

# ESP32-H2

## ESP-IDF Programming Guide



Release v5.3.1  
乐鑫信息科技  
2024年09月03日

# Table of contents

<b>Table of contents</b>	<b>i</b>
<b>1 快速入门</b>	<b>3</b>
1.1 概述	3
1.2 准备工作	3
1.2.1 硬件:	3
1.2.2 软件:	4
1.3 安装	4
1.3.1 IDE	4
1.3.2 手动安装	4
1.4 编译第一个工程	30
1.5 卸载 ESP-IDF	30
<b>2 API 参考</b>	<b>31</b>
2.1 API 约定	31
2.1.1 错误处理	31
2.1.2 配置结构体	31
2.1.3 私有 API	33
2.1.4 示例项目组件	33
2.1.5 API 稳定性	33
2.2 应用层协议	34
2.2.1 ASIO 端口	34
2.2.2 ESP-Modbus	34
2.2.3 ESP-MQTT	35
2.2.4 ESP-TLS	53
2.2.5 ESP HTTP 客户端	72
2.2.6 ESP 本地控制	90
2.2.7 ESP 串行从机链路	99
2.2.8 ESP x509 证书包	113
2.2.9 HTTP 服务器	115
2.2.10 HTTPS 服务器	144
2.2.11 ICMP 回显	149
2.2.12 mDNS 服务	154
2.2.13 Mbed TLS	154
2.2.14 IP 网络层协议	156
2.3 蓝牙 API	156
2.3.1 Bluetooth® Common	156
2.3.2 Bluetooth® Low Energy (Bluetooth LE)	168
2.3.3 Controller && VHCI	298
2.3.4 ESP-BLE-MESH	308
2.3.5 NimBLE-based Host APIs	689
2.4 错误代码参考	691
2.5 连网 API	698
2.5.1 以太网	698
2.5.2 Thread	735
2.5.3 ESP-NETIF	745
2.5.4 IP 网络层协议	779

2.5.5	应用层协议	782
2.6	外设 API	782
2.6.1	模数转换器 (ADC) 单次转换模式驱动	782
2.6.2	模数转换器 (ADC) 连续转换模式驱动	792
2.6.3	模数转换器 (ADC) 校准驱动程序	801
2.6.4	Analog Comparator	804
2.6.5	时钟树	814
2.6.6	椭圆曲线数字签名算法 (ECDSA)	828
2.6.7	事件任务矩阵 (ETM)	831
2.6.8	GPIO & RTC GPIO	840
2.6.9	通用定时器	858
2.6.10	专用 GPIO	874
2.6.11	哈希消息认证码 (HMAC)	878
2.6.12	数字签名 (DS)	882
2.6.13	Inter-Integrated Circuit (I2C)	888
2.6.14	I2S	912
2.6.15	LCD	954
2.6.16	LED PWM 控制器	970
2.6.17	电机控制脉宽调制器 (MCPWM)	993
2.6.18	并行 IO	1047
2.6.19	脉冲计数器 (PCNT)	1062
2.6.20	红外遥控 (RMT)	1076
2.6.21	SD SPI 主机驱动程序	1104
2.6.22	Sigma-Delta 调制器 (SDM)	1110
2.6.23	SPI flash API	1115
2.6.24	SPI 主机驱动程序	1147
2.6.25	SPI 从机驱动程序	1169
2.6.26	SPI 从机半双工模式	1176
2.6.27	温度传感器	1184
2.6.28	Two-Wire Automotive Interface (TWAI)	1193
2.6.29	通用异步接收器/发送器 (UART)	1215
2.7	项目配置	1240
2.7.1	简介	1240
2.7.2	项目配置菜单	1240
2.7.3	使用 sdkconfig.defaults	1240
2.7.4	Kconfig 格式规定	1240
2.7.5	Kconfig 选项的向后兼容性	1241
2.7.6	配置选项参考	1241
2.8	配网 API	1591
2.8.1	协议通信	1591
2.9	存储 API	1607
2.9.1	FAT 文件系统	1608
2.9.2	量产程序	1619
2.9.3	非易失性存储库	1622
2.9.4	NVS 加密	1646
2.9.5	NVS 分区生成程序	1652
2.9.6	NVS 分区解析程序	1657
2.9.7	SD/SDIO/MMC 驱动程序	1658
2.9.8	分区 API	1665
2.9.9	SPIFFS 文件系统	1674
2.9.10	虚拟文件系统组件	1678
2.9.11	磨损均衡 API	1695
2.10	系统 API	1698
2.10.1	应用程序镜像格式	1698
2.10.2	引导加载程序镜像的格式	1704
2.10.3	应用级追踪	1706
2.10.4	使用外部堆栈调用函数	1712
2.10.5	芯片版本	1714

2.10.6	控制台终端	1717
2.10.7	eFuse Manager	1727
2.10.8	错误代码和辅助函数	1758
2.10.9	ESP HTTPS OTA 升级	1762
2.10.10	事件循环库	1769
2.10.11	FreeRTOS 概述	1782
2.10.12	FreeRTOS (IDF)	1784
2.10.13	FreeRTOS (附加功能)	1898
2.10.14	堆内存分配	1925
2.10.15	基于 MMU 的存储管理	1940
2.10.16	堆内存调试	1946
2.10.17	ESP 定时器	1958
2.10.18	内部 API 和不稳定的 API	1963
2.10.19	中断分配	1965
2.10.20	日志库	1972
2.10.21	杂项系统 API	1980
2.10.22	空中升级 (OTA)	1997
2.10.23	电源管理	2009
2.10.24	POSIX Thread	2016
2.10.25	随机数发生器	2021
2.10.26	睡眠模式	2024
2.10.27	SoC 功能	2038
2.10.28	系统时间	2055
2.10.29	异步内存复制	2062
2.10.30	看门狗	2066
<b>3</b>	<b>H/W 硬件参考</b>	<b>2073</b>
<b>4</b>	<b>API 指南</b>	<b>2075</b>
4.1	应用层跟踪库	2075
4.1.1	概述	2075
4.1.2	运行模式	2075
4.1.3	配置选项与依赖项	2076
4.1.4	如何使用此库	2077
4.2	应用程序的启动流程	2084
4.2.1	一级引导程序	2085
4.2.2	二级引导程序	2085
4.2.3	应用程序启动阶段	2085
4.3	Bluetooth® Overview	2087
4.3.1	ESP Bluetooth Controller	2087
4.3.2	Hosts	2087
4.3.3	Profiles	2088
4.3.4	Applications	2088
4.4	引导加载程序 (Bootloader)	2089
4.4.1	引导加载程序兼容性	2089
4.4.2	日志级别	2089
4.4.3	恢复出厂设置	2089
4.4.4	从测试固件启动	2090
4.4.5	回滚	2090
4.4.6	看门狗	2091
4.4.7	引导加载程序大小	2091
4.4.8	从深度睡眠中快速启动	2091
4.4.9	自定义引导加载程序	2091
4.5	构建系统	2092
4.5.1	概述	2092
4.5.2	使用构建系统	2092
4.5.3	示例项目	2094
4.5.4	项目 CMakeLists 文件	2095



4.5.5	组件 CMakeLists 文件	2096
4.5.6	组件配置	2098
4.5.7	预处理器定义	2098
4.5.8	组件依赖	2098
4.5.9	覆盖项目的部分设置	2102
4.5.10	仅配置组件	2104
4.5.11	CMake 调试	2104
4.5.12	组件 CMakeLists 示例	2104
4.5.13	自定义 sdkconfig 的默认值	2108
4.5.14	flash 参数	2109
4.5.15	构建 Bootloader	2109
4.5.16	编写纯 CMake 组件	2109
4.5.17	组件中使用第三方 CMake 项目	2110
4.5.18	组件中使用预建库	2111
4.5.19	在自定义 CMake 项目中使用 ESP-IDF	2111
4.5.20	ESP-IDF CMake 构建系统 API	2111
4.5.21	文件通配 & 增量构建	2115
4.5.22	构建系统的元数据	2116
4.5.23	构建系统内部	2116
4.5.24	从 ESP-IDF GNU Make 构建系统迁移到 CMake 构建系统	2118
4.6	RF 共存	2119
4.6.1	概览	2119
4.6.2	ESP32-H2 支持的共存场景	2119
4.6.3	共存机制与策略	2119
4.6.4	如何使用共存功能	2120
4.7	C Support	2121
4.7.1	C Version	2121
4.7.2	Unsupported C Features	2122
4.8	C++ 支持	2122
4.8.1	esp-idf-cxx 组件	2122
4.8.2	C++ 语言标准	2122
4.8.3	多线程	2122
4.8.4	异常处理	2123
4.8.5	运行时类型信息 (RTTI)	2123
4.8.6	在 C++ 中进行开发	2123
4.8.7	限制	2125
4.8.8	注意事项	2125
4.9	核心转储	2125
4.9.1	概述	2125
4.9.2	配置	2125
4.9.3	将核心转储保存到 flash	2126
4.9.4	将核心转储保存到 UART	2127
4.9.5	核心转储命令	2128
4.9.6	回溯中的 ROM 函数	2128
4.9.7	按需转储变量	2129
4.9.8	运行 idf.py coredump-info 和 idf.py coredump-debug	2129
4.10	Current Consumption Measurement of Modules	2130
4.10.1	Notes to Measurement	2130
4.10.2	Hardware Connection	2132
4.10.3	Measurement Steps	2134
4.11	Deep Sleep Wake Stubs	2134
4.11.1	Introduction	2134
4.11.2	Implement wake stub	2137
4.11.3	Example	2138
4.12	错误处理	2138
4.12.1	概述	2138
4.12.2	错误码	2139
4.12.3	错误码到错误消息	2139

4.12.4	ESP_ERROR_CHECK 宏	2139
4.12.5	ESP_ERROR_CHECK_WITHOUT_ABORT 宏	2140
4.12.6	ESP_RETURN_ON_ERROR 宏	2140
4.12.7	ESP_GOTO_ON_ERROR 宏	2140
4.12.8	ESP_RETURN_ON_FALSE 宏	2140
4.12.9	ESP_GOTO_ON_FALSE 宏	2140
4.12.10	CHECK 宏使用示例	2140
4.12.11	错误处理模式	2141
4.12.12	C++ 异常	2142
4.13	ESP-BLE-MESH	2142
4.13.1	ESP-BLE-MESH 快速入门	2142
4.13.2	ESP-BLE-MESH 示例	2147
4.13.3	ESP-BLE-MESH 演示视频	2149
4.13.4	ESP-BLE-MESH 常见问题手册	2149
4.13.5	相关文档	2150
4.14	严重错误	2177
4.14.1	概述	2177
4.14.2	紧急处理程序	2178
4.14.3	寄存器转储与回溯	2178
4.14.4	GDB Stub	2181
4.14.5	RTC 看门狗超时	2182
4.14.6	Guru Meditation 错误	2182
4.14.7	其他严重错误	2183
4.15	硬件抽象	2186
4.15.1	架构	2186
4.15.2	LL 层 (低级层)	2187
4.15.3	HAL (硬件抽象层)	2188
4.16	JTAG 调试	2189
4.16.1	引言	2189
4.16.2	工作原理	2189
4.16.3	选择 JTAG 适配器	2190
4.16.4	安装 OpenOCD	2191
4.16.5	配置 ESP32-H2 目标板	2191
4.16.6	启动调试器	2194
4.16.7	调试范例	2194
4.16.8	从源码构建 OpenOCD	2194
4.16.9	注意事项和补充内容	2199
4.16.10	相关文档	2203
4.17	链接器脚本生成机制	2228
4.17.1	概述	2228
4.17.2	快速上手	2228
4.17.3	链接器脚本生成机制内核	2231
4.18	lwIP	2237
4.18.1	支持的 API	2237
4.18.2	BSD 套接字 API	2237
4.18.3	Netconn API	2241
4.18.4	lwIP FreeRTOS 任务	2241
4.18.5	IPv6 支持	2242
4.18.6	ESP-lwIP 自定义修改	2242
4.18.7	性能优化	2244
4.19	存储器类型	2245
4.19.1	DRAM (数据 RAM)	2245
4.19.2	IRAM (指令 RAM)	2246
4.19.3	IROM (代码从 flash 中运行)	2247
4.19.4	DROM (数据存储在 flash 中)	2247
4.19.5	RTC FAST memory (RTC 快速存储器)	2247
4.19.6	具备 DMA 功能	2247
4.19.7	在堆栈中放置 DMA 缓冲区	2248



4.20	OpenThread	2248
4.20.1	OpenThread 协议栈运行模式	2248
4.20.2	编写 OpenThread 应用程序	2249
4.20.3	OpenThread 边界路由器	2250
4.21	分区表	2250
4.21.1	概述	2250
4.21.2	内置分区表	2251
4.21.3	创建自定义分区表	2251
4.21.4	生成二进制分区表	2254
4.21.5	分区大小检查	2254
4.21.6	烧写分区表	2254
4.21.7	分区工具 (parttool.py)	2255
4.22	性能	2256
4.22.1	如何优化性能	2256
4.22.2	指南	2256
4.23	Reproducible Builds	2273
4.23.1	Introduction	2273
4.23.2	Reasons for Non-Reproducible Builds	2273
4.23.3	Enabling Reproducible Builds in ESP-IDF	2273
4.23.4	How Reproducible Builds Are Achieved	2273
4.23.5	Reproducible Builds and Debugging	2274
4.23.6	Factors Which Still Affect Reproducible Builds	2274
4.24	RF 校准	2274
4.24.1	部分校准	2274
4.24.2	全面校准	2274
4.24.3	不校准	2275
4.24.4	PHY 初始化数据	2275
4.24.5	API 参考	2275
4.25	线程局部存储	2282
4.25.1	概述	2283
4.25.2	FreeRTOS 原生 API	2283
4.25.3	Pthread API	2283
4.25.4	C11 标准	2283
4.26	工具	2283
4.26.1	IDF 前端工具 - idf.py	2283
4.26.2	IDF 监视器	2287
4.26.3	IDF Docker 镜像	2295
4.26.4	IDF Windows 安装程序	2298
4.26.5	IDF 组件管理器	2299
4.26.6	IDF clang-tidy	2300
4.26.7	可下载 ESP-IDF 工具	2301
4.27	ESP32-H2 中的单元测试	2314
4.27.1	添加常规测试用例	2314
4.27.2	添加多设备测试用例	2315
4.27.3	添加多阶段测试用例	2316
4.27.4	应用于不同芯片的单元测试	2316
4.27.5	编译单元测试程序	2317
4.27.6	运行单元测试	2317
4.27.7	带缓存补偿定时器的定时代码	2318
4.27.8	Mocks	2319
4.28	在主机上运行 ESP-IDF 应用程序	2321
4.28.1	介绍	2321
4.28.2	使用模拟器的前提	2322
4.28.3	构建和运行	2322
4.28.4	组件 Linux/Mock 支持情况概述	2322
4.29	USB 串行/JTAG 控制器控制台	2323
4.29.1	硬件要求	2324
4.29.2	软件配置	2324

4.29.3	上传应用程序	2324
4.29.4	限制	2324
4.30	低功耗模式使用指南	2325
4.30.1	系统低功耗模式介绍	2325
4.31	PHY	2331
4.31.1	多根天线	2331
<b>5</b>	<b>迁移指南</b>	<b>2335</b>
5.1	迁移到 ESP-IDF 5.x	2335
5.1.1	从 4.4 迁移到 5.0	2335
5.1.2	从 5.0 迁移到 5.1	2364
5.1.3	从 5.1 迁移到 5.2	2366
5.1.4	从 5.2 迁移到 5.3	2368
<b>6</b>	<b>安全指南</b>	<b>2373</b>
6.1	概述	2373
6.1.1	安全	2373
6.2	功能	2376
6.2.1	flash 加密	2376
6.2.2	Secure Boot V2	2386
6.3	流程	2395
6.3.1	Host-Based Security Workflows	2395
<b>7</b>	<b>库与框架</b>	<b>2405</b>
7.1	云框架	2405
7.1.1	ESP RainMaker	2405
7.1.2	AWS IoT	2405
7.1.3	Azure IoT	2405
7.1.4	Google IoT Core	2405
7.1.5	阿里云 IoT	2405
7.1.6	Joylink IoT	2405
7.1.7	腾讯 IoT	2406
7.1.8	腾讯云 IoT	2406
7.1.9	百度 IoT	2406
7.2	其他库和开发框架	2406
7.2.1	ESP-ADF	2406
7.2.2	ESP-CSI	2406
7.2.3	ESP-DSP	2406
7.2.4	ESP-WIFI-MESH	2407
7.2.5	ESP-WHO	2407
7.2.6	ESP RainMaker	2407
7.2.7	ESP-IoT-Solution	2407
7.2.8	ESP-Protocols	2407
7.2.9	ESP-BSP	2407
7.2.10	ESP-IDF-CXX	2408
<b>8</b>	<b>贡献指南</b>	<b>2409</b>
8.1	如何贡献	2409
8.2	准备工作	2409
8.3	Pull Request 提交流程	2409
8.4	法律规范	2409
8.5	相关文档	2410
8.5.1	Espressif IoT Development Framework Style Guide	2410
8.5.2	为 ESP-IDF 安装 pre-commit 钩子	2418
8.5.3	编写文档	2419
8.5.4	创建示例项目	2423
8.5.5	API 文档模板	2424
8.5.6	贡献者协议	2426
8.5.7	版权标头指南	2428

8.5.8	ESP-IDF pytest 指南	2429
<b>9</b>	<b>ESP-IDF 版本简介</b>	<b>2441</b>
9.1	发布版本	2441
9.2	我该选择哪个版本?	2441
9.3	版本管理	2441
9.4	支持期限	2442
9.5	查看当前版本	2443
9.6	Git 工作流	2444
9.7	更新 ESP-IDF	2444
9.7.1	更新至一个稳定发布版本	2444
9.7.2	更新至一个预发布版本	2445
9.7.3	更新至 master 分支	2445
9.7.4	更新至一个发布分支	2445
<b>10</b>	<b>资源</b>	<b>2447</b>
10.1	PlatformIO	2447
10.1.1	什么是 PlatformIO?	2447
10.1.2	安装	2447
10.1.3	配置	2448
10.1.4	教程	2448
10.1.5	项目示例	2448
10.1.6	更多内容	2448
10.2	CLion	2448
10.2.1	CLion 是什么?	2448
10.2.2	安装	2448
10.2.3	配置	2448
10.2.4	资源	2448
10.3	VisualGDB	2448
10.3.1	VisualGDB 是什么?	2449
10.3.2	安装	2449
10.3.3	配置	2449
10.3.4	资源	2449
10.4	有用的链接	2449
<b>11</b>	<b>Copyrights and Licenses</b>	<b>2451</b>
11.1	Software Copyrights	2451
11.1.1	Firmware Components	2451
11.1.2	Documentation	2452
11.2	ROM Source Code Copyrights	2452
11.3	Xtensa libhal MIT License	2453
11.4	TinyBasic Plus MIT License	2453
11.5	TJpgDec License	2453
<b>12</b>	<b>关于本指南</b>	<b>2455</b>
<b>13</b>	<b>切换语言</b>	<b>2457</b>
	<b>索引</b>	<b>2459</b>
	<b>索引</b>	<b>2459</b>

这里是乐鑫 IoT 开发框架 ([esp-idf](#)) 的文档中心。ESP-IDF 是 [ESP32](#)、[ESP32-S](#)、[ESP32-C](#)、[ESP32-H](#) 和 [ESP32-P](#) 系列芯片的官方开发框架。

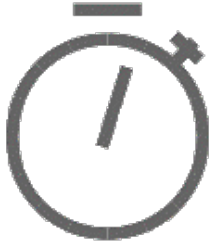
本文档仅包含针对 ESP32-H2 芯片的 ESP-IDF 使用。

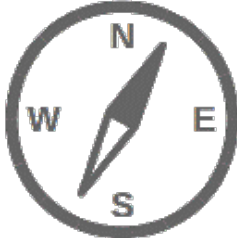
		
<a href="#">快速入门</a>	<a href="#">API 参考</a>	<a href="#">API 指南</a>



# Chapter 1

## 快速入门

本文档旨在指导用户搭建 ESP32-H2 硬件开发的软件环境，通过一个简单的示例展示如何使用 ESP-IDF (Espressif IoT Development Framework) 配置菜单，并编译、下载固件至 ESP32-H2 开发板等步骤。

---

**备注：**这是 ESP-IDF 稳定版本 v5.3.1 的文档，还有其他版本的文档[ESP-IDF 版本简介](#) 供参考。

---

### 1.1 概述

ESP32-H2 SoC 芯片支持以下功能：

- 低功耗蓝牙
- 802.15.4，支持 Thread 和 Zigbee 协议
- 高性能 32 位 RISC-V 单核处理器
- 多种外设
- 内置安全硬件

ESP32-H2 采用 40 nm 工艺制成，具有最佳的功耗性能、射频性能、稳定性、通用性和可靠性，适用于各种应用场景和不同功耗需求。

乐鑫为用户提供完整的软、硬件资源，进行 ESP32-H2 硬件设备的开发。其中，乐鑫的软件开发环境 ESP-IDF 旨在协助用户快速开发物联网 (IoT) 应用，可满足用户对 Wi-Fi、蓝牙、低功耗等方面的要求。

### 1.2 准备工作

#### 1.2.1 硬件：

- 一款 **ESP32-H2** 开发板
- **USB 数据线** (A 转 Micro-B)
- 电脑 (Windows、Linux 或 macOS)

---

**备注：**目前一些开发板使用的是 USB Type C 接口。请确保使用合适的数据线来连接开发板！

---

以下是 ESP32-H2 官方开发板，[点击链接](#)可了解更多硬件信息。



## 1.2.2 软件：

如需在 **ESP32-H2** 上使用 ESP-IDF，请安装以下软件：

- 设置 **工具链**，用于编译 ESP32-H2 代码；
- **编译构建工具**——CMake 和 Ninja 编译构建工具，用于编译 ESP32-H2 **应用程序**；
- 获取 **ESP-IDF** 软件开发框架。该框架已经基本包含 ESP32-H2 使用的 API（软件库和源代码）和运行 **工具链** 的脚本；

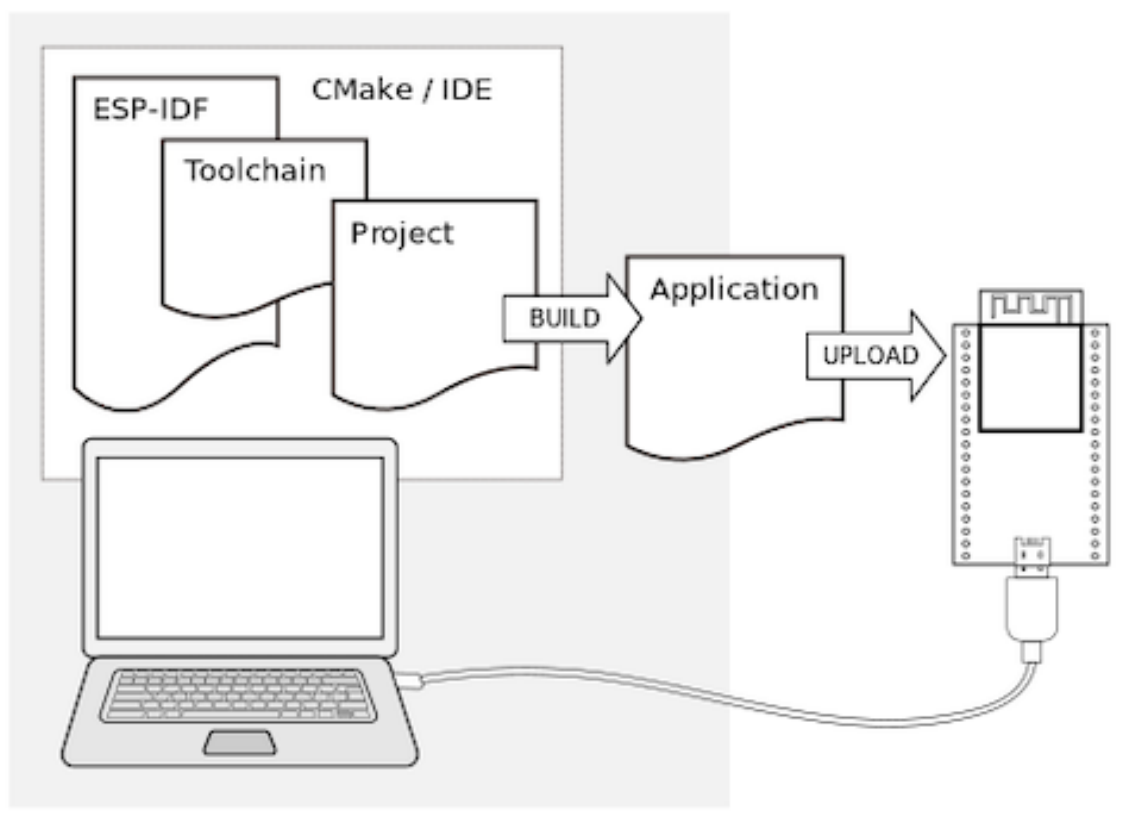

## 1.3 安装

为安装所需软件，乐鑫提供了以下方法，可根据需要选择其中之一。

### 1.3.1 IDE

**备注：** 建议通过自己喜欢的集成开发环境 (IDE) 安装 ESP-IDF。

- [Eclipse Plugin](#)
- [VSCode Extension](#)

### 1.3.2 手动安装

请根据操作系统，选择对应的手动安装流程。

## Windows 平台工具链的标准设置

**概述** ESP-IDF 需要安装一些必备工具，才能围绕 ESP32-H2 构建固件，包括 Python、Git、交叉编译器、CMake 和 Ninja 编译工具等。

本入门指南介绍了如何通过 **命令提示符** 进行有关操作。不过，安装 ESP-IDF 后，还可以使用 [Eclipse Plugin](#) 或其他支持 CMake 的图形化工具 IDE。

---

**备注：** 限定条件：

- 请注意 ESP-IDF 和 ESP-IDF 工具的安装路径不能超过 90 个字符，安装路径过长可能会导致构建失败。
- Python 或 ESP-IDF 的安装路径中一定不能包含空格或括号。
- 除非操作系统配置为支持 Unicode UTF-8，否则 Python 或 ESP-IDF 的安装路径中也不能包括特殊字符（非 ASCII 码字符）

系统管理员可以通过如下方式将操作系统配置为支持 Unicode UTF-8: Control Panel > 更改 date、time、或 number 格式 > Administrative tab > 更改 system locale > 勾选选项 Beta: Use Unicode UTF-8 for worldwide language support > Ok > 重启电脑。

---

**ESP-IDF 工具安装器** 安装 ESP-IDF 必备工具最简易的方式是下载一个 ESP-IDF 工具安装器。



**在线安装与离线安装的区别** 在线安装程序非常小，可以安装 ESP-IDF 的所有版本。在安装过程中，安装程序只下载必要的依赖文件，包括 [Git For Windows](#) 安装器。在线安装程序会将下载的文件存储在缓存目录 %userprofile%/espressif 中。

离线安装程序不需要任何网络连接。安装程序中包含了所有需要的依赖文件，包括 [Git For Windows](#) 安装器。

**安装内容** 安装程序会安装以下组件：

- 内置的 Python
- 交叉编译器
- OpenOCD
- CMake 和 Ninja 编译工具
- ESP-IDF

安装程序允许将程序下载到现有的 ESP-IDF 目录。推荐将 ESP-IDF 下载到 %userprofile%\Desktop\esp-idf 目录下，其中 %userprofile% 代表家目录。

**启动 ESP-IDF 环境** 安装结束时，如果勾选了 Run ESP-IDF PowerShell Environment 或 Run ESP-IDF Command Prompt (cmd.exe)，安装程序会在选定的提示符窗口启动 ESP-IDF。

Run ESP-IDF PowerShell Environment:



图 1: 完成 ESP-IDF 工具安装向导时运行 Run ESP-IDF PowerShell Environment

Run ESP-IDF Command Prompt (cmd.exe):

**使用命令提示符** 在后续步骤中，将介绍如何使用 Windows 的命令提示符进行操作。

ESP-IDF 工具安装器可在“开始”菜单中，创建一个打开 ESP-IDF 命令提示符窗口的快捷方式。本快捷方式可以打开 Windows 命令提示符 (即 cmd.exe)，并运行 export.bat 脚本以设置各环境变量 (比如 PATH, IDF\_PATH 等)。此外，还可以通过 Windows 命令提示符使用各种已经安装的工具。

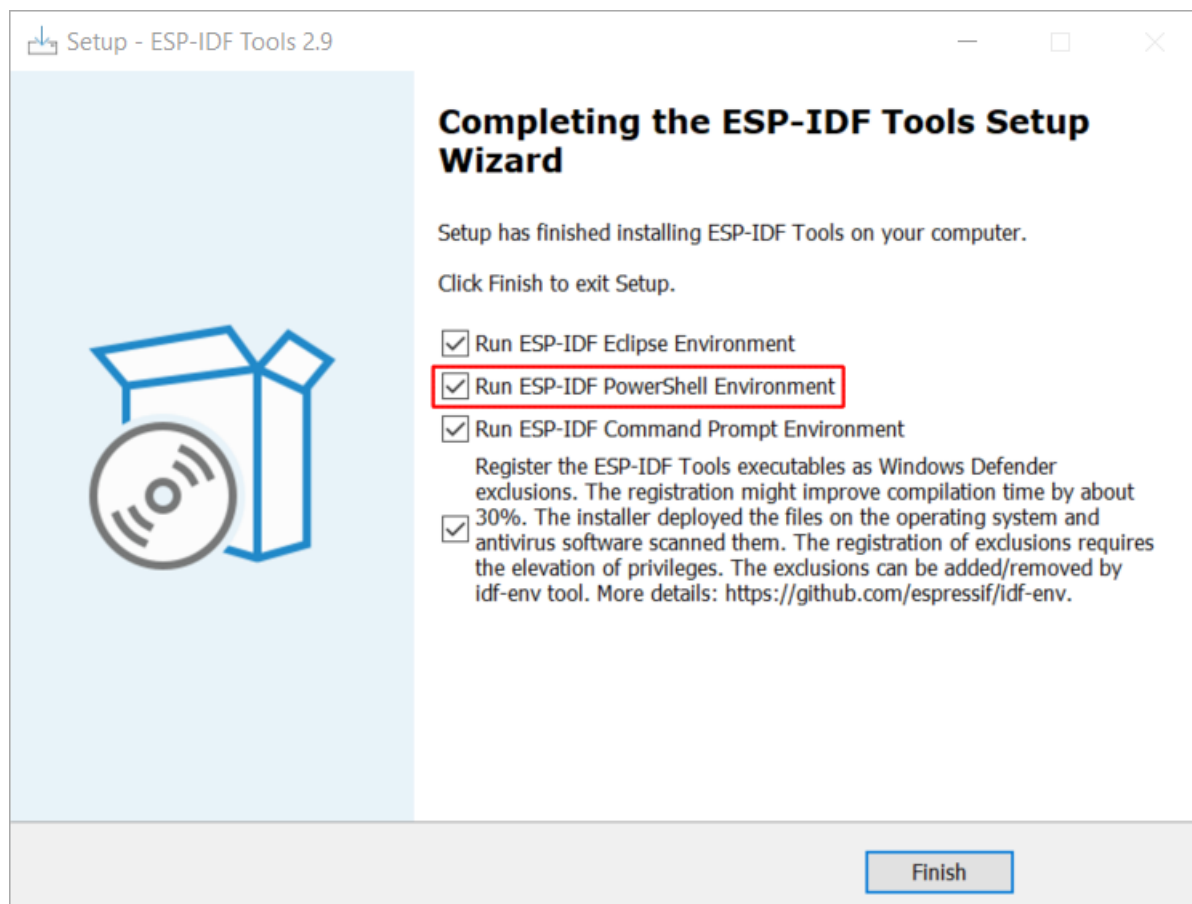
注意，本快捷方式仅适用 ESP-IDF 工具安装器中指定的 ESP-IDF 路径。如果电脑上存在多个 ESP-IDF 路径 (比如需要不同版本的 ESP-IDF)，有以下两种解决方法：

1. 为 ESP-IDF 工具安装器创建的快捷方式创建一个副本，并将新快捷方式的 ESP-IDF 工作路径指定为希望使用的 ESP-IDF 路径。
2. 或者，可以运行 cmd.exe，并切换至希望使用的 ESP-IDF 目录，然后运行 export.bat。注意，这种方法要求 PATH 中存在 Python 和 Git。如果在使用时遇到有关“找不到 Python 或 Git”的错误信息，请使用第一种方法。

**开始使用 ESP-IDF** 现在你已经具备了使用 ESP-IDF 的所有条件，接下来将介绍如何开始第一个工程。

本指南将介绍如何初步上手 ESP-IDF，包括如何使用 ESP32-H2 创建第一个工程，并构建、烧录和监控设备输出。

```
ESP-IDF PowerShell

Using Python in C:/Users/developer/.espressif/python_env/idf4.1_py3.8_env/scripts
Python 3.8.7
Using Git in C:/Program Files/Git/cmd/
git version 2.29.2.windows.1
Setting IDF_PATH: C:/Users/developer/Desktop/esp-idf
Adding ESP-IDF tools to PATH...
C:/Users/developer/.espressif/tools/xtensa-esp32-elf/esp-2020r3-8.4.0/xtensa-esp32-elf/bin
C:/Users/developer/.espressif/tools/xtensa-esp32s2-elf/esp-2020r3-8.4.0/xtensa-esp32s2-elf/bin
C:/Users/developer/.espressif/tools/esp32ulp-elf/2.28.51-esp-20191205/esp32ulp-elf-binutils/bin
C:/Users/developer/.espressif/tools/esp32s2ulp-elf/2.28.51-esp-20191205/esp32s2ulp-elf-binutils/bin
C:/Users/developer/.espressif/tools/cmake/3.13.4/bin
C:/Users/developer/.espressif/tools/openocd-esp32/v0.10.0-esp32-20200709/openocd-esp32/bin
C:/Users/developer/.espressif/tools/ninja/1.9.0/
C:/Users/developer/.espressif/tools/idf-exe/1.0.1/
C:/Users/developer/.espressif/tools/ccache/3.7/
C:/Users/developer/Desktop/esp-idf/tools
Checking if Python packages are up to date...
Python requirements from C:/Users/developer/Desktop/esp-idf/requirements.txt are satisfied.

Done! You can now compile ESP-IDF projects.
Go to the project directory and run:
  idf.py build

PS C:/Users/developer/Desktop/esp-idf>
```

图 2: ESP-IDF PowerShell



图 3: 完成 ESP-IDF 工具安装向导时运行 Run ESP-IDF Command Prompt (cmd.exe)

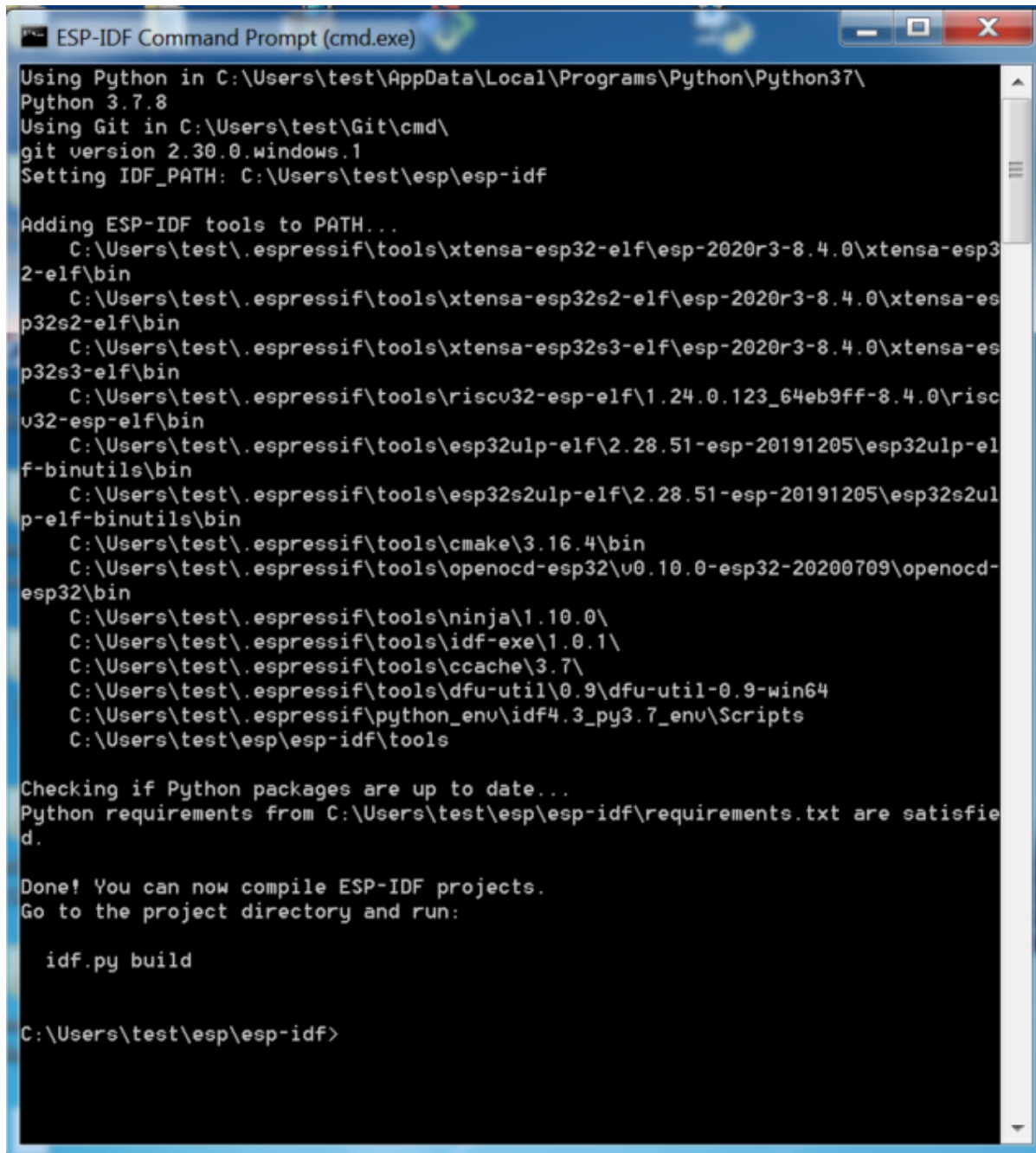

```
ESP-IDF Command Prompt (cmd.exe)
Using Python in C:\Users\test\AppData\Local\Programs\Python\Python37\
Python 3.7.8
Using Git in C:\Users\test\Git\cmd\
git version 2.30.0.windows.1
Setting IDF_PATH: C:\Users\test\esp\esp-idf

Adding ESP-IDF tools to PATH...
  C:\Users\test\.espressif\tools\xtensa-esp32-elf\esp-2020r3-8.4.0\xtensa-esp32-elf\bin
  C:\Users\test\.espressif\tools\xtensa-esp32s2-elf\esp-2020r3-8.4.0\xtensa-esp32s2-elf\bin
  C:\Users\test\.espressif\tools\xtensa-esp32s3-elf\esp-2020r3-8.4.0\xtensa-esp32s3-elf\bin
  C:\Users\test\.espressif\tools\riscv32-esp-elf\1.24.0.123_64eb9ff-8.4.0\riscv32-esp-elf\bin
  C:\Users\test\.espressif\tools\esp32ulp-elf\2.28.51-esp-20191205\esp32ulp-elf-binutils\bin
  C:\Users\test\.espressif\tools\esp32s2ulp-elf\2.28.51-esp-20191205\esp32s2ulp-elf-binutils\bin
  C:\Users\test\.espressif\tools\cmake\3.16.4\bin
  C:\Users\test\.espressif\tools\openocd-esp32\v0.10.0-esp32-20200709\openocd-esp32\bin
  C:\Users\test\.espressif\tools\ninja\1.10.0\
  C:\Users\test\.espressif\tools\idf-exe\1.0.1\
  C:\Users\test\.espressif\tools\ccache\3.7\
  C:\Users\test\.espressif\tools\dfu-util\0.9\dfu-util-0.9-win64
  C:\Users\test\.espressif\python_env\idf4.3_py3.7_env\Scripts
  C:\Users\test\esp\esp-idf\tools

Checking if Python packages are up to date...
Python requirements from C:\Users\test\esp\esp-idf\requirements.txt are satisfied.

Done! You can now compile ESP-IDF projects.
Go to the project directory and run:

  idf.py build

C:\Users\test\esp\esp-idf>
```

图 4: ESP-IDF 命令提示符窗口

**备注:** 如果还未安装 ESP-IDF，请参照[安装](#)中的步骤，获取使用本指南所需的所有软件。

---

**开始创建工程** 现在，可以准备开发 ESP32-H2 应用程序了。可以从 ESP-IDF 中 `examples` 目录下的 `get-started/hello_world` 工程开始。

**重要:** ESP-IDF 编译系统不支持 ESP-IDF 路径或其工程路径中带有空格。

---

将 `get-started/hello_world` 工程复制至本地的 `~/esp` 目录下：

```
cd %userprofile%\esp
xcopy /e /i %IDF_PATH%\examples\get-started\hello_world hello_world
```

**备注:** ESP-IDF 的 `examples` 目录下有一系列示例工程，可以按照上述方法复制并运行其中的任何示例，也可以直接编译示例，无需进行复制。

---

**连接设备** 现在，请将 ESP32-H2 开发板连接到 PC，并查看开发板使用的串口。

在 Windows 操作系统中，串口名称通常以 COM 开头。

有关如何查看串口名称的详细信息，请见与 [ESP32-H2 创建串口连接](#)。

---

**备注:** 请记住串口名，以便后续使用。

---

**配置工程** 请进入 `hello_world` 目录，设置 ESP32-H2 为目标芯片，然后运行工程配置工具 `menuconfig`。

### Windows

```
cd %userprofile%\esp\hello_world
idf.py set-target esp32h2
idf.py menuconfig
```

打开一个新工程后，应首先使用 `idf.py set-target esp32h2` 设置“目标”芯片。注意，此操作将清除并初始化项目之前的编译和配置（如有）。也可以直接将“目标”配置为环境变量（此时可跳过该步骤）。更多信息，请见[选择目标芯片：set-target](#)。

正确操作上述步骤后，系统将显示以下菜单：

可以通过此菜单设置项目的具体变量，包括 Wi-Fi 网络名称、密码和处理器速度等。`hello_world` 示例项目会以默认配置运行，因此在这一项目中，可以跳过使用 `menuconfig` 进行项目配置这一步骤。

---

**备注:** 终端窗口中显示出的菜单颜色可能会与上图不同。可以通过选项 `--style` 来改变外观。请运行 `idf.py menuconfig --help` 命令，获取更多信息。

---

**编译工程** 请使用以下命令，编译烧录工程：

```
idf.py build
```

运行以上命令可以编译应用程序和所有 ESP-IDF 组件，接着生成引导加载程序、分区表和应用程序二进制文件。

---

```
(Top)
      Espressif IoT Development Framework Configuration
SDK tool configuration --->
Build type --->
Application manager --->
Bootloader config --->
Security features --->
Serial flasher config --->
Partition Table --->
Compiler options --->
Component config --->
Compatibility options --->

[Space/Enter] Toggle/enter  [ESC] Leave menu          [S] Save
[O] Load                    [?] Symbol info          [/] Jump to symbol
[F] Toggle show-help mode   [C] Toggle show-name mode [A] Toggle show-all mode
[Q] Quit (prompts for save) [D] Save minimal config (advanced)
```

图 5: 工程配置—主窗口

```
$ idf.py build
Running cmake in directory /path/to/hello_world/build
Executing "cmake -G Ninja --warn-uninitialized /path/to/hello_world"...
Warn about uninitialized values.
-- Found Git: /usr/bin/git (found version "2.17.0")
-- Building empty aws_iot component due to configuration
-- Component names: ...
-- Component paths: ...

... (more lines of build system output)

[527/527] Generating hello_world.bin
esptool.py v2.3.1

Project build complete. To flash, run this command:
../../components/esptool_py/esptool/esptool.py -p (PORT) -b 921600 write_flash -
↪-flash_mode dio --flash_size detect --flash_freq 40m 0x10000 build/hello_world.
↪bin build 0x1000 build/bootloader/bootloader.bin 0x8000 build/partition_table/
↪partition-table.bin
or run 'idf.py -p PORT flash'
```

如果一切正常，编译完成后将生成 `.bin` 文件。

**烧录到设备** 请运行以下命令，将刚刚生成的二进制文件烧录至 ESP32-H2 开发板：

```
idf.py -p PORT flash
```

请将 `PORT` 替换为 ESP32-H2 开发板的串口名称。如果 `PORT` 未经定义，`idf.py` 将尝试使用可用的串口自动连接。

更多有关 `idf.py` 参数的详情，请见 [idf.py](#)。

**备注：**勾选 `flash` 选项将自动编译并烧录工程，因此无需再运行 `idf.py build`。

若在烧录过程中遇到问题，请参考下文中的“其他提示”。也可以前往 [烧录故障排除](#) 或与 [ESP32-H2 创建串口连接](#) 获取更多详细信息。



**常规操作** 在烧录过程中，会看到类似如下的输出日志：

```
...
esptool esp32h2 -p /dev/ttyUSB0 -b 460800 --before=default_reset --after=hard_
↳reset write_flash --flash_mode dio --flash_freq 48m --flash_size 2MB 0x0
↳bootloader/bootloader.bin 0x10000 hello_world.bin 0x8000 partition_table/
↳partition-table.bin
esptool.py v4.6
Serial port /dev/ttyUSB0
Connecting....
Chip is ESP32-H2 (revision v0.1)
Features: BLE
Crystal is 32MHz
MAC: 60:55:f9:f7:3e:93:ff:fe
Uploading stub...
Running stub...
Stub running...
Changing baud rate to 460800
Changed.
Configuring flash size...
Flash will be erased from 0x00000000 to 0x00005fff...
Flash will be erased from 0x00010000 to 0x00034fff...
Flash will be erased from 0x00008000 to 0x00008fff...
Compressed 20880 bytes to 12788...
Writing at 0x00000000... (100 %)
Wrote 20880 bytes (12788 compressed) at 0x00000000 in 0.6 seconds (effective 297.5
↳kbit/s)...
Hash of data verified.
Compressed 149424 bytes to 79574...
Writing at 0x00010000... (20 %)
Writing at 0x00019959... (40 %)
Writing at 0x00020bb5... (60 %)
Writing at 0x00026d8f... (80 %)
Writing at 0x0002e60a... (100 %)
Wrote 149424 bytes (79574 compressed) at 0x00010000 in 2.1 seconds (effective 571.
↳7 kbit/s)...
Hash of data verified.
Compressed 3072 bytes to 103...
Writing at 0x00008000... (100 %)
Wrote 3072 bytes (103 compressed) at 0x00008000 in 0.0 seconds (effective 539.7
↳kbit/s)...
Hash of data verified.

Leaving...
Hard resetting via RTS pin...
```

如果一切顺利，烧录完成后，开发板将会复位，应用程序“hello\_world”开始运行。

如果希望使用 Eclipse 或是 VS Code IDE，而非 idf.py，请参考 [Eclipse Plugin](#)，以及 [VSCode Extension](#)。

**监视输出** 可以使用 idf.py -p PORT monitor 命令，监视“hello\_world”工程的运行情况。注意，不要忘记将 PORT 替换为自己的串口名称。

运行该命令后，[IDF 监视器](#) 应用程序将启动。

```
$ idf.py -p <PORT> monitor
Running idf_monitor in directory [...]/esp/hello_world/build
Executing "python [...]/esp-idf/tools/idf_monitor.py -b 115200 [...]/esp/hello_
↳world/build/hello_world.elf"...
--- idf_monitor on <PORT> 115200 ---
--- Quit: Ctrl+] | Menu: Ctrl+T | Help: Ctrl+T followed by Ctrl+H ---
ets Jun  8 2016 00:22:57
```

(下页继续)



```
rst:0x1 (POWERON_RESET),boot:0x13 (SPI_FAST_FLASH_BOOT)
ets Jun  8 2016 00:22:57
...
```

此时，就可以在启动日志和诊断日志之后，看到打印的“Hello world!”了。

```
...
Hello world!
Restarting in 10 seconds...
This is esp32h2 chip with 1 CPU core(s), BLE, 802.15.4 (Zigbee/Thread),
↪silicon revision v0.1, 2 MB external flash
Minimum free heap size: 268256 bytes
Restarting in 9 seconds...
Restarting in 8 seconds...
Restarting in 7 seconds...
```

使用快捷键 Ctrl+]，可退出 ESP-IDF 监视器。

**备注：**也可以运行以下命令，一次性执行构建、烧录和监视过程：

```
idf.py -p PORT flash monitor
```

此外，

- 请前往 [IDF 监视器](#)，了解更多使用 ESP-IDF 监视器的快捷键和其他详情。
- 请前往 [idf.py](#)，查看更多 idf.py 命令和选项。

**恭喜完成 ESP32-H2 的入门学习！**

现在，可以尝试一些其他 [examples](#)，或者直接开发自己的应用程序。

**重要：**一些示例程序不支持 ESP32-H2，因为 ESP32-H2 中不包含所需的硬件。

在编译示例程序前请查看 README 文件中 Supported Targets 表格。如果表格中包含 ESP32-H2，或者不存在这个表格，那么即表示 ESP32-H2 支持这个示例程序。

## 其他提示

**权限问题** 使用某些 Linux 版本向 ESP32-H2 烧录固件时，可能会出现类似 Could not open port <PORT>: Permission denied: '<PORT>' 错误消息。此时可以在 Linux 将用户添加至 [dialout 组](#) 或 [uucp 组](#) 来解决此类问题。

**兼容的 Python 版本** ESP-IDF 支持 Python 3.8 及以上版本，建议升级操作系统到最新版本从而更新 Python。也可选择从 [sources](#) 安装最新版 Python，或使用 Python 管理系统如 [pyenv](#) 对版本进行升级管理。

**擦除 flash** ESP-IDF 支持擦除 flash。请运行以下命令，擦除整个 flash：

```
idf.py -p PORT erase-flash
```

若存在需要擦除的 OTA 数据，请运行以下命令：

```
idf.py -p PORT erase-otadata
```

擦除 flash 需要一段时间，在擦除过程中，请勿断开设备连接。

**相关文档** 想要自定义安装流程的高阶用户可参照：

- 在 *Windows* 环境下更新 *ESP-IDF* 工具
- 与 *ESP32-H2* 创建串口连接
- Eclipse Plugin
- VSCode Extension
- *IDF* 监视器

## 在 Windows 环境下更新 ESP-IDF 工具

**使用脚本安装 ESP-IDF 工具** 请从 Windows “命令提示符” 窗口，切换至 ESP-IDF 的安装目录。然后运行：

```
install.bat
```

对于 Powershell，请切换至 ESP-IDF 的安装目录。然后运行：

```
install.ps1
```

该命令可下载并安装 ESP-IDF 所需的工具。如已经安装了某个版本的工具，则该命令将无效。该工具的下  
载安装位置由 ESP-IDF 工具安装器的设置决定，默认情况下为：C:\Users\username\.espressif。

**使用“导出脚本”将 ESP-IDF 工具添加至 PATH 环境变量** ESP-IDF 工具安装器将在“开始菜单”为  
“ESP-IDF 命令提示符”创建快捷方式。点击该快捷方式可打开 Windows 命令提示符窗口，可在该窗口使  
用所有已安装的工具。

有些情况下，正在使用的命令提示符窗口并不是通过快捷方式打开的，此时如果想要在该窗口使用  
ESP-IDF，可以根据下方步骤将 ESP-IDF 工具添加至 PATH 环境变量。

首先，请打开需要使用 ESP-IDF 的命令提示符窗口，切换至安装 ESP-IDF 的目录，然后执行 `export.bat`，  
具体命令如下：

```
cd %userprofile%\esp\esp-idf  
export.bat
```

对于 Powershell 用户，请同样切换至安装 ESP-IDF 的目录，然后执行 `export.ps1`，具体命令如下：

```
cd ~/esp/esp-idf  
export.ps1
```

运行完成后，就可以通过命令提示符使用 ESP-IDF 工具了。

## 与 ESP32-H2 创建串口连接

可以使用 USB 至 UART 桥或 ESP32-H2 支持的 USB 外设，与 ESP32-H2 创建串口连接。

部分开发板中已经安装有 USB 至 UART 桥。如未安装，可使用外部桥。

**支持的 USB 外设** ESP32-H2 支持 USB 外设。无需 USB 至 UART 桥，便可直接烧录设备。

部分支持 USB 外设的开发板同时也包含 USB 至 UART 桥。

**安装有 USB 至 UART 桥的开发板** 在安装有 USB 至 UART 桥的开发板中，PC 和桥之间通过 USB 连接，  
桥和 ESP32-H2 之间通过 UART 连接。

**外部 USB 至 UART 桥** 部分开发板使用外部 USB 至 UART 桥。这种情况通常出现在需要控制空间和成  
本的产品中，例如一些小型开发板或成品。



图 6: 支持 USB 的 SoC



图 7: 安装有 USB 至 UART 桥的开发板

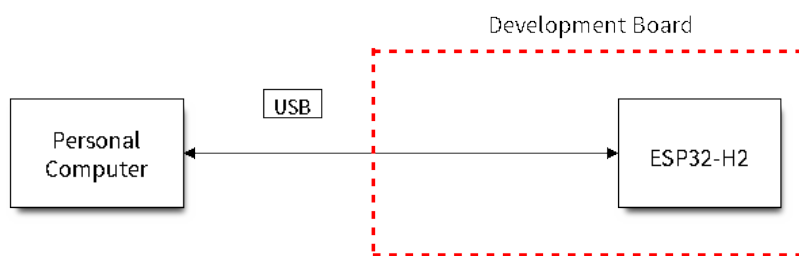

图 8: 外部 USB 至 UART 桥

**使用 USB 进行烧录** ESP32-H2 支持 USB 外设，无需外部 USB 至 UART 桥，即可烧录二进制文件。ESP32-H2 上的 USB 使用 **GPIO27** 作为 **D+**，**GPIO26** 作为 **D-**。

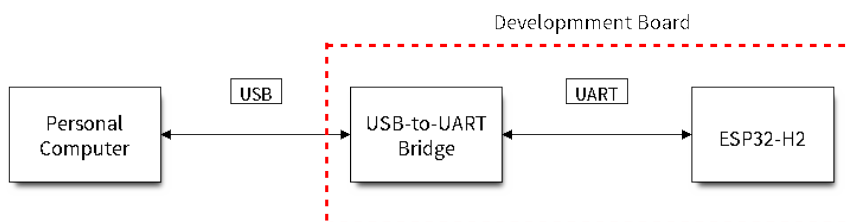
---

**备注：**ESP32-H2 仅支持 *USB CDC and JTAG*。

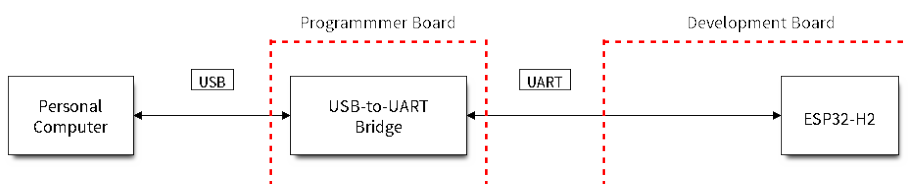
---

首次烧录需要手动设置 ESP32-H2 进入下载模式。请按住 BOOT 按钮，同时按一下 RESET 按钮。之后，松开 BOOT 按钮。

**使用 UART 进行烧录** 本节描述如何使用 USB 至 UART 桥在 ESP32-H2 和 PC 之间建立串行连接。板上桥与外部桥均适用。

**连接 ESP32-H2 和 PC** 用 USB 线将 ESP32-H2 开发板连接到 PC。如果设备驱动程序没有自动安装，请先确认 ESP32-H2 开发板上的 USB 至 UART 桥（或外部转 UART 适配器）型号，然后在网上搜索驱动程序，并进行手动安装。

以下是乐鑫 ESP32-H2 开发板驱动程序的链接：

- CP210x: [CP210x USB 至 UART 桥 VCP 驱动程序](#)
- FTDI: [FTDI 虚拟 COM 端口驱动程序](#)

以上驱动仅供参考，请查看开发板用户指南，了解开发板具体使用的 USB 至 UART 桥芯片。一般情况下，当 ESP32-H2 开发板与 PC 连接时，对应驱动程序应该已经被打包在操作系统中，并已经自动安装。

对于使用 USB 至 UART 桥下载的设备，可以运行以下命令，包括定义波特率的可选参数。

```
idf.py -p PORT [-b BAUD] flash
```

将 PORT 替换为 ESP32-H2 开发板的串口名称。-b 为可选参数，默认的波特率为 460800。如需改变烧录器的波特率，请用需要的波特率代替 BAUD。

要查看串口名称，Windows 用户请参考[check-port-on-windows](#)，Linux 与 macOS 用户请参考[check-port-on-linux-and-macos](#)。

例如，Windows 平台上串口名称为 COM3，所需波特率为 115200，可使用如下命令烧录开发板：

```
idf.py -p COM3 -b 115200 flash
```

Linux 平台上串口名称为 /dev/ttyUSB0，所需波特率为 115200，可使用如下命令烧录开发板：

```
idf.py -p /dev/ttyUSB0 -b 115200 flash
```

macOS 平台上串口名称为 /dev/cu.usbserial-1401，所需波特率为 115200，可使用如下命令烧录开发板：

```
idf.py -p /dev/cu.usbserial-1401 -b 115200 flash
```

---

**备注：**如果设备不支持自动下载模式，则需要手动进入下载模式。请按住 BOOT 按钮，同时按一下 RESET 按钮。之后，松开 BOOT 按钮。

---

**在 Windows 上查看端口** 检查 Windows 设备管理器中的 COM 端口列表。断开 ESP32-H2 与 PC 的连接，然后重新连接，查看哪个端口从列表中消失后又再次出现。

以下为 ESP32 DevKitC 和 ESP32 WROVER KIT 串口：



图 9: 设备管理器中 ESP32-DevKitC 的 USB 至 UART 桥



图 10: Windows 设备管理器中 ESP-WROVER-KIT 的两个 USB 串行端口

**在 Linux 和 macOS 上查看端口** 查看 ESP32-H2 开发板（或外部转串口适配器）的串口设备名称，请将以下命令运行两次。首先，断开开发板或适配器，首次运行以下命令；然后，连接开发板或适配器，再次运行以下命令。其中，第二次运行命令后出现的端口即是 ESP32-H2 对应的串口：

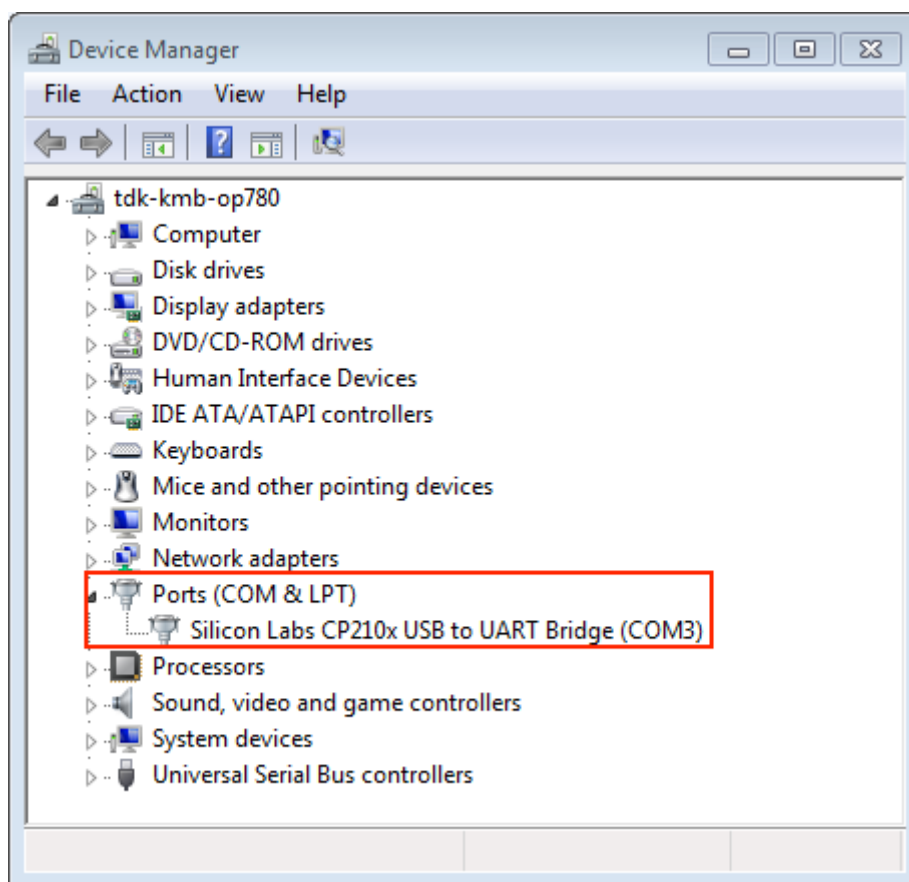
Linux:

```
ls /dev/tty*
```

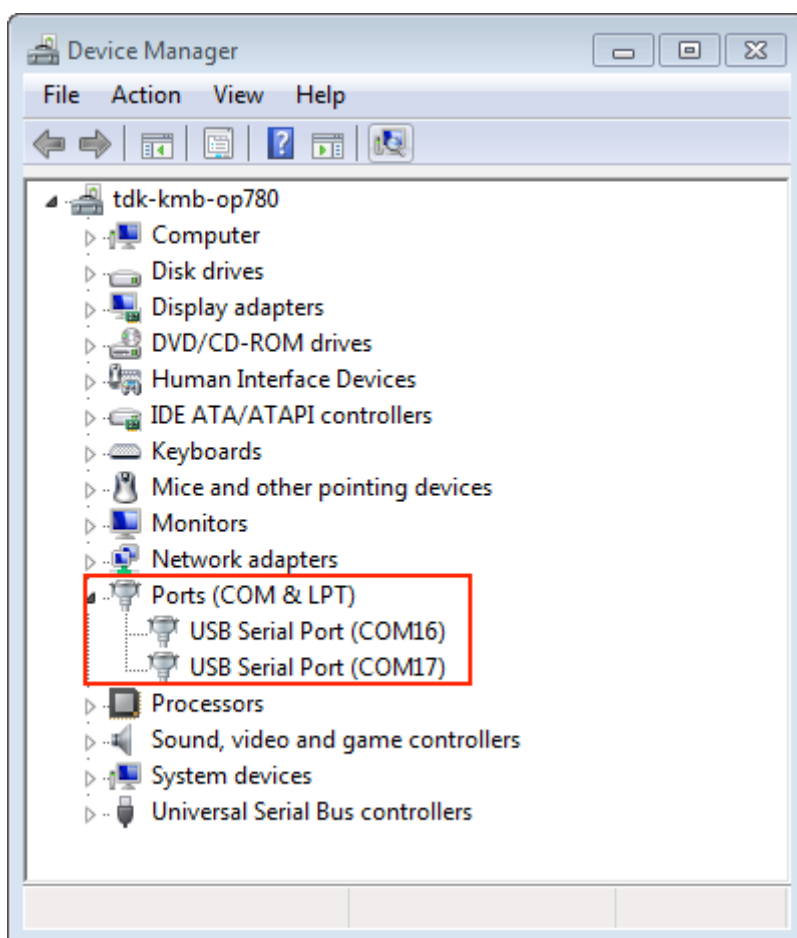
macOS:

```
ls /dev/cu.*
```

**备注：**对于 macOS 用户：若没有看到串口，请检查是否安装 USB/串口驱动程序。具体应使用的驱动程序，见章节[连接 ESP32-H2 和 PC](#)。对于 macOS High Sierra (10.13) 的用户，你可能还需要手动允许驱动程序的加载，具体可打开 系统偏好设置 -> 安全和隐私 -> 通用，检查是否有信息显示：“来自开发人员的系统软件...”，其中开发人员的名称为 Silicon Labs 或 FTDI。

**在 Linux 中添加用户到 dialout 或 uucp 组** 当前登录用户应当可以通过 USB 对串口进行读写操作。在多数 Linux 版本中，都可以通过以下命令，将用户添加到 dialout 组，从而获许读写权限：

```
sudo usermod -a -G dialout $USER
```

在 Arch Linux 中，需要通过以下命令将用户添加到 uucp 组中：

```
sudo usermod -a -G uucp $USER
```

请重新登录，确保串口读写权限生效。

**确认串口连接** 现在，请使用串口终端程序，查看重置 ESP32-H2 后终端上是否有输出，从而验证串口连接是否可用。

ESP32-H2 的控制台波特率默认为 115200。

**Windows 和 Linux 操作系统** 在本示例中，我们将使用 PuTTY SSH Client，PuTTY SSH Client 既可用于 Windows 也可用于 Linux。也可以使用其他串口程序并设置如下的通信参数。

运行终端，配置在上述步骤中确认的串口：波特率 = 115200（如有需要，请更改为使用芯片的默认波特率），数据位 = 8，停止位 = 1，奇偶校验 = N。以下截屏分别展示了如何在 Windows 和 Linux 中配置串口和上述通信参数（如 115200-8-1-N）。注意，这里一定要选择在上述步骤中确认的串口进行配置。

然后，请检查 ESP32-H2 是否有打印日志。如有，请在终端打开串口进行查看。这里的日志内容取决于加载到 ESP32-H2 的应用程序，请参考[输出示例](#)。如果没有看到输出日志，请尝试重启开发板。

**备注：**请在验证完串口通信正常后，关闭串口终端。如果终端一直保持打开的状态，之后上传固件时将无法访问串口。

**备注：**如果没有日志输出，请检查以下原因：

- ESP32-H2 的供电是否正常
- 启动终端程序后，是否重置开发板
- 使用在 [Windows 上查看端口](#) 与在 [Linux 和 macOS 上查看端口](#) 中描述的方法，检查所选串口是否正确
- 其他程序是否正在使用该串口
- 对于 [Windows 和 Linux 操作系统](#) 中描述的串口终端程序，其选择的端口是否正确
- 串口终端程序中的串口设置是否适用于该应用程序
- 开发板上选择的 USB 连接器（UART）是否正确



图 11: 在 Windows 操作系统中使用 PuTTY 设置串口通信参数



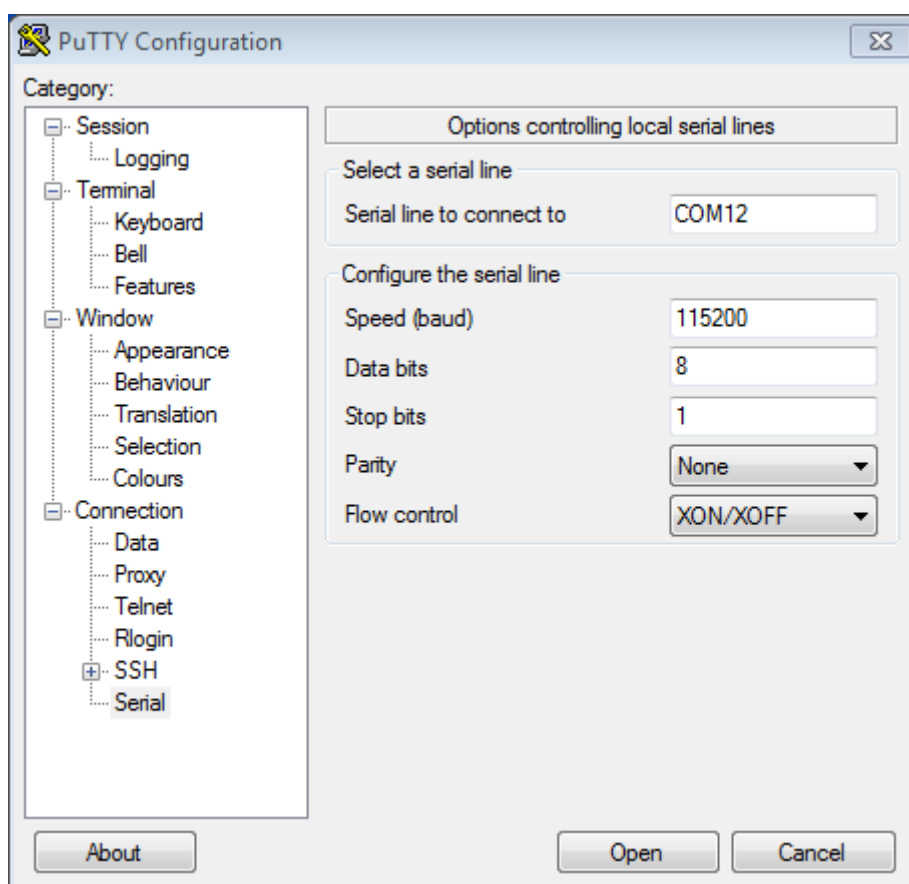

图 12: 在 Linux 操作系统中使用 PuTTY 设置串口通信参数

- 应用程序是否会输出日志
- 是否禁用了日志输出（使用 [hello world 示例](#) 进行测试）

**macOS 操作系统** macOS 提供了 **屏幕命令**，因此无需安装串口终端程序。

- 参考在 [Linux](#) 和 [macOS](#) 上查看端口，运行以下命令：

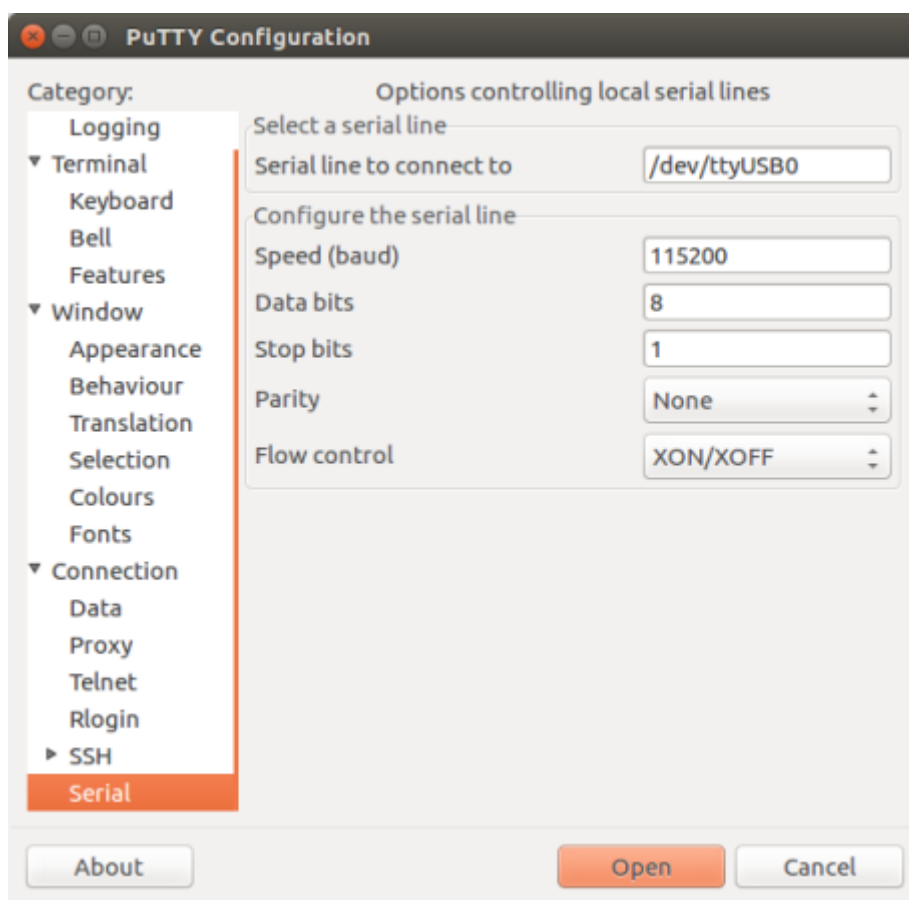
```
ls /dev/cu.*
```

- 会看到类似如下输出：

```
/dev/cu.Bluetooth-Incoming-Port /dev/cu.SLAB_USBtoUART /dev/cu.SLAB_
↪USBtoUART7
```

- 根据连接到电脑上的开发板类型和数量，输出结果会有所不同。请选择开发板的设备名称，并运行以下命令（如有需要，请将“115200”更改为使用芯片的默认波特率）：

```
screen /dev/cu.device_name 115200
```

将 device\_name 替换为运行 `ls /dev/cu.*` 后出现的设备串口号。

- **屏幕**显示的日志即为所需内容。日志内容取决于加载到 ESP32-H2 的应用程序，请参考[输出示例](#)。请使用 `Ctrl-A + K` 键退出当前 **屏幕**会话。

**备注：**请在验证完串口通信正常后，关闭 **当前屏幕会话**。如果直接关闭终端窗口而没有关闭 **屏幕**，之后上传固件时将无法访问串口。

**输出示例** 以下是一个日志示例。如果没看到任何输出，请尝试重置开发板。

```
ets Jun  8 2016 00:22:57

rst:0x5 (DEEPSLEEP_RESET),boot:0x13 (SPI_FAST_FLASH_BOOT)
ets Jun  8 2016 00:22:57

rst:0x7 (TG0WDT_SYS_RESET),boot:0x13 (SPI_FAST_FLASH_BOOT)
configsip: 0, SPIWP:0x00
clk_drv:0x00,q_drv:0x00,d_drv:0x00,cs0_drv:0x00,hd_drv:0x00,wp_drv:0x00
mode:DIO, clock div:2
load:0x3fff0008,len:8
load:0x3fff0010,len:3464
load:0x40078000,len:7828
load:0x40080000,len:252
entry 0x40080034
I (44) boot: ESP-IDF v2.0-rc1-401-gf9fba35 2nd stage bootloader
I (45) boot: compile time 18:48:10
...
```

如果打印出的日志是可读的（而不是乱码），则表示串口连接正常。此时，可以继续安装，并最终将应用程序上载到 ESP32-H2。

**备注：**在某些串口接线方式下，在 ESP32-H2 启动并开始打印串口日志前，需要在终端程序中禁用串口 RTS & DTR 管脚。该问题仅存在于将 RTS & DTR 管脚直接连接到 EN & GPIO9 管脚上的情况，绝大多数开发板（包括乐鑫所有的开发板）都没有这个问题。更多详细信息，请参考 [esptool 文档](#)。

如在安装 ESP32-H2 硬件开发的软件环境时，从 [第五步：开始使用 ESP-IDF 吧](#) 跳转到了这里，请从 [第五步：开始使用 ESP-IDF 吧](#) 继续阅读。

## 烧录故障排除

**连接失败** 如果在运行给定命令时出现如“连接失败”这样的错误，造成该错误的原因之一可能是运行 `esptool.py` 时出现错误。`esptool.py` 是构建系统调用的程序，用于重置芯片、与 ROM 引导加载器交互以及烧录固件的工具。可以按照以下步骤进行手动复位，轻松解决该问题。如果问题仍未解决，请参考 [esptool 故障排除](#) 获取更多信息。

`esptool.py` 通过使 USB 至 UART 桥（如 FTDI 或 CP210x）的 DTR 和 RTS 控制线生效来自动复位 ESP32-H2（请参考与 [ESP32-H2 创建串口连接](#) 获取更多详细信息）。DTR 和 RTS 控制线又连接到 ESP32-H2 的 GPIO9 和 CHIP\_PU (EN) 管脚上，因此 DTR 和 RTS 的电压电平变化会使 ESP32-H2 进入固件下载模式。相关示例可查看 ESP32 DevKitC 开发板的 [原理图](#)。

一般来说，使用官方的 ESP-IDF 开发板不会出现问题。但是，`esptool.py` 在以下情况下不能自动重置硬件：

- 硬件未连接到 GPIO9 和 CHIP\_PU 的 DTR 和 RTS 控制线。
- DTR 和 RTS 控制线的配置方式不同。
- 不存在这样的串行控制线路。

根据硬件的种类，也可以将 ESP32-H2 开发板手动设置为固件下载模式（复位）。

- 对于乐鑫开发板，可以参考对应开发板的入门指南或用户指南。例如，可以通过按住 Boot 按钮 (GPIO9) 再按住 EN 按钮 (CHIP\_PU) 来手动复位 ESP-IDF 开发板。
- 对于其他类型的硬件，可以尝试将 GPIO9 拉低。

## Linux 和 macOS 平台工具链的标准设置

**详细安装步骤** 请根据下方详细步骤，完成安装过程。

**设置开发环境** 以下是为 ESP32-H2 设置 ESP-IDF 的具体步骤。

- [第一步：安装准备](#)
- [第二步：获取 ESP-IDF](#)
- [第三步：设置工具](#)
- [第四步：设置环境变量](#)
- [第五步：开始使用 ESP-IDF 吧](#)

**第一步：安装准备** 为了在 ESP32-H2 中使用 ESP-IDF，需要根据操作系统安装一些软件包。可以参考以下安装指南，安装 Linux 和 macOS 的系统上所有需要的软件包。

**Linux 用户** 编译 ESP-IDF 需要以下软件包。请根据使用的 Linux 发行版本，选择合适的安装命令。

- Ubuntu 和 Debian:

```
sudo apt-get install git wget flex bison gperf python3 python3-pip python3-venv cmake ninja-build ccache libffi-dev libssl-dev dfu-util libusb-1.0-0
```

- CentOS 7 & 8:

```
sudo yum -y update && sudo yum install git wget flex bison gperf python3 python3-setuptools cmake ninja-build ccache dfu-util libusbx
```

目前仍然支持 CentOS 7，但为了更好的用户体验，建议使用 CentOS 8。

- Arch:

```
sudo pacman -S --needed gcc git make flex bison gperf python cmake ninja
↳ccache dfu-util libusb
```

**备注:**

- 使用 ESP-IDF 需要 CMake 3.16 或以上版本。较早的 Linux 发行版可能需要升级自身的软件源仓库，或开启 backports 套件库，或安装“cmake3”软件包（不是安装“cmake”）。
- 如果上述列表中没有当前所用系统，请参考所用系统的相关文档，查看安装软件包所用的命令。

**macOS 用户** ESP-IDF 将使用 macOS 上默认安装的 Python 版本。

- 安装 CMake 和 Ninja 编译工具：
  - 若有 HomeBrew，可以运行：

```
brew install cmake ninja dfu-util
```

- 若有 MacPorts，可以运行：

```
sudo port install cmake ninja dfu-util
```

- 若以上均不适用，请访问 CMake 和 Ninja 主页，查询有关 macOS 平台的下载安装问题。
- 强烈建议同时安装 ccache 以获得更快的编译速度。如有 HomeBrew，可通过 MacPorts 上的 brew install ccache 或 sudo port install ccache 完成安装。

**备注:** 如在上述任何步骤中遇到以下错误：

```
xcrun: error: invalid active developer path (/Library/Developer/CommandLineTools),
↳missing xcrun at: /Library/Developer/CommandLineTools/usr/bin/xcrun
```

则必须安装 XCode 命令行工具，可运行 xcode-select --install 命令进行安装。

**Apple M1 用户** 如果使用的是 Apple M1 系列且看到如下错误提示：

```
WARNING: directory for tool xtensa-esp32-elf version esp-2021r2-patch3-8.4.0 is
↳present, but tool was not found
ERROR: tool xtensa-esp32-elf has no installed versions. Please run 'install.sh' to
↳install it.
```

或者：

```
zsh: bad CPU type in executable: ~/.espressif/tools/xtensa-esp32-elf/esp-2021r2-
↳patch3-8.4.0/xtensa-esp32-elf/bin/xtensa-esp32-elf-gcc
```

运行如下命令，安装 Apple Rosetta 2：

```
/usr/sbin/softwareupdate --install-rosetta --agree-to-license
```

**安装 Python 3** Catalina 10.15 发布说明 中表示不推荐使用 Python 2.7 版本，在未来的 macOS 版本中也不会默认包含 Python 2.7。执行以下命令来检查当前使用的 Python 版本：

```
python --version
```

如果输出结果是 Python 2.7.17，则代表默认解析器是 Python 2.7。这时需要运行以下命令检查电脑上是否已经安装过 Python 3：

```
python3 --version
```

如果运行上述命令出现错误，则代表电脑上没有安装 Python 3。

请根据以下步骤安装 Python 3：

- 使用 [HomeBrew](#) 进行安装的方法如下：

```
brew install python3
```

- 使用 [MacPorts](#) 进行安装的方法如下：

```
sudo port install python38
```

**第二步：获取 ESP-IDF** 在围绕 ESP32-H2 构建应用程序之前，请先获取乐鑫提供的软件库文件 [ESP-IDF 仓库](#)。

获取 ESP-IDF 的本地副本：打开终端，切换到要保存 ESP-IDF 的工作目录，使用 `git clone` 命令克隆远程仓库。针对不同操作系统的详细步骤，请见下文。

打开终端，运行以下命令：

```
mkdir -p ~/esp
cd ~/esp
git clone -b v5.3.1 --recursive https://github.com/espressif/esp-idf.git
```

ESP-IDF 将下载至 `~/esp/esp-idf`。

请前往 [ESP-IDF 版本简介](#)，查看 ESP-IDF 不同版本的具体适用场景。

**第三步：设置工具** 除了 ESP-IDF 本身，还需要为支持 ESP32-H2 的项目安装 ESP-IDF 使用的各种工具，比如编译器、调试器、Python 包等。

```
cd ~/esp/esp-idf
./install.sh esp32h2
```

或使用 Fish shell：

```
cd ~/esp/esp-idf
./install.fish esp32h2
```

上述命令仅仅为 ESP32-H2 安装所需工具。如果需要为多个目标芯片开发项目，则可以一次性指定多个目标，如下所示：

```
cd ~/esp/esp-idf
./install.sh esp32,esp32s2
```

或使用 Fish shell：

```
cd ~/esp/esp-idf
./install.fish esp32,esp32s2
```

如果需要一次性为所有支持的目标芯片安装工具，可以运行如下命令：

```
cd ~/esp/esp-idf
./install.sh all
```

或使用 Fish shell：

```
cd ~/esp/esp-idf
./install.fish all
```

**备注：**对于 macOS 用户，如在上述任何步骤中遇到以下错误：

```
<urlopen error [SSL: CERTIFICATE_VERIFY_FAILED] certificate verify failed: unable_
↳to get local issuer certificate (_ssl.c:xxx)
```

可运行电脑 Python 文件夹中的 `Install Certificates.command` 安装证书。了解更多信息，请参考[安装 ESP-IDF 工具时出现的下载错误](#)。

**下载工具备选方案** ESP-IDF 工具安装器会下载 Github 发布版本中附带的一些工具，如果访问 Github 较为缓慢，可以设置一个环境变量，从而优先选择 Espressif 的下载服务器进行 Github 资源下载。

**备注：**该设置只影响从 Github 发布版本中下载的单一个工具，它并不会改变访问任何 Git 仓库的 URL。

要在安装工具时优先选择 Espressif 下载服务器，请在运行 `install.sh` 时使用以下命令：

```
cd ~/esp/esp-idf
export IDF_GITHUB_ASSETS="dl.espressif.com/github_assets"
./install.sh
```

**备注：**推荐国内用户使用国内的下载服务器，以加快下载速度。

```
cd ~/esp/esp-idf
export IDF_GITHUB_ASSETS="dl.espressif.cn/github_assets"
./install.sh
```

**自定义工具安装路径** 本步骤中介绍的脚本将 ESP-IDF 所需的编译工具默认安装在用户的根目录中，即 Linux 系统中的 `$HOME/.espressif` 目录。可以选择将工具安装到其他目录中，**但在运行安装脚本前，导出环境变量 `IDF_TOOLS_PATH`**。注意，请确保用户账号已经具备了读写该路径的权限。

```
export IDF_TOOLS_PATH="$HOME/required_idf_tools_path"
./install.sh

. ./export.sh
```

如果修改了 `IDF_TOOLS_PATH` 变量，请在运行任意 ESP-IDF 工具或脚本前，将该变量导出到环境变量中。

**备注：**如未导出环境变量，大多数 shell 将不支持在变量赋值中使用 `IDF_TOOLS_PATH`，例如 `IDF_TOOLS_PATH="$HOME/required_idf_tools_path" ./install.sh`。因为即便在源脚本中导出或修改了该变量，当前的执行环境也不受变量赋值影响。

**第四步：设置环境变量** 此时，刚刚安装的工具尚未添加至 `PATH` 环境变量，无法通过“命令窗口”使用这些工具。因此，必须设置一些环境变量。这可以通过 ESP-IDF 提供的另一个脚本进行设置。

请在需要运行 ESP-IDF 的终端窗口运行以下命令：

```
. $HOME/esp/esp-idf/export.sh
```

对于 fish shell（仅支持 fish 3.0.0 及以上版本），请运行以下命令：

```
. $HOME/esp/esp-idf/export.fish
```

注意，命令开始的“.”与路径之间应有一个空格！

如果需要经常运行 ESP-IDF，可以为执行 `export.sh` 创建一个别名，具体步骤如下：

1. 复制并粘贴以下命令到 shell 配置文件中（`.profile`、`.bashrc`、`.zprofile` 等）

```
alias get_idf='. $HOME/esp/esp-idf/export.sh'
```

2. 通过重启终端窗口或运行 `source [path to profile]`，如 `source ~/.bashrc` 来刷新配置文件。

现在可以在任何终端窗口中运行 `get_idf` 来设置或刷新 ESP-IDF 环境。

不建议直接将 `export.sh` 添加到 shell 的配置文件。这样做会导致在每个终端会话中都激活 IDF 虚拟环境（包括无需使用 ESP-IDF 的会话）。这违背了使用虚拟环境的目的，还可能影响其他软件的使用。

**第五步：开始使用 ESP-IDF 吧** 现在你已经具备了使用 ESP-IDF 的所有条件，接下来将介绍如何开始第一个工程。

本指南将介绍如何初步上手 ESP-IDF，包括如何使用 ESP32-H2 创建第一个工程，并构建、烧录和监控设备输出。

---

**备注：**如果还未安装 ESP-IDF，请参照 [安装](#) 中的步骤，获取使用本指南所需的所有软件。

---

**开始创建工程** 现在，可以准备开发 ESP32-H2 应用程序了。可以从 ESP-IDF 中 `examples` 目录下的 `get-started/hello_world` 工程开始。

---

**重要：**ESP-IDF 编译系统不支持 ESP-IDF 路径或其工程路径中带有空格。

---

将 `get-started/hello_world` 工程复制至本地的 `~/esp` 目录下：

```
cd ~/esp
cp -r $IDF_PATH/examples/get-started/hello_world .
```

---

**备注：**ESP-IDF 的 `examples` 目录下有一系列示例工程，可以按照上述方法复制并运行其中的任何示例，也可以直接编译示例，无需进行复制。

---

**连接设备** 现在，请将 ESP32-H2 开发板连接到 PC，并查看开发板使用的串口。

通常，串口在不同操作系统下显示的名称有所不同：

- **Linux 操作系统：**以 `/dev/tty` 开头
- **macOS 操作系统：**以 `/dev/cu.` 开头

有关如何查看串口名称的详细信息，请见与 [ESP32-H2 创建串口连接](#)。

---

**备注：**请记住串口名，以便后续使用。

---

**配置工程** 请进入 `hello_world` 目录，设置 ESP32-H2 为目标芯片，然后运行工程配置工具 `menuconfig`。

```
cd ~/esp/hello_world
idf.py set-target esp32h2
idf.py menuconfig
```



打开一个新工程后，应首先使用 `idf.py set-target esp32h2` 设置“目标”芯片。注意，此操作将清除并初始化项目之前的编译和配置（如有）。也可以直接将“目标”配置为环境变量（此时可跳过该步骤）。更多信息，请见[选择目标芯片：set-target](#)。

正确操作上述步骤后，系统将显示以下菜单：

```
(Top)
      Espressif IoT Development Framework Configuration
SDK tool configuration --->
Build type --->
Application manager --->
Bootloader config --->
Security features --->
Serial flasher config --->
Partition Table --->
Compiler options --->
Component config --->
Compatibility options --->

[Space/Enter] Toggle/enter  [ESC] Leave menu          [S] Save
[O] Load                   [?] Symbol info          [/] Jump to symbol
[F] Toggle show-help mode  [C] Toggle show-name mode [A] Toggle show-all mode
[Q] Quit (prompts for save) [D] Save minimal config (advanced)
```

图 13: 工程配置—主窗口

可以通过此菜单设置项目的具体变量，包括 Wi-Fi 网络名称、密码和处理器速度等。hello\_world 示例项目会以默认配置运行，因此在这一项目中，可以跳过使用 `menuconfig` 进行项目配置这一步骤。

**备注：** 终端窗口中显示出的菜单颜色可能会与上图不同。可以通过选项 `--style` 来改变外观。请运行 `idf.py menuconfig --help` 命令，获取更多信息。

**编译工程** 请使用以下命令，编译烧录工程：

```
idf.py build
```

运行以上命令可以编译应用程序和所有 ESP-IDF 组件，接着生成引导加载程序、分区表和应用程序二进制文件。

```
$ idf.py build
Running cmake in directory /path/to/hello_world/build
Executing "cmake -G Ninja --warn-uninitialized /path/to/hello_world"...
Warn about uninitialized values.
-- Found Git: /usr/bin/git (found version "2.17.0")
-- Building empty aws_iot component due to configuration
-- Component names: ...
-- Component paths: ...

... (more lines of build system output)

[527/527] Generating hello_world.bin
esptool.py v2.3.1

Project build complete. To flash, run this command:
../../components/esptool_py/esptool/esptool.py -p (PORT) -b 921600 write_flash -
↪-flash_mode dio --flash_size detect --flash_freq 40m 0x10000 build/hello_world.
↪bin build 0x1000 build/bootloader/bootloader.bin 0x8000 build/partition_table/
↪partition-table.bin
```

(下页继续)



```
or run 'idf.py -p PORT flash'
```

如果一切正常，编译完成后将生成.bin 文件。

**烧录到设备** 请运行以下命令，将刚刚生成的二进制文件烧录至 ESP32-H2 开发板：

```
idf.py -p PORT flash
```

请将 PORT 替换为 ESP32-H2 开发板的串口名称。如果 PORT 未经定义，*idf.py* 将尝试使用可用的串口自动连接。

更多有关 *idf.py* 参数的详情，请见*idf.py*。

**备注：**勾选 flash 选项将自动编译并烧录工程，因此无需再运行 `idf.py build`。

若在烧录过程中遇到问题，请参考下文中的“其他提示”。也可以前往[烧录故障排除](#) 或与 [ESP32-H2 创建串口连接](#) 获取更多详细信息。

**常规操作** 在烧录过程中，会看到类似如下的输出日志：

```
...
esptool esp32h2 -p /dev/ttyUSB0 -b 460800 --before=default_reset --after=hard_
↳reset write_flash --flash_mode dio --flash_freq 48m --flash_size 2MB 0x0_
↳bootloader/bootloader.bin 0x10000 hello_world.bin 0x8000 partition_table/
↳partition-table.bin
esptool.py v4.6
Serial port /dev/ttyUSB0
Connecting....
Chip is ESP32-H2 (revision v0.1)
Features: BLE
Crystal is 32MHz
MAC: 60:55:f9:f7:3e:93:ff:fe
Uploading stub...
Running stub...
Stub running...
Changing baud rate to 460800
Changed.
Configuring flash size...
Flash will be erased from 0x00000000 to 0x00005fff...
Flash will be erased from 0x00010000 to 0x00034fff...
Flash will be erased from 0x00008000 to 0x00008fff...
Compressed 20880 bytes to 12788...
Writing at 0x00000000... (100 %)
Wrote 20880 bytes (12788 compressed) at 0x00000000 in 0.6 seconds (effective 297.5_
↳kbit/s)...
Hash of data verified.
Compressed 149424 bytes to 79574...
Writing at 0x00010000... (20 %)
Writing at 0x00019959... (40 %)
Writing at 0x00020bb5... (60 %)
Writing at 0x00026d8f... (80 %)
Writing at 0x0002e60a... (100 %)
Wrote 149424 bytes (79574 compressed) at 0x00010000 in 2.1 seconds (effective 571.
↳7 kbit/s)...
Hash of data verified.
Compressed 3072 bytes to 103...
Writing at 0x00008000... (100 %)
Wrote 3072 bytes (103 compressed) at 0x00008000 in 0.0 seconds (effective 539.7_
↳kbit/s)...
```

(下页继续)

(续上页)

```
Hash of data verified.
Leaving...
Hard resetting via RTS pin...
```

如果一切顺利，烧录完成后，开发板将会复位，应用程序“hello\_world”开始运行。

如果希望使用 Eclipse 或是 VS Code IDE，而非 idf.py，请参考 [Eclipse Plugin](#)，以及 [VSCode Extension](#)。

**监视输出** 可以使用 `idf.py -p PORT monitor` 命令，监视“hello\_world”工程的运行情况。注意，不要忘记将 `PORT` 替换为自己的串口名称。

运行该命令后，[IDF 监视器](#) 应用程序将启动。

```
$ idf.py -p <PORT> monitor
Running idf_monitor in directory [...]/esp/hello_world/build
Executing "python [...]/esp-idf/tools/idf_monitor.py -b 115200 [...]/esp/hello_
↔world/build/hello_world.elf"...
--- idf_monitor on <PORT> 115200 ---
--- Quit: Ctrl+] | Menu: Ctrl+T | Help: Ctrl+T followed by Ctrl+H ---
ets Jun  8 2016 00:22:57

rst:0x1 (POWERON_RESET),boot:0x13 (SPI_FAST_FLASH_BOOT)
ets Jun  8 2016 00:22:57
...
```

此时，就可以在启动日志和诊断日志之后，看到打印的“Hello world!”了。

```
...
Hello world!
Restarting in 10 seconds...
This is esp32h2 chip with 1 CPU core(s), BLE, 802.15.4 (Zigbee/Thread),
↔silicon revision v0.1, 2 MB external flash
Minimum free heap size: 268256 bytes
Restarting in 9 seconds...
Restarting in 8 seconds...
Restarting in 7 seconds...
```

使用快捷键 `Ctrl+]`，可退出 ESP-IDF 监视器。

**备注：**也可以运行以下命令，一次性执行构建、烧录和监视过程：

```
idf.py -p PORT flash monitor
```

此外，

- 请前往[IDF 监视器](#)，了解更多使用 ESP-IDF 监视器的快捷键和其他详情。
- 请前往[idf.py](#)，查看更多 `idf.py` 命令和选项。

**恭喜完成 ESP32-H2 的入门学习！**

现在，可以尝试一些其他 [examples](#)，或者直接开发自己的应用程序。

**重要：**一些示例程序不支持 ESP32-H2，因为 ESP32-H2 中不包含所需的硬件。

在编译示例程序前请查看 README 文件中 Supported Targets 表格。如果表格中包含 ESP32-H2，或者不存在这个表格，那么即表示 ESP32-H2 支持这个示例程序。

**其他提示**

**权限问题** 使用某些 Linux 版本向 ESP32-H2 烧录固件时，可能会出现类似 `Could not open port <PORT>: Permission denied: '<PORT>'` 错误消息。此时可以在 Linux 将用户添加至 [dialout 组](#) 或 [uucp 组](#) 来解决此类问题。

**兼容的 Python 版本** ESP-IDF 支持 Python 3.8 及以上版本，建议升级操作系统到最新版本从而更新 Python。也可选择从 [sources](#) 安装最新版 Python，或使用 Python 管理系统如 [pyenv](#) 对版本进行升级管理。

**擦除 flash** ESP-IDF 支持擦除 flash。请运行以下命令，擦除整个 flash：

```
idf.py -p PORT erase-flash
```

若存在需要擦除的 OTA 数据，请运行以下命令：

```
idf.py -p PORT erase-otadata
```

擦除 flash 需要一段时间，在擦除过程中，请勿断开设备连接。

**建议：更新 ESP-IDF** 乐鑫会不时推出新版本的 ESP-IDF，修复 bug 或提供新的功能。请注意，ESP-IDF 的每个主要版本和次要版本都有相应的支持期限。支持期限满后，版本停止更新维护，用户可将项目升级到最新的 ESP-IDF 版本。更多关于支持期限的信息，请参考 [ESP-IDF 版本](#)。

因此，在使用时，也应注意更新本地版本。最简单的方法是：直接删除本地的 `esp-idf` 文件夹，然后按照 [第二步：获取 ESP-IDF](#) 中的指示，重新完成克隆。

另一种方法是仅更新变更的部分，具体方式请前往 [更新 ESP-IDF](#) 章节查看。具体更新步骤会根据使用的 ESP-IDF 版本有所不同。

注意，更新完成后，请再次运行安装脚本，以防新版 ESP-IDF 所需的工具也有所更新。具体请参考 [第三步：设置工具](#)。

一旦重新安装好工具，请使用导出脚本更新环境，具体请参考 [第四步：设置环境变量](#)。

## 相关文档

- [与 ESP32-H2 创建串口连接](#)
- [Eclipse Plugin](#)
- [VSCode Extension](#)
- [IDF 监视器](#)

## 1.4 编译第一个工程

如果已经安装好 ESP-IDF，且没有使用集成开发环境 (IDE)，请在命令提示行中，按照在 [Windows 中开始创建工程](#) 或在 [Linux 和 macOS 中开始创建工程](#) 编译第一个工程。

## 1.5 卸载 ESP-IDF

如需卸载 ESP-IDF，请参考 [卸载 ESP-IDF](#)。

## Chapter 2

# API 参考

### 2.1 API 约定

本文介绍了 ESP-IDF 应用程序编程接口 (API) 中常见的约定和假设。

ESP-IDF 提供了几种编程接口：

- 在 ESP-IDF 组件的公共头文件中声明的 C 函数、结构体、枚举、类型定义和预处理器宏。编程指南的 API 参考部分描述了这些函数、结构体和类型。
- 编译系统函数、预定义变量和选项，详情请参阅[ESP-IDF CMake 构建系统 API](#)。
- [Kconfig](#) 选项，可用于代码及编译系统文件 (CMakeLists.txt)。
- [主机工具](#) 及其命令行参数。

ESP-IDF 由多个组件组成，组件中包含专门为 ESP 芯片编写的代码或第三方库（即第三方组件）。对于某些第三方库，ESP-IDF 提供专用的包装器和接口，以简化对第三方库的使用，或提高其与 ESP-IDF 其他功能的兼容性。某些情况下，第三方组件将直接呈现底层库的原始 API。

以下各节介绍了部分 ESP-IDF API 及其使用的相关内容。

#### 2.1.1 错误处理

多数 ESP-IDF API 会返回由 `esp_err_t` 类型定义的错误代码。有关出错处理的更多信息，请参阅[错误处理](#) 部分。有关 ESP-IDF 组件返回的错误代码列表，请参阅[错误代码参考](#)。

#### 2.1.2 配置结构体

---

**重要：** 为确保应用程序与未来 ESP-IDF 版本的兼容性，请正确初始化配置结构体。

---

多数 ESP-IDF 中的初始化、配置和安装函数（通常以 `..._init()`、`..._config()` 和 `..._install()` 命名）都需要一个指向配置结构体的指针作为参数。例如：

```
const esp_timer_create_args_t my_timer_args = {
    .callback = &my_timer_callback,
    .arg = callback_arg,
    .name = "my_timer"
};
```

(下页继续)



### 2.1.3 私有 API

在 ESP-IDF 中，某些头文件包含的 API 仅限于在 ESP-IDF 源代码中使用，不支持在应用程序中使用。此类头文件的名称或路径通常带有 `private` 或 `esp_private`。某些组件（如 `hal`）则仅包含私有 API。

私有 API 可能在次要或补丁版本之间以不兼容的方式被删除或更改。

### 2.1.4 示例项目组件

ESP-IDF 示例中提供了一系列演示 ESP-IDF API 使用方式的工程。为避免在各个示例中重复引用相同的代码片段，示例的常用组件中定义了一些通用辅助工具。这些常用组件包括 `common_components` 目录下的组件和示例本身的部分组件，它们不属于 ESP-IDF API 的范畴。

不建议在自定义项目中通过 `EXTRA_COMPONENT_DIRS` 编译系统变量直接引用这些组件，因为在不同的 ESP-IDF 版本中，组件可能存在显著变化。基于 ESP-IDF 示例开始新项目时，需将项目及其所依赖的公共组件从 ESP-IDF 中复制出来，并将公共组件视为项目的一部分。请注意，公共组件是针对示例编写的，可能不包括生产应用程序所需的所有出错处理。在使用前，需阅读代码并判断它是否适用于所需用例。

### 2.1.5 API 稳定性

ESP-IDF 使用 [语义版本管理办法](#)，详情请参阅 [版本管理](#)。

ESP-IDF 的次要版本和错误修复版本会保证与过往版本的兼容性。以下各节解释了兼容性的不同方面和限制。

#### 源代码级别兼容性

ESP-IDF 确保在 ESP-IDF 组件的公共头文件中声明的 C 函数、结构体、枚举、类型定义和预处理宏的源代码级别兼容性。源代码级别兼容性意味着应用程序无需修改即可在新版本的 ESP-IDF 上重新编译。

以下在次要版本之间的更改不会破坏源代码级别兼容性：

- 使用 `deprecated` 属性废弃函数、使用预处理器 `#warning` 废弃头文件。废弃功能已在 ESP-IDF 发布说明中列出。建议更新源代码以使用替换被废弃的函数或文件的新函数或文件。ESP-IDF 的主要版本将移除废弃的函数和文件。
- 重命名组件，在组件间移动源代码和头文件，但需确保编译系统仍可以找到正确的文件。
- 重命名 Kconfig 选项。Kconfig 系统的 [向后兼容性](#) 确保应用程序在 `sdkconfig` 文件、CMake 文件和源代码中仍然可以使用原始的 Kconfig 选项名称。

#### 缺少二进制兼容性

ESP-IDF 无法确保版本间的二进制兼容性。这意味着，如果使用某个 ESP-IDF 版本构建了一个预编译库，在下一个次要或错误修复版本中，无法确保该库将以相同方式运行。以下更改可以保持源代码级别兼容性，但不保证二进制兼容性：

- 更改 C 枚举成员的数值。
- 添加新的结构体成员或更改成员顺序。关于有助于确保兼容性的提示，请参阅 [配置结构体](#)。
- 用具有相同签名的 `static inline` 函数替换 `extern` 函数，反之亦然。
- 用兼容的 C 函数替换类似于函数的宏。

#### 其他不兼容情况

尽管我们致力于优化 ESP-IDF 版本升级，但是在次要版本之间，ESP-IDF 的某些部分可能会不兼容。如有不属于下列情况的意外重大更新，欢迎向我们发送报告：

- [私有 API](#)。
- [示例项目组件](#)。

- 明确标记为“beta”、“preview”或“experimental”的功能。
- 为缓解安全问题做出的更改，或以更安全的行为取代不安全的默认行为的更改。
- 从未运行成功的功能。例如，如果某个函数或枚举值从未成功使用，则可能会以修复的形式将其重命名或删除。这包括依赖于非功能芯片硬件功能的软件功能。
- 未明确记录的意外或未定义行为可能会被修复或更改，如缺少参数范围验证。
- 在菜单配置中 *Kconfig* 选项的位置。
- 示例项目的位置和名称。

## 2.2 应用层协议

### 2.2.1 ASIO 端口

ASIO 是一个跨平台的 C++ 库，参见 <https://think-async.com/Asio/>。它采用现代 C++ 方法提供了一个一致的异步模型。

ASIO 组件自 ESP-IDF 版本 v5.0 起移到了单独的仓库：

- [GitHub ASIO 组件](#)

运行 `idf.py add-dependency espressif/asio` 将 ASIO 组件添加到你的项目中。

#### 文档

访问以下链接查看相关文档：

- [ASIO 文档 \(English\)](#)

### 2.2.2 ESP-Modbus

乐鑫的 ESP-Modbus 库 (`esp-modbus`) 支持基于 RS485、Wi-Fi 和以太网接口的 Modbus 通信。自 ESP-IDF v5.0 版本以来，组件 `freemodbus` 已被移动到单独的代码仓库中：

- [GitHub 上的 ESP-Modbus 组件](#)

#### 托管文档

相应文档请参阅：

- [ESP-Modbus 文档](#)

#### 应用示例

以下示例分别介绍了 ESP-Modbus 库的串行端口、TCP 端口的从机和主机实现。

- [protocols/modbus/serial/mb\\_slave](#)
- [protocols/modbus/serial/mb\\_master](#)
- [protocols/modbus/tcp/mb\\_tcp\\_slave](#)
- [protocols/modbus/tcp/mb\\_tcp\\_master](#)

详情请参阅具体示例的 `README.md`。



## 协议参考

- Modbus 组织与规范协议请参阅 [The Modbus Organization](#)。

### 2.2.3 ESP-MQTT

#### 概述

ESP-MQTT 是 MQTT 协议客户端的实现，MQTT 是一种基于发布/订阅模式的轻量级消息传输协议。ESP-MQTT 当前支持 MQTT v5.0。

#### 特性

- 支持基于 TCP 的 MQTT、基于 Mbed TLS 的 SSL、基于 WebSocket 的 MQTT 以及基于 WebSocket Secure 的 MQTT
- 通过 URI 简化配置流程
- 多个实例（一个应用程序中有多个客户端）
- 支持订阅、发布、认证、遗嘱消息、保持连接心跳机制以及 3 个服务质量 (QoS) 级别（组成全功能客户端）

#### 应用示例

- `protocols/mqtt/tcp`: 基于 TCP 的 MQTT，默认端口 1883
- `protocols/mqtt/ssl`: 基于 TLS 的 MQTT，默认端口 8883
- `protocols/mqtt/ssl_ds`: 基于 TLS 的 MQTT，使用数字签名外设进行身份验证，默认端口 8883
- `protocols/mqtt/ssl_mutual_auth`: 基于 TLS 的 MQTT，使用证书进行身份验证，默认端口 8883
- `protocols/mqtt/ssl_psk`: 基于 TLS 的 MQTT，使用预共享密钥进行身份验证，默认端口 8883
- `protocols/mqtt/ws`: 基于 WebSocket 的 MQTT，默认端口 80
- `protocols/mqtt/wss`: 基于 WebSocket Secure 的 MQTT，默认端口 443
- `protocols/mqtt5`: 使用 ESP-MQTT 库连接 MQTT v5.0 的服务器

#### MQTT 消息重传

调用 `esp_mqtt_client_publish` 或其非阻塞形式 `esp_mqtt_client_enqueue`，可以创建新的 MQTT 消息。

QoS 0 的消息将只发送一次，QoS 1 和 2 具有不同行为，因为协议需要执行额外步骤来完成该过程。

ESP-MQTT 库将始终重新传输未确认的 QoS 1 和 2 发布消息，以避免连接错误导致信息丢失，虽然 MQTT 规范要求仅在重新连接且 Clean Session 标志设置为 0 时重新传输（针对此行为，将 `disable_clean_session` 设置为 true）。

可能需要重传的 QoS 1 和 2 消息总是处于排队状态，但若使用 `esp_mqtt_client_publish` 则会立即进行第一次传输尝试。未确认消息的重传将在 `message_retransmit_timeout` 之后进行。在 `CONFIG_MQTT_OUTBOX_EXPIRED_TIMEOUT_MS` 之后，消息会过期并被删除。如已设置 `CONFIG_MQTT_REPORT_DELETED_MESSAGES`，则会发送事件来通知用户。

#### 配置

通过设置 `esp_mqtt_client_config_t` 结构体中的字段来进行配置。配置结构体包含以下子结构体，用于配置客户端的多种操作。

- `esp_mqtt_client_config_t::broker_t` - 允许设置地址和安全验证。



- `esp_mqtt_client_config_t::credentials_t` - 用于身份验证的客户端凭据。
- `esp_mqtt_client_config_t::session_t` - MQTT 会话相关配置。
- `esp_mqtt_client_config_t::network_t` - 网络相关配置。
- `esp_mqtt_client_config_t::task_t` - 允许配置 FreeRTOS 任务。
- `esp_mqtt_client_config_t::buffer_t` - 输入输出的缓冲区大小。

下文将详细介绍不同配置。

## 服务器

**地址** 通过 `address` 结构体的 `uri` 字段或者 `hostname`、`transport` 以及 `port` 的组合，可以设置服务器地址。也可以选择设置 `path`，该字段对 WebSocket 连接而言非常有用。

使用 `uri` 字段的格式为 `scheme://hostname:port/path`。

- 当前支持 mqtt、mqtts、ws 和 wss 协议
- 基于 TCP 的 MQTT 示例：
  - `mqtt://mqtt.eclipseprojects.io`: 基于 TCP 的 MQTT，默认端口 1883
  - `mqtt://mqtt.eclipseprojects.io:1884`: 基于 TCP 的 MQTT，端口 1884
  - `mqtt://username:password@mqtt.eclipseprojects.io:1884`: 基于 TCP 的 MQTT，端口 1884，带有用户名和密码
- 基于 SSL 的 MQTT 示例：
  - `mqtts://mqtt.eclipseprojects.io`: 基于 SSL 的 MQTT，端口 8883
  - `mqtts://mqtt.eclipseprojects.io:8884`: 基于 SSL 的 MQTT，端口 8884
- 基于 WebSocket 的 MQTT 示例：
  - `ws://mqtt.eclipseprojects.io:80/mqtt`
- 基于 WebSocket Secure 的 MQTT 示例：
  - `wss://mqtt.eclipseprojects.io:443/mqtt`
- 最简配置：

```
const esp_mqtt_client_config_t mqtt_cfg = {
    .broker.address.uri = "mqtt://mqtt.eclipseprojects.io",
};
esp_mqtt_client_handle_t client = esp_mqtt_client_init(&mqtt_cfg);
esp_mqtt_client_register_event(client, ESP_EVENT_ANY_ID, mqtt_event_handler,
↪client);
esp_mqtt_client_start(client);
```

**备注：**默认情况下，MQTT 客户端使用事件循环库来发布相关 MQTT 事件（已连接、已订阅、已发布等）。

**验证** 为验证服务器身份，对于使用 TLS 的安全链接，必须设置 `verification` 结构体。服务器证书可设置为 PEM 或 DER 格式。如要选择 DER 格式，必须设置等效 `certificate_len` 字段，否则应在 `certificate` 字段传入以空字符结尾的 PEM 格式字符串。

- 从服务器获取证书，例如：`mqtt.eclipseprojects.io`

```
openssl s_client -showcerts -connect mqtt.eclipseprojects.io:8883 < /dev/
↪null \
2> /dev/null | openssl x509 -outform PEM > mqtt_eclipse_org.pem
```

- 检查示例应用程序：[protocols/mqtt/ssl](#)
- 配置：

```
const esp_mqtt_client_config_t mqtt_cfg = {
    .broker = {
        .address.uri = "mqtts://mqtt.eclipseprojects.io:8883",
```

(下页继续)

```

        .verification.certificate = (const char *)mqtt_eclipse_org_pem_start,
    },
};

```

了解其他字段的详细信息，请查看[API 参考](#) 以及[TLS 服务器验证](#)。

**客户端凭据** `credentials` 字段下包含所有客户端相关凭据。

- `username`: 指向用于连接服务器用户名的指针，也可通过 URI 设置
- `client_id`: 指向客户端 ID 的指针，默认为 ESP32\_%CHIPID%，其中 %CHIPID% 是十六进制 MAC 地址的最后 3 个字节

**认证** 可以通过 `authentication` 字段设置认证参数。客户端支持以下认证方式：

- `password`: 使用密码
- `certificate` 和 `key`: 进行双向 TLS 身份验证，PEM 或 DER 格式均可
- `use_secure_element`: 使用 ESP32 中的安全元素 (ATECC608A)
- `ds_data`: 使用某些乐鑫设备的数字签名外设

**会话** 使用 `session` 字段进行 MQTT 会话相关配置。

**遗嘱消息 (LWT)** 通过设置 `last_will` 结构体的以下字段，MQTT 会在一个客户端意外断开连接时通过遗嘱消息通知其他客户端。

- `topic`: 指向 LWT 消息主题的指针
- `msg`: 指向 LWT 消息的指针
- `msg_len`: LWT 消息的长度，`msg` 不以空字符结尾时需要该字段
- `qos`: LWT 消息的服务质量
- `retain`: 指定 LWT 消息的保留标志

**在项目配置菜单中设置 MQTT** 通过 `idf.py menuconfig`，可以在 Component config > ESP-MQTT Configuration 中找到 MQTT 设置。

相关设置如下：

- `CONFIG_MQTT_PROTOCOL_311`: 启用 MQTT 协议 3.1.1 版本
- `CONFIG_MQTT_TRANSPORT_SSL` 和 `CONFIG_MQTT_TRANSPORT_WEBSOCKET`: 启用特定 MQTT 传输层，例如 SSL、WEBSOCKET 和 WEBSOCKET\_SECURE
- `CONFIG_MQTT_CUSTOM_OUTBOX`: 禁用 `mqtt_outbox` 默认实现，因此可以提供特定实现

## 事件

MQTT 客户端可能会发布以下事件：

- `MQTT_EVENT_BEFORE_CONNECT`: 客户端已初始化并即将开始连接至服务器。
- `MQTT_EVENT_CONNECTED`: 客户端已成功连接至服务器。客户端已准备好收发数据。
- `MQTT_EVENT_DISCONNECTED`: 由于无法读取或写入数据，例如因为服务器无法使用，客户端已终止连接。
- `MQTT_EVENT_SUBSCRIBED`: 服务器已确认客户端的订阅请求。事件数据将包含订阅消息的消息 ID。
- `MQTT_EVENT_UNSUBSCRIBED`: 服务器已确认客户端的退订请求。事件数据将包含退订消息的消息 ID。
- `MQTT_EVENT_PUBLISHED`: 服务器已确认客户端的发布消息。消息将仅针对 QoS 级别 1 和 2 发布，因为级别 0 不会进行确认。事件数据将包含发布消息的消息 ID。

- `MQTT_EVENT_DATA`: 客户端已收到发布消息。事件数据包含: 消息 ID、发布消息所属主题名称、收到的数据及其长度。对于超出内部缓冲区的数据, 将发布多个 `MQTT_EVENT_DATA`, 并更新事件数据的 `current_data_offset` 和 `total_data_len` 以跟踪碎片化消息。
- `MQTT_EVENT_ERROR`: 客户端遇到错误。使用事件数据 `error_handle` 字段中的 `error_type`, 可以发现错误。错误类型决定 `error_handle` 结构体的哪些部分会被填充。

## API 参考

### Header File

- `components/mqtt/esp-mqtt/include/mqtt_client.h`
- This header file can be included with:

```
#include "mqtt_client.h"
```

- This header file is a part of the API provided by the `mqtt` component. To declare that your component depends on `mqtt`, add the following to your `CMakeLists.txt`:

```
REQUIRES mqtt
```

or

```
PRIV_REQUIRES mqtt
```

### Functions

`esp_mqtt_client_handle_t esp_mqtt_client_init` (const `esp_mqtt_client_config_t` \*config)

Creates *MQTT* client handle based on the configuration.

参数 `config` -- *MQTT* configuration structure

返回 `mqtt_client_handle` if successfully created, `NULL` on error

`esp_err_t esp_mqtt_client_set_uri` (`esp_mqtt_client_handle_t` client, const char \*uri)

Sets *MQTT* connection URI. This API is usually used to overrides the URI configured in `esp_mqtt_client_init`.

参数

- `client` -- *MQTT* client handle
- `uri` --

返回 `ESP_FAIL` if URI parse error, `ESP_OK` on success

`esp_err_t esp_mqtt_client_start` (`esp_mqtt_client_handle_t` client)

Starts *MQTT* client with already created client handle.

参数 `client` -- *MQTT* client handle

返回 `ESP_OK` on success `ESP_ERR_INVALID_ARG` on wrong initialization `ESP_FAIL` on other error

`esp_err_t esp_mqtt_client_reconnect` (`esp_mqtt_client_handle_t` client)

This api is typically used to force reconnection upon a specific event.

参数 `client` -- *MQTT* client handle

返回 `ESP_OK` on success `ESP_ERR_INVALID_ARG` on wrong initialization `ESP_FAIL` if client is in invalid state

`esp_err_t esp_mqtt_client_disconnect` (`esp_mqtt_client_handle_t` client)

This api is typically used to force disconnection from the broker.

参数 `client` -- *MQTT* client handle

返回 `ESP_OK` on success `ESP_ERR_INVALID_ARG` on wrong initialization

`esp_err_t esp_mqtt_client_stop` (`esp_mqtt_client_handle_t` client)

Stops *MQTT* client tasks.

- Notes:
- Cannot be called from the *MQTT* event handler

**参数** **client** -- *MQTT* client handle

**返回** ESP\_OK on success ESP\_ERR\_INVALID\_ARG on wrong initialization ESP\_FAIL if client is in invalid state

int **esp\_mqtt\_client\_subscribe\_single** (*esp\_mqtt\_client\_handle\_t* client, const char \*topic, int qos)  
Subscribe the client to defined topic with defined qos.

Notes:

- Client must be connected to send subscribe message
- This API is could be executed from a user task or from a *MQTT* event callback i.e. internal *MQTT* task (API is protected by internal mutex, so it might block if a longer data receive operation is in progress.
- `esp_mqtt_client_subscribe` could be used to call this function.

**参数**

- **client** -- *MQTT* client handle
- **topic** -- topic filter to subscribe
- **qos** -- Max qos level of the subscription

**返回** message\_id of the subscribe message on success -1 on failure -2 in case of full outbox.

int **esp\_mqtt\_client\_subscribe\_multiple** (*esp\_mqtt\_client\_handle\_t* client, const *esp\_mqtt\_topic\_t* \*topic\_list, int size)

Subscribe the client to a list of defined topics with defined qos.

Notes:

- Client must be connected to send subscribe message
- This API is could be executed from a user task or from a *MQTT* event callback i.e. internal *MQTT* task (API is protected by internal mutex, so it might block if a longer data receive operation is in progress.
- `esp_mqtt_client_subscribe` could be used to call this function.

**参数**

- **client** -- *MQTT* client handle
- **topic\_list** -- List of topics to subscribe
- **size** -- size of topic\_list

**返回** message\_id of the subscribe message on success -1 on failure -2 in case of full outbox.

int **esp\_mqtt\_client\_unsubscribe** (*esp\_mqtt\_client\_handle\_t* client, const char \*topic)

Unsubscribe the client from defined topic.

Notes:

- Client must be connected to send unsubscribe message
- It is thread safe, please refer to `esp_mqtt_client_subscribe_single` for details

**参数**

- **client** -- *MQTT* client handle
- **topic** --

**返回** message\_id of the subscribe message on success -1 on failure

int **esp\_mqtt\_client\_publish** (*esp\_mqtt\_client\_handle\_t* client, const char \*topic, const char \*data, int len, int qos, int retain)

Client to send a publish message to the broker.

Notes:

- This API might block for several seconds, either due to network timeout (10s) or if publishing payloads longer than internal buffer (due to message fragmentation)

- Client doesn't have to be connected for this API to work, enqueueing the messages with qos>1 (returning -1 for all the qos=0 messages if disconnected). If MQTT\_SKIP\_PUBLISH\_IF\_DISCONNECTED is enabled, this API will not attempt to publish when the client is not connected and will always return -1.
- It is thread safe, please refer to `esp_mqtt_client_subscribe` for details

**参数**

- **client** -- *MQTT* client handle
- **topic** -- topic string
- **data** -- payload string (set to NULL, sending empty payload message)
- **len** -- data length, if set to 0, length is calculated from payload string
- **qos** -- QoS of publish message
- **retain** -- retain flag

**返回** message\_id of the publish message (for QoS 0 message\_id will always be zero) on success.  
-1 on failure, -2 in case of full outbox.

int **esp\_mqtt\_client\_enqueue** (*esp\_mqtt\_client\_handle\_t* client, const char \*topic, const char \*data, int len, int qos, int retain, bool store)

Enqueue a message to the outbox, to be sent later. Typically used for messages with qos>0, but could be also used for qos=0 messages if store=true.

This API generates and stores the publish message into the internal outbox and the actual sending to the network is performed in the mqtt-task context (in contrast to the `esp_mqtt_client_publish()` which sends the publish message immediately in the user task's context). Thus, it could be used as a non blocking version of `esp_mqtt_client_publish()`.

**参数**

- **client** -- *MQTT* client handle
- **topic** -- topic string
- **data** -- payload string (set to NULL, sending empty payload message)
- **len** -- data length, if set to 0, length is calculated from payload string
- **qos** -- QoS of publish message
- **retain** -- retain flag
- **store** -- if true, all messages are enqueued; otherwise only QoS 1 and QoS 2 are enqueued

**返回** message\_id if queued successfully, -1 on failure, -2 in case of full outbox.

*esp\_err\_t* **esp\_mqtt\_client\_destroy** (*esp\_mqtt\_client\_handle\_t* client)

Destroys the client handle.

Notes:

- Cannot be called from the *MQTT* event handler

**参数** **client** -- *MQTT* client handle

**返回** ESP\_OK ESP\_ERR\_INVALID\_ARG on wrong initialization

*esp\_err\_t* **esp\_mqtt\_set\_config** (*esp\_mqtt\_client\_handle\_t* client, const *esp\_mqtt\_client\_config\_t* \*config)

Set configuration structure, typically used when updating the config (i.e. on "before\_connect" event).

Notes:

- When calling this function make sure to have all the intended configurations set, otherwise default values are set.

**参数**

- **client** -- *MQTT* client handle
- **config** -- *MQTT* configuration structure

**返回** ESP\_ERR\_NO\_MEM if failed to allocate ESP\_ERR\_INVALID\_ARG if conflicts on transport configuration. ESP\_OK on success

`esp_err_t esp_mqtt_client_register_event` (`esp_mqtt_client_handle_t` client, `esp_mqtt_event_id_t` event, `esp_event_handler_t` event\_handler, void \*event\_handler\_arg)

Registers *MQTT* event.

#### 参数

- **client** -- *MQTT* client handle
- **event** -- event type
- **event\_handler** -- handler callback
- **event\_handler\_arg** -- handlers context

**返回** ESP\_ERR\_NO\_MEM if failed to allocate ESP\_ERR\_INVALID\_ARG on wrong initialization ESP\_OK on success

`esp_err_t esp_mqtt_client_unregister_event` (`esp_mqtt_client_handle_t` client, `esp_mqtt_event_id_t` event, `esp_event_handler_t` event\_handler)

Unregisters mqtt event.

#### 参数

- **client** -- mqtt client handle
- **event** -- event ID
- **event\_handler** -- handler to unregister

**返回** ESP\_ERR\_NO\_MEM if failed to allocate ESP\_ERR\_INVALID\_ARG on invalid event ID ESP\_OK on success

int `esp_mqtt_client_get_outbox_size` (`esp_mqtt_client_handle_t` client)

Get outbox size.

**参数** **client** -- *MQTT* client handle

**返回** outbox size 0 on wrong initialization

`esp_err_t esp_mqtt_dispatch_custom_event` (`esp_mqtt_client_handle_t` client, `esp_mqtt_event_t` \*event)

Dispatch user event to the mqtt internal event loop.

#### 参数

- **client** -- *MQTT* client handle
- **event** -- *MQTT* event handle structure

**返回** ESP\_OK on success ESP\_ERR\_TIMEOUT if the event couldn't be queued (ref also CONFIG\_MQTT\_EVENT\_QUEUE\_SIZE)

## Structures

struct `esp_mqtt_error_codes`

*MQTT* error code structure to be passed as a contextual information into ERROR event

Important: This structure extends `esp_tls_last_error` error structure and is backward compatible with it (so might be down-casted and treated as `esp_tls_last_error` error, but recommended to update applications if used this way previously)

Use this structure directly checking error\_type first and then appropriate error code depending on the source of the error:

error_type	related member variables	note
MQTT_ERROR_TYPE_TCP_TRANSPORT	esp_tls_last_esp_err, esp_tls_stack_err, esp_tls_cert_verify_flags, sock_errno	Error reported from tcp_transport/esp-tls
MQTT_ERROR_TYPE_CONNECTION_REFUSED	connect_return_code	Internal error reported from <i>MQTT</i> broker on connection

## Public Members

`esp_err_t esp_tls_last_esp_err`

last esp\_err code reported from esp-tls component

int **esp\_tls\_stack\_err**

tls specific error code reported from underlying tls stack

int **esp\_tls\_cert\_verify\_flags**

tls flags reported from underlying tls stack during certificate verification

*esp\_mqtt\_error\_type\_t* **error\_type**

error type referring to the source of the error

*esp\_mqtt\_connect\_return\_code\_t* **connect\_return\_code**

connection refused error code reported from MQTT\* broker on connection

int **esp\_transport\_sock\_errno**

errno from the underlying socket

struct **esp\_mqtt\_event\_t**

*MQTT* event configuration structure

### Public Members

*esp\_mqtt\_event\_id\_t* **event\_id**

*MQTT* event type

*esp\_mqtt\_client\_handle\_t* **client**

*MQTT* client handle for this event

char \***data**

Data associated with this event

int **data\_len**

Length of the data for this event

int **total\_data\_len**

Total length of the data (longer data are supplied with multiple events)

int **current\_data\_offset**

Actual offset for the data associated with this event

char \***topic**

Topic associated with this event

int **topic\_len**

Length of the topic for this event associated with this event

int **msg\_id**

*MQTT* messaged id of message

int **session\_present**

*MQTT* session\_present flag for connection event

*esp\_mqtt\_error\_codes\_t* \***error\_handle**

esp-mqtt error handle including esp-tls errors as well as internal *MQTT* errors

bool **retain**

Retained flag of the message associated with this event

int **qos**

QoS of the messages associated with this event

bool **dup**

dup flag of the message associated with this event

*esp\_mqtt\_protocol\_ver\_t* **protocol\_ver**

*MQTT* protocol version used for connection, defaults to value from menuconfig

struct **esp\_mqtt\_client\_config\_t**

*MQTT* client configuration structure

- Default values can be set via menuconfig
- All certificates and key data could be passed in PEM or DER format. PEM format must have a terminating NULL character and the related len field set to 0. DER format requires a related len field set to the correct length.

### Public Members

struct *esp\_mqtt\_client\_config\_t::broker\_t* **broker**

Broker address and security verification

struct *esp\_mqtt\_client\_config\_t::credentials\_t* **credentials**

User credentials for broker

struct *esp\_mqtt\_client\_config\_t::session\_t* **session**

*MQTT* session configuration.

struct *esp\_mqtt\_client\_config\_t::network\_t* **network**

Network configuration

struct *esp\_mqtt\_client\_config\_t::task\_t* **task**

FreeRTOS task configuration.

struct *esp\_mqtt\_client\_config\_t::buffer\_t* **buffer**

Buffer size configuration.

struct *esp\_mqtt\_client\_config\_t::outbox\_config\_t* **outbox**

Outbox configuration.



struct **broker\_t**  
Broker related configuration

### Public Members

struct *esp\_mqtt\_client\_config\_t::broker\_t::address\_t* **address**  
Broker address configuration

struct *esp\_mqtt\_client\_config\_t::broker\_t::verification\_t* **verification**  
Security verification of the broker

struct **address\_t**  
Broker address

- uri have precedence over other fields
- If uri isn't set at least hostname, transport and port should.

### Public Members

const char \***uri**  
Complete *MQTT* broker URI

const char \***hostname**  
Hostname, to set ipv4 pass it as string)

*esp\_mqtt\_transport\_t* **transport**  
Selects transport

const char \***path**  
Path in the URI

uint32\_t **port**  
*MQTT* server port

struct **verification\_t**  
Broker identity verification  
If fields are not set broker's identity isn't verified. it's recommended to set the options in this struct for security reasons.

### Public Members

bool **use\_global\_ca\_store**  
Use a global ca\_store, look esp-tls documentation for details.

`esp_err_t (*crt_bundle_attach)(void *conf)`

Pointer to ESP x509 Certificate Bundle attach function for the usage of certificate bundles. Client only attach the bundle, the clean up must be done by the user.

const char \***certificate**

Certificate data, default is NULL. It's not copied nor freed by the client, user needs to clean up.

size\_t **certificate\_len**

Length of the buffer pointed to by certificate.

const struct *psk\_key\_hint* \***psk\_hint\_key**

Pointer to PSK struct defined in `esp_tls.h` to enable PSK authentication (as alternative to certificate verification). PSK is enabled only if there are no other ways to verify broker. It's not copied nor freed by the client, user needs to clean up.

bool **skip\_cert\_common\_name\_check**

Skip any validation of server certificate CN field, this reduces the security of TLS and makes the *MQTT* client susceptible to MITM attacks

const char \*\***alpn\_protos**

NULL-terminated list of supported application protocols to be used for ALPN.

const char \***common\_name**

Pointer to the string containing server certificate common name. If non-NULL, server certificate CN must match this name, If NULL, server certificate CN must match hostname. This is ignored if `skip_cert_common_name_check=true`. It's not copied nor freed by the client, user needs to clean up.

struct **buffer\_t**

Client buffer size configuration

Client have two buffers for input and output respectively.

### Public Members

int **size**

size of *MQTT* send/receive buffer

int **out\_size**

size of *MQTT* output buffer. If not defined, defaults to the size defined by `buffer_size`

struct **credentials\_t**

Client related credentials for authentication.

### Public Members

const char \***username**

*MQTT* username

const char \***client\_id**

Set *MQTT* client identifier. Ignored if `set_null_client_id == true` If NULL set the default client id. Default client id is `ESP32_CHIPID%` where `CHIPID%` are last 3 bytes of MAC address in hex format

bool **set\_null\_client\_id**

Selects a NULL client id

struct *esp\_mqtt\_client\_config\_t::credentials\_t::authentication\_t* **authentication**

Client authentication

struct **authentication\_t**

Client authentication

Fields related to client authentication by broker

For mutual authentication using TLS, user could select certificate and key, secure element or digital signature peripheral if available.

### Public Members

const char \***password**

*MQTT* password

const char \***certificate**

Certificate for ssl mutual authentication, not required if mutual authentication is not needed. Must be provided with `key`. It's not copied nor freed by the client, user needs to clean up.

size\_t **certificate\_len**

Length of the buffer pointed to by certificate.

const char \***key**

Private key for SSL mutual authentication, not required if mutual authentication is not needed. If it is not NULL, also `certificate` has to be provided. It's not copied nor freed by the client, user needs to clean up.

size\_t **key\_len**

Length of the buffer pointed to by key.

const char \***key\_password**

Client key decryption password, not PEM nor DER, if provided `key_password_len` must be correctly set.

int **key\_password\_len**

Length of the password pointed to by `key_password`

bool **use\_secure\_element**

Enable secure element, available in ESP32-ROOM-32SE, for SSL connection

void **\*ds\_data**

Carrier of handle for digital signature parameters, digital signature peripheral is available in some Espressif devices. It's not copied nor freed by the client, user needs to clean up.

struct **network\_t**

Network related configuration

### Public Members

int **reconnect\_timeout\_ms**

Reconnect to the broker after this value in milliseconds if auto reconnect is not disabled (defaults to 10s)

int **timeout\_ms**

Abort network operation if it is not completed after this value, in milliseconds (defaults to 10s).

int **refresh\_connection\_after\_ms**

Refresh connection after this value (in milliseconds)

bool **disable\_auto\_reconnect**

Client will reconnect to server (when errors/disconnect). Set `disable_auto_reconnect=true` to disable

esp\_transport\_handle\_t **transport**

Custom transport handle to use. Warning: The transport should be valid during the client lifetime and is destroyed when `esp_mqtt_client_destroy` is called.

struct ifreq **\*if\_name**

The name of interface for data to go through. Use the default interface without setting

struct **outbox\_config\_t**

Client outbox configuration options.

### Public Members

uint64\_t **limit**

Size limit for the outbox in bytes.

struct **session\_t**

*MQTT* Session related configuration

### Public Members

struct *esp\_mqtt\_client\_config\_t::session\_t::last\_will\_t* **last\_will**

Last will configuration

bool **disable\_clean\_session**

*MQTT* clean session, default clean\_session is true

int **keepalive**

*MQTT* keepalive, default is 120 seconds When configuring this value, keep in mind that the client attempts to communicate with the broker at half the interval that is actually set. This conservative approach allows for more attempts before the broker's timeout occurs

bool **disable\_keepalive**

Set `disable_keepalive=true` to turn off keep-alive mechanism, keepalive is active by default. Note: setting the config value `keepalive` to 0 doesn't disable keepalive feature, but uses a default keepalive period

*esp\_mqtt\_protocol\_ver\_t* **protocol\_ver**

*MQTT* protocol version used for connection.

int **message\_retransmit\_timeout**

timeout for retransmitting of failed packet

struct **last\_will\_t**

Last Will and Testament message configuration.

### Public Members

const char \***topic**

LWT (Last Will and Testament) message topic

const char \***msg**

LWT message, may be NULL terminated

int **msg\_len**

LWT message length, if msg isn't NULL terminated must have the correct length

int **qos**

LWT message QoS

int **retain**

LWT retained message flag

struct **task\_t**

Client task configuration

### Public Members

int **priority**

*MQTT* task priority

int **stack\_size**  
*MQTT* task stack size

struct **topic\_t**  
Topic definition struct

### Public Members

const char \***filter**  
Topic filter to subscribe

int **qos**  
Max QoS level of the subscription

### Macros

#### **MQTT\_ERROR\_TYPE\_ESP\_TLS**

**MQTT\_ERROR\_TYPE\_TCP\_TRANSPORT** error type hold all sorts of transport layer errors, including ESP-TLS error, but in the past only the errors from **MQTT\_ERROR\_TYPE\_ESP\_TLS** layer were reported, so the ESP-TLS error type is re-defined here for backward compatibility

**esp\_mqtt\_client\_subscribe** (client\_handle, topic\_type, qos\_or\_size)

Convenience macro to select subscribe function to use.

Notes:

- Usage of `esp_mqtt_client_subscribe_single` is the same as previous `esp_mqtt_client_subscribe`, refer to it for details.

#### 参数

- **client\_handle** -- *MQTT* client handle
- **topic\_type** -- Needs to be char\* for single subscription or `esp_mqtt_topic_t` for multiple topics
- **qos\_or\_size** -- It's either a qos when subscribing to a single topic or the size of the subscription array when subscribing to multiple topics.

**返回** message\_id of the subscribe message on success -1 on failure -2 in case of full outbox.

### Type Definitions

typedef struct esp\_mqtt\_client \***esp\_mqtt\_client\_handle\_t**

typedef enum *esp\_mqtt\_event\_id\_t* **esp\_mqtt\_event\_id\_t**

*MQTT* event types.

User event handler receives context data in *esp\_mqtt\_event\_t* structure with

- client - *MQTT* client handle
- various other data depending on event type

typedef enum *esp\_mqtt\_connect\_return\_code\_t* **esp\_mqtt\_connect\_return\_code\_t**

*MQTT* connection error codes propagated via ERROR event

typedef enum *esp\_mqtt\_error\_type\_t* **esp\_mqtt\_error\_type\_t**

*MQTT* connection error codes propagated via ERROR event

```
typedef enum esp_mqtt_transport_t esp_mqtt_transport_t
```

```
typedef enum esp_mqtt_protocol_ver_t esp_mqtt_protocol_ver_t
```

*MQTT* protocol version used for connection

```
typedef struct esp_mqtt_error_codes esp_mqtt_error_codes_t
```

*MQTT* error code structure to be passed as a contextual information into ERROR event

Important: This structure extends *esp\_tls\_last\_error* error structure and is backward compatible with it (so might be down-casted and treated as *esp\_tls\_last\_error* error, but recommended to update applications if used this way previously)

Use this structure directly checking `error_type` first and then appropriate error code depending on the source of the error:

<code>error_type</code>	related member variables	note	<code>MQTT_ERROR_TYPE_TCP_TRANSPORT</code>
<code>esp_tls_last_esp_err</code> ,	<code>esp_tls_stack_err</code> ,	<code>esp_tls_cert_verify_flags</code> ,	<code>sock_errno</code>
Error reported from	<code>tcp_transport/esp-tls</code>	<code>MQTT_ERROR_TYPE_CONNECTION_REFUSED</code>	<code>connect_return_code</code>
Internal error reported from	<i>MQTT</i> broker on connection		

```
typedef struct esp_mqtt_event_t esp_mqtt_event_t
```

*MQTT* event configuration structure

```
typedef esp_mqtt_event_t *esp_mqtt_event_handle_t
```

```
typedef struct esp_mqtt_client_config_t esp_mqtt_client_config_t
```

*MQTT* client configuration structure

- Default values can be set via `menuconfig`
- All certificates and key data could be passed in PEM or DER format. PEM format must have a terminating NULL character and the related `len` field set to 0. DER format requires a related `len` field set to the correct length.

```
typedef struct topic_t esp_mqtt_topic_t
```

Topic definition struct

## Enumerations

```
enum esp_mqtt_event_id_t
```

*MQTT* event types.

User event handler receives context data in *esp\_mqtt\_event\_t* structure with

- client - *MQTT* client handle
- various other data depending on event type

Values:

enumerator **MQTT\_EVENT\_ANY**

enumerator **MQTT\_EVENT\_ERROR**

on error event, additional context: connection return code, error handle from `esp_tls` (if supported)

enumerator **MQTT\_EVENT\_CONNECTED**

connected event, additional context: session\_present flag

enumerator **MQTT\_EVENT\_DISCONNECTED**

disconnected event

enumerator **MQTT\_EVENT\_SUBSCRIBED**

subscribed event, additional context:

- msg\_id message id
- error\_handle error\_type in case subscribing failed
- data pointer to broker response, check for errors.
- data\_len length of the data for this event

enumerator **MQTT\_EVENT\_UNSUBSCRIBED**

unsubscribed event, additional context: msg\_id

enumerator **MQTT\_EVENT\_PUBLISHED**

published event, additional context: msg\_id

enumerator **MQTT\_EVENT\_DATA**

data event, additional context:

- msg\_id message id
- topic pointer to the received topic
- topic\_len length of the topic
- data pointer to the received data
- data\_len length of the data for this event
- current\_data\_offset offset of the current data for this event
- total\_data\_len total length of the data received
- retain retain flag of the message
- qos QoS level of the message
- dup dup flag of the message Note: Multiple MQTT\_EVENT\_DATA could be fired for one message, if it is longer than internal buffer. In that case only first event contains topic pointer and length, other contain data only with current data length and current data offset updating.

enumerator **MQTT\_EVENT\_BEFORE\_CONNECT**

The event occurs before connecting

enumerator **MQTT\_EVENT\_DELETED**

Notification on delete of one message from the internal outbox, if the message couldn't have been sent and acknowledged before expiring defined in OUTBOX\_EXPIRED\_TIMEOUT\_MS. (events are not posted upon deletion of successfully acknowledged messages)

- This event id is posted only if MQTT\_REPORT\_DELETED\_MESSAGES==1
- Additional context: msg\_id (id of the deleted message).

enumerator **MQTT\_USER\_EVENT**

Custom event used to queue tasks into mqtt event handler All fields from the *esp\_mqtt\_event\_t* type could be used to pass an additional context data to the handler.

enum **esp\_mqtt\_connect\_return\_code\_t**

MQTT connection error codes propagated via ERROR event

Values:



enumerator **MQTT\_CONNECTION\_ACCEPTED**

Connection accepted

enumerator **MQTT\_CONNECTION\_REFUSE\_PROTOCOL**

*MQTT* connection refused reason: Wrong protocol

enumerator **MQTT\_CONNECTION\_REFUSE\_ID\_REJECTED**

*MQTT* connection refused reason: ID rejected

enumerator **MQTT\_CONNECTION\_REFUSE\_SERVER\_UNAVAILABLE**

*MQTT* connection refused reason: Server unavailable

enumerator **MQTT\_CONNECTION\_REFUSE\_BAD\_USERNAME**

*MQTT* connection refused reason: Wrong user

enumerator **MQTT\_CONNECTION\_REFUSE\_NOT\_AUTHORIZED**

*MQTT* connection refused reason: Wrong username or password

enum **esp\_mqtt\_error\_type\_t**

*MQTT* connection error codes propagated via ERROR event

*Values:*

enumerator **MQTT\_ERROR\_TYPE\_NONE**

enumerator **MQTT\_ERROR\_TYPE\_TCP\_TRANSPORT**

enumerator **MQTT\_ERROR\_TYPE\_CONNECTION\_REFUSED**

enumerator **MQTT\_ERROR\_TYPE\_SUBSCRIBE\_FAILED**

enum **esp\_mqtt\_transport\_t**

*Values:*

enumerator **MQTT\_TRANSPORT\_UNKNOWN**

enumerator **MQTT\_TRANSPORT\_OVER\_TCP**

*MQTT* over TCP, using scheme: *MQTT*

enumerator **MQTT\_TRANSPORT\_OVER\_SSL**

*MQTT* over SSL, using scheme: *MQTTS*

enumerator **MQTT\_TRANSPORT\_OVER\_WS**

*MQTT* over WebSocket, using scheme:: *ws*

enumerator **MQTT\_TRANSPORT\_OVER\_WSS**

*MQTT* over WebSocket Secure, using scheme: *wss*

enum **esp\_mqtt\_protocol\_ver\_t**

*MQTT* protocol version used for connection

Values:

enumerator **MQTT\_PROTOCOL\_UNDEFINED**

enumerator **MQTT\_PROTOCOL\_V\_3\_1**

enumerator **MQTT\_PROTOCOL\_V\_3\_1\_1**

enumerator **MQTT\_PROTOCOL\_V\_5**

## 2.2.4 ESP-TLS

### 概述

ESP-TLS 组件提供简化 API 接口，用于访问常用 TLS 功能，支持如 CA 认证验证、SNI、ALPN 协商和非阻塞连接等常见场景，相关配置可在数据结构体 `esp_tls_cfg_t` 中指定。配置完成后，使用以下 API 进行 TLS 通信：

- `esp_tls_init()`：初始化 TLS 连接句柄。
- `esp_tls_conn_new_sync()`：开启新的阻塞式 TLS 连接。
- `esp_tls_conn_new_async()`：开启新的非阻塞式 TLS 连接。
- `esp_tls_conn_read()`：读取 TLS 层之上的应用数据。
- `esp_tls_conn_write()`：将应用数据写入 TLS 连接。
- `esp_tls_conn_destroy()`：释放连接。

任何应用层协议，如 HTTP1、HTTP2 等，均可调用 ESP-TLS 组件接口实现。

### 应用示例

使用 ESP-TLS 建立安全套接字连接的 HTTPS 简单示例，请参阅 [protocols/https\\_request](#)。

### ESP-TLS 组件的树形结构

```

├─ esp_tls.c
├─ esp_tls.h
├─ esp_tls_mbedtls.c
├─ esp_tls_wolfssl.c
└─ private_include
   └─ esp_tls_mbedtls.h
      └─ esp_tls_wolfssl.h

```

ESP-TLS 组件文件 `esp-tls/esp_tls.h` 包含该组件的公共 API 头文件。在 ESP-TLS 组件内部，为了实现安全会话功能，会使用 MbedTLS 和 WolfSSL 两个 SSL/TLS 库中的其中一个进行安全会话的建立，与 MbedTLS 相关的 API 存放在 `esp-tls/private_include/esp_tls_mbedtls.h`，而与 WolfSSL 相关的 API 存放在 `esp-tls/private_include/esp_tls_wolfssl.h`。

## TLS 服务器验证

ESP-TLS 在客户端提供了多种验证 TLS 服务器的选项，如验证对端服务器的服务器证书、或使用预共享密钥验证服务器。用户应在 `esp_tls_cfg_t` 结构体中选择以下任一选项完成 TLS 服务器验证，若未做选择，则客户端默认在 TLS 连接创建时，会返回错误。

- **cacert\_buf** 和 **cacert\_bytes**: 以缓冲区的形式向 `esp_tls_cfg_t` 结构体提供 CA 证书，ESP-TLS 将使用缓冲区中的 CA 证书验证服务器。注意，须在 `esp_tls_cfg_t` 结构体中设置以下变量：
  - `cacert_buf` - 指针，指向包含 CA 证书的缓冲区。
  - `cacert_bytes` - CA 证书大小（以字节为单位）。
- **use\_global\_ca\_store**: `global_ca_store` 可一次性完成初始化及设置，并用于验证 ESP-TLS 连接的服务器，注意需要在这些服务器各自的 `esp_tls_cfg_t` 结构体中设置 `use_global_ca_store = true`。有关初始化和设置 `global_ca_store` 的不同 API，请参阅文末的 API 参考。
- **crt\_bundle\_attach**: ESP x509 证书包 API 提供了便捷的服务器验证方法，即打包一组自定义的 x509 根证书，用于 TLS 服务器验证，详情请参阅 [ESP x509 证书包](#)。
- **psk\_hint\_key**: 要使用预共享密钥验证服务器，必须在 ESP-TLS menuconfig 中启用 `CONFIG_ESP_TLS_PSK_VERIFICATION`，然后向结构体 `esp_tls_cfg_t` 提供指向 PSK 提示和密钥的指针。若未选择有关服务器验证的其他选项，ESP-TLS 将仅用 PSK 验证服务器。
- **跳过服务器验证**: 该选项并不安全，仅供测试使用。在 ESP-TLS menuconfig 中启用 `CONFIG_ESP_TLS_INSECURE` 和 `CONFIG_ESP_TLS_SKIP_SERVER_CERT_VERIFY` 可启用该选项，此时，若未在 `esp_tls_cfg_t` 结构体选择其他服务器验证选项，ESP-TLS 将默认跳过服务器验证。

**警告:** 启用 **跳过服务器验证** 选项存在潜在风险，若未通过 API 或 `ca_store` 等其他机制提供服务器证书，可能导致设备与伪造身份的服务器建立 TLS 连接。

## ESP-TLS 服务器证书选择回调

使用 MbedTLS 协议栈时，ESP-TLS 组件支持设置服务器证书选择回调函数。此时，在服务器握手期间可选择使用哪个服务器证书，该回调可获取客户端发送的“Client Hello”消息中提供的 TLS 扩展（ALPN、SPI 等），并基于此选择传输哪个服务器证书给客户端。要启用此功能，请在 ESP-TLS menuconfig 中启用 `CONFIG_ESP_TLS_SERVER_CERT_SELECT_HOOK`。

证书选择回调可在结构体 `esp_tls_cfg_t` 中配置，具体如下：

```
int cert_selection_callback(mbedtls_ssl_context *ssl)
{
    /* 回调应执行的代码 */
    return 0;
}

esp_tls_cfg_t cfg = {
    cert_select_cb = cert_section_callback,
};
```

## 底层 SSL/TLS 库选择

ESP-TLS 组件支持以 MbedTLS 或 WolfSSL 作为其底层 SSL/TLS 库，默认仅使用 MbedTLS，WolfSSL 的 SSL/TLS 库可在 <https://github.com/espressif/esp-wolfssl> 上公开获取，该仓库提供二进制格式的 WolfSSL 组件，并提供了一些示例帮助用户了解相关 API。有关许可证和其他选项，请参阅仓库的 `README.md` 文件。下文介绍了在工程中使用 WolfSSL 的具体流程。

**备注：** 库选项位于 ESP-TLS 内部，因此切换库不会更改工程的 ESP-TLS 特定代码。

### 在 ESP-IDF 使用 WolfSSL

要在工程中使用 WolfSSL，可采取以下两种方式：

- 1) 使用以下三行命令，将 WolfSSL 作为组件直接添加到工程中：

```
(首先用 cd 命令进入工程目录)
mkdir components
cd components
git clone https://github.com/espressif/esp-wolfssl.git
```

- 2) 将 WolfSSL 作为额外组件添加到工程中。

- 使用以下命令下载 WolfSSL：

```
git clone https://github.com/espressif/esp-wolfssl.git
```

- 参照 [wolfssl/examples](#) 示例，在工程的 CMakeLists.txt 文件中设置 EXTRA\_COMPONENT\_DIRS，从而在 ESP-IDF 中包含 ESP-WolfSSL，详情请参阅 [构建系统](#) 中的 [可选的项目变量](#) 小节。

完成上述步骤后，可以在工程配置菜单中将 WolfSSL 作为底层 SSL/TLS 库，具体步骤如下：

```
idf.py menuconfig > ESP-TLS > SSL/TLS Library > Mbedtls/Wolfssl
```

### MbedTLS 与 WolfSSL 对比

下表是在使用 WolfSSL 和 MbedTLS 两种 SSL/TLS 库，并将所有相关配置设置为默认值时，运行具有服务器身份验证的 [protocols/https\\_request](#) 示例的比较结果。对于 MbedTLS，IN\_CONTENT 长度和 OUT\_CONTENT 长度分别设置为 16384 字节和 4096 字节。

属性	WolfSSL	MbedTLS
总消耗堆空间	~ 19 KB	~ 37 KB
任务栈使用	~ 2.2 KB	~ 3.6 KB
二进制文件大小	~ 858 KB	~ 736 KB

**备注：** 若配置选项不同或相应库的版本不同，得到的值可能与上表不同。

### ESP-TLS 的数字签名

ESP-TLS 支持在 ESP32-H2 中使用数字签名 (DS)，但只有当 ESP-TLS 以 MbedTLS (默认协议栈) 为底层 SSL/TLS 协议栈时，才支持使用 TLS 的数字签名。有关数字签名的详细信息，请参阅 [数字签名 \(DS\)](#)。有关数字签名的技术细节 (例如私钥参数计算)，请参阅 [ESP32-H2 技术参考手册 > 数字签名 \(DS\) \[PDF\]](#)。在使用数字签名前，应预先配置数字签名外设，请参阅 [TLS 连接所需的 DS 外设配置](#)。

数字签名外设必须用所需的加密私钥参数初始化，相应参数在配置数字签名外设时获取。具备所需的数字签名上下文，即数字签名参数时，ESP-TLS 会在内部初始化数字签名外设。要将数字签名上下文传递给 ESP-TLS 上下文，请参阅以下代码段。注意，在删除 TLS 连接之前，不应释放传递给 ESP-TLS 上下文的数字签名上下文。

```
#include "esp_tls.h"
esp_ds_data_ctx_t *ds_ctx;
/* 使用加密的私钥参数初始化 ds_ctx，这类参数可以从 nvs_
↳ 中读取，或由应用程序代码提供 */
```

(下页继续)

```
esp_tls_cfg_t cfg = {
    .clientcert_buf = /* 客户端证书 */,
    .clientcert_bytes = /* 客户端证书长度 */,
    /* 其他配置选项 */
    .ds_data = (void *)ds_ctx,
};
```

**备注:** 当使用数字签名进行 TLS 连接时, 除其他必要参数外, 仅需提供客户端证书 (clientcert\_buf) 和数字签名参数 (ds\_data), 此时可将客户端密钥 (clientkey\_buf) 设置为 NULL。

- 使用数字签名外设进行双向认证的示例请参阅 [SSL 双向认证](#), 该示例使用 ESP-TLS 实现 TLS 连接。

### 在 ESP-TLS 中使用 ECDSA 外设

ESP-TLS 支持在 ESP32-H2 中使用 ECDSA 外设。使用 ECDSA 外设时, ESP-TLS 必须与 MbedTLS 一起作为底层 SSL/TLS 协议栈, 并且 ECDSA 的私钥应存储在 eFuse 中。请参考 [espefuse.py](#) 文档, 了解如何在 eFuse 中烧写 ECDSA 密钥。在 ESP-TLS 中启用 ECDSA 外设前, 请将 esp\_tls\_cfg\_t::use\_ecdsa\_peripheral 设置为 true, 并将 esp\_tls\_cfg\_t::ecdsa\_key\_efuse\_blk 设置为存储了 ECDSA 密钥的 eFuse 块 ID。这样就可以使用 ECDSA 外设进行私钥操作。由于客户私钥已经存储在 eFuse 中, 因此无需将其传递给 esp\_tls\_cfg\_t。

```
#include "esp_tls.h"
esp_tls_cfg_t cfg = {
    .use_ecdsa_peripheral = true,
    .ecdsa_key_efuse_blk = /* 存储 ECDSA 私钥的 eFuse 块 */,
};
```

**备注:** 在 TLS 中使用 ECDSA 外设时, 只支持 MBEDTLS\_TLS\_ECDHE\_ECDSA\_WITH\_AES\_128\_GCM\_SHA256 密码套件。如果使用 TLS v1.3, 则支持 MBEDTLS\_TLS1\_3\_AES\_128\_GCM\_SHA256 密码套件。

### TLS 加密套件

ESP-TLS 支持在客户端模式下设置加密套件列表, TLS 密码套件列表用于向服务器传递所支持的密码套件信息, 用户可以根据自己需求增减加密套件, 且适用于任何 TLS 协议栈配置。如果服务器支持列表中的任一密码套件, 则 TLS 连接成功, 反之连接失败。

连接客户端时, 在 esp\_tls\_cfg\_t 结构体中设置 ciphersuites\_list 的步骤如下:

```
/* 加密套件列表必须以 0 结尾, 并且在整个 TLS 连接期间, 加密套件的内存地址空间有效。
↪ */
static const int ciphersuites_list[] = {MBEDTLS_TLS_ECDHE_ECDSA_WITH_AES_256_GCM_
↪SHA384, MBEDTLS_TLS_ECDHE_RSA_WITH_AES_256_GCM_SHA384, 0};
esp_tls_cfg_t cfg = {
    .ciphersuites_list = ciphersuites_list,
};
```

ESP-TLS 不会检查 ciphersuites\_list 的有效性, 因此需调用 esp\_tls\_get\_ciphersuites\_list() 获取 TLS 协议栈中支持的加密套件列表, 并检查设置的加密套件是否在支持的加密套件列表中。

**备注:** 此功能仅在 MbedTLS 协议栈中有效。

## TLS 协议版本

ESP-TLS 能够为 TLS 连接设置相应的 TLS 协议版本，指定版本将用于建立专用 TLS 连接。也就是说，在运行时不同的 TLS 连接可以配置到 TLS 1.2、TLS 1.3 等不同协议版本。

**备注：**目前，仅在 MbedTLS 作为 ESP-TLS 的底层 SSL/TLS 协议栈时支持此功能。

要在 ESP-TLS 中设置 TLS 协议版本，请设置 `esp_tls_cfg_t::tls_version`，从 `esp_tls_proto_ver_t` 中选择所需版本。如未指定协议版本字段，将默认根据服务器要求建立 TLS 连接。

ESP-TLS 连接的协议版本可按如下方式配置：

```
#include "esp_tls.h"
esp_tls_cfg_t cfg = {
    .tls_version = ESP_TLS_VER_TLS_1_2,
};
```

## API 参考

### Header File

- [components/esp-tls/esp\\_tls.h](#)
- This header file can be included with:

```
#include "esp_tls.h"
```

- This header file is a part of the API provided by the `esp-tls` component. To declare that your component depends on `esp-tls`, add the following to your CMakeLists.txt:

```
REQUIRES esp-tls
```

or

```
PRIV_REQUIRES esp-tls
```

### Functions

`esp_err_t esp_tls_cfg_server_session_tickets_init (esp_tls_cfg_server_t *cfg)`

Initialize the server side TLS session ticket context.

This function initializes the server side tls session ticket context which holds all necessary data structures to enable tls session tickets according to RFC5077. Use `esp_tls_cfg_server_session_tickets_free` to free the data.

**参数** `cfg` -- [in] server configuration as `esp_tls_cfg_server_t`

**返回** `ESP_OK` if setup succeeded `ESP_ERR_INVALID_ARG` if context is already initialized  
`ESP_ERR_NO_MEM` if memory allocation failed `ESP_ERR_NOT_SUPPORTED` if session tickets are not available due to build configuration `ESP_FAIL` if setup failed

void `esp_tls_cfg_server_session_tickets_free (esp_tls_cfg_server_t *cfg)`

Free the server side TLS session ticket context.

**参数** `cfg` -- server configuration as `esp_tls_cfg_server_t`

`esp_tls_t *esp_tls_init (void)`

Create TLS connection.

This function allocates and initializes esp-tls structure handle.

**返回** tls Pointer to esp-tls as esp-tls handle if successfully initialized, NULL if allocation error

*esp\_tls\_t* \***esp\_tls\_conn\_http\_new** (const char \*url, const *esp\_tls\_cfg\_t* \*cfg)

Create a new blocking TLS/SSL connection with a given "HTTP" url.

Note: This API is present for backward compatibility reasons. Alternative function with the same functionality is *esp\_tls\_conn\_http\_new\_sync* (and its asynchronous version *esp\_tls\_conn\_http\_new\_async*)

#### 参数

- **url** -- **[in]** url of host.
- **cfg** -- **[in]** TLS configuration as *esp\_tls\_cfg\_t*. If you wish to open non-TLS connection, keep this NULL. For TLS connection, a pass pointer to 'esp\_tls\_cfg\_t'. At a minimum, this structure should be zero-initialized.

返回 pointer to *esp\_tls\_t*, or NULL if connection couldn't be opened.

int **esp\_tls\_conn\_new\_sync** (const char \*hostname, int hostlen, int port, const *esp\_tls\_cfg\_t* \*cfg, *esp\_tls\_t* \*tls)

Create a new blocking TLS/SSL connection.

This function establishes a TLS/SSL connection with the specified host in blocking manner.

#### 参数

- **hostname** -- **[in]** Hostname of the host.
- **hostlen** -- **[in]** Length of hostname.
- **port** -- **[in]** Port number of the host.
- **cfg** -- **[in]** TLS configuration as *esp\_tls\_cfg\_t*. If you wish to open non-TLS connection, keep this NULL. For TLS connection, a pass pointer to *esp\_tls\_cfg\_t*. At a minimum, this structure should be zero-initialized.
- **tls** -- **[in]** Pointer to esp-tls as esp-tls handle.

#### 返回

- -1 If connection establishment fails.
- 1 If connection establishment is successful.
- 0 If connection state is in progress.

int **esp\_tls\_conn\_http\_new\_sync** (const char \*url, const *esp\_tls\_cfg\_t* \*cfg, *esp\_tls\_t* \*tls)

Create a new blocking TLS/SSL connection with a given "HTTP" url.

The behaviour is same as *esp\_tls\_conn\_new\_sync*() API. However this API accepts host's url.

#### 参数

- **url** -- **[in]** url of host.
- **cfg** -- **[in]** TLS configuration as *esp\_tls\_cfg\_t*. If you wish to open non-TLS connection, keep this NULL. For TLS connection, a pass pointer to 'esp\_tls\_cfg\_t'. At a minimum, this structure should be zero-initialized.
- **tls** -- **[in]** Pointer to esp-tls as esp-tls handle.

#### 返回

- -1 If connection establishment fails.
- 1 If connection establishment is successful.
- 0 If connection state is in progress.

int **esp\_tls\_conn\_new\_async** (const char \*hostname, int hostlen, int port, const *esp\_tls\_cfg\_t* \*cfg, *esp\_tls\_t* \*tls)

Create a new non-blocking TLS/SSL connection.

This function initiates a non-blocking TLS/SSL connection with the specified host, but due to its non-blocking nature, it doesn't wait for the connection to get established.

#### 参数

- **hostname** -- **[in]** Hostname of the host.
- **hostlen** -- **[in]** Length of hostname.
- **port** -- **[in]** Port number of the host.
- **cfg** -- **[in]** TLS configuration as *esp\_tls\_cfg\_t*. *non\_block* member of this structure should be set to be true.
- **tls** -- **[in]** pointer to esp-tls as esp-tls handle.



**返回**

- -1 If connection establishment fails.
- 0 If connection establishment is in progress.
- 1 If connection establishment is successful.

int **esp\_tls\_conn\_http\_new\_async** (const char \*url, const *esp\_tls\_cfg\_t* \*cfg, *esp\_tls\_t* \*tls)

Create a new non-blocking TLS/SSL connection with a given "HTTP" url.

The behaviour is same as esp\_tls\_conn\_new\_async() API. However this API accepts host's url.

**参数**

- **url** -- **[in]** url of host.
- **cfg** -- **[in]** TLS configuration as esp\_tls\_cfg\_t.
- **tls** -- **[in]** pointer to esp-tls as esp-tls handle.

**返回**

- -1 If connection establishment fails.
- 0 If connection establishment is in progress.
- 1 If connection establishment is successful.

ssize\_t **esp\_tls\_conn\_write** (*esp\_tls\_t* \*tls, const void \*data, size\_t datalen)

Write from buffer 'data' into specified tls connection.

**参数**

- **tls** -- **[in]** pointer to esp-tls as esp-tls handle.
- **data** -- **[in]** Buffer from which data will be written.
- **datalen** -- **[in]** Length of data buffer.

**返回**

- $\geq 0$  if write operation was successful, the return value is the number of bytes actually written to the TLS/SSL connection.
- $< 0$  if write operation was not successful, because either an error occurred or an action must be taken by the calling process.
- ESP\_TLS\_ERR\_SSL\_WANT\_READ/ ESP\_TLS\_ERR\_SSL\_WANT\_WRITE. if the handshake is incomplete and waiting for data to be available for reading. In this case this functions needs to be called again when the underlying transport is ready for operation.

ssize\_t **esp\_tls\_conn\_read** (*esp\_tls\_t* \*tls, void \*data, size\_t datalen)

Read from specified tls connection into the buffer 'data'.

**参数**

- **tls** -- **[in]** pointer to esp-tls as esp-tls handle.
- **data** -- **[in]** Buffer to hold read data.
- **datalen** -- **[in]** Length of data buffer.

**返回**

- $> 0$  if read operation was successful, the return value is the number of bytes actually read from the TLS/SSL connection.
- 0 if read operation was not successful. The underlying connection was closed.
- $< 0$  if read operation was not successful, because either an error occurred or an action must be taken by the calling process.

int **esp\_tls\_conn\_destroy** (*esp\_tls\_t* \*tls)

Close the TLS/SSL connection and free any allocated resources.

This function should be called to close each tls connection opened with esp\_tls\_conn\_new\_sync() (or esp\_tls\_conn\_http\_new\_sync()) and esp\_tls\_conn\_new\_async() (or esp\_tls\_conn\_http\_new\_async()) APIs.

**参数** **tls** -- **[in]** pointer to esp-tls as esp-tls handle.

**返回** - 0 on success

- -1 if socket error or an invalid argument

ssize\_t **esp\_tls\_get\_bytes\_avail** (*esp\_tls\_t* \*tls)

Return the number of application data bytes remaining to be read from the current record.

This API is a wrapper over mbedtls's mbedtls\_ssl\_get\_bytes\_avail() API.



参数 **tls** -- **[in]** pointer to esp-tls as esp-tls handle.

返回

- -1 in case of invalid arg
- bytes available in the application data record read buffer

*esp\_err\_t* **esp\_tls\_get\_conn\_sockfd** (*esp\_tls\_t* \*tls, int \*sockfd)

Returns the connection socket file descriptor from esp\_tls session.

参数

- **tls** -- **[in]** handle to esp\_tls context
- **sockfd** -- **[out]** int pointer to sockfd value.

返回 - ESP\_OK on success and value of sockfd will be updated with socket file descriptor for connection

- ESP\_ERR\_INVALID\_ARG if (tls == NULL || sockfd == NULL)

*esp\_err\_t* **esp\_tls\_set\_conn\_sockfd** (*esp\_tls\_t* \*tls, int sockfd)

Sets the connection socket file descriptor for the esp\_tls session.

参数

- **tls** -- **[in]** handle to esp\_tls context
- **sockfd** -- **[in]** sockfd value to set.

返回 - ESP\_OK on success and value of sockfd for the tls connection shall updated with the provided value

- ESP\_ERR\_INVALID\_ARG if (tls == NULL || sockfd < 0)

*esp\_err\_t* **esp\_tls\_get\_conn\_state** (*esp\_tls\_t* \*tls, *esp\_tls\_conn\_state\_t* \*conn\_state)

Gets the connection state for the esp\_tls session.

参数

- **tls** -- **[in]** handle to esp\_tls context
- **conn\_state** -- **[out]** pointer to the connection state value.

返回 - ESP\_OK on success and value of sockfd for the tls connection shall updated with the provided value

- ESP\_ERR\_INVALID\_ARG (Invalid arguments)

*esp\_err\_t* **esp\_tls\_set\_conn\_state** (*esp\_tls\_t* \*tls, *esp\_tls\_conn\_state\_t* conn\_state)

Sets the connection state for the esp\_tls session.

参数

- **tls** -- **[in]** handle to esp\_tls context
- **conn\_state** -- **[in]** connection state value to set.

返回 - ESP\_OK on success and value of sockfd for the tls connection shall updated with the provided value

- ESP\_ERR\_INVALID\_ARG (Invalid arguments)

void \***esp\_tls\_get\_ssl\_context** (*esp\_tls\_t* \*tls)

Returns the ssl context.

参数 **tls** -- **[in]** handle to esp\_tls context

返回 - ssl\_ctx pointer to ssl context of underlying TLS layer on success

- NULL in case of error

*esp\_err\_t* **esp\_tls\_init\_global\_ca\_store** (void)

Create a global CA store, initially empty.

This function should be called if the application wants to use the same CA store for multiple connections. This function initialises the global CA store which can be then set by calling `esp_tls_set_global_ca_store()`. To be effective, this function must be called before any call to `esp_tls_set_global_ca_store()`.

返回

- ESP\_OK if creating global CA store was successful.
- ESP\_ERR\_NO\_MEM if an error occurred when allocating the mbedTLS resources.

*esp\_err\_t* **esp\_tls\_set\_global\_ca\_store** (const unsigned char \*cacert\_pem\_buf, const unsigned int cacert\_pem\_bytes)

Set the global CA store with the buffer provided in pem format.

This function should be called if the application wants to set the global CA store for multiple connections i.e. to add the certificates in the provided buffer to the certificate chain. This function implicitly calls `esp_tls_init_global_ca_store()` if it has not already been called. The application must call this function before calling `esp_tls_conn_new()`.

#### 参数

- **cacert\_pem\_buf** -- [in] Buffer which has certificates in pem format. This buffer is used for creating a global CA store, which can be used by other tls connections.
- **cacert\_pem\_bytes** -- [in] Length of the buffer.

#### 返回

- ESP\_OK if adding certificates was successful.
- Other if an error occurred or an action must be taken by the calling process.

void **esp\_tls\_free\_global\_ca\_store** (void)

Free the global CA store currently being used.

The memory being used by the global CA store to store all the parsed certificates is freed up. The application can call this API if it no longer needs the global CA store.

*esp\_err\_t* **esp\_tls\_get\_and\_clear\_last\_error** (*esp\_tls\_error\_handle\_t* h, int \*esp\_tls\_code, int \*esp\_tls\_flags)

Returns last error in esp\_tls with detailed mbedtls related error codes. The error information is cleared internally upon return.

#### 参数

- **h** -- [in] esp-tls error handle.
- **esp\_tls\_code** -- [out] last error code returned from mbedtls api (set to zero if none) This pointer could be NULL if caller does not care about esp\_tls\_code
- **esp\_tls\_flags** -- [out] last certification verification flags (set to zero if none) This pointer could be NULL if caller does not care about esp\_tls\_code

#### 返回

- ESP\_ERR\_INVALID\_STATE if invalid parameters
- ESP\_OK (0) if no error occurred
- specific error code (based on ESP\_ERR\_ESP\_TLS\_BASE) otherwise

*esp\_err\_t* **esp\_tls\_get\_and\_clear\_error\_type** (*esp\_tls\_error\_handle\_t* h, *esp\_tls\_error\_type\_t* err\_type, int \*error\_code)

Returns the last error captured in esp\_tls of a specific type The error information is cleared internally upon return.

#### 参数

- **h** -- [in] esp-tls error handle.
- **err\_type** -- [in] specific error type
- **error\_code** -- [out] last error code returned from mbedtls api (set to zero if none) This pointer could be NULL if caller does not care about esp\_tls\_code

#### 返回

- ESP\_ERR\_INVALID\_STATE if invalid parameters
- ESP\_OK if a valid error returned and was cleared

*esp\_err\_t* **esp\_tls\_get\_error\_handle** (*esp\_tls\_t* \*tls, *esp\_tls\_error\_handle\_t* \*error\_handle)

Returns the ESP-TLS error\_handle.

#### 参数

- **tls** -- [in] handle to esp\_tls context
- **error\_handle** -- [out] pointer to the error handle.

#### 返回

- ESP\_OK on success and error\_handle will be updated with the ESP-TLS error handle.
- ESP\_ERR\_INVALID\_ARG if (tls == NULL || error\_handle == NULL)

`mbedtls_x509_crt *esp_tls_get_global_ca_store` (void)

Get the pointer to the global CA store currently being used.

The application must first call `esp_tls_set_global_ca_store()`. Then the same CA store could be used by the application for APIs other than `esp_tls`.

---

**备注:** Modifying the pointer might cause a failure in verifying the certificates.

---

#### 返回

- Pointer to the global CA store currently being used if successful.
- NULL if there is no global CA store set.

`const int *esp_tls_get_ciphersuites_list` (void)

Get supported TLS ciphersuites list.

See <https://www.iana.org/assignments/tls-parameters/tls-parameters.xhtml#tls-parameters-4> for the list of ciphersuites

**返回** Pointer to a zero-terminated array of IANA identifiers of TLS ciphersuites.

`int esp_tls_server_session_create` (*esp\_tls\_cfg\_server\_t* \*cfg, int sockfd, *esp\_tls\_t* \*tls)

Create TLS/SSL server session.

This function creates a TLS/SSL server context for already accepted client connection and performs TLS/SSL handshake with the client

#### 参数

- **cfg** -- **[in]** Pointer to `esp_tls_cfg_server_t`
- **sockfd** -- **[in]** FD of accepted connection
- **tls** -- **[out]** Pointer to allocated `esp_tls_t`

#### 返回

- 0 if successful
- <0 in case of error

`void esp_tls_server_session_delete` (*esp\_tls\_t* \*tls)

Close the server side TLS/SSL connection and free any allocated resources.

This function should be called to close each `tls` connection opened with `esp_tls_server_session_create()`

**参数** **tls** -- **[in]** pointer to `esp_tls_t`

`esp_err_t esp_tls_plain_tcp_connect` (const char \*host, int hostlen, int port, const *esp\_tls\_cfg\_t* \*cfg, *esp\_tls\_error\_handle\_t* error\_handle, int \*sockfd)

Creates a plain TCP connection, returning a valid socket fd on success or an error handle.

#### 参数

- **host** -- **[in]** Hostname of the host.
- **hostlen** -- **[in]** Length of hostname.
- **port** -- **[in]** Port number of the host.
- **cfg** -- **[in]** ESP-TLS configuration as `esp_tls_cfg_t`.
- **error\_handle** -- **[out]** ESP-TLS error handle holding potential errors occurred during connection
- **sockfd** -- **[out]** Socket descriptor if successfully connected on TCP layer

**返回** ESP\_OK on success ESP\_ERR\_INVALID\_ARG if invalid output parameters ESP-TLS based error codes on failure

## Structures

struct **psk\_key\_hint**

ESP-TLS preshared key and hint structure.

### Public Members

const uint8\_t \***key**  
key in PSK authentication mode in binary format

const size\_t **key\_size**  
length of the key

const char \***hint**  
hint in PSK authentication mode in string format

struct **tls\_keep\_alive\_cfg**  
esp-tls client session ticket ctx  
Keep alive parameters structure

### Public Members

bool **keep\_alive\_enable**  
Enable keep-alive timeout

int **keep\_alive\_idle**  
Keep-alive idle time (second)

int **keep\_alive\_interval**  
Keep-alive interval time (second)

int **keep\_alive\_count**  
Keep-alive packet retry send count

struct **esp\_tls\_cfg**  
ESP-TLS configuration parameters.

---

**备注:** Note about format of certificates:

- This structure includes certificates of a Certificate Authority, of client or server as well as private keys, which may be of PEM or DER format. In case of PEM format, the buffer must be NULL terminated (with NULL character included in certificate size).
  - Certificate Authority's certificate may be a chain of certificates in case of PEM format, but could be only one certificate in case of DER format
  - Variables names of certificates and private key buffers and sizes are defined as unions providing backward compatibility for legacy \*\_pem\_buf and \*\_pem\_bytes names which suggested only PEM format was supported. It is encouraged to use generic names such as cacert\_buf and cacert\_bytes.
- 

### Public Members

const char \*\***alpn\_protos**  
Application protocols required for HTTP2. If HTTP2/ALPN support is required, a list of protocols that should be negotiated. The format is length followed by protocol name. For the most common cases the following is ok: const char \*\*alpn\_protos = { "h2", NULL };

- where 'h2' is the protocol name

const unsigned char \***cacert\_buf**

Certificate Authority's certificate in a buffer. Format may be PEM or DER, depending on mbedtls-support  
This buffer should be NULL terminated in case of PEM

const unsigned char \***cacert\_pem\_buf**

CA certificate buffer legacy name

unsigned int **cacert\_bytes**

Size of Certificate Authority certificate pointed to by cacert\_buf (including NULL-terminator in case of PEM format)

unsigned int **cacert\_pem\_bytes**

Size of Certificate Authority certificate legacy name

const unsigned char \***clientcert\_buf**

Client certificate in a buffer Format may be PEM or DER, depending on mbedtls-support This buffer should be NULL terminated in case of PEM

const unsigned char \***clientcert\_pem\_buf**

Client certificate legacy name

unsigned int **clientcert\_bytes**

Size of client certificate pointed to by clientcert\_pem\_buf (including NULL-terminator in case of PEM format)

unsigned int **clientcert\_pem\_bytes**

Size of client certificate legacy name

const unsigned char \***clientkey\_buf**

Client key in a buffer Format may be PEM or DER, depending on mbedtls-support This buffer should be NULL terminated in case of PEM

const unsigned char \***clientkey\_pem\_buf**

Client key legacy name

unsigned int **clientkey\_bytes**

Size of client key pointed to by clientkey\_pem\_buf (including NULL-terminator in case of PEM format)

unsigned int **clientkey\_pem\_bytes**

Size of client key legacy name

const unsigned char \***clientkey\_password**

Client key decryption password string

unsigned int **clientkey\_password\_len**

String length of the password pointed to by clientkey\_password

bool **use\_ecdsa\_peripheral**

Use the ECDSA peripheral for the private key operations

uint8\_t **ecdsa\_key\_efuse\_blk**

The efuse block where the ECDSA key is stored

bool **non\_block**

Configure non-blocking mode. If set to true the underneath socket will be configured in non blocking mode after tls session is established

bool **use\_secure\_element**

Enable this option to use secure element or atec608a chip

int **timeout\_ms**

Network timeout in milliseconds. Note: If this value is not set, by default the timeout is set to 10 seconds. If you wish that the session should wait indefinitely then please use a larger value e.g., INT32\_MAX

bool **use\_global\_ca\_store**

Use a global ca\_store for all the connections in which this bool is set.

const char \***common\_name**

If non-NULL, server certificate CN must match this name. If NULL, server certificate CN must match hostname.

bool **skip\_common\_name**

Skip any validation of server certificate CN field

*tls\_keep\_alive\_cfg\_t* \***keep\_alive\_cfg**

Enable TCP keep-alive timeout for SSL connection

const *psk\_hint\_key\_t* \***psk\_hint\_key**

Pointer to PSK hint and key. if not NULL (and certificates are NULL) then PSK authentication is enabled with configured setup. Important note: the pointer must be valid for connection

*esp\_err\_t* (\***crt\_bundle\_attach**)(void \*conf)

Function pointer to esp\_cert\_bundle\_attach. Enables the use of certification bundle for server verification, must be enabled in menuconfig

void \***ds\_data**

Pointer for digital signature peripheral context

bool **is\_plain\_tcp**

Use non-TLS connection: When set to true, the esp-tls uses plain TCP transport rather than TLS/SSL connection. Note, that it is possible to connect using a plain tcp transport directly with esp\_tls\_plain\_tcp\_connect() API

struct ifreq \***if\_name**

The name of interface for data to go through. Use the default interface without setting

*esp\_tls\_addr\_family\_t* **addr\_family**

The address family to use when connecting to a host.

const int \***ciphersuites\_list**

Pointer to a zero-terminated array of IANA identifiers of TLS ciphersuites. Please check the list validity by `esp_tls_get_ciphersuites_list()` API

*esp\_tls\_proto\_ver\_t* **tls\_version**

TLS protocol version of the connection, e.g., TLS 1.2, TLS 1.3 (default - no preference)

struct **esp\_tls\_cfg\_server**

ESP-TLS Server configuration parameters.

### Public Members

const char \*\***alpn\_protos**

Application protocols required for HTTP2. If HTTP2/ALPN support is required, a list of protocols that should be negotiated. The format is length followed by protocol name. For the most common cases the following is ok: `const char **alpn_protos = { "h2", NULL };`

- where 'h2' is the protocol name

const unsigned char \***cacert\_buf**

Client CA certificate in a buffer. This buffer should be NULL terminated

const unsigned char \***cacert\_pem\_buf**

Client CA certificate legacy name

unsigned int **cacert\_bytes**

Size of client CA certificate pointed to by `cacert_pem_buf`

unsigned int **cacert\_pem\_bytes**

Size of client CA certificate legacy name

const unsigned char \***servercert\_buf**

Server certificate in a buffer This buffer should be NULL terminated

const unsigned char \***servercert\_pem\_buf**

Server certificate legacy name

unsigned int **servercert\_bytes**

Size of server certificate pointed to by `servercert_pem_buf`

unsigned int **servercert\_pem\_bytes**

Size of server certificate legacy name

const unsigned char \***serverkey\_buf**

Server key in a buffer This buffer should be NULL terminated

const unsigned char \***serverkey\_pem\_buf**  
Server key legacy name

unsigned int **serverkey\_bytes**  
Size of server key pointed to by serverkey\_pem\_buf

unsigned int **serverkey\_pem\_bytes**  
Size of server key legacy name

const unsigned char \***serverkey\_password**  
Server key decryption password string

unsigned int **serverkey\_password\_len**  
String length of the password pointed to by serverkey\_password

bool **use\_ecdsa\_peripheral**  
Use ECDSA peripheral to use private key

uint8\_t **ecdsa\_key\_efuse\_blk**  
The efuse block where ECDSA key is stored

bool **use\_secure\_element**  
Enable this option to use secure element or atec608a chip

void \***userdata**  
User data to be added to the ssl context. Can be retrieved by callbacks

### Type Definitions

typedef enum *esp\_tls\_conn\_state* **esp\_tls\_conn\_state\_t**  
ESP-TLS Connection State.

typedef enum *esp\_tls\_role* **esp\_tls\_role\_t**

typedef struct *psk\_key\_hint* **psk\_hint\_key\_t**  
ESP-TLS preshared key and hint structure.

typedef struct *tls\_keep\_alive\_cfg* **tls\_keep\_alive\_cfg\_t**  
esp-tls client session ticket ctx  
Keep alive parameters structure

typedef enum *esp\_tls\_addr\_family* **esp\_tls\_addr\_family\_t**

typedef struct *esp\_tls\_cfg* **esp\_tls\_cfg\_t**  
ESP-TLS configuration parameters.

---

备注: Note about format of certificates:



- This structure includes certificates of a Certificate Authority, of client or server as well as private keys, which may be of PEM or DER format. In case of PEM format, the buffer must be NULL terminated (with NULL character included in certificate size).
  - Certificate Authority's certificate may be a chain of certificates in case of PEM format, but could be only one certificate in case of DER format
  - Variables names of certificates and private key buffers and sizes are defined as unions providing backward compatibility for legacy \*\_pem\_buf and \*\_pem\_bytes names which suggested only PEM format was supported. It is encouraged to use generic names such as cacert\_buf and cacert\_bytes.
- 

```
typedef void *esp_tls_handshake_callback
```

```
typedef struct esp_tls_cfg_server esp_tls_cfg_server_t
```

ESP-TLS Server configuration parameters.

```
typedef struct esp_tls esp_tls_t
```

### Enumerations

```
enum esp_tls_conn_state
```

ESP-TLS Connection State.

*Values:*

```
enumerator ESP_TLS_INIT
```

```
enumerator ESP_TLS_CONNECTING
```

```
enumerator ESP_TLS_HANDSHAKE
```

```
enumerator ESP_TLS_FAIL
```

```
enumerator ESP_TLS_DONE
```

```
enum esp_tls_role
```

*Values:*

```
enumerator ESP_TLS_CLIENT
```

```
enumerator ESP_TLS_SERVER
```

```
enum esp_tls_addr_family
```

*Values:*

```
enumerator ESP_TLS_AF_UNSPEC
```

Unspecified address family.

```
enumerator ESP_TLS_AF_INET
```

IPv4 address family.

enumerator **ESP\_TLS\_AF\_INET6**

IPv6 address family.

enum **esp\_tls\_proto\_ver\_t**

*Values:*

enumerator **ESP\_TLS\_VER\_ANY**

enumerator **ESP\_TLS\_VER\_TLS\_1\_2**

enumerator **ESP\_TLS\_VER\_TLS\_1\_3**

enumerator **ESP\_TLS\_VER\_TLS\_MAX**

### Header File

- [components/esp-tls/esp\\_tls\\_errors.h](#)
- This header file can be included with:

```
#include "esp_tls_errors.h"
```

- This header file is a part of the API provided by the `esp-tls` component. To declare that your component depends on `esp-tls`, add the following to your `CMakeLists.txt`:

```
REQUIRES esp-tls
```

or

```
PRIV_REQUIRES esp-tls
```

### Structures

struct **esp\_tls\_last\_error**

Error structure containing relevant errors in case tls error occurred.

### Public Members

*esp\_err\_t* **last\_error**

error code (based on `ESP_ERR_ESP_TLS_BASE`) of the last occurred error

int **esp\_tls\_error\_code**

esp\_tls error code from last esp\_tls failed api

int **esp\_tls\_flags**

last certification verification flags

### Macros

**ESP\_ERR\_ESP\_TLS\_BASE**

Starting number of ESP-TLS error codes

**ESP\_ERR\_ESP\_TLS\_CANNOT\_RESOLVE\_HOSTNAME**

Error if hostname couldn't be resolved upon tls connection

**ESP\_ERR\_ESP\_TLS\_CANNOT\_CREATE\_SOCKET**

Failed to create socket

**ESP\_ERR\_ESP\_TLS\_UNSUPPORTED\_PROTOCOL\_FAMILY**

Unsupported protocol family

**ESP\_ERR\_ESP\_TLS\_FAILED\_CONNECT\_TO\_HOST**

Failed to connect to host

**ESP\_ERR\_ESP\_TLS\_SOCKET\_SETOPT\_FAILED**

failed to set/get socket option

**ESP\_ERR\_ESP\_TLS\_CONNECTION\_TIMEOUT**

new connection in esp\_tls\_low\_level\_conn connection timeouted

**ESP\_ERR\_ESP\_TLS\_SE\_FAILED**

**ESP\_ERR\_ESP\_TLS\_TCP\_CLOSED\_FIN**

**ESP\_ERR\_MBEDTLS\_CERT\_PARTLY\_OK**

mbedtls parse certificates was partly successful

**ESP\_ERR\_MBEDTLS\_CTR\_DRBG\_SEED\_FAILED**

mbedtls api returned error

**ESP\_ERR\_MBEDTLS\_SSL\_SET\_HOSTNAME\_FAILED**

mbedtls api returned error

**ESP\_ERR\_MBEDTLS\_SSL\_CONFIG\_DEFAULTS\_FAILED**

mbedtls api returned error

**ESP\_ERR\_MBEDTLS\_SSL\_CONF\_ALPN\_PROTOCOLS\_FAILED**

mbedtls api returned error

**ESP\_ERR\_MBEDTLS\_X509\_CERT\_PARSE\_FAILED**

mbedtls api returned error

**ESP\_ERR\_MBEDTLS\_SSL\_CONF\_OWN\_CERT\_FAILED**

mbedtls api returned error

**ESP\_ERR\_MBEDTLS\_SSL\_SETUP\_FAILED**

mbedtls api returned error

**ESP\_ERR\_MBEDTLS\_SSL\_WRITE\_FAILED**

mbedtls api returned error

**ESP\_ERR\_MBEDTLS\_PK\_PARSE\_KEY\_FAILED**

mbedtls api returned failed

**ESP\_ERR\_MBEDTLS\_SSL\_HANDSHAKE\_FAILED**

mbedtls api returned failed

**ESP\_ERR\_MBEDTLS\_SSL\_CONF\_PSK\_FAILED**

mbedtls api returned failed

**ESP\_ERR\_MBEDTLS\_SSL\_TICKET\_SETUP\_FAILED**

mbedtls api returned failed

**ESP\_ERR\_WOLFSSL\_SSL\_SET\_HOSTNAME\_FAILED**

wolfSSL api returned error

**ESP\_ERR\_WOLFSSL\_SSL\_CONF\_ALPN\_PROTOCOLS\_FAILED**

wolfSSL api returned error

**ESP\_ERR\_WOLFSSL\_CERT\_VERIFY\_SETUP\_FAILED**

wolfSSL api returned error

**ESP\_ERR\_WOLFSSL\_KEY\_VERIFY\_SETUP\_FAILED**

wolfSSL api returned error

**ESP\_ERR\_WOLFSSL\_SSL\_HANDSHAKE\_FAILED**

wolfSSL api returned failed

**ESP\_ERR\_WOLFSSL\_CTX\_SETUP\_FAILED**

wolfSSL api returned failed

**ESP\_ERR\_WOLFSSL\_SSL\_SETUP\_FAILED**

wolfSSL api returned failed

**ESP\_ERR\_WOLFSSL\_SSL\_WRITE\_FAILED**

wolfSSL api returned failed

**ESP\_TLS\_ERR\_SSL\_WANT\_READ**

Definition of errors reported from IO API (potentially non-blocking) in case of error:

- esp\_tls\_conn\_read()
- esp\_tls\_conn\_write()

**ESP\_TLS\_ERR\_SSL\_WANT\_WRITE****ESP\_TLS\_ERR\_SSL\_TIMEOUT****Type Definitions**

```
typedef struct esp_tls_last_error *esp_tls_error_handle_t
```

typedef struct *esp\_tls\_last\_error* **esp\_tls\_last\_error\_t**

Error structure containing relevant errors in case tls error occurred.

### Enumerations

enum **esp\_tls\_error\_type\_t**

Definition of different types/sources of error codes reported from different components

*Values:*

enumerator **ESP\_TLS\_ERR\_TYPE\_UNKNOWN**

enumerator **ESP\_TLS\_ERR\_TYPE\_SYSTEM**

System error –errno

enumerator **ESP\_TLS\_ERR\_TYPE\_MBEDTLS**

Error code from mbedTLS library

enumerator **ESP\_TLS\_ERR\_TYPE\_MBEDTLS\_CERT\_FLAGS**

Certificate flags defined in mbedTLS

enumerator **ESP\_TLS\_ERR\_TYPE\_ESP**

ESP-IDF error type –esp\_err\_t

enumerator **ESP\_TLS\_ERR\_TYPE\_WOLFSSL**

Error code from wolfSSL library

enumerator **ESP\_TLS\_ERR\_TYPE\_WOLFSSL\_CERT\_FLAGS**

Certificate flags defined in wolfSSL

enumerator **ESP\_TLS\_ERR\_TYPE\_MAX**

Last err type –invalid entry

## 2.2.5 ESP HTTP 客户端

### 概述

`esp_http_client` 提供了一组 API，用于从 ESP-IDF 应用程序中发起 HTTP/S 请求，具体的使用步骤如下：

- 首先调用 `esp_http_client_init()`，创建一个 `esp_http_client_handle_t` 实例，即基于给定的 `esp_http_client_config_t` 配置创建 HTTP 客户端句柄。此函数必须第一个被调用。若用户未明确定义参数的配置值，则使用默认值。
- 其次调用 `esp_http_client_perform()`，执行 `esp_http_client` 的所有操作，包括打开连接、交换数据、关闭连接（如需要），同时当前任务完成前阻塞该任务。所有相关的事件（在 `esp_http_client_config_t` 中指定）将通过事件处理程序被调用。
- 最后调用 `esp_http_client_cleanup()` 来关闭连接（如有），并释放所有分配给 HTTP 客户端实例的内存。此函数必须在操作完成后最后一个被调用。

## 应用示例

使用 ESP HTTP 客户端发起 HTTP/S 请求的简单示例，可参考 [protocols/esp\\_http\\_client](#)。

## HTTP 基本请求

如需了解实现细节，请参考应用示例中的 `http_rest_with_url` 和 `http_rest_with_hostname_path` 函数。

## 持久连接

持久连接是 HTTP 客户端在多次交换中重复使用同一连接的方法。如果服务器没有使用 `Connection: close` 头来请求关闭连接，连接就会一直保持开放，用于其他新请求。

为了使 ESP HTTP 客户端充分利用持久连接的优势，建议尽可能多地使用同一个句柄实例来发起请求，可参考应用示例中的函数 `http_rest_with_url` 和 `http_rest_with_hostname_path`。示例中，一旦创建连接，即会在连接关闭前发出多个请求（如 GET、POST、PUT 等）。

## HTTPS 请求

ESP HTTP 客户端支持使用 **mbedTLS** 的 SSL 连接，需将 `url` 配置为以 `https` 开头，或将 `transport_type` 设置为 `HTTP_TRANSPORT_OVER_SSL`。可以通过 `CONFIG_ESP_HTTP_CLIENT_ENABLE_HTTPS` 来配置 HTTPS 支持（默认启用）。

---

**备注：**在发起 HTTPS 请求时，如需服务器验证，首先需要向 `esp_http_client_config_t` 配置中的 `cert_pem` 成员提供额外的根证书（PEM 格式）。用户还可以通过 `esp_http_client_config_t` 配置中的 `crt_bundle_attach` 成员，使用 ESP x509 Certificate Bundle 进行服务器验证。

---

如需了解上文备注中的实现细节，请参考应用示例中的函数 `https_with_url` 和 `https_with_hostname_path`。

## HTTP 流

有些应用程序需要主动打开连接并控制数据交换（数据流）。在这种情况下，应用流程与常规请求不同。请参考以下示例：

- `esp_http_client_init()`：创建一个 HTTP 客户端句柄。
- `esp_http_client_set_*` 或 `esp_http_client_delete_*`：修改 HTTP 连接参数（可选）。
- `esp_http_client_open()`：用 `write_len`（该参数为需要写入服务器的内容长度）打开 HTTP 连接，设置 `write_len=0` 为只读连接。
- `esp_http_client_write()`：向服务器写入数据，最大长度为 `esp_http_client_open()` 函数中的 `write_len` 值；配置 `write_len=0` 无需调用此函数。
- `esp_http_client_fetch_headers()`：在发送完请求头和服务器数据（如有）后，读取 HTTP 服务器的响应头。从服务器返回 `content-length`，并可以由 `esp_http_client_get_status_code()` 继承，以获取连接的 HTTP 状态。
- `esp_http_client_read()`：读取 HTTP 流。
- `esp_http_client_close()`：关闭连接。
- `esp_http_client_cleanup()`：释放分配的资源。

如需了解实现细节，请参考应用示例中的函数 `http_perform_as_stream_reader`。

## HTTP 认证

ESP HTTP 客户端同时支持基本和摘要认证。

- 用户可以在 `url` 或 `esp_http_client_config_t` 配置中的 `username` 和 `password` 处输入用户名和密码。对于 `auth_type = HTTP_AUTH_TYPE_BASIC`，HTTP 客户端只需执行一项操作就可通过认证过程。
- 如果 `auth_type = HTTP_AUTH_TYPE_NONE`，但配置中有 `username` 和 `password` 字段，HTTP 客户端需要执行两项操作。客户端在第一次尝试连接服务器时，会收到 401 Unauthorized 头，而后再根据这些信息来选择认证方法，并在第二项操作中执行。
- 如需了解实现细节，请参考应用示例中的函数 `http_auth_basic`、`http_auth_basic_redirect`（用于基本认证）和 `http_auth_digest`（用于摘要认证）。
- 目前，摘要认证仅支持 MD5 和 SHA-256 算法。

### 认证配置示例

- 基于 URI 的认证

```
esp_http_client_config_t config = {
    .url = "http://user:passwd@httpbin.org/basic-auth/user/passwd",
    .auth_type = HTTP_AUTH_TYPE_BASIC,
};
```

- 基于用户名和密码的认证

```
esp_http_client_config_t config = {
    .url = "http://httpbin.org/basic-auth/user/passwd",
    .username = "user",
    .password = "passwd",
    .auth_type = HTTP_AUTH_TYPE_BASIC,
};
```

### 事件处理

ESP HTTP 客户端支持事件处理，发生相关事件时会触发相应的事件处理程序。`esp_http_client_event_id_t` 中包含了所有使用 ESP HTTP 客户端执行 HTTP 请求时可能发生的事件。

通过 `esp_http_client_config_t::event_handler` 设置回调函数即可启用事件处理功能。

### ESP HTTP 客户端诊断信息

诊断信息可以帮助用户深入了解出现的问题。在 ESP HTTP 客户端中，可以通过在事件循环库中注册事件处理程序来获取诊断信息。此功能的增加基于 ESP Insights 框架，该框架可帮助收集诊断信息。然而，即使不依赖 ESP Insights 框架，也可以获取诊断信息。事件处理程序可通过 `esp_event_handler_register()` 函数注册到事件循环中。

事件循环中不同 HTTP 客户端事件的预期数据类型如下所示：

- `HTTP_EVENT_ERROR`: `esp_http_client_handle_t`
- `HTTP_EVENT_ON_CONNECTED`: `esp_http_client_handle_t`
- `HTTP_EVENT_HEADERS_SENT`: `esp_http_client_handle_t`
- `HTTP_EVENT_ON_HEADER`: `esp_http_client_handle_t`
- `HTTP_EVENT_ON_DATA`: `esp_http_client_on_data_t`
- `HTTP_EVENT_ON_FINISH`: `esp_http_client_handle_t`
- `HTTP_EVENT_DISCONNECTED`: `esp_http_client_handle_t`
- `HTTP_EVENT_REDIRECT`: `esp_http_client_redirect_event_data_t`

在无法接收到 `HTTP_EVENT_DISCONNECTED` 之前，与事件数据一起接收到的 `esp_http_client_handle_t` 将始终有效。这个句柄主要是为了区分不同的客户端连接，无法用于其他目的，因为它可能会随着客户端连接状态的变化而改变。

## TLS 协议版本

可在 `esp_http_client_config_t` 中设置用于底层 TLS 连接的 TLS 协议版本。了解更多信息，请参考 [ESP-TLS](#) 中的 **TLS 协议版本** 章节。

HTTP 客户端的 TLS 协议版本可按如下方式配置：

```
#include "esp_http_client.h"
esp_http_client_config_t config = {
    .tls_version = ESP_HTTP_CLIENT_TLS_VER_TLS_1_2,
};
```

## API 参考

### Header File

- `components/esp_http_client/include/esp_http_client.h`
- This header file can be included with:

```
#include "esp_http_client.h"
```

- This header file is a part of the API provided by the `esp_http_client` component. To declare that your component depends on `esp_http_client`, add the following to your `CMakeLists.txt`:

```
REQUIRES esp_http_client
```

or

```
PRIV_REQUIRES esp_http_client
```

### Functions

**`esp_http_client_handle_t esp_http_client_init`** (const `esp_http_client_config_t` \*config)

Start a HTTP session This function must be the first function to call, and it returns a `esp_http_client_handle_t` that you must use as input to other functions in the interface. This call **MUST** have a corresponding call to `esp_http_client_cleanup` when the operation is complete.

**参数** `config` -- [in] The configurations, see `http_client_config_t`

**返回**

- `esp_http_client_handle_t`
- NULL if any errors

**`esp_err_t esp_http_client_perform`** (`esp_http_client_handle_t` client)

Invoke this function after `esp_http_client_init` and all the options calls are made, and will perform the transfer as described in the options. It must be called with the same `esp_http_client_handle_t` as input as the `esp_http_client_init` call returned. `esp_http_client_perform` performs the entire request in either blocking or non-blocking manner. By default, the API performs request in a blocking manner and returns when done, or if it failed, and in non-blocking manner, it returns if EAGAIN/EWOULDBLOCK or EINPROGRESS is encountered, or if it failed. And in case of non-blocking request, the user may call this API multiple times unless request & response is complete or there is a failure. To enable non-blocking `esp_http_client_perform()`, `is_async` member of `esp_http_client_config_t` must be set while making a call to `esp_http_client_init()` API. You can do any amount of calls to `esp_http_client_perform` while using the same `esp_http_client_handle_t`. The underlying connection may be kept open if the server allows it. If you intend to transfer more than one file, you are even encouraged to do so. `esp_http_client` will then attempt to reuse the same connection for the following transfers, thus making the operations faster, less CPU intense and using less network resources. Just note that you will have to use `esp_http_client_set_*` between the invokes to set options for the following `esp_http_client_perform`.

**备注:** You must never call this function simultaneously from two places using the same client handle. Let the function return first before invoking it another time. If you want parallel transfers,



you must use several `esp_http_client_handle_t`. This function include `esp_http_client_open` -> `esp_http_client_write` -> `esp_http_client_fetch_headers` -> `esp_http_client_read` (and option) `esp_http_client_close`.

---

**参数** `client` -- The `esp_http_client` handle  
**返回**

- ESP\_OK on successful
- ESP\_FAIL on error

*esp\_err\_t* `esp_http_client_cancel_request` (*esp\_http\_client\_handle\_t* client)

Cancel an ongoing HTTP request. This API closes the current socket and opens a new socket with the same `esp_http_client` context.

**参数** `client` -- The `esp_http_client` handle  
**返回**

- ESP\_OK on successful
- ESP\_FAIL on error
- ESP\_ERR\_INVALID\_ARG
- ESP\_ERR\_INVALID\_STATE

*esp\_err\_t* `esp_http_client_set_url` (*esp\_http\_client\_handle\_t* client, const char \*url)

Set URL for client, when performing this behavior, the options in the URL will replace the old ones.

**参数**

- `client` -- [in] The `esp_http_client` handle
- `url` -- [in] The url

**返回**

- ESP\_OK
- ESP\_FAIL

*esp\_err\_t* `esp_http_client_set_post_field` (*esp\_http\_client\_handle\_t* client, const char \*data, int len)

Set post data, this function must be called before `esp_http_client_perform`. Note: The data parameter passed to this function is a pointer and this function will not copy the data.

**参数**

- `client` -- [in] The `esp_http_client` handle
- `data` -- [in] post data pointer
- `len` -- [in] post length

**返回**

- ESP\_OK
- ESP\_FAIL

int `esp_http_client_get_post_field` (*esp\_http\_client\_handle\_t* client, char \*\*data)

Get current post field information.

**参数**

- `client` -- [in] The client
- `data` -- [out] Point to post data pointer

**返回** Size of post data

*esp\_err\_t* `esp_http_client_set_header` (*esp\_http\_client\_handle\_t* client, const char \*key, const char \*value)

Set http request header, this function must be called after `esp_http_client_init` and before any perform function.

**参数**

- `client` -- [in] The `esp_http_client` handle
- `key` -- [in] The header key
- `value` -- [in] The header value

**返回**

- ESP\_OK

- ESP\_FAIL

*esp\_err\_t* **esp\_http\_client\_get\_header** (*esp\_http\_client\_handle\_t* client, const char \*key, char \*\*value)

Get http request header. The value parameter will be set to NULL if there is no header which is same as the key specified, otherwise the address of header value will be assigned to value parameter. This function must be called after `esp_http_client_init`.

#### 参数

- **client** -- [in] The `esp_http_client` handle
- **key** -- [in] The header key
- **value** -- [out] The header value

#### 返回

- ESP\_OK
- ESP\_FAIL

*esp\_err\_t* **esp\_http\_client\_get\_username** (*esp\_http\_client\_handle\_t* client, char \*\*value)

Get http request username. The address of username buffer will be assigned to value parameter. This function must be called after `esp_http_client_init`.

#### 参数

- **client** -- [in] The `esp_http_client` handle
- **value** -- [out] The username value

#### 返回

- ESP\_OK
- ESP\_ERR\_INVALID\_ARG

*esp\_err\_t* **esp\_http\_client\_set\_username** (*esp\_http\_client\_handle\_t* client, const char \*username)

Set http request username. The value of username parameter will be assigned to username buffer. If the username parameter is NULL then username buffer will be freed.

#### 参数

- **client** -- [in] The `esp_http_client` handle
- **username** -- [in] The username value

#### 返回

- ESP\_OK
- ESP\_ERR\_INVALID\_ARG

*esp\_err\_t* **esp\_http\_client\_get\_password** (*esp\_http\_client\_handle\_t* client, char \*\*value)

Get http request password. The address of password buffer will be assigned to value parameter. This function must be called after `esp_http_client_init`.

#### 参数

- **client** -- [in] The `esp_http_client` handle
- **value** -- [out] The password value

#### 返回

- ESP\_OK
- ESP\_ERR\_INVALID\_ARG

*esp\_err\_t* **esp\_http\_client\_set\_password** (*esp\_http\_client\_handle\_t* client, const char \*password)

Set http request password. The value of password parameter will be assigned to password buffer. If the password parameter is NULL then password buffer will be freed.

#### 参数

- **client** -- [in] The `esp_http_client` handle
- **password** -- [in] The password value

#### 返回

- ESP\_OK
- ESP\_ERR\_INVALID\_ARG

*esp\_err\_t* **esp\_http\_client\_set\_auth\_type** (*esp\_http\_client\_handle\_t* client, *esp\_http\_client\_auth\_type\_t* auth\_type)

Set http request auth\_type.

**参数**

- **client** -- **[in]** The esp\_http\_client handle
- **auth\_type** -- **[in]** The esp\_http\_client auth type

**返回**

- ESP\_OK
- ESP\_ERR\_INVALID\_ARG

*esp\_err\_t* **esp\_http\_client\_get\_user\_data** (*esp\_http\_client\_handle\_t* client, void \*\*data)

Get http request user\_data. The value stored from the *esp\_http\_client\_config\_t* will be written to the address passed into data.

**参数**

- **client** -- **[in]** The esp\_http\_client handle
- **data** -- **[out]** A pointer to the pointer that will be set to user\_data.

**返回**

- ESP\_OK
- ESP\_ERR\_INVALID\_ARG

*esp\_err\_t* **esp\_http\_client\_set\_user\_data** (*esp\_http\_client\_handle\_t* client, void \*data)

Set http request user\_data. The value passed in +data+ will be available during event callbacks. No memory management will be performed on the user's behalf.

**参数**

- **client** -- **[in]** The esp\_http\_client handle
- **data** -- **[in]** The pointer to the user data

**返回**

- ESP\_OK
- ESP\_ERR\_INVALID\_ARG

int **esp\_http\_client\_get\_errno** (*esp\_http\_client\_handle\_t* client)

Get HTTP client session errno.

**参数** **client** -- **[in]** The esp\_http\_client handle

**返回**

- (-1) if invalid argument
- errno

*esp\_err\_t* **esp\_http\_client\_set\_method** (*esp\_http\_client\_handle\_t* client, *esp\_http\_client\_method\_t* method)

Set http request method.

**参数**

- **client** -- **[in]** The esp\_http\_client handle
- **method** -- **[in]** The method

**返回**

- ESP\_OK
- ESP\_ERR\_INVALID\_ARG

*esp\_err\_t* **esp\_http\_client\_set\_timeout\_ms** (*esp\_http\_client\_handle\_t* client, int timeout\_ms)

Set http request timeout.

**参数**

- **client** -- **[in]** The esp\_http\_client handle
- **timeout\_ms** -- **[in]** The timeout value

**返回**

- ESP\_OK
- ESP\_ERR\_INVALID\_ARG

*esp\_err\_t* **esp\_http\_client\_delete\_header** (*esp\_http\_client\_handle\_t* client, const char \*key)

Delete http request header.

**参数**

- **client** -- **[in]** The esp\_http\_client handle

- **key** -- **[in]** The key
- 返回

- ESP\_OK
- ESP\_FAIL

*esp\_err\_t* **esp\_http\_client\_open** (*esp\_http\_client\_handle\_t* client, int write\_len)

This function will be open the connection, write all header strings and return.

参数

- **client** -- **[in]** The esp\_http\_client handle
- **write\_len** -- **[in]** HTTP Content length need to write to the server

返回

- ESP\_OK
- ESP\_FAIL

int **esp\_http\_client\_write** (*esp\_http\_client\_handle\_t* client, const char \*buffer, int len)

This function will write data to the HTTP connection previously opened by esp\_http\_client\_open()

参数

- **client** -- **[in]** The esp\_http\_client handle
- **buffer** -- The buffer
- **len** -- **[in]** This value must not be larger than the write\_len parameter provided to esp\_http\_client\_open()

返回

- (-1) if any errors
- Length of data written

int64\_t **esp\_http\_client\_fetch\_headers** (*esp\_http\_client\_handle\_t* client)

This function need to call after esp\_http\_client\_open, it will read from http stream, process all receive headers.

参数 **client** -- **[in]** The esp\_http\_client handle

返回

- (0) if stream doesn't contain content-length header, or chunked encoding (checked by esp\_http\_client\_is\_chunked response)
- (-1: ESP\_FAIL) if any errors
- (-ESP\_ERR\_HTTP\_EAGAIN = -0x7007) if call is timed-out before any data was ready
- Download data length defined by content-length header

bool **esp\_http\_client\_is\_chunked\_response** (*esp\_http\_client\_handle\_t* client)

Check response data is chunked.

参数 **client** -- **[in]** The esp\_http\_client handle

返回 true or false

int **esp\_http\_client\_read** (*esp\_http\_client\_handle\_t* client, char \*buffer, int len)

Read data from http stream.

---

备注: (-ESP\_ERR\_HTTP\_EAGAIN = -0x7007) is returned when call is timed-out before any data was ready

---

参数

- **client** -- **[in]** The esp\_http\_client handle
- **buffer** -- The buffer
- **len** -- **[in]** The length

返回

- (-1) if any errors
- Length of data was read

int **esp\_http\_client\_get\_status\_code** (*esp\_http\_client\_handle\_t* client)

Get http response status code, the valid value if this function invoke after esp\_http\_client\_perform

参数 **client** -- [in] The `esp_http_client` handle  
 返回 Status code

`int64_t esp_http_client_get_content_length(esp_http_client_handle_t client)`

Get http response content length (from header Content-Length) the valid value if this function invoke after `esp_http_client_perform`

参数 **client** -- [in] The `esp_http_client` handle  
 返回

- (-1) Chunked transfer
- Content-Length value as bytes

`esp_err_t esp_http_client_close(esp_http_client_handle_t client)`

Close http connection, still kept all http request resources.

参数 **client** -- [in] The `esp_http_client` handle  
 返回

- ESP\_OK
- ESP\_FAIL

`esp_err_t esp_http_client_cleanup(esp_http_client_handle_t client)`

This function must be the last function to call for an session. It is the opposite of the `esp_http_client_init` function and must be called with the same handle as input that a `esp_http_client_init` call returned. This might close all connections this handle has used and possibly has kept open until now. Don't call this function if you intend to transfer more files, re-using handles is a key to good performance with `esp_http_client`.

参数 **client** -- [in] The `esp_http_client` handle  
 返回

- ESP\_OK
- ESP\_FAIL

`esp_http_client_transport_t esp_http_client_get_transport_type(esp_http_client_handle_t client)`

Get transport type.

参数 **client** -- [in] The `esp_http_client` handle  
 返回

- HTTP\_TRANSPORT\_UNKNOWN
- HTTP\_TRANSPORT\_OVER\_TCP
- HTTP\_TRANSPORT\_OVER\_SSL

`esp_err_t esp_http_client_set_redirection(esp_http_client_handle_t client)`

Set redirection URL. When received the 30x code from the server, the client stores the redirect URL provided by the server. This function will set the current URL to redirect to enable client to execute the redirection request. When `disable_auto_redirect` is set, the client will not call this function but the event `HTTP_EVENT_REDIRECT` will be dispatched giving the user control over the redirection event.

参数 **client** -- [in] The `esp_http_client` handle  
 返回

- ESP\_OK
- ESP\_FAIL

`esp_err_t esp_http_client_reset_redirect_counter(esp_http_client_handle_t client)`

Reset the redirection counter. This is useful to reset redirect counter in cases where the same handle is used for multiple requests.

参数 **client** -- [in] The `esp_http_client` handle  
 返回

- ESP\_OK
- ESP\_ERR\_INVALID\_ARG

`esp_err_t esp_http_client_set_auth_data(esp_http_client_handle_t client, const char *auth_data, int len)`

On receiving a custom authentication header, this API can be invoked to set the authentication information from the header. This API can be called from the event handler.

**参数**

- **client** -- **[in]** The `esp_http_client` handle
- **auth\_data** -- **[in]** The authentication data received in the header
- **len** -- **[in]** length of `auth_data`.

**返回**

- `ESP_ERR_INVALID_ARG`
- `ESP_OK`

void `esp_http_client_add_auth` (*esp\_http\_client\_handle\_t* client)

On receiving HTTP Status code 401, this API can be invoked to add authorization information.

---

**备注:** There is a possibility of receiving body message with redirection status codes, thus make sure to flush off body data after calling this API.

---

**参数** **client** -- **[in]** The `esp_http_client` handle

bool `esp_http_client_is_complete_data_received` (*esp\_http\_client\_handle\_t* client)

Checks if entire data in the response has been read without any error.

**参数** **client** -- **[in]** The `esp_http_client` handle

**返回**

- true
- false

int `esp_http_client_read_response` (*esp\_http\_client\_handle\_t* client, char \*buffer, int len)

Helper API to read larger data chunks This is a helper API which internally calls `esp_http_client_read` multiple times till the end of data is reached or till the buffer gets full.

**参数**

- **client** -- **[in]** The `esp_http_client` handle
- **buffer** -- The buffer
- **len** -- **[in]** The buffer length

**返回**

- Length of data was read

*esp\_err\_t* `esp_http_client_flush_response` (*esp\_http\_client\_handle\_t* client, int \*len)

Process all remaining response data This uses an internal buffer to repeatedly receive, parse, and discard response data until complete data is processed. As no additional user-supplied buffer is required, this may be preferable to `esp_http_client_read_response` in situations where the content of the response may be ignored.

**参数**

- **client** -- **[in]** The `esp_http_client` handle
- **len** -- Length of data discarded

**返回**

- `ESP_OK` If successful, len will have discarded length
- `ESP_FAIL` If failed to read response
- `ESP_ERR_INVALID_ARG` If the client is NULL

*esp\_err\_t* `esp_http_client_get_url` (*esp\_http\_client\_handle\_t* client, char \*url, const int len)

Get URL from client.

**参数**

- **client** -- **[in]** The `esp_http_client` handle
- **url** -- **[inout]** The buffer to store URL
- **len** -- **[in]** The buffer length

**返回**

- ESP\_OK
- ESP\_FAIL

*esp\_err\_t* **esp\_http\_client\_get\_chunk\_length** (*esp\_http\_client\_handle\_t* client, int \*len)

Get Chunk-Length from client.

**参数**

- **client** -- [in] The esp\_http\_client handle
- **len** -- [out] Variable to store length

**返回**

- ESP\_OK If successful, len will have length of current chunk
- ESP\_FAIL If the server is not a chunked server
- ESP\_ERR\_INVALID\_ARG If the client or len are NULL

**Structures**

struct **esp\_http\_client\_event**

HTTP Client events data.

**Public Members**

*esp\_http\_client\_event\_id\_t* **event\_id**

event\_id, to know the cause of the event

*esp\_http\_client\_handle\_t* **client**

esp\_http\_client\_handle\_t context

void \***data**

data of the event

int **data\_len**

data length of data

void \***user\_data**

user\_data context, from *esp\_http\_client\_config\_t* user\_data

char \***header\_key**

For HTTP\_EVENT\_ON\_HEADER event\_id, it's store current http header key

char \***header\_value**

For HTTP\_EVENT\_ON\_HEADER event\_id, it's store current http header value

struct **esp\_http\_client\_on\_data**

Argument structure for HTTP\_EVENT\_ON\_DATA event.

**Public Members**

*esp\_http\_client\_handle\_t* **client**

Client handle

int64\_t **data\_process**

Total data processed

struct **esp\_http\_client\_redirect\_event\_data**

Argument structure for HTTP\_EVENT\_REDIRECT event.

### Public Members

*esp\_http\_client\_handle\_t* **client**

Client handle

int **status\_code**

Status Code

struct **esp\_http\_client\_config\_t**

HTTP configuration.

### Public Members

const char \***url**

HTTP URL, the information on the URL is most important, it overrides the other fields below, if any

const char \***host**

Domain or IP as string

int **port**

Port to connect, default depend on esp\_http\_client\_transport\_t (80 or 443)

const char \***username**

Using for Http authentication

const char \***password**

Using for Http authentication

*esp\_http\_client\_auth\_type\_t* **auth\_type**

Http authentication type, see esp\_http\_client\_auth\_type\_t

const char \***path**

HTTP Path, if not set, default is /

const char \***query**

HTTP query

const char \***cert\_pem**

SSL server certification, PEM format as string, if the client requires to verify server



size\_t **cert\_len**

Length of the buffer pointed to by cert\_pem. May be 0 for null-terminated pem

const char \***client\_cert\_pem**

SSL client certification, PEM format as string, if the server requires to verify client

size\_t **client\_cert\_len**

Length of the buffer pointed to by client\_cert\_pem. May be 0 for null-terminated pem

const char \***client\_key\_pem**

SSL client key, PEM format as string, if the server requires to verify client

size\_t **client\_key\_len**

Length of the buffer pointed to by client\_key\_pem. May be 0 for null-terminated pem

const char \***client\_key\_password**

Client key decryption password string

size\_t **client\_key\_password\_len**

String length of the password pointed to by client\_key\_password

*esp\_http\_client\_proto\_ver\_t* **tls\_version**

TLS protocol version of the connection, e.g., TLS 1.2, TLS 1.3 (default - no preference)

const char \***user\_agent**

The User Agent string to send with HTTP requests

*esp\_http\_client\_method\_t* **method**

HTTP Method

int **timeout\_ms**

Network timeout in milliseconds

bool **disable\_auto\_redirect**

Disable HTTP automatic redirects

int **max\_redirection\_count**

Max number of redirections on receiving HTTP redirect status code, using default value if zero

int **max\_authorization\_retries**

Max connection retries on receiving HTTP unauthorized status code, using default value if zero. Disables authorization retry if -1

*http\_event\_handle\_cb* **event\_handler**

HTTP Event Handle

*esp\_http\_client\_transport\_t* **transport\_type**

HTTP transport type, see esp\_http\_client\_transport\_t

int **buffer\_size**

HTTP receive buffer size

int **buffer\_size\_tx**

HTTP transmit buffer size

void \***user\_data**

HTTP user\_data context

bool **is\_async**

Set asynchronous mode, only supported with HTTPS for now

bool **use\_global\_ca\_store**

Use a global ca\_store for all the connections in which this bool is set.

bool **skip\_cert\_common\_name\_check**

Skip any validation of server certificate CN field

const char \***common\_name**

Pointer to the string containing server certificate common name. If non-NULL, server certificate CN must match this name, If NULL, server certificate CN must match hostname.

*esp\_err\_t* (\***crt\_bundle\_attach**)(void \*conf)

Function pointer to esp\_cert\_bundle\_attach. Enables the use of certification bundle for server verification, must be enabled in menuconfig

bool **keep\_alive\_enable**

Enable keep-alive timeout

int **keep\_alive\_idle**

Keep-alive idle time. Default is 5 (second)

int **keep\_alive\_interval**

Keep-alive interval time. Default is 5 (second)

int **keep\_alive\_count**

Keep-alive packet retry send count. Default is 3 counts

struct ifreq \***if\_name**

The name of interface for data to go through. Use the default interface without setting

void \***ds\_data**

Pointer for digital signature peripheral context, see ESP-TLS Documentation for more details

## Macros

**DEFAULT\_HTTP\_BUF\_SIZE**

**ESP\_ERR\_HTTP\_BASE**

Starting number of HTTP error codes

**ESP\_ERR\_HTTP\_MAX\_REDIRECT**

The error exceeds the number of HTTP redirects

**ESP\_ERR\_HTTP\_CONNECT**

Error open the HTTP connection

**ESP\_ERR\_HTTP\_WRITE\_DATA**

Error write HTTP data

**ESP\_ERR\_HTTP\_FETCH\_HEADER**

Error read HTTP header from server

**ESP\_ERR\_HTTP\_INVALID\_TRANSPORT**

There are no transport support for the input scheme

**ESP\_ERR\_HTTP\_CONNECTING**

HTTP connection hasn't been established yet

**ESP\_ERR\_HTTP\_EAGAIN**

Mapping of errno EAGAIN to esp\_err\_t

**ESP\_ERR\_HTTP\_CONNECTION\_CLOSED**

Read FIN from peer and the connection closed

**Type Definitions**

```
typedef struct esp_http_client *esp_http_client_handle_t
```

```
typedef struct esp_http_client_event *esp_http_client_event_handle_t
```

```
typedef struct esp_http_client_event esp_http_client_event_t
```

HTTP Client events data.

```
typedef struct esp_http_client_on_data esp_http_client_on_data_t
```

Argument structure for HTTP\_EVENT\_ON\_DATA event.

```
typedef struct esp_http_client_redirect_event_data esp_http_client_redirect_event_data_t
```

Argument structure for HTTP\_EVENT\_REDIRECT event.

```
typedef esp_err_t (*http_event_handle_cb)(esp_http_client_event_t *evt)
```

**Enumerations**

```
enum esp_http_client_event_id_t
```

HTTP Client events id.

*Values:*

enumerator **HTTP\_EVENT\_ERROR**

This event occurs when there are any errors during execution

enumerator **HTTP\_EVENT\_ON\_CONNECTED**

Once the HTTP has been connected to the server, no data exchange has been performed

enumerator **HTTP\_EVENT\_HEADERS\_SENT**

After sending all the headers to the server

enumerator **HTTP\_EVENT\_HEADER\_SENT**

This header has been kept for backward compatibility and will be deprecated in future versions esp-idf

enumerator **HTTP\_EVENT\_ON\_HEADER**

Occurs when receiving each header sent from the server

enumerator **HTTP\_EVENT\_ON\_DATA**

Occurs when receiving data from the server, possibly multiple portions of the packet

enumerator **HTTP\_EVENT\_ON\_FINISH**

Occurs when finish a HTTP session

enumerator **HTTP\_EVENT\_DISCONNECTED**

The connection has been disconnected

enumerator **HTTP\_EVENT\_REDIRECT**

Intercepting HTTP redirects to handle them manually

enum **esp\_http\_client\_transport\_t**

HTTP Client transport.

*Values:*

enumerator **HTTP\_TRANSPORT\_UNKNOWN**

Unknown

enumerator **HTTP\_TRANSPORT\_OVER\_TCP**

Transport over tcp

enumerator **HTTP\_TRANSPORT\_OVER\_SSL**

Transport over ssl

enum **esp\_http\_client\_proto\_ver\_t**

*Values:*

enumerator **ESP\_HTTP\_CLIENT\_TLS\_VER\_ANY**

enumerator **ESP\_HTTP\_CLIENT\_TLS\_VER\_TLS\_1\_2**

enumerator **ESP\_HTTP\_CLIENT\_TLS\_VER\_TLS\_1\_3**

enumerator **ESP\_HTTP\_CLIENT\_TLS\_VER\_MAX**

enum **esp\_http\_client\_method\_t**

HTTP method.

*Values:*

enumerator **HTTP\_METHOD\_GET**

HTTP GET Method

enumerator **HTTP\_METHOD\_POST**

HTTP POST Method

enumerator **HTTP\_METHOD\_PUT**

HTTP PUT Method

enumerator **HTTP\_METHOD\_PATCH**

HTTP PATCH Method

enumerator **HTTP\_METHOD\_DELETE**

HTTP DELETE Method

enumerator **HTTP\_METHOD\_HEAD**

HTTP HEAD Method

enumerator **HTTP\_METHOD\_NOTIFY**

HTTP NOTIFY Method

enumerator **HTTP\_METHOD\_SUBSCRIBE**

HTTP SUBSCRIBE Method

enumerator **HTTP\_METHOD\_UNSUBSCRIBE**

HTTP UNSUBSCRIBE Method

enumerator **HTTP\_METHOD\_OPTIONS**

HTTP OPTIONS Method

enumerator **HTTP\_METHOD\_COPY**

HTTP COPY Method

enumerator **HTTP\_METHOD\_MOVE**

HTTP MOVE Method

enumerator **HTTP\_METHOD\_LOCK**

HTTP LOCK Method

enumerator **HTTP\_METHOD\_UNLOCK**

HTTP UNLOCK Method

enumerator **HTTP\_METHOD\_PROPFIND**

HTTP PROPFIND Method

enumerator **HTTP\_METHOD\_PROPPATCH**

HTTP PROPPATCH Method

enumerator **HTTP\_METHOD\_MKCOL**

HTTP MKCOL Method

enumerator **HTTP\_METHOD\_MAX**

enum **esp\_http\_client\_auth\_type\_t**

HTTP Authentication type.

*Values:*

enumerator **HTTP\_AUTH\_TYPE\_NONE**

No authentication

enumerator **HTTP\_AUTH\_TYPE\_BASIC**

HTTP Basic authentication

enumerator **HTTP\_AUTH\_TYPE\_DIGEST**

HTTP Digest authentication

enum **HttpStatus\_Code**

Enum for the HTTP status codes.

*Values:*

enumerator **HttpStatus\_Ok**

enumerator **HttpStatus\_MultipleChoices**

enumerator **HttpStatus\_MovedPermanently**

enumerator **HttpStatus\_Found**

enumerator **HttpStatus\_SeeOther**

enumerator **HttpStatus\_TemporaryRedirect**

enumerator **HttpStatus\_PermanentRedirect**

enumerator **HttpStatus\_BadRequest**

enumerator **HttpStatus\_Unauthorized**

enumerator **HttpStatus\_Forbidden**

enumerator **HttpStatus\_NotFound**

enumerator `HttpStatus_InternalError`

## 2.2.6 ESP 本地控制

### 概述

通过 ESP-IDF 的 ESP 本地控制 (`esp_local_ctrl`) 组件, 可使用 HTTPS 或 BLE 协议控制 ESP 设备。通过一系列可配置的处理程序, 该组件允许你对应用程序定义的读/写 属性进行访问。

通过 BLE 传输协议初始化 `esp_local_ctrl` 的过程如下:

```
esp_local_ctrl_config_t config = {
    .transport = ESP_LOCAL_CTRL_TRANSPORT_BLE,
    .transport_config = {
        .ble = & (protocomm_ble_config_t) {
            .device_name = SERVICE_NAME,
            .service_uuid = {
                /* LSB <----->
                * -----> MSB */
                0x21, 0xd5, 0x3b, 0x8d, 0xbd, 0x75, 0x68, 0x8a,
                0xb4, 0x42, 0xeb, 0x31, 0x4a, 0x1e, 0x98, 0x3d
            }
        }
    },
    .proto_sec = {
        .version = PROTOCOM_SEC0,
        .custom_handle = NULL,
        .sec_params = NULL,
    },
    .handlers = {
        /* User defined handler functions */
        .get_prop_values = get_property_values,
        .set_prop_values = set_property_values,
        .usr_ctx = NULL,
        .usr_ctx_free_fn = NULL
    },
    /* Maximum number of properties that may be set */
    .max_properties = 10
};

/* Start esp_local_ctrl service */
ESP_ERROR_CHECK(esp_local_ctrl_start(&config));
```

同样, 对于 HTTP 传输:

```
/* Set the configuration */
httpd_ssl_config_t https_conf = HTTPD_SSL_CONFIG_DEFAULT();

/* Load server certificate */
extern const unsigned char servercert_start[] asm("_binary_servercert_pem_
↪start");
extern const unsigned char servercert_end[] asm("_binary_servercert_pem_
↪end");
https_conf.servercert = servercert_start;
https_conf.servercert_len = servercert_end - servercert_start;

/* Load server private key */
```

(下页继续)

(续上页)

```

extern const unsigned char prvkey_pem_start[] asm("_binary_prvkey_pem_
↪start");
extern const unsigned char prvkey_pem_end[]   asm("_binary_prvkey_pem_
↪end");
https_conf.prvkey_pem = prvkey_pem_start;
https_conf.prvkey_len = prvkey_pem_end - prvkey_pem_start;

esp_local_ctrl_config_t config = {
    .transport = ESP_LOCAL_CTRL_TRANSPORT_HTTPD,
    .transport_config = {
        .httpd = &https_conf
    },
    .proto_sec = {
        .version = PROTOCOM_SEC0,
        .custom_handle = NULL,
        .sec_params = NULL,
    },
    .handlers = {
        /* User defined handler functions */
        .get_prop_values = get_property_values,
        .set_prop_values = set_property_values,
        .usr_ctx         = NULL,
        .usr_ctx_free_fn = NULL
    },
    /* Maximum number of properties that may be set */
    .max_properties = 10
};

/* Start esp_local_ctrl service */
ESP_ERROR_CHECK(esp_local_ctrl_start(&config));

```

你可以利用以下选项设置 ESP 本地控制的传输安全性：

1. PROTOCOM\_SEC2: 指定使用基于 SRP6a 的密钥交换和基于 AES-GCM 的端到端加密。这一选项通过增强的 PAKE 协议（即 SRP6a）提供了强大的安全保障，是最受欢迎的选项。
2. PROTOCOM\_SEC1: 指定使用基于 Curve25519 的密钥交换和基于 AES-CTR 的端到端加密。
3. PROTOCOM\_SEC0: 指定以明文（无安全性）方式交换数据。
4. PROTOCOM\_SEC\_CUSTOM: 自定义安全需求。注意，使用这一选项时，必须提供 `protocomm_security_t *` 类型的 `custom_handle`。

**备注：**相应的安全方案需通过项目配置菜单启用。要了解详情，请参考 *Protocol Communication* 中关于启用 `protocomm` 安全版本的章节。

## 创建属性

启用 `esp_local_ctrl` 后，可以为它添加属性。每个属性必须具有唯一的名称 `name`（字符串），还需具有类型 `type`（如枚举）、标记 `flags`（位域）和大小 `size`。

如果希望属性值的长度可变（例如，字符串或字节流），则 `size` 值应保持为 0。对于有固定长度属性值的数据类型，如整型、浮点型等，将 `size` 字段设置为正确的值，有助于 `esp_local_ctrl` 对接收到的写入请求的参数进行内部检查。

`type` 和 `flags` 字段的含义取决于具体的应用程序，它们可以是枚举、位域、甚至整型。可以使用 `type` 表示属性，用 `flags` 指定属性的特征。

例如，以下属性被用作时间戳。此处假设应用程序定义了 `TYPE_TIMESTAMP` 和 `READONLY` 来设置此处的 `type` 和 `flags` 字段：



```

/* Create a timestamp property */
esp_local_ctrl_prop_t timestamp = {
    .name      = "timestamp",
    .type      = TYPE_TIMESTAMP,
    .size      = sizeof(int32_t),
    .flags     = READONLY,
    .ctx       = func_get_time,
    .ctx_free_fn = NULL
};

/* Now register the property */
esp_local_ctrl_add_property(&timestamp);

```

另外，此示例中还设置了一个 `ctx` 字段，指向自定义的 `func_get_time()`，用于在属性的 `get/set` 处理程序中检索时间戳。

以下为 `get_prop_values()` 处理程序的一个示例，用于检索时间戳：

```

static esp_err_t get_property_values(size_t props_count,
                                     const esp_local_ctrl_prop_t *props,
                                     esp_local_ctrl_prop_val_t *prop_
→values,
                                     void *usr_ctx)
{
    for (uint32_t i = 0; i < props_count; i++) {
        ESP_LOGI(TAG, "Reading %s", props[i].name);
        if (props[i].type == TYPE_TIMESTAMP) {
            /* Obtain the timer function from ctx */
            int32_t (*func_get_time)(void) = props[i].ctx;

            /* Use static variable for saving the value. This is_
→essential because the value has to be valid even after this function_
→returns. Alternative is to use dynamic allocation and set the free_fn_
→field */
            static int32_t ts = func_get_time();
            prop_values[i].data = &ts;
        }
    }
    return ESP_OK;
}

```

以下为 `set_prop_values()` 应用程序的一个示例，注意此示例是如何为只读属性限制写入操作：

```

static esp_err_t set_property_values(size_t props_count,
                                     const esp_local_ctrl_prop_t *props,
                                     const esp_local_ctrl_prop_val_t_
→*prop_values,
                                     void *usr_ctx)
{
    for (uint32_t i = 0; i < props_count; i++) {
        if (props[i].flags & READONLY) {
            ESP_LOGE(TAG, "Cannot write to read-only property %s",_
→props[i].name);
            return ESP_ERR_INVALID_ARG;
        } else {
            ESP_LOGI(TAG, "Setting %s", props[i].name);

            /* For keeping it simple, lets only log the incoming data */
            ESP_LOG_BUFFER_HEX_LEVEL(TAG, prop_values[i].data,
                                     prop_values[i].size, ESP_LOG_INFO);
        }
    }
}

```

(下页继续)

(续上页)

```

return ESP_OK;
}

```

完整示例请参见 [protocols/esp\\_local\\_ctrl](#)。

## 客户端实现

在客户端的实现过程中，首先，通过支持的传输模式与设备建立 `protocomm` 会话，然后发送并接收 `esp_local_ctrl` 服务能够处理的 `protobuf` 信息。`esp_local_ctrl` 服务会将这些信息转换为请求，并发起相应的处理程序 (`set/get`)。接着，为每个处理程序生成的响应会被再次打包到一条 `protobuf` 信息中，传输回客户端。

以下是 `esp_local_ctrl` 服务能够处理的各种 `protobuf` 信息：

1. `get_prop_count`：返回服务支持的属性总数。
2. `get_prop_values`：接受一个索引数组，并返回这些索引相对应的属性信息（名称、类型、标志）和属性值。
3. `set_prop_values`：接受一个索引数组和一个新值数组，用于设置索引对应的属性值。

注意，在多个会话中，一个属性的索引可能相同，也可能不同。因此，客户端必须用唯一的属性名称来识别属性。每次建立新会话时，客户端都应首先调用 `get_prop_count`，然后调用 `get_prop_values`，为所有属性建立从索引到名称的映射。为一组属性调用 `set_prop_values` 时，必须先用创建的映射将名称转换为索引。如前所述，每次使用同一设备建立新会话时，客户端必须刷新该映射。

下面列出了 `esp_local_ctrl` 服务提供的各种 `protocomm` 端点：

表 1: ESP 本地控制服务提供的端点

端点名称 (BLE + GATT 服 务器)	URI (HTTPS 服务器 + mDNS)	描述
<code>esp_local_ctrl</code>	<code>https://[esp_local_ctrl- hostname]&gt;.local/esp_local_ctrl/version</code>	检索版本字符串
<code>esp_local_ctrl</code>	<code>https://[esp_local_ctrl- hostname]&gt;.local/esp_local_ctrl/control</code>	发送或接收控制信息

## API 参考

### Header File

- [components/esp\\_local\\_ctrl/include/esp\\_local\\_ctrl.h](#)
- This header file can be included with:

```
#include "esp_local_ctrl.h"
```

- This header file is a part of the API provided by the `esp_local_ctrl` component. To declare that your component depends on `esp_local_ctrl`, add the following to your `CMakeLists.txt`:

```
REQUIRES esp_local_ctrl
```

or

```
PRIV_REQUIRES esp_local_ctrl
```

### Functions

const `esp_local_ctrl_transport_t*` `esp_local_ctrl_get_transport_ble` (void)

Function for obtaining BLE transport mode.

const *esp\_local\_ctrl\_transport\_t* \***esp\_local\_ctrl\_get\_transport\_httpd** (void)

Function for obtaining HTTPD transport mode.

*esp\_err\_t* **esp\_local\_ctrl\_start** (const *esp\_local\_ctrl\_config\_t* \*config)

Start local control service.

**参数 config** -- [in] Pointer to configuration structure

**返回**

- ESP\_OK : Success
- ESP\_FAIL : Failure

*esp\_err\_t* **esp\_local\_ctrl\_stop** (void)

Stop local control service.

*esp\_err\_t* **esp\_local\_ctrl\_add\_property** (const *esp\_local\_ctrl\_prop\_t* \*prop)

Add a new property.

This adds a new property and allocates internal resources for it. The total number of properties that could be added is limited by configuration option `max_properties`

**参数 prop** -- [in] Property description structure

**返回**

- ESP\_OK : Success
- ESP\_FAIL : Failure

*esp\_err\_t* **esp\_local\_ctrl\_remove\_property** (const char \*name)

Remove a property.

This finds a property by name, and releases the internal resources which are associated with it.

**参数 name** -- [in] Name of the property to remove

**返回**

- ESP\_OK : Success
- ESP\_ERR\_NOT\_FOUND : Failure

const *esp\_local\_ctrl\_prop\_t* \***esp\_local\_ctrl\_get\_property** (const char \*name)

Get property description structure by name.

This API may be used to get a property's context structure `esp_local_ctrl_prop_t` when its name is known

**参数 name** -- [in] Name of the property to find

**返回**

- Pointer to property
- NULL if not found

*esp\_err\_t* **esp\_local\_ctrl\_set\_handler** (const char \*ep\_name, *protocomm\_req\_handler\_t* handler, void \*user\_ctx)

Register protocomm handler for a custom endpoint.

This API can be called by the application to register a protocomm handler for an endpoint after the local control service has started.

---

**备注:** In case of BLE transport the names and uuids of all custom endpoints must be provided beforehand as a part of the `protocomm_ble_config_t` structure set in `esp_local_ctrl_config_t`, and passed to `esp_local_ctrl_start()`.

---

**参数**

- **ep\_name** -- [in] Name of the endpoint
- **handler** -- [in] Endpoint handler function
- **user\_ctx** -- [in] User data

**返回**

- ESP\_OK : Success
- ESP\_FAIL : Failure

## Unions

union **esp\_local\_ctrl\_transport\_config\_t**

*#include <esp\_local\_ctrl.h>* Transport mode (BLE / HTTPD) configuration.

### Public Members

*esp\_local\_ctrl\_transport\_config\_ble\_t* \*ble

This is same as `protocomm_ble_config_t`. See `protocomm_ble.h` for available configuration parameters.

*esp\_local\_ctrl\_transport\_config\_httpd\_t* \*httpd

This is same as `httpd_ssl_config_t`. See `esp_https_server.h` for available configuration parameters.

## Structures

struct **esp\_local\_ctrl\_prop**

Property description data structure, which is to be populated and passed to the `esp_local_ctrl_add_property()` function.

Once a property is added, its structure is available for read-only access inside `get_prop_values()` and `set_prop_values()` handlers.

### Public Members

char \***name**

Unique name of property

uint32\_t **type**

Type of property. This may be set to application defined enums

size\_t **size**

Size of the property value, which:

- if zero, the property can have values of variable size
- if non-zero, the property can have values of fixed size only, therefore, checks are performed internally by `esp_local_ctrl` when setting the value of such a property

uint32\_t **flags**

Flags set for this property. This could be a bit field. A flag may indicate property behavior, e.g. read-only / constant

void \***ctx**

Pointer to some context data relevant for this property. This will be available for use inside the `get_prop_values` and `set_prop_values` handlers as a part of this property structure. When set, this is valid throughout the lifetime of a property, till either the property is removed or the `esp_local_ctrl` service is stopped.

```
void (*ctx_free_fn)(void *ctx)
```

Function used by `esp_local_ctrl` to internally free the property context when `esp_local_ctrl_remove_property()` or `esp_local_ctrl_stop()` is called.

```
struct esp_local_ctrl_prop_val
```

Property value data structure. This gets passed to the `get_prop_values()` and `set_prop_values()` handlers for the purpose of retrieving or setting the present value of a property.

### Public Members

```
void *data
```

Pointer to memory holding property value

```
size_t size
```

Size of property value

```
void (*free_fn)(void *data)
```

This may be set by the application in `get_prop_values()` handler to tell `esp_local_ctrl` to call this function on the data pointer above, for freeing its resources after sending the `get_prop_values` response.

```
struct esp_local_ctrl_handlers
```

Handlers for receiving and responding to local control commands for getting and setting properties.

### Public Members

```
esp_err_t (*get_prop_values)(size_t props_count, const esp_local_ctrl_prop_t props[],
    esp_local_ctrl_prop_val_t prop_values[], void *usr_ctx)
```

Handler function to be implemented for retrieving current values of properties.

---

**备注:** If any of the properties have fixed sizes, the size field of corresponding element in `prop_values` need to be set

---

**Param props\_count [in]** Total elements in the props array

**Param props [in]** Array of properties, the current values for which have been requested by the client

**Param prop\_values [out]** Array of empty property values, the elements of which need to be populated with the current values of those properties specified by props argument

**Param usr\_ctx [in]** This provides value of the `usr_ctx` field of `esp_local_ctrl_handlers_t` structure

**Return** Returning different error codes will convey the corresponding protocol level errors to the client :

- ESP\_OK : Success
- ESP\_ERR\_INVALID\_ARG : InvalidArgument
- ESP\_ERR\_INVALID\_STATE : InvalidProto
- All other error codes : InternalError

```
esp_err_t (*set_prop_values)(size_t props_count, const esp_local_ctrl_prop_t props[], const
    esp_local_ctrl_prop_val_t prop_values[], void *usr_ctx)
```

Handler function to be implemented for changing values of properties.

---

**备注:** If any of the properties have variable sizes, the size field of the corresponding element in `prop_values` must be checked explicitly before making any assumptions on the size.

---

**Param props\_count [in]** Total elements in the props array

**Param props [in]** Array of properties, the values for which the client requests to change

**Param prop\_values [in]** Array of property values, the elements of which need to be used for updating those properties specified by props argument

**Param usr\_ctx [in]** This provides value of the `usr_ctx` field of `esp_local_ctrl_handlers_t` structure

**Return** Returning different error codes will convey the corresponding protocol level errors to the client :

- ESP\_OK : Success
- ESP\_ERR\_INVALID\_ARG : InvalidArgument
- ESP\_ERR\_INVALID\_STATE : InvalidProto
- All other error codes : InternalError

void \***usr\_ctx**

Context pointer to be passed to above handler functions upon invocation. This is different from the property level context, as this is valid throughout the lifetime of the `esp_local_ctrl` service, and freed only when the service is stopped.

void (\***usr\_ctx\_free\_fn**)(void \*usr\_ctx)

Pointer to function which will be internally invoked on `usr_ctx` for freeing the context resources when `esp_local_ctrl_stop()` is called.

struct **esp\_local\_ctrl\_proto\_sec\_cfg**

Protocom security configs

### Public Members

*esp\_local\_ctrl\_proto\_sec\_t* **version**

This sets protocom security version, sec0/sec1 or custom. If custom, user must provide handle via `proto_sec_custom_handle` below

void \***custom\_handle**

Custom security handle if security is set custom via `proto_sec` above. This handle must follow `protocomm_security_t` signature

const void \***pop**

Proof of possession to be used for local control. Could be NULL.

const void \***sec\_params**

Pointer to security params (NULL if not needed). This is not needed for `protocomm` security 0. This pointer should hold the struct of type `esp_local_ctrl_security1_params_t` for `protocomm` security 1 and `esp_local_ctrl_security2_params_t` for `protocomm` security 2 respectively. Could be NULL.

struct **esp\_local\_ctrl\_config**

Configuration structure to pass to `esp_local_ctrl_start()`

## Public Members

const *esp\_local\_ctrl\_transport\_t* \***ttransport**

Transport layer over which service will be provided

*esp\_local\_ctrl\_transport\_config\_t* **ttransport\_config**

Transport layer over which service will be provided

*esp\_local\_ctrl\_proto\_sec\_cfg\_t* **proto\_sec**

Security version and POP

*esp\_local\_ctrl\_handlers\_t* **handlers**

Register handlers for responding to get/set requests on properties

size\_t **max\_properties**

This limits the number of properties that are available at a time

## Macros

**ESP\_LOCAL\_CTRL\_TRANSPORT\_BLE**

**ESP\_LOCAL\_CTRL\_TRANSPORT\_HTTPD**

## Type Definitions

typedef struct *esp\_local\_ctrl\_prop* **esp\_local\_ctrl\_prop\_t**

Property description data structure, which is to be populated and passed to the `esp_local_ctrl_add_property()` function.

Once a property is added, its structure is available for read-only access inside `get_prop_values()` and `set_prop_values()` handlers.

typedef struct *esp\_local\_ctrl\_prop\_val* **esp\_local\_ctrl\_prop\_val\_t**

Property value data structure. This gets passed to the `get_prop_values()` and `set_prop_values()` handlers for the purpose of retrieving or setting the present value of a property.

typedef struct *esp\_local\_ctrl\_handlers* **esp\_local\_ctrl\_handlers\_t**

Handlers for receiving and responding to local control commands for getting and setting properties.

typedef struct *esp\_local\_ctrl\_transport* **esp\_local\_ctrl\_transport\_t**

Transport mode (BLE / HTTPD) over which the service will be provided.

This is forward declaration of a private structure, implemented internally by `esp_local_ctrl`.

typedef struct *protocomm\_ble\_config* **esp\_local\_ctrl\_transport\_config\_ble\_t**

Configuration for transport mode BLE.

This is a forward declaration for `protocomm_ble_config_t`. To use this, application must set `CONFIG_BT_ENABLED` and include `protocomm_ble.h`.

typedef struct *httpd\_config* **esp\_local\_ctrl\_transport\_config\_httpd\_t**

Configuration for transport mode HTTPD.

This is a forward declaration for `httpd_ssl_config_t` (for HTTPS) or `httpd_config_t` (for HTTP)

```
typedef enum esp_local_ctrl_proto_sec esp_local_ctrl_proto_sec_t
```

Security types for esp\_local\_control.

```
typedef protocomm_security1_params_t esp_local_ctrl_security1_params_t
```

```
typedef protocomm_security2_params_t esp_local_ctrl_security2_params_t
```

```
typedef struct esp_local_ctrl_proto_sec_cfg esp_local_ctrl_proto_sec_cfg_t
```

Protocom security configs

```
typedef struct esp_local_ctrl_config esp_local_ctrl_config_t
```

Configuration structure to pass to esp\_local\_ctrl\_start()

### Enumerations

```
enum esp_local_ctrl_proto_sec
```

Security types for esp\_local\_control.

*Values:*

enumerator **PROTOCOLCOM\_SEC0**

enumerator **PROTOCOLCOM\_SEC1**

enumerator **PROTOCOLCOM\_SEC2**

enumerator **PROTOCOLCOM\_SEC\_CUSTOM**

## 2.2.7 ESP 串行从机链路

### 概述

乐鑫有多款芯片可用作从机的芯片。这些从机依赖于一些通用总线，并在总线上实现了各自的通信协议。esp\_serial\_slave\_link 组件能让主机通过总线驱动和相应的协议与 ESP 从机进行通信。

esp\_serial\_slave\_link 设备初始化完成后，应用程序就能通过它与 ESP 从机方便地通信。

---

**备注:** esp\_serial\_slave\_link 组件自 ESP-IDF 版本 v5.0 起移到了单独的仓库:

- [ESSL component on GitHub](#)

运行 `idf.py add-dependency espressif/esp_serial_slave_link` 将 ESSL 组件添加到你的项目中。

---

### 乐鑫设备协议

如需了解关于乐鑫设备协议详情，请参考以下文档:



## ESP SPI 从机 HD (半双工) 模式协议

## 乐鑫芯片的 SPI 从机功能支持概况

	ESP32	ESP32-S2	ESP32-C3	ESP32-S3	ESP32-C2	ESP32-C6	ESP32-H2	ESP32-P4
SPI 从机 HD	N	Y (v2)	Y (v2)	Y (v2)	Y (v2)	Y (v2)	Y (v2)	Y (v2)
Tohost intr		N	N	N	N	N	N	N
Frhost intr		2 *	2 *	2 *	2 *	2 *	2 *	2 *
TX DMA		Y	Y	Y	Y	Y	Y	Y
RX DMA		Y	Y	Y	Y	Y	Y	Y
共享寄存器		72	64	64	64	64	64	64

**概述** 在半双工模式下，主机须使用从机定义的协议与从机通信。每个传输事务按顺序可能包括以下阶段：

- 命令阶段：8 位，主机到从机  
此阶段决定事务的其它阶段。参见[支持的命令](#)。
- 地址阶段：8 位，主机到从机，可选  
对于某些命令（如 WRBUF、RDBUF），此阶段指定要写入/读取的共享寄存器地址。对于其他包括此阶段的命令，这没有实际意义，但仍必须存在于事务中。
- Dummy 阶段：8 位，浮动，可选  
此阶段是主机和从机在总线上的周转时间，并为从机向主机发送数据提供了充分的准备时间。
- 数据阶段：长度可变，方向由命令确定。  
这一阶段可以输出数据（OUT，方向为由从机向主机），或者输入数据（IN，方向为由主机向从机）。

方向是指哪一方（主机或从机）控制 MOSI、MISO、WP 和 HD 管脚。

**数据 IO 模式** 在某些 IO 模式下，可以使用更多数据线来发送数据。因此，与 1 位模式相比，发送相同数据量所需的 SPI 时钟周期更少。例如，在 QIO 模式下，地址和数据（IN 和 OUT）应发送到全部 4 条数据线上（MOSI、MISO、WP 和 HD）。下表展示了 ESP32-S2 SPI 从机支持的模式，以及相应模式下使用的数据线数量。

Mode	命令线数	地址线数	dummy 线数	数据线数
1-bit	1	1	1	1
DOUT	1	1	4	2
DIO	1	2	4	2
QOUT	1	1	4	4
QIO	1	4	4	4
QPI	4	4	4	4

除 QPI 模式外，使用哪种模式通常取决于主机发送的命令（请参考[支持的命令](#)）。

**QPI 模式** QPI 模式是 SPI 从机的一种特殊状态。主机可发送 ENQPI 命令，使从机进入 QPI 模式。在 QPI 模式下，命令以 4 位形式发送，因此与其他正常模式不兼容。只有在从机处于 QPI 模式时，主机才能发送 QPI 命令。主机可发送 EXQPI 命令退出 QPI 模式。

**支持的命令**

**备注：**命令名称是从主机视角确定的。例如，WRBUF 表示由主机向从机的缓冲区写入。

名称	描述	命令	地址	数据
WRBUF	写入缓冲区	0x01	Buf addr	主到从，不超过缓冲区大小
RDBUF	读取缓冲区	0x02	Buf addr	从到主，不超过缓冲区大小
WRDMA	写入 DMA	0x03	8 位	主到从，不超过从机提供的长度
RDDMA	读取 DMA	0x04	8 位	从到主，不超过从机提供的长度
SEG_DONE	段完成	0x05	•	•
ENQPI	进入 QPI 模式	0x06	•	•
WR_DONE	写入段完成	0x07	•	•
CMD8	中断	0x08	•	•
CMD9	中断	0x09	•	•
CMDA	中断	0x0A	•	•
EXQPI	退出 QPI 模式	0xDD	•	•

此外，WRBUF、RDBUF、WRDMA 和 RDDMA 命令都有 2 位和 4 位版本。要在 2 位或 4 位模式下操作，请用下表中的对应命令掩码与原始命令按位或 (bit OR) 后发送。例如，命令 0xA1 表示 QIO 模式下的 WRBUF。

模式	掩码
1-bit	0x00
DOUT	0x10
DIO	0x50
QOUT	0x20
QIO	0xA0
QPI	0xA0

**段事务模式** 目前，SPI 从机 HD 驱动程序仅支持段事务模式。在此模式下，对于从机加载到 DMA 的事务，主机可以分段读取或写入。这样，主机就无需准备与从机数据大小相同的大缓冲区。主机在一个缓冲区的读取/写入完成后，须向从机发送相应的终止命令作为同步信号。在从机收到终止命令后，从机驱动程序会将新数据（如有）更新到 DMA 上。

WRDMA 的终止命令是 WR\_DONE (0x07)，RDDMA 的终止命令是 CMD8 (0x08)。

以下是主机自从机 DMA 读取数据的流程示例：

1. 从机将 4092 字节数据加载到 RDDMA。
2. 主机进行七次 RDDMA 事务，每个事务长 512 字节，并自从机读取前 3584 字节。
3. 主机进行最后一次 RDDMA 事务，长度为 512 字节（长度可以与从机相同、更长或更短）。前 508 字节是从机发送的有效数据，最后 4 字节无意义。
4. 主机向从机发送 CMD8。
5. 从机将其他的 4092 字节数据加载到 RDDMA。

6. 主机发送 CMD8 后，可以开始新的读取事务。

### 术语解释

- ESSL: ESP 串行从机链路 (ESP Serial Slave Link)，即本文档描述的组件。
- 主机: 运行 `esp_serial_slave_link` 组件的设备。
- ESSL 设备: 主机上的虚拟设备，关联到一个 ESP 从机，其设备上下文中具有如何通过总线驱动和从机的总线协议与其通信的信息。
- ESSL 设备句柄: ESSL 设备上下文的一个句柄，包含配置信息、状态信息和 ESSL 组件所需的数据。设备上下文中储存了驱动配置、通信状态和主从机共享的数据等。
  - 在使用前，应将上下文初始化；如不再使用，应该反初始化。主机应用程序通过这一句柄操作 ESSL 设备。
- ESP 从机: 连接到总线的从机，ESSL 组件的通信对象。
- 总线: 特指用于主机和从机相互通信的总线。
- 从机协议: Espressif 硬件和软件在总线上使用的特殊通信协议。
- TX buffer num: 计数器，位于从机，可由主机读取。指示由从机加载到硬件上、用于接收主机数据的累计 buffer 总数。
- RX data size: 计数器，位于从机，可由主机读取。指示由从机加载到硬件上、需发送给主机的累计数据大小。

### ESP 从机提供的服务

Espressif 从机提供下列服务：

1. Tohost 中断: 从机可通过中断线向主机通知某些事件。(可选)
2. Frhost 中断: 主机可向从机通知某些事件。
3. TX FIFO (主机到从机): 从机能够以接收 buffer 为单位，接收主机发送的数据。从机通过更新 TX buffer num 的方式，将可以接收多少数据的信息通知主机。主机读取 TX buffer num，减去已使用的 buffer 数，得到剩余 buffer 数量。
4. RX FIFO (从机到主机): 从机可向主机发送数据流。SDIO 从机也可通过中断线通知主机，从机有待发送的新数据。从机通过更新 RX data size，将准备发送的数据大小通知主机。主机读取该数据大小，减去已接收的数据长度，得到剩余数据大小。
5. 共享寄存器: 主机可以读取从机寄存器上的部分内容，也可写入从机寄存器供从机读取。

从机提供的服务取决于从机的模型。如需了解详情，请参考乐鑫芯片的 [SPI 从机功能支持概况](#)。

### 初始化 ESP 串行从机链路

**ESP SDIO 从机** ESP SDIO 从机链路 (ESSL SDIO) 设备依赖于 SDMMC 组件。它可通过 SDMMC Host 或 SDSPI Host 功能均可与 ESP SDIO 从机通信。ESSL 设备初始化步骤如下：

1. 初始化 SDMMC 卡 (参考 [SDMMC 驱动相关文档](#)) 结构体。
2. 调用 `sdmmc_card_init()` 初始化该卡。
3. 用 `essl_sdio_config_t` 初始化 ESSL 设备。其中，`card` 成员应为第二步中的 `sdmmc_card_t`，`recv_buffer_size` 成员应填写为预先协商的值。
4. 调用 `essl_init()` 对 SDIO 部分进行初始化。
5. 调用 `essl_wait_for_ready()` 等待从机就绪。

### ESP SPI 从机

**备注:** 如果你正在用 SPI 接口与 ESP SDIO 从机进行通信，则应该用 [SDIO 接口](#) 代替。

暂不支持。

## API

初始化完成后，你可调用以下 API 使用从机提供的服务：

### Tohost 中断（可选）

1. 调用 `essl_get_intr_ena()` 了解哪些事件触发了对主机的中断。
2. 调用 `essl_set_intr_ena()` 设置能够触发主机中断的事件。
3. 调用 `essl_wait_int()` 等待从机中断或超时。
4. 中断触发后，调用 `essl_get_intr()` 了解哪些事件处于活跃状态，并调用 `essl_clear_intr()` 将其清空。

### Erhost 中断

1. 调用 `essl_send_slave_intr()` 触发从机的通用中断。

### TX FIFO

1. 调用 `essl_get_tx_buffer_num()` 了解从机准备用于接收主机数据的 `buffer` 数。你可选择是否调用该函数。主机向从机发送数据包前，也会轮询 `tx_buffer_num`，直到从机的 `buffer` 数量足够或超时。
2. 调用 `essl_send_packet()` 向从机发送数据。

### RX FIFO

1. 调用 `essl_get_rx_data_size()` 了解从机需发送给主机的数据大小。你可选择是否调用该函数。当主机尝试接收数据时，如果目前的 `rx_data_size` 小于主机准备接收数据的 `buffer` 大小，就会对 `rx_data_size` 进行一次更新。如果 `rx_data_size` 一直为 0，主机可能会轮询 `rx_data_size` 直到超时。
2. 调用 `essl_get_packet()` 接收来自从机的数据。

**重置计数器（可选）** 如果从机计数器已重置，调用 `essl_reset_cnt()` 重置内部计数器。

## 应用示例

以下示例展示了 ESP32-H2 SDIO 主机如何与从机互相通信，其中主机使用了 ESSL SDIO：

[peripherals/sdio](#)

如需了解详情，请参考 README.md 中的示例。

## API 参考

### Header File

- [components/driver/test\\_apps/components/esp\\_serial\\_slave\\_link/include/esp\\_serial\\_slave\\_link/essl.h](#)

### Functions

`esp_err_t essl_init(essl_handle_t handle, uint32_t wait_ms)`

Initialize the slave.

#### 参数

- **handle** -- Handle of an ESSL device.
- **wait\_ms** -- Millisecond to wait before timeout, will not wait at all if set to 0-9.

#### 返回

- ESP\_OK: If success

- ESP\_ERR\_NOT\_SUPPORTED: Current device does not support this function.
- Other value returned from lower layer `init`.

`esp_err_t essl_wait_for_ready(essl_handle_t handle, uint32_t wait_ms)`

Wait for interrupt of an ESSL slave device.

#### 参数

- **handle** -- Handle of an ESSL device.
- **wait\_ms** -- Millisecond to wait before timeout, will not wait at all if set to 0-9.

#### 返回

- ESP\_OK: If success
- ESP\_ERR\_NOT\_SUPPORTED: Current device does not support this function.
- One of the error codes from SDMMC host controller

`esp_err_t essl_get_tx_buffer_num(essl_handle_t handle, uint32_t *out_tx_num, uint32_t wait_ms)`

Get buffer num for the host to send data to the slave. The buffers are size of `buffer_size`.

#### 参数

- **handle** -- Handle of a ESSL device.
- **out\_tx\_num** -- Output of buffer num that host can send data to ESSL slave.
- **wait\_ms** -- Millisecond to wait before timeout, will not wait at all if set to 0-9.

#### 返回

- ESP\_OK: Success
- ESP\_ERR\_NOT\_SUPPORTED: This API is not supported in this mode
- One of the error codes from SDMMC/SPI host controller

`esp_err_t essl_get_rx_data_size(essl_handle_t handle, uint32_t *out_rx_size, uint32_t wait_ms)`

Get the size, in bytes, of the data that the ESSL slave is ready to send

#### 参数

- **handle** -- Handle of an ESSL device.
- **out\_rx\_size** -- Output of data size to read from slave, in bytes
- **wait\_ms** -- Millisecond to wait before timeout, will not wait at all if set to 0-9.

#### 返回

- ESP\_OK: Success
- ESP\_ERR\_NOT\_SUPPORTED: This API is not supported in this mode
- One of the error codes from SDMMC/SPI host controller

`esp_err_t essl_reset_cnt(essl_handle_t handle)`

Reset the counters of this component. Usually you don't need to do this unless you know the slave is reset.

参数 **handle** -- Handle of an ESSL device.

#### 返回

- ESP\_OK: Success
- ESP\_ERR\_NOT\_SUPPORTED: This API is not supported in this mode
- ESP\_ERR\_INVALID\_ARG: Invalid argument, handle is not init.

`esp_err_t essl_send_packet(essl_handle_t handle, const void *start, size_t length, uint32_t wait_ms)`

Send a packet to the ESSL Slave. The Slave receives the packet into buffers whose size is `buffer_size` (configured during initialization).

#### 参数

- **handle** -- Handle of an ESSL device.
- **start** -- Start address of the packet to send
- **length** -- Length of data to send, if the packet is over-size, the it will be divided into blocks and hold into different buffers automatically.
- **wait\_ms** -- Millisecond to wait before timeout, will not wait at all if set to 0-9.

#### 返回

- ESP\_OK Success
- ESP\_ERR\_INVALID\_ARG: Invalid argument, handle is not init or other argument is not valid.
- ESP\_ERR\_TIMEOUT: No buffer to use, or error from SDMMC host controller.

- `ESP_ERR_NOT_FOUND`: Slave is not ready for receiving.
- `ESP_ERR_NOT_SUPPORTED`: This API is not supported in this mode
- One of the error codes from SDMMC/SPI host controller.

`esp_err_t` `essl_get_packet` (`essl_handle_t` handle, void \*out\_data, size\_t size, size\_t \*out\_length, uint32\_t wait\_ms)

Get a packet from ESSL slave.

#### 参数

- **handle** -- Handle of an ESSL device.
- **out\_data** -- [out] Data output address
- **size** -- The size of the output buffer, if the buffer is smaller than the size of data to receive from slave, the driver returns `ESP_ERR_NOT_FINISHED`
- **out\_length** -- [out] Output of length the data actually received from slave.
- **wait\_ms** -- Millisecond to wait before timeout, will not wait at all if set to 0-9.

#### 返回

- `ESP_OK` Success: All the data has been read from the slave.
- `ESP_ERR_INVALID_ARG`: Invalid argument, The handle is not initialized or the other arguments are invalid.
- `ESP_ERR_NOT_FINISHED`: Read was successful, but there is still data remaining.
- `ESP_ERR_NOT_FOUND`: Slave is not ready to send data.
- `ESP_ERR_NOT_SUPPORTED`: This API is not supported in this mode
- One of the error codes from SDMMC/SPI host controller.

`esp_err_t` `essl_write_reg` (`essl_handle_t` handle, uint8\_t addr, uint8\_t value, uint8\_t \*value\_o, uint32\_t wait\_ms)

Write general purpose R/W registers (8-bit) of ESSL slave.

---

**备注:** sdio 28-31 are reserved, the lower API helps to skip.

---

#### 参数

- **handle** -- Handle of an ESSL device.
- **addr** -- Address of register to write. For SDIO, valid address: 0-59. For SPI, see `essl_spi.h`
- **value** -- Value to write to the register.
- **value\_o** -- Output of the returned written value.
- **wait\_ms** -- Millisecond to wait before timeout, will not wait at all if set to 0-9.

#### 返回

- `ESP_OK` Success
- One of the error codes from SDMMC/SPI host controller

`esp_err_t` `essl_read_reg` (`essl_handle_t` handle, uint8\_t addr, uint8\_t \*value\_o, uint32\_t wait\_ms)

Read general purpose R/W registers (8-bit) of ESSL slave.

#### 参数

- **handle** -- Handle of a `essl` device.
- **add** -- Address of register to read. For SDIO, Valid address: 0-27, 32-63 (28-31 reserved, return interrupt bits on read). For SPI, see `essl_spi.h`
- **value\_o** -- Output value read from the register.
- **wait\_ms** -- Millisecond to wait before timeout, will not wait at all if set to 0-9.

#### 返回

- `ESP_OK` Success
- One of the error codes from SDMMC/SPI host controller

`esp_err_t` `essl_wait_int` (`essl_handle_t` handle, uint32\_t wait\_ms)

wait for an interrupt of the slave

#### 参数

- **handle** -- Handle of an ESSL device.

- **wait\_ms** -- Millisecond to wait before timeout, will not wait at all if set to 0-9.

**返回**

- ESP\_OK: If interrupt is triggered.
- ESP\_ERR\_NOT\_SUPPORTED: Current device does not support this function.
- ESP\_ERR\_TIMEOUT: No interrupts before timeout.

*esp\_err\_t* **essl\_clear\_intr** (*essl\_handle\_t* handle, uint32\_t intr\_mask, uint32\_t wait\_ms)

Clear interrupt bits of ESSL slave. All the bits set in the mask will be cleared, while other bits will stay the same.

**参数**

- **handle** -- Handle of an ESSL device.
- **intr\_mask** -- Mask of interrupt bits to clear.
- **wait\_ms** -- Millisecond to wait before timeout, will not wait at all if set to 0-9.

**返回**

- ESP\_OK: Success
- ESP\_ERR\_NOT\_SUPPORTED: Current device does not support this function.
- One of the error codes from SDMMC host controller

*esp\_err\_t* **essl\_get\_intr** (*essl\_handle\_t* handle, uint32\_t \*intr\_raw, uint32\_t \*intr\_st, uint32\_t wait\_ms)

Get interrupt bits of ESSL slave.

**参数**

- **handle** -- Handle of an ESSL device.
- **intr\_raw** -- Output of the raw interrupt bits. Set to NULL if only masked bits are read.
- **intr\_st** -- Output of the masked interrupt bits. set to NULL if only raw bits are read.
- **wait\_ms** -- Millisecond to wait before timeout, will not wait at all if set to 0-9.

**返回**

- ESP\_OK: Success
- ESP\_INVALID\_ARG: If both *intr\_raw* and *intr\_st* are NULL.
- ESP\_ERR\_NOT\_SUPPORTED: Current device does not support this function.
- One of the error codes from SDMMC host controller

*esp\_err\_t* **essl\_set\_intr\_ena** (*essl\_handle\_t* handle, uint32\_t ena\_mask, uint32\_t wait\_ms)

Set interrupt enable bits of ESSL slave. The slave only sends interrupt on the line when there is a bit both the raw status and the enable are set.

**参数**

- **handle** -- Handle of an ESSL device.
- **ena\_mask** -- Mask of the interrupt bits to enable.
- **wait\_ms** -- Millisecond to wait before timeout, will not wait at all if set to 0-9.

**返回**

- ESP\_OK: Success
- ESP\_ERR\_NOT\_SUPPORTED: Current device does not support this function.
- One of the error codes from SDMMC host controller

*esp\_err\_t* **essl\_get\_intr\_ena** (*essl\_handle\_t* handle, uint32\_t \*ena\_mask\_o, uint32\_t wait\_ms)

Get interrupt enable bits of ESSL slave.

**参数**

- **handle** -- Handle of an ESSL device.
- **ena\_mask\_o** -- Output of interrupt bit enable mask.
- **wait\_ms** -- Millisecond to wait before timeout, will not wait at all if set to 0-9.

**返回**

- ESP\_OK Success
- One of the error codes from SDMMC host controller

*esp\_err\_t* **essl\_send\_slave\_intr** (*essl\_handle\_t* handle, uint32\_t intr\_mask, uint32\_t wait\_ms)

Send interrupts to slave. Each bit of the interrupt will be triggered.

**参数**

- **handle** -- Handle of an ESSL device.



- **intr\_mask** -- Mask of interrupt bits to send to slave.
- **wait\_ms** -- Millisecond to wait before timeout, will not wait at all if set to 0-9.

**返回**

- ESP\_OK: Success
- ESP\_ERR\_NOT\_SUPPORTED: Current device does not support this function.
- One of the error codes from SDMMC host controller

**Type Definitions**

```
typedef struct essl_dev_t *essl_handle_t
```

Handle of an ESSL device.

**Header File**

- [components/driver/test\\_apps/components/esp\\_serial\\_slave\\_link/include/esp\\_serial\\_slave\\_link/essl\\_sdio.h](#)

**Functions**

```
esp_err_t essl_sdio_init_dev (essl_handle_t *out_handle, const essl_sdio_config_t *config)
```

Initialize the ESSL SDIO device and get its handle.

**参数**

- **out\_handle** -- Output of the handle.
- **config** -- Configuration for the ESSL SDIO device.

**返回**

- ESP\_OK: on success
- ESP\_ERR\_NO\_MEM: memory exhausted.

```
esp_err_t essl_sdio_deinit_dev (essl_handle_t handle)
```

Deinitialize and free the space used by the ESSL SDIO device.

**参数** **handle** -- Handle of the ESSL SDIO device to deinit.

**返回**

- ESP\_OK: on success
- ESP\_ERR\_INVALID\_ARG: wrong handle passed

**Structures**

```
struct essl_sdio_config_t
```

Configuration for the ESSL SDIO device.

**Public Members**

```
sdmmc_card_t *card
```

The initialized sdmmc card pointer of the slave.

```
int recv_buffer_size
```

The pre-negotiated recv buffer size used by both the host and the slave.

**Header File**

- [components/driver/test\\_apps/components/esp\\_serial\\_slave\\_link/include/esp\\_serial\\_slave\\_link/essl\\_spi.h](#)



**Functions**

*esp\_err\_t* **essl\_spi\_init\_dev** (*essl\_handle\_t* \*out\_handle, const *essl\_spi\_config\_t* \*init\_config)

Initialize the ESSL SPI device function list and get its handle.

**参数**

- **out\_handle** -- [out] Output of the handle
- **init\_config** -- Configuration for the ESSL SPI device

**返回**

- ESP\_OK: On success
- ESP\_ERR\_NO\_MEM: Memory exhausted
- ESP\_ERR\_INVALID\_STATE: SPI driver is not initialized
- ESP\_ERR\_INVALID\_ARG: Wrong register ID

*esp\_err\_t* **essl\_spi\_deinit\_dev** (*essl\_handle\_t* handle)

Deinitialize the ESSL SPI device and free the memory used by the device.

**参数** **handle** -- Handle of the ESSL SPI device

**返回**

- ESP\_OK: On success
- ESP\_ERR\_INVALID\_STATE: ESSL SPI is not in use

*esp\_err\_t* **essl\_spi\_read\_reg** (void \*arg, uint8\_t addr, uint8\_t \*out\_value, uint32\_t wait\_ms)

Read from the shared registers.

---

**备注:** The registers for Master/Slave synchronization are reserved. Do not use them. (see `rx_sync_reg` in `essl_spi_config_t`)

---

**参数**

- **arg** -- Context of the component. (Member `arg` from `essl_handle_t`)
- **addr** -- Address of the shared registers. (Valid: 0 ~ SOC\_SPI\_MAXIMUM\_BUFFER\_SIZE, registers for M/S sync are reserved, see note1).
- **out\_value** -- [out] Read buffer for the shared registers.
- **wait\_ms** -- Time to wait before timeout (reserved for future use, user should set this to 0).

**返回**

- ESP\_OK: success
- ESP\_ERR\_INVALID\_STATE: ESSL SPI has not been initialized.
- ESP\_ERR\_INVALID\_ARG: The address argument is not valid. See note 1.
- or other return value from `:cpp:func:spi_device_transmit`.

*esp\_err\_t* **essl\_spi\_get\_packet** (void \*arg, void \*out\_data, size\_t size, uint32\_t wait\_ms)

Get a packet from Slave.

**参数**

- **arg** -- Context of the component. (Member `arg` from `essl_handle_t`)
- **out\_data** -- [out] Output data address
- **size** -- The size of the output data.
- **wait\_ms** -- Time to wait before timeout (reserved for future use, user should set this to 0).

**返回**

- ESP\_OK: On Success
- ESP\_ERR\_INVALID\_STATE: ESSL SPI has not been initialized.
- ESP\_ERR\_INVALID\_ARG: The output data address is neither DMA capable nor 4 byte-aligned
- ESP\_ERR\_INVALID\_SIZE: Master requires `size` bytes of data but Slave did not load enough bytes.

*esp\_err\_t* **essl\_spi\_write\_reg** (void \*arg, uint8\_t addr, uint8\_t value, uint8\_t \*out\_value, uint32\_t wait\_ms)

Write to the shared registers.

---

**备注:** The registers for Master/Slave synchronization are reserved. Do not use them. (see `tx_sync_reg` in `essl_spi_config_t`)

---



---

**备注:** Feature of checking the actual written value (`out_value`) is not supported.

---

#### 参数

- **arg** -- Context of the component. (Member `arg` from `essl_handle_t`)
- **addr** -- Address of the shared registers. (Valid: 0 ~ SOC\_SPI\_MAXIMUM\_BUFFER\_SIZE, registers for M/S sync are reserved, see note1)
- **value** -- Buffer for data to send, should be align to 4.
- **out\_value** -- [out] Not supported, should be set to NULL.
- **wait\_ms** -- Time to wait before timeout (reserved for future use, user should set this to 0).

#### 返回

- ESP\_OK: success
- ESP\_ERR\_INVALID\_STATE: ESSL SPI has not been initialized.
- ESP\_ERR\_INVALID\_ARG: The address argument is not valid. See note 1.
- ESP\_ERR\_NOT\_SUPPORTED: Should set `out_value` to NULL. See note 2.
- or other return value from `:cpp:func:spi_device_transmit`.

*esp\_err\_t* **essl\_spi\_send\_packet** (void \*arg, const void \*data, size\_t size, uint32\_t wait\_ms)

Send a packet to Slave.

#### 参数

- **arg** -- Context of the component. (Member `arg` from `essl_handle_t`)
- **data** -- Address of the data to send
- **size** -- Size of the data to send.
- **wait\_ms** -- Time to wait before timeout (reserved for future use, user should set this to 0).

#### 返回

- ESP\_OK: On success
- ESP\_ERR\_INVALID\_STATE: ESSL SPI has not been initialized.
- ESP\_ERR\_INVALID\_ARG: The data address is not DMA capable
- ESP\_ERR\_INVALID\_SIZE: Master will send `size` bytes of data but Slave did not load enough RX buffer

void **essl\_spi\_reset\_cnt** (void \*arg)

Reset the counter in Master context.

---

**备注:** Shall only be called if the slave has reset its counter. Else, Slave and Master would be desynchronized

---

**参数** **arg** -- Context of the component. (Member `arg` from `essl_handle_t`)

*esp\_err\_t* **essl\_spi\_rdbuf** (*spi\_device\_handle\_t* spi, uint8\_t \*out\_data, int addr, int len, uint32\_t flags)

Read the shared buffer from the slave in ISR way.

---

**备注:** The slave's HW doesn't guarantee the data in one SPI transaction is consistent. It sends data in unit of byte. In other words, if the slave SW attempts to update the shared register when a rdbuf SPI transaction is

---

in-flight, the data got by the master will be the combination of bytes of different writes of slave SW.

---

**备注:** `out_data` should be prepared in words and in the DRAM. The buffer may be written in words by the DMA. When a byte is written, the remaining bytes in the same word will also be overwritten, even the `len` is shorter than a word.

---

#### 参数

- **spi** -- SPI device handle representing the slave
- **out\_data** -- [out] Buffer for read data, strongly suggested to be in the DRAM and aligned to 4
- **addr** -- Address of the slave shared buffer
- **len** -- Length to read
- **flags** -- `SPI_TRANS_*` flags to control the transaction mode of the transaction to send.

#### 返回

- `ESP_OK`: on success
- or other return value from `:cpp:func:spi_device_transmit`.

*esp\_err\_t* `essl_spi_rdbuf_polling` (*spi\_device\_handle\_t* spi, uint8\_t \*out\_data, int addr, int len, uint32\_t flags)

Read the shared buffer from the slave in polling way.

---

**备注:** `out_data` should be prepared in words and in the DRAM. The buffer may be written in words by the DMA. When a byte is written, the remaining bytes in the same word will also be overwritten, even the `len` is shorter than a word.

---

#### 参数

- **spi** -- SPI device handle representing the slave
- **out\_data** -- [out] Buffer for read data, strongly suggested to be in the DRAM and aligned to 4
- **addr** -- Address of the slave shared buffer
- **len** -- Length to read
- **flags** -- `SPI_TRANS_*` flags to control the transaction mode of the transaction to send.

#### 返回

- `ESP_OK`: on success
- or other return value from `:cpp:func:spi_device_transmit`.

*esp\_err\_t* `essl_spi_wrbuf` (*spi\_device\_handle\_t* spi, const uint8\_t \*data, int addr, int len, uint32\_t flags)

Write the shared buffer of the slave in ISR way.

---

**备注:** `out_data` should be prepared in words and in the DRAM. The buffer may be written in words by the DMA. When a byte is written, the remaining bytes in the same word will also be overwritten, even the `len` is shorter than a word.

---

#### 参数

- **spi** -- SPI device handle representing the slave
- **data** -- Buffer for data to send, strongly suggested to be in the DRAM
- **addr** -- Address of the slave shared buffer,
- **len** -- Length to write
- **flags** -- `SPI_TRANS_*` flags to control the transaction mode of the transaction to send.

#### 返回

- `ESP_OK`: success
- or other return value from `:cpp:func:spi_device_transmit`.

*esp\_err\_t* **essl\_spi\_wrbuf\_polling** (*spi\_device\_handle\_t* spi, const uint8\_t \*data, int addr, int len, uint32\_t flags)

Write the shared buffer of the slave in polling way.

---

**备注:** out\_data should be prepared in words and in the DRAM. The buffer may be written in words by the DMA. When a byte is written, the remaining bytes in the same word will also be overwritten, even the len is shorter than a word.

---

#### 参数

- **spi** -- SPI device handle representing the slave
- **data** -- Buffer for data to send, strongly suggested to be in the DRAM
- **addr** -- Address of the slave shared buffer,
- **len** -- Length to write
- **flags** -- SPI\_TRANS\_\* flags to control the transaction mode of the transaction to send.

#### 返回

- ESP\_OK: success
- or other return value from :cpp:func:spi\_device\_polling\_transmit.

*esp\_err\_t* **essl\_spi\_rddma** (*spi\_device\_handle\_t* spi, uint8\_t \*out\_data, int len, int seg\_len, uint32\_t flags)

Receive long buffer in segments from the slave through its DMA.

---

**备注:** This function combines several :cpp:func:essl\_spi\_rddma\_seg and one :cpp:func:essl\_spi\_rddma\_done at the end. Used when the slave is working in segment mode.

---

#### 参数

- **spi** -- SPI device handle representing the slave
- **out\_data** -- [out] Buffer to hold the received data, strongly suggested to be in the DRAM and aligned to 4
- **len** -- Total length of data to receive.
- **seg\_len** -- Length of each segment, which is not larger than the maximum transaction length allowed for the spi device. Suggested to be multiples of 4. When set < 0, means send all data in one segment (the rddma\_done will still be sent.)
- **flags** -- SPI\_TRANS\_\* flags to control the transaction mode of the transaction to send.

#### 返回

- ESP\_OK: success
- or other return value from :cpp:func:spi\_device\_transmit.

*esp\_err\_t* **essl\_spi\_rddma\_seg** (*spi\_device\_handle\_t* spi, uint8\_t \*out\_data, int seg\_len, uint32\_t flags)

Read one data segment from the slave through its DMA.

---

**备注:** To read long buffer, call :cpp:func:essl\_spi\_rddma instead.

---

#### 参数

- **spi** -- SPI device handle representing the slave
- **out\_data** -- [out] Buffer to hold the received data. strongly suggested to be in the DRAM and aligned to 4
- **seg\_len** -- Length of this segment
- **flags** -- SPI\_TRANS\_\* flags to control the transaction mode of the transaction to send.

#### 返回

- ESP\_OK: success
- or other return value from :cpp:func:spi\_device\_transmit.

*esp\_err\_t* **essl\_spi\_rddma\_done** (*spi\_device\_handle\_t* spi, uint32\_t flags)

Send the `rddma_done` command to the slave. Upon receiving this command, the slave will stop sending the current buffer even there are data unsent, and maybe prepare the next buffer to send.

---

**备注:** This is required only when the slave is working in segment mode.

---

#### 参数

- **spi** -- SPI device handle representing the slave
- **flags** -- `SPI_TRANS_*` flags to control the transaction mode of the transaction to send.

#### 返回

- `ESP_OK`: success
- or other return value from `:cpp:func:spi_device_transmit`.

*esp\_err\_t* **essl\_spi\_wrdma** (*spi\_device\_handle\_t* spi, const uint8\_t \*data, int len, int seg\_len, uint32\_t flags)

Send long buffer in segments to the slave through its DMA.

---

**备注:** This function combines several `:cpp:func:essl_spi_wrdma_seg` and one `:cpp:func:essl_spi_wrdma_done` at the end. Used when the slave is working in segment mode.

---

#### 参数

- **spi** -- SPI device handle representing the slave
- **data** -- Buffer for data to send, strongly suggested to be in the DRAM
- **len** -- Total length of data to send.
- **seg\_len** -- Length of each segment, which is not larger than the maximum transaction length allowed for the spi device. Suggested to be multiples of 4. When set < 0, means send all data in one segment (the `wrdma_done` will still be sent.)
- **flags** -- `SPI_TRANS_*` flags to control the transaction mode of the transaction to send.

#### 返回

- `ESP_OK`: success
- or other return value from `:cpp:func:spi_device_transmit`.

*esp\_err\_t* **essl\_spi\_wrdma\_seg** (*spi\_device\_handle\_t* spi, const uint8\_t \*data, int seg\_len, uint32\_t flags)

Send one data segment to the slave through its DMA.

---

**备注:** To send long buffer, call `:cpp:func:essl_spi_wrdma` instead.

---

#### 参数

- **spi** -- SPI device handle representing the slave
- **data** -- Buffer for data to send, strongly suggested to be in the DRAM
- **seg\_len** -- Length of this segment
- **flags** -- `SPI_TRANS_*` flags to control the transaction mode of the transaction to send.

#### 返回

- `ESP_OK`: success
- or other return value from `:cpp:func:spi_device_transmit`.

*esp\_err\_t* **essl\_spi\_wrdma\_done** (*spi\_device\_handle\_t* spi, uint32\_t flags)

Send the `wrdma_done` command to the slave. Upon receiving this command, the slave will stop receiving, process the received data, and maybe prepare the next buffer to receive.

---

**备注:** This is required only when the slave is working in segment mode.

---

**参数**

- **spi** -- SPI device handle representing the slave
- **flags** -- SPI\_TRANS\_\* flags to control the transaction mode of the transaction to send.

**返回**

- ESP\_OK: success
- or other return value from :cpp:func:spi\_device\_transmit.

**Structures**

```
struct essl_spi_config_t
```

Configuration of ESSL SPI device.

**Public Members**

```
spi_device_handle_t *spi
```

Pointer to SPI device handle.

```
uint32_t tx_buf_size
```

The pre-negotiated Master TX buffer size used by both the host and the slave.

```
uint8_t tx_sync_reg
```

The pre-negotiated register ID for Master-TX-SLAVE-RX synchronization. 1 word (4 Bytes) will be reserved for the synchronization.

```
uint8_t rx_sync_reg
```

The pre-negotiated register ID for Master-RX-Slave-TX synchronization. 1 word (4 Bytes) will be reserved for the synchronization.

## 2.2.8 ESP x509 证书包

**概述**

ESP x509 证书包 API 提供了一种简便的方法，帮助你安装自定义 x509 根证书用于 TLS 服务器验证。

---

**备注：**目前在使用 WolfSSL 时该证书包不可用。

---

该证书包中包括 Mozilla NSS 根证书存储区的完整根证书列表。使用 `gen_cert_bundle.py` python 程序，可将证书的主题名称和公钥存储在文件中，并嵌入 ESP32-H2 二进制文件。

生成证书包时，你需选择：

- 来自 Mozilla 的完整根证书包，包含超过 130 份证书。目前提供的证书包更新于 2024 年 3 月 11 日，星期一，15:25:27 (GMT)。
- 一组预先筛选的常用根证书。其中仅包含约 41 份证书，但根据 SSL 证书颁发机构统计数据，其绝对使用率约达到 90%，市场覆盖率约达 99%。

此外，还可指定证书文件的路径或包含证书的目录，将其他证书添加到生成的证书包中。

---

**备注：**信任所有根证书意味着如果任何证书被收回，就必须更新证书列表，包括从 `cacrt_all.pem` 中将其删除。

---

## 配置

多数配置可通过 `menuconfig` 完成。CMake 会根据配置信息生成及嵌入证书包。

- `CONFIG_MBEDTLS_CERTIFICATE_BUNDLE`: 自动创建并附加证书包。
- `CONFIG_MBEDTLS_DEFAULT_CERTIFICATE_BUNDLE`: 决定添加证书列表中的哪些证书。
- `CONFIG_MBEDTLS_CUSTOM_CERTIFICATE_BUNDLE_PATH`: 指定要在证书包中嵌入的其他证书的路径。

要在使用 ESP-TLS 时启用证书包，将函数指针指向证书包的 `attach` 函数：

```
esp_tls_cfg_t cfg = {
    .cert_bundle_attach = esp_cert_bundle_attach,
};
```

此步骤是为了避免在用户未使能的情况下嵌入证书包。

如果直接使用 mbedTLS 包，在设置阶段直接调用 `attach` 函数可以激活证书包：

```
mbedtls_ssl_config conf;
mbedtls_ssl_config_init(&conf);

esp_cert_bundle_attach(&conf);
```

## 生成根证书列表

根证书列表来自 Mozilla 的 [NSS 根证书商店](#)。

运行 `mk-ca-bundle.pl` 脚本可下载和创建列表。脚本发布于 [curl](#)。

还可通过 `curl` 网站直接下载完整列表：[从 Mozilla 提取的 CA 证书](#)。

常用证书包是通过筛选出市场份额超过 1% 的授权机构来决定的，筛选数据来自 w3tech 的 [SSL Survey](#)。

根据这些授权机构，从 Mozilla 提供的 [列表](#) 的 `cmn_cert_authorities.csv` 中筛选证书名称。

## 更新证书包

证书包嵌入到应用程序中，通过 OTA 更新与应用程序一起更新。如果想使用比目前 ESP-IDF 中的证书包更新的包，则可按照[生成根证书列表](#)中的说明从 Mozilla 下载证书列表。

## 定期同步

证书包会与 Mozilla 的 NSS 根证书商店定期同步。在 ESP-IDF 的次要版本或补丁版本中，为了保证兼容性，会将上游证书包中已弃用的证书添加到弃用列表。如有需要，可以通过 `CONFIG_MBEDTLS_CERTIFICATE_BUNDLE_DEPRECATED_LIST` 将弃用证书加入默认证书包。这些弃用证书将在下一个 ESP-IDF 主要版本中移除。

## 应用示例

使用 ESP-TLS 创建安全套接字连接的简单 HTTPS 示例：[protocols/https\\_x509\\_bundle](#)，该示例使用了证书包并添加了两个自定义证书用于验证。

使用 ESP-TLS 和默认证书包的 HTTPS 示例：[protocols/https\\_request](#)。

使用 mbedTLS 和默认证书包的 HTTPS 示例：[protocols/https\\_mbedtls](#)。

## API 参考

### Header File

- [components/mbedtls/esp\\_cert\\_bundle/include/esp\\_cert\\_bundle.h](#)
- This header file can be included with:

```
#include "esp_cert_bundle.h"
```

- This header file is a part of the API provided by the `mbedtls` component. To declare that your component depends on `mbedtls`, add the following to your `CMakeLists.txt`:

```
REQUIRES mbedtls
```

or

```
PRIV_REQUIRES mbedtls
```

### Functions

*esp\_err\_t* **esp\_cert\_bundle\_attach** (void \*conf)

Attach and enable use of a bundle for certificate verification.

Attach and enable use of a bundle for certificate verification through a verification callback. If no specific bundle has been set through `esp_cert_bundle_set()` it will default to the bundle defined in `menuconfig` and embedded in the binary.

**参数** `conf` -- **[in]** The config struct for the SSL connection.

**返回**

- `ESP_OK` if adding certificates was successful.
- Other if an error occurred or an action must be taken by the calling process.

void **esp\_cert\_bundle\_detach** (mbedtls\_ssl\_config \*conf)

Disable and deallocate the certification bundle.

Removes the certificate verification callback and deallocates used resources

**参数** `conf` -- **[in]** The config struct for the SSL connection.

*esp\_err\_t* **esp\_cert\_bundle\_set** (const uint8\_t \*x509\_bundle, size\_t bundle\_size)

Set the default certificate bundle used for verification.

Overrides the default certificate bundle only in case of successful initialization. In most use cases the bundle should be set through `menuconfig`. The bundle needs to be sorted by subject name since binary search is used to find certificates.

**参数**

- `x509_bundle` -- **[in]** A pointer to the certificate bundle.
- `bundle_size` -- **[in]** Size of the certificate bundle in bytes.

**返回**

- `ESP_OK` if adding certificates was successful.
- Other if an error occurred or an action must be taken by the calling process.

## 2.2.9 HTTP 服务器

### 概述

HTTP Server 组件提供了在 ESP32 上运行轻量级 Web 服务器的功能，下面介绍使用 HTTP Server 组件 API 的详细步骤：



- `httpd_start()`: 创建 HTTP 服务器的实例, 根据具体的配置为其分配内存和资源, 并返回该服务器实例的句柄。服务器使用了两个套接字, 一个用来监听 HTTP 流量 (TCP 类型), 另一个用来处理控制信号 (UDP 类型), 它们在服务器的任务循环中轮流使用。通过向 `httpd_start()` 传递 `httpd_config_t` 结构体, 可以在创建服务器实例时配置任务的优先级和堆栈的大小。TCP 流量被解析为 HTTP 请求, 根据请求的 URI 来调用用户注册的处理程序, 在处理程序中需要发送回 HTTP 响应数据包。
- `httpd_stop()`: 根据传入的句柄停止服务器, 并释放相关联的内存和资源。这是一个阻塞函数, 首先给服务器任务发送停止信号, 然后等待其终止。期间服务器任务会关闭所有已打开的连接, 删除已注册的 URI 处理程序, 并将所有会话的上下文数据重置为空。
- `httpd_register_uri_handler()`: 通过传入 `httpd_uri_t` 结构体类型的对象来注册 URI 处理程序。该结构体包含如下成员: `uri` 名字, `method` 类型 (比如 `HTTPD_GET/HTTPD_POST/HTTPD_PUT` 等等), `esp_err_t *handler (httpd_req_t *req)` 类型的函数指针, 指向用户上下文数据的 `user_ctx` 指针。

### 应用示例

```

/* URI 处理函数, 在客户端发起 GET /uri 请求时被调用 */
esp_err_t get_handler(httpd_req_t *req)
{
    /* 发送回简单的响应数据包 */
    const char resp[] = "URI GET Response";
    httpd_resp_send(req, resp, HTTPD_RESP_USE_STRLEN);
    return ESP_OK;
}

/* URI 处理函数, 在客户端发起 POST/uri 请求时被调用 */
esp_err_t post_handler(httpd_req_t *req)
{
    /* 定义 HTTP POST 请求数据的目标缓存区
     * httpd_req_recv() 只接收 char* 数据, 但也可以是
     * 任意二进制数据 (需要类型转换)
     * 对于字符串数据, null 终止符会被省略,
     * content_len 会给出字符串的长度 */
    char content[100];

    /* 如果内容长度大于缓冲区则截断 */
    size_t recv_size = MIN(req->content_len, sizeof(content));

    int ret = httpd_req_recv(req, content, recv_size);
    if (ret <= 0) { /* 返回 0 表示连接已关闭 */
        /* 检查是否超时 */
        if (ret == HTTPD SOCK_ERR_TIMEOUT) {
            /* 如果是超时, 可以调用 httpd_req_recv() 重试
             * 简单起见, 这里我们直接
             * 响应 HTTP 408 (请求超时) 错误给客户端 */
            httpd_resp_send_408(req);
        }
        /* 如果发生了错误, 返回 ESP_FAIL 可以确保
         * 底层套接字被关闭 */
        return ESP_FAIL;
    }

    /* 发送简单的响应数据包 */
    const char resp[] = "URI POST Response";
    httpd_resp_send(req, resp, HTTPD_RESP_USE_STRLEN);
    return ESP_OK;
}

/* GET /uri 的 URI 处理结构 */
httpd_uri_t uri_get = {

```

(下页继续)

```

    .uri      = "/uri",
    .method   = HTTP_GET,
    .handler  = get_handler,
    .user_ctx = NULL
};

/* POST/uri 的 URI 处理结构 */
httpd_uri_t uri_post = {
    .uri      = "/uri",
    .method   = HTTP_POST,
    .handler  = post_handler,
    .user_ctx = NULL
};

/* 启动 Web 服务器的函数 */
httpd_handle_t start_webserver(void)
{
    /* 生成默认的配置参数 */
    httpd_config_t config = HTTPD_DEFAULT_CONFIG();

    /* 置空 esp_http_server 的实例句柄 */
    httpd_handle_t server = NULL;

    /* 启动 httpd server */
    if (httpd_start(&server, &config) == ESP_OK) {
        /* 注册 URI 处理程序 */
        httpd_register_uri_handler(server, &uri_get);
        httpd_register_uri_handler(server, &uri_post);
    }
    /* 如果服务器启动失败，返回的句柄是 NULL */
    return server;
}

/* 停止 Web 服务器的函数 */
void stop_webserver(httpd_handle_t server)
{
    if (server) {
        /* 停止 httpd server */
        httpd_stop(server);
    }
}

```

**简单 HTTP 服务器示例** 请查看位于 [protocols/http\\_server/simple](#) 的 HTTP 服务器示例，该示例演示了如何处理任意内容长度的数据，读取请求头和 URL 查询参数，设置响应头。

## HTTP 长连接

HTTP 服务器具有长连接的功能，允许重复使用同一个连接（会话）进行多次传输，同时保持会话的上下文数据。上下文数据可由处理程序动态分配，在这种情况下需要提前指定好自定义的回调函数，以便在连接/会话被关闭时释放这部分内存资源。

### 长连接示例

```

/* 自定义函数，用来释放上下文数据 */
void free_ctx_func(void *ctx)
{
    /* 也可以是 free 以外的代码逻辑 */
    free(ctx);
}

```

(下页继续)

```

}

esp_err_t adder_post_handler(httpd_req_t *req)
{
    /* 若上下文中不存在会话，则新建一个 */
    if (! req->sess_ctx) {
        req->sess_ctx = malloc(sizeof(ANY_DATA_TYPE)); /*!< 指向上下文数据 */
        req->free_ctx = free_ctx_func; /*!< 释放上下文数据的函数 */
    }

    /* 访问上下文数据 */
    ANY_DATA_TYPE *ctx_data = (ANY_DATA_TYPE *) req->sess_ctx;

    /* 响应 */
    .....
    .....
    .....

    return ESP_OK;
}

```

详情请参考位于 [protocols/http\\_server/persistent\\_sockets](#) 的示例代码。

## Websocket 服务器

HTTP 服务器组件提供 websocket 支持。可以在 `menuconfig` 中使用 `CONFIG_HTTPD_WS_SUPPORT` 选项启用 websocket 功能。有关如何使用 websocket 功能，请参阅 [protocols/http\\_server/ws\\_echo\\_server](#) 目录下的示例代码。

## 事件处理

ESP HTTP 服务器有各种事件，当特定事件发生时，[事件循环库](#) 可以触发处理程序。必须使用 `esp_event_handler_register()` 注册处理程序以便 ESP HTTP 服务器进行事件处理。

`esp_http_server_event_id_t` 包含 ESP HTTP 服务器可能发生的所有事件。

以下为事件循环中不同 ESP HTTP 服务器事件的预期数据类型：

- `HTTP_SERVER_EVENT_ERROR`: `httpd_err_code_t`
- `HTTP_SERVER_EVENT_START`: `NULL`
- `HTTP_SERVER_EVENT_ON_CONNECTED`: `int`
- `HTTP_SERVER_EVENT_ON_HEADER`: `int`
- `HTTP_SERVER_EVENT_HEADERS_SENT`: `int`
- `HTTP_SERVER_EVENT_ON_DATA`: `esp_http_server_event_data`
- `HTTP_SERVER_EVENT_SENT_DATA`: `esp_http_server_event_data`
- `HTTP_SERVER_EVENT_DISCONNECTED`: `int`
- `HTTP_SERVER_EVENT_STOP`: `NULL`

## API 参考

### Header File

- `components/esp_http_server/include/esp_http_server.h`
- This header file can be included with:

```
#include "esp_http_server.h"
```

- This header file is a part of the API provided by the `esp_http_server` component. To declare that your component depends on `esp_http_server`, add the following to your `CMakeLists.txt`:

```
REQUIRES esp_http_server
```

or

```
PRIV_REQUIRES esp_http_server
```

## Functions

*esp\_err\_t* **httpd\_start** (*httpd\_handle\_t* \*handle, const *httpd\_config\_t* \*config)

Starts the web server.

Create an instance of HTTP server and allocate memory/resources for it depending upon the specified configuration.

Example usage:

```
//Function for starting the webserver
httpd_handle_t start_webserver(void)
{
    // Generate default configuration
    httpd_config_t config = HTTPD_DEFAULT_CONFIG();

    // Empty handle to http_server
    httpd_handle_t server = NULL;

    // Start the httpd server
    if (httpd_start(&server, &config) == ESP_OK) {
        // Register URI handlers
        httpd_register_uri_handler(server, &uri_get);
        httpd_register_uri_handler(server, &uri_post);
    }
    // If server failed to start, handle will be NULL
    return server;
}
```

### 参数

- **config** -- [in] Configuration for new instance of the server
- **handle** -- [out] Handle to newly created instance of the server. NULL on error

### 返回

- `ESP_OK` : Instance created successfully
- `ESP_ERR_INVALID_ARG` : Null argument(s)
- `ESP_ERR_HTTPD_ALLOC_MEM` : Failed to allocate memory for instance
- `ESP_ERR_HTTPD_TASK` : Failed to launch server task

*esp\_err\_t* **httpd\_stop** (*httpd\_handle\_t* handle)

Stops the web server.

Deallocates memory/resources used by an HTTP server instance and deletes it. Once deleted the handle can no longer be used for accessing the instance.

Example usage:

```
// Function for stopping the webserver
void stop_webserver(httpd_handle_t server)
{
    // Ensure handle is non NULL
    if (server != NULL) {
        // Stop the httpd server
        httpd_stop(server);
    }
}
```

(下页继续)

```

    }
}

```

**参数** **handle** -- **[in]** Handle to server returned by `httpd_start`

**返回**

- `ESP_OK` : Server stopped successfully
- `ESP_ERR_INVALID_ARG` : Handle argument is Null

*esp\_err\_t* **httpd\_register\_uri\_handler** (*httpd\_handle\_t* handle, const *httpd\_uri\_t* \*uri\_handler)

Registers a URI handler.

Example usage:

```

esp_err_t my_uri_handler(httpd_req_t* req)
{
    // Recv , Process and Send
    ....
    ....
    ....

    // Fail condition
    if (....) {
        // Return fail to close session //
        return ESP_FAIL;
    }

    // On success
    return ESP_OK;
}

// URI handler structure
httpd_uri_t my_uri {
    .uri      = "/my_uri/path/xyz",
    .method   = HTTPD_GET,
    .handler  = my_uri_handler,
    .user_ctx = NULL
};

// Register handler
if (httpd_register_uri_handler(server_handle, &my_uri) != ESP_OK) {
    // If failed to register handler
    ....
}

```

**备注:** URI handlers can be registered in real time as long as the server handle is valid.

**参数**

- **handle** -- **[in]** handle to HTTPD server instance
- **uri\_handler** -- **[in]** pointer to handler that needs to be registered

**返回**

- `ESP_OK` : On successfully registering the handler
- `ESP_ERR_INVALID_ARG` : Null arguments
- `ESP_ERR_HTTPD_HANDLERS_FULL` : If no slots left for new handler
- `ESP_ERR_HTTPD_HANDLER_EXISTS` : If handler with same URI and method is already registered

*esp\_err\_t* **httpd\_unregister\_uri\_handler** (*httpd\_handle\_t* handle, const char \*uri, *httpd\_method\_t* method)

Unregister a URI handler.

#### 参数

- **handle** -- [in] handle to HTTPD server instance
- **uri** -- [in] URI string
- **method** -- [in] HTTP method

#### 返回

- ESP\_OK : On successfully deregistering the handler
- ESP\_ERR\_INVALID\_ARG : Null arguments
- ESP\_ERR\_NOT\_FOUND : Handler with specified URI and method not found

*esp\_err\_t* **httpd\_unregister\_uri** (*httpd\_handle\_t* handle, const char \*uri)

Unregister all URI handlers with the specified uri string.

#### 参数

- **handle** -- [in] handle to HTTPD server instance
- **uri** -- [in] uri string specifying all handlers that need to be deregistered

#### 返回

- ESP\_OK : On successfully deregistering all such handlers
- ESP\_ERR\_INVALID\_ARG : Null arguments
- ESP\_ERR\_NOT\_FOUND : No handler registered with specified uri string

*esp\_err\_t* **httpd\_sess\_set\_recv\_override** (*httpd\_handle\_t* hd, int sockfd, *httpd\_recv\_func\_t* recv\_func)

Override web server's receive function (by session FD)

This function overrides the web server's receive function. This same function is used to read HTTP request packets.

---

**备注:** This API is supposed to be called either from the context of

- an http session APIs where sockfd is a valid parameter
  - a URI handler where sockfd is obtained using `httpd_req_to_sockfd()`
- 

#### 参数

- **hd** -- [in] HTTPD instance handle
- **sockfd** -- [in] Session socket FD
- **recv\_func** -- [in] The receive function to be set for this session

#### 返回

- ESP\_OK : On successfully registering override
- ESP\_ERR\_INVALID\_ARG : Null arguments

*esp\_err\_t* **httpd\_sess\_set\_send\_override** (*httpd\_handle\_t* hd, int sockfd, *httpd\_send\_func\_t* send\_func)

Override web server's send function (by session FD)

This function overrides the web server's send function. This same function is used to send out any response to any HTTP request.

---

**备注:** This API is supposed to be called either from the context of

- an http session APIs where sockfd is a valid parameter
  - a URI handler where sockfd is obtained using `httpd_req_to_sockfd()`
- 

#### 参数

- **hd** -- [in] HTTPD instance handle
- **sockfd** -- [in] Session socket FD
- **send\_func** -- [in] The send function to be set for this session

**返回**

- ESP\_OK : On successfully registering override
- ESP\_ERR\_INVALID\_ARG : Null arguments

*esp\_err\_t* **httpd\_sess\_set\_pending\_override** (*httpd\_handle\_t* hd, int sockfd, *httpd\_pending\_func\_t* pending\_func)

Override web server's pending function (by session FD)

This function overrides the web server's pending function. This function is used to test for pending bytes in a socket.

---

**备注:** This API is supposed to be called either from the context of

- an http session APIs where sockfd is a valid parameter
  - a URI handler where sockfd is obtained using httpd\_req\_to\_sockfd()
- 

**参数**

- **hd** -- **[in]** HTTPD instance handle
- **sockfd** -- **[in]** Session socket FD
- **pending\_func** -- **[in]** The receive function to be set for this session

**返回**

- ESP\_OK : On successfully registering override
- ESP\_ERR\_INVALID\_ARG : Null arguments

*esp\_err\_t* **httpd\_req\_async\_handler\_begin** (*httpd\_req\_t* \*r, *httpd\_req\_t* \*\*out)

Start an asynchronous request. This function can be called in a request handler to get a request copy that can be used on a async thread.

---

**备注:**

- This function is necessary in order to handle multiple requests simultaneously. See examples/async\_requests for example usage.
  - You must call httpd\_req\_async\_handler\_complete() when you are done with the request.
- 

**参数**

- **r** -- **[in]** The request to create an async copy of
- **out** -- **[out]** A newly allocated request which can be used on an async thread

**返回**

- ESP\_OK : async request object created

*esp\_err\_t* **httpd\_req\_async\_handler\_complete** (*httpd\_req\_t* \*r)

Mark an asynchronous request as completed. This will.

- free the request memory
- relinquish ownership of the underlying socket, so it can be reused.
- allow the http server to close our socket if needed (lru\_purge\_enable)

---

**备注:** If async requests are not marked completed, eventually the server will no longer accept incoming connections. The server will log a "httpd\_accept\_conn: error in accept (23)" message if this happens.

---

**参数** **r** -- **[in]** The request to mark async work as completed

**返回**

- ESP\_OK : async request was marked completed

int **httpd\_req\_to\_sockfd** (*httpd\_req\_t* \*r)

Get the Socket Descriptor from the HTTP request.

This API will return the socket descriptor of the session for which URI handler was executed on reception of HTTP request. This is useful when user wants to call functions that require session socket fd, from within a URI handler, ie. : `httpd_sess_get_ctx()`, `httpd_sess_trigger_close()`, `httpd_sess_update_lru_counter()`.

---

**备注:** This API is supposed to be called only from the context of a URI handler where `httpd_req_t*` request pointer is valid.

---

**参数** **r** -- **[in]** The request whose socket descriptor should be found  
**返回**

- Socket descriptor : The socket descriptor for this request
- -1 : Invalid/NULL request pointer

int **httpd\_req\_recv** (*httpd\_req\_t* \*r, char \*buf, size\_t buf\_len)

API to read content data from the HTTP request.

This API will read HTTP content data from the HTTP request into provided buffer. Use `content_len` provided in `httpd_req_t` structure to know the length of data to be fetched. If `content_len` is too large for the buffer then user may have to make multiple calls to this function, each time fetching 'buf\_len' number of bytes, while the pointer to content data is incremented internally by the same number.

---

**备注:**

- This API is supposed to be called only from the context of a URI handler where `httpd_req_t*` request pointer is valid.
  - If an error is returned, the URI handler must further return an error. This will ensure that the erroneous socket is closed and cleaned up by the web server.
  - Presently Chunked Encoding is not supported
- 

**参数**

- **r** -- **[in]** The request being responded to
- **buf** -- **[in]** Pointer to a buffer that the data will be read into
- **buf\_len** -- **[in]** Length of the buffer

**返回**

- Bytes : Number of bytes read into the buffer successfully
- 0 : Buffer length parameter is zero / connection closed by peer
- `HTTPD SOCK_ERR_INVALID` : Invalid arguments
- `HTTPD SOCK_ERR_TIMEOUT` : Timeout/interrupted while calling socket `recv()`
- `HTTPD SOCK_ERR_FAIL` : Unrecoverable error while calling socket `recv()`

size\_t **httpd\_req\_get\_hdr\_value\_len** (*httpd\_req\_t* \*r, const char \*field)

Search for a field in request headers and return the string length of it's value.

---

**备注:**

- This API is supposed to be called only from the context of a URI handler where `httpd_req_t*` request pointer is valid.
  - Once `httpd_resp_send()` API is called all request headers are purged, so request headers need be copied into separate buffers if they are required later.
- 

**参数**

- **r** -- **[in]** The request being responded to
- **field** -- **[in]** The header field to be searched in the request



**返回**

- Length : If field is found in the request URL
- Zero : Field not found / Invalid request / Null arguments

*esp\_err\_t* **httpd\_req\_get\_hdr\_value\_str** (*httpd\_req\_t* \*r, const char \*field, char \*val, size\_t val\_size)

Get the value string of a field from the request headers.

---

**备注:**

- This API is supposed to be called only from the context of a URI handler where *httpd\_req\_t*\* request pointer is valid.
  - Once *httpd\_resp\_send()* API is called all request headers are purged, so request headers need be copied into separate buffers if they are required later.
  - If output size is greater than input, then the value is truncated, accompanied by truncation error as return value.
  - Use *httpd\_req\_get\_hdr\_value\_len()* to know the right buffer length
- 

**参数**

- **r** -- [in] The request being responded to
- **field** -- [in] The field to be searched in the header
- **val** -- [out] Pointer to the buffer into which the value will be copied if the field is found
- **val\_size** -- [in] Size of the user buffer "val"

**返回**

- ESP\_OK : Field found in the request header and value string copied
- ESP\_ERR\_NOT\_FOUND : Key not found
- ESP\_ERR\_INVALID\_ARG : Null arguments
- ESP\_ERR\_HTTPD\_INVALID\_REQ : Invalid HTTP request pointer
- ESP\_ERR\_HTTPD\_RESULT\_TRUNC : Value string truncated

*size\_t* **httpd\_req\_get\_url\_query\_len** (*httpd\_req\_t* \*r)

Get Query string length from the request URL.

---

**备注:** This API is supposed to be called only from the context of a URI handler where *httpd\_req\_t*\* request pointer is valid

---

**参数** **r** -- [in] The request being responded to

**返回**

- Length : Query is found in the request URL
- Zero : Query not found / Null arguments / Invalid request

*esp\_err\_t* **httpd\_req\_get\_url\_query\_str** (*httpd\_req\_t* \*r, char \*buf, size\_t buf\_len)

Get Query string from the request URL.

---

**备注:**

- Presently, the user can fetch the full URL query string, but decoding will have to be performed by the user. Request headers can be read using *httpd\_req\_get\_hdr\_value\_str()* to know the 'Content-Type' (eg. Content-Type: application/x-www-form-urlencoded) and then the appropriate decoding algorithm needs to be applied.
- This API is supposed to be called only from the context of a URI handler where *httpd\_req\_t*\* request pointer is valid
- If output size is greater than input, then the value is truncated, accompanied by truncation error as return value

- Prior to calling this function, one can use `httpd_req_get_url_query_len()` to know the query string length beforehand and hence allocate the buffer of right size (usually query string length + 1 for null termination) for storing the query string
- 

**参数**

- **r** -- **[in]** The request being responded to
- **buf** -- **[out]** Pointer to the buffer into which the query string will be copied (if found)
- **buf\_len** -- **[in]** Length of output buffer

**返回**

- `ESP_OK` : Query is found in the request URL and copied to buffer
- `ESP_ERR_NOT_FOUND` : Query not found
- `ESP_ERR_INVALID_ARG` : Null arguments
- `ESP_ERR_HTTPD_INVALID_REQ` : Invalid HTTP request pointer
- `ESP_ERR_HTTPD_RESULT_TRUNC` : Query string truncated

*esp\_err\_t* **httpd\_query\_key\_value** (const char \*qry, const char \*key, char \*val, size\_t val\_size)

Helper function to get a URL query tag from a query string of the type param1=val1&param2=val2.

---

**备注:**

- The components of URL query string (keys and values) are not URLdecoded. The user must check for 'Content-Type' field in the request headers and then depending upon the specified encoding (URLencoded or otherwise) apply the appropriate decoding algorithm.
  - If actual value size is greater than val\_size, then the value is truncated, accompanied by truncation error as return value.
- 

**参数**

- **qry** -- **[in]** Pointer to query string
- **key** -- **[in]** The key to be searched in the query string
- **val** -- **[out]** Pointer to the buffer into which the value will be copied if the key is found
- **val\_size** -- **[in]** Size of the user buffer "val"

**返回**

- `ESP_OK` : Key is found in the URL query string and copied to buffer
- `ESP_ERR_NOT_FOUND` : Key not found
- `ESP_ERR_INVALID_ARG` : Null arguments
- `ESP_ERR_HTTPD_RESULT_TRUNC` : Value string truncated

*esp\_err\_t* **httpd\_req\_get\_cookie\_val** (*httpd\_req\_t* \*req, const char \*cookie\_name, char \*val, size\_t \*val\_size)

Get the value string of a cookie value from the "Cookie" request headers by cookie name.

**参数**

- **req** -- **[in]** Pointer to the HTTP request
- **cookie\_name** -- **[in]** The cookie name to be searched in the request
- **val** -- **[out]** Pointer to the buffer into which the value of cookie will be copied if the cookie is found
- **val\_size** -- **[inout]** Pointer to size of the user buffer "val". This variable will contain cookie length if `ESP_OK` is returned and required buffer length incase `ESP_ERR_HTTPD_RESULT_TRUNC` is returned.

**返回**

- `ESP_OK` : Key is found in the cookie string and copied to buffer
- `ESP_ERR_NOT_FOUND` : Key not found
- `ESP_ERR_INVALID_ARG` : Null arguments
- `ESP_ERR_HTTPD_RESULT_TRUNC` : Value string truncated
- `ESP_ERR_NO_MEM` : Memory allocation failure

bool **httpd\_uri\_match\_wildcard** (const char \*uri\_template, const char \*uri\_to\_match, size\_t match\_upto)

Test if a URI matches the given wildcard template.

Template may end with "?" to make the previous character optional (typically a slash), "\*" for a wildcard match, and "?\*" to make the previous character optional, and if present, allow anything to follow.

Example:

- \* matches everything
- /foo/? matches /foo and /foo/
- /foo/\* (sans the backslash) matches /foo/ and /foo/bar, but not /foo or /fo
- /foo/?\* or /foo/\*? (sans the backslash) matches /foo/, /foo/bar, and also /foo, but not /foox or /fo

The special characters "?" and "\*" anywhere else in the template will be taken literally.

#### 参数

- **uri\_template** -- [in] URI template (pattern)
- **uri\_to\_match** -- [in] URI to be matched
- **match\_upto** -- [in] how many characters of the URI buffer to test (there may be trailing query string etc.)

返回 true if a match was found

*esp\_err\_t* **httpd\_resp\_send** (*httpd\_req\_t* \*r, const char \*buf, ssize\_t buf\_len)

API to send a complete HTTP response.

This API will send the data as an HTTP response to the request. This assumes that you have the entire response ready in a single buffer. If you wish to send response in incremental chunks use `httpd_resp_send_chunk()` instead.

If no status code and content-type were set, by default this will send 200 OK status code and content type as text/html. You may call the following functions before this API to configure the response headers : `httpd_resp_set_status()` - for setting the HTTP status string, `httpd_resp_set_type()` - for setting the Content Type, `httpd_resp_set_hdr()` - for appending any additional field value entries in the response header

---

#### 备注:

- This API is supposed to be called only from the context of a URI handler where `httpd_req_t*` request pointer is valid.
  - Once this API is called, the request has been responded to.
  - No additional data can then be sent for the request.
  - Once this API is called, all request headers are purged, so request headers need be copied into separate buffers if they are required later.
- 

#### 参数

- **r** -- [in] The request being responded to
- **buf** -- [in] Buffer from where the content is to be fetched
- **buf\_len** -- [in] Length of the buffer, `HTTPD_RESP_USE_STRLEN` to use `strlen()`

#### 返回

- `ESP_OK` : On successfully sending the response packet
- `ESP_ERR_INVALID_ARG` : Null request pointer
- `ESP_ERR_HTTPD_RESP_HDR` : Essential headers are too large for internal buffer
- `ESP_ERR_HTTPD_RESP_SEND` : Error in raw send
- `ESP_ERR_HTTPD_INVALID_REQ` : Invalid request

*esp\_err\_t* **httpd\_resp\_send\_chunk** (*httpd\_req\_t* \*r, const char \*buf, ssize\_t buf\_len)

API to send one HTTP chunk.

This API will send the data as an HTTP response to the request. This API will use chunked-encoding and send the response in the form of chunks. If you have the entire response contained in a single buffer, please use `httpd_resp_send()` instead.

If no status code and content-type were set, by default this will send 200 OK status code and content type as text/html. You may call the following functions before this API to configure the response headers `httpd_resp_set_status()` - for setting the HTTP status string, `httpd_resp_set_type()` - for setting the Content Type, `httpd_resp_set_hdr()` - for appending any additional field value entries in the response header

---

#### 备注:

- This API is supposed to be called only from the context of a URI handler where `httpd_req_t*` request pointer is valid.
  - When you are finished sending all your chunks, you must call this function with `buf_len` as 0.
  - Once this API is called, all request headers are purged, so request headers need be copied into separate buffers if they are required later.
- 

#### 参数

- **r** -- **[in]** The request being responded to
- **buf** -- **[in]** Pointer to a buffer that stores the data
- **buf\_len** -- **[in]** Length of the buffer, `HTTPD_RESP_USE_STRLEN` to use `strlen()`

#### 返回

- `ESP_OK` : On successfully sending the response packet chunk
- `ESP_ERR_INVALID_ARG` : Null request pointer
- `ESP_ERR_HTTPD_RESP_HDR` : Essential headers are too large for internal buffer
- `ESP_ERR_HTTPD_RESP_SEND` : Error in raw send
- `ESP_ERR_HTTPD_INVALID_REQ` : Invalid request pointer

static inline *esp\_err\_t* **httpd\_resp\_sendstr** (*httpd\_req\_t* \*r, const char \*str)

API to send a complete string as HTTP response.

This API simply calls `http_resp_send` with buffer length set to string length assuming the buffer contains a null terminated string

#### 参数

- **r** -- **[in]** The request being responded to
- **str** -- **[in]** String to be sent as response body

#### 返回

- `ESP_OK` : On successfully sending the response packet
- `ESP_ERR_INVALID_ARG` : Null request pointer
- `ESP_ERR_HTTPD_RESP_HDR` : Essential headers are too large for internal buffer
- `ESP_ERR_HTTPD_RESP_SEND` : Error in raw send
- `ESP_ERR_HTTPD_INVALID_REQ` : Invalid request

static inline *esp\_err\_t* **httpd\_resp\_sendstr\_chunk** (*httpd\_req\_t* \*r, const char \*str)

API to send a string as an HTTP response chunk.

This API simply calls `http_resp_send_chunk` with buffer length set to string length assuming the buffer contains a null terminated string

#### 参数

- **r** -- **[in]** The request being responded to
- **str** -- **[in]** String to be sent as response body (NULL to finish response packet)

#### 返回

- `ESP_OK` : On successfully sending the response packet
- `ESP_ERR_INVALID_ARG` : Null request pointer
- `ESP_ERR_HTTPD_RESP_HDR` : Essential headers are too large for internal buffer
- `ESP_ERR_HTTPD_RESP_SEND` : Error in raw send
- `ESP_ERR_HTTPD_INVALID_REQ` : Invalid request

*esp\_err\_t* **httpd\_resp\_set\_status** (*httpd\_req\_t* \*r, const char \*status)

API to set the HTTP status code.

This API sets the status of the HTTP response to the value specified. By default, the '200 OK' response is sent as the response.

---

**备注:**

- This API is supposed to be called only from the context of a URI handler where `httpd_req_t*` request pointer is valid.
  - This API only sets the status to this value. The status isn't sent out until any of the send APIs is executed.
  - Make sure that the lifetime of the status string is valid till send function is called.
- 

**参数**

- **r** -- **[in]** The request being responded to
- **status** -- **[in]** The HTTP status code of this response

**返回**

- `ESP_OK` : On success
- `ESP_ERR_INVALID_ARG` : Null arguments
- `ESP_ERR_HTTPD_INVALID_REQ` : Invalid request pointer

*esp\_err\_t* **httpd\_resp\_set\_type** (*httpd\_req\_t* \*r, const char \*type)

API to set the HTTP content type.

This API sets the 'Content Type' field of the response. The default content type is 'text/html'.

---

**备注:**

- This API is supposed to be called only from the context of a URI handler where `httpd_req_t*` request pointer is valid.
  - This API only sets the content type to this value. The type isn't sent out until any of the send APIs is executed.
  - Make sure that the lifetime of the type string is valid till send function is called.
- 

**参数**

- **r** -- **[in]** The request being responded to
- **type** -- **[in]** The Content Type of the response

**返回**

- `ESP_OK` : On success
- `ESP_ERR_INVALID_ARG` : Null arguments
- `ESP_ERR_HTTPD_INVALID_REQ` : Invalid request pointer

*esp\_err\_t* **httpd\_resp\_set\_hdr** (*httpd\_req\_t* \*r, const char \*field, const char \*value)

API to append any additional headers.

This API sets any additional header fields that need to be sent in the response.

---

**备注:**

- This API is supposed to be called only from the context of a URI handler where `httpd_req_t*` request pointer is valid.
  - The header isn't sent out until any of the send APIs is executed.
  - The maximum allowed number of additional headers is limited to value of `max_resp_headers` in config structure.
  - Make sure that the lifetime of the field value strings are valid till send function is called.
- 

**参数**

- **r** -- **[in]** The request being responded to
- **field** -- **[in]** The field name of the HTTP header

- **value** -- **[in]** The value of this HTTP header
- 返回
- ESP\_OK : On successfully appending new header
  - ESP\_ERR\_INVALID\_ARG : Null arguments
  - ESP\_ERR\_HTTPD\_RESP\_HDR : Total additional headers exceed max allowed
  - ESP\_ERR\_HTTPD\_INVALID\_REQ : Invalid request pointer

*esp\_err\_t* **httpd\_resp\_send\_err** (*httpd\_req\_t* \*req, *httpd\_err\_code\_t* error, const char \*msg)

For sending out error code in response to HTTP request.

---

**备注:**

- This API is supposed to be called only from the context of a URI handler where *httpd\_req\_t*\* request pointer is valid.
- Once this API is called, all request headers are purged, so request headers need be copied into separate buffers if they are required later.
- If you wish to send additional data in the body of the response, please use the lower-level functions directly.

---

**参数**

- **req** -- **[in]** Pointer to the HTTP request for which the response needs to be sent
- **error** -- **[in]** Error type to send
- **msg** -- **[in]** Error message string (pass NULL for default message)

**返回**

- ESP\_OK : On successfully sending the response packet
- ESP\_ERR\_INVALID\_ARG : Null arguments
- ESP\_ERR\_HTTPD\_RESP\_SEND : Error in raw send
- ESP\_ERR\_HTTPD\_INVALID\_REQ : Invalid request pointer

*esp\_err\_t* **httpd\_resp\_send\_custom\_err** (*httpd\_req\_t* \*req, const char \*status, const char \*msg)

For sending out custom error code in response to HTTP request.

---

**备注:**

- This API is supposed to be called only from the context of a URI handler where *httpd\_req\_t*\* request pointer is valid.
- Once this API is called, all request headers are purged, so request headers need be copied into separate buffers if they are required later.
- If you wish to send additional data in the body of the response, please use the lower-level functions directly.

---

**参数**

- **req** -- **[in]** Pointer to the HTTP request for which the response needs to be sent
- **status** -- **[in]** Error status to send
- **msg** -- **[in]** Error message string

**返回**

- ESP\_OK : On successfully sending the response packet
- ESP\_ERR\_INVALID\_ARG : Null arguments
- ESP\_ERR\_HTTPD\_RESP\_SEND : Error in raw send
- ESP\_ERR\_HTTPD\_INVALID\_REQ : Invalid request pointer

static inline *esp\_err\_t* **httpd\_resp\_send\_404** (*httpd\_req\_t* \*r)

Helper function for HTTP 404.

Send HTTP 404 message. If you wish to send additional data in the body of the response, please use the lower-level functions directly.

**备注:**

- This API is supposed to be called only from the context of a URI handler where `httpd_req_t*` request pointer is valid.
  - Once this API is called, all request headers are purged, so request headers need be copied into separate buffers if they are required later.
- 

**参数** `r` -- **[in]** The request being responded to

**返回**

- `ESP_OK` : On successfully sending the response packet
- `ESP_ERR_INVALID_ARG` : Null arguments
- `ESP_ERR_HTTPD_RESP_SEND` : Error in raw send
- `ESP_ERR_HTTPD_INVALID_REQ` : Invalid request pointer

static inline `esp_err_t httpd_resp_send_408` (`httpd_req_t` \*r)

Helper function for HTTP 408.

Send HTTP 408 message. If you wish to send additional data in the body of the response, please use the lower-level functions directly.

---

**备注:**

- This API is supposed to be called only from the context of a URI handler where `httpd_req_t*` request pointer is valid.
  - Once this API is called, all request headers are purged, so request headers need be copied into separate buffers if they are required later.
- 

**参数** `r` -- **[in]** The request being responded to

**返回**

- `ESP_OK` : On successfully sending the response packet
- `ESP_ERR_INVALID_ARG` : Null arguments
- `ESP_ERR_HTTPD_RESP_SEND` : Error in raw send
- `ESP_ERR_HTTPD_INVALID_REQ` : Invalid request pointer

static inline `esp_err_t httpd_resp_send_500` (`httpd_req_t` \*r)

Helper function for HTTP 500.

Send HTTP 500 message. If you wish to send additional data in the body of the response, please use the lower-level functions directly.

---

**备注:**

- This API is supposed to be called only from the context of a URI handler where `httpd_req_t*` request pointer is valid.
  - Once this API is called, all request headers are purged, so request headers need be copied into separate buffers if they are required later.
- 

**参数** `r` -- **[in]** The request being responded to

**返回**

- `ESP_OK` : On successfully sending the response packet
- `ESP_ERR_INVALID_ARG` : Null arguments
- `ESP_ERR_HTTPD_RESP_SEND` : Error in raw send
- `ESP_ERR_HTTPD_INVALID_REQ` : Invalid request pointer

int **httpd\_send** (*httpd\_req\_t* \*r, const char \*buf, size\_t buf\_len)

Raw HTTP send.

Call this API if you wish to construct your custom response packet. When using this, all essential header, eg. HTTP version, Status Code, Content Type and Length, Encoding, etc. will have to be constructed manually, and HTTP delimiters (CRLF) will need to be placed correctly for separating sub-sections of the HTTP response packet.

If the send override function is set, this API will end up calling that function eventually to send data out.

---

#### 备注:

- This API is supposed to be called only from the context of a URI handler where *httpd\_req\_t*\* request pointer is valid.
  - Unless the response has the correct HTTP structure (which the user must now ensure) it is not guaranteed that it will be recognized by the client. For most cases, you wouldn't have to call this API, but you would rather use either of : *httpd\_resp\_send()*, *httpd\_resp\_send\_chunk()*
- 

#### 参数

- **r** -- **[in]** The request being responded to
- **buf** -- **[in]** Buffer from where the fully constructed packet is to be read
- **buf\_len** -- **[in]** Length of the buffer

#### 返回

- Bytes : Number of bytes that were sent successfully
- HTTPD\_SOCK\_ERR\_INVALID : Invalid arguments
- HTTPD\_SOCK\_ERR\_TIMEOUT : Timeout/interrupted while calling socket send()
- HTTPD\_SOCK\_ERR\_FAIL : Unrecoverable error while calling socket send()

int **httpd\_socket\_send** (*httpd\_handle\_t* hd, int sockfd, const char \*buf, size\_t buf\_len, int flags)

A low level API to send data on a given socket

This internally calls the default send function, or the function registered by *httpd\_sess\_set\_send\_override()*.

---

**备注:** This API is not recommended to be used in any request handler. Use this only for advanced use cases, wherein some asynchronous data is to be sent over a socket.

---

#### 参数

- **hd** -- **[in]** server instance
- **sockfd** -- **[in]** session socket file descriptor
- **buf** -- **[in]** buffer with bytes to send
- **buf\_len** -- **[in]** data size
- **flags** -- **[in]** flags for the send() function

#### 返回

- Bytes : The number of bytes sent successfully
- HTTPD\_SOCK\_ERR\_INVALID : Invalid arguments
- HTTPD\_SOCK\_ERR\_TIMEOUT : Timeout/interrupted while calling socket send()
- HTTPD\_SOCK\_ERR\_FAIL : Unrecoverable error while calling socket send()

int **httpd\_socket\_recv** (*httpd\_handle\_t* hd, int sockfd, char \*buf, size\_t buf\_len, int flags)

A low level API to receive data from a given socket

This internally calls the default recv function, or the function registered by *httpd\_sess\_set\_recv\_override()*.



---

**备注:** This API is not recommended to be used in any request handler. Use this only for advanced use cases, wherein some asynchronous communication is required.

---

**参数**

- **hd** -- **[in]** server instance
- **sockfd** -- **[in]** session socket file descriptor
- **buf** -- **[in]** buffer with bytes to send
- **buf\_len** -- **[in]** data size
- **flags** -- **[in]** flags for the send() function

**返回**

- Bytes : The number of bytes received successfully
- 0 : Buffer length parameter is zero / connection closed by peer
- HTTPD SOCK\_ERR\_INVALID : Invalid arguments
- HTTPD SOCK\_ERR\_TIMEOUT : Timeout/interrupted while calling socket recv()
- HTTPD SOCK\_ERR\_FAIL : Unrecoverable error while calling socket recv()

*esp\_err\_t* **httpd\_register\_err\_handler** (*httpd\_handle\_t* handle, *httpd\_err\_code\_t* error, *httpd\_err\_handler\_func\_t* handler\_fn)

Function for registering HTTP error handlers.

This function maps a handler function to any supported error code given by *httpd\_err\_code\_t*. See prototype *httpd\_err\_handler\_func\_t* above for details.

**参数**

- **handle** -- **[in]** HTTP server handle
- **error** -- **[in]** Error type
- **handler\_fn** -- **[in]** User implemented handler function (Pass NULL to unset any previously set handler)

**返回**

- ESP\_OK : handler registered successfully
- ESP\_ERR\_INVALID\_ARG : invalid error code or server handle

*esp\_err\_t* **httpd\_queue\_work** (*httpd\_handle\_t* handle, *httpd\_work\_fn\_t* work, void \*arg)

Queue execution of a function in HTTPD's context.

This API queues a work function for asynchronous execution

---

**备注:** Some protocols require that the web server generate some asynchronous data and send it to the persistently opened connection. This facility is for use by such protocols.

---

**参数**

- **handle** -- **[in]** Handle to server returned by *httpd\_start*
- **work** -- **[in]** Pointer to the function to be executed in the HTTPD's context
- **arg** -- **[in]** Pointer to the arguments that should be passed to this function

**返回**

- ESP\_OK : On successfully queueing the work
- ESP\_FAIL : Failure in ctrl socket
- ESP\_ERR\_INVALID\_ARG : Null arguments

void \***httpd\_sess\_get\_ctx** (*httpd\_handle\_t* handle, int sockfd)

Get session context from socket descriptor.

Typically if a session context is created, it is available to URI handlers through the *httpd\_req\_t* structure. But, there are cases where the web server's send/receive functions may require the context (for example, for accessing keying information etc). Since the send/receive function only have the socket descriptor at their disposal, this API provides them with a way to retrieve the session context.

**参数**

- **handle** -- **[in]** Handle to server returned by `httpd_start`
- **sockfd** -- **[in]** The socket descriptor for which the context should be extracted.

**返回**

- `void*` : Pointer to the context associated with this session
- `NULL` : Empty context / Invalid handle / Invalid socket fd

void **httpd\_sess\_set\_ctx** (*httpd\_handle\_t* handle, int sockfd, void \*ctx, *httpd\_free\_ctx\_fn\_t* free\_fn)

Set session context by socket descriptor.

**参数**

- **handle** -- **[in]** Handle to server returned by `httpd_start`
- **sockfd** -- **[in]** The socket descriptor for which the context should be extracted.
- **ctx** -- **[in]** Context object to assign to the session
- **free\_fn** -- **[in]** Function that should be called to free the context

void \***httpd\_sess\_get\_transport\_ctx** (*httpd\_handle\_t* handle, int sockfd)

Get session 'transport' context by socket descriptor.

This context is used by the send/receive functions, for example to manage SSL context.

**参见:**

`httpd_sess_get_ctx()`

**参数**

- **handle** -- **[in]** Handle to server returned by `httpd_start`
- **sockfd** -- **[in]** The socket descriptor for which the context should be extracted.

**返回**

- `void*` : Pointer to the transport context associated with this session
- `NULL` : Empty context / Invalid handle / Invalid socket fd

void **httpd\_sess\_set\_transport\_ctx** (*httpd\_handle\_t* handle, int sockfd, void \*ctx, *httpd\_free\_ctx\_fn\_t* free\_fn)

Set session 'transport' context by socket descriptor.

**参见:**

`httpd_sess_set_ctx()`

**参数**

- **handle** -- **[in]** Handle to server returned by `httpd_start`
- **sockfd** -- **[in]** The socket descriptor for which the context should be extracted.
- **ctx** -- **[in]** Transport context object to assign to the session
- **free\_fn** -- **[in]** Function that should be called to free the transport context

void \***httpd\_get\_global\_user\_ctx** (*httpd\_handle\_t* handle)

Get HTTPD global user context (it was set in the server config struct)

**参数** **handle** -- **[in]** Handle to server returned by `httpd_start`

**返回** global user context

void \***httpd\_get\_global\_transport\_ctx** (*httpd\_handle\_t* handle)

Get HTTPD global transport context (it was set in the server config struct)

**参数** **handle** -- **[in]** Handle to server returned by `httpd_start`

**返回** global transport context

*esp\_err\_t* **httpd\_sess\_trigger\_close** (*httpd\_handle\_t* handle, int sockfd)

Trigger an httpd session close externally.

---

**备注:** Calling this API is only required in special circumstances wherein some application requires to close an httpd client session asynchronously.

---

**参数**

- **handle** -- **[in]** Handle to server returned by `httpd_start`
- **sockfd** -- **[in]** The socket descriptor of the session to be closed

**返回**

- `ESP_OK` : On successfully initiating closure
- `ESP_FAIL` : Failure to queue work
- `ESP_ERR_NOT_FOUND` : Socket fd not found
- `ESP_ERR_INVALID_ARG` : Null arguments

*esp\_err\_t* **httpd\_sess\_update\_lru\_counter** (*httpd\_handle\_t* handle, int sockfd)

Update LRU counter for a given socket.

LRU Counters are internally associated with each session to monitor how recently a session exchanged traffic. When LRU purge is enabled, if a client is requesting for connection but maximum number of sockets/sessions is reached, then the session having the earliest LRU counter is closed automatically.

Updating the LRU counter manually prevents the socket from being purged due to the Least Recently Used (LRU) logic, even though it might not have received traffic for some time. This is useful when all open sockets/session are frequently exchanging traffic but the user specifically wants one of the sessions to be kept open, irrespective of when it last exchanged a packet.

---

**备注:** Calling this API is only necessary if the LRU Purge Enable option is enabled.

---

**参数**

- **handle** -- **[in]** Handle to server returned by `httpd_start`
- **sockfd** -- **[in]** The socket descriptor of the session for which LRU counter is to be updated

**返回**

- `ESP_OK` : Socket found and LRU counter updated
- `ESP_ERR_NOT_FOUND` : Socket not found
- `ESP_ERR_INVALID_ARG` : Null arguments

*esp\_err\_t* **httpd\_get\_client\_list** (*httpd\_handle\_t* handle, size\_t \*fds, int \*client\_fds)

Returns list of current socket descriptors of active sessions.

---

**备注:** Size of provided array has to be equal or greater than maximum number of opened sockets, configured upon initialization with `max_open_sockets` field in `httpd_config_t` structure.

---

**参数**

- **handle** -- **[in]** Handle to server returned by `httpd_start`
- **fds** -- **[inout]** In: Size of provided `client_fds` array Out: Number of valid client fds returned in `client_fds`,
- **client\_fds** -- **[out]** Array of client fds

**返回**

- `ESP_OK` : Successfully retrieved session list
- `ESP_ERR_INVALID_ARG` : Wrong arguments or list is longer than provided array

## Structures

struct **esp\_http\_server\_event\_data**

Argument structure for HTTP\_SERVER\_EVENT\_ON\_DATA and HTTP\_SERVER\_EVENT\_SENT\_DATA event

### Public Members

int **fd**

Session socket file descriptor

int **data\_len**

Data length

struct **httpd\_config**

HTTP Server Configuration Structure.

---

**备注:** Use HTTPD\_DEFAULT\_CONFIG() to initialize the configuration to a default value and then modify only those fields that are specifically determined by the use case.

---

### Public Members

unsigned **task\_priority**

Priority of FreeRTOS task which runs the server

size\_t **stack\_size**

The maximum stack size allowed for the server task

BaseType\_t **core\_id**

The core the HTTP server task will run on

uint32\_t **task\_caps**

The memory capabilities to use when allocating the HTTP server task's stack

uint16\_t **server\_port**

TCP Port number for receiving and transmitting HTTP traffic

uint16\_t **ctrl\_port**

UDP Port number for asynchronously exchanging control signals between various components of the server

uint16\_t **max\_open\_sockets**

Max number of sockets/clients connected at any time (3 sockets are reserved for internal working of the HTTP server)

uint16\_t **max\_uri\_handlers**

Maximum allowed uri handlers

uint16\_t **max\_resp\_headers**

Maximum allowed additional headers in HTTP response

uint16\_t **backlog\_conn**

Number of backlog connections

bool **lru\_purge\_enable**

Purge "Least Recently Used" connection

uint16\_t **recv\_wait\_timeout**

Timeout for recv function (in seconds)

uint16\_t **send\_wait\_timeout**

Timeout for send function (in seconds)

void \***global\_user\_ctx**

Global user context.

This field can be used to store arbitrary user data within the server context. The value can be retrieved using the server handle, available e.g. in the `httpd_req_t` struct.

When shutting down, the server frees up the user context by calling `free()` on the `global_user_ctx` field. If you wish to use a custom function for freeing the global user context, please specify that here.

[\*httpd\\_free\\_ctx\\_fn\\_t\*](#) **global\_user\_ctx\_free\_fn**

Free function for global user context

void \***global\_transport\_ctx**

Global transport context.

Similar to `global_user_ctx`, but used for session encoding or encryption (e.g. to hold the SSL context). It will be freed using `free()`, unless `global_transport_ctx_free_fn` is specified.

[\*httpd\\_free\\_ctx\\_fn\\_t\*](#) **global\_transport\_ctx\_free\_fn**

Free function for global transport context

bool **enable\_so\_linger**

bool to enable/disable linger

int **linger\_timeout**

linger timeout (in seconds)

bool **keep\_alive\_enable**

Enable keep-alive timeout

int **keep\_alive\_idle**

Keep-alive idle time. Default is 5 (second)

int **keep\_alive\_interval**

Keep-alive interval time. Default is 5 (second)

**int keep\_alive\_count**

Keep-alive packet retry send count. Default is 3 counts

***httpd\_open\_func\_t* open\_fn**

Custom session opening callback.

Called on a new session socket just after `accept()`, but before reading any data.

This is an opportunity to set up e.g. SSL encryption using `global_transport_ctx` and the `send/recv/pending` session overrides.

If a context needs to be maintained between these functions, store it in the session using `httpd_sess_set_transport_ctx()` and retrieve it later with `httpd_sess_get_transport_ctx()`

Returning a value other than `ESP_OK` will immediately close the new socket.

***httpd\_close\_func\_t* close\_fn**

Custom session closing callback.

Called when a session is deleted, before freeing user and transport contexts and before closing the socket. This is a place for custom de-init code common to all sockets.

The server will only close the socket if no custom session closing callback is set. If a custom callback is used, `close(sockfd)` should be called in here for most cases.

Set the user or transport context to `NULL` if it was freed here, so the server does not try to free it again.

This function is run for all terminated sessions, including sessions where the socket was closed by the network stack - that is, the file descriptor may not be valid anymore.

***httpd\_uri\_match\_func\_t* uri\_match\_fn**

URI matcher function.

Called when searching for a matching URI: 1) whose request handler is to be executed right after an HTTP request is successfully parsed 2) in order to prevent duplication while registering a new URI handler using `httpd_register_uri_handler()`

Available options are: 1) `NULL` : Internally do basic matching using `strcmp()` 2) `httpd_uri_match_wildcard()` : URI wildcard matcher

Users can implement their own matching functions (See description of the `httpd_uri_match_func_t` function prototype)

**struct httpd\_req**

HTTP Request Data Structure.

**Public Members*****httpd\_handle\_t* handle**

Handle to server instance

**int method**

The type of HTTP request, -1 if unsupported method, `HTTP_ANY` for wildcard method to support every method

const char **uri**[HTTPD\_MAX\_URI\_LEN + 1]

The URI of this request (1 byte extra for null termination)

size\_t **content\_len**

Length of the request body

void \***aux**

Internally used members

void \***user\_ctx**

User context pointer passed during URI registration.

void \***sess\_ctx**

Session Context Pointer

A session context. Contexts are maintained across 'sessions' for a given open TCP connection. One session could have multiple request responses. The web server will ensure that the context persists across all these request and responses.

By default, this is NULL. URI Handlers can set this to any meaningful value.

If the underlying socket gets closed, and this pointer is non-NULL, the web server will free up the context by calling free(), unless free\_ctx function is set.

[httpd\\_free\\_ctx\\_fn\\_t](#) **free\_ctx**

Pointer to free context hook

Function to free session context

If the web server's socket closes, it frees up the session context by calling free() on the sess\_ctx member. If you wish to use a custom function for freeing the session context, please specify that here.

bool **ignore\_sess\_ctx\_changes**

Flag indicating if Session Context changes should be ignored

By default, if you change the sess\_ctx in some URI handler, the http server will internally free the earlier context (if non NULL), after the URI handler returns. If you want to manage the allocation/reallocation/freeing of sess\_ctx yourself, set this flag to true, so that the server will not perform any checks on it. The context will be cleared by the server (by calling free\_ctx or free()) only if the socket gets closed.

struct **httpd\_uri**

Structure for URI handler.

### Public Members

const char \***uri**

The URI to handle

[httpd\\_method\\_t](#) **method**

Method supported by the URI, HTTP\_ANY for wildcard method to support all methods

[esp\\_err\\_t](#) (\***handler**)([httpd\\_req\\_t](#) \*r)

Handler to call for supported request method. This must return ESP\_OK, or else the underlying socket will be closed.

void \***user\_ctx**

Pointer to user context data which will be available to handler

## Macros

**HTTP\_ANY**

**HTTPD\_MAX\_REQ\_HDR\_LEN**

**HTTPD\_MAX\_URI\_LEN**

**HTTPD SOCK\_ERR\_FAIL**

**HTTPD SOCK\_ERR\_INVALID**

**HTTPD SOCK\_ERR\_TIMEOUT**

**HTTPD\_200**

HTTP Response 200

**HTTPD\_204**

HTTP Response 204

**HTTPD\_207**

HTTP Response 207

**HTTPD\_400**

HTTP Response 400

**HTTPD\_404**

HTTP Response 404

**HTTPD\_408**

HTTP Response 408

**HTTPD\_500**

HTTP Response 500

**HTTPD\_TYPE\_JSON**

HTTP Content type JSON

**HTTPD\_TYPE\_TEXT**

HTTP Content type text/HTML

**HTTPD\_TYPE\_OCTET**

HTTP Content type octext-stream



**ESP\_HTTPD\_DEF\_CTRL\_PORT**

HTTP Server control socket port

**HTTPD\_DEFAULT\_CONFIG()****ESP\_ERR\_HTTPD\_BASE**

Starting number of HTTPD error codes

**ESP\_ERR\_HTTPD\_HANDLERS\_FULL**

All slots for registering URI handlers have been consumed

**ESP\_ERR\_HTTPD\_HANDLER\_EXISTS**

URI handler with same method and target URI already registered

**ESP\_ERR\_HTTPD\_INVALID\_REQ**

Invalid request pointer

**ESP\_ERR\_HTTPD\_RESULT\_TRUNC**

Result string truncated

**ESP\_ERR\_HTTPD\_RESP\_HDR**

Response header field larger than supported

**ESP\_ERR\_HTTPD\_RESP\_SEND**

Error occurred while sending response packet

**ESP\_ERR\_HTTPD\_ALLOC\_MEM**

Failed to dynamically allocate memory for resource

**ESP\_ERR\_HTTPD\_TASK**

Failed to launch server task/thread

**HTTPD\_RESP\_USE\_STRLEN****Type Definitions**typedef void \***httpd\_handle\_t**

HTTP Server Instance Handle.

Every instance of the server will have a unique handle.

typedef enum http\_method **httpd\_method\_t**

HTTP Method Type wrapper over "enum http\_method" available in "http\_parser" library.

typedef void (\***httpd\_free\_ctx\_fn\_t**)(void \*ctx)

Prototype for freeing context data (if any)

**Param ctx** [in] object to free

```
typedef esp_err_t (*httpd_open_func_t)(httpd_handle_t hd, int sockfd)
```

Function prototype for opening a session.

Called immediately after the socket was opened to set up the send/recv functions and other parameters of the socket.

**Param hd [in]** server instance

**Param sockfd [in]** session socket file descriptor

**Return**

- ESP\_OK : On success
- Any value other than ESP\_OK will signal the server to close the socket immediately

```
typedef void (*httpd_close_func_t)(httpd_handle_t hd, int sockfd)
```

Function prototype for closing a session.

---

**备注:** It's possible that the socket descriptor is invalid at this point, the function is called for all terminated sessions. Ensure proper handling of return codes.

---

**Param hd [in]** server instance

**Param sockfd [in]** session socket file descriptor

```
typedef bool (*httpd_uri_match_func_t)(const char *reference_uri, const char *uri_to_match, size_t match_upto)
```

Function prototype for URI matching.

**Param reference\_uri [in]** URI/template with respect to which the other URI is matched

**Param uri\_to\_match [in]** URI/template being matched to the reference URI/template

**Param match\_upto [in]** For specifying the actual length of `uri_to_match` up to which the matching algorithm is to be applied (The maximum value is `strlen(uri_to_match)`, independent of the length of `reference_uri`)

**Return** true on match

```
typedef struct httpd_config httpd_config_t
```

HTTP Server Configuration Structure.

---

**备注:** Use `HTTPD_DEFAULT_CONFIG()` to initialize the configuration to a default value and then modify only those fields that are specifically determined by the use case.

---

```
typedef struct httpd_req httpd_req_t
```

HTTP Request Data Structure.

```
typedef struct httpd_uri httpd_uri_t
```

Structure for URI handler.

```
typedef int (*httpd_send_func_t)(httpd_handle_t hd, int sockfd, const char *buf, size_t buf_len, int flags)
```

Prototype for HTTPDs low-level send function.

---

**备注:** User specified send function must handle errors internally, depending upon the set value of `errno`, and return specific `HTTPD_SOCK_ERR_codes`, which will eventually be conveyed as return value of `httpd_send()` function

---

**Param hd [in]** server instance  
**Param sockfd [in]** session socket file descriptor  
**Param buf [in]** buffer with bytes to send  
**Param buf\_len [in]** data size  
**Param flags [in]** flags for the send() function

**Return**

- Bytes : The number of bytes sent successfully
- HTTPD\_SOCK\_ERR\_INVALID : Invalid arguments
- HTTPD\_SOCK\_ERR\_TIMEOUT : Timeout/interrupted while calling socket send()
- HTTPD\_SOCK\_ERR\_FAIL : Unrecoverable error while calling socket send()

```
typedef int (*httpd_recv_func_t)(httpd_handle_t hd, int sockfd, char *buf, size_t buf_len, int flags)
```

Prototype for HTTPDs low-level recv function.

---

**备注:** User specified recv function must handle errors internally, depending upon the set value of `errno`, and return specific `HTTPD_SOCK_ERR_` codes, which will eventually be conveyed as return value of `httpd_req_recv()` function

---

**Param hd [in]** server instance  
**Param sockfd [in]** session socket file descriptor  
**Param buf [in]** buffer with bytes to send  
**Param buf\_len [in]** data size  
**Param flags [in]** flags for the send() function

**Return**

- Bytes : The number of bytes received successfully
- 0 : Buffer length parameter is zero / connection closed by peer
- HTTPD\_SOCK\_ERR\_INVALID : Invalid arguments
- HTTPD\_SOCK\_ERR\_TIMEOUT : Timeout/interrupted while calling socket recv()
- HTTPD\_SOCK\_ERR\_FAIL : Unrecoverable error while calling socket recv()

```
typedef int (*httpd_pending_func_t)(httpd_handle_t hd, int sockfd)
```

Prototype for HTTPDs low-level "get pending bytes" function.

---

**备注:** User specified pending function must handle errors internally, depending upon the set value of `errno`, and return specific `HTTPD_SOCK_ERR_` codes, which will be handled accordingly in the server task.

---

**Param hd [in]** server instance  
**Param sockfd [in]** session socket file descriptor

**Return**

- Bytes : The number of bytes waiting to be received
- HTTPD\_SOCK\_ERR\_INVALID : Invalid arguments
- HTTPD\_SOCK\_ERR\_TIMEOUT : Timeout/interrupted while calling socket pending()
- HTTPD\_SOCK\_ERR\_FAIL : Unrecoverable error while calling socket pending()

```
typedef esp_err_t (*httpd_err_handler_func_t)(httpd_req_t *req, httpd_err_code_t error)
```

Function prototype for HTTP error handling.

This function is executed upon HTTP errors generated during internal processing of an HTTP request. This is used to override the default behavior on error, which is to send HTTP error response and close the underlying socket.

---

**备注:**

- If implemented, the server will not automatically send out HTTP error response codes, therefore, `httpd_resp_send_err()` must be invoked inside this function if user wishes to generate HTTP error responses.
  - When invoked, the validity of `uri`, `method`, `content_len` and `user_ctx` fields of the `httpd_req_t` parameter is not guaranteed as the HTTP request may be partially received/parsed.
  - The function must return `ESP_OK` if underlying socket needs to be kept open. Any other value will ensure that the socket is closed. The return value is ignored when error is of type `HTTPD_500_INTERNAL_SERVER_ERROR` and the socket closed anyway.
- 

**Param req [in]** HTTP request for which the error needs to be handled

**Param error [in]** Error type

**Return**

- `ESP_OK` : error handled successful
- `ESP_FAIL` : failure indicates that the underlying socket needs to be closed

`typedef void (*httpd_work_fn_t)(void *arg)`

Prototype of the HTTPD work function Please refer to `httpd_queue_work()` for more details.

**Param arg [in]** The arguments for this work function

### Enumerations

enum `httpd_err_code_t`

Error codes sent as HTTP response in case of errors encountered during processing of an HTTP request.

*Values:*

enumerator `HTTPD_500_INTERNAL_SERVER_ERROR`

enumerator `HTTPD_501_METHOD_NOT_IMPLEMENTED`

enumerator `HTTPD_505_VERSION_NOT_SUPPORTED`

enumerator `HTTPD_400_BAD_REQUEST`

enumerator `HTTPD_401_UNAUTHORIZED`

enumerator `HTTPD_403_FORBIDDEN`

enumerator `HTTPD_404_NOT_FOUND`

enumerator `HTTPD_405_METHOD_NOT_ALLOWED`

enumerator `HTTPD_408_REQ_TIMEOUT`

enumerator `HTTPD_411_LENGTH_REQUIRED`

enumerator `HTTPD_414_URI_TOO_LONG`

enumerator `HTTPD_431_REQ_HDR_FIELDS_TOO_LARGE`

enumerator **HTTPD\_ERR\_CODE\_MAX**

enum **esp\_http\_server\_event\_id\_t**

HTTP Server events id.

*Values:*

enumerator **HTTP\_SERVER\_EVENT\_ERROR**

This event occurs when there are any errors during execution

enumerator **HTTP\_SERVER\_EVENT\_START**

This event occurs when HTTP Server is started

enumerator **HTTP\_SERVER\_EVENT\_ON\_CONNECTED**

Once the HTTP Server has been connected to the client, no data exchange has been performed

enumerator **HTTP\_SERVER\_EVENT\_ON\_HEADER**

Occurs when receiving each header sent from the client

enumerator **HTTP\_SERVER\_EVENT\_HEADERS\_SENT**

After sending all the headers to the client

enumerator **HTTP\_SERVER\_EVENT\_ON\_DATA**

Occurs when receiving data from the client

enumerator **HTTP\_SERVER\_EVENT\_SENT\_DATA**

Occurs when an ESP HTTP server session is finished

enumerator **HTTP\_SERVER\_EVENT\_DISCONNECTED**

The connection has been disconnected

enumerator **HTTP\_SERVER\_EVENT\_STOP**

This event occurs when HTTP Server is stopped

## 2.2.10 HTTPS 服务器

### 概述

HTTPS 服务器组件建立在[HTTP 服务器](#)组件的基础上。该服务器借助常规 HTTP 服务器中的钩子注册函数，注册 SSL 会话回调处理函数。

[HTTP 服务器](#) 组件的所有文档同样适用于用户按照本文档搭建的服务器。

### API 说明

下列[HTTP 服务器](#)的 API 已不适用于[HTTPS 服务器](#)。这些 API 仅限内部使用，用于处理安全会话和维护内部状态。

- “send”、“receive”和“pending”回调注册函数——处理安全套接字

- `httpd_sess_set_send_override()`
- `httpd_sess_set_recv_override()`
- `httpd_sess_set_pending_override()`
- "transport context"——传输层上下文
  - `httpd_sess_get_transport_ctx()`: 返回会话使用的 SSL
  - `httpd_sess_set_transport_ctx()`
  - `httpd_get_global_transport_ctx()`: 返回共享的 SSL 上下文
  - `httpd_config::global_transport_ctx`
  - `httpd_config::global_transport_ctx_free_fn`
  - `httpd_config::open_fn`: 用于设置安全套接字

其他 API 均可使用，没有其他限制。

## 如何使用

请参考示例 [protocols/https\\_server](#) 来学习如何搭建安全的服务器。

总体而言，只需生成证书，将其嵌入到固件中，并且在初始化结构体中配置好正确的证书地址和长度后，将其传入服务器启动函数。

通过改变初始化配置结构体中的标志 `httpd_ssl_config::transport_mode`，可以选择是否需要 SSL 连接来启动服务器。在测试时或在速度比安全性更重要的可信环境中，可以使用此功能。

## 性能

建立起始会话大约需要两秒，在时钟速度较慢或日志记录冗余信息较多的情况下，可能需要花费更多时间。后续通过已打开的安全套接字建立请求的速度会更快，最快只需不到 100 ms。

## 事件处理

ESP HTTPS 服务器在特定事件发生时，可以通过 [事件循环库](#) 触发事件处理程序。处理程序必须使用 `esp_event_handler_register()` 进行注册，以帮助 ESP HTTPS 服务器处理事件。

`esp_https_server_event_id_t` 包含了 ESP HTTPS 服务器可能发生的所有事件。

事件循环中不同 ESP HTTPS 服务器事件的预期数据类型如下所示：

- `HTTPS_SERVER_EVENT_ERROR`: `esp_https_server_last_error_t`
- `HTTPS_SERVER_EVENT_START`: `NULL`
- `HTTPS_SERVER_EVENT_ON_CONNECTED`: `NULL`
- `HTTPS_SERVER_EVENT_ON_DATA`: `int`
- `HTTPS_SERVER_EVENT_SENT_DATA`: `NULL`
- `HTTPS_SERVER_EVENT_DISCONNECTED`: `NULL`
- `HTTPS_SERVER_EVENT_STOP`: `NULL`

## API 参考

### Header File

- `components/esp_https_server/include/esp_https_server.h`
- This header file can be included with:

```
#include "esp_https_server.h"
```

- This header file is a part of the API provided by the `esp_https_server` component. To declare that your component depends on `esp_https_server`, add the following to your `CMakeLists.txt`:

```
REQUIRES esp_https_server
```

or

```
PRIV_REQUIRES esp_https_server
```

## Functions

*esp\_err\_t* **httpd\_ssl\_start** (*httpd\_handle\_t* \*handle, *httpd\_ssl\_config\_t* \*config)

Create a SSL capable HTTP server (secure mode may be disabled in config)

### 参数

- **config** -- **[inout]** - server config, must not be const. Does not have to stay valid after calling this function.
- **handle** -- **[out]** - storage for the server handle, must be a valid pointer

返回 success

*esp\_err\_t* **httpd\_ssl\_stop** (*httpd\_handle\_t* handle)

Stop the server. Blocks until the server is shut down.

参数 **handle** -- **[in]**

### 返回

- ESP\_OK: Server stopped successfully
- ESP\_ERR\_INVALID\_ARG: Invalid argument
- ESP\_FAIL: Failure to shut down server

## Structures

struct **esp\_https\_server\_user\_cb\_arg**

Callback data struct, contains the ESP-TLS connection handle and the connection state at which the callback is executed.

## Public Members

*httpd\_ssl\_user\_cb\_state\_t* **user\_cb\_state**

State of user callback

*esp\_tls\_t* \***tls**

ESP-TLS connection handle

struct **httpd\_ssl\_config**

HTTPS server config struct

Please use HTTPD\_SSL\_CONFIG\_DEFAULT() to initialize it.

## Public Members

*httpd\_config\_t* **httpd**

Underlying HTTPD server config

Parameters like task stack size and priority can be adjusted here.

const uint8\_t \***servercert**

Server certificate

size\_t **servercert\_len**

Server certificate byte length

const uint8\_t \***cacert\_pem**

CA certificate ((CA used to sign clients, or client cert itself)

size\_t **cacert\_len**

CA certificate byte length

const uint8\_t \***prvtkey\_pem**

Private key

size\_t **prvtkey\_len**

Private key byte length

bool **use\_ecdsa\_peripheral**

Use ECDSA peripheral to use private key

uint8\_t **ecdsa\_key\_efuse\_blk**

The efuse block where ECDSA key is stored

*httpd\_ssl\_transport\_mode\_t* **transport\_mode**

Transport Mode (default secure)

uint16\_t **port\_secure**

Port used when transport mode is secure (default 443)

uint16\_t **port\_insecure**

Port used when transport mode is insecure (default 80)

bool **session\_tickets**

Enable tls session tickets

bool **use\_secure\_element**

Enable secure element for server session

*esp\_https\_server\_user\_cb* \***user\_cb**

User callback for esp\_https\_server

void \***ssl\_userdata**

User data to add to the ssl context

*esp\_tls\_handshake\_callback* **cert\_select\_cb**

Certificate selection callback to use. The callback is only applicable when CONFIG\_ESP\_TLS\_SERVER\_CERT\_SELECT\_HOOK is enabled in menuconfig

const char \*\***alpn\_protos**

Application protocols the server supports in order of preference. Used for negotiating during the TLS handshake, first one the client supports is selected. The data structure must live as long as the https server itself



## Macros

**HTTPD\_SSL\_CONFIG\_DEFAULT** ()

Default config struct init Notes:

- port is set when starting the server, according to 'transport\_mode'
- one socket uses ~ 40kB RAM with SSL, we reduce the default socket count to 4
- SSL sockets are usually long-lived, closing LRU prevents pool exhaustion DOS
- Stack size may need adjustments depending on the user application

## Type Definitions

typedef struct *esp\_https\_server\_user\_cb\_arg* **esp\_https\_server\_user\_cb\_arg\_t**

Callback data struct, contains the ESP-TLS connection handle and the connection state at which the callback is executed.

typedef *esp\_tls\_last\_error\_t* **esp\_https\_server\_last\_error\_t**

typedef void **esp\_https\_server\_user\_cb** (*esp\_https\_server\_user\_cb\_arg\_t* \*user\_cb)

Callback function prototype Can be used to get connection or client information (SSL context) E.g. Client certificate, Socket FD, Connection state, etc.

**Param user\_cb** Callback data struct

typedef struct *httpd\_ssl\_config* **httpd\_ssl\_config\_t**

## Enumerations

enum **esp\_https\_server\_event\_id\_t**

*Values:*

enumerator **HTTPS\_SERVER\_EVENT\_ERROR**

This event occurs when there are any errors during execution

enumerator **HTTPS\_SERVER\_EVENT\_START**

This event occurs when HTTPS Server is started

enumerator **HTTPS\_SERVER\_EVENT\_ON\_CONNECTED**

Once the HTTPS Server has been connected to the client

enumerator **HTTPS\_SERVER\_EVENT\_ON\_DATA**

Occurs when receiving data from the client

enumerator **HTTPS\_SERVER\_EVENT\_SENT\_DATA**

Occurs when an ESP HTTPS server sends data to the client

enumerator **HTTPS\_SERVER\_EVENT\_DISCONNECTED**

The connection has been disconnected

enumerator **HTTPS\_SERVER\_EVENT\_STOP**

This event occurs when HTTPS Server is stopped

enum **httpd\_ssl\_transport\_mode\_t**

*Values:*

enumerator **HTTPD\_SSL\_TRANSPORT\_SECURE**

enumerator **HTTPD\_SSL\_TRANSPORT\_INSECURE**

enum **httpd\_ssl\_user\_cb\_state\_t**

Indicates the state at which the user callback is executed, i.e at session creation or session close.

*Values:*

enumerator **HTTPD\_SSL\_USER\_CB\_SESS\_CREATE**

enumerator **HTTPD\_SSL\_USER\_CB\_SESS\_CLOSE**

## 2.2.11 ICMP 回显

### 概述

网际控制报文协议 (ICMP) 通常用于诊断或控制目的, 或响应 IP 操作中的错误。常用的网络工具 ping 的应答, 即 Echo Reply, 就是基于类型字段值为 0 的 ICMP 数据包实现的。

在 ping 会话中, 首先由源主机发出请求包 (ICMP echo request), 然后等待应答包 (ICMP echo reply), 等待具有超时限制。通过这一过程, 还能测量出信息的往返用时。收到有效的应答包后, 源主机生成 IP 链路层的统计数据 (如失包率、运行时间等)。

IoT 设备通常需要检查远程服务器是否可用。如果服务器离线, 设备应向用户发出警告。通过创建 ping 会话, 定期发送或解析 ICMP echo 数据包, 就能实现这一功能。

为简化这一过程方便用户操作, ESP-IDF 提供了一些好用的 API。

**创建 ping 会话** 要创建 ping 会话, 首先需填写 `esp_ping_config_t`, 指定目标芯片 IP 地址、间隔时间等配置。此外, 还可以通过 `esp_ping_callbacks_t` 注册回调函数。

创建 ping 会话并注册回调函数示例:

```
static void test_on_ping_success(esp_ping_handle_t hdl, void *args)
{
    // optionally, get callback arguments
    // const char* str = (const char*) args;
    // printf("%s\r\n", str); // "foo"
    uint8_t ttl;
    uint16_t seqno;
    uint32_t elapsed_time, recv_len;
    ip_addr_t target_addr;
    esp_ping_get_profile(hdl, ESP_PING_PROF_SEQNO, &seqno, sizeof(seqno));
    esp_ping_get_profile(hdl, ESP_PING_PROF_TTL, &ttl, sizeof(ttl));
    esp_ping_get_profile(hdl, ESP_PING_PROF_IPADDR, &target_addr, sizeof(target_
    ↪addr));
    esp_ping_get_profile(hdl, ESP_PING_PROF_SIZE, &recv_len, sizeof(recv_len));
    esp_ping_get_profile(hdl, ESP_PING_PROF_TIMEGAP, &elapsed_time, sizeof(elapsed_
    ↪time));
    printf("%d bytes from %s icmp_seq=%d ttl=%d time=%d ms\n",
           recv_len, inet_ntoa(target_addr.u_addr.ip4), seqno, ttl, elapsed_time);
}
```

(下页继续)

```

static void test_on_ping_timeout(esp_ping_handle_t hdl, void *args)
{
    uint16_t seqno;
    ip_addr_t target_addr;
    esp_ping_get_profile(hdl, ESP_PING_PROF_SEQNO, &seqno, sizeof(seqno));
    esp_ping_get_profile(hdl, ESP_PING_PROF_IPADDR, &target_addr, sizeof(target_
↪addr));
    printf("From %s icmp_seq=%d timeout\n", inet_ntoa(target_addr.u_addr.ip4), ↪
↪seqno);
}

static void test_on_ping_end(esp_ping_handle_t hdl, void *args)
{
    uint32_t transmitted;
    uint32_t received;
    uint32_t total_time_ms;

    esp_ping_get_profile(hdl, ESP_PING_PROF_REQUEST, &transmitted, ↪
↪sizeof(transmitted));
    esp_ping_get_profile(hdl, ESP_PING_PROF_REPLY, &received, sizeof(received));
    esp_ping_get_profile(hdl, ESP_PING_PROF_DURATION, &total_time_ms, sizeof(total_
↪time_ms));
    printf("%d packets transmitted, %d received, time %dms\n", transmitted, ↪
↪received, total_time_ms);
}

void initialize_ping()
{
    /* convert URL to IP address */
    ip_addr_t target_addr;
    struct addrinfo hint;
    struct addrinfo *res = NULL;
    memset(&hint, 0, sizeof(hint));
    memset(&target_addr, 0, sizeof(target_addr));
    getaddrinfo("www.espressif.com", NULL, &hint, &res);
    struct in_addr addr4 = ((struct sockaddr_in *) (res->ai_addr))->sin_addr;
    inet_addr_to_ip4addr(ip_2_ip4(&target_addr), &addr4);
    freeaddrinfo(res);

    esp_ping_config_t ping_config = ESP_PING_DEFAULT_CONFIG();
    ping_config.target_addr = target_addr;           // target IP address
    ping_config.count = ESP_PING_COUNT_INFINITE;    // ping in infinite mode, esp_
↪ping_stop can stop it

    /* set callback functions */
    esp_ping_callbacks_t cbs;
    cbs.on_ping_success = test_on_ping_success;
    cbs.on_ping_timeout = test_on_ping_timeout;
    cbs.on_ping_end = test_on_ping_end;
    cbs.cb_args = "foo"; // arguments that will feed to all callback functions, ↪
↪can be NULL
    cbs.cb_args = eth_event_group;

    esp_ping_handle_t ping;
    esp_ping_new_session(&ping_config, &cbs, &ping);
}

```

**启动和停止 ping 会话** 使用 `esp_ping_new_session` 返回的句柄可以启动或停止 ping 会话。注意，ping 会话在创建后不会自动启动。如果 ping 会话停止后重启，ICMP 数据包的序列号会归零重新计数。

**删除 ping 会话** 如果不再使用 ping 会话，可用 `esp_ping_delete_session` 将其删除。在删除 ping 会话时，确保该会话已处于停止状态（即已调用了 `esp_ping_stop`，或该会话已完成所有步骤）。

**获取运行时间数据** 在回调函数中调用 `esp_ping_get_profile`，可获取 ping 会话的不同运行时间数据，如上文代码示例所示。

## 应用示例

ICMP echo 示例：[protocols/icmp\\_echo](#)

## API 参考

### Header File

- `components/lwip/include/apps/ping/ping_sock.h`
- This header file can be included with:

```
#include "ping/ping_sock.h"
```

- This header file is a part of the API provided by the `lwip` component. To declare that your component depends on `lwip`, add the following to your `CMakeLists.txt`:

```
REQUIRES lwip
```

or

```
PRIV_REQUIRES lwip
```

### Functions

`esp_err_t esp_ping_new_session` (const `esp_ping_config_t` \*config, const `esp_ping_callbacks_t` \*cbs, `esp_ping_handle_t` \*hdl\_out)

Create a ping session.

#### 参数

- **config** -- ping configuration
- **cbs** -- a bunch of callback functions invoked by internal ping task
- **hdl\_out** -- handle of ping session

#### 返回

- `ESP_ERR_INVALID_ARG`: invalid parameters (e.g. configuration is null, etc)
- `ESP_ERR_NO_MEM`: out of memory
- `ESP_FAIL`: other internal error (e.g. socket error)
- `ESP_OK`: create ping session successfully, user can take the ping handle to do follow-on jobs

`esp_err_t esp_ping_delete_session` (`esp_ping_handle_t` hdl)

Delete a ping session.

参数 **hdl** -- handle of ping session

#### 返回

- `ESP_ERR_INVALID_ARG`: invalid parameters (e.g. ping handle is null, etc)
- `ESP_OK`: delete ping session successfully

`esp_err_t esp_ping_start` (`esp_ping_handle_t` hdl)

Start the ping session.

参数 **hdl** -- handle of ping session

#### 返回

- `ESP_ERR_INVALID_ARG`: invalid parameters (e.g. ping handle is null, etc)
- `ESP_OK`: start ping session successfully

*esp\_err\_t* **esp\_ping\_stop** (*esp\_ping\_handle\_t* hdl)

Stop the ping session.

**参数** **hdl** -- handle of ping session

**返回**

- **ESP\_ERR\_INVALID\_ARG**: invalid parameters (e.g. ping handle is null, etc)
- **ESP\_OK**: stop ping session successfully

*esp\_err\_t* **esp\_ping\_get\_profile** (*esp\_ping\_handle\_t* hdl, *esp\_ping\_profile\_t* profile, void \*data, uint32\_t size)

Get runtime profile of ping session.

**参数**

- **hdl** -- handle of ping session
- **profile** -- type of profile
- **data** -- profile data
- **size** -- profile data size

**返回**

- **ESP\_ERR\_INVALID\_ARG**: invalid parameters (e.g. ping handle is null, etc)
- **ESP\_ERR\_INVALID\_SIZE**: the actual profile data size doesn't match the "size" parameter
- **ESP\_OK**: get profile successfully

## Structures

struct **esp\_ping\_callbacks\_t**

Type of "ping" callback functions.

### Public Members

void \***cb\_args**

arguments for callback functions

void (\***on\_ping\_success**)(*esp\_ping\_handle\_t* hdl, void \*args)

Invoked by internal ping thread when received ICMP echo reply packet.

void (\***on\_ping\_timeout**)(*esp\_ping\_handle\_t* hdl, void \*args)

Invoked by internal ping thread when receive ICMP echo reply packet timeout.

void (\***on\_ping\_end**)(*esp\_ping\_handle\_t* hdl, void \*args)

Invoked by internal ping thread when a ping session is finished.

struct **esp\_ping\_config\_t**

Type of "ping" configuration.

### Public Members

uint32\_t **count**

A "ping" session contains count procedures

uint32\_t **interval\_ms**

Milliseconds between each ping procedure

**uint32\_t timeout\_ms**  
Timeout value (in milliseconds) of each ping procedure

**uint32\_t data\_size**  
Size of the data next to ICMP packet header

**int tos**  
Type of Service, a field specified in the IP header

**int ttl**  
Time to Live, a field specified in the IP header

**ip\_addr\_t target\_addr**  
Target IP address, either IPv4 or IPv6

**uint32\_t task\_stack\_size**  
Stack size of internal ping task

**uint32\_t task\_prio**  
Priority of internal ping task

**uint32\_t interface**  
Netif index, interface=0 means NETIF\_NO\_INDEX

### Macros

**ESP\_PING\_DEFAULT\_CONFIG ()**  
Default ping configuration.

**ESP\_PING\_COUNT\_INFINITE**  
Set ping count to zero will ping target infinitely

### Type Definitions

**typedef void \*esp\_ping\_handle\_t**  
Type of "ping" session handle.

### Enumerations

**enum esp\_ping\_profile\_t**  
Profile of ping session.

*Values:*

enumerator **ESP\_PING\_PROF\_SEQNO**  
Sequence number of a ping procedure

enumerator **ESP\_PING\_PROF\_TOS**  
Type of service of a ping procedure

- enumerator **ESP\_PING\_PROF\_TTL**  
Time to live of a ping procedure
- enumerator **ESP\_PING\_PROF\_REQUEST**  
Number of request packets sent out
- enumerator **ESP\_PING\_PROF\_REPLY**  
Number of reply packets received
- enumerator **ESP\_PING\_PROF\_IPADDR**  
IP address of replied target
- enumerator **ESP\_PING\_PROF\_SIZE**  
Size of received packet
- enumerator **ESP\_PING\_PROF\_TIMEGAP**  
Elapsed time between request and reply packet
- enumerator **ESP\_PING\_PROF\_DURATION**  
Elapsed time of the whole ping session

### 2.2.12 mDNS 服务

mDNS 是一种组播 UDP 服务，用来提供本地网络服务和主机发现。

自 v5.0 版本起，ESP-IDF 组件 mDNS 已从 ESP-IDF 中迁出至独立的仓库：

- [GitHub 上 mDNS 组件](#)

运行 `idf.py add-dependency espressif/mdns`，在项目中添加 mDNS 组件。

#### 托管的文档

请点击如下链接，查看 mDNS 的相关文档：

- [mDNS 文档](#)

### 2.2.13 Mbed TLS

[Mbed TLS](#) 是一个 C 代码库，用于实现加密基元、X.509 证书操作以及 SSL/TLS 和 DTLS 协议。该库代码占用空间小，适合嵌入式系统使用。

---

**备注：**ESP-IDF 使用的 [Mbed TLS 复刻仓库](#) 中包含对原生 Mbed TLS 的补丁。这些补丁与某些模块的硬件例程有关，如 `bignum` (MPI) 和 `ECC`。

---

Mbed TLS 提供以下功能：

- TCP/IP 通信功能：监听、连接、接收、读/写。
- SSL/TLS 通信功能：初始化、握手、读/写。
- X.509 功能：CRT、CRL 和密钥处理

- 随机数生成
- 哈希
- 加密/解密

TLS 版本支持 SSL 3.0、TLS 1.0、TLS 1.1、TLS 1.2 和 TLS 1.3，但是最新的 ESP-IDF 上 Mbed TLS 已经移除了 SSL 3.0、TLS 1.0 和 TLS 1.1。DTLS 版本支持 DTLS 1.0、DTLS 1.1 和 DTLS 1.2，但最新的 ESP-IDF 上 Mbed TLS 已经移除了 DTLS 1.0。

### Mbed TLS 文档

Mbed TLS 文档请参阅以下（上游）指针：

- [API Reference](#)
- [Knowledge Base](#)

### ESP-IDF 的 Mbed TLS 支持

请在 [此处](#) 查找 ESP-IDF 不同分支上的 Mbed TLS 版本信息。

---

**备注：** 参考 [Mbed TLS](#) 从 Mbed TLS 2.x 版本迁移到 3.0 及以上版本。

---

### 应用示例

ESP-IDF 中的示例使用 [ESP-TLS](#)，为访问常用的 TLS 功能提供了一个简化 API 接口。

参考示例 [protocols/https\\_server/simple](#)（简单的 HTTPS 服务器）和 [protocols/https\\_request](#)（发出 HTTPS 请求）了解更多信息。

如需直接使用 Mbed TLS API，请参考示例 [protocols/https\\_mbedtls](#)。

### 其他选项

[ESP-TLS](#) 是底层 SSL/TLS 库的抽象层，因此可以选择使用 Mbed TLS 或 wolfSSL 作为底层库。默认情况下，仅 Mbed TLS 可在 ESP-IDF 中使用，而 wolfSSL 在 <https://github.com/espressif/esp-wolfSSL> 公开，还提供了上游子模块指针的相关信息。

如需了解更多相关信息或比较 Mbed TLS 和 wolfSSL，请参考文档 [ESP-TLS: Underlying SSL/TLS Library Options](#)。

### 重要配置

Component Config -> mbedtls 中的部分重要配置选项如下表所示。点击 [此处](#) 获取完整配置选项列表。

- [CONFIG\\_MBEDTLS\\_SSL\\_PROTO\\_TLS1\\_2](#): 支持 TLS 1.2
- [CONFIG\\_MBEDTLS\\_SSL\\_PROTO\\_TLS1\\_3](#): 支持 TLS 1.3
- [CONFIG\\_MBEDTLS\\_CERTIFICATE\\_BUNDLE](#): 支持受信任的根证书包（更多信息请参考 [ESP x509 证书包](#)）
- [CONFIG\\_MBEDTLS\\_CLIENT\\_SSL\\_SESSION\\_TICKETS](#): 支持 TLS 会话恢复：客户端会话票证
- [CONFIG\\_MBEDTLS\\_SERVER\\_SSL\\_SESSION\\_TICKETS](#): 支持 TLS 会话恢复：服务会话票证
- [CONFIG\\_MBEDTLS\\_HARDWARE\\_SHA](#): 支持硬件 SHA 加速
- [CONFIG\\_MBEDTLS\\_HARDWARE\\_AES](#): 支持硬件 AES 加速
- [CONFIG\\_MBEDTLS\\_HARDWARE\\_MPI](#): 支持硬件 MPI (bignum) 加速
- [CONFIG\\_MBEDTLS\\_HARDWARE\\_ECC](#): 支持硬件 ECC 加速



**备注：** Mbed TLS v3.0.0 及其更新版本仅支持 TLS 1.2 和 TLS 1.3，不支持 SSL 3.0、TLS 1.0、TLS 1.1、和 DTLS 1.0)。TLS 1.3 尚在试验阶段，仅支持客户端。要了解更多信息，请点击 [此处](#)。

## 性能和内存调整

**减少内存使用** 下表展示了在不同配置下，用 Mbed TLS 作为 SSL/TLS 库运行示例 [protocols/https\\_request](#) (启用服务器验证) 时，内存的实际使用情况。

Mbed TLS 测试	相关配置	堆使用 (近似)
默认	NA	42196 B
启用 SSL 动态 buffer 长度	<a href="#">CONFIG_MBEDTLS_SSL_VARIABLE_BUFFER_LENGTH</a>	42120 B
禁用保留对端证书	<a href="#">CONFIG_MBEDTLS_SSL_KEEP_PEER_CERTIFICATE</a>	38533 B
启用动态 buffer 功能	<a href="#">CONFIG_MBEDTLS_DYNAMIC_BUFFER</a> <a href="#">CON- FIG_MBEDTLS_DYNAMIC_FREE_CONFIG_DATA</a> <a href="#">CONFIG_MBEDTLS_DYNAMIC_FREE_CA_CERT</a>	22013 B

**备注：** 这些值会随着配置选项和 Mbed TLS 版本的变化而变化。

**减小固件大小** 在 Component Config -> mbedTLS 中，有多个 Mbed TLS 功能默认为启用状态。如不需要这些功能，可将其禁用以减小固件大小。要了解更多信息，请参考 [Minimizing Binary Size](#) 文档。

此 API 部分的示例代码存放在 ESP-IDF 示例项目的 [protocols](#) 目录下。

## 2.2.14 IP 网络层协议

IP 网络层协议 (应用层协议之下) 的文档存放在 [连网 API](#) 目录下。

## 2.3 蓝牙 API

### 2.3.1 Bluetooth® Common

#### Bluetooth® Generic Defines

#### API Reference

#### Header File

- [components/bt/host/bluedroid/api/include/api/esp\\_bt\\_defs.h](#)
- This header file can be included with:

```
#include "esp_bt_defs.h"
```

- This header file is a part of the API provided by the `bt` component. To declare that your component depends on `bt`, add the following to your `CMakeLists.txt`:

```
REQUIRES bt
```

or

```
PRIV_REQUIRES bt
```

## Structures

struct **esp\_bt\_uuid\_t**

UUID type.

### Public Members

uint16\_t **len**

UUID length, 16bit, 32bit or 128bit

uint16\_t **uuid16**

16bit UUID

uint32\_t **uuid32**

32bit UUID

uint8\_t **uuid128**[ESP\_UUID\_LEN\_128]

128bit UUID

union *esp\_bt\_uuid\_t*::[anonymous] **uuid**

UUID

## Macros

**ESP\_BLUEDROID\_STATUS\_CHECK** (status)

**ESP\_BT\_STATUS\_BASE\_FOR\_HCI\_ERR**

**ESP\_BT\_OCTET16\_LEN**

**ESP\_BT\_OCTET8\_LEN**

**ESP\_DEFAULT\_GATT\_IF**

Default GATT interface id.

**ESP\_BLE\_PRIM\_ADV\_INT\_MIN**

Minimum advertising interval for undirected and low duty cycle directed advertising

**ESP\_BLE\_PRIM\_ADV\_INT\_MAX**

Maximum advertising interval for undirected and low duty cycle directed advertising

**ESP\_BLE\_CONN\_INT\_MIN**

relate to BTM\_BLE\_CONN\_INT\_MIN in stack/btm\_ble\_api.h

**ESP\_BLE\_CONN\_INT\_MAX**

relate to BTM\_BLE\_CONN\_INT\_MAX in stack/btm\_ble\_api.h

**ESP\_BLE\_CONN\_LATENCY\_MAX**

relate to ESP\_BLE\_CONN\_LATENCY\_MAX in stack/btm\_ble\_api.h

**ESP\_BLE\_CONN\_SUP\_TOUT\_MIN**

relate to BTM\_BLE\_CONN\_SUP\_TOUT\_MIN in stack/btm\_ble\_api.h

**ESP\_BLE\_CONN\_SUP\_TOUT\_MAX**

relate to ESP\_BLE\_CONN\_SUP\_TOUT\_MAX in stack/btm\_ble\_api.h

**ESP\_BLE\_IS\_VALID\_PARAM** (x, min, max)

Check the param is valid or not.

**ESP\_UUID\_LEN\_16**

**ESP\_UUID\_LEN\_32**

**ESP\_UUID\_LEN\_128**

**ESP\_BD\_ADDR\_LEN**

Bluetooth address length.

**ESP\_PEER\_IRK\_LEN**

Bluetooth peer irk.

**ESP\_BLE\_ENC\_KEY\_MASK**

Used to exchange the encryption key in the init key & response key.

**ESP\_BLE\_ID\_KEY\_MASK**

Used to exchange the IRK key in the init key & response key.

**ESP\_BLE\_CSR\_KEY\_MASK**

Used to exchange the CSRK key in the init key & response key.

**ESP\_BLE\_LINK\_KEY\_MASK**

Used to exchange the link key(this key just used in the BLE & BR/EDR coexist mode) in the init key & response key.

**ESP\_APP\_ID\_MIN**

Minimum of the application id.

**ESP\_APP\_ID\_MAX**

Maximum of the application id.

**ESP\_BD\_ADDR\_STR**

**ESP\_BD\_ADDR\_HEX** (addr)

### Type Definitions

```
typedef uint8_t esp_bt_octet16_t[ESP_BT_OCTET16_LEN]
```

```
typedef uint8_t esp_bt_octet8_t[ESP_BT_OCTET8_LEN]
```

```
typedef uint8_t esp_link_key[ESP_BT_OCTET16_LEN]
```

```
typedef uint8_t esp_bd_addr_t[ESP_BT_ADDR_LEN]
```

Bluetooth device address.

```
typedef uint8_t esp_ble_key_mask_t
```

### Enumerations

```
enum esp_bt_status_t
```

Status Return Value.

*Values:*

```
enumerator ESP_BT_STATUS_SUCCESS
```

```
enumerator ESP_BT_STATUS_FAIL
```

```
enumerator ESP_BT_STATUS_NOT_READY
```

```
enumerator ESP_BT_STATUS_NOMEM
```

```
enumerator ESP_BT_STATUS_BUSY
```

```
enumerator ESP_BT_STATUS_DONE
```

```
enumerator ESP_BT_STATUS_UNSUPPORTED
```

```
enumerator ESP_BT_STATUS_PARM_INVALID
```

```
enumerator ESP_BT_STATUS_UNHANDLED
```

```
enumerator ESP_BT_STATUS_AUTH_FAILURE
```

```
enumerator ESP_BT_STATUS_RMT_DEV_DOWN
```

```
enumerator ESP_BT_STATUS_AUTH_REJECTED
```

```
enumerator ESP_BT_STATUS_INVALID_STATIC_RAND_ADDR
```

```
enumerator ESP_BT_STATUS_PENDING
```

enumerator **ESP\_BT\_STATUS\_UNACCEPT\_CONN\_INTERVAL**

enumerator **ESP\_BT\_STATUS\_PARAM\_OUT\_OF\_RANGE**

enumerator **ESP\_BT\_STATUS\_TIMEOUT**

enumerator **ESP\_BT\_STATUS\_PEER\_LE\_DATA\_LEN\_UNSUPPORTED**

enumerator **ESP\_BT\_STATUS\_CONTROL\_LE\_DATA\_LEN\_UNSUPPORTED**

enumerator **ESP\_BT\_STATUS\_ERR\_ILLEGAL\_PARAMETER\_FMT**

enumerator **ESP\_BT\_STATUS\_MEMORY\_FULL**

enumerator **ESP\_BT\_STATUS\_EIR\_TOO\_LARGE**

enumerator **ESP\_BT\_STATUS\_HCI\_SUCCESS**

enumerator **ESP\_BT\_STATUS\_HCI\_ILLEGAL\_COMMAND**

enumerator **ESP\_BT\_STATUS\_HCI\_NO\_CONNECTION**

enumerator **ESP\_BT\_STATUS\_HCI\_HW\_FAILURE**

enumerator **ESP\_BT\_STATUS\_HCI\_PAGE\_TIMEOUT**

enumerator **ESP\_BT\_STATUS\_HCI\_AUTH\_FAILURE**

enumerator **ESP\_BT\_STATUS\_HCI\_KEY\_MISSING**

enumerator **ESP\_BT\_STATUS\_HCI\_MEMORY\_FULL**

enumerator **ESP\_BT\_STATUS\_HCI\_CONNECTION\_TOUT**

enumerator **ESP\_BT\_STATUS\_HCI\_MAX\_NUM\_OF\_CONNECTIONS**

enumerator **ESP\_BT\_STATUS\_HCI\_MAX\_NUM\_OF\_SCOS**

enumerator **ESP\_BT\_STATUS\_HCI\_CONNECTION\_EXISTS**

enumerator **ESP\_BT\_STATUS\_HCI\_COMMAND\_DISALLOWED**

enumerator **ESP\_BT\_STATUS\_HCI\_HOST\_REJECT\_RESOURCES**

enumerator **ESP\_BT\_STATUS\_HCI\_HOST\_REJECT\_SECURITY**

enumerator **ESP\_BT\_STATUS\_HCI\_HOST\_REJECT\_DEVICE**

enumerator **ESP\_BT\_STATUS\_HCI\_HOST\_TIMEOUT**

enumerator **ESP\_BT\_STATUS\_HCI\_UNSUPPORTED\_VALUE**

enumerator **ESP\_BT\_STATUS\_HCI\_ILLEGAL\_PARAMETER\_FMT**

enumerator **ESP\_BT\_STATUS\_HCI\_PEER\_USER**

enumerator **ESP\_BT\_STATUS\_HCI\_PEER\_LOW\_RESOURCES**

enumerator **ESP\_BT\_STATUS\_HCI\_PEER\_POWER\_OFF**

enumerator **ESP\_BT\_STATUS\_HCI\_CONN\_CAUSE\_LOCAL\_HOST**

enumerator **ESP\_BT\_STATUS\_HCI\_REPEATED\_ATTEMPTS**

enumerator **ESP\_BT\_STATUS\_HCI\_PAIRING\_NOT\_ALLOWED**

enumerator **ESP\_BT\_STATUS\_HCI\_UNKNOWN\_LMP\_PDU**

enumerator **ESP\_BT\_STATUS\_HCI\_UNSUPPORTED\_REM\_FEATURE**

enumerator **ESP\_BT\_STATUS\_HCI\_SCO\_OFFSET\_REJECTED**

enumerator **ESP\_BT\_STATUS\_HCI\_SCO\_INTERVAL\_REJECTED**

enumerator **ESP\_BT\_STATUS\_HCI\_SCO\_AIR\_MODE**

enumerator **ESP\_BT\_STATUS\_HCI\_INVALID\_LMP\_PARAM**

enumerator **ESP\_BT\_STATUS\_HCI\_UNSPECIFIED**

enumerator **ESP\_BT\_STATUS\_HCI\_UNSUPPORTED\_LMP\_PARAMETERS**

enumerator **ESP\_BT\_STATUS\_HCI\_ROLE\_CHANGE\_NOT\_ALLOWED**

enumerator **ESP\_BT\_STATUS\_HCI\_LMP\_RESPONSE\_TIMEOUT**

enumerator **ESP\_BT\_STATUS\_HCI\_LMP\_ERR\_TRANS\_COLLISION**

enumerator **ESP\_BT\_STATUS\_HCI\_LMP\_PDU\_NOT\_ALLOWED**

enumerator **ESP\_BT\_STATUS\_HCI\_ENCRY\_MODE\_NOT\_ACCEPTABLE**

enumerator **ESP\_BT\_STATUS\_HCI\_UNIT\_KEY\_USED**

enumerator **ESP\_BT\_STATUS\_HCI\_QOS\_NOT\_SUPPORTED**

enumerator **ESP\_BT\_STATUS\_HCI\_INSTANT\_PASSED**

enumerator **ESP\_BT\_STATUS\_HCI\_PAIRING\_WITH\_UNIT\_KEY\_NOT\_SUPPORTED**

enumerator **ESP\_BT\_STATUS\_HCI\_DIFF\_TRANSACTION\_COLLISION**

enumerator **ESP\_BT\_STATUS\_HCI\_UNDEFINED\_0x2B**

enumerator **ESP\_BT\_STATUS\_HCI\_QOS\_UNACCEPTABLE\_PARAM**

enumerator **ESP\_BT\_STATUS\_HCI\_QOS\_REJECTED**

enumerator **ESP\_BT\_STATUS\_HCI\_CHAN\_CLASSIF\_NOT\_SUPPORTED**

enumerator **ESP\_BT\_STATUS\_HCI\_INSUFFICIENT\_SECURITY**

enumerator **ESP\_BT\_STATUS\_HCI\_PARAM\_OUT\_OF\_RANGE**

enumerator **ESP\_BT\_STATUS\_HCI\_UNDEFINED\_0x31**

enumerator **ESP\_BT\_STATUS\_HCI\_ROLE\_SWITCH\_PENDING**

enumerator **ESP\_BT\_STATUS\_HCI\_UNDEFINED\_0x33**

enumerator **ESP\_BT\_STATUS\_HCI\_RESERVED\_SLOT\_VIOLATION**

enumerator **ESP\_BT\_STATUS\_HCI\_ROLE\_SWITCH\_FAILED**

enumerator **ESP\_BT\_STATUS\_HCI\_INQ\_RSP\_DATA\_TOO\_LARGE**

enumerator **ESP\_BT\_STATUS\_HCI\_SIMPLE\_PAIRING\_NOT\_SUPPORTED**

enumerator **ESP\_BT\_STATUS\_HCI\_HOST\_BUSY\_PAIRING**

enumerator **ESP\_BT\_STATUS\_HCI\_REJ\_NO\_SUITABLE\_CHANNEL**

enumerator **ESP\_BT\_STATUS\_HCI\_CONTROLLER\_BUSY**

enumerator **ESP\_BT\_STATUS\_HCI\_UNACCEPT\_CONN\_INTERVAL**

enumerator **ESP\_BT\_STATUS\_HCI\_DIRECTED\_ADVERTISING\_TIMEOUT**

enumerator **ESP\_BT\_STATUS\_HCI\_CONN\_TOUT\_DUE\_TO\_MIC\_FAILURE**

enumerator **ESP\_BT\_STATUS\_HCI\_CONN\_FAILED\_ESTABLISHMENT**

enumerator **ESP\_BT\_STATUS\_HCI\_MAC\_CONNECTION\_FAILED**

enum **esp\_bt\_dev\_type\_t**

Bluetooth device type.

*Values:*

enumerator **ESP\_BT\_DEVICE\_TYPE\_BREDR**

enumerator **ESP\_BT\_DEVICE\_TYPE\_BLE**

enumerator **ESP\_BT\_DEVICE\_TYPE\_DUMO**

enum **esp\_ble\_addr\_type\_t**

BLE device address type.

*Values:*

enumerator **BLE\_ADDR\_TYPE\_PUBLIC**

Public Device Address

enumerator **BLE\_ADDR\_TYPE\_RANDOM**

Random Device Address. To set this address, use the function `esp_ble_gap_set_rand_addr(esp_bd_addr_t rand_addr)`

enumerator **BLE\_ADDR\_TYPE\_RPA\_PUBLIC**

Resolvable Private Address (RPA) with public identity address

enumerator **BLE\_ADDR\_TYPE\_RPA\_RANDOM**

Resolvable Private Address (RPA) with random identity address. To set this address, use the function `esp_ble_gap_set_rand_addr(esp_bd_addr_t rand_addr)`

enum **esp\_ble\_wl\_addr\_type\_t**

white list address type

*Values:*

enumerator **BLE\_WL\_ADDR\_TYPE\_PUBLIC**

enumerator **BLE\_WL\_ADDR\_TYPE\_RANDOM**

## Bluetooth® Main API

### API Reference



## Header File

- `components/bt/host/bluedroid/api/include/api/esp_bt_main.h`
- This header file can be included with:

```
#include "esp_bt_main.h"
```

- This header file is a part of the API provided by the `bt` component. To declare that your component depends on `bt`, add the following to your `CMakeLists.txt`:

```
REQUIRES bt
```

or

```
PRIV_REQUIRES bt
```

## Functions

*esp\_bt\_status\_t* **esp\_bt\_status\_get** (void)

Get bluetooth stack status.

返回 Bluetooth stack status

*esp\_err\_t* **esp\_bt\_enable** (void)

Enable bluetooth, must after `esp_bt_init()/esp_bt_init_with_cfg()`.

返回

- `ESP_OK` : Succeed
- Other : Failed

*esp\_err\_t* **esp\_bt\_disable** (void)

Disable Bluetooth, must be called prior to `esp_bt_deinit()`.

---

**备注:** Before calling this API, ensure that all activities related to the application, such as connections, scans, etc., are properly closed.

---

返回

- `ESP_OK` : Succeed
- Other : Failed

*esp\_err\_t* **esp\_bt\_init** (void)

Init and alloc the resource for bluetooth, must be prior to every bluetooth stuff.

返回

- `ESP_OK` : Succeed
- Other : Failed

*esp\_err\_t* **esp\_bt\_init\_with\_cfg** (*esp\_bt\_config\_t* \*cfg)

Init and alloc the resource for bluetooth, must be prior to every bluetooth stuff.

参数 **cfg** -- Initial configuration of ESP Bluetooth stack.

返回

- `ESP_OK` : Succeed
- Other : Failed

*esp\_err\_t* **esp\_bt\_deinit** (void)

Deinit and free the resource for bluetooth, must be after every bluetooth stuff.

返回

- `ESP_OK` : Succeed
- Other : Failed

## Structures

struct **esp\_bluedroid\_config\_t**

Bluetooth stack configuration.

## Public Members

bool **ssp\_en**

Whether SSP(secure simple pairing) or legacy pairing is used for Classic Bluetooth

## Macros

**BT\_BLUEDROID\_INIT\_CONFIG\_DEFAULT** ()

## Enumerations

enum **esp\_bluedroid\_status\_t**

Bluetooth stack status type, to indicate whether the bluetooth stack is ready.

*Values:*

enumerator **ESP\_BLUEDROID\_STATUS\_UNINITIALIZED**

Bluetooth not initialized

enumerator **ESP\_BLUEDROID\_STATUS\_INITIALIZED**

Bluetooth initialized but not enabled

enumerator **ESP\_BLUEDROID\_STATUS\_ENABLED**

Bluetooth initialized and enabled

## Bluetooth® Device APIs

**Overview** Bluetooth device reference APIs.

## API Reference

### Header File

- [components/bt/host/bluedroid/api/include/api/esp\\_bt\\_device.h](#)
- This header file can be included with:

```
#include "esp_bt_device.h"
```

- This header file is a part of the API provided by the `bt` component. To declare that your component depends on `bt`, add the following to your `CMakeLists.txt`:

```
REQUIRES bt
```

or

```
PRIV_REQUIRES bt
```

**Functions**

***esp\_err\_t* esp\_bt\_dev\_register\_callback** (*esp\_bt\_dev\_cb\_t* callback)

register callback function. This function should be called after `esp_bluedroid_enable()` completes successfully

返回

- ESP\_OK : Succeed
- ESP\_FAIL: others

**const uint8\_t \*esp\_bt\_dev\_get\_address** (void)

Get bluetooth device address. Must use after "esp\_bluedroid\_enable".

返回 bluetooth device address (six bytes), or NULL if bluetooth stack is not enabled

***esp\_err\_t* esp\_bt\_dev\_set\_device\_name** (const char \*name)

Set bluetooth device name. This function should be called after `esp_bluedroid_enable()` completes successfully.

A BR/EDR/LE device type shall have a single Bluetooth device name which shall be identical irrespective of the physical channel used to perform the name discovery procedure.

参数 **name** -- [in] : device name to be set

返回

- ESP\_OK : Succeed
- ESP\_ERR\_INVALID\_ARG : if name is NULL pointer or empty, or string length out of limit
- ESP\_ERR\_INVALID\_STATE : if bluetooth stack is not yet enabled
- ESP\_FAIL : others

***esp\_err\_t* esp\_bt\_dev\_get\_device\_name** (void)

Get bluetooth device name. This function should be called after `esp_bluedroid_enable()` completes successfully.

A BR/EDR/LE device type shall have a single Bluetooth device name which shall be identical irrespective of the physical channel used to perform the name discovery procedure.

返回

- ESP\_OK : Succeed
- ESP\_ERR\_INVALID\_STATE : if bluetooth stack is not yet enabled
- ESP\_FAIL : others

***esp\_err\_t* esp\_bt\_dev\_coex\_status\_config** (*esp\_bt\_dev\_coex\_type\_t* type, *esp\_bt\_dev\_coex\_op\_t* op, uint8\_t status)

Config bluetooth device coexis status. This function should be called after `esp_bluedroid_enable()` completes successfully.

参数

- **type** -- [in] : coexist type to operate on
- **op** -- [in] : clear or set coexist status
- **status** -- [in] : coexist status to be configured

返回

- ESP\_OK : Succeed
- ESP\_ERR\_INVALID\_ARG : if name is NULL pointer or empty, or string length out of limit
- ESP\_ERR\_INVALID\_STATE : if bluetooth stack is not yet enabled
- ESP\_FAIL : others

***esp\_err\_t* esp\_bt\_config\_file\_path\_update** (const char \*file\_path)

This function is used to update the path name of bluetooth bond keys saved in the NVS module and need to be called before `esp_bluedroid_init()`.

参数 **file\_path** -- [in] the name of config file path, the length of file\_path should be less than NVS\_NS\_NAME\_MAX\_SIZE

返回

- ESP\_OK: success
- other: failed

## Unions

union **esp\_bt\_dev\_cb\_param\_t**  
*#include <esp\_bt\_device.h>* BT device callback parameters.

### Public Members

struct *esp\_bt\_dev\_cb\_param\_t::name\_res\_param* **name\_res**  
discovery result parameter struct

struct **name\_res\_param**  
*#include <esp\_bt\_device.h>* ESP\_BT\_DEV\_NAME\_RES\_EVT.

### Public Members

*esp\_bt\_status\_t* **status**  
Status of getting device name

char \***name**  
Name of Bluetooth device

## Macros

**ESP\_BT\_DEV\_COEX\_BLE\_ST\_MESH\_CONFIG**

**ESP\_BT\_DEV\_COEX\_BLE\_ST\_MESH\_TRAFFIC**

**ESP\_BT\_DEV\_COEX\_BLE\_ST\_MESH\_STANDBY**

**ESP\_BT\_DEV\_COEX\_BT\_ST\_A2DP\_STREAMING**

**ESP\_BT\_DEV\_COEX\_BT\_ST\_A2DP\_PAUSED**

**ESP\_BT\_DEV\_COEX\_OP\_CLEAR**

**ESP\_BT\_DEV\_COEX\_OP\_SET**

## Type Definitions

typedef uint8\_t **esp\_bt\_dev\_coex\_op\_t**

typedef void (\***esp\_bt\_dev\_cb\_t**)(*esp\_bt\_dev\_cb\_event\_t* event, *esp\_bt\_dev\_cb\_param\_t* \*param)  
bluetooth device callback function type

**Param event** : Event type

**Param param** : Pointer to callback parameter

## Enumerations

enum **esp\_bt\_dev\_coex\_type\_t**

Bluetooth device coex type.

*Values:*

enumerator **ESP\_BT\_DEV\_COEX\_TYPE\_BLE**

enumerator **ESP\_BT\_DEV\_COEX\_TYPE\_BT**

enum **esp\_bt\_dev\_cb\_event\_t**

BT device callback events.

*Values:*

enumerator **ESP\_BT\_DEV\_NAME\_RES\_EVT**

Device name result event

enumerator **ESP\_BT\_DEV\_EVT\_MAX**

## 2.3.2 Bluetooth® Low Energy (Bluetooth LE)

### GAP API

**应用示例** 以下示例及其教程存放在 ESP-IDF 项目示例的 [bluetooth/bluedroid/ble](#) 目录下。

- 以下为 SMP（安全管理协议）安全客户端示例及教程。该示例程序会初始化其安全参数，并充当 GATT 客户端，可向对端设备发送安全请求，完成加密过程。
  - [bluetooth/bluedroid/ble/gatt\\_security\\_client](#)
  - [GATT 安全客户端示例演示](#)
- 以下为 SMP 安全服务器示例及其教程。该示例程序会初始化其安全参数，并充当 GATT 客户端，可向对端设备发送配对请求，完成加密过程。
  - [bluetooth/bluedroid/ble/gatt\\_security\\_server](#)
  - [GATT 安全服务器示例演示](#)

### API 参考

#### Header File

- [components/bt/host/bluedroid/api/include/api/esp\\_gap\\_ble\\_api.h](#)
- This header file can be included with:

```
#include "esp_gap_ble_api.h"
```

- This header file is a part of the API provided by the `bt` component. To declare that your component depends on `bt`, add the following to your `CMakeLists.txt`:

```
REQUIRES bt
```

or

```
PRIV_REQUIRES bt
```

**Functions**

*esp\_err\_t* **esp\_ble\_gap\_register\_callback** (*esp\_gap\_ble\_cb\_t* callback)

This function is called to occur gap event, such as scan result.

**参数** **callback** -- [in] callback function

**返回**

- ESP\_OK : success
- other : failed

*esp\_gap\_ble\_cb\_t* **esp\_ble\_gap\_get\_callback** (void)

This function is called to get the current gap callback.

**返回**

- esp\_gap\_ble\_cb\_t : callback function

*esp\_err\_t* **esp\_ble\_gap\_config\_adv\_data** (*esp\_ble\_adv\_data\_t* \*adv\_data)

This function is called to override the BTA default ADV parameters.

**参数** **adv\_data** -- [in] Pointer to User defined ADV data structure. This memory space can not be freed until callback of config\_adv\_data is received.

**返回**

- ESP\_OK : success
- other : failed

*esp\_err\_t* **esp\_ble\_gap\_set\_scan\_params** (*esp\_ble\_scan\_params\_t* \*scan\_params)

This function is called to set scan parameters.

**参数** **scan\_params** -- [in] Pointer to User defined scan\_params data structure. This memory space can not be freed until callback of set\_scan\_params

**返回**

- ESP\_OK : success
- other : failed

*esp\_err\_t* **esp\_ble\_gap\_start\_scanning** (uint32\_t duration)

This procedure keep the device scanning the peer device which advertising on the air.

**参数** **duration** -- [in] Keeping the scanning time, the unit is second.

**返回**

- ESP\_OK : success
- other : failed

*esp\_err\_t* **esp\_ble\_gap\_stop\_scanning** (void)

This function call to stop the device scanning the peer device which advertising on the air.

**返回**

- ESP\_OK : success
- other : failed

*esp\_err\_t* **esp\_ble\_gap\_start\_advertising** (*esp\_ble\_adv\_params\_t* \*adv\_params)

This function is called to start advertising.

**参数** **adv\_params** -- [in] pointer to User defined adv\_params data structure.

**返回**

- ESP\_OK : success
- other : failed

*esp\_err\_t* **esp\_ble\_gap\_stop\_advertising** (void)

This function is called to stop advertising.

**返回**

- ESP\_OK : success
- other : failed

`esp_err_t esp_ble_gap_update_conn_params (esp_ble_conn_update_params_t *params)`

Update connection parameters, can only be used when connection is up.

**参数** `params` -- **[in]** - connection update parameters

**返回**

- ESP\_OK : success
- other : failed

`esp_err_t esp_ble_gap_set_pkt_data_len (esp_bd_addr_t remote_device, uint16_t tx_data_length)`

This function is to set maximum LE data packet size.

**返回**

- ESP\_OK : success
- other : failed

`esp_err_t esp_ble_gap_set_rand_addr (esp_bd_addr_t rand_addr)`

This function allows configuring either a Non-Resolvable Private Address or a Static Random Address.

**参数** `rand_addr` -- **[in]** The address to be configured. Refer to the table below for possible address subtypes:

address [47:46]	Address Type	
↔Corresponding API		
↔----- ----- ----- -----		
↔             0b00    Non-Resolvable Private		esp_
↔ble_gap_addr_create_nrpa	Address (NRPA)	
↔           ----- ----- ----- -----		
↔             0b11    Static Random Address		esp_
↔ble_gap_addr_create_static		
↔----- ----- ----- -----		

**返回**

- ESP\_OK : success
- other : failed

`esp_err_t esp_ble_gap_addr_create_static (esp_bd_addr_t rand_addr)`

Create a static device address.

**参数** `rand_addr` -- **[out]** Pointer to the buffer where the static device address will be stored.

**返回** - ESP\_OK : Success

- Other : Failed

`esp_err_t esp_ble_gap_addr_create_nrpa (esp_bd_addr_t rand_addr)`

Create a non-resolvable private address (NRPA)

**参数** `rand_addr` -- **[out]** Pointer to the buffer where the NRPA will be stored.

**返回** - ESP\_OK : Success

- Other : Failed

`esp_err_t esp_ble_gap_set_resolvable_private_address_timeout (uint16_t rpa_timeout)`

This function sets the length of time the Controller uses a Resolvable Private Address before generating and starting to use a new resolvable private address.

---

**备注:** Note: This function is currently not supported on the ESP32 but will be enabled in a future update.

---

**参数** `rpa_timeout` -- **[in]** The timeout duration in seconds for how long a Resolvable Private Address is used before a new one is generated. The value must be within the range specified

by the Bluetooth specification (0x0001 to 0x0E10), which corresponds to a time range of 1 second to 1 hour. The default value is 0x0384 (900 seconds or 15 minutes).

#### 返回

- ESP\_OK : success
- other : failed

*esp\_err\_t* **esp\_ble\_gap\_add\_device\_to\_resolving\_list** (*esp\_bd\_addr\_t* peer\_addr, uint8\_t addr\_type, uint8\_t \*peer\_irk)

This function adds a device to the resolving list used to generate and resolve Resolvable Private Addresses in the Controller.

---

**备注:** Note: This function shall not be used when address resolution is enabled in the Controller and:

- Advertising (other than periodic advertising) is enabled,
  - Scanning is enabled, or
  - an HCI\_LE\_Create\_Connection, HCI\_LE\_Extended\_Create\_Connection, or HCI\_LE\_Periodic\_Advertising\_Create\_Sync command is pending. This command may be used at any time when address resolution is disabled in the Controller. The added device shall be set to Network Privacy mode.
- 

#### 参数

- **peer\_addr** -- [in] The peer identity address of the device to be added to the resolving list.
- **addr\_type** -- [in] The address type of the peer identity address (BLE\_ADDR\_TYPE\_PUBLIC or BLE\_ADDR\_TYPE\_RANDOM).
- **peer\_irk** -- [in] The Identity Resolving Key (IRK) of the device.

#### 返回

- ESP\_OK : success
- other : failed

*esp\_err\_t* **esp\_ble\_gap\_clear\_rand\_addr** (void)

This function clears the random address for the application.

#### 返回

- ESP\_OK : success
- other : failed

*esp\_err\_t* **esp\_ble\_gap\_config\_local\_privacy** (bool privacy\_enable)

Enable/disable privacy (including address resolution) on the local device.

**参数** **privacy\_enable** -- [in] - enable/disable privacy on remote device.

#### 返回

- ESP\_OK : success
- other : failed

*esp\_err\_t* **esp\_ble\_gap\_config\_local\_icon** (uint16\_t icon)

set local gap appearance icon

**参数** **icon** -- [in] - External appearance value, these values are defined by the Bluetooth SIG, please refer to <https://www.bluetooth.com/specifications/assigned-numbers/>

#### 返回

- ESP\_OK : success
- other : failed

*esp\_err\_t* **esp\_ble\_gap\_update\_whitelist** (bool add\_remove, *esp\_bd\_addr\_t* remote\_bda, *esp\_ble\_wl\_addr\_type\_t* wl\_addr\_type)

Add or remove device from white list.

#### 参数



- **add\_remove** -- **[in]** the value is true if added the ble device to the white list, and false remove to the white list.
- **remote\_bda** -- **[in]** the remote device address add/remove from the white list.
- **wl\_addr\_type** -- **[in]** whitelist address type

**返回**

- ESP\_OK : success
- other : failed

*esp\_err\_t* **esp\_ble\_gap\_clear\_whitelist** (void)

Clear all white list.

**返回**

- ESP\_OK : success
- other : failed

*esp\_err\_t* **esp\_ble\_gap\_get\_whitelist\_size** (uint16\_t \*length)

Get the whitelist size in the controller.

**参数** **length** -- **[out]** the white list length.

**返回**

- ESP\_OK : success
- other : failed

*esp\_err\_t* **esp\_ble\_gap\_set\_prefer\_conn\_params** (*esp\_bd\_addr\_t* bd\_addr, uint16\_t min\_conn\_int, uint16\_t max\_conn\_int, uint16\_t slave\_latency, uint16\_t supervision\_tout)

This function is called to set the preferred connection parameters when default connection parameter is not desired before connecting. This API can only be used in the master role.

**参数**

- **bd\_addr** -- **[in]** BD address of the peripheral
- **min\_conn\_int** -- **[in]** minimum preferred connection interval
- **max\_conn\_int** -- **[in]** maximum preferred connection interval
- **slave\_latency** -- **[in]** preferred slave latency
- **supervision\_tout** -- **[in]** preferred supervision timeout

**返回**

- ESP\_OK : success
- other : failed

*esp\_err\_t* **esp\_ble\_gap\_set\_device\_name** (const char \*name)

Set device name to the local device Note: This API don't affect the advertising data.

**参数** **name** -- **[in]** - device name.

**返回**

- ESP\_OK : success
- other : failed

*esp\_err\_t* **esp\_ble\_gap\_get\_device\_name** (void)

Get device name of the local device.

**返回**

- ESP\_OK : success
- other : failed

*esp\_err\_t* **esp\_ble\_gap\_get\_local\_used\_addr** (*esp\_bd\_addr\_t* local\_used\_addr, uint8\_t \*addr\_type)

This function is called to get local used address and address type. uint8\_t \*esp\_bt\_dev\_get\_address(void) get the public address.

**参数**

- **local\_used\_addr** -- **[in]** - current local used ble address (six bytes)
- **addr\_type** -- **[in]** - ble address type

**返回** - ESP\_OK : success

- other : failed

`uint8_t *esp_ble_resolve_adv_data (uint8_t *adv_data, uint8_t type, uint8_t *length)`

This function is called to get ADV data for a specific type.

#### 参数

- **adv\_data** -- [in] - pointer of ADV data which to be resolved
- **type** -- [in] - finding ADV data type
- **length** -- [out] - return the length of ADV data not including type

返回 pointer of ADV data

`esp_err_t esp_ble_gap_config_adv_data_raw (uint8_t *raw_data, uint32_t raw_data_len)`

This function is called to set raw advertising data. User need to fill ADV data by self.

#### 参数

- **raw\_data** -- [in] : raw advertising data with the format: [Length 1][Data Type 1][Data 1][Length 2][Data Type 2][Data 2] ...
- **raw\_data\_len** -- [in] : raw advertising data length , less than 31 bytes

#### 返回

- ESP\_OK : success
- other : failed

`esp_err_t esp_ble_gap_config_scan_rsp_data_raw (uint8_t *raw_data, uint32_t raw_data_len)`

This function is called to set raw scan response data. User need to fill scan response data by self.

#### 参数

- **raw\_data** -- [in] : raw scan response data
- **raw\_data\_len** -- [in] : raw scan response data length , less than 31 bytes

#### 返回

- ESP\_OK : success
- other : failed

`esp_err_t esp_ble_gap_read_rssi (esp_bd_addr_t remote_addr)`

This function is called to read the RSSI of remote device. The address of link policy results are returned in the gap callback function with ESP\_GAP\_BLE\_READ\_RSSI\_COMPLETE\_EVT event.

参数 **remote\_addr** -- [in] : The remote connection device address.

#### 返回

- ESP\_OK : success
- other : failed

`esp_err_t esp_ble_gap_add_duplicate_scan_exceptional_device (esp_ble_duplicate_exceptional_info_type_t type, esp_duplicate_info_t device_info)`

This function is called to add a device info into the duplicate scan exceptional list.

#### 参数

- **type** -- [in] device info type, it is defined in `esp_ble_duplicate_exceptional_info_type_t` when type is MESH\_BEACON\_TYPE, MESH\_PROV\_SRV\_ADV or MESH\_PROXY\_SRV\_ADV , device\_info is invalid.
- **device\_info** -- [in] the device information.

#### 返回

- ESP\_OK : success
- other : failed

`esp_err_t esp_ble_gap_remove_duplicate_scan_exceptional_device (esp_ble_duplicate_exceptional_info_type_t type, esp_duplicate_info_t device_info)`

This function is called to remove a device info from the duplicate scan exceptional list.

#### 参数

- **type** -- **[in]** device info type, it is defined in `esp_ble_duplicate_exceptional_info_type_t` when type is `MESH_BEACON_TYPE`, `MESH_PROV_SRV_ADV` or `MESH_PROXY_SRV_ADV`, device\_info is invalid.
- **device\_info** -- **[in]** the device information.

**返回**

- `ESP_OK` : success
- other : failed

*esp\_err\_t* **esp\_ble\_gap\_clean\_duplicate\_scan\_exceptional\_list** (*esp\_duplicate\_scan\_exceptional\_list\_type\_t* list\_type)

This function is called to clean the duplicate scan exceptional list. This API will delete all device information in the duplicate scan exceptional list.

**参数** **list\_type** -- **[in]** duplicate scan exceptional list type, the value can be one or more of `esp_duplicate_scan_exceptional_list_type_t`.

**返回**

- `ESP_OK` : success
- other : failed

*esp\_err\_t* **esp\_ble\_gap\_set\_security\_param** (*esp\_ble\_sm\_param\_t* param\_type, void \*value, uint8\_t len)

Set a GAP security parameter value. Overrides the default value.

Secure connection is highly recommended to avoid some major vulnerabilities like 'Impersonation in the Pin Pairing Protocol' (CVE-2020-26555) and 'Authentication of the LE Legacy Pairing Protocol'.

To accept only `secure connection mode`, it is necessary do as following:

1. Set bit `ESP\_LE\_AUTH\_REQ\_SC\_ONLY` (`param\_type` is `ESP\_BLE\_SM\_AUTHEN\_REQ\_MODE`), bit `ESP\_LE\_AUTH\_BOND` and bit `ESP\_LE\_AUTH\_REQ\_MITM` is optional as required.
2. Set to `ESP\_BLE\_ONLY\_ACCEPT\_SPECIFIED\_AUTH\_ENABLE` (`param\_type` is `ESP\_BLE\_SM\_ONLY\_ACCEPT\_SPECIFIED\_SEC\_AUTH`).

**参数**

- **param\_type** -- **[in]** : the type of the param which to be set
- **value** -- **[in]** : the param value
- **len** -- **[in]** : the length of the param value

**返回** - `ESP_OK` : success

- other : failed

*esp\_err\_t* **esp\_ble\_gap\_security\_rsp** (*esp\_bd\_addr\_t* bd\_addr, bool accept)

Grant security request access.

**参数**

- **bd\_addr** -- **[in]** : BD address of the peer
- **accept** -- **[in]** : accept the security request or not

**返回** - `ESP_OK` : success

- other : failed

*esp\_err\_t* **esp\_ble\_set\_encryption** (*esp\_bd\_addr\_t* bd\_addr, *esp\_ble\_sec\_act\_t* sec\_act)

Set a gap parameter value. Use this function to change the default GAP parameter values.

**参数**

- **bd\_addr** -- **[in]** : the address of the peer device need to encryption

- **sec\_act** -- **[in]** : This is the security action to indicate what kind of BLE security level is required for the BLE link if the BLE is supported
- 返回 - ESP\_OK : success
- other : failed

*esp\_err\_t* **esp\_ble\_passkey\_reply** (*esp\_bd\_addr\_t* bd\_addr, bool accept, uint32\_t passkey)

Reply the key value to the peer device in the legacy connection stage.

参数

- **bd\_addr** -- **[in]** : BD address of the peer
  - **accept** -- **[in]** : passkey entry successful or declined.
  - **passkey** -- **[in]** : passkey value, must be a 6 digit number, can be lead by 0.
- 返回 - ESP\_OK : success
- other : failed

*esp\_err\_t* **esp\_ble\_confirm\_reply** (*esp\_bd\_addr\_t* bd\_addr, bool accept)

Reply the confirm value to the peer device in the secure connection stage.

参数

- **bd\_addr** -- **[in]** : BD address of the peer device
  - **accept** -- **[in]** : numbers to compare are the same or different.
- 返回 - ESP\_OK : success
- other : failed

*esp\_err\_t* **esp\_ble\_remove\_bond\_device** (*esp\_bd\_addr\_t* bd\_addr)

Removes a device from the security database list of peer device. It manages unpairing event while connected.

参数 **bd\_addr** -- **[in]** : BD address of the peer device

- 返回 - ESP\_OK : success
- other : failed

int **esp\_ble\_get\_bond\_device\_num** (void)

Get the device number from the security database list of peer device. It will return the device bonded number immediately.

- 返回 - >= 0 : bonded devices number.
- ESP\_FAIL : failed

*esp\_err\_t* **esp\_ble\_get\_bond\_device\_list** (int \*dev\_num, *esp\_ble\_bond\_dev\_t* \*dev\_list)

Get the device from the security database list of peer device. It will return the device bonded information immediately.

参数

- **dev\_num** -- **[inout]** Indicate the dev\_list array(buffer) size as input. If dev\_num is large enough, it means the actual number as output. Suggest that dev\_num value equal to esp\_ble\_get\_bond\_device\_num().
  - **dev\_list** -- **[out]** an array(buffer) of *esp\_ble\_bond\_dev\_t* type. Use for storing the bonded devices address. The dev\_list should be allocated by who call this API.
- 返回 - ESP\_OK : success
- other : failed

*esp\_err\_t* **esp\_ble\_oob\_req\_reply** (*esp\_bd\_addr\_t* bd\_addr, uint8\_t \*TK, uint8\_t len)

This function is called to provide the OOB data for SMP in response to ESP\_GAP\_BLE\_OOB\_REQ\_EVT.

参数

- **bd\_addr** -- **[in]** BD address of the peer device.
  - **TK** -- **[in]** Temporary Key value, the TK value shall be a 128-bit random number
  - **len** -- **[in]** length of temporary key, should always be 128-bit
- 返回 - ESP\_OK : success
- other : failed

*esp\_err\_t* **esp\_ble\_sc\_oob\_req\_reply** (*esp\_bd\_addr\_t* bd\_addr, uint8\_t p\_c[16], uint8\_t p\_r[16])

This function is called to provide the OOB data for SMP in response to ESP\_GAP\_BLE\_SC\_OOB\_REQ\_EVT.

**参数**

- **bd\_addr** -- **[in]** BD address of the peer device.
- **p\_c** -- **[in]** Confirmation value, it shall be a 128-bit random number
- **p\_r** -- **[in]** Randomizer value, it should be a 128-bit random number

**返回** - ESP\_OK : success  
 • other : failed

*esp\_err\_t* **esp\_ble\_create\_sc\_oob\_data** (void)

This function is called to create the OOB data for SMP when secure connection.

**返回** - ESP\_OK : success  
 • other : failed

*esp\_err\_t* **esp\_ble\_gap\_disconnect** (*esp\_bd\_addr\_t* remote\_device)

This function is to disconnect the physical connection of the peer device gattc may have multiple virtual GATT server connections when multiple app\_id registered. esp\_ble\_gattc\_close (esp\_gatt\_if\_t gattc\_if, uint16\_t conn\_id) only close one virtual GATT server connection. if there exist other virtual GATT server connections, it does not disconnect the physical connection. esp\_ble\_gap\_disconnect(esp\_bd\_addr\_t remote\_device) disconnect the physical connection directly.

**参数** **remote\_device** -- **[in]** : BD address of the peer device

**返回** - ESP\_OK : success  
 • other : failed

*esp\_err\_t* **esp\_ble\_get\_current\_conn\_params** (*esp\_bd\_addr\_t* bd\_addr, *esp\_gap\_conn\_params\_t* \*conn\_params)

This function is called to read the connection parameters information of the device.

**参数**

- **bd\_addr** -- **[in]** BD address of the peer device.
- **conn\_params** -- **[out]** the connection parameters information

**返回** - ESP\_OK : success  
 • other : failed

*esp\_err\_t* **esp\_gap\_ble\_set\_channels** (*esp\_gap\_ble\_channels\_t* channels)

BLE set channels.

**参数** **channels** -- **[in]** : The n th such field (in the range 0 to 36) contains the value for the link layer channel index n. 0 means channel n is bad. 1 means channel n is unknown. The most significant bits are reserved and shall be set to 0. At least one channel shall be marked as unknown.

**返回** - ESP\_OK : success  
 • ESP\_ERR\_INVALID\_STATE: if bluetooth stack is not yet enabled  
 • other : failed

*esp\_err\_t* **esp\_gap\_ble\_set\_authorization** (*esp\_bd\_addr\_t* bd\_addr, bool authorize)

This function is called to authorized a link after Authentication(MITM protection)

**参数**

- **bd\_addr** -- **[in]** BD address of the peer device.
- **authorize** -- **[out]** Authorized the link or not.

**返回** - ESP\_OK : success  
 • other : failed

*esp\_err\_t* **esp\_ble\_gap\_read\_phy** (*esp\_bd\_addr\_t* bd\_addr)

This function is used to read the current transmitter PHY and receiver PHY on the connection identified by remote address.

**参数** **bd\_addr** -- **[in]** : BD address of the peer device

返回 - ESP\_OK : success  
 • other : failed

*esp\_err\_t* **esp\_ble\_gap\_set\_preferred\_default\_phy** (*esp\_ble\_gap\_phy\_mask\_t* tx\_phy\_mask,  
*esp\_ble\_gap\_phy\_mask\_t* rx\_phy\_mask)

This function is used to allow the Host to specify its preferred values for the transmitter PHY and receiver PHY to be used for all subsequent connections over the LE transport.

#### 参数

- **tx\_phy\_mask** -- [in] : indicates the transmitter PHYs that the Host prefers the Controller to use
- **rx\_phy\_mask** -- [in] : indicates the receiver PHYs that the Host prefers the Controller to use

返回 - ESP\_OK : success  
 • other : failed

*esp\_err\_t* **esp\_ble\_gap\_set\_preferred\_phy** (*esp\_bd\_addr\_t* bd\_addr, *esp\_ble\_gap\_all\_phys\_t*  
 all\_phys\_mask, *esp\_ble\_gap\_phy\_mask\_t* tx\_phy\_mask,  
*esp\_ble\_gap\_phy\_mask\_t* rx\_phy\_mask,  
*esp\_ble\_gap\_prefer\_phy\_options\_t* phy\_options)

This function is used to set the PHY preferences for the connection identified by the remote address. The Controller might not be able to make the change (e.g. because the peer does not support the requested PHY) or may decide that the current PHY is preferable.

#### 参数

- **bd\_addr** -- [in] : remote address
- **all\_phys\_mask** -- [in] : a bit field that allows the Host to specify
- **tx\_phy\_mask** -- [in] : a bit field that indicates the transmitter PHYs that the Host prefers the Controller to use
- **rx\_phy\_mask** -- [in] : a bit field that indicates the receiver PHYs that the Host prefers the Controller to use
- **phy\_options** -- [in] : a bit field that allows the Host to specify options for PHYs

返回 - ESP\_OK : success  
 • other : failed

*esp\_err\_t* **esp\_ble\_gap\_ext\_adv\_set\_rand\_addr** (uint8\_t instance, *esp\_bd\_addr\_t* rand\_addr)

This function is used by the Host to set the random device address specified by the Random\_Address parameter.

#### 参数

- **instance** -- [in] : Used to identify an advertising set
- **rand\_addr** -- [in] : Random Device Address

返回 - ESP\_OK : success  
 • other : failed

*esp\_err\_t* **esp\_ble\_gap\_ext\_adv\_set\_params** (uint8\_t instance, const *esp\_ble\_gap\_ext\_adv\_params\_t*  
 \*params)

This function is used by the Host to set the advertising parameters.

#### 参数

- **instance** -- [in] : identifies the advertising set whose parameters are being configured.
- **params** -- [in] : advertising parameters

返回 - ESP\_OK : success  
 • other : failed

*esp\_err\_t* **esp\_ble\_gap\_config\_ext\_adv\_data\_raw** (uint8\_t instance, uint16\_t length, const uint8\_t  
 \*data)

This function is used to set the data used in advertising PDUs that have a data field.

#### 参数

- **instance** -- [in] : identifies the advertising set whose data are being configured
- **length** -- [in] : data length
- **data** -- [in] : data information

返回 - ESP\_OK : success  
 • other : failed

*esp\_err\_t* **esp\_ble\_gap\_config\_ext\_scan\_rsp\_data\_raw** (uint8\_t instance, uint16\_t length, const uint8\_t \*scan\_rsp\_data)

This function is used to provide scan response data used in scanning response PDUs.

#### 参数

- **instance** -- [in] : identifies the advertising set whose response data are being configured.
- **length** -- [in] : response data length
- **scan\_rsp\_data** -- [in] : response data information

返回 - ESP\_OK : success  
 • other : failed

*esp\_err\_t* **esp\_ble\_gap\_ext\_adv\_start** (uint8\_t num\_adv, const *esp\_ble\_gap\_ext\_adv\_t* \*ext\_adv)

This function is used to request the Controller to enable one or more advertising sets using the advertising sets identified by the instance parameter.

#### 参数

- **num\_adv** -- [in] : Number of advertising sets to enable or disable
- **ext\_adv** -- [in] : adv parameters

返回 - ESP\_OK : success  
 • other : failed

*esp\_err\_t* **esp\_ble\_gap\_ext\_adv\_stop** (uint8\_t num\_adv, const uint8\_t \*ext\_adv\_inst)

This function is used to request the Controller to disable one or more advertising sets using the advertising sets identified by the instance parameter.

#### 参数

- **num\_adv** -- [in] : Number of advertising sets to enable or disable
- **ext\_adv\_inst** -- [in] : ext adv instance

返回 - ESP\_OK : success  
 • other : failed

*esp\_err\_t* **esp\_ble\_gap\_ext\_adv\_set\_remove** (uint8\_t instance)

This function is used to remove an advertising set from the Controller.

参数 **instance** -- [in] : Used to identify an advertising set

返回 - ESP\_OK : success  
 • other : failed

*esp\_err\_t* **esp\_ble\_gap\_ext\_adv\_set\_clear** (void)

This function is used to remove all existing advertising sets from the Controller.

返回 - ESP\_OK : success  
 • other : failed

*esp\_err\_t* **esp\_ble\_gap\_periodic\_adv\_set\_params** (uint8\_t instance, const *esp\_ble\_gap\_periodic\_adv\_params\_t* \*params)

This function is used by the Host to set the parameters for periodic advertising.

#### 参数

- **instance** -- [in] : identifies the advertising set whose periodic advertising parameters are being configured.
- **params** -- [in] : periodic adv parameters

返回 - ESP\_OK : success  
 • other : failed

*esp\_err\_t* **esp\_ble\_gap\_config\_periodic\_adv\_data\_raw** (uint8\_t instance, uint16\_t length, const uint8\_t \*data)

This function is used to set the data used in periodic advertising PDUs.

**参数**

- **instance** -- **[in]** : identifies the advertising set whose periodic advertising parameters are being configured.
- **length** -- **[in]** : the length of periodic data
- **data** -- **[in]** : periodic data information

**返回** - ESP\_OK : success  
 • other : failed

*esp\_err\_t* **esp\_ble\_gap\_periodic\_adv\_start** (uint8\_t instance)

This function is used to request the Controller to enable the periodic advertising for the advertising set specified.

**参数 instance** -- **[in]** : Used to identify an advertising set

**返回** - ESP\_OK : success  
 • other : failed

*esp\_err\_t* **esp\_ble\_gap\_periodic\_adv\_stop** (uint8\_t instance)

This function is used to request the Controller to disable the periodic advertising for the advertising set specified.

**参数 instance** -- **[in]** : Used to identify an advertising set

**返回** - ESP\_OK : success  
 • other : failed

*esp\_err\_t* **esp\_ble\_gap\_set\_ext\_scan\_params** (const *esp\_ble\_ext\_scan\_params\_t* \*params)

This function is used to set the extended scan parameters to be used on the advertising channels.

**参数 params** -- **[in]** : scan parameters

**返回** - ESP\_OK : success  
 • other : failed

*esp\_err\_t* **esp\_ble\_gap\_start\_ext\_scan** (uint32\_t duration, uint16\_t period)

This function is used to enable scanning.

**参数**

- **duration** -- **[in]** Scan duration time, where Time = N \* 10 ms. Range: 0x0001 to 0xFFFF.
- **period** -- **[in]** Time interval from when the Controller started its last Scan Duration until it begins the subsequent Scan Duration. Time = N \* 1.28 sec. Range: 0x0001 to 0xFFFF.

**返回** - ESP\_OK : success  
 • other : failed

*esp\_err\_t* **esp\_ble\_gap\_stop\_ext\_scan** (void)

This function is used to disable scanning.

**返回** - ESP\_OK : success  
 • other : failed

*esp\_err\_t* **esp\_ble\_gap\_periodic\_adv\_create\_sync** (const *esp\_ble\_gap\_periodic\_adv\_sync\_params\_t* \*params)

This function is used to synchronize with periodic advertising from an advertiser and begin receiving periodic advertising packets.

**参数 params** -- **[in]** : sync parameters

**返回** - ESP\_OK : success  
 • other : failed

*esp\_err\_t* **esp\_ble\_gap\_periodic\_adv\_sync\_cancel** (void)

This function is used to cancel the LE\_Periodic\_Advertising\_Create\_Sync command while it is pending.

**返回** - ESP\_OK : success  
 • other : failed

*esp\_err\_t* **esp\_ble\_gap\_periodic\_adv\_sync\_terminate** (uint16\_t sync\_handle)

This function is used to stop reception of the periodic advertising identified by the Sync Handle parameter.



参数 **sync\_handle** -- **[in]** : identify the periodic advertiser

返回 - ESP\_OK : success

- other : failed

*esp\_err\_t* **esp\_ble\_gap\_periodic\_adv\_add\_dev\_to\_list** (*esp\_ble\_addr\_type\_t* addr\_type, *esp\_bd\_addr\_t* addr, uint8\_t sid)

This function is used to add a single device to the Periodic Advertiser list stored in the Controller.

参数

- **addr\_type** -- **[in]** : address type
- **addr** -- **[in]** : Device Address
- **sid** -- **[in]** : Advertising SID subfield in the ADI field used to identify the Periodic Advertising

返回 - ESP\_OK : success

- other : failed

*esp\_err\_t* **esp\_ble\_gap\_periodic\_adv\_remove\_dev\_from\_list** (*esp\_ble\_addr\_type\_t* addr\_type, *esp\_bd\_addr\_t* addr, uint8\_t sid)

This function is used to remove one device from the list of Periodic Advertisers stored in the Controller. Removals from the Periodic Advertisers List take effect immediately.

参数

- **addr\_type** -- **[in]** : address type
- **addr** -- **[in]** : Device Address
- **sid** -- **[in]** : Advertising SID subfield in the ADI field used to identify the Periodic Advertising

返回 - ESP\_OK : success

- other : failed

*esp\_err\_t* **esp\_ble\_gap\_periodic\_adv\_clear\_dev** (void)

This function is used to remove all devices from the list of Periodic Advertisers in the Controller.

返回 - ESP\_OK : success

- other : failed

*esp\_err\_t* **esp\_ble\_gap\_prefer\_ext\_connect\_params\_set** (*esp\_bd\_addr\_t* addr, *esp\_ble\_gap\_phy\_mask\_t* phy\_mask, const *esp\_ble\_gap\_conn\_params\_t* \*phy\_1m\_conn\_params, const *esp\_ble\_gap\_conn\_params\_t* \*phy\_2m\_conn\_params, const *esp\_ble\_gap\_conn\_params\_t* \*phy\_coded\_conn\_params)

This function is used to set aux connection parameters.

参数

- **addr** -- **[in]** : device address
- **phy\_mask** -- **[in]** : indicates the PHY(s) on which the advertising packets should be received on the primary advertising channel and the PHYs for which connection parameters have been specified.
- **phy\_1m\_conn\_params** -- **[in]** : Scan connectable advertisements on the LE 1M PHY. Connection parameters for the LE 1M PHY are provided.
- **phy\_2m\_conn\_params** -- **[in]** : Connection parameters for the LE 2M PHY are provided.
- **phy\_coded\_conn\_params** -- **[in]** : Scan connectable advertisements on the LE Coded PHY. Connection parameters for the LE Coded PHY are provided.

返回 - ESP\_OK : success

- other : failed

*esp\_err\_t* **esp\_ble\_gap\_periodic\_adv\_rcv\_enable** (uint16\_t sync\_handle, uint8\_t enable)

This function is used to set periodic advertising receive enable.

**参数**

- **sync\_handle** -- **[in]** : Handle of periodic advertising sync
- **enable** -- **[in]** : Determines whether reporting and duplicate filtering are enabled or disabled

**返回** - ESP\_OK : success  
 • other : failed

*esp\_err\_t* **esp\_ble\_gap\_periodic\_adv\_sync\_trans** (*esp\_bd\_addr\_t* addr, uint16\_t service\_data, uint16\_t sync\_handle)

This function is used to transfer periodic advertising sync.

**参数**

- **addr** -- **[in]** : Peer device address
- **service\_data** -- **[in]** : Service data used by Host
- **sync\_handle** -- **[in]** : Handle of periodic advertising sync

**返回** - ESP\_OK : success  
 • other : failed

*esp\_err\_t* **esp\_ble\_gap\_periodic\_adv\_set\_info\_trans** (*esp\_bd\_addr\_t* addr, uint16\_t service\_data, uint8\_t adv\_handle)

This function is used to transfer periodic advertising set info.

**参数**

- **addr** -- **[in]** : Peer device address
- **service\_data** -- **[in]** : Service data used by Host
- **adv\_handle** -- **[in]** : Handle of advertising set

**返回** - ESP\_OK : success  
 • other : failed

*esp\_err\_t* **esp\_ble\_gap\_set\_periodic\_adv\_sync\_trans\_params** (*esp\_bd\_addr\_t* addr, const *esp\_ble\_gap\_past\_params\_t* \*params)

This function is used to set periodic advertising sync transfer params.

**参数**

- **addr** -- **[in]** : Peer device address
- **params** -- **[in]** : Params of periodic advertising sync transfer

**返回** - ESP\_OK : success  
 • other : failed

*esp\_err\_t* **esp\_ble\_dtm\_tx\_start** (const *esp\_ble\_dtm\_tx\_t* \*tx\_params)

This function is used to start a test where the DUT generates reference packets at a fixed interval.

**参数** **tx\_params** -- **[in]** : DTM Transmitter parameters

**返回** - ESP\_OK : success  
 • other : failed

*esp\_err\_t* **esp\_ble\_dtm\_rx\_start** (const *esp\_ble\_dtm\_rx\_t* \*rx\_params)

This function is used to start a test where the DUT receives test reference packets at a fixed interval.

**参数** **rx\_params** -- **[in]** : DTM Receiver parameters

**返回** - ESP\_OK : success  
 • other : failed

*esp\_err\_t* **esp\_ble\_dtm\_enh\_tx\_start** (const *esp\_ble\_dtm\_enh\_tx\_t* \*tx\_params)

This function is used to start a test where the DUT generates reference packets at a fixed interval.

**参数** **tx\_params** -- **[in]** : DTM Transmitter parameters

**返回** - ESP\_OK : success  
 • other : failed

*esp\_err\_t* **esp\_ble\_dtm\_enh\_rx\_start** (const *esp\_ble\_dtm\_enh\_rx\_t* \*rx\_params)

This function is used to start a test where the DUT receives test reference packets at a fixed interval.

参数 **rx\_params** -- [in] : DTM Receiver parameters

返回 - ESP\_OK : success

- other : failed

*esp\_err\_t* **esp\_ble\_dtm\_stop** (void)

This function is used to stop any test which is in progress.

返回 - ESP\_OK : success

- other : failed

*esp\_err\_t* **esp\_ble\_gap\_clear\_advertising** (void)

This function is used to clear legacy advertising.

返回 - ESP\_OK : success

- other : failed

*esp\_err\_t* **esp\_ble\_gap\_vendor\_command\_send** (*esp\_ble\_vendor\_cmd\_params\_t* \*vendor\_cmd\_param)

This function is called to send vendor hci command.

参数 **vendor\_cmd\_param** -- [in] vendor hci command parameters

返回

- ESP\_OK : success

- other : failed

*esp\_err\_t* **esp\_ble\_gap\_set\_privacy\_mode** (*esp\_ble\_addr\_type\_t* addr\_type, *esp\_bd\_addr\_t* addr, *esp\_ble\_privacy\_mode\_t* mode)

This function set the privacy mode of the device in resolving list.

---

备注: This feature is not supported on ESP32.

---

参数

- **addr\_type** -- [in] The address type of the peer identity address (BLE\_ADDR\_TYPE\_PUBLIC or BLE\_ADDR\_TYPE\_RANDOM).
- **addr** -- [in] The peer identity address of the device.
- **mode** -- [in] The privacy mode of the device.

返回

- ESP\_OK : success

- other : failed

## Unions

union **esp\_ble\_key\_value\_t**

*#include* <esp\_gap\_ble\_api.h> union type of the security key value

## Public Members

*esp\_ble\_penc\_keys\_t* **penc\_key**

received peer encryption key

*esp\_ble\_pcsrkeys\_t* **pcsrk\_key**

received peer device SRK

*esp\_ble\_pid\_keys\_t* **pid\_key**

peer device ID key

*esp\_ble\_lenc\_keys\_t* **lenc\_key**

local encryption reproduction keys LTK = = d1(ER,DIV,0)

*esp\_ble\_lcsrk\_keys* **lcsrk\_key**

local device CSRK = d1(ER,DIV,1)

union **esp\_ble\_sec\_t**

*#include <esp\_gap\_ble\_api.h>* union associated with ble security

### Public Members

*esp\_ble\_sec\_key\_notif\_t* **key\_notif**

passkey notification

*esp\_ble\_sec\_req\_t* **ble\_req**

BLE SMP related request

*esp\_ble\_key\_t* **ble\_key**

BLE SMP keys used when pairing

*esp\_ble\_local\_id\_keys\_t* **ble\_id\_keys**

BLE IR event

*esp\_ble\_local\_oob\_data\_t* **oob\_data**

BLE SMP secure connection OOB data

*esp\_ble\_auth\_cmpl\_t* **auth\_cmpl**

Authentication complete indication.

union **esp\_ble\_gap\_cb\_param\_t**

*#include <esp\_gap\_ble\_api.h>* Gap callback parameters union.

### Public Members

struct *esp\_ble\_gap\_cb\_param\_t::ble\_get\_dev\_name\_cmpl\_evt\_param* **get\_dev\_name\_cmpl**

Event parameter of ESP\_GAP\_BLE\_GET\_DEV\_NAME\_COMPLETE\_EVT

struct *esp\_ble\_gap\_cb\_param\_t::ble\_adv\_data\_cmpl\_evt\_param* **adv\_data\_cmpl**

Event parameter of ESP\_GAP\_BLE\_ADV\_DATA\_SET\_COMPLETE\_EVT

struct *esp\_ble\_gap\_cb\_param\_t::ble\_scan\_rsp\_data\_cmpl\_evt\_param* **scan\_rsp\_data\_cmpl**

Event parameter of ESP\_GAP\_BLE\_SCAN\_RSP\_DATA\_SET\_COMPLETE\_EVT

struct *esp\_ble\_gap\_cb\_param\_t::ble\_scan\_param\_cmpl\_evt\_param* **scan\_param\_cmpl**

Event parameter of ESP\_GAP\_BLE\_SCAN\_PARAM\_SET\_COMPLETE\_EVT

struct *esp\_ble\_gap\_cb\_param\_t::ble\_scan\_result\_evt\_param* **scan\_rst**

Event parameter of ESP\_GAP\_BLE\_SCAN\_RESULT\_EVT

struct *esp\_ble\_gap\_cb\_param\_t::ble\_adv\_data\_raw\_cmpl\_evt\_param* **adv\_data\_raw\_cmpl**  
Event parameter of ESP\_GAP\_BLE\_ADV\_DATA\_RAW\_SET\_COMPLETE\_EVT

struct *esp\_ble\_gap\_cb\_param\_t::ble\_scan\_rsp\_data\_raw\_cmpl\_evt\_param* **scan\_rsp\_data\_raw\_cmpl**  
Event parameter of ESP\_GAP\_BLE\_SCAN\_RSP\_DATA\_RAW\_SET\_COMPLETE\_EVT

struct *esp\_ble\_gap\_cb\_param\_t::ble\_adv\_start\_cmpl\_evt\_param* **adv\_start\_cmpl**  
Event parameter of ESP\_GAP\_BLE\_ADV\_START\_COMPLETE\_EVT

struct *esp\_ble\_gap\_cb\_param\_t::ble\_scan\_start\_cmpl\_evt\_param* **scan\_start\_cmpl**  
Event parameter of ESP\_GAP\_BLE\_SCAN\_START\_COMPLETE\_EVT

*esp\_ble\_sec\_t* **ble\_security**  
ble gap security union type

struct *esp\_ble\_gap\_cb\_param\_t::ble\_scan\_stop\_cmpl\_evt\_param* **scan\_stop\_cmpl**  
Event parameter of ESP\_GAP\_BLE\_SCAN\_STOP\_COMPLETE\_EVT

struct *esp\_ble\_gap\_cb\_param\_t::ble\_adv\_stop\_cmpl\_evt\_param* **adv\_stop\_cmpl**  
Event parameter of ESP\_GAP\_BLE\_ADV\_STOP\_COMPLETE\_EVT

struct *esp\_ble\_gap\_cb\_param\_t::ble\_adv\_clear\_cmpl\_evt\_param* **adv\_clear\_cmpl**  
Event parameter of ESP\_GAP\_BLE\_ADV\_CLEAR\_COMPLETE\_EVT

struct *esp\_ble\_gap\_cb\_param\_t::ble\_set\_rand\_cmpl\_evt\_param* **set\_rand\_addr\_cmpl**  
Event parameter of ESP\_GAP\_BLE\_SET\_STATIC\_RAND\_ADDR\_EVT

struct *esp\_ble\_gap\_cb\_param\_t::ble\_update\_conn\_params\_evt\_param* **update\_conn\_params**  
Event parameter of ESP\_GAP\_BLE\_UPDATE\_CONN\_PARAMS\_EVT

struct *esp\_ble\_gap\_cb\_param\_t::ble\_pkt\_data\_length\_cmpl\_evt\_param* **pkt\_data\_length\_cmpl**  
Event parameter of ESP\_GAP\_BLE\_SET\_PKT\_LENGTH\_COMPLETE\_EVT

struct *esp\_ble\_gap\_cb\_param\_t::ble\_local\_privacy\_cmpl\_evt\_param* **local\_privacy\_cmpl**  
Event parameter of ESP\_GAP\_BLE\_SET\_LOCAL\_PRIVACY\_COMPLETE\_EVT

struct *esp\_ble\_gap\_cb\_param\_t::ble\_rpa\_timeout\_cmpl\_evt\_param* **set\_rpa\_timeout\_cmpl**  
Event parameter of ESP\_GAP\_BLE\_SET\_RPA\_TIMEOUT\_COMPLETE\_EVT

struct *esp\_ble\_gap\_cb\_param\_t::ble\_add\_dev\_to\_resolving\_list\_cmpl\_evt\_param* **add\_dev\_to\_resolving\_list\_cmpl**  
Event parameter of ESP\_GAP\_BLE\_ADD\_DEV\_TO\_RESOLVING\_LIST\_COMPLETE\_EVT

struct *esp\_ble\_gap\_cb\_param\_t::ble\_remove\_bond\_dev\_cmpl\_evt\_param* **remove\_bond\_dev\_cmpl**  
Event parameter of ESP\_GAP\_BLE\_REMOVE\_BOND\_DEV\_COMPLETE\_EVT

struct *esp\_ble\_gap\_cb\_param\_t::ble\_clear\_bond\_dev\_cmpl\_evt\_param* **clear\_bond\_dev\_cmpl**  
Event parameter of ESP\_GAP\_BLE\_CLEAR\_BOND\_DEV\_COMPLETE\_EVT

```

struct esp_ble_gap_cb_param_t::ble_get_bond_dev_cmpl_evt_param get_bond_dev_cmpl
    Event parameter of ESP_GAP_BLE_GET_BOND_DEV_COMPLETE_EVT

struct esp_ble_gap_cb_param_t::ble_read_rssi_cmpl_evt_param read_rssi_cmpl
    Event parameter of ESP_GAP_BLE_READ_RSSI_COMPLETE_EVT

struct esp_ble_gap_cb_param_t::ble_update_whitelist_cmpl_evt_param update_whitelist_cmpl
    Event parameter of ESP_GAP_BLE_UPDATE_WHITELIST_COMPLETE_EVT

struct esp_ble_gap_cb_param_t::ble_update_duplicate_exceptional_list_cmpl_evt_param
update_duplicate_exceptional_list_cmpl
    Event parameter of ESP_GAP_BLE_UPDATE_DUPLICATE_EXCEPTIONAL_LIST_COMPLETE_EVT

struct esp_ble_gap_cb_param_t::ble_set_channels_evt_param ble_set_channels
    Event parameter of ESP_GAP_BLE_SET_CHANNELS_EVT

struct esp_ble_gap_cb_param_t::ble_read_phy_cmpl_evt_param read_phy
    Event parameter of ESP_GAP_BLE_READ_PHY_COMPLETE_EVT

struct esp_ble_gap_cb_param_t::ble_set_perf_def_phy_cmpl_evt_param set_perf_def_phy
    Event parameter of ESP_GAP_BLE_SET_PREFERRED_DEFAULT_PHY_COMPLETE_EVT

struct esp_ble_gap_cb_param_t::ble_set_perf_phy_cmpl_evt_param set_perf_phy
    Event parameter of ESP_GAP_BLE_SET_PREFERRED_PHY_COMPLETE_EVT

struct esp_ble_gap_cb_param_t::ble_ext_adv_set_rand_addr_cmpl_evt_param
ext_adv_set_rand_addr
    Event parameter of ESP_GAP_BLE_EXT_ADV_SET_RAND_ADDR_COMPLETE_EVT

struct esp_ble_gap_cb_param_t::ble_ext_adv_set_params_cmpl_evt_param ext_adv_set_params
    Event parameter of ESP_GAP_BLE_EXT_ADV_SET_PARAMS_COMPLETE_EVT

struct esp_ble_gap_cb_param_t::ble_ext_adv_data_set_cmpl_evt_param ext_adv_data_set
    Event parameter of ESP_GAP_BLE_EXT_ADV_DATA_SET_COMPLETE_EVT

struct esp_ble_gap_cb_param_t::ble_ext_adv_scan_rsp_set_cmpl_evt_param scan_rsp_set
    Event parameter of ESP_GAP_BLE_EXT_SCAN_RSP_DATA_SET_COMPLETE_EVT

struct esp_ble_gap_cb_param_t::ble_ext_adv_start_cmpl_evt_param ext_adv_start
    Event parameter of ESP_GAP_BLE_EXT_ADV_START_COMPLETE_EVT

struct esp_ble_gap_cb_param_t::ble_ext_adv_stop_cmpl_evt_param ext_adv_stop
    Event parameter of ESP_GAP_BLE_EXT_ADV_STOP_COMPLETE_EVT

struct esp_ble_gap_cb_param_t::ble_ext_adv_set_remove_cmpl_evt_param ext_adv_remove
    Event parameter of ESP_GAP_BLE_EXT_ADV_SET_REMOVE_COMPLETE_EVT

struct esp_ble_gap_cb_param_t::ble_ext_adv_set_clear_cmpl_evt_param ext_adv_clear
    Event parameter of ESP_GAP_BLE_EXT_ADV_SET_CLEAR_COMPLETE_EVT

```

```

struct esp_ble_gap_cb_param_t::ble_periodic_adv_set_params_cmpl_param period_adv_set_params
    Event parameter of ESP_GAP_BLE_PERIODIC_ADV_SET_PARAMS_COMPLETE_EVT

struct esp_ble_gap_cb_param_t::ble_periodic_adv_data_set_cmpl_param period_adv_data_set
    Event parameter of ESP_GAP_BLE_PERIODIC_ADV_DATA_SET_COMPLETE_EVT

struct esp_ble_gap_cb_param_t::ble_periodic_adv_start_cmpl_param period_adv_start
    Event parameter of ESP_GAP_BLE_PERIODIC_ADV_START_COMPLETE_EVT

struct esp_ble_gap_cb_param_t::ble_periodic_adv_stop_cmpl_param period_adv_stop
    Event parameter of ESP_GAP_BLE_PERIODIC_ADV_STOP_COMPLETE_EVT

struct esp_ble_gap_cb_param_t::ble_period_adv_create_sync_cmpl_param period_adv_create_sync
    Event parameter of ESP_GAP_BLE_PERIODIC_ADV_CREATE_SYNC_COMPLETE_EVT

struct esp_ble_gap_cb_param_t::ble_period_adv_sync_cancel_cmpl_param period_adv_sync_cancel
    Event parameter of ESP_GAP_BLE_PERIODIC_ADV_SYNC_CANCEL_COMPLETE_EVT

struct esp_ble_gap_cb_param_t::ble_period_adv_sync_terminate_cmpl_param period_adv_sync_term
    Event parameter of ESP_GAP_BLE_PERIODIC_ADV_SYNC_TERMINATE_COMPLETE_EVT

struct esp_ble_gap_cb_param_t::ble_period_adv_add_dev_cmpl_param period_adv_add_dev
    Event parameter of ESP_GAP_BLE_PERIODIC_ADV_ADD_DEV_COMPLETE_EVT

struct esp_ble_gap_cb_param_t::ble_period_adv_remove_dev_cmpl_param period_adv_remove_dev
    Event parameter of ESP_GAP_BLE_PERIODIC_ADV_REMOVE_DEV_COMPLETE_EVT

struct esp_ble_gap_cb_param_t::ble_period_adv_clear_dev_cmpl_param period_adv_clear_dev
    Event parameter of ESP_GAP_BLE_PERIODIC_ADV_CLEAR_DEV_COMPLETE_EVT

struct esp_ble_gap_cb_param_t::ble_set_ext_scan_params_cmpl_param set_ext_scan_params
    Event parameter of ESP_GAP_BLE_SET_EXT_SCAN_PARAMS_COMPLETE_EVT

struct esp_ble_gap_cb_param_t::ble_ext_scan_start_cmpl_param ext_scan_start
    Event parameter of ESP_GAP_BLE_EXT_SCAN_START_COMPLETE_EVT

struct esp_ble_gap_cb_param_t::ble_ext_scan_stop_cmpl_param ext_scan_stop
    Event parameter of ESP_GAP_BLE_EXT_SCAN_STOP_COMPLETE_EVT

struct esp_ble_gap_cb_param_t::ble_ext_conn_params_set_cmpl_param ext_conn_params_set
    Event parameter of ESP_GAP_BLE_PREFER_EXT_CONN_PARAMS_SET_COMPLETE_EVT

struct esp_ble_gap_cb_param_t::ble_adv_terminate_param adv_terminate
    Event parameter of ESP_GAP_BLE_ADV_TERMINATED_EVT

struct esp_ble_gap_cb_param_t::ble_scan_req_received_param scan_req_received
    Event parameter of ESP_GAP_BLE_SCAN_REQ_RECEIVED_EVT

```

```
struct esp_ble_gap_cb_param_t::ble_channel_sel_alg_param channel_sel_alg
    Event parameter of ESP_GAP_BLE_CHANNEL_SELECT_ALGORITHM_EVT

struct esp_ble_gap_cb_param_t::ble_periodic_adv_sync_lost_param periodic_adv_sync_lost
    Event parameter of ESP_GAP_BLE_PERIODIC_ADV_SYNC_LOST_EVT

struct esp_ble_gap_cb_param_t::ble_periodic_adv_sync_estab_param periodic_adv_sync_estab
    Event parameter of ESP_GAP_BLE_PERIODIC_ADV_SYNC_ESTAB_EVT

struct esp_ble_gap_cb_param_t::ble_phy_update_cmpl_param phy_update
    Event parameter of ESP_GAP_BLE_PHY_UPDATE_COMPLETE_EVT

struct esp_ble_gap_cb_param_t::ble_ext_adv_report_param ext_adv_report
    Event parameter of ESP_GAP_BLE_EXT_ADV_REPORT_EVT

struct esp_ble_gap_cb_param_t::ble_periodic_adv_report_param period_adv_report
    Event parameter of ESP_GAP_BLE_PERIODIC_ADV_REPORT_EVT

struct esp_ble_gap_cb_param_t::ble_periodic_adv_recv_enable_cmpl_param
period_adv_recv_enable
    Event parameter of ESP_GAP_BLE_PERIODIC_ADV_RECV_ENABLE_COMPLETE_EVT

struct esp_ble_gap_cb_param_t::ble_periodic_adv_sync_trans_cmpl_param period_adv_sync_trans
    Event parameter of ESP_GAP_BLE_PERIODIC_ADV_SYNC_TRANS_COMPLETE_EVT

struct esp_ble_gap_cb_param_t::ble_periodic_adv_set_info_trans_cmpl_param
period_adv_set_info_trans
    Event parameter of ESP_GAP_BLE_PERIODIC_ADV_SET_INFO_TRANS_COMPLETE_EVT

struct esp_ble_gap_cb_param_t::ble_set_past_params_cmpl_param set_past_params
    Event parameter of ESP_GAP_BLE_SET_PAST_PARAMS_COMPLETE_EVT

struct esp_ble_gap_cb_param_t::ble_periodic_adv_sync_trans_recv_param past_received
    Event parameter of ESP_GAP_BLE_PERIODIC_ADV_SYNC_TRANS_RECV_EVT

struct esp_ble_gap_cb_param_t::ble_dtm_state_update_evt_param dtm_state_update
    Event parameter of ESP_GAP_BLE_DTM_TEST_UPDATE_EVT

struct esp_ble_gap_cb_param_t::vendor_cmd_cmpl_evt_param vendor_cmd_cmpl
    Event parameter of ESP_GAP_BLE_VENDOR_CMD_COMPLETE_EVT

struct esp_ble_gap_cb_param_t::ble_set_privacy_mode_cmpl_evt_param set_privacy_mode_cmpl
    Event parameter of ESP_GAP_BLE_SET_PRIVACY_MODE_COMPLETE_EVT

struct ble_add_dev_to_resolving_list_cmpl_evt_param
    #include <esp_gap_ble_api.h> ESP_GAP_BLE_ADD_DEV_TO_RESOLVING_LIST_COMPLETE_EVT.
```



### Public Members

#### *esp\_bt\_status\_t* status

Indicates the success status of adding a device to the resolving list

```
struct ble_adv_clear_cmpl_evt_param
```

```
#include <esp_gap_ble_api.h> ESP_GAP_BLE_ADV_CLEAR_COMPLETE_EVT.
```

### Public Members

#### *esp\_bt\_status\_t* status

Indicate adv clear operation success status

```
struct ble_adv_data_cmpl_evt_param
```

```
#include <esp_gap_ble_api.h> ESP_GAP_BLE_ADV_DATA_SET_COMPLETE_EVT.
```

### Public Members

#### *esp\_bt\_status\_t* status

Indicate the set advertising data operation success status

```
struct ble_adv_data_raw_cmpl_evt_param
```

```
#include <esp_gap_ble_api.h> ESP_GAP_BLE_ADV_DATA_RAW_SET_COMPLETE_EVT.
```

### Public Members

#### *esp\_bt\_status\_t* status

Indicate the set raw advertising data operation success status

```
struct ble_adv_start_cmpl_evt_param
```

```
#include <esp_gap_ble_api.h> ESP_GAP_BLE_ADV_START_COMPLETE_EVT.
```

### Public Members

#### *esp\_bt\_status\_t* status

Indicate advertising start operation success status

```
struct ble_adv_stop_cmpl_evt_param
```

```
#include <esp_gap_ble_api.h> ESP_GAP_BLE_ADV_STOP_COMPLETE_EVT.
```

### Public Members

#### *esp\_bt\_status\_t* status

Indicate adv stop operation success status

```
struct ble_adv_terminate_param  
    #include <esp_gap_ble_api.h> ESP_GAP_BLE_ADV_TERMINATED_EVT.
```

### Public Members

`uint8_t status`  
Indicate adv terminate status

`uint8_t adv_instance`  
extend advertising handle

`uint16_t conn_idx`  
connection index

`uint8_t completed_event`  
the number of completed extend advertising events

```
struct ble_channel_sel_alg_param  
    #include <esp_gap_ble_api.h> ESP_GAP_BLE_CHANNEL_SELECT_ALGORITHM_EVT.
```

### Public Members

`uint16_t conn_handle`  
connection handle

`uint8_t channel_sel_alg`  
channel selection algorithm

```
struct ble_clear_bond_dev_cmpl_evt_param  
    #include <esp_gap_ble_api.h> ESP_GAP_BLE_CLEAR_BOND_DEV_COMPLETE_EVT.
```

### Public Members

`esp_bt_status_t status`  
Indicate the clear bond device operation success status

```
struct ble_dtm_state_update_evt_param  
    #include <esp_gap_ble_api.h> ESP_GAP_BLE_DTM_TEST_UPDATE_EVT.
```

### Public Members

`esp_bt_status_t status`  
Indicate DTM operation success status

`esp_ble_dtm_update_evt_t update_evt`  
DTM state change event, 0x00: DTM TX start, 0x01: DTM RX start, 0x02:DTM end

uint16\_t **num\_of\_pkt**

number of packets received, only valid if update\_evt is DTM\_TEST\_STOP\_EVT and shall be reported as 0 for a transmitter

struct **ble\_ext\_adv\_data\_set\_cmpl\_evt\_param**

*#include <esp\_gap\_ble\_api.h>* ESP\_GAP\_BLE\_EXT\_ADV\_DATA\_SET\_COMPLETE\_EVT.

### Public Members

*esp\_bt\_status\_t* **status**

Indicate extend advertising data set status

uint8\_t **instance**

extend advertising handle

struct **ble\_ext\_adv\_report\_param**

*#include <esp\_gap\_ble\_api.h>* ESP\_GAP\_BLE\_EXT\_ADV\_REPORT\_EVT.

### Public Members

*esp\_ble\_gap\_ext\_adv\_report\_t* **params**

extend advertising report parameters

struct **ble\_ext\_adv\_scan\_rsp\_set\_cmpl\_evt\_param**

*#include <esp\_gap\_ble\_api.h>* ESP\_GAP\_BLE\_EXT\_SCAN\_RSP\_DATA\_SET\_COMPLETE\_EVT.

### Public Members

*esp\_bt\_status\_t* **status**

Indicate extend advertising scan response data set status

uint8\_t **instance**

extend advertising handle

struct **ble\_ext\_adv\_set\_clear\_cmpl\_evt\_param**

*#include <esp\_gap\_ble\_api.h>* ESP\_GAP\_BLE\_EXT\_ADV\_SET\_CLEAR\_COMPLETE\_EVT.

### Public Members

*esp\_bt\_status\_t* **status**

Indicate advertising stop operation success status

uint8\_t **instance**

extend advertising handle

struct **ble\_ext\_adv\_set\_params\_cmpl\_evt\_param**

*#include <esp\_gap\_ble\_api.h>* ESP\_GAP\_BLE\_EXT\_ADV\_SET\_PARAMS\_COMPLETE\_EVT.

### Public Members

#### *esp\_bt\_status\_t* status

Indicate extend advertising parameters set status

#### uint8\_t instance

extend advertising handle

struct **ble\_ext\_adv\_set\_rand\_addr\_cmpl\_evt\_param**

*#include <esp\_gap\_ble\_api.h>* ESP\_GAP\_BLE\_EXT\_ADV\_SET\_RAND\_ADDR\_COMPLETE\_EVT.

### Public Members

#### *esp\_bt\_status\_t* status

Indicate extend advertising random address set status

#### uint8\_t instance

extend advertising handle

struct **ble\_ext\_adv\_set\_remove\_cmpl\_evt\_param**

*#include <esp\_gap\_ble\_api.h>* ESP\_GAP\_BLE\_EXT\_ADV\_SET\_REMOVE\_COMPLETE\_EVT.

### Public Members

#### *esp\_bt\_status\_t* status

Indicate advertising stop operation success status

#### uint8\_t instance

extend advertising handle

struct **ble\_ext\_adv\_start\_cmpl\_evt\_param**

*#include <esp\_gap\_ble\_api.h>* ESP\_GAP\_BLE\_EXT\_ADV\_START\_COMPLETE\_EVT.

### Public Members

#### *esp\_bt\_status\_t* status

Indicate advertising start operation success status

#### uint8\_t instance\_num

extend advertising handle numble

#### uint8\_t instance[EXT\_ADV\_NUM\_SETS\_MAX]

extend advertising handle list

struct **ble\_ext\_adv\_stop\_cmpl\_evt\_param**

*#include <esp\_gap\_ble\_api.h>* ESP\_GAP\_BLE\_EXT\_ADV\_STOP\_COMPLETE\_EVT.

### Public Members

#### *esp\_bt\_status\_t* status

Indicate advertising stop operation success status

#### uint8\_t instance\_num

extend advertising handle numble

#### uint8\_t instance[EXT\_ADV\_NUM\_SETS\_MAX]

extend advertising handle list

struct **ble\_ext\_conn\_params\_set\_cmpl\_param**

*#include <esp\_gap\_ble\_api.h>* ESP\_GAP\_BLE\_PREFER\_EXT\_CONN\_PARAMS\_SET\_COMPLETE\_EVT.

### Public Members

#### *esp\_bt\_status\_t* status

Indicate extend connection parameters set status

struct **ble\_ext\_scan\_start\_cmpl\_param**

*#include <esp\_gap\_ble\_api.h>* ESP\_GAP\_BLE\_EXT\_SCAN\_START\_COMPLETE\_EVT.

### Public Members

#### *esp\_bt\_status\_t* status

Indicate extend advertising start status

struct **ble\_ext\_scan\_stop\_cmpl\_param**

*#include <esp\_gap\_ble\_api.h>* ESP\_GAP\_BLE\_EXT\_SCAN\_STOP\_COMPLETE\_EVT.

### Public Members

#### *esp\_bt\_status\_t* status

Indicate extend advertising stop status

struct **ble\_get\_bond\_dev\_cmpl\_evt\_param**

*#include <esp\_gap\_ble\_api.h>* ESP\_GAP\_BLE\_GET\_BOND\_DEV\_COMPLETE\_EVT.

### Public Members

#### *esp\_bt\_status\_t* status

Indicate the get bond device operation success status

#### uint8\_t dev\_num

Indicate the get number device in the bond list

*esp\_ble\_bond\_dev\_t* \*bond\_dev

the pointer to the bond device Structure

struct **ble\_get\_dev\_name\_cmpl\_evt\_param**

*#include <esp\_gap\_ble\_api.h>* ESP\_GAP\_BLE\_GET\_DEV\_NAME\_COMPLETE\_EVT.

### Public Members

*esp\_bt\_status\_t* status

Indicate the get device name success status

char \*name

Name of bluetooth device

struct **ble\_local\_privacy\_cmpl\_evt\_param**

*#include <esp\_gap\_ble\_api.h>* ESP\_GAP\_BLE\_SET\_LOCAL\_PRIVACY\_COMPLETE\_EVT.

### Public Members

*esp\_bt\_status\_t* status

Indicate the set local privacy operation success status

struct **ble\_period\_adv\_add\_dev\_cmpl\_param**

*#include <esp\_gap\_ble\_api.h>* ESP\_GAP\_BLE\_PERIODIC\_ADV\_ADD\_DEV\_COMPLETE\_EVT.

### Public Members

*esp\_bt\_status\_t* status

Indicate periodic advertising device list add status

struct **ble\_period\_adv\_clear\_dev\_cmpl\_param**

*#include <esp\_gap\_ble\_api.h>* ESP\_GAP\_BLE\_PERIODIC\_ADV\_CLEAR\_DEV\_COMPLETE\_EVT.

### Public Members

*esp\_bt\_status\_t* status

Indicate periodic advertising device list clean status

struct **ble\_period\_adv\_create\_sync\_cmpl\_param**

*#include <esp\_gap\_ble\_api.h>* ESP\_GAP\_BLE\_PERIODIC\_ADV\_CREATE\_SYNC\_COMPLETE\_EVT.

### Public Members

*esp\_bt\_status\_t* status

Indicate periodic advertising create sync status

```
struct ble_period_adv_remove_dev_cmpl_param  
#include <esp_gap_ble_api.h> ESP_GAP_BLE_PERIODIC_ADV_REMOVE_DEV_COMPLETE_EVT.
```

### Public Members

*esp\_bt\_status\_t* **status**  
Indicate periodic advertising device list remove status

```
struct ble_period_adv_sync_cancel_cmpl_param  
#include <esp_gap_ble_api.h> ESP_GAP_BLE_PERIODIC_ADV_SYNC_CANCEL_COMPLETE_EVT.
```

### Public Members

*esp\_bt\_status\_t* **status**  
Indicate periodic advertising sync cancel status

```
struct ble_period_adv_sync_terminate_cmpl_param  
#include <esp_gap_ble_api.h> ESP_GAP_BLE_PERIODIC_ADV_SYNC_TERMINATE_COMPLETE_EVT.
```

### Public Members

*esp\_bt\_status\_t* **status**  
Indicate periodic advertising sync terminate status

```
struct ble_periodic_adv_data_set_cmpl_param  
#include <esp_gap_ble_api.h> ESP_GAP_BLE_PERIODIC_ADV_DATA_SET_COMPLETE_EVT.
```

### Public Members

*esp\_bt\_status\_t* **status**  
Indicate periodic advertising data set status

uint8\_t **instance**  
extend advertising handle

```
struct ble_periodic_adv_recv_enable_cmpl_param  
#include <esp_gap_ble_api.h> ESP_GAP_BLE_PERIODIC_ADV_RECV_ENABLE_COMPLETE_EVT.
```

### Public Members

*esp\_bt\_status\_t* **status**  
Set periodic advertising receive enable status

```
struct ble_periodic_adv_report_param  
#include <esp_gap_ble_api.h> ESP_GAP_BLE_PERIODIC_ADV_REPORT_EVT.
```

### Public Members

*esp\_ble\_gap\_periodic\_adv\_report\_t* **params**

periodic advertising report parameters

struct **ble\_periodic\_adv\_set\_info\_trans\_cmpl\_param**

*#include <esp\_gap\_ble\_api.h>* ESP\_GAP\_BLE\_PERIODIC\_ADV\_SET\_INFO\_TRANS\_COMPLETE\_EVT.

### Public Members

*esp\_bt\_status\_t* **status**

Periodic advertising set info transfer status

*esp\_bd\_addr\_t* **bda**

The remote device address

struct **ble\_periodic\_adv\_set\_params\_cmpl\_param**

*#include <esp\_gap\_ble\_api.h>* ESP\_GAP\_BLE\_PERIODIC\_ADV\_SET\_PARAMS\_COMPLETE\_EVT.

### Public Members

*esp\_bt\_status\_t* **status**

Indicate periodic advertising parameters set status

uint8\_t **instance**

extend advertising handle

struct **ble\_periodic\_adv\_start\_cmpl\_param**

*#include <esp\_gap\_ble\_api.h>* ESP\_GAP\_BLE\_PERIODIC\_ADV\_START\_COMPLETE\_EVT.

### Public Members

*esp\_bt\_status\_t* **status**

Indicate periodic advertising start status

uint8\_t **instance**

extend advertising handle

struct **ble\_periodic\_adv\_stop\_cmpl\_param**

*#include <esp\_gap\_ble\_api.h>* ESP\_GAP\_BLE\_PERIODIC\_ADV\_STOP\_COMPLETE\_EVT.

### Public Members

*esp\_bt\_status\_t* **status**

Indicate periodic advertising stop status



uint8\_t **instance**

extend advertising handle

struct **ble\_periodic\_adv\_sync\_estab\_param**

*#include <esp\_gap\_ble\_api.h>* ESP\_GAP\_BLE\_PERIODIC\_ADV\_SYNC\_ESTAB\_EVT.

### Public Members

uint8\_t **status**

periodic advertising sync status

uint16\_t **sync\_handle**

periodic advertising sync handle

uint8\_t **sid**

periodic advertising sid

*esp\_ble\_addr\_type\_t* **adv\_addr\_type**

periodic advertising address type

*esp\_bd\_addr\_t* **adv\_addr**

periodic advertising address

*esp\_ble\_gap\_phy\_t* **adv\_phy**

periodic advertising phy type

uint16\_t **period\_adv\_interval**

periodic advertising interval

uint8\_t **adv\_clk\_accuracy**

periodic advertising clock accuracy

struct **ble\_periodic\_adv\_sync\_lost\_param**

*#include <esp\_gap\_ble\_api.h>* ESP\_GAP\_BLE\_PERIODIC\_ADV\_SYNC\_LOST\_EVT.

### Public Members

uint16\_t **sync\_handle**

sync handle

struct **ble\_periodic\_adv\_sync\_trans\_cmpl\_param**

*#include <esp\_gap\_ble\_api.h>* ESP\_GAP\_BLE\_PERIODIC\_ADV\_SYNC\_TRANS\_COMPLETE\_EVT.

### Public Members

*esp\_bt\_status\_t* **status**

Periodic advertising sync transfer status

*esp\_bd\_addr\_t* **bda**

The remote device address

struct **ble\_periodic\_adv\_sync\_trans\_rcv\_param**

*#include <esp\_gap\_ble\_api.h>* ESP\_GAP\_BLE\_PERIODIC\_ADV\_SYNC\_TRANS\_RECV\_EVT.

### Public Members

*esp\_bt\_status\_t* **status**

Periodic advertising sync transfer received status

*esp\_bd\_addr\_t* **bda**

The remote device address

uint16\_t **service\_data**

The value provided by the peer device

uint16\_t **sync\_handle**

Periodic advertising sync handle

uint8\_t **adv\_sid**

Periodic advertising set id

uint8\_t **adv\_addr\_type**

Periodic advertiser address type

*esp\_bd\_addr\_t* **adv\_addr**

Periodic advertiser address

*esp\_ble\_gap\_phy\_t* **adv\_phy**

Periodic advertising PHY

uint16\_t **adv\_interval**

Periodic advertising interval

uint8\_t **adv\_clk\_accuracy**

Periodic advertising clock accuracy

struct **ble\_phy\_update\_cmpl\_param**

*#include <esp\_gap\_ble\_api.h>* ESP\_GAP\_BLE\_PHY\_UPDATE\_COMPLETE\_EVT.

### Public Members

*esp\_bt\_status\_t* **status**

phy update status

*esp\_bd\_addr\_t* **bda**

address

*esp\_ble\_gap\_phy\_t* **tx\_phy**

tx phy type

*esp\_ble\_gap\_phy\_t* **rx\_phy**

rx phy type

struct **ble\_pkt\_data\_length\_cmpl\_evt\_param**

*#include <esp\_gap\_ble\_api.h>* ESP\_GAP\_BLE\_SET\_PKT\_LENGTH\_COMPLETE\_EVT.

### Public Members

*esp\_bt\_status\_t* **status**

Indicate the set pkt data length operation success status

*esp\_ble\_pkt\_data\_length\_params\_t* **params**

pkt data length value

struct **ble\_read\_phy\_cmpl\_evt\_param**

*#include <esp\_gap\_ble\_api.h>* ESP\_GAP\_BLE\_READ\_PHY\_COMPLETE\_EVT.

### Public Members

*esp\_bt\_status\_t* **status**

read phy complete status

*esp\_bd\_addr\_t* **bda**

read phy address

*esp\_ble\_gap\_phy\_t* **tx\_phy**

tx phy type

*esp\_ble\_gap\_phy\_t* **rx\_phy**

rx phy type

struct **ble\_read\_rssi\_cmpl\_evt\_param**

*#include <esp\_gap\_ble\_api.h>* ESP\_GAP\_BLE\_READ\_RSSI\_COMPLETE\_EVT.

### Public Members

***esp\_bt\_status\_t* status**

Indicate the read adv tx power operation success status

**int8\_t rssi**

The ble remote device rssi value, the range is from -127 to 20, the unit is dbm, if the RSSI cannot be read, the RSSI metric shall be set to 127.

***esp\_bd\_addr\_t* remote\_addr**

The remote device address

struct **ble\_remove\_bond\_dev\_cmpl\_evt\_param**

*#include <esp\_gap\_ble\_api.h>* ESP\_GAP\_BLE\_REMOVE\_BOND\_DEV\_COMPLETE\_EVT.

**Public Members*****esp\_bt\_status\_t* status**

Indicate the remove bond device operation success status

***esp\_bd\_addr\_t* bd\_addr**

The device address which has been remove from the bond list

struct **ble\_rpa\_timeout\_cmpl\_evt\_param**

*#include <esp\_gap\_ble\_api.h>* ESP\_GAP\_BLE\_SET\_RPA\_TIMEOUT\_COMPLETE\_EVT.

**Public Members*****esp\_bt\_status\_t* status**

Indicate the set RPA timeout operation success status

struct **ble\_scan\_param\_cmpl\_evt\_param**

*#include <esp\_gap\_ble\_api.h>* ESP\_GAP\_BLE\_SCAN\_PARAM\_SET\_COMPLETE\_EVT.

**Public Members*****esp\_bt\_status\_t* status**

Indicate the set scan param operation success status

struct **ble\_scan\_req\_received\_param**

*#include <esp\_gap\_ble\_api.h>* ESP\_GAP\_BLE\_SCAN\_REQ\_RECEIVED\_EVT.

**Public Members****uint8\_t adv\_instance**

extend advertising handle

*esp\_ble\_addr\_type\_t* **scan\_addr\_type**

scanner address type

*esp\_bd\_addr\_t* **scan\_addr**

scanner address

struct **ble\_scan\_result\_evt\_param**

*#include <esp\_gap\_ble\_api.h>* ESP\_GAP\_BLE\_SCAN\_RESULT\_EVT.

### Public Members

*esp\_gap\_search\_evt\_t* **search\_evt**

Search event type

*esp\_bd\_addr\_t* **bda**

Bluetooth device address which has been searched

*esp\_bt\_dev\_type\_t* **dev\_type**

Device type

*esp\_ble\_addr\_type\_t* **ble\_addr\_type**

Ble device address type

*esp\_ble\_evt\_type\_t* **ble\_evt\_type**

Ble scan result event type

int **rssi**

Searched device's RSSI

uint8\_t **ble\_adv**[ESP\_BLE\_ADV\_DATA\_LEN\_MAX +  
ESP\_BLE\_SCAN\_RSP\_DATA\_LEN\_MAX]

Received EIR

int **flag**

Advertising data flag bit

int **num\_resps**

Scan result number

uint8\_t **adv\_data\_len**

Adv data length

uint8\_t **scan\_rsp\_len**

Scan response length

uint32\_t **num\_dis**

The number of discard packets

```
struct ble_scan_rsp_data_cmpl_evt_param  
#include <esp_gap_ble_api.h> ESP_GAP_BLE_SCAN_RSP_DATA_SET_COMPLETE_EVT.
```

### Public Members

*esp\_bt\_status\_t* **status**

Indicate the set scan response data operation success status

```
struct ble_scan_rsp_data_raw_cmpl_evt_param  
#include <esp_gap_ble_api.h> ESP_GAP_BLE_SCAN_RSP_DATA_RAW_SET_COMPLETE_EVT.
```

### Public Members

*esp\_bt\_status\_t* **status**

Indicate the set raw advertising data operation success status

```
struct ble_scan_start_cmpl_evt_param  
#include <esp_gap_ble_api.h> ESP_GAP_BLE_SCAN_START_COMPLETE_EVT.
```

### Public Members

*esp\_bt\_status\_t* **status**

Indicate scan start operation success status

```
struct ble_scan_stop_cmpl_evt_param  
#include <esp_gap_ble_api.h> ESP_GAP_BLE_SCAN_STOP_COMPLETE_EVT.
```

### Public Members

*esp\_bt\_status\_t* **status**

Indicate scan stop operation success status

```
struct ble_set_channels_evt_param  
#include <esp_gap_ble_api.h> ESP_GAP_BLE_SET_CHANNELS_EVT.
```

### Public Members

*esp\_bt\_status\_t* **stat**

BLE set channel status

```
struct ble_set_ext_scan_params_cmpl_param  
#include <esp_gap_ble_api.h> ESP_GAP_BLE_SET_EXT_SCAN_PARAMS_COMPLETE_EVT.
```

### Public Members

#### *esp\_bt\_status\_t* status

Indicate extend advertising parameters set status

struct **ble\_set\_past\_params\_cmpl\_param**

*#include <esp\_gap\_ble\_api.h>* ESP\_GAP\_BLE\_SET\_PAST\_PARAMS\_COMPLETE\_EVT.

### Public Members

#### *esp\_bt\_status\_t* status

Set periodic advertising sync transfer params status

#### *esp\_bd\_addr\_t* bda

The remote device address

struct **ble\_set\_perf\_def\_phy\_cmpl\_evt\_param**

*#include <esp\_gap\_ble\_api.h>* ESP\_GAP\_BLE\_SET\_PREFERRED\_DEFAULT\_PHY\_COMPLETE\_EVT.

### Public Members

#### *esp\_bt\_status\_t* status

Indicate perf default phy set status

struct **ble\_set\_perf\_phy\_cmpl\_evt\_param**

*#include <esp\_gap\_ble\_api.h>* ESP\_GAP\_BLE\_SET\_PREFERRED\_PHY\_COMPLETE\_EVT.

### Public Members

#### *esp\_bt\_status\_t* status

Indicate perf phy set status

struct **ble\_set\_privacy\_mode\_cmpl\_evt\_param**

*#include <esp\_gap\_ble\_api.h>* ESP\_GAP\_BLE\_SET\_PRIVACY\_MODE\_COMPLETE\_EVT.

### Public Members

#### *esp\_bt\_status\_t* status

Indicate privacy mode set operation success status

struct **ble\_set\_rand\_cmpl\_evt\_param**

*#include <esp\_gap\_ble\_api.h>* ESP\_GAP\_BLE\_SET\_STATIC\_RAND\_ADDR\_EVT.

### Public Members

#### *esp\_bt\_status\_t* status

Indicate set static rand address operation success status

struct **ble\_update\_conn\_params\_evt\_param**

*#include <esp\_gap\_ble\_api.h>* ESP\_GAP\_BLE\_UPDATE\_CONN\_PARAMS\_EVT.

### Public Members

#### *esp\_bt\_status\_t* status

Indicate update connection parameters success status

#### *esp\_bd\_addr\_t* bda

Bluetooth device address

#### uint16\_t min\_int

Min connection interval

#### uint16\_t max\_int

Max connection interval

#### uint16\_t latency

Slave latency for the connection in number of connection events. Range: 0x0000 to 0x01F3

#### uint16\_t conn\_int

Current connection interval

#### uint16\_t timeout

Supervision timeout for the LE Link. Range: 0x000A to 0x0C80. Mandatory Range: 0x000A to 0x0C80 Time = N \* 10 msec

struct **ble\_update\_duplicate\_exceptional\_list\_cmpl\_evt\_param**

*#include <esp\_gap\_ble\_api.h>* ESP\_GAP\_BLE\_UPDATE\_DUPLICATE\_EXCEPTIONAL\_LIST\_COMPLETE\_EVT.

### Public Members

#### *esp\_bt\_status\_t* status

Indicate update duplicate scan exceptional list operation success status

#### uint8\_t subcode

Define in *esp\_bt\_duplicate\_exceptional\_subcode\_type\_t*

#### uint16\_t length

The length of *device\_info*



***esp\_duplicate\_info\_t* device\_info**

device information, when subcode is ESP\_BLE\_DUPLICATE\_EXCEPTIONAL\_LIST\_CLEAN, the value is invalid

struct **ble\_update\_whitelist\_cmpl\_evt\_param**

*#include <esp\_gap\_ble\_api.h>* ESP\_GAP\_BLE\_UPDATE\_WHITELIST\_COMPLETE\_EVT.

**Public Members*****esp\_bt\_status\_t* status**

Indicate the add or remove whitelist operation success status

***esp\_ble\_wl\_operation\_t* wl\_operation**

The value is ESP\_BLE\_WHITELIST\_ADD if add address to whitelist operation success, ESP\_BLE\_WHITELIST\_REMOVE if remove address from the whitelist operation success

struct **vendor\_cmd\_cmpl\_evt\_param**

*#include <esp\_gap\_ble\_api.h>* ESP\_GAP\_BLE\_VENDOR\_CMD\_COMPLETE\_EVT.

**Public Members****uint16\_t opcode**

vendor hci command opcode

**uint16\_t param\_len**

The length of parameter buffer

**uint8\_t \*p\_param\_buf**

The point of parameter buffer

**Structures**

struct **esp\_ble\_vendor\_cmd\_params\_t**

Vendor HCI command parameters.

**Public Members****uint16\_t opcode**

vendor hci command opcode

**uint8\_t param\_len**

the length of parameter

**uint8\_t \*p\_param\_buf**

the point of parameter buffer

struct **esp\_ble\_dtm\_tx\_t**

DTM TX parameters.

### Public Members

uint8\_t **tx\_channel**

channel for sending test data, tx\_channel = (Frequency - 2402)/2, tx\_channel range: 0x00-0x27, Frequency range: 2402 MHz to 2480 MHz

uint8\_t **len\_of\_data**

length in bytes of payload data in each packet

*esp\_ble\_dtm\_pkt\_payload\_t* **pkt\_payload**

packet payload type. value range: 0x00-0x07

struct **esp\_ble\_dtm\_rx\_t**

DTM RX parameters.

### Public Members

uint8\_t **rx\_channel**

channel for test data reception, rx\_channel = (Frequency - 2402)/2, tx\_channel range: 0x00-0x27, Frequency range: 2402 MHz to 2480 MHz

struct **esp\_ble\_adv\_params\_t**

Advertising parameters.

### Public Members

uint16\_t **adv\_int\_min**

Minimum advertising interval for undirected and low duty cycle directed advertising. Range: 0x0020 to 0x4000 Default: N = 0x0800 (1.28 second) Time = N \* 0.625 msec Time Range: 20 ms to 10.24 sec

uint16\_t **adv\_int\_max**

Maximum advertising interval for undirected and low duty cycle directed advertising. Range: 0x0020 to 0x4000 Default: N = 0x0800 (1.28 second) Time = N \* 0.625 msec Time Range: 20 ms to 10.24 sec  
Advertising max interval

*esp\_ble\_adv\_type\_t* **adv\_type**

Advertising type

*esp\_ble\_addr\_type\_t* **own\_addr\_type**

Owner bluetooth device address type

*esp\_bd\_addr\_t* **peer\_addr**

Peer device bluetooth device address

*esp\_ble\_addr\_type\_t* **peer\_addr\_type**

Peer device bluetooth device address type, only support public address type and random address type

*esp\_ble\_adv\_channel\_t* **channel\_map**

Advertising channel map

*esp\_ble\_adv\_filter\_t* **adv\_filter\_policy**

Advertising filter policy

struct **esp\_ble\_adv\_data\_t**

Advertising data content, according to "Supplement to the Bluetooth Core Specification".

### Public Members

bool **set\_scan\_rsp**

Set this advertising data as scan response or not

bool **include\_name**

Advertising data include device name or not

bool **include\_txpower**

Advertising data include TX power

int **min\_interval**

Advertising data show slave preferred connection min interval. The connection interval in the following manner:  $\text{connIntervalmin} = \text{Conn\_Interval\_Min} * 1.25 \text{ ms}$  Conn\_Interval\_Min range: 0x0006 to 0x0C80 Value of 0xFFFF indicates no specific minimum. Values not defined above are reserved for future use.

int **max\_interval**

Advertising data show slave preferred connection max interval. The connection interval in the following manner:  $\text{connIntervalmax} = \text{Conn\_Interval\_Max} * 1.25 \text{ ms}$  Conn\_Interval\_Max range: 0x0006 to 0x0C80 Conn\_Interval\_Max shall be equal to or greater than the Conn\_Interval\_Min. Value of 0xFFFF indicates no specific maximum. Values not defined above are reserved for future use.

int **appearance**

External appearance of device

uint16\_t **manufacturer\_len**

Manufacturer data length

uint8\_t \***p\_manufacturer\_data**

Manufacturer data point

uint16\_t **service\_data\_len**

Service data length

uint8\_t \***p\_service\_data**

Service data point

uint16\_t **service\_uuid\_len**

Service uuid length

uint8\_t \***p\_service\_uuid**

Service uuid array point

uint8\_t **flag**

Advertising flag of discovery mode, see BLE\_ADV\_DATA\_FLAG detail

struct **esp\_ble\_scan\_params\_t**

Ble scan parameters.

### Public Members

*esp\_ble\_scan\_type\_t* **scan\_type**

Scan type

*esp\_ble\_addr\_type\_t* **own\_addr\_type**

Owner address type

*esp\_ble\_scan\_filter\_t* **scan\_filter\_policy**

Scan filter policy

uint16\_t **scan\_interval**

Scan interval. This is defined as the time interval from when the Controller started its last LE scan until it begins the subsequent LE scan. Range: 0x0004 to 0x4000 Default: 0x0010 (10 ms) Time = N \* 0.625 msec Time Range: 2.5 msec to 10.24 seconds

uint16\_t **scan\_window**

Scan window. The duration of the LE scan. LE\_Scan\_Window shall be less than or equal to LE\_Scan\_Interval Range: 0x0004 to 0x4000 Default: 0x0010 (10 ms) Time = N \* 0.625 msec Time Range: 2.5 msec to 10240 msec

*esp\_ble\_scan\_duplicate\_t* **scan\_duplicate**

The Scan\_Duplicates parameter controls whether the Link Layer should filter out duplicate advertising reports (BLE\_SCAN\_DUPLICATE\_ENABLE) to the Host, or if the Link Layer should generate advertising reports for each packet received

struct **esp\_gap\_conn\_params\_t**

connection parameters information

### Public Members

uint16\_t **interval**

connection interval

uint16\_t **latency**

Slave latency for the connection in number of connection events. Range: 0x0000 to 0x01F3

**uint16\_t timeout**

Supervision timeout for the LE Link. Range: 0x000A to 0x0C80. Mandatory Range: 0x000A to 0x0C80  
Time = N \* 10 msec Time Range: 100 msec to 32 seconds

struct **esp\_ble\_conn\_update\_params\_t**

Connection update parameters.

**Public Members***esp\_bd\_addr\_t* **bda**

Bluetooth device address

**uint16\_t min\_int**

Min connection interval

**uint16\_t max\_int**

Max connection interval

**uint16\_t latency**

Slave latency for the connection in number of connection events. Range: 0x0000 to 0x01F3

**uint16\_t timeout**

Supervision timeout for the LE Link. Range: 0x000A to 0x0C80. Mandatory Range: 0x000A to 0x0C80  
Time = N \* 10 msec Time Range: 100 msec to 32 seconds

struct **esp\_ble\_pkt\_data\_length\_params\_t**

BLE pkt data length keys.

**Public Members****uint16\_t rx\_len**

pkt rx data length value

**uint16\_t tx\_len**

pkt tx data length value

struct **esp\_ble\_penc\_keys\_t**

BLE encryption keys.

**Public Members***esp\_bt\_octet16\_t* **ltk**

The long term key

*esp\_bt\_octet8\_t* **rand**

The random number

uint16\_t **ediv**

The ediv value

uint8\_t **sec\_level**

The security level of the security link

uint8\_t **key\_size**

The key size(7~16) of the security link

struct **esp\_ble\_pcsrkeys\_t**

BLE CSRK keys.

### Public Members

uint32\_t **counter**

The counter

*esp\_bt\_octet16\_t* **csrkey**

The csrkey

uint8\_t **sec\_level**

The security level

struct **esp\_ble\_pidkeys\_t**

BLE pid keys.

### Public Members

*esp\_bt\_octet16\_t* **irk**

The irk value

*esp\_ble\_addr\_type\_t* **addr\_type**

The address type

*esp\_bd\_addr\_t* **static\_addr**

The static address

struct **esp\_ble\_lenckeys\_t**

BLE Encryption reproduction keys.

### Public Members

*esp\_bt\_octet16\_t* **ltk**

The long term key

uint16\_t **div**

The div value

uint8\_t **key\_size**

The key size of the security link

uint8\_t **sec\_level**

The security level of the security link

struct **esp\_ble\_lcsrk\_keys**

BLE SRK keys.

### Public Members

uint32\_t **counter**

The counter value

uint16\_t **div**

The div value

uint8\_t **sec\_level**

The security level of the security link

*esp\_bt\_octet16\_t* **csrk**

The csrk key value

struct **esp\_ble\_sec\_key\_notif\_t**

Structure associated with ESP\_KEY\_NOTIF\_EVT.

### Public Members

*esp\_bd\_addr\_t* **bd\_addr**

peer address

uint32\_t **passkey**

the numeric value for comparison. If just\_works, do not show this number to UI

struct **esp\_ble\_sec\_req\_t**

Structure of the security request.

### Public Members

*esp\_bd\_addr\_t* **bd\_addr**

peer address

struct **esp\_ble\_bond\_key\_info\_t**

struct type of the bond key information value

**Public Members**

*esp\_ble\_key\_mask\_t* **key\_mask**

the key mask to indicate witch key is present

*esp\_ble\_penc\_keys\_t* **penc\_key**

received peer encryption key

*esp\_ble\_pcsrkeys\_t* **pcsrk\_key**

received peer device SRK

*esp\_ble\_pidkeys\_t* **pid\_key**

peer device ID key

struct **esp\_ble\_bond\_dev\_t**

struct type of the bond device value

**Public Members**

*esp\_bd\_addr\_t* **bd\_addr**

peer address

*esp\_ble\_bond\_key\_info\_t* **bond\_key**

the bond key information

struct **esp\_ble\_key\_t**

union type of the security key value

**Public Members**

*esp\_bd\_addr\_t* **bd\_addr**

peer address

*esp\_ble\_key\_type\_t* **key\_type**

key type of the security link

*esp\_ble\_key\_value\_t* **p\_key\_value**

the pointer to the key value

struct **esp\_ble\_local\_id\_keys\_t**

structure type of the ble local id keys value

**Public Members**

*esp\_bt\_octet16\_t* **ir**

the 16 bits of the ir value



*esp\_bt\_octet16\_t* **irk**

the 16 bits of the ir key value

*esp\_bt\_octet16\_t* **dhk**

the 16 bits of the dh key value

struct **esp\_ble\_local\_oob\_data\_t**

structure type of the ble local oob data value

### Public Members

*esp\_bt\_octet16\_t* **oob\_c**

the 128 bits of confirmation value

*esp\_bt\_octet16\_t* **oob\_r**

the 128 bits of randomizer value

struct **esp\_ble\_auth\_cmpl\_t**

Structure associated with ESP\_AUTH\_CMPL\_EVT.

### Public Members

*esp\_bd\_addr\_t* **bd\_addr**

BD address of peer device

bool **key\_present**

True if the link key value is valid; false otherwise

*esp\_link\_key* **key**

Link key associated with peer device

uint8\_t **key\_type**

The type of link key

bool **success**

True if authentication succeeded; false otherwise

*esp\_ble\_auth\_fail\_rsn\_t* **fail\_reason**

The HCI reason/error code for failure when success is false

*esp\_ble\_addr\_type\_t* **addr\_type**

Peer device address type

*esp\_bt\_dev\_type\_t* **dev\_type**

Device type

*esp\_ble\_auth\_req\_t* **auth\_mode**

Authentication mode

struct **esp\_ble\_gap\_ext\_adv\_params\_t**

ext adv parameters

### **Public Members**

*esp\_ble\_ext\_adv\_type\_mask\_t* **type**

ext adv type

uint32\_t **interval\_min**

ext adv minimum interval

uint32\_t **interval\_max**

ext adv maximum interval

*esp\_ble\_adv\_channel\_t* **channel\_map**

ext adv channel map

*esp\_ble\_addr\_type\_t* **own\_addr\_type**

ext adv own address type

*esp\_ble\_addr\_type\_t* **peer\_addr\_type**

ext adv peer address type

*esp\_bd\_addr\_t* **peer\_addr**

ext adv peer address

*esp\_ble\_adv\_filter\_t* **filter\_policy**

ext adv filter policy

int8\_t **tx\_power**

ext adv tx power

*esp\_ble\_gap\_pri\_phy\_t* **primary\_phy**

ext adv primary phy

uint8\_t **max\_skip**

ext adv maximum skip

*esp\_ble\_gap\_phy\_t* **secondary\_phy**

ext adv secondary phy

uint8\_t **sid**

ext adv sid

bool **scan\_req\_notif**  
ext adv scan request event notify

struct **esp\_ble\_ext\_scan\_cfg\_t**  
ext scan config

### Public Members

*esp\_ble\_scan\_type\_t* **scan\_type**  
ext scan type

uint16\_t **scan\_interval**  
ext scan interval

uint16\_t **scan\_window**  
ext scan window

struct **esp\_ble\_ext\_scan\_params\_t**  
ext scan parameters

### Public Members

*esp\_ble\_addr\_type\_t* **own\_addr\_type**  
ext scan own address type

*esp\_ble\_scan\_filter\_t* **filter\_policy**  
ext scan filter policy

*esp\_ble\_scan\_duplicate\_t* **scan\_duplicate**  
ext scan duplicate scan

*esp\_ble\_ext\_scan\_cfg\_mask\_t* **cfg\_mask**  
ext scan config mask

*esp\_ble\_ext\_scan\_cfg\_t* **uncoded\_cfg**  
ext scan uncoded config parameters

*esp\_ble\_ext\_scan\_cfg\_t* **coded\_cfg**  
ext scan coded config parameters

struct **esp\_ble\_gap\_conn\_params\_t**  
create extend connection parameters

### Public Members

uint16\_t **scan\_interval**

init scan interval

uint16\_t **scan\_window**

init scan window

uint16\_t **interval\_min**

minimum interval

uint16\_t **interval\_max**

maximum interval

uint16\_t **latency**

ext scan type

uint16\_t **supervision\_timeout**

connection supervision timeout

uint16\_t **min\_ce\_len**

minimum ce length

uint16\_t **max\_ce\_len**

maximum ce length

struct **esp\_ble\_gap\_ext\_adv\_t**

extend adv enable parameters

### Public Members

uint8\_t **instance**

advertising handle

int **duration**

advertising duration

int **max\_events**

maximum number of extended advertising events

struct **esp\_ble\_gap\_periodic\_adv\_params\_t**

periodic adv parameters

### Public Members

uint16\_t **interval\_min**

periodic advertising minimum interval

uint16\_t **interval\_max**  
periodic advertising maximum interval

uint8\_t **properties**  
periodic advertising properties

struct **esp\_ble\_gap\_periodic\_adv\_sync\_params\_t**  
periodic adv sync parameters

### Public Members

*esp\_ble\_gap\_sync\_t* **filter\_policy**

Configures the filter policy for periodic advertising sync: 0: Use Advertising SID, Advertiser Address Type, and Advertiser Address parameters to determine the advertiser to listen to. 1: Use the Periodic Advertiser List to determine the advertiser to listen to.

uint8\_t **sid**  
SID of the periodic advertising

*esp\_ble\_addr\_type\_t* **addr\_type**  
Address type of the periodic advertising

*esp\_bd\_addr\_t* **addr**  
Address of the periodic advertising

uint16\_t **skip**  
Maximum number of periodic advertising events that can be skipped

uint16\_t **sync\_timeout**  
Synchronization timeout

struct **esp\_ble\_gap\_ext\_adv\_report\_t**  
extend adv report parameters

### Public Members

*esp\_ble\_gap\_adv\_type\_t* **event\_type**  
extend advertising type

uint8\_t **addr\_type**  
extend advertising address type

*esp\_bd\_addr\_t* **addr**  
extend advertising address

*esp\_ble\_gap\_pri\_phy\_t* **primary\_phy**  
extend advertising primary phy

*esp\_ble\_gap\_phy\_t* **secondly\_phy**

extend advertising secondary phy

uint8\_t **sid**

extend advertising sid

uint8\_t **tx\_power**

extend advertising tx power

int8\_t **rssi**

extend advertising rssi

uint16\_t **per\_adv\_interval**

periodic advertising interval

uint8\_t **dir\_addr\_type**

direct address type

*esp\_bd\_addr\_t* **dir\_addr**

direct address

*esp\_ble\_gap\_ext\_adv\_data\_status\_t* **data\_status**

data type

uint8\_t **adv\_data\_len**

extend advertising data length

uint8\_t **adv\_data**[251]

extend advertising data

struct **esp\_ble\_gap\_periodic\_adv\_report\_t**

periodic adv report parameters

### Public Members

uint16\_t **sync\_handle**

periodic advertising train handle

uint8\_t **tx\_power**

periodic advertising tx power

int8\_t **rssi**

periodic advertising rssi

*esp\_ble\_gap\_ext\_adv\_data\_status\_t* **data\_status**

periodic advertising data type

`uint8_t data_length`  
periodic advertising data length

`uint8_t data[251]`  
periodic advertising data

struct `esp_ble_gap_periodic_adv_sync_estab_t`  
periodic adv sync establish parameters

### Public Members

`uint8_t status`  
periodic advertising sync status

`uint16_t sync_handle`  
periodic advertising train handle

`uint8_t sid`  
periodic advertising sid

`esp_ble_addr_type_t addr_type`  
periodic advertising address type

`esp_bd_addr_t adv_addr`  
periodic advertising address

`esp_ble_gap_phy_t adv_phy`  
periodic advertising adv phy type

`uint16_t period_adv_interval`  
periodic advertising interval

`uint8_t adv_clk_accuracy`  
periodic advertising clock accuracy

struct `esp_ble_dtm_enh_tx_t`  
DTM TX parameters.

### Public Members

`uint8_t tx_channel`  
channel for sending test data,  $tx\_channel = (Frequency - 2402) / 2$ , `tx_channel` range: 0x00-0x27, Frequency range: 2402 MHz to 2480 MHz

`uint8_t len_of_data`  
length in bytes of payload data in each packet

*esp\_ble\_dtm\_pkt\_payload\_t* **pkt\_payload**

packet payload type. value range: 0x00-0x07

*esp\_ble\_gap\_phy\_t* **phy**

the phy type used by the transmitter, coded phy with S=2:0x04

struct **esp\_ble\_dtm\_enh\_rx\_t**

DTM RX parameters.

### Public Members

uint8\_t **rx\_channel**

channel for test data reception, rx\_channel = (Frequency -2402)/2, tx\_channel range:0x00-0x27, Frequency range: 2402 MHz to 2480 MHz

*esp\_ble\_gap\_phy\_t* **phy**

the phy type used by the receiver, 1M phy: 0x01, 2M phy:0x02, coded phy:0x03

uint8\_t **modulation\_idx**

modulation index, 0x00:standard modulation index, 0x01:stable modulation index

struct **esp\_ble\_gap\_past\_params\_t**

periodic adv sync transfer parameters

### Public Members

*esp\_ble\_gap\_past\_mode\_t* **mode**

periodic advertising sync transfer mode

uint16\_t **skip**

the number of periodic advertising packets that can be skipped

uint16\_t **sync\_timeout**

synchronization timeout for the periodic advertising train

uint8\_t **cte\_type**

periodic advertising sync transfer CET type

### Macros

**ESP\_BLE\_ADV\_FLAG\_LIMIT\_DISC**

BLE\_ADV\_DATA\_FLAG data flag bit definition used for advertising data flag.

**ESP\_BLE\_ADV\_FLAG\_GEN\_DISC**

**ESP\_BLE\_ADV\_FLAG\_BREDR\_NOT\_SPT**



**ESP\_BLE\_ADV\_FLAG\_DMT\_CONTROLLER\_SPT**

**ESP\_BLE\_ADV\_FLAG\_DMT\_HOST\_SPT**

**ESP\_BLE\_ADV\_FLAG\_NON\_LIMIT\_DISC**

**ESP\_LE\_KEY\_NONE**

relate to BTM\_LE\_KEY\_XXX in stack/btm\_api.h

No encryption key

**ESP\_LE\_KEY\_PENC**

encryption key, encryption information of peer device

**ESP\_LE\_KEY\_PID**

identity key of the peer device

**ESP\_LE\_KEY\_PCSRK**

peer SRK

**ESP\_LE\_KEY\_PLK**

Link key

**ESP\_LE\_KEY\_LLK**

peer link key

**ESP\_LE\_KEY\_LENC**

master role security information:div

**ESP\_LE\_KEY\_LID**

master device ID key

**ESP\_LE\_KEY\_LCSRK**

local CSRK has been deliver to peer

**ESP\_LE\_AUTH\_NO\_BOND**

relate to BTM\_LE\_AUTH\_XXX in stack/btm\_api.h

0 no bondingv

**ESP\_LE\_AUTH\_BOND**

1 << 0 device in the bonding with peer

**ESP\_LE\_AUTH\_REQ\_MITM**

1 << 2 man in the middle attack

**ESP\_LE\_AUTH\_REQ\_BOND\_MITM**

0101 banding with man in the middle attack

**ESP\_LE\_AUTH\_REQ\_SC\_ONLY**

1 « 3 secure connection

**ESP\_LE\_AUTH\_REQ\_SC\_BOND**

1001 secure connection with bond

**ESP\_LE\_AUTH\_REQ\_SC\_MITM**

1100 secure conn with MITM

**ESP\_LE\_AUTH\_REQ\_SC\_MITM\_BOND**

1101 SC with MITM and Bonding

**ESP\_BLE\_ONLY\_ACCEPT\_SPECIFIED\_AUTH\_DISABLE**

authentication disable

**ESP\_BLE\_ONLY\_ACCEPT\_SPECIFIED\_AUTH\_ENABLE**

authentication enable

**ESP\_BLE\_OOB\_DISABLE**

disable the out of bond

**ESP\_BLE\_OOB\_ENABLE**

enable the out of bond

**ESP\_IO\_CAP\_OUT**

relate to BTM\_IO\_CAP\_xxx in stack/btm\_api.h

DisplayOnly

**ESP\_IO\_CAP\_IO**

DisplayYesNo

**ESP\_IO\_CAP\_IN**

KeyboardOnly

**ESP\_IO\_CAP\_NONE**

NoInputNoOutput

**ESP\_IO\_CAP\_KBDISP**

Keyboard display

**ESP\_BLE\_APPEARANCE\_UNKNOWN**

relate to BTM\_BLE\_APPEARANCE\_UNKNOWN in stack/btm\_ble\_api.h

**ESP\_BLE\_APPEARANCE\_GENERIC\_PHONE**

relate to BTM\_BLE\_APPEARANCE\_GENERIC\_PHONE in stack/btm\_ble\_api.h

**ESP\_BLE\_APPEARANCE\_GENERIC\_COMPUTER**

relate to BTM\_BLE\_APPEARANCE\_GENERIC\_COMPUTER in stack/btm\_ble\_api.h

**ESP\_BLE\_APPEARANCE\_GENERIC\_WATCH**

relate to BTM\_BLE\_APPEARANCE\_GENERIC\_WATCH in stack/btm\_ble\_api.h

**ESP\_BLE\_APPEARANCE\_SPORTS\_WATCH**

relate to BTM\_BLE\_APPEARANCE\_SPORTS\_WATCH in stack/btm\_ble\_api.h

**ESP\_BLE\_APPEARANCE\_GENERIC\_CLOCK**

relate to BTM\_BLE\_APPEARANCE\_GENERIC\_CLOCK in stack/btm\_ble\_api.h

**ESP\_BLE\_APPEARANCE\_GENERIC\_DISPLAY**

relate to BTM\_BLE\_APPEARANCE\_GENERIC\_DISPLAY in stack/btm\_ble\_api.h

**ESP\_BLE\_APPEARANCE\_GENERIC\_REMOTE**

relate to BTM\_BLE\_APPEARANCE\_GENERIC\_REMOTE in stack/btm\_ble\_api.h

**ESP\_BLE\_APPEARANCE\_GENERIC\_EYEGLASSES**

relate to BTM\_BLE\_APPEARANCE\_GENERIC\_EYEGLASSES in stack/btm\_ble\_api.h

**ESP\_BLE\_APPEARANCE\_GENERIC\_TAG**

relate to BTM\_BLE\_APPEARANCE\_GENERIC\_TAG in stack/btm\_ble\_api.h

**ESP\_BLE\_APPEARANCE\_GENERIC\_KEYRING**

relate to BTM\_BLE\_APPEARANCE\_GENERIC\_KEYRING in stack/btm\_ble\_api.h

**ESP\_BLE\_APPEARANCE\_GENERIC\_MEDIA\_PLAYER**

relate to BTM\_BLE\_APPEARANCE\_GENERIC\_MEDIA\_PLAYER in stack/btm\_ble\_api.h

**ESP\_BLE\_APPEARANCE\_GENERIC\_BARCODE\_SCANNER**

relate to BTM\_BLE\_APPEARANCE\_GENERIC\_BARCODE\_SCANNER in stack/btm\_ble\_api.h

**ESP\_BLE\_APPEARANCE\_GENERIC\_THERMOMETER**

relate to BTM\_BLE\_APPEARANCE\_GENERIC\_THERMOMETER in stack/btm\_ble\_api.h

**ESP\_BLE\_APPEARANCE\_THERMOMETER\_EAR**

relate to BTM\_BLE\_APPEARANCE\_THERMOMETER\_EAR in stack/btm\_ble\_api.h

**ESP\_BLE\_APPEARANCE\_GENERIC\_HEART\_RATE**

relate to BTM\_BLE\_APPEARANCE\_GENERIC\_HEART\_RATE in stack/btm\_ble\_api.h

**ESP\_BLE\_APPEARANCE\_HEART\_RATE\_BELT**

relate to BTM\_BLE\_APPEARANCE\_HEART\_RATE\_BELT in stack/btm\_ble\_api.h

**ESP\_BLE\_APPEARANCE\_GENERIC\_BLOOD\_PRESSURE**

relate to BTM\_BLE\_APPEARANCE\_GENERIC\_BLOOD\_PRESSURE in stack/btm\_ble\_api.h

**ESP\_BLE\_APPEARANCE\_BLOOD\_PRESSURE\_ARM**

relate to BTM\_BLE\_APPEARANCE\_BLOOD\_PRESSURE\_ARM in stack/btm\_ble\_api.h

**ESP\_BLE\_APPEARANCE\_BLOOD\_PRESSURE\_WRIST**

relate to BTM\_BLE\_APPEARANCE\_BLOOD\_PRESSURE\_WRIST in stack/btm\_ble\_api.h

**ESP\_BLE\_APPEARANCE\_GENERIC\_HID**

relate to BTM\_BLE\_APPEARANCE\_GENERIC\_HID in stack/btm\_ble\_api.h

**ESP\_BLE\_APPEARANCE\_HID\_KEYBOARD**

relate to BTM\_BLE\_APPEARANCE\_HID\_KEYBOARD in stack/btm\_ble\_api.h

**ESP\_BLE\_APPEARANCE\_HID\_MOUSE**

relate to BTM\_BLE\_APPEARANCE\_HID\_MOUSE in stack/btm\_ble\_api.h

**ESP\_BLE\_APPEARANCE\_HID\_JOYSTICK**

relate to BTM\_BLE\_APPEARANCE\_HID\_JOYSTICK in stack/btm\_ble\_api.h

**ESP\_BLE\_APPEARANCE\_HID\_GAMEPAD**

relate to BTM\_BLE\_APPEARANCE\_HID\_GAMEPAD in stack/btm\_ble\_api.h

**ESP\_BLE\_APPEARANCE\_HID\_DIGITIZER\_TABLET**

relate to BTM\_BLE\_APPEARANCE\_HID\_DIGITIZER\_TABLET in stack/btm\_ble\_api.h

**ESP\_BLE\_APPEARANCE\_HID\_CARD\_READER**

relate to BTM\_BLE\_APPEARANCE\_HID\_CARD\_READER in stack/btm\_ble\_api.h

**ESP\_BLE\_APPEARANCE\_HID\_DIGITAL\_PEN**

relate to BTM\_BLE\_APPEARANCE\_HID\_DIGITAL\_PEN in stack/btm\_ble\_api.h

**ESP\_BLE\_APPEARANCE\_HID\_BARCODE\_SCANNER**

relate to BTM\_BLE\_APPEARANCE\_HID\_BARCODE\_SCANNER in stack/btm\_ble\_api.h

**ESP\_BLE\_APPEARANCE\_GENERIC\_GLUKOSE**

relate to BTM\_BLE\_APPEARANCE\_GENERIC\_GLUKOSE in stack/btm\_ble\_api.h

**ESP\_BLE\_APPEARANCE\_GENERIC\_WALKING**

relate to BTM\_BLE\_APPEARANCE\_GENERIC\_WALKING in stack/btm\_ble\_api.h

**ESP\_BLE\_APPEARANCE\_WALKING\_IN\_SHOE**

relate to BTM\_BLE\_APPEARANCE\_WALKING\_IN\_SHOE in stack/btm\_ble\_api.h

**ESP\_BLE\_APPEARANCE\_WALKING\_ON\_SHOE**

relate to BTM\_BLE\_APPEARANCE\_WALKING\_ON\_SHOE in stack/btm\_ble\_api.h

**ESP\_BLE\_APPEARANCE\_WALKING\_ON\_HIP**

relate to BTM\_BLE\_APPEARANCE\_WALKING\_ON\_HIP in stack/btm\_ble\_api.h

**ESP\_BLE\_APPEARANCE\_GENERIC\_CYCLING**

relate to BTM\_BLE\_APPEARANCE\_GENERIC\_CYCLING in stack/btm\_ble\_api.h

**ESP\_BLE\_APPEARANCE\_CYCLING\_COMPUTER**

relate to BTM\_BLE\_APPEARANCE\_CYCLING\_COMPUTER in stack/btm\_ble\_api.h

**ESP\_BLE\_APPEARANCE\_CYCLING\_SPEED**

relate to BTM\_BLE\_APPEARANCE\_CYCLING\_SPEED in stack/btm\_ble\_api.h

**ESP\_BLE\_APPEARANCE\_CYCLING\_CADENCE**

relate to BTM\_BLE\_APPEARANCE\_CYCLING\_CADENCE in stack/btm\_ble\_api.h

**ESP\_BLE\_APPEARANCE\_CYCLING\_POWER**

relate to BTM\_BLE\_APPEARANCE\_CYCLING\_POWER in stack/btm\_ble\_api.h

**ESP\_BLE\_APPEARANCE\_CYCLING\_SPEED\_CADENCE**

relate to BTM\_BLE\_APPEARANCE\_CYCLING\_SPEED\_CADENCE in stack/btm\_ble\_api.h

**ESP\_BLE\_APPEARANCE\_STANDALONE\_SPEAKER**

relate to BTM\_BLE\_APPEARANCE\_STANDALONE\_SPEAKER in stack/btm\_ble\_api.h

**ESP\_BLE\_APPEARANCE\_GENERIC\_PULSE\_OXIMETER**

relate to BTM\_BLE\_APPEARANCE\_GENERIC\_PULSE\_OXIMETER in stack/btm\_ble\_api.h

**ESP\_BLE\_APPEARANCE\_PULSE\_OXIMETER\_FINGERTIP**

relate to BTM\_BLE\_APPEARANCE\_PULSE\_OXIMETER\_FINGERTIP in stack/btm\_ble\_api.h

**ESP\_BLE\_APPEARANCE\_PULSE\_OXIMETER\_WRIST**

relate to BTM\_BLE\_APPEARANCE\_PULSE\_OXIMETER\_WRIST in stack/btm\_ble\_api.h

**ESP\_BLE\_APPEARANCE\_GENERIC\_WEIGHT**

relate to BTM\_BLE\_APPEARANCE\_GENERIC\_WEIGHT in stack/btm\_ble\_api.h

**ESP\_BLE\_APPEARANCE\_GENERIC\_PERSONAL\_MOBILITY\_DEVICE**

relate to BTM\_BLE\_APPEARANCE\_GENERIC\_PERSONAL\_MOBILITY\_DEVICE in stack/btm\_ble\_api.h

**ESP\_BLE\_APPEARANCE\_POWERED\_WHEELCHAIR**

relate to BTM\_BLE\_APPEARANCE\_POWERED\_WHEELCHAIR in stack/btm\_ble\_api.h

**ESP\_BLE\_APPEARANCE\_MOBILITY\_SCOOTER**

relate to BTM\_BLE\_APPEARANCE\_MOBILITY\_SCOOTER in stack/btm\_ble\_api.h

**ESP\_BLE\_APPEARANCE\_GENERIC\_CONTINUOUS\_GLUCOSE\_MONITOR**

relate to BTM\_BLE\_APPEARANCE\_GENERIC\_CONTINUOUS\_GLUCOSE\_MONITOR in stack/btm\_ble\_api.h

**ESP\_BLE\_APPEARANCE\_GENERIC\_INSULIN\_PUMP**

relate to BTM\_BLE\_APPEARANCE\_GENERIC\_INSULIN\_PUMP in stack/btm\_ble\_api.h

**ESP\_BLE\_APPEARANCE\_INSULIN\_PUMP\_DURABLE\_PUMP**

relate to BTM\_BLE\_APPEARANCE\_INSULIN\_PUMP\_DURABLE\_PUMP in stack/btm\_ble\_api.h

**ESP\_BLE\_APPEARANCE\_INSULIN\_PUMP\_PATCH\_PUMP**

relate to BTM\_BLE\_APPEARANCE\_INSULIN\_PUMP\_PATCH\_PUMP in stack/btm\_ble\_api.h

**ESP\_BLE\_APPEARANCE\_INSULIN\_PEN**

relate to BTM\_BLE\_APPEARANCE\_INSULIN\_PEN in stack/btm\_ble\_api.h

**ESP\_BLE\_APPEARANCE\_GENERIC\_MEDICATION\_DELIVERY**

relate to BTM\_BLE\_APPEARANCE\_GENERIC\_MEDICATION\_DELIVERY in stack/btm\_ble\_api.h

**ESP\_BLE\_APPEARANCE\_GENERIC\_OUTDOOR\_SPORTS**

relate to BTM\_BLE\_APPEARANCE\_GENERIC\_OUTDOOR\_SPORTS in stack/btm\_ble\_api.h

**ESP\_BLE\_APPEARANCE\_OUTDOOR\_SPORTS\_LOCATION**

relate to BTM\_BLE\_APPEARANCE\_OUTDOOR\_SPORTS\_LOCATION in stack/btm\_ble\_api.h

**ESP\_BLE\_APPEARANCE\_OUTDOOR\_SPORTS\_LOCATION\_AND\_NAV**

relate to BTM\_BLE\_APPEARANCE\_OUTDOOR\_SPORTS\_LOCATION\_AND\_NAV in stack/btm\_ble\_api.h

**ESP\_BLE\_APPEARANCE\_OUTDOOR\_SPORTS\_LOCATION\_POD**

relate to BTM\_BLE\_APPEARANCE\_OUTDOOR\_SPORTS\_LOCATION\_POD in stack/btm\_ble\_api.h

**ESP\_BLE\_APPEARANCE\_OUTDOOR\_SPORTS\_LOCATION\_POD\_AND\_NAV**

relate to BTM\_BLE\_APPEARANCE\_OUTDOOR\_SPORTS\_LOCATION\_POD\_AND\_NAV in stack/btm\_ble\_api.h

**BLE\_DTM\_PKT\_PAYLOAD\_0x00**

PRBS9 sequence ‘1111111100000111101...’ (in transmission order) as described in [Vol 6] Part F, Section 4.1.5

**BLE\_DTM\_PKT\_PAYLOAD\_0x01**

Repeated ‘11110000’ (in transmission order) sequence as described in [Vol 6] Part F, Section 4.1.5

**BLE\_DTM\_PKT\_PAYLOAD\_0x02**

Repeated ‘10101010’ (in transmission order) sequence as described in [Vol 6] Part F, Section 4.1.5

**BLE\_DTM\_PKT\_PAYLOAD\_0x03**

PRBS15 sequence as described in [Vol 6] Part F, Section 4.1.5

**BLE\_DTM\_PKT\_PAYLOAD\_0x04**

Repeated ‘11111111’ (in transmission order) sequence

**BLE\_DTM\_PKT\_PAYLOAD\_0x05**

Repeated ‘00000000’ (in transmission order) sequence

**BLE\_DTM\_PKT\_PAYLOAD\_0x06**

Repeated ‘00001111’ (in transmission order) sequence

**BLE\_DTM\_PKT\_PAYLOAD\_0x07**

Repeated '01010101' (in transmission order) sequence

**BLE\_DTM\_PKT\_PAYLOAD\_MAX**

0x08 ~ 0xFF, Reserved for future use

**ESP\_GAP\_BLE\_CHANNELS\_LEN**

channel length

**ESP\_GAP\_BLE\_ADD\_WHITELIST\_COMPLETE\_EVT**

This is the old name, just for backwards compatibility.

**ESP\_BLE\_ADV\_DATA\_LEN\_MAX**

Advertising data maximum length.

**ESP\_BLE\_SCAN\_RSP\_DATA\_LEN\_MAX**

Scan response data maximum length.

**VENDOR\_HCI\_CMD\_MASK**

**BLE\_BIT** (n)

**ESP\_BLE\_GAP\_SET\_EXT\_ADV\_PROP\_NONCONN\_NONSCANNABLE\_UNDIRECTED**

Non-Connectable and Non-Scannable Undirected advertising

**ESP\_BLE\_GAP\_SET\_EXT\_ADV\_PROP\_CONNECTABLE**

Connectable advertising

**ESP\_BLE\_GAP\_SET\_EXT\_ADV\_PROP\_SCANNABLE**

Scannable advertising

**ESP\_BLE\_GAP\_SET\_EXT\_ADV\_PROP\_DIRECTED**

Directed advertising

**ESP\_BLE\_GAP\_SET\_EXT\_ADV\_PROP\_HD\_DIRECTED**

High Duty Cycle Directed Connectable advertising ( $\leq 3.75$  ms Advertising Interval)

**ESP\_BLE\_GAP\_SET\_EXT\_ADV\_PROP\_LEGACY**

Use legacy advertising PDUs

**ESP\_BLE\_GAP\_SET\_EXT\_ADV\_PROP\_ANON\_ADV**

Omit advertiser's address from all PDUs ("anonymous advertising")

**ESP\_BLE\_GAP\_SET\_EXT\_ADV\_PROP\_INCLUDE\_TX\_PWR**

Include TxPower in the extended header of the advertising PDU

**ESP\_BLE\_GAP\_SET\_EXT\_ADV\_PROP\_MASK**

Reserved for future use If extended advertising PDU types are being used (bit 4 = 0) then: The advertisement shall not be both connectable and scannable. High duty cycle directed connectable advertising ( $\leq 3.75$  ms advertising interval) shall not be used (bit 3 = 0) ADV\_IND

**ESP\_BLE\_GAP\_SET\_EXT\_ADV\_PROP\_LEGACY\_IND**

ADV\_DIRECT\_IND (low duty cycle)

**ESP\_BLE\_GAP\_SET\_EXT\_ADV\_PROP\_LEGACY\_LD\_DIR**

ADV\_DIRECT\_IND (high duty cycle)

**ESP\_BLE\_GAP\_SET\_EXT\_ADV\_PROP\_LEGACY\_HD\_DIR**

ADV\_SCAN\_IND

**ESP\_BLE\_GAP\_SET\_EXT\_ADV\_PROP\_LEGACY\_SCAN**

ADV\_NONCONN\_IND

**ESP\_BLE\_GAP\_SET\_EXT\_ADV\_PROP\_LEGACY\_NONCONN**

**ESP\_BLE\_GAP\_PHY\_1M**

Secondary Advertisement PHY is LE1M

**ESP\_BLE\_GAP\_PHY\_2M**

Secondary Advertisement PHY is LE2M

**ESP\_BLE\_GAP\_PHY\_CODED**

Secondary Advertisement PHY is LE Coded

**ESP\_BLE\_GAP\_NO\_PREFER\_TRANSMIT\_PHY**

No Prefer TX PHY supported by controller

**ESP\_BLE\_GAP\_NO\_PREFER\_RECEIVE\_PHY**

No Prefer RX PHY supported by controller

**ESP\_BLE\_GAP\_PRI\_PHY\_1M**

Primary phy only support 1M and LE coded phy.

Primary Phy is LE1M

**ESP\_BLE\_GAP\_PRI\_PHY\_CODED**

Primary Phy is LE CODED

**ESP\_BLE\_GAP\_PHY\_1M\_PREF\_MASK**

The Host prefers use the LE1M transmitter or receiver PHY

**ESP\_BLE\_GAP\_PHY\_2M\_PREF\_MASK**

The Host prefers use the LE2M transmitter or receiver PHY

**ESP\_BLE\_GAP\_PHY\_CODED\_PREF\_MASK**

The Host prefers use the LE CODED transmitter or receiver PHY

**ESP\_BLE\_GAP\_PHY\_OPTIONS\_NO\_PREF**

The Host has no preferred coding when transmitting on the LE Coded PHY



**ESP\_BLE\_GAP\_PHY\_OPTIONS\_PREF\_S2\_CODING**

The Host prefers that S=2 coding be used when transmitting on the LE Coded PHY

**ESP\_BLE\_GAP\_PHY\_OPTIONS\_PREF\_S8\_CODING**

The Host prefers that S=8 coding be used when transmitting on the LE Coded PHY

**ESP\_BLE\_GAP\_EXT\_SCAN\_CFG\_UNCODE\_MASK**

Scan Advertisements on the LE1M PHY

**ESP\_BLE\_GAP\_EXT\_SCAN\_CFG\_CODE\_MASK**

Scan advertisements on the LE coded PHY

**ESP\_BLE\_GAP\_EXT\_ADV\_DATA\_COMPLETE**

Advertising data.

extended advertising data compete

**ESP\_BLE\_GAP\_EXT\_ADV\_DATA\_INCOMPLETE**

extended advertising data incomplete

**ESP\_BLE\_GAP\_EXT\_ADV\_DATA\_TRUNCATED**

extended advertising data truncated mode

**ESP\_BLE\_GAP\_SYNC\_POLICY\_BY\_ADV\_INFO**

Advertising SYNC policy.

sync policy by advertising info

**ESP\_BLE\_GAP\_SYNC\_POLICY\_BY\_PERIODIC\_LIST**

periodic advertising sync policy

**ESP\_BLE\_ADV\_REPORT\_EXT\_ADV\_IND**

Advertising report.

advertising report with extended advertising indication type

**ESP\_BLE\_ADV\_REPORT\_EXT\_SCAN\_IND**

advertising report with extended scan indication type

**ESP\_BLE\_ADV\_REPORT\_EXT\_DIRECT\_ADV**

advertising report with extended direct advertising indication type

**ESP\_BLE\_ADV\_REPORT\_EXT\_SCAN\_RSP**

advertising report with extended scan response indication type Bluetooth 5.0, Vol 2, Part E, 7.7.65.13

**ESP\_BLE\_LEGACY\_ADV\_TYPE\_IND**

advertising report with legacy advertising indication type

**ESP\_BLE\_LEGACY\_ADV\_TYPE\_DIRECT\_IND**

advertising report with legacy direct indication type

**ESP\_BLE\_LEGACY\_ADV\_TYPE\_SCAN\_IND**

advertising report with legacy scan indication type

**ESP\_BLE\_LEGACY\_ADV\_TYPE\_NONCON\_IND**

advertising report with legacy non connectable indication type

**ESP\_BLE\_LEGACY\_ADV\_TYPE\_SCAN\_RSP\_TO\_ADV\_IND**

advertising report with legacy scan response indication type

**ESP\_BLE\_LEGACY\_ADV\_TYPE\_SCAN\_RSP\_TO\_ADV\_SCAN\_IND**

advertising report with legacy advertising with scan response indication type

**EXT\_ADV\_TX\_PWR\_NO\_PREFERENCE**

Extend advertising tx power, range: [-127, +126] dBm.

host has no preference for tx power

**EXT\_ADV\_NUM\_SETS\_MAX**

max number of advertising sets to enable or disable

max evt instance num

**ESP\_BLE\_GAP\_PAST\_MODE\_NO\_SYNC\_EVT**

Periodic advertising sync trans mode.

No attempt is made to sync and no periodic adv sync transfer received event

**ESP\_BLE\_GAP\_PAST\_MODE\_NO\_REPORT\_EVT**

An periodic adv sync transfer received event and no periodic adv report events

**ESP\_BLE\_GAP\_PAST\_MODE\_DUP\_FILTER\_DISABLED**

Periodic adv report events will be enabled with duplicate filtering disabled

**ESP\_BLE\_GAP\_PAST\_MODE\_DUP\_FILTER\_ENABLED**

Periodic adv report events will be enabled with duplicate filtering enabled

**Type Definitions**

```
typedef uint8_t esp_ble_key_type_t
```

```
typedef uint8_t esp_ble_auth_req_t
```

combination of the above bit pattern

```
typedef uint8_t esp_ble_io_cap_t
```

combination of the io capability

```
typedef uint8_t esp_ble_dtm_pkt_payload_t
```

```
typedef uint8_t esp_gap_ble_channels[ESP_GAP_BLE_CHANNELS_LEN]
```

```
typedef uint8_t esp_duplicate_info_t[ESP_BD_ADDR_LEN]
```

```
typedef uint16_t esp_ble_ext_adv_type_mask_t
```

```
typedef uint8_t esp_ble_gap_phy_t
```

```
typedef uint8_t esp_ble_gap_all_phys_t
```

```
typedef uint8_t esp_ble_gap_pri_phy_t
```

```
typedef uint8_t esp_ble_gap_phy_mask_t
```

```
typedef uint16_t esp_ble_gap_prefer_phy_options_t
```

```
typedef uint8_t esp_ble_ext_scan_cfg_mask_t
```

```
typedef uint8_t esp_ble_gap_ext_adv_data_status_t
```

```
typedef uint8_t esp_ble_gap_sync_t
```

```
typedef uint8_t esp_ble_gap_adv_type_t
```

```
typedef uint8_t esp_ble_gap_past_mode_t
```

```
typedef void (*esp_gap_ble_cb_t)(esp_gap_ble_cb_event_t event, esp_ble_gap_cb_param_t *param)
```

GAP callback function type.

**Param event** : Event type

**Param param** : Point to callback parameter, currently is union type

## Enumerations

```
enum esp_gap_ble_cb_event_t
```

GAP BLE callback event type.

*Values:*

enumerator **ESP\_GAP\_BLE\_ADV\_DATA\_SET\_COMPLETE\_EVT**

When advertising data set complete, the event comes

enumerator **ESP\_GAP\_BLE\_SCAN\_RSP\_DATA\_SET\_COMPLETE\_EVT**

When scan response data set complete, the event comes

enumerator **ESP\_GAP\_BLE\_SCAN\_PARAM\_SET\_COMPLETE\_EVT**

When scan parameters set complete, the event comes

enumerator **ESP\_GAP\_BLE\_SCAN\_RESULT\_EVT**

When one scan result ready, the event comes each time

enumerator **ESP\_GAP\_BLE\_ADV\_DATA\_RAW\_SET\_COMPLETE\_EVT**

When raw advertising data set complete, the event comes

enumerator **ESP\_GAP\_BLE\_SCAN\_RSP\_DATA\_RAW\_SET\_COMPLETE\_EVT**

When raw scan response data set complete, the event comes

enumerator **ESP\_GAP\_BLE\_ADV\_START\_COMPLETE\_EVT**

When start advertising complete, the event comes

enumerator **ESP\_GAP\_BLE\_SCAN\_START\_COMPLETE\_EVT**

When start scan complete, the event comes

enumerator **ESP\_GAP\_BLE\_AUTH\_CMPL\_EVT**

Authentication complete indication.

enumerator **ESP\_GAP\_BLE\_KEY\_EVT**

BLE key event for peer device keys

enumerator **ESP\_GAP\_BLE\_SEC\_REQ\_EVT**

BLE security request

enumerator **ESP\_GAP\_BLE\_PASSKEY\_NOTIF\_EVT**

passkey notification event

enumerator **ESP\_GAP\_BLE\_PASSKEY\_REQ\_EVT**

passkey request event

enumerator **ESP\_GAP\_BLE\_OOB\_REQ\_EVT**

OOB request event

enumerator **ESP\_GAP\_BLE\_LOCAL\_IR\_EVT**

BLE local IR (identity Root 128-bit random static value used to generate Long Term Key) event

enumerator **ESP\_GAP\_BLE\_LOCAL\_ER\_EVT**

BLE local ER (Encryption Root value used to generate identity resolving key) event

enumerator **ESP\_GAP\_BLE\_NC\_REQ\_EVT**

Numeric Comparison request event

enumerator **ESP\_GAP\_BLE\_ADV\_STOP\_COMPLETE\_EVT**

When stop adv complete, the event comes

enumerator **ESP\_GAP\_BLE\_SCAN\_STOP\_COMPLETE\_EVT**

When stop scan complete, the event comes

enumerator **ESP\_GAP\_BLE\_SET\_STATIC\_RAND\_ADDR\_EVT**

When set the static rand address complete, the event comes

enumerator **ESP\_GAP\_BLE\_UPDATE\_CONN\_PARAMS\_EVT**

When update connection parameters complete, the event comes

enumerator **ESP\_GAP\_BLE\_SET\_PKT\_LENGTH\_COMPLETE\_EVT**

When set pkt length complete, the event comes

enumerator **ESP\_GAP\_BLE\_SET\_LOCAL\_PRIVACY\_COMPLETE\_EVT**

When Enable/disable privacy on the local device complete, the event comes

enumerator **ESP\_GAP\_BLE\_REMOVE\_BOND\_DEV\_COMPLETE\_EVT**

When remove the bond device complete, the event comes

enumerator **ESP\_GAP\_BLE\_CLEAR\_BOND\_DEV\_COMPLETE\_EVT**

When clear the bond device clear complete, the event comes

enumerator **ESP\_GAP\_BLE\_GET\_BOND\_DEV\_COMPLETE\_EVT**

When get the bond device list complete, the event comes

enumerator **ESP\_GAP\_BLE\_READ\_RSSI\_COMPLETE\_EVT**

When read the rssi complete, the event comes

enumerator **ESP\_GAP\_BLE\_UPDATE\_WHITELIST\_COMPLETE\_EVT**

When add or remove whitelist complete, the event comes

enumerator **ESP\_GAP\_BLE\_UPDATE\_DUPLICATE\_EXCEPTIONAL\_LIST\_COMPLETE\_EVT**

When update duplicate exceptional list complete, the event comes

enumerator **ESP\_GAP\_BLE\_SET\_CHANNELS\_EVT**

When setting BLE channels complete, the event comes

enumerator **ESP\_GAP\_BLE\_READ\_PHY\_COMPLETE\_EVT**

when reading phy complete, this event comes

enumerator **ESP\_GAP\_BLE\_SET\_PREFERRED\_DEFAULT\_PHY\_COMPLETE\_EVT**

when preferred default phy complete, this event comes

enumerator **ESP\_GAP\_BLE\_SET\_PREFERRED\_PHY\_COMPLETE\_EVT**

when preferred phy complete , this event comes

enumerator **ESP\_GAP\_BLE\_EXT\_ADV\_SET\_RAND\_ADDR\_COMPLETE\_EVT**

when extended set random address complete, the event comes

enumerator **ESP\_GAP\_BLE\_EXT\_ADV\_SET\_PARAMS\_COMPLETE\_EVT**

when extended advertising parameter complete, the event comes

enumerator **ESP\_GAP\_BLE\_EXT\_ADV\_DATA\_SET\_COMPLETE\_EVT**

when extended advertising data complete, the event comes

enumerator **ESP\_GAP\_BLE\_EXT\_SCAN\_RSP\_DATA\_SET\_COMPLETE\_EVT**

when extended scan response data complete, the event comes

enumerator **ESP\_GAP\_BLE\_EXT\_ADV\_START\_COMPLETE\_EVT**

when extended advertising start complete, the event comes

enumerator **ESP\_GAP\_BLE\_EXT\_ADV\_STOP\_COMPLETE\_EVT**

when extended advertising stop complete, the event comes

enumerator **ESP\_GAP\_BLE\_EXT\_ADV\_SET\_REMOVE\_COMPLETE\_EVT**

when extended advertising set remove complete, the event comes

enumerator **ESP\_GAP\_BLE\_EXT\_ADV\_SET\_CLEAR\_COMPLETE\_EVT**

when extended advertising set clear complete, the event comes

enumerator **ESP\_GAP\_BLE\_PERIODIC\_ADV\_SET\_PARAMS\_COMPLETE\_EVT**

when periodic advertising parameter complete, the event comes

enumerator **ESP\_GAP\_BLE\_PERIODIC\_ADV\_DATA\_SET\_COMPLETE\_EVT**

when periodic advertising data complete, the event comes

enumerator **ESP\_GAP\_BLE\_PERIODIC\_ADV\_START\_COMPLETE\_EVT**

when periodic advertising start complete, the event comes

enumerator **ESP\_GAP\_BLE\_PERIODIC\_ADV\_STOP\_COMPLETE\_EVT**

when periodic advertising stop complete, the event comes

enumerator **ESP\_GAP\_BLE\_PERIODIC\_ADV\_CREATE\_SYNC\_COMPLETE\_EVT**

when periodic advertising create sync complete, the event comes

enumerator **ESP\_GAP\_BLE\_PERIODIC\_ADV\_SYNC\_CANCEL\_COMPLETE\_EVT**

when extended advertising sync cancel complete, the event comes

enumerator **ESP\_GAP\_BLE\_PERIODIC\_ADV\_SYNC\_TERMINATE\_COMPLETE\_EVT**

when extended advertising sync terminate complete, the event comes

enumerator **ESP\_GAP\_BLE\_PERIODIC\_ADV\_ADD\_DEV\_COMPLETE\_EVT**

when extended advertising add device complete , the event comes

enumerator **ESP\_GAP\_BLE\_PERIODIC\_ADV\_REMOVE\_DEV\_COMPLETE\_EVT**

when extended advertising remove device complete, the event comes

enumerator **ESP\_GAP\_BLE\_PERIODIC\_ADV\_CLEAR\_DEV\_COMPLETE\_EVT**

when extended advertising clear device, the event comes

enumerator **ESP\_GAP\_BLE\_SET\_EXT\_SCAN\_PARAMS\_COMPLETE\_EVT**

when extended scan parameter complete, the event comes

enumerator **ESP\_GAP\_BLE\_EXT\_SCAN\_START\_COMPLETE\_EVT**

when extended scan start complete, the event comes

enumerator **ESP\_GAP\_BLE\_EXT\_SCAN\_STOP\_COMPLETE\_EVT**

when extended scan stop complete, the event comes

enumerator **ESP\_GAP\_BLE\_PREFER\_EXT\_CONN\_PARAMS\_SET\_COMPLETE\_EVT**

when extended prefer connection parameter set complete, the event comes

enumerator **ESP\_GAP\_BLE\_PHY\_UPDATE\_COMPLETE\_EVT**

when ble phy update complete, the event comes

enumerator **ESP\_GAP\_BLE\_EXT\_ADV\_REPORT\_EVT**

when extended advertising report complete, the event comes

enumerator **ESP\_GAP\_BLE\_SCAN\_TIMEOUT\_EVT**

when scan timeout complete, the event comes

enumerator **ESP\_GAP\_BLE\_ADV\_TERMINATED\_EVT**

when advertising terminate data complete, the event comes

enumerator **ESP\_GAP\_BLE\_SCAN\_REQ\_RECEIVED\_EVT**

when scan req received complete, the event comes

enumerator **ESP\_GAP\_BLE\_CHANNEL\_SELECT\_ALGORITHM\_EVT**

when channel select algorithm complete, the event comes

enumerator **ESP\_GAP\_BLE\_PERIODIC\_ADV\_REPORT\_EVT**

when periodic report advertising complete, the event comes

enumerator **ESP\_GAP\_BLE\_PERIODIC\_ADV\_SYNC\_LOST\_EVT**

when periodic advertising sync lost complete, the event comes

enumerator **ESP\_GAP\_BLE\_PERIODIC\_ADV\_SYNC\_ESTAB\_EVT**

when periodic advertising sync establish complete, the event comes

enumerator **ESP\_GAP\_BLE\_SC\_OOB\_REQ\_EVT**

Secure Connection OOB request event

enumerator **ESP\_GAP\_BLE\_SC\_CR\_LOC\_OOB\_EVT**

Secure Connection create OOB data complete event

enumerator **ESP\_GAP\_BLE\_GET\_DEV\_NAME\_COMPLETE\_EVT**

When getting BT device name complete, the event comes

enumerator **ESP\_GAP\_BLE\_PERIODIC\_ADV\_RECV\_ENABLE\_COMPLETE\_EVT**

when set periodic advertising receive enable complete, the event comes

enumerator **ESP\_GAP\_BLE\_PERIODIC\_ADV\_SYNC\_TRANS\_COMPLETE\_EVT**

when periodic advertising sync transfer complete, the event comes

enumerator **ESP\_GAP\_BLE\_PERIODIC\_ADV\_SET\_INFO\_TRANS\_COMPLETE\_EVT**

when periodic advertising set info transfer complete, the event comes

enumerator **ESP\_GAP\_BLE\_SET\_PAST\_PARAMS\_COMPLETE\_EVT**

when set periodic advertising sync transfer params complete, the event comes

enumerator **ESP\_GAP\_BLE\_PERIODIC\_ADV\_SYNC\_TRANS\_RECV\_EVT**

when periodic advertising sync transfer received, the event comes

enumerator **ESP\_GAP\_BLE\_DTM\_TEST\_UPDATE\_EVT**

when direct test mode state changes, the event comes

enumerator **ESP\_GAP\_BLE\_ADV\_CLEAR\_COMPLETE\_EVT**

When clear advertising complete, the event comes

enumerator **ESP\_GAP\_BLE\_SET\_RPA\_TIMEOUT\_COMPLETE\_EVT**

When set the Resolvable Private Address (RPA) timeout completes, the event comes

enumerator **ESP\_GAP\_BLE\_ADD\_DEV\_TO\_RESOLVING\_LIST\_COMPLETE\_EVT**

when add a device to the resolving list completes, the event comes

enumerator **ESP\_GAP\_BLE\_VENDOR\_CMD\_COMPLETE\_EVT**

When vendor hci command complete, the event comes

enumerator **ESP\_GAP\_BLE\_SET\_PRIVACY\_MODE\_COMPLETE\_EVT**

When set privacy mode complete, the event comes

enumerator **ESP\_GAP\_BLE\_EVT\_MAX**

when maximum advertising event complete, the event comes

enum **esp\_ble\_adv\_data\_type**

The type of advertising data(not adv\_type)

*Values:*

enumerator **ESP\_BLE\_AD\_TYPE\_FLAG**

enumerator **ESP\_BLE\_AD\_TYPE\_16SRV\_PART**

enumerator **ESP\_BLE\_AD\_TYPE\_16SRV\_CMPL**

enumerator **ESP\_BLE\_AD\_TYPE\_32SRV\_PART**

enumerator **ESP\_BLE\_AD\_TYPE\_32SRV\_CMPL**

enumerator **ESP\_BLE\_AD\_TYPE\_128SRV\_PART**

enumerator **ESP\_BLE\_AD\_TYPE\_128SRV\_CMPL**



enumerator **ESP\_BLE\_AD\_TYPE\_NAME\_SHORT**

enumerator **ESP\_BLE\_AD\_TYPE\_NAME\_CMPL**

enumerator **ESP\_BLE\_AD\_TYPE\_TX\_PWR**

enumerator **ESP\_BLE\_AD\_TYPE\_DEV\_CLASS**

enumerator **ESP\_BLE\_AD\_TYPE\_SM\_TK**

enumerator **ESP\_BLE\_AD\_TYPE\_SM\_OOB\_FLAG**

enumerator **ESP\_BLE\_AD\_TYPE\_INT\_RANGE**

enumerator **ESP\_BLE\_AD\_TYPE\_SOL\_SRV\_UUID**

enumerator **ESP\_BLE\_AD\_TYPE\_128SOL\_SRV\_UUID**

enumerator **ESP\_BLE\_AD\_TYPE\_SERVICE\_DATA**

enumerator **ESP\_BLE\_AD\_TYPE\_PUBLIC\_TARGET**

enumerator **ESP\_BLE\_AD\_TYPE\_RANDOM\_TARGET**

enumerator **ESP\_BLE\_AD\_TYPE\_APPEARANCE**

enumerator **ESP\_BLE\_AD\_TYPE\_ADV\_INT**

enumerator **ESP\_BLE\_AD\_TYPE\_LE\_DEV\_ADDR**

enumerator **ESP\_BLE\_AD\_TYPE\_LE\_ROLE**

enumerator **ESP\_BLE\_AD\_TYPE\_SPAIR\_C256**

enumerator **ESP\_BLE\_AD\_TYPE\_SPAIR\_R256**

enumerator **ESP\_BLE\_AD\_TYPE\_32SOL\_SRV\_UUID**

enumerator **ESP\_BLE\_AD\_TYPE\_32SERVICE\_DATA**

enumerator **ESP\_BLE\_AD\_TYPE\_128SERVICE\_DATA**

enumerator **ESP\_BLE\_AD\_TYPE\_LE\_SECURE\_CONFIRM**

enumerator **ESP\_BLE\_AD\_TYPE\_LE\_SECURE\_RANDOM**

enumerator **ESP\_BLE\_AD\_TYPE\_URI**

enumerator **ESP\_BLE\_AD\_TYPE\_INDOOR\_POSITION**

enumerator **ESP\_BLE\_AD\_TYPE\_TRANS\_DISC\_DATA**

enumerator **ESP\_BLE\_AD\_TYPE\_LE\_SUPPORT\_FEATURE**

enumerator **ESP\_BLE\_AD\_TYPE\_CHAN\_MAP\_UPDATE**

enumerator **ESP\_BLE\_AD\_MANUFACTURER\_SPECIFIC\_TYPE**

enum **esp\_ble\_adv\_type\_t**

Advertising mode.

*Values:*

enumerator **ADV\_TYPE\_IND**

enumerator **ADV\_TYPE\_DIRECT\_IND\_HIGH**

enumerator **ADV\_TYPE\_SCAN\_IND**

enumerator **ADV\_TYPE\_NONCONN\_IND**

enumerator **ADV\_TYPE\_DIRECT\_IND\_LOW**

enum **esp\_ble\_adv\_channel\_t**

Advertising channel mask.

*Values:*

enumerator **ADV\_CHNL\_37**

enumerator **ADV\_CHNL\_38**

enumerator **ADV\_CHNL\_39**

enumerator **ADV\_CHNL\_ALL**

enum **esp\_ble\_adv\_filter\_t**

*Values:*

enumerator **ADV\_FILTER\_ALLOW\_SCAN\_ANY\_CON\_ANY**

Allow both scan and connection requests from anyone.

enumerator **ADV\_FILTER\_ALLOW\_SCAN\_WLST\_CON\_ANY**

Allow both scan req from White List devices only and connection req from anyone.

enumerator **ADV\_FILTER\_ALLOW\_SCAN\_ANY\_CON\_WLST**

Allow both scan req from anyone and connection req from White List devices only.

enumerator **ADV\_FILTER\_ALLOW\_SCAN\_WLST\_CON\_WLST**

Allow scan and connection requests from White List devices only.

enum **esp\_ble\_sec\_act\_t**

*Values:*

enumerator **ESP\_BLE\_SEC\_ENCRYPT**

relate to **BTA\_DM\_BLE\_SEC\_ENCRYPT** in `bta/bta_api.h`. If the device has already bonded, the stack will use Long Term Key (LTK) to encrypt with the remote device directly. Else if the device hasn't bonded, the stack will use the default authentication request used in the `esp_ble_gap_set_security_param` function set by the user.

enumerator **ESP\_BLE\_SEC\_ENCRYPT\_NO\_MITM**

relate to **BTA\_DM\_BLE\_SEC\_ENCRYPT\_NO\_MITM** in `bta/bta_api.h`. If the device has been already bonded, the stack will check the LTK (Long Term Key) whether the authentication request has been met, and if met, use the LTK to encrypt with the remote device directly, else re-pair with the remote device. Else if the device hasn't been bonded, the stack will use NO MITM authentication request in the current link instead of using the `authreq` in the `esp_ble_gap_set_security_param` function set by the user.

enumerator **ESP\_BLE\_SEC\_ENCRYPT\_MITM**

relate to **BTA\_DM\_BLE\_SEC\_ENCRYPT\_MITM** in `bta/bta_api.h`. If the device has been already bonded, the stack will check the LTK (Long Term Key) whether the authentication request has been met, and if met, use the LTK to encrypt with the remote device directly, else re-pair with the remote device. Else if the device hasn't been bonded, the stack will use MITM authentication request in the current link instead of using the `authreq` in the `esp_ble_gap_set_security_param` function set by the user.

enum **esp\_ble\_sm\_param\_t**

*Values:*

enumerator **ESP\_BLE\_SM\_PASSKEY**

Authentication requirements of local device

enumerator **ESP\_BLE\_SM\_AUTHEN\_REQ\_MODE**

The IO capability of local device

enumerator **ESP\_BLE\_SM\_IOCAP\_MODE**

Initiator Key Distribution/Generation

enumerator **ESP\_BLE\_SM\_SET\_INIT\_KEY**

Responder Key Distribution/Generation

enumerator **ESP\_BLE\_SM\_SET\_RSP\_KEY**

Maximum Encryption key size to support

enumerator **ESP\_BLE\_SM\_MAX\_KEY\_SIZE**

Minimum Encryption key size requirement from Peer

enumerator **ESP\_BLE\_SM\_MIN\_KEY\_SIZE**

Set static Passkey

enumerator **ESP\_BLE\_SM\_SET\_STATIC\_PASSKEY**

Reset static Passkey

enumerator **ESP\_BLE\_SM\_CLEAR\_STATIC\_PASSKEY**

Accept only specified SMP Authentication requirement

enumerator **ESP\_BLE\_SM\_ONLY\_ACCEPT\_SPECIFIED\_SEC\_AUTH**

Enable/Disable OOB support

enumerator **ESP\_BLE\_SM\_OOB\_SUPPORT**

Appl encryption key size

enumerator **ESP\_BLE\_APP\_ENC\_KEY\_SIZE**

authentication max param

enumerator **ESP\_BLE\_SM\_MAX\_PARAM**

enum **esp\_ble\_dtm\_update\_evt\_t**

*Values:*

enumerator **DTM\_TX\_START\_EVT**

DTM TX start event.

enumerator **DTM\_RX\_START\_EVT**

DTM RX start event.

enumerator **DTM\_TEST\_STOP\_EVT**

DTM test end event.

enum **esp\_ble\_scan\_type\_t**

Ble scan type.

*Values:*

enumerator **BLE\_SCAN\_TYPE\_PASSIVE**

Passive scan

enumerator **BLE\_SCAN\_TYPE\_ACTIVE**

Active scan

enum **esp\_ble\_scan\_filter\_t**

Ble scan filter type.

*Values:*

enumerator **BLE\_SCAN\_FILTER\_ALLOW\_ALL**

Accept all :

- i. advertisement packets except directed advertising packets not addressed to this device (default).

enumerator **BLE\_SCAN\_FILTER\_ALLOW\_ONLY\_WLST**

Accept only :

- i. advertisement packets from devices where the advertiser' s address is in the White list.
- ii. Directed advertising packets which are not addressed for this device shall be ignored.

enumerator **BLE\_SCAN\_FILTER\_ALLOW\_UND\_RPA\_DIR**

Accept all :

- i. undirected advertisement packets, and
- ii. directed advertising packets where the initiator address is a resolvable private address, and
- iii. directed advertising packets addressed to this device.

enumerator **BLE\_SCAN\_FILTER\_ALLOW\_WLIST\_RPA\_DIR**

Accept all :

- i. advertisement packets from devices where the advertiser' s address is in the White list, and
- ii. directed advertising packets where the initiator address is a resolvable private address, and
- iii. directed advertising packets addressed to this device.

enum **esp\_ble\_scan\_duplicate\_t**

Ble scan duplicate type.

*Values:*

enumerator **BLE\_SCAN\_DUPLICATE\_DISABLE**

the Link Layer should generate advertising reports to the host for each packet received

enumerator **BLE\_SCAN\_DUPLICATE\_ENABLE**

the Link Layer should filter out duplicate advertising reports to the Host

enumerator **BLE\_SCAN\_DUPLICATE\_ENABLE\_RESET**

Duplicate filtering enabled, reset for each scan period, only supported in BLE 5.0.

enumerator **BLE\_SCAN\_DUPLICATE\_MAX**

Reserved for future use.

enum **esp\_ble\_auth\_fail\_rsn\_t**

Definition of the authentication failed reason.

*Values:*

enumerator **ESP\_AUTH\_SMP\_PASSKEY\_FAIL**

The user input of passkey failed

enumerator **ESP\_AUTH\_SMP\_OOB\_FAIL**

The OOB data is not available

enumerator **ESP\_AUTH\_SMP\_PAIR\_AUTH\_FAIL**

The authentication requirements cannot be met

enumerator **ESP\_AUTH\_SMP\_CONFIRM\_VALUE\_FAIL**

The confirm value does not match the calculated comparison value

enumerator **ESP\_AUTH\_SMP\_PAIR\_NOT\_SUPPORT**

Pairing is not supported by the device

enumerator **ESP\_AUTH\_SMP\_ENC\_KEY\_SIZE**

The resultant encryption key size is not long enough

enumerator **ESP\_AUTH\_SMP\_INVALID\_CMD**

The SMP command received is not supported by this device

enumerator **ESP\_AUTH\_SMP\_UNKNOWN\_ERR**

Pairing failed due to an unspecified reason

enumerator **ESP\_AUTH\_SMP\_REPEATED\_ATTEMPT**

Pairing or authentication procedure is disallowed

enumerator **ESP\_AUTH\_SMP\_INVALID\_PARAMETERS**

The command length is invalid or that a parameter is outside the specified range

enumerator **ESP\_AUTH\_SMP\_DHKEY\_CHK\_FAIL**

The DHKey Check value received doesn't match the one calculated by the local device

enumerator **ESP\_AUTH\_SMP\_NUM\_COMP\_FAIL**

The confirm values in the numeric comparison protocol do not match

enumerator **ESP\_AUTH\_SMP\_BR\_PAIRING\_IN\_PROGR**

Pairing Request sent over the BR/EDR transport is in progress

enumerator **ESP\_AUTH\_SMP\_XTRANS\_DERIVE\_NOT\_ALLOW**

The BR/EDR Link Key or BLE LTK cannot be used to derive

enumerator **ESP\_AUTH\_SMP\_INTERNAL\_ERR**

Internal error in pairing procedure

enumerator **ESP\_AUTH\_SMP\_UNKNOWN\_IO**

Unknown IO capability, unable to decide association model

enumerator **ESP\_AUTH\_SMP\_INIT\_FAIL**

SMP pairing initiation failed

enumerator **ESP\_AUTH\_SMP\_CONFIRM\_FAIL**

The confirm value does not match

enumerator **ESP\_AUTH\_SMP\_BUSY**

Pending security request on going

enumerator **ESP\_AUTH\_SMP\_ENC\_FAIL**

The Controller failed to start encryption

enumerator **ESP\_AUTH\_SMP\_STARTED**

SMP pairing process started

enumerator **ESP\_AUTH\_SMP\_RSP\_TIMEOUT**

Security Manager timeout due to no SMP command being received

enumerator **ESP\_AUTH\_SMP\_DIV\_NOT\_AVAIL**

Encrypted Diversifier value not available

enumerator **ESP\_AUTH\_SMP\_UNSPEC\_ERR**

Unspecified failed reason

enumerator **ESP\_AUTH\_SMP\_CONN\_TOUT**

Pairing process failed due to connection timeout

enum **esp\_gap\_search\_evt\_t**

Sub Event of ESP\_GAP\_BLE\_SCAN\_RESULT\_EVT.

*Values:*

enumerator **ESP\_GAP\_SEARCH\_INQ\_RES\_EVT**

Inquiry result for a peer device.

enumerator **ESP\_GAP\_SEARCH\_INQ\_CMPL\_EVT**

Inquiry complete.

enumerator **ESP\_GAP\_SEARCH\_DISC\_RES\_EVT**

Discovery result for a peer device.

enumerator **ESP\_GAP\_SEARCH\_DISC\_BLE\_RES\_EVT**

Discovery result for BLE GATT based service on a peer device.

enumerator **ESP\_GAP\_SEARCH\_DISC\_CMPL\_EVT**

Discovery complete.

enumerator **ESP\_GAP\_SEARCH\_DI\_DISC\_CMPL\_EVT**

Discovery complete.

enumerator **ESP\_GAP\_SEARCH\_SEARCH\_CANCEL\_CMPL\_EVT**

Search cancelled

enumerator **ESP\_GAP\_SEARCH\_INQ\_DISCARD\_NUM\_EVT**

The number of pkt discarded by flow control

enum **esp\_ble\_evt\_type\_t**

Ble scan result event type, to indicate the result is scan response or advertising data or other.

*Values:*

enumerator **ESP\_BLE\_EVT\_CONN\_ADV**  
Connectable undirected advertising (ADV\_IND)

enumerator **ESP\_BLE\_EVT\_CONN\_DIR\_ADV**  
Connectable directed advertising (ADV\_DIRECT\_IND)

enumerator **ESP\_BLE\_EVT\_DISC\_ADV**  
Scannable undirected advertising (ADV\_SCAN\_IND)

enumerator **ESP\_BLE\_EVT\_NON\_CONN\_ADV**  
Non connectable undirected advertising (ADV\_NONCONN\_IND)

enumerator **ESP\_BLE\_EVT\_SCAN\_RSP**  
Scan Response (SCAN\_RSP)

enum **esp\_ble\_wl\_operation\_t**  
*Values:*

enumerator **ESP\_BLE\_WHITELIST\_REMOVE**  
remove mac from whitelist

enumerator **ESP\_BLE\_WHITELIST\_ADD**  
add address to whitelist

enumerator **ESP\_BLE\_WHITELIST\_CLEAR**  
clear all device in whitelist

enum **esp\_bt\_duplicate\_exceptional\_subcode\_type\_t**  
*Values:*

enumerator **ESP\_BLE\_DUPLICATE\_EXCEPTIONAL\_LIST\_ADD**  
Add device info into duplicate scan exceptional list

enumerator **ESP\_BLE\_DUPLICATE\_EXCEPTIONAL\_LIST\_REMOVE**  
Remove device info from duplicate scan exceptional list

enumerator **ESP\_BLE\_DUPLICATE\_EXCEPTIONAL\_LIST\_CLEAN**  
Clean duplicate scan exceptional list

enum **esp\_ble\_duplicate\_exceptional\_info\_type\_t**  
*Values:*

enumerator **ESP\_BLE\_DUPLICATE\_SCAN\_EXCEPTIONAL\_INFO\_ADV\_ADDR**  
BLE advertising address , device info will be added into ESP\_BLE\_DUPLICATE\_SCAN\_EXCEPTIONAL\_ADDR\_LIST

enumerator **ESP\_BLE\_DUPLICATE\_SCAN\_EXCEPTIONAL\_INFO\_MESH\_LINK\_ID**  
BLE mesh link ID, it is for BLE mesh, device info will be added into ESP\_BLE\_DUPLICATE\_SCAN\_EXCEPTIONAL\_MESH\_LINK\_ID\_LIST



enumerator **ESP\_BLE\_DUPLICATE\_SCAN\_EXCEPTIONAL\_INFO\_MESH\_BEACON\_TYPE**

BLE mesh beacon AD type, the format is | Len | 0x2B | Beacon Type | Beacon Data |

enumerator **ESP\_BLE\_DUPLICATE\_SCAN\_EXCEPTIONAL\_INFO\_MESH\_PROV\_SRV\_ADV**

BLE mesh provisioning service uuid, the format is | 0x02 | 0x01 | flags | 0x03 | 0x03 | 0x1827 | .... |

enumerator **ESP\_BLE\_DUPLICATE\_SCAN\_EXCEPTIONAL\_INFO\_MESH\_PROXY\_SRV\_ADV**

BLE mesh adv with proxy service uuid, the format is | 0x02 | 0x01 | flags | 0x03 | 0x03 | 0x1828 | .... |

enumerator **ESP\_BLE\_DUPLICATE\_SCAN\_EXCEPTIONAL\_INFO\_MESH\_PROXY\_SOLIC\_ADV**

BLE mesh adv with proxy service uuid, the format is | 0x02 | 0x01 | flags | 0x03 | 0x03 | 0x1859 | .... |

enumerator **ESP\_BLE\_DUPLICATE\_SCAN\_EXCEPTIONAL\_INFO\_MESH\_URI\_ADV**

BLE mesh URI adv, the format is ...| Len | 0x24 | data |...

enum **esp\_duplicate\_scan\_exceptional\_list\_type\_t**

*Values:*

enumerator **ESP\_BLE\_DUPLICATE\_SCAN\_EXCEPTIONAL\_ADDR\_LIST**

duplicate scan exceptional addr list

enumerator **ESP\_BLE\_DUPLICATE\_SCAN\_EXCEPTIONAL\_MESH\_LINK\_ID\_LIST**

duplicate scan exceptional mesh link ID list

enumerator **ESP\_BLE\_DUPLICATE\_SCAN\_EXCEPTIONAL\_MESH\_BEACON\_TYPE\_LIST**

duplicate scan exceptional mesh beacon type list

enumerator **ESP\_BLE\_DUPLICATE\_SCAN\_EXCEPTIONAL\_MESH\_PROV\_SRV\_ADV\_LIST**

duplicate scan exceptional mesh adv with provisioning service uuid

enumerator **ESP\_BLE\_DUPLICATE\_SCAN\_EXCEPTIONAL\_MESH\_PROXY\_SRV\_ADV\_LIST**

duplicate scan exceptional mesh adv with proxy service uuid

enumerator **ESP\_BLE\_DUPLICATE\_SCAN\_EXCEPTIONAL\_MESH\_PROXY\_SOLIC\_ADV\_LIST**

duplicate scan exceptional mesh adv with proxy solicitation PDU uuid

enumerator **ESP\_BLE\_DUPLICATE\_SCAN\_EXCEPTIONAL\_MESH\_URI\_ADV\_LIST**

duplicate scan exceptional URI list

enumerator **ESP\_BLE\_DUPLICATE\_SCAN\_EXCEPTIONAL\_ALL\_LIST**

duplicate scan exceptional all list

enum **esp\_ble\_privacy\_mode\_t**

*Values:*

enumerator **ESP\_BLE\_NETWORK\_PRIVACY\_MODE**

Network Privacy Mode for peer device (default)

enumerator **ESP\_BLE\_DEVICE\_PRIVACY\_MODE**

Device Privacy Mode for peer device

## GATT Defines

## API Reference

### Header File

- [components/bt/host/bluedroid/api/include/api/esp\\_gatt\\_defs.h](#)
- This header file can be included with:

```
#include "esp_gatt_defs.h"
```

- This header file is a part of the API provided by the `bt` component. To declare that your component depends on `bt`, add the following to your `CMakeLists.txt`:

```
REQUIRES bt
```

or

```
PRIV_REQUIRES bt
```

### Unions

union **esp\_gatt\_rsp\_t**

*#include <esp\_gatt\_defs.h>* Represents the response type for a GATT remote read request.

#### Public Members

*esp\_gatt\_value\_t* **attr\_value**

The GATT attribute value, including its data, handle, and metadata.

uint16\_t **handle**

Only the handle of the GATT attribute, when that's the only required information.

### Structures

struct **esp\_gatt\_id\_t**

Represents a GATT identifier.

#### Public Members

*esp\_bt\_uuid\_t* **uuid**

The UUID component of the GATT ID.

uint8\_t **inst\_id**

The instance ID component of the GATT ID, providing further differentiation of the GATT ID.

struct **esp\_gatt\_srvc\_id\_t**

Represents a GATT service identifier.

### Public Members

#### `esp_gatt_id_t id`

Encapsulates the UUID and instance ID of the GATT service.

#### bool `is_primary`

Indicates if the service is primary. A value of true means it is a primary service, false indicates a secondary service.

#### struct `esp_attr_desc_t`

Defines an attribute's description.

This structure is used to describe an attribute in the GATT database. It includes details such as the UUID of the attribute, its permissions, and its value.

### Public Members

#### `uint16_t uuid_length`

Length of the UUID in bytes.

#### `uint8_t *uuid_p`

Pointer to the UUID value.

#### `uint16_t perm`

Attribute permissions, defined by `esp_gatt_perm_t`.

#### `uint16_t max_length`

Maximum length of the attribute's value.

#### `uint16_t length`

Current length of the attribute's value.

#### `uint8_t *value`

Pointer to the attribute's value array.

#### struct `esp_attr_control_t`

Defines the auto response setting for attribute operations.

This structure is used to control whether the GATT stack or the application will handle responses to Read/Write operations.

### Public Members

#### `uint8_t auto_rsp`

Controls who handles the response to Read/Write operations.

- If set to `ESP_GATT_RSP_BY_APP`, the application is responsible for generating the response.
- If set to `ESP_GATT_AUTO_RSP`, the GATT stack will automatically generate the response.

struct **esp\_gatts\_attr\_db\_t**  
attribute type added to the GATT server database

### Public Members

*esp\_attr\_control\_t* **attr\_control**  
The attribute control type

*esp\_attr\_desc\_t* **att\_desc**  
The attribute type

struct **esp\_attr\_value\_t**  
set the attribute value type

### Public Members

uint16\_t **attr\_max\_len**  
attribute max value length

uint16\_t **attr\_len**  
attribute current value length

uint8\_t \***attr\_value**  
the pointer to attribute value

struct **esp\_gatts\_incl\_svc\_desc\_t**  
Gatt include service entry element.

### Public Members

uint16\_t **start\_hdl**  
Gatt start handle value of included service

uint16\_t **end\_hdl**  
Gatt end handle value of included service

uint16\_t **uuid**  
Gatt attribute value UUID of included service

struct **esp\_gatts\_incl128\_svc\_desc\_t**  
Gatt include 128 bit service entry element.

### Public Members

uint16\_t **start\_hdl**  
Gatt start handle value of included 128 bit service

uint16\_t **end\_hdl**

Gatt end handle value of included 128 bit service

struct **esp\_gatt\_value\_t**

Represents a GATT attribute's value.

### Public Members

uint8\_t **value**[ESP\_GATT\_MAX\_ATTR\_LEN]

Array holding the value of the GATT attribute.

uint16\_t **handle**

Unique identifier (handle) of the GATT attribute.

uint16\_t **offset**

Offset within the attribute's value, for partial updates.

uint16\_t **len**

Current length of the data in the value array.

uint8\_t **auth\_req**

Authentication requirements for accessing this attribute.

struct **esp\_gatt\_conn\_params\_t**

Connection parameters for GATT.

### Public Members

uint16\_t **interval**

Connection interval.

uint16\_t **latency**

Slave latency for the connection in number of connection events.

uint16\_t **timeout**

Supervision timeout for the LE Link.

struct **esp\_gattc\_multi\_t**

Represents multiple attributes for reading.

### Public Members

uint8\_t **num\_attr**

Number of attributes.

uint16\_t **handles**[ESP\_GATT\_MAX\_READ\_MULTI\_HANDLES]

List of attribute handles.

struct **esp\_gattc\_db\_elem\_t**

GATT database attribute element.

### Public Members

*esp\_gatt\_db\_attr\_type\_t* **type**

Attribute type.

uint16\_t **attribute\_handle**

Attribute handle.

uint16\_t **start\_handle**

Service start handle.

uint16\_t **end\_handle**

Service end handle.

*esp\_gatt\_char\_prop\_t* **properties**

Characteristic properties.

*esp\_bt\_uuid\_t* **uuid**

Attribute UUID.

struct **esp\_gattc\_service\_elem\_t**

Represents a GATT service element.

### Public Members

bool **is\_primary**

Indicates if the service is primary.

uint16\_t **start\_handle**

Service start handle.

uint16\_t **end\_handle**

Service end handle.

*esp\_bt\_uuid\_t* **uuid**

Service UUID.

struct **esp\_gattc\_char\_elem\_t**

Represents a GATT characteristic element.

### Public Members

`uint16_t char_handle`  
Characteristic handle.

`esp_gatt_char_prop_t properties`  
Characteristic properties.

`esp_bt_uuid_t uuid`  
Characteristic UUID.

struct `esp_gattc_descr_elem_t`  
Represents a GATT descriptor element.

### Public Members

`uint16_t handle`  
Descriptor handle.

`esp_bt_uuid_t uuid`  
Descriptor UUID.

struct `esp_gattc_incl_svc_elem_t`  
Represents an included GATT service element.

### Public Members

`uint16_t handle`  
Current attribute handle of the included service.

`uint16_t incl_srvc_s_handle`  
Start handle of the included service.

`uint16_t incl_srvc_e_handle`  
End handle of the included service.

`esp_bt_uuid_t uuid`  
Included service UUID.

### Macros

`ESP_GATT_ILLEGAL_UUID`  
GATT INVALID UUID.

`ESP_GATT_ILLEGAL_HANDLE`  
GATT INVALID HANDLE.

**ESP\_GATT\_ATTR\_HANDLE\_MAX**

GATT attribute max handle.

**ESP\_GATT\_MAX\_READ\_MULTI\_HANDLES**

Maximum number of attributes to read in one request.

**ESP\_GATT\_UUID\_IMMEDIATE\_ALERT\_SVC**

Immediate Alert Service UUID.

**ESP\_GATT\_UUID\_LINK\_LOSS\_SVC**

Link Loss Service UUID.

**ESP\_GATT\_UUID\_TX\_POWER\_SVC**

TX Power Service UUID.

**ESP\_GATT\_UUID\_CURRENT\_TIME\_SVC**

Current Time Service UUID.

**ESP\_GATT\_UUID\_REF\_TIME\_UPDATE\_SVC**

Reference Time Update Service UUID.

**ESP\_GATT\_UUID\_NEXT\_DST\_CHANGE\_SVC**

Next DST Change Service UUID.

**ESP\_GATT\_UUID\_GLUCOSE\_SVC**

Glucose Service UUID.

**ESP\_GATT\_UUID\_HEALTH\_THERMOM\_SVC**

Health Thermometer Service UUID.

**ESP\_GATT\_UUID\_DEVICE\_INFO\_SVC**

Device Information Service UUID.

**ESP\_GATT\_UUID\_HEART\_RATE\_SVC**

Heart Rate Service UUID.

**ESP\_GATT\_UUID\_PHONE\_ALERT\_STATUS\_SVC**

Phone Alert Status Service UUID.

**ESP\_GATT\_UUID\_BATTERY\_SERVICE\_SVC**

Battery Service UUID.

**ESP\_GATT\_UUID\_BLOOD\_PRESSURE\_SVC**

Blood Pressure Service UUID.

**ESP\_GATT\_UUID\_ALERT\_NTF\_SVC**

Alert Notification Service UUID.



**ESP\_GATT\_UUID\_HID\_SVC**

HID Service UUID.

**ESP\_GATT\_UUID\_SCAN\_PARAMETERS\_SVC**

Scan Parameters Service UUID.

**ESP\_GATT\_UUID\_RUNNING\_SPEED\_CADENCE\_SVC**

Running Speed and Cadence Service UUID.

**ESP\_GATT\_UUID\_Automation\_IO\_SVC**

Automation IO Service UUID.

**ESP\_GATT\_UUID\_CYCLING\_SPEED\_CADENCE\_SVC**

Cycling Speed and Cadence Service UUID.

**ESP\_GATT\_UUID\_CYCLING\_POWER\_SVC**

Cycling Power Service UUID.

**ESP\_GATT\_UUID\_LOCATION\_AND\_NAVIGATION\_SVC**

Location and Navigation Service UUID.

**ESP\_GATT\_UUID\_ENVIRONMENTAL\_SENSING\_SVC**

Environmental Sensing Service UUID.

**ESP\_GATT\_UUID\_BODY\_COMPOSITION**

Body Composition Service UUID.

**ESP\_GATT\_UUID\_USER\_DATA\_SVC**

User Data Service UUID.

**ESP\_GATT\_UUID\_WEIGHT\_SCALE\_SVC**

Weight Scale Service UUID.

**ESP\_GATT\_UUID\_BOND\_MANAGEMENT\_SVC**

Bond Management Service UUID.

**ESP\_GATT\_UUID\_CONT\_GLUCOSE\_MONITOR\_SVC**

Continuous Glucose Monitoring Service UUID.

**ESP\_GATT\_UUID\_PRI\_SERVICE**

Primary Service UUID.

**ESP\_GATT\_UUID\_SEC\_SERVICE**

Secondary Service UUID.

**ESP\_GATT\_UUID\_INCLUDE\_SERVICE**

Include Service UUID.

**ESP\_GATT\_UUID\_CHAR\_DECLARE**

Characteristic Declaration UUID.

**ESP\_GATT\_UUID\_CHAR\_EXT\_PROP**

Characteristic Extended Properties UUID.

**ESP\_GATT\_UUID\_CHAR\_DESCRIPTION**

Characteristic User Description UUID.

**ESP\_GATT\_UUID\_CHAR\_CLIENT\_CONFIG**

Client Characteristic Configuration UUID.

**ESP\_GATT\_UUID\_CHAR\_SRVR\_CONFIG**

Server Characteristic Configuration UUID.

**ESP\_GATT\_UUID\_CHAR\_PRESENT\_FORMAT**

Characteristic Presentation Format UUID.

**ESP\_GATT\_UUID\_CHAR\_AGG\_FORMAT**

Characteristic Aggregate Format UUID.

**ESP\_GATT\_UUID\_CHAR\_VALID\_RANGE**

Characteristic Valid Range UUID.

**ESP\_GATT\_UUID\_EXT\_RPT\_REF\_DESCR**

External Report Reference Descriptor UUID.

**ESP\_GATT\_UUID\_RPT\_REF\_DESCR**

Report Reference Descriptor UUID.

**ESP\_GATT\_UUID\_NUM\_DIGITALS\_DESCR**

Number of Digitals Descriptor UUID.

**ESP\_GATT\_UUID\_VALUE\_TRIGGER\_DESCR**

Value Trigger Setting Descriptor UUID.

**ESP\_GATT\_UUID\_ENV\_SENSING\_CONFIG\_DESCR**

Environmental Sensing Configuration Descriptor UUID.

**ESP\_GATT\_UUID\_ENV\_SENSING\_MEASUREMENT\_DESCR**

Environmental Sensing Measurement Descriptor UUID.

**ESP\_GATT\_UUID\_ENV\_SENSING\_TRIGGER\_DESCR**

Environmental Sensing Trigger Setting Descriptor UUID.

**ESP\_GATT\_UUID\_TIME\_TRIGGER\_DESCR**

Time Trigger Setting Descriptor UUID.

**ESP\_GATT\_UUID\_GAP\_DEVICE\_NAME**

GAP Device Name UUID.

**ESP\_GATT\_UUID\_GAP\_ICON**

GAP Icon UUID.

**ESP\_GATT\_UUID\_GAP\_PREF\_CONN\_PARAM**

GAP Preferred Connection Parameters UUID.

**ESP\_GATT\_UUID\_GAP\_CENTRAL\_ADDR\_RESOL**

GAP Central Address Resolution UUID.

**ESP\_GATT\_UUID\_GATT\_SRV\_CHGD**

GATT Service Changed UUID.

**ESP\_GATT\_UUID\_ALERT\_LEVEL**

Alert Level UUID.

**ESP\_GATT\_UUID\_TX\_POWER\_LEVEL**

TX Power Level UUID.

**ESP\_GATT\_UUID\_CURRENT\_TIME**

Current Time UUID.

**ESP\_GATT\_UUID\_LOCAL\_TIME\_INFO**

Local Time Info UUID.

**ESP\_GATT\_UUID\_REF\_TIME\_INFO**

Reference Time Information UUID.

**ESP\_GATT\_UUID\_NW\_STATUS**

Network Availability Status UUID.

**ESP\_GATT\_UUID\_NW\_TRIGGER**

Network Availability Trigger UUID.

**ESP\_GATT\_UUID\_ALERT\_STATUS**

Alert Status UUID.

**ESP\_GATT\_UUID\_RINGER\_CP**

Ringer Control Point UUID.

**ESP\_GATT\_UUID\_RINGER\_SETTING**

Ringer Setting UUID.

**ESP\_GATT\_UUID\_GM\_MEASUREMENT**

Glucose Measurement Characteristic UUID.

**ESP\_GATT\_UUID\_GM\_CONTEXT**

Glucose Measurement Context Characteristic UUID.

**ESP\_GATT\_UUID\_GM\_CONTROL\_POINT**

Glucose Control Point Characteristic UUID.

**ESP\_GATT\_UUID\_GM\_FEATURE**

Glucose Feature Characteristic UUID.

**ESP\_GATT\_UUID\_SYSTEM\_ID**

System ID Characteristic UUID.

**ESP\_GATT\_UUID\_MODEL\_NUMBER\_STR**

Model Number String Characteristic UUID.

**ESP\_GATT\_UUID\_SERIAL\_NUMBER\_STR**

Serial Number String Characteristic UUID.

**ESP\_GATT\_UUID\_FW\_VERSION\_STR**

Firmware Revision String Characteristic UUID.

**ESP\_GATT\_UUID\_HW\_VERSION\_STR**

Hardware Revision String Characteristic UUID.

**ESP\_GATT\_UUID\_SW\_VERSION\_STR**

Software Revision String Characteristic UUID.

**ESP\_GATT\_UUID\_MANU\_NAME**

Manufacturer Name String Characteristic UUID.

**ESP\_GATT\_UUID\_IEEE\_DATA**

IEEE 11073-20601 Regulatory Certification Data List Characteristic UUID.

**ESP\_GATT\_UUID\_PNP\_ID**

PnP ID Characteristic UUID.

**ESP\_GATT\_UUID\_HID\_INFORMATION**

HID Information Characteristic UUID.

**ESP\_GATT\_UUID\_HID\_REPORT\_MAP**

HID Report Map Characteristic UUID.

**ESP\_GATT\_UUID\_HID\_CONTROL\_POINT**

HID Control Point Characteristic UUID.

**ESP\_GATT\_UUID\_HID\_REPORT**

HID Report Characteristic UUID.

**ESP\_GATT\_UUID\_HID\_PROTO\_MODE**

HID Protocol Mode Characteristic UUID.

**ESP\_GATT\_UUID\_HID\_BT\_KB\_INPUT**

HID Bluetooth Keyboard Input Characteristic UUID.

**ESP\_GATT\_UUID\_HID\_BT\_KB\_OUTPUT**

HID Bluetooth Keyboard Output Characteristic UUID.

**ESP\_GATT\_UUID\_HID\_BT\_MOUSE\_INPUT**

HID Bluetooth Mouse Input Characteristic UUID.

**ESP\_GATT\_HEART\_RATE\_MEAS**

Heart Rate Measurement Characteristic UUID.

**ESP\_GATT\_BODY\_SENSOR\_LOCATION**

Body Sensor Location Characteristic UUID.

**ESP\_GATT\_HEART\_RATE\_CNTL\_POINT**

Heart Rate Control Point Characteristic UUID.

**ESP\_GATT\_UUID\_BATTERY\_LEVEL**

Battery Level Characteristic UUID.

**ESP\_GATT\_UUID\_SC\_CONTROL\_POINT**

Sensor Control Point Characteristic UUID.

**ESP\_GATT\_UUID\_SENSOR\_LOCATION**

Sensor Location Characteristic UUID.

**ESP\_GATT\_UUID\_RSC\_MEASUREMENT**

RSC Measurement Characteristic UUID.

**ESP\_GATT\_UUID\_RSC\_FEATURE**

RSC Feature Characteristic UUID.

**ESP\_GATT\_UUID\_CSC\_MEASUREMENT**

CSC Measurement Characteristic UUID.

**ESP\_GATT\_UUID\_CSC\_FEATURE**

CSC Feature Characteristic UUID.

**ESP\_GATT\_UUID\_SCAN\_INT\_WINDOW**

Scan Interval Window Characteristic UUID.

**ESP\_GATT\_UUID\_SCAN\_REFRESH**

Scan Refresh UUID.

**ESP\_GATT\_PERM\_READ**

Permission to read the attribute. Corresponds to BTA\_GATT\_PERM\_READ.

**ESP\_GATT\_PERM\_READ\_ENCRYPTED**

Permission to read the attribute with encryption. Corresponds to BTA\_GATT\_PERM\_READ\_ENCRYPTED.

**ESP\_GATT\_PERM\_READ\_ENC\_MITM**

Permission to read the attribute with encrypted MITM (Man In The Middle) protection. Corresponds to BTA\_GATT\_PERM\_READ\_ENC\_MITM.

**ESP\_GATT\_PERM\_WRITE**

Permission to write to the attribute. Corresponds to BTA\_GATT\_PERM\_WRITE.

**ESP\_GATT\_PERM\_WRITE\_ENCRYPTED**

Permission to write to the attribute with encryption. Corresponds to BTA\_GATT\_PERM\_WRITE\_ENCRYPTED.

**ESP\_GATT\_PERM\_WRITE\_ENC\_MITM**

Permission to write to the attribute with encrypted MITM protection. Corresponds to BTA\_GATT\_PERM\_WRITE\_ENC\_MITM.

**ESP\_GATT\_PERM\_WRITE\_SIGNED**

Permission for signed writes to the attribute. Corresponds to BTA\_GATT\_PERM\_WRITE\_SIGNED.

**ESP\_GATT\_PERM\_WRITE\_SIGNED\_MITM**

Permission for signed writes to the attribute with MITM protection. Corresponds to BTA\_GATT\_PERM\_WRITE\_SIGNED\_MITM.

**ESP\_GATT\_PERM\_READ\_AUTHORIZATION**

Permission to read the attribute with authorization.

**ESP\_GATT\_PERM\_WRITE\_AUTHORIZATION**

Permission to write to the attribute with authorization.

**ESP\_GATT\_PERM\_ENCRYPT\_KEY\_SIZE** (keysize)

Macro to specify minimum encryption key size.

**参数**

- **keysize** -- The minimum size of the encryption key, in bytes.

**ESP\_GATT\_CHAR\_PROP\_BIT\_BROADCAST**

Ability to broadcast. Corresponds to BTA\_GATT\_CHAR\_PROP\_BIT\_BROADCAST.

**ESP\_GATT\_CHAR\_PROP\_BIT\_READ**

Ability to read. Corresponds to BTA\_GATT\_CHAR\_PROP\_BIT\_READ.

**ESP\_GATT\_CHAR\_PROP\_BIT\_WRITE\_NR**

Ability to write without response. Corresponds to BTA\_GATT\_CHAR\_PROP\_BIT\_WRITE\_NR.

**ESP\_GATT\_CHAR\_PROP\_BIT\_WRITE**

Ability to write. Corresponds to BTA\_GATT\_CHAR\_PROP\_BIT\_WRITE.

**ESP\_GATT\_CHAR\_PROP\_BIT\_NOTIFY**

Ability to notify. Corresponds to BTA\_GATT\_CHAR\_PROP\_BIT\_NOTIFY.

**ESP\_GATT\_CHAR\_PROP\_BIT\_INDICATE**

Ability to indicate. Corresponds to BTA\_GATT\_CHAR\_PROP\_BIT\_INDICATE.

**ESP\_GATT\_CHAR\_PROP\_BIT\_AUTH**

Ability to authenticate. Corresponds to BTA\_GATT\_CHAR\_PROP\_BIT\_AUTH.

**ESP\_GATT\_CHAR\_PROP\_BIT\_EXT\_PROP**

Has extended properties. Corresponds to BTA\_GATT\_CHAR\_PROP\_BIT\_EXT\_PROP.

**ESP\_GATT\_MAX\_ATTR\_LEN**

Defines the maximum length of a GATT attribute.

This definition specifies the maximum number of bytes that a GATT attribute can hold. As same as GATT\_MAX\_ATTR\_LEN.

**ESP\_GATT\_RSP\_BY\_APP**

Defines attribute control for GATT operations.

This module provides definitions for controlling attribute auto responses in GATT operations.

Response to Write/Read operations should be handled by the application.

**ESP\_GATT\_AUTO\_RSP**

Response to Write/Read operations should be automatically handled by the GATT stack.

**ESP\_GATT\_IF\_NONE**

Macro indicating no specific GATT interface.

No specific application GATT interface.

**Type Definitions**

```
typedef uint16_t esp_gatt_perm_t
```

Type to represent GATT attribute permissions.

```
typedef uint8_t esp_gatt_char_prop_t
```

Type for characteristic properties bitmask.

```
typedef uint8_t esp_gatt_if_t
```

GATT interface type for client applications.

**Enumerations**

```
enum esp_gatt_prep_write_type
```

Defines the attribute write operation types from the client.

These values are used to specify the type of write operation in a prepare write sequence. relate to BTA\_GATT\_PREP\_WRITE\_XXX in bta/bta\_gatt\_api.h.

*Values:*

enumerator **ESP\_GATT\_PREP\_WRITE\_CANCEL**

Prepare write cancel. Corresponds to BTA\_GATT\_PREP\_WRITE\_CANCEL.

enumerator **ESP\_GATT\_PREP\_WRITE\_EXEC**

Prepare write execute. Corresponds to BTA\_GATT\_PREP\_WRITE\_EXEC.

enum **esp\_gatt\_status\_t**

GATT operation status codes.

These status codes are used to indicate the result of various GATT operations. relate to BTA\_GATT\_xxx in bta/bta\_gatt\_api.h .

*Values:*

enumerator **ESP\_GATT\_OK**

0x0, Operation successful. Corresponds to BTA\_GATT\_OK.

enumerator **ESP\_GATT\_INVALID\_HANDLE**

0x01, Invalid handle. Corresponds to BTA\_GATT\_INVALID\_HANDLE.

enumerator **ESP\_GATT\_READ\_NOT\_PERMIT**

0x02, Read operation not permitted. Corresponds to BTA\_GATT\_READ\_NOT\_PERMIT.

enumerator **ESP\_GATT\_WRITE\_NOT\_PERMIT**

0x03, Write operation not permitted. Corresponds to BTA\_GATT\_WRITE\_NOT\_PERMIT.

enumerator **ESP\_GATT\_INVALID\_PDU**

0x04, Invalid PDU. Corresponds to BTA\_GATT\_INVALID\_PDU.

enumerator **ESP\_GATT\_INSUF\_AUTHENTICATION**

0x05, Insufficient authentication. Corresponds to BTA\_GATT\_INSUF\_AUTHENTICATION.

enumerator **ESP\_GATT\_REQ\_NOT\_SUPPORTED**

0x06, Request not supported. Corresponds to BTA\_GATT\_REQ\_NOT\_SUPPORTED.

enumerator **ESP\_GATT\_INVALID\_OFFSET**

0x07, Invalid offset. Corresponds to BTA\_GATT\_INVALID\_OFFSET.

enumerator **ESP\_GATT\_INSUF\_AUTHORIZATION**

0x08, Insufficient authorization. Corresponds to BTA\_GATT\_INSUF\_AUTHORIZATION.

enumerator **ESP\_GATT\_PREPARE\_Q\_FULL**

0x09, Prepare queue full. Corresponds to BTA\_GATT\_PREPARE\_Q\_FULL.

enumerator **ESP\_GATT\_NOT\_FOUND**

0x0a, Not found. Corresponds to BTA\_GATT\_NOT\_FOUND.

enumerator **ESP\_GATT\_NOT\_LONG**

0x0b, Not long. Corresponds to BTA\_GATT\_NOT\_LONG.



enumerator **ESP\_GATT\_INSUF\_KEY\_SIZE**

0x0c, Insufficient key size. Corresponds to BTA\_GATT\_INSUF\_KEY\_SIZE.

enumerator **ESP\_GATT\_INVALID\_ATTR\_LEN**

0x0d, Invalid attribute length. Corresponds to BTA\_GATT\_INVALID\_ATTR\_LEN.

enumerator **ESP\_GATT\_ERR\_UNLIKELY**

0x0e, Unlikely error. Corresponds to BTA\_GATT\_ERR\_UNLIKELY.

enumerator **ESP\_GATT\_INSUF\_ENCRYPTION**

0x0f, Insufficient encryption. Corresponds to BTA\_GATT\_INSUF\_ENCRYPTION.

enumerator **ESP\_GATT\_UNSUPPORT\_GRP\_TYPE**

0x10, Unsupported group type. Corresponds to BTA\_GATT\_UNSUPPORT\_GRP\_TYPE.

enumerator **ESP\_GATT\_INSUF\_RESOURCE**

0x11, Insufficient resource. Corresponds to BTA\_GATT\_INSUF\_RESOURCE.

enumerator **ESP\_GATT\_NO\_RESOURCES**

0x80, No resources. Corresponds to BTA\_GATT\_NO\_RESOURCES.

enumerator **ESP\_GATT\_INTERNAL\_ERROR**

0x81, Internal error. Corresponds to BTA\_GATT\_INTERNAL\_ERROR.

enumerator **ESP\_GATT\_WRONG\_STATE**

0x82, Wrong state. Corresponds to BTA\_GATT\_WRONG\_STATE.

enumerator **ESP\_GATT\_DB\_FULL**

0x83, Database full. Corresponds to BTA\_GATT\_DB\_FULL.

enumerator **ESP\_GATT\_BUSY**

0x84, Busy. Corresponds to BTA\_GATT\_BUSY.

enumerator **ESP\_GATT\_ERROR**

0x85, Generic error. Corresponds to BTA\_GATT\_ERROR.

enumerator **ESP\_GATT\_CMD\_STARTED**

0x86, Command started. Corresponds to BTA\_GATT\_CMD\_STARTED.

enumerator **ESP\_GATT\_ILLEGAL\_PARAMETER**

0x87, Illegal parameter. Corresponds to BTA\_GATT\_ILLEGAL\_PARAMETER.

enumerator **ESP\_GATT\_PENDING**

0x88, Operation pending. Corresponds to BTA\_GATT\_PENDING.

enumerator **ESP\_GATT\_AUTH\_FAIL**

0x89, Authentication failed. Corresponds to BTA\_GATT\_AUTH\_FAIL.

enumerator **ESP\_GATT\_MORE**

0x8a, More data available. Corresponds to BTA\_GATT\_MORE.

enumerator **ESP\_GATT\_INVALID\_CFG**

0x8b, Invalid configuration. Corresponds to BTA\_GATT\_INVALID\_CFG.

enumerator **ESP\_GATT\_SERVICE\_STARTED**

0x8c, Service started. Corresponds to BTA\_GATT\_SERVICE\_STARTED.

enumerator **ESP\_GATT\_ENCRYPTED\_MITM**

0x0, Encrypted, with MITM protection. Corresponds to BTA\_GATT\_ENCRYPTED\_MITM.

enumerator **ESP\_GATT\_ENCRYPTED\_NO\_MITM**

0x8d, Encrypted, without MITM protection. Corresponds to BTA\_GATT\_ENCRYPTED\_NO\_MITM.

enumerator **ESP\_GATT\_NOT\_ENCRYPTED**

0x8e, Not encrypted. Corresponds to BTA\_GATT\_NOT\_ENCRYPTED.

enumerator **ESP\_GATT\_CONGESTED**

0x8f, Congested. Corresponds to BTA\_GATT\_CONGESTED.

enumerator **ESP\_GATT\_DUP\_REG**

0x90, Duplicate registration. Corresponds to BTA\_GATT\_DUP\_REG.

enumerator **ESP\_GATT\_ALREADY\_OPEN**

0x91, Already open. Corresponds to BTA\_GATT\_ALREADY\_OPEN.

enumerator **ESP\_GATT\_CANCEL**

0x92, Operation cancelled. Corresponds to BTA\_GATT\_CANCEL.

enumerator **ESP\_GATT\_STACK\_RSP**

0xe0, Stack response. Corresponds to BTA\_GATT\_STACK\_RSP.

enumerator **ESP\_GATT\_APP\_RSP**

0xe1, Application response. Corresponds to BTA\_GATT\_APP\_RSP.

enumerator **ESP\_GATT\_UNKNOWN\_ERROR**

0xef, Unknown error. Corresponds to BTA\_GATT\_UNKNOWN\_ERROR.

enumerator **ESP\_GATT\_CCC\_CFG\_ERR**

0xfd, Client Characteristic Configuration Descriptor improperly configured. Corresponds to BTA\_GATT\_CCC\_CFG\_ERR.

enumerator **ESP\_GATT\_PRC\_IN\_PROGRESS**

0xfe, Procedure already in progress. Corresponds to BTA\_GATT\_PRC\_IN\_PROGRESS.

enumerator **ESP\_GATT\_OUT\_OF\_RANGE**

0xff, Attribute value out of range. Corresponds to BTA\_GATT\_OUT\_OF\_RANGE.

**enum esp\_gatt\_conn\_reason\_t**

Enumerates reasons for GATT connection.

*Values:*

**enumerator ESP\_GATT\_CONN\_UNKNOWN**

Unknown connection reason. Corresponds to BTA\_GATT\_CONN\_UNKNOWN in bta/bta\_gatt\_api.h

**enumerator ESP\_GATT\_CONN\_L2C\_FAILURE**

General L2CAP failure. Corresponds to BTA\_GATT\_CONN\_L2C\_FAILURE in bta/bta\_gatt\_api.h

**enumerator ESP\_GATT\_CONN\_TIMEOUT**

Connection timeout. Corresponds to BTA\_GATT\_CONN\_TIMEOUT in bta/bta\_gatt\_api.h

**enumerator ESP\_GATT\_CONN\_TERMINATE\_PEER\_USER**

Connection terminated by peer user. Corresponds to BTA\_GATT\_CONN\_TERMINATE\_PEER\_USER in bta/bta\_gatt\_api.h

**enumerator ESP\_GATT\_CONN\_TERMINATE\_LOCAL\_HOST**

Connection terminated by local host. Corresponds to BTA\_GATT\_CONN\_TERMINATE\_LOCAL\_HOST in bta/bta\_gatt\_api.h

**enumerator ESP\_GATT\_CONN\_FAIL\_ESTABLISH**

Failure to establish connection. Corresponds to BTA\_GATT\_CONN\_FAIL\_ESTABLISH in bta/bta\_gatt\_api.h

**enumerator ESP\_GATT\_CONN\_LMP\_TIMEOUT**

Connection failed due to LMP response timeout. Corresponds to BTA\_GATT\_CONN\_LMP\_TIMEOUT in bta/bta\_gatt\_api.h

**enumerator ESP\_GATT\_CONN\_CONN\_CANCEL**

L2CAP connection cancelled. Corresponds to BTA\_GATT\_CONN\_CONN\_CANCEL in bta/bta\_gatt\_api.h

**enumerator ESP\_GATT\_CONN\_NONE**

No connection to cancel. Corresponds to BTA\_GATT\_CONN\_NONE in bta/bta\_gatt\_api.h

**enum esp\_gatt\_auth\_req\_t**

Defines the GATT authentication request types.

This enumeration lists the types of authentication requests that can be made. It corresponds to the BTA\_GATT\_AUTH\_REQ\_XXX values defined in bta/bta\_gatt\_api.h. The types include options for no authentication, unauthenticated encryption, authenticated encryption, and both signed versions with and without MITM (Man-In-The-Middle) protection.

*Values:*

**enumerator ESP\_GATT\_AUTH\_REQ\_NONE**

No authentication required. Corresponds to BTA\_GATT\_AUTH\_REQ\_NONE.

**enumerator ESP\_GATT\_AUTH\_REQ\_NO\_MITM**

Unauthenticated encryption. Corresponds to BTA\_GATT\_AUTH\_REQ\_NO\_MITM.

enumerator **ESP\_GATT\_AUTH\_REQ\_MITM**

Authenticated encryption (MITM protection). Corresponds to BTA\_GATT\_AUTH\_REQ\_MITM.

enumerator **ESP\_GATT\_AUTH\_REQ\_SIGNED\_NO\_MITM**

Signed data, no MITM protection. Corresponds to BTA\_GATT\_AUTH\_REQ\_SIGNED\_NO\_MITM.

enumerator **ESP\_GATT\_AUTH\_REQ\_SIGNED\_MITM**

Signed data with MITM protection. Corresponds to BTA\_GATT\_AUTH\_REQ\_SIGNED\_MITM.

enum **esp\_service\_source\_t**

Enumerates the possible sources of a GATT service discovery.

This enumeration identifies the source of a GATT service discovery process, indicating whether the service information was obtained from a remote device, from NVS (Non-Volatile Storage) flash, or the source is unknown.

*Values:*

enumerator **ESP\_GATT\_SERVICE\_FROM\_REMOTE\_DEVICE**

Service information from a remote device. Relates to BTA\_GATTC\_SERVICE\_INFO\_FROM\_REMOTE\_DEVICE.

enumerator **ESP\_GATT\_SERVICE\_FROM\_NVS\_FLASH**

Service information from NVS flash. Relates to BTA\_GATTC\_SERVICE\_INFO\_FROM\_NVS\_FLASH.

enumerator **ESP\_GATT\_SERVICE\_FROM\_UNKNOWN**

Service source is unknown. Relates to BTA\_GATTC\_SERVICE\_INFO\_FROM\_UNKNOWN.

enum **esp\_gatt\_write\_type\_t**

Defines the types of GATT write operations.

*Values:*

enumerator **ESP\_GATT\_WRITE\_TYPE\_NO\_RSP**

Write operation where no response is needed.

enumerator **ESP\_GATT\_WRITE\_TYPE\_RSP**

Write operation that requires a remote response.

enum **esp\_gatt\_db\_attr\_type\_t**

Enumerates types of GATT database attributes.

*Values:*

enumerator **ESP\_GATT\_DB\_PRIMARY\_SERVICE**

Primary service attribute.

enumerator **ESP\_GATT\_DB\_SECONDARY\_SERVICE**

Secondary service attribute.

enumerator **ESP\_GATT\_DB\_CHARACTERISTIC**

Characteristic attribute.

enumerator **ESP\_GATT\_DB\_DESCRIPTOR**

Descriptor attribute.

enumerator **ESP\_GATT\_DB\_INCLUDED\_SERVICE**

Included service attribute.

enumerator **ESP\_GATT\_DB\_ALL**

All attribute types.

## GATT 服务器 API

**应用示例** 以下示例及其教程存放在 ESP-IDF 示例的 `bluetooth/bluedroid/ble` 目录下：

- 以下为 GATT 服务器示例及其教程，该示例创建了一个带有属性表的 GATT 服务器，无需逐个添加属性。建议通过以下方式添加属性（官方推荐）。
  - [bluetooth/bluedroid/ble/gatt\\_server\\_service\\_table](#)
  - [GATT 服务器服务表示例](#)
- 以下为 GATT 服务器示例及其教程，该示例逐个添加 Bluedroid 定义的属性，创建 GATT 服务。建议通过以下方式添加属性。
  - [bluetooth/bluedroid/ble/gatt\\_server](#)
  - [GATT 服务器示例](#)
- 以下示例与低功耗蓝牙 (Bluetooth® LE) SPP 类似。在该示例中，GATT 服务器可以接收来自 UART 的数据，并将数据自动发送到对端设备。
  - [bluetooth/bluedroid/ble/ble\\_spp\\_server](#)

## API 参考

### Header File

- [components/bt/host/bluedroid/api/include/api/esp\\_gatts\\_api.h](#)
- This header file can be included with:

```
#include "esp_gatts_api.h"
```

- This header file is a part of the API provided by the `bt` component. To declare that your component depends on `bt`, add the following to your `CMakeLists.txt`:

```
REQUIRES bt
```

or

```
PRIV_REQUIRES bt
```

### Functions

`esp_err_t esp_ble_gatts_register_callback(esp_gatts_cb_t callback)`

This function is called to register application callbacks with BTA GATTS module.

**返回**

- `ESP_OK` : success
- other : failed

**esp\_gatts\_cb\_t esp\_ble\_gatts\_get\_callback** (void)

This function is called to get the current application callbacks with BTA GATTS module.

**返回**

- esp\_gatts\_cb\_t : current callback

**esp\_err\_t esp\_ble\_gatts\_app\_register** (uint16\_t app\_id)

This function is called to register application identifier.

**返回**

- ESP\_OK : success
- other : failed

**esp\_err\_t esp\_ble\_gatts\_app\_unregister** (esp\_gatt\_if\_t gatts\_if)

unregister with GATT Server.

**参数** gatts\_if -- [in] GATT server access interface

**返回**

- ESP\_OK : success
- other : failed

**esp\_err\_t esp\_ble\_gatts\_create\_service** (esp\_gatt\_if\_t gatts\_if, esp\_gatt\_srv\_id\_t \*service\_id, uint16\_t num\_handle)

Create a service. When service creation is done, a callback event ESP\_GATTS\_CREATE\_EVT is called to report status and service ID to the profile. The service ID obtained in the callback function needs to be used when adding included service and characteristics/descriptors into the service.

**参数**

- gatts\_if -- [in] GATT server access interface
- service\_id -- [in] service ID.
- num\_handle -- [in] number of handle requested for this service.

**返回**

- ESP\_OK : success
- other : failed

**esp\_err\_t esp\_ble\_gatts\_create\_attr\_tab** (const esp\_gatts\_attr\_db\_t \*gatts\_attr\_db, esp\_gatt\_if\_t gatts\_if, uint16\_t max\_nb\_attr, uint8\_t srv\_inst\_id)

Create a service attribute tab.

**参数**

- gatts\_attr\_db -- [in] the pointer to the service attr tab
- gatts\_if -- [in] GATT server access interface
- max\_nb\_attr -- [in] the number of attribute to be added to the service database.
- srv\_inst\_id -- [in] the instance id of the service

**返回**

- ESP\_OK : success
- other : failed

**esp\_err\_t esp\_ble\_gatts\_add\_included\_service** (uint16\_t service\_handle, uint16\_t included\_service\_handle)

This function is called to add an included service. This function have to be called between 'esp\_ble\_gatts\_create\_service' and 'esp\_ble\_gatts\_add\_char'. After included service is included, a callback event ESP\_GATTS\_ADD\_INCL\_SRVC\_EVT is reported the included service ID.

**参数**

- service\_handle -- [in] service handle to which this included service is to be added.
- included\_service\_handle -- [in] the service ID to be included.

**返回**

- ESP\_OK : success
- other : failed

*esp\_err\_t* **esp\_ble\_gatts\_add\_char** (uint16\_t service\_handle, *esp\_bt\_uuid\_t* \*char\_uuid, *esp\_gatt\_perm\_t* perm, *esp\_gatt\_char\_prop\_t* property, *esp\_attr\_value\_t* \*char\_val, *esp\_attr\_control\_t* \*control)

This function is called to add a characteristic into a service.

#### 参数

- **service\_handle** -- [in] service handle to which this included service is to be added.
- **char\_uuid** -- [in] : Characteristic UUID.
- **perm** -- [in] : Characteristic value declaration attribute permission.
- **property** -- [in] : Characteristic Properties
- **char\_val** -- [in] : Characteristic value
- **control** -- [in] : attribute response control byte

#### 返回

- ESP\_OK : success
- other : failed

*esp\_err\_t* **esp\_ble\_gatts\_add\_char\_descr** (uint16\_t service\_handle, *esp\_bt\_uuid\_t* \*descr\_uuid, *esp\_gatt\_perm\_t* perm, *esp\_attr\_value\_t* \*char\_descr\_val, *esp\_attr\_control\_t* \*control)

This function is called to add characteristic descriptor. When it's done, a callback event ESP\_GATTS\_ADD\_DESCR\_EVT is called to report the status and an ID number for this descriptor.

#### 参数

- **service\_handle** -- [in] service handle to which this characteristic descriptor is to be added.
- **perm** -- [in] descriptor access permission.
- **descr\_uuid** -- [in] descriptor UUID.
- **char\_descr\_val** -- [in] : Characteristic descriptor value
- **control** -- [in] : attribute response control byte

#### 返回

- ESP\_OK : success
- other : failed

*esp\_err\_t* **esp\_ble\_gatts\_delete\_service** (uint16\_t service\_handle)

This function is called to delete a service. When this is done, a callback event ESP\_GATTS\_DELETE\_EVT is report with the status.

**参数** **service\_handle** -- [in] service\_handle to be deleted.

#### 返回

- ESP\_OK : success
- other : failed

*esp\_err\_t* **esp\_ble\_gatts\_start\_service** (uint16\_t service\_handle)

This function is called to start a service.

**参数** **service\_handle** -- [in] the service handle to be started.

#### 返回

- ESP\_OK : success
- other : failed

*esp\_err\_t* **esp\_ble\_gatts\_stop\_service** (uint16\_t service\_handle)

This function is called to stop a service.

**参数** **service\_handle** -- [in] - service to be topped.

#### 返回

- ESP\_OK : success
- other : failed

*esp\_err\_t* **esp\_ble\_gatts\_send\_indicate** (*esp\_gatt\_if\_t* gatts\_if, uint16\_t conn\_id, uint16\_t attr\_handle, uint16\_t value\_len, uint8\_t \*value, bool need\_confirm)

Send indicate or notify to GATT client. Set param need\_confirm as false will send notification, otherwise indication. Note: the size of indicate or notify data need less than MTU size, see "esp\_ble\_gattc\_send\_mtu\_req".

## 参数

- **gatts\_if** -- **[in]** GATT server access interface
- **conn\_id** -- **[in]** - connection id to indicate.
- **attr\_handle** -- **[in]** - attribute handle to indicate.
- **value\_len** -- **[in]** - indicate value length.
- **value** -- **[in]** value to indicate.
- **need\_confirm** -- **[in]** - Whether a confirmation is required. false sends a GATT notification, true sends a GATT indication.

## 返回

- ESP\_OK : success
- other : failed

*esp\_err\_t* **esp\_ble\_gatts\_send\_response** (*esp\_gatt\_if\_t* gatts\_if, uint16\_t conn\_id, uint32\_t trans\_id, *esp\_gatt\_status\_t* status, *esp\_gatt\_rsp\_t* \*rsp)

This function is called to send a response to a request.

## 参数

- **gatts\_if** -- **[in]** GATT server access interface
- **conn\_id** -- **[in]** - connection identifier.
- **trans\_id** -- **[in]** - transfer id
- **status** -- **[in]** - response status
- **rsp** -- **[in]** - response data.

## 返回

- ESP\_OK : success
- other : failed

*esp\_err\_t* **esp\_ble\_gatts\_set\_attr\_value** (uint16\_t attr\_handle, uint16\_t length, const uint8\_t \*value)

This function is called to set the attribute value by the application.

## 参数

- **attr\_handle** -- **[in]** the attribute handle which to be set
- **length** -- **[in]** the value length
- **value** -- **[in]** the pointer to the attribute value

## 返回

- ESP\_OK : success
- other : failed

*esp\_gatt\_status\_t* **esp\_ble\_gatts\_get\_attr\_value** (uint16\_t attr\_handle, uint16\_t \*length, const uint8\_t \*\*value)

Retrieve attribute value.

## 参数

- **attr\_handle** -- **[in]** Attribute handle.
- **length** -- **[out]** pointer to the attribute value length
- **value** -- **[out]** Pointer to attribute value payload, the value cannot be modified by user

## 返回

- ESP\_GATT\_OK : success
- other : failed

*esp\_err\_t* **esp\_ble\_gatts\_open** (*esp\_gatt\_if\_t* gatts\_if, *esp\_bd\_addr\_t* remote\_bda, bool is\_direct)

Open a direct open connection or add a background auto connection.

## 参数

- **gatts\_if** -- **[in]** GATT server access interface
- **remote\_bda** -- **[in]** remote device bluetooth device address.
- **is\_direct** -- **[in]** direct connection or background auto connection

## 返回

- ESP\_OK : success
- other : failed



*esp\_err\_t* **esp\_ble\_gatts\_close** (*esp\_gatt\_if\_t* gatts\_if, uint16\_t conn\_id)

Close a connection a remote device.

#### 参数

- **gatts\_if** -- [in] GATT server access interface
- **conn\_id** -- [in] connection ID to be closed.

#### 返回

- ESP\_OK : success
- other : failed

*esp\_err\_t* **esp\_ble\_gatts\_send\_service\_change\_indication** (*esp\_gatt\_if\_t* gatts\_if, *esp\_bd\_addr\_t* remote\_bda)

Send service change indication.

#### 参数

- **gatts\_if** -- [in] GATT server access interface
- **remote\_bda** -- [in] remote device bluetooth device address. If remote\_bda is NULL then it will send service change indication to all the connected devices and if not then to a specific device

#### 返回

- ESP\_OK : success
- other : failed

*esp\_err\_t* **esp\_ble\_gatts\_show\_local\_database** (void)

Print local database (GATT service table)

#### 返回

- ESP\_OK : success
- other : failed

## Unions

union **esp\_ble\_gatts\_cb\_param\_t**

*#include <esp\_gatts\_api.h>* Gatt server callback parameters union.

### Public Members

struct *esp\_ble\_gatts\_cb\_param\_t::gatts\_reg\_evt\_param* **reg**

Gatt server callback param of ESP\_GATTS\_REG\_EVT

struct *esp\_ble\_gatts\_cb\_param\_t::gatts\_read\_evt\_param* **read**

Gatt server callback param of ESP\_GATTS\_READ\_EVT

struct *esp\_ble\_gatts\_cb\_param\_t::gatts\_write\_evt\_param* **write**

Gatt server callback param of ESP\_GATTS\_WRITE\_EVT

struct *esp\_ble\_gatts\_cb\_param\_t::gatts\_exec\_write\_evt\_param* **exec\_write**

Gatt server callback param of ESP\_GATTS\_EXEC\_WRITE\_EVT

struct *esp\_ble\_gatts\_cb\_param\_t::gatts\_mtu\_evt\_param* **mtu**

Gatt server callback param of ESP\_GATTS\_MTU\_EVT

struct *esp\_ble\_gatts\_cb\_param\_t::gatts\_conf\_evt\_param* **conf**

Gatt server callback param of ESP\_GATTS\_CONF\_EVT (confirm)

struct *esp\_ble\_gatts\_cb\_param\_t::gatts\_create\_evt\_param* **create**  
Gatt server callback param of ESP\_GATTS\_CREATE\_EVT

struct *esp\_ble\_gatts\_cb\_param\_t::gatts\_add\_incl\_srvc\_evt\_param* **add\_incl\_srvc**  
Gatt server callback param of ESP\_GATTS\_ADD\_INCL\_SRVC\_EVT

struct *esp\_ble\_gatts\_cb\_param\_t::gatts\_add\_char\_evt\_param* **add\_char**  
Gatt server callback param of ESP\_GATTS\_ADD\_CHAR\_EVT

struct *esp\_ble\_gatts\_cb\_param\_t::gatts\_add\_char\_descr\_evt\_param* **add\_char\_descr**  
Gatt server callback param of ESP\_GATTS\_ADD\_CHAR\_DESCR\_EVT

struct *esp\_ble\_gatts\_cb\_param\_t::gatts\_delete\_evt\_param* **del**  
Gatt server callback param of ESP\_GATTS\_DELETE\_EVT

struct *esp\_ble\_gatts\_cb\_param\_t::gatts\_start\_evt\_param* **start**  
Gatt server callback param of ESP\_GATTS\_START\_EVT

struct *esp\_ble\_gatts\_cb\_param\_t::gatts\_stop\_evt\_param* **stop**  
Gatt server callback param of ESP\_GATTS\_STOP\_EVT

struct *esp\_ble\_gatts\_cb\_param\_t::gatts\_connect\_evt\_param* **connect**  
Gatt server callback param of ESP\_GATTS\_CONNECT\_EVT

struct *esp\_ble\_gatts\_cb\_param\_t::gatts\_disconnect\_evt\_param* **disconnect**  
Gatt server callback param of ESP\_GATTS\_DISCONNECT\_EVT

struct *esp\_ble\_gatts\_cb\_param\_t::gatts\_open\_evt\_param* **open**  
Gatt server callback param of ESP\_GATTS\_OPEN\_EVT

struct *esp\_ble\_gatts\_cb\_param\_t::gatts\_cancel\_open\_evt\_param* **cancel\_open**  
Gatt server callback param of ESP\_GATTS\_CANCEL\_OPEN\_EVT

struct *esp\_ble\_gatts\_cb\_param\_t::gatts\_close\_evt\_param* **close**  
Gatt server callback param of ESP\_GATTS\_CLOSE\_EVT

struct *esp\_ble\_gatts\_cb\_param\_t::gatts\_congest\_evt\_param* **congest**  
Gatt server callback param of ESP\_GATTS\_CONGEST\_EVT

struct *esp\_ble\_gatts\_cb\_param\_t::gatts\_rsp\_evt\_param* **rsp**  
Gatt server callback param of ESP\_GATTS\_RESPONSE\_EVT

struct *esp\_ble\_gatts\_cb\_param\_t::gatts\_add\_attr\_tab\_evt\_param* **add\_attr\_tab**  
Gatt server callback param of ESP\_GATTS\_CREAT\_ATTR\_TAB\_EVT

struct *esp\_ble\_gatts\_cb\_param\_t::gatts\_set\_attr\_val\_evt\_param* **set\_attr\_val**  
Gatt server callback param of ESP\_GATTS\_SET\_ATTR\_VAL\_EVT

```
struct esp_ble_gatts_cb_param_t::gatts_send_service_change_evt_param service_change  
    Gatt server callback param of ESP_GATTS_SEND_SERVICE_CHANGE_EVT
```

```
struct gatts_add_attr_tab_evt_param  
    #include <esp_gatts_api.h> ESP_GATTS_CREAT_ATTR_TAB_EVT.
```

### Public Members

*esp\_gatt\_status\_t* **status**  
 Operation status

*esp\_bt\_uuid\_t* **svc\_uuid**  
 Service uuid type

uint8\_t **svc\_inst\_id**  
 Service id

uint16\_t **num\_handle**  
 The number of the attribute handle to be added to the gatts database

uint16\_t \***handles**  
 The number to the handles

```
struct gatts_add_char_descr_evt_param  
    #include <esp_gatts_api.h> ESP_GATTS_ADD_CHAR_DESCR_EVT.
```

### Public Members

*esp\_gatt\_status\_t* **status**  
 Operation status

uint16\_t **attr\_handle**  
 Descriptor attribute handle

uint16\_t **service\_handle**  
 Service attribute handle

*esp\_bt\_uuid\_t* **descr\_uuid**  
 Characteristic descriptor uuid

```
struct gatts_add_char_evt_param  
    #include <esp_gatts_api.h> ESP_GATTS_ADD_CHAR_EVT.
```

### Public Members

*esp\_gatt\_status\_t* **status**

Operation status

uint16\_t **attr\_handle**

Characteristic attribute handle

uint16\_t **service\_handle**

Service attribute handle

*esp\_bt\_uuid\_t* **char\_uuid**

Characteristic uuid

struct **gatts\_add\_incl\_srvc\_evt\_param**

*#include <esp\_gatts\_api.h>* ESP\_GATTS\_ADD\_INCL\_SRVC\_EVT.

### Public Members

*esp\_gatt\_status\_t* **status**

Operation status

uint16\_t **attr\_handle**

Included service attribute handle

uint16\_t **service\_handle**

Service attribute handle

struct **gatts\_cancel\_open\_evt\_param**

*#include <esp\_gatts\_api.h>* ESP\_GATTS\_CANCEL\_OPEN\_EVT.

### Public Members

*esp\_gatt\_status\_t* **status**

Operation status

struct **gatts\_close\_evt\_param**

*#include <esp\_gatts\_api.h>* ESP\_GATTS\_CLOSE\_EVT.

### Public Members

*esp\_gatt\_status\_t* **status**

Operation status

uint16\_t **conn\_id**

Connection id

struct **gatts\_conf\_evt\_param**

*#include <esp\_gatts\_api.h>* ESP\_GATTS\_CONF\_EVT.

### Public Members

*esp\_gatt\_status\_t* **status**

Operation status

uint16\_t **conn\_id**

Connection id

uint16\_t **handle**

attribute handle

uint16\_t **len**

The indication or notification value length, len is valid when send notification or indication failed

uint8\_t \***value**

The indication or notification value , value is valid when send notification or indication failed

struct **gatts\_congest\_evt\_param**

*#include <esp\_gatts\_api.h>* ESP\_GATTS\_LISTEN\_EVT.

ESP\_GATTS\_CONGEST\_EVT

### Public Members

uint16\_t **conn\_id**

Connection id

bool **congested**

Congested or not

struct **gatts\_connect\_evt\_param**

*#include <esp\_gatts\_api.h>* ESP\_GATTS\_CONNECT\_EVT.

### Public Members

uint16\_t **conn\_id**

Connection id

uint8\_t **link\_role**

Link role : master role = 0 ; slave role = 1

*esp\_bd\_addr\_t* **remote\_bda**

Remote bluetooth device address

*esp\_gatt\_conn\_params\_t* **conn\_params**

current Connection parameters

*esp\_ble\_addr\_type\_t* **ble\_addr\_type**

Remote BLE device address type

uint16\_t **conn\_handle**

HCI connection handle

struct **gatts\_create\_evt\_param**

*#include <esp\_gatts\_api.h>* ESP\_GATTS\_UNREG\_EVT.

ESP\_GATTS\_CREATE\_EVT

### Public Members

*esp\_gatt\_status\_t* **status**

Operation status

uint16\_t **service\_handle**

Service attribute handle

*esp\_gatt\_srv\_id\_t* **service\_id**

Service id, include service uuid and other information

struct **gatts\_delete\_evt\_param**

*#include <esp\_gatts\_api.h>* ESP\_GATTS\_DELETE\_EVT.

### Public Members

*esp\_gatt\_status\_t* **status**

Operation status

uint16\_t **service\_handle**

Service attribute handle

struct **gatts\_disconnect\_evt\_param**

*#include <esp\_gatts\_api.h>* ESP\_GATTS\_DISCONNECT\_EVT.

### Public Members

uint16\_t **conn\_id**

Connection id

*esp\_bd\_addr\_t* **remote\_bda**

Remote bluetooth device address

*esp\_gatt\_conn\_reason\_t* **reason**

Indicate the reason of disconnection

```
struct gatts_exec_write_evt_param  
    #include <esp_gatts_api.h> ESP_GATTS_EXEC_WRITE_EVT.
```

### Public Members

uint16\_t **conn\_id**  
 Connection id

uint32\_t **trans\_id**  
 Transfer id

*esp\_bd\_addr\_t* **bda**  
 The bluetooth device address which been written

uint8\_t **exec\_write\_flag**  
 Execute write flag

```
struct gatts_mtu_evt_param  
    #include <esp_gatts_api.h> ESP_GATTS_MTU_EVT.
```

### Public Members

uint16\_t **conn\_id**  
 Connection id

uint16\_t **mtu**  
 MTU size

```
struct gatts_open_evt_param  
    #include <esp_gatts_api.h> ESP_GATTS_OPEN_EVT.
```

### Public Members

*esp\_gatt\_status\_t* **status**  
 Operation status

```
struct gatts_read_evt_param  
    #include <esp_gatts_api.h> ESP_GATTS_READ_EVT.
```

### Public Members

uint16\_t **conn\_id**  
 Connection id

uint32\_t **trans\_id**  
 Transfer id

*esp\_bd\_addr\_t* **bda**

The bluetooth device address which been read

uint16\_t **handle**

The attribute handle

uint16\_t **offset**

Offset of the value, if the value is too long

bool **is\_long**

The value is too long or not

bool **need\_rsp**

The read operation need to do response

struct **gatts\_reg\_evt\_param**

*#include <esp\_gatts\_api.h>* ESP\_GATTS\_REG\_EVT.

### Public Members

*esp\_gatt\_status\_t* **status**

Operation status

uint16\_t **app\_id**

Application id which input in register API

struct **gatts\_rsp\_evt\_param**

*#include <esp\_gatts\_api.h>* ESP\_GATTS\_RESPONSE\_EVT.

### Public Members

*esp\_gatt\_status\_t* **status**

Operation status

uint16\_t **handle**

Attribute handle which send response

struct **gatts\_send\_service\_change\_evt\_param**

*#include <esp\_gatts\_api.h>* ESP\_GATTS\_SEND\_SERVICE\_CHANGE\_EVT.

### Public Members

*esp\_gatt\_status\_t* **status**

Operation status

struct **gatts\_set\_attr\_val\_evt\_param**

*#include <esp\_gatts\_api.h>* ESP\_GATTS\_SET\_ATTR\_VAL\_EVT.



**Public Members****uint16\_t `srvc_handle`**

The service handle

**uint16\_t `attr_handle`**

The attribute handle

***esp\_gatt\_status\_t* `status`**

Operation status

struct **`gatts_start_evt_param`***#include <esp\_gatts\_api.h>* ESP\_GATTS\_START\_EVT.**Public Members*****esp\_gatt\_status\_t* `status`**

Operation status

**uint16\_t `service_handle`**

Service attribute handle

struct **`gatts_stop_evt_param`***#include <esp\_gatts\_api.h>* ESP\_GATTS\_STOP\_EVT.**Public Members*****esp\_gatt\_status\_t* `status`**

Operation status

**uint16\_t `service_handle`**

Service attribute handle

struct **`gatts_write_evt_param`***#include <esp\_gatts\_api.h>* ESP\_GATTS\_WRITE\_EVT.**Public Members****uint16\_t `conn_id`**

Connection id

**uint32\_t `trans_id`**

Transfer id

***esp\_bd\_addr\_t* `bda`**

The bluetooth device address which been written

uint16\_t **handle**

The attribute handle

uint16\_t **offset**

Offset of the value, if the value is too long

bool **need\_rsp**

The write operation need to do response

bool **is\_prep**

This write operation is prepare write

uint16\_t **len**

The write attribute value length

uint8\_t \***value**

The write attribute value

## Macros

**ESP\_GATT\_PREP\_WRITE\_CANCEL**

Prepare write flag to indicate cancel prepare write

**ESP\_GATT\_PREP\_WRITE\_EXEC**

Prepare write flag to indicate execute prepare write

## Type Definitions

typedef void (\***esp\_gatts\_cb\_t**)(*esp\_gatts\_cb\_event\_t* event, *esp\_gatt\_if\_t* gatts\_if, *esp\_ble\_gatts\_cb\_param\_t* \*param)

GATT Server callback function type.

**Param event** : Event type

**Param gatts\_if** : GATT server access interface, normally different gatts\_if correspond to different profile

**Param param** : Point to callback parameter, currently is union type

## Enumerations

enum **esp\_gatts\_cb\_event\_t**

GATT Server callback function events.

*Values:*

enumerator **ESP\_GATTS\_REG\_EVT**

When register application id, the event comes

enumerator **ESP\_GATTS\_READ\_EVT**

When gatt client request read operation, the event comes

enumerator **ESP\_GATTS\_WRITE\_EVT**

When gatt client request write operation, the event comes

enumerator **ESP\_GATTS\_EXEC\_WRITE\_EVT**

When gatt client request execute write, the event comes

enumerator **ESP\_GATTS\_MTU\_EVT**

When set mtu complete, the event comes

enumerator **ESP\_GATTS\_CONF\_EVT**

When receive confirm, the event comes

enumerator **ESP\_GATTS\_UNREG\_EVT**

When unregister application id, the event comes

enumerator **ESP\_GATTS\_CREATE\_EVT**

When create service complete, the event comes

enumerator **ESP\_GATTS\_ADD\_INCL\_SRVC\_EVT**

When add included service complete, the event comes

enumerator **ESP\_GATTS\_ADD\_CHAR\_EVT**

When add characteristic complete, the event comes

enumerator **ESP\_GATTS\_ADD\_CHAR\_DESCR\_EVT**

When add descriptor complete, the event comes

enumerator **ESP\_GATTS\_DELETE\_EVT**

When delete service complete, the event comes

enumerator **ESP\_GATTS\_START\_EVT**

When start service complete, the event comes

enumerator **ESP\_GATTS\_STOP\_EVT**

When stop service complete, the event comes

enumerator **ESP\_GATTS\_CONNECT\_EVT**

When gatt client connect, the event comes

enumerator **ESP\_GATTS\_DISCONNECT\_EVT**

When gatt client disconnect, the event comes

enumerator **ESP\_GATTS\_OPEN\_EVT**

When connect to peer, the event comes

enumerator **ESP\_GATTS\_CANCEL\_OPEN\_EVT**

When disconnect from peer, the event comes

enumerator **ESP\_GATTS\_CLOSE\_EVT**

When gatt server close, the event comes

enumerator **ESP\_GATTS\_LISTEN\_EVT**

When gatt listen to be connected the event comes

enumerator **ESP\_GATTS\_CONGEST\_EVT**

When congest happen, the event comes

enumerator **ESP\_GATTS\_RESPONSE\_EVT**

When gatt send response complete, the event comes

enumerator **ESP\_GATTS\_CREAT\_ATTR\_TAB\_EVT**

When gatt create table complete, the event comes

enumerator **ESP\_GATTS\_SET\_ATTR\_VAL\_EVT**

When gatt set attr value complete, the event comes

enumerator **ESP\_GATTS\_SEND\_SERVICE\_CHANGE\_EVT**

When gatt send service change indication complete, the event comes

## GATT Client API

**Application Example** Check [bluetooth/bluedroid/ble](#) folder in ESP-IDF examples, which contains the following demos and their tutorials:

- This is a GATT client demo and its tutorial. This demo can scan for devices, connect to the GATT server and discover its services.
  - [bluetooth/bluedroid/ble/gatt\\_client](#)
  - [GATT Client Example Walkthrough](#)
- This is a multiple connection demo and its tutorial. This demo can connect to multiple GATT server devices and discover their services.
  - [bluetooth/bluedroid/ble/gattc\\_multi\\_connect](#)
  - [GATT Client Multi-connection Example Walkthrough](#)
- This is a demo similar to Bluetooth® Low Energy (Bluetooth LE) SPP. This demo, which acts as a GATT client, can receive data from UART and then send the data to the peer device automatically.
  - [bluetooth/bluedroid/ble/ble\\_spp\\_client](#)

## API Reference

### Header File

- [components/bt/host/bluedroid/api/include/api/esp\\_gattc\\_api.h](#)
- This header file can be included with:

```
#include "esp_gattc_api.h"
```

- This header file is a part of the API provided by the `bt` component. To declare that your component depends on `bt`, add the following to your `CMakeLists.txt`:

```
REQUIRES bt
```

or

```
PRIV_REQUIRES bt
```

**Functions**

*esp\_err\_t* **esp\_ble\_gattc\_register\_callback** (*esp\_gattc\_cb\_t* callback)

This function is called to register application callbacks with GATTC module.

**参数** **callback** -- **[in]** : pointer to the application callback function.

**返回**

- ESP\_OK: success
- other: failed

*esp\_gattc\_cb\_t* **esp\_ble\_gattc\_get\_callback** (void)

This function is called to get the current application callbacks with BTA GATTC module.

**返回**

- esp\_gattC\_cb\_t : current callback

*esp\_err\_t* **esp\_ble\_gattc\_app\_register** (uint16\_t app\_id)

This function is called to register application callbacks with GATTC module.

**参数** **app\_id** -- **[in]** : Application Identify (UUID), for different application

**返回**

- ESP\_OK: success
- other: failed

*esp\_err\_t* **esp\_ble\_gattc\_app\_unregister** (*esp\_gatt\_if\_t* gattc\_if)

This function is called to unregister an application from the GATTC module.

---

**备注:** Before calling this API, ensure that all activities related to the application, such as connections, scans, ADV, are properly closed.

---

**参数** **gattc\_if** -- **[in]** Gatt client access interface.

**返回**

- ESP\_OK: success
- other: failed

*esp\_err\_t* **esp\_ble\_gattc\_open** (*esp\_gatt\_if\_t* gattc\_if, *esp\_bd\_addr\_t* remote\_bda, *esp\_ble\_addr\_type\_t* remote\_addr\_type, bool is\_direct)

Open a direct connection or add a background auto connection.

**参数**

- **gattc\_if** -- **[in]** Gatt client access interface.
- **remote\_bda** -- **[in]** remote device bluetooth device address.
- **remote\_addr\_type** -- **[in]** remote device bluetooth device the address type.
- **is\_direct** -- **[in]** direct connection or background auto connection (by now, background auto connection is not supported).

**返回**

- ESP\_OK: success
- other: failed

*esp\_err\_t* **esp\_ble\_gattc\_aux\_open** (*esp\_gatt\_if\_t* gattc\_if, *esp\_bd\_addr\_t* remote\_bda, *esp\_ble\_addr\_type\_t* remote\_addr\_type, bool is\_direct)

*esp\_err\_t* **esp\_ble\_gattc\_close** (*esp\_gatt\_if\_t* gattc\_if, uint16\_t conn\_id)

Close the virtual connection to the GATT server. gattc may have multiple virtual GATT server connections when multiple app\_id registered, this API only close one virtual GATT server connection. if there exist other virtual GATT server connections, it does not disconnect the physical connection. if you want to disconnect the physical connection directly, you can use esp\_ble\_gap\_disconnect(esp\_bd\_addr\_t remote\_device).

**参数**

- **gattc\_if** -- **[in]** Gatt client access interface.
- **conn\_id** -- **[in]** connection ID to be closed.

## 返回

- ESP\_OK: success
- other: failed

*esp\_err\_t* **esp\_ble\_gattc\_send\_mtu\_req** (*esp\_gatt\_if\_t* gattc\_if, uint16\_t conn\_id)

Configure the MTU size in the GATT channel. This can be done only once per connection. Before using, use `esp_ble_gattc_set_local_mtu()` to configure the local MTU size.

## 参数

- **gattc\_if** -- **[in]** Gatt client access interface.
- **conn\_id** -- **[in]** connection ID.

## 返回

- ESP\_OK: success
- other: failed

*esp\_err\_t* **esp\_ble\_gattc\_search\_service** (*esp\_gatt\_if\_t* gattc\_if, uint16\_t conn\_id, *esp\_bt\_uuid\_t* \*filter\_uuid)

This function is called to get service from local cache. This function report service search result by a callback event, and followed by a service search complete event. Note: 128-bit base UUID will automatically be converted to a 16-bit UUID in the search results. Other types of UUID remain unchanged.

## 参数

- **gattc\_if** -- **[in]** Gatt client access interface.
- **conn\_id** -- **[in]** connection ID.
- **filter\_uuid** -- **[in]** a UUID of the service application is interested in. If Null, discover for all services.

## 返回

- ESP\_OK: success
- other: failed

*esp\_gatt\_status\_t* **esp\_ble\_gattc\_get\_service** (*esp\_gatt\_if\_t* gattc\_if, uint16\_t conn\_id, *esp\_bt\_uuid\_t* \*svc\_uuid, *esp\_gattc\_service\_elem\_t* \*result, uint16\_t \*count, uint16\_t offset)

Find all the service with the given service uuid in the gattc cache, if the `svc_uuid` is NULL, find all the service. Note: It just get service from local cache, won't get from remote devices. If want to get it from remote device, need to used the `esp_ble_gattc_cache_refresh`, then call `esp_ble_gattc_get_service` again.

## 参数

- **gattc\_if** -- **[in]** Gatt client access interface.
- **conn\_id** -- **[in]** connection ID which identify the server.
- **svc\_uuid** -- **[in]** the pointer to the service uuid.
- **result** -- **[out]** The pointer to the service which has been found in the gattc cache.
- **count** -- **[inout]** input the number of service want to find, it will output the number of service has been found in the gattc cache with the given service uuid.
- **offset** -- **[in]** Offset of the service position to get.

## 返回

- ESP\_OK: success
- other: failed

*esp\_gatt\_status\_t* **esp\_ble\_gattc\_get\_all\_char** (*esp\_gatt\_if\_t* gattc\_if, uint16\_t conn\_id, uint16\_t start\_handle, uint16\_t end\_handle, *esp\_gattc\_char\_elem\_t* \*result, uint16\_t \*count, uint16\_t offset)

Find all the characteristic with the given service in the gattc cache Note: It just get characteristic from local cache, won't get from remote devices.

## 参数

- **gattc\_if** -- **[in]** Gatt client access interface.
- **conn\_id** -- **[in]** connection ID which identify the server.
- **start\_handle** -- **[in]** the attribute start handle.
- **end\_handle** -- **[in]** the attribute end handle

- **result** -- **[out]** The pointer to the characteristic in the service.
- **count** -- **[inout]** input the number of characteristic want to find, it will output the number of characteristic has been found in the gattc cache with the given service.
- **offset** -- **[in]** Offset of the characteristic position to get.

#### 返回

- ESP\_OK: success
- other: failed

*esp\_gatt\_status\_t* **esp\_ble\_gattc\_get\_all\_descr** (*esp\_gatt\_if\_t* gattc\_if, uint16\_t conn\_id, uint16\_t char\_handle, *esp\_gattc\_descr\_elem\_t* \*result, uint16\_t \*count, uint16\_t offset)

Find all the descriptor with the given characteristic in the gattc cache Note: It just get descriptor from local cache, won't get from remote devices.

#### 参数

- **gattc\_if** -- **[in]** Gatt client access interface.
- **conn\_id** -- **[in]** connection ID which identify the server.
- **char\_handle** -- **[in]** the given characteristic handle
- **result** -- **[out]** The pointer to the descriptor in the characteristic.
- **count** -- **[inout]** input the number of descriptor want to find, it will output the number of descriptor has been found in the gattc cache with the given characteristic.
- **offset** -- **[in]** Offset of the descriptor position to get.

#### 返回

- ESP\_OK: success
- other: failed

*esp\_gatt\_status\_t* **esp\_ble\_gattc\_get\_char\_by\_uuid** (*esp\_gatt\_if\_t* gattc\_if, uint16\_t conn\_id, uint16\_t start\_handle, uint16\_t end\_handle, *esp\_bt\_uuid\_t* char\_uuid, *esp\_gattc\_char\_elem\_t* \*result, uint16\_t \*count)

Find the characteristic with the given characteristic uuid in the gattc cache Note: It just get characteristic from local cache, won't get from remote devices.

#### 参数

- **gattc\_if** -- **[in]** Gatt client access interface.
- **conn\_id** -- **[in]** connection ID which identify the server.
- **start\_handle** -- **[in]** the attribute start handle
- **end\_handle** -- **[in]** the attribute end handle
- **char\_uuid** -- **[in]** the characteristic uuid
- **result** -- **[out]** The pointer to the characteristic in the service.
- **count** -- **[inout]** input the number of characteristic want to find, it will output the number of characteristic has been found in the gattc cache with the given service.

#### 返回

- ESP\_OK: success
- other: failed

*esp\_gatt\_status\_t* **esp\_ble\_gattc\_get\_descr\_by\_uuid** (*esp\_gatt\_if\_t* gattc\_if, uint16\_t conn\_id, uint16\_t start\_handle, uint16\_t end\_handle, *esp\_bt\_uuid\_t* char\_uuid, *esp\_bt\_uuid\_t* descr\_uuid, *esp\_gattc\_descr\_elem\_t* \*result, uint16\_t \*count)

Find the descriptor with the given characteristic uuid in the gattc cache Note: It just get descriptor from local cache, won't get from remote devices.

#### 参数

- **gattc\_if** -- **[in]** Gatt client access interface.
- **conn\_id** -- **[in]** connection ID which identify the server.
- **start\_handle** -- **[in]** the attribute start handle
- **end\_handle** -- **[in]** the attribute end handle
- **char\_uuid** -- **[in]** the characteristic uuid.
- **descr\_uuid** -- **[in]** the descriptor uuid.

- **result** -- **[out]** The pointer to the descriptor in the given characteristic.
- **count** -- **[inout]** input the number of descriptor want to find, it will output the number of descriptor has been found in the gattc cache with the given characteristic.

**返回**

- ESP\_OK: success
- other: failed

*esp\_gatt\_status\_t* **esp\_ble\_gattc\_get\_descr\_by\_char\_handle** (*esp\_gatt\_if\_t* gattc\_if, uint16\_t conn\_id, uint16\_t char\_handle, *esp\_bt\_uuid\_t* descr\_uuid, *esp\_gattc\_descr\_elem\_t* \*result, uint16\_t \*count)

Find the descriptor with the given characteristic handle in the gattc cache Note: It just get descriptor from local cache, won't get from remote devices.

**参数**

- **gattc\_if** -- **[in]** Gatt client access interface.
- **conn\_id** -- **[in]** connection ID which identify the server.
- **char\_handle** -- **[in]** the characteristic handle.
- **descr\_uuid** -- **[in]** the descriptor uuid.
- **result** -- **[out]** The pointer to the descriptor in the given characteristic.
- **count** -- **[inout]** input the number of descriptor want to find, it will output the number of descriptor has been found in the gattc cache with the given characteristic.

**返回**

- ESP\_OK: success
- other: failed

*esp\_gatt\_status\_t* **esp\_ble\_gattc\_get\_include\_service** (*esp\_gatt\_if\_t* gattc\_if, uint16\_t conn\_id, uint16\_t start\_handle, uint16\_t end\_handle, *esp\_bt\_uuid\_t* \*incl\_uuid, *esp\_gattc\_incl\_svc\_elem\_t* \*result, uint16\_t \*count)

Find the include service with the given service handle in the gattc cache Note: It just get include service from local cache, won't get from remote devices.

**参数**

- **gattc\_if** -- **[in]** Gatt client access interface.
- **conn\_id** -- **[in]** connection ID which identify the server.
- **start\_handle** -- **[in]** the attribute start handle
- **end\_handle** -- **[in]** the attribute end handle
- **incl\_uuid** -- **[in]** the include service uuid
- **result** -- **[out]** The pointer to the include service in the given service.
- **count** -- **[inout]** input the number of include service want to find, it will output the number of include service has been found in the gattc cache with the given service.

**返回**

- ESP\_OK: success
- other: failed

*esp\_gatt\_status\_t* **esp\_ble\_gattc\_get\_attr\_count** (*esp\_gatt\_if\_t* gattc\_if, uint16\_t conn\_id, *esp\_gatt\_db\_attr\_type\_t* type, uint16\_t start\_handle, uint16\_t end\_handle, uint16\_t char\_handle, uint16\_t \*count)

Find the attribute count with the given service or characteristic in the gattc cache.

**参数**

- **gattc\_if** -- **[in]** Gatt client access interface.
- **conn\_id** -- **[in]** connection ID which identify the server.
- **type** -- **[in]** the attribute type.
- **start\_handle** -- **[in]** the attribute start handle, if the type is ESP\_GATT\_DB\_DESCRIPTOR, this parameter should be ignore



- **end\_handle** -- **[in]** the attribute end handle, if the type is ESP\_GATT\_DB\_DESCRIPTOR, this parameter should be ignore
- **char\_handle** -- **[in]** the characteristic handle, this parameter valid when the type is ESP\_GATT\_DB\_DESCRIPTOR. If the type isn't ESP\_GATT\_DB\_DESCRIPTOR, this parameter should be ignore.
- **count** -- **[out]** output the number of attribute has been found in the gattc cache with the given attribute type.

**返回**

- ESP\_OK: success
- other: failed

*esp\_gatt\_status\_t* **esp\_ble\_gattc\_get\_db** (*esp\_gatt\_if\_t* gattc\_if, uint16\_t conn\_id, uint16\_t start\_handle, uint16\_t end\_handle, *esp\_gattc\_db\_elem\_t* \*db, uint16\_t \*count)

This function is called to get the GATT database. Note: It just get attribute data base from local cache, won't get from remote devices.

**参数**

- **gattc\_if** -- **[in]** Gatt client access interface.
- **start\_handle** -- **[in]** the attribute start handle
- **end\_handle** -- **[in]** the attribute end handle
- **conn\_id** -- **[in]** connection ID which identify the server.
- **db** -- **[in]** output parameter which will contain the GATT database copy. Caller is responsible for freeing it.
- **count** -- **[in]** number of elements in database.

**返回**

- ESP\_OK: success
- other: failed

*esp\_err\_t* **esp\_ble\_gattc\_read\_char** (*esp\_gatt\_if\_t* gattc\_if, uint16\_t conn\_id, uint16\_t handle, *esp\_gatt\_auth\_req\_t* auth\_req)

This function is called to read a service's characteristics of the given characteristic handle.

**参数**

- **gattc\_if** -- **[in]** Gatt client access interface.
- **conn\_id** -- **[in]** : connection ID.
- **handle** -- **[in]** : characteristic handle to read.
- **auth\_req** -- **[in]** : authenticate request type

**返回**

- ESP\_OK: success
- other: failed

*esp\_err\_t* **esp\_ble\_gattc\_read\_by\_type** (*esp\_gatt\_if\_t* gattc\_if, uint16\_t conn\_id, uint16\_t start\_handle, uint16\_t end\_handle, *esp\_bt\_uuid\_t* \*uuid, *esp\_gatt\_auth\_req\_t* auth\_req)

This function is called to read a service's characteristics of the given characteristic UUID.

**参数**

- **gattc\_if** -- **[in]** Gatt client access interface.
- **conn\_id** -- **[in]** : connection ID.
- **start\_handle** -- **[in]** : the attribute start handle.
- **end\_handle** -- **[in]** : the attribute end handle
- **uuid** -- **[in]** : The UUID of attribute which will be read.
- **auth\_req** -- **[in]** : authenticate request type

**返回**

- ESP\_OK: success
- other: failed

*esp\_err\_t* **esp\_ble\_gattc\_read\_multiple** (*esp\_gatt\_if\_t* gattc\_if, uint16\_t conn\_id, *esp\_gattc\_multi\_t* \*read\_multi, *esp\_gatt\_auth\_req\_t* auth\_req)

This function is called to read multiple characteristic or characteristic descriptors.

**参数**

- **gattc\_if** -- **[in]** Gatt client access interface.
- **conn\_id** -- **[in]** : connection ID.
- **read\_multi** -- **[in]** : pointer to the read multiple parameter.
- **auth\_req** -- **[in]** : authenticate request type

**返回**

- ESP\_OK: success
- other: failed

*esp\_err\_t* **esp\_ble\_gattc\_read\_multiple\_variable** (*esp\_gatt\_if\_t* gattc\_if, uint16\_t conn\_id, *esp\_gatt\_multi\_t* \*read\_multi, *esp\_gatt\_auth\_req\_t* auth\_req)

This function is called to read multiple variable length characteristic or characteristic descriptors.

**参数**

- **gattc\_if** -- **[in]** Gatt client access interface.
- **conn\_id** -- **[in]** : connection ID.
- **read\_multi** -- **[in]** : pointer to the read multiple parameter.
- **auth\_req** -- **[in]** : authenticate request type

**返回**

- ESP\_OK: success
- other: failed

*esp\_err\_t* **esp\_ble\_gattc\_read\_char\_descr** (*esp\_gatt\_if\_t* gattc\_if, uint16\_t conn\_id, uint16\_t handle, *esp\_gatt\_auth\_req\_t* auth\_req)

This function is called to read a characteristics descriptor.

**参数**

- **gattc\_if** -- **[in]** Gatt client access interface.
- **conn\_id** -- **[in]** : connection ID.
- **handle** -- **[in]** : descriptor handle to read.
- **auth\_req** -- **[in]** : authenticate request type

**返回**

- ESP\_OK: success
- other: failed

*esp\_err\_t* **esp\_ble\_gattc\_write\_char** (*esp\_gatt\_if\_t* gattc\_if, uint16\_t conn\_id, uint16\_t handle, uint16\_t value\_len, uint8\_t \*value, *esp\_gatt\_write\_type\_t* write\_type, *esp\_gatt\_auth\_req\_t* auth\_req)

This function is called to write characteristic value.

**参数**

- **gattc\_if** -- **[in]** Gatt client access interface.
- **conn\_id** -- **[in]** : connection ID.
- **handle** -- **[in]** : characteristic handle to write.
- **value\_len** -- **[in]** length of the value to be written.
- **value** -- **[in]** : the value to be written.
- **write\_type** -- **[in]** : the type of attribute write operation.
- **auth\_req** -- **[in]** : authentication request.

**返回**

- ESP\_OK: success
- other: failed

*esp\_err\_t* **esp\_ble\_gattc\_write\_char\_descr** (*esp\_gatt\_if\_t* gattc\_if, uint16\_t conn\_id, uint16\_t handle, uint16\_t value\_len, uint8\_t \*value, *esp\_gatt\_write\_type\_t* write\_type, *esp\_gatt\_auth\_req\_t* auth\_req)

This function is called to write characteristic descriptor value.

**参数**

- **gattc\_if** -- **[in]** Gatt client access interface.
- **conn\_id** -- **[in]** : connection ID

- **handle** -- **[in]** : descriptor handle to write.
- **value\_len** -- **[in]** length of the value to be written.
- **value** -- **[in]** : the value to be written.
- **write\_type** -- **[in]** : the type of attribute write operation.
- **auth\_req** -- **[in]** : authentication request.

**返回**

- ESP\_OK: success
- other: failed

*esp\_err\_t* **esp\_ble\_gattc\_prepare\_write** (*esp\_gatt\_if\_t* gattc\_if, uint16\_t conn\_id, uint16\_t handle, uint16\_t offset, uint16\_t value\_len, uint8\_t \*value, *esp\_gatt\_auth\_req\_t* auth\_req)

This function is called to prepare write a characteristic value.

**参数**

- **gattc\_if** -- **[in]** Gatt client access interface.
- **conn\_id** -- **[in]** : connection ID.
- **handle** -- **[in]** : characteristic handle to prepare write.
- **offset** -- **[in]** : offset of the write value.
- **value\_len** -- **[in]** length of the value to be written.
- **value** -- **[in]** : the value to be written.
- **auth\_req** -- **[in]** : authentication request.

**返回**

- ESP\_OK: success
- other: failed

*esp\_err\_t* **esp\_ble\_gattc\_prepare\_write\_char\_descr** (*esp\_gatt\_if\_t* gattc\_if, uint16\_t conn\_id, uint16\_t handle, uint16\_t offset, uint16\_t value\_len, uint8\_t \*value, *esp\_gatt\_auth\_req\_t* auth\_req)

This function is called to prepare write a characteristic descriptor value.

**参数**

- **gattc\_if** -- **[in]** Gatt client access interface.
- **conn\_id** -- **[in]** : connection ID.
- **handle** -- **[in]** : characteristic descriptor handle to prepare write.
- **offset** -- **[in]** : offset of the write value.
- **value\_len** -- **[in]** length of the value to be written.
- **value** -- **[in]** : the value to be written.
- **auth\_req** -- **[in]** : authentication request.

**返回**

- ESP\_OK: success
- other: failed

*esp\_err\_t* **esp\_ble\_gattc\_execute\_write** (*esp\_gatt\_if\_t* gattc\_if, uint16\_t conn\_id, bool is\_execute)

This function is called to execute write a prepare write sequence.

**参数**

- **gattc\_if** -- **[in]** Gatt client access interface.
- **conn\_id** -- **[in]** : connection ID.
- **is\_execute** -- **[in]** : execute or cancel.

**返回**

- ESP\_OK: success
- other: failed

*esp\_err\_t* **esp\_ble\_gattc\_register\_for\_notify** (*esp\_gatt\_if\_t* gattc\_if, *esp\_bd\_addr\_t* server\_bda, uint16\_t handle)

This function is called to register for notification of a service.

**参数**

- **gattc\_if** -- **[in]** Gatt client access interface.

- **server\_bda** -- **[in]** : target GATT server.
- **handle** -- **[in]** : GATT characteristic handle.

**返回**

- ESP\_OK: registration succeeds
- other: failed

*esp\_err\_t* **esp\_ble\_gattc\_unregister\_for\_notify** (*esp\_gatt\_if\_t* gattc\_if, *esp\_bd\_addr\_t* server\_bda, uint16\_t handle)

This function is called to de-register for notification of a service.

**参数**

- **gattc\_if** -- **[in]** Gatt client access interface.
- **server\_bda** -- **[in]** : target GATT server.
- **handle** -- **[in]** : GATT characteristic handle.

**返回**

- ESP\_OK: unregister succeeds
- other: failed

*esp\_err\_t* **esp\_ble\_gattc\_cache\_refresh** (*esp\_bd\_addr\_t* remote\_bda)

Refresh the server cache store in the gattc stack of the remote device. If the device is connected, this API will restart the discovery of service information of the remote device.

**参数** **remote\_bda** -- **[in]** remote device BD address.

**返回**

- ESP\_OK: success
- other: failed

*esp\_err\_t* **esp\_ble\_gattc\_cache\_assoc** (*esp\_gatt\_if\_t* gattc\_if, *esp\_bd\_addr\_t* src\_addr, *esp\_bd\_addr\_t* assoc\_addr, bool is\_assoc)

Add or delete the associated address with the source address. Note: The role of this API is mainly when the client side has stored a server-side database, when it needs to connect another device, but the device's attribute database is the same as the server database stored on the client-side, calling this API can use the database that the device has stored used as the peer server database to reduce the attribute database search and discovery process and speed up the connection time. The associated address mains that device want to used the database has stored in the local cache. The source address mains that device want to share the database to the associated address device.

**参数**

- **gattc\_if** -- **[in]** Gatt client access interface.
- **src\_addr** -- **[in]** the source address which provide the attribute table.
- **assoc\_addr** -- **[in]** the associated device address which went to share the attribute table with the source address.
- **is\_assoc** -- **[in]** true add the associated device address, false remove the associated device address.

**返回**

- ESP\_OK: success
- other: failed

*esp\_err\_t* **esp\_ble\_gattc\_cache\_get\_addr\_list** (*esp\_gatt\_if\_t* gattc\_if)

Get the address list which has store the attribute table in the gattc cache. There will callback ESP\_GATTC\_GET\_ADDR\_LIST\_EVT event when get address list complete.

**参数** **gattc\_if** -- **[in]** Gatt client access interface.

**返回**

- ESP\_OK: success
- other: failed

*esp\_err\_t* **esp\_ble\_gattc\_cache\_clean** (*esp\_bd\_addr\_t* remote\_bda)

Clean the service cache of this device in the gattc stack,.

**参数** **remote\_bda** -- **[in]** remote device BD address.

**返回**

- ESP\_OK: success
- other: failed

## Unions

union **esp\_ble\_gattc\_cb\_param\_t**

*#include <esp\_gattc\_api.h>* Gatt client callback parameters union.

### Public Members

struct *esp\_ble\_gattc\_cb\_param\_t::gattc\_reg\_evt\_param* **reg**

Gatt client callback param of ESP\_GATTC\_REG\_EVT

struct *esp\_ble\_gattc\_cb\_param\_t::gattc\_open\_evt\_param* **open**

Gatt client callback param of ESP\_GATTC\_OPEN\_EVT

struct *esp\_ble\_gattc\_cb\_param\_t::gattc\_close\_evt\_param* **close**

Gatt client callback param of ESP\_GATTC\_CLOSE\_EVT

struct *esp\_ble\_gattc\_cb\_param\_t::gattc\_cfg\_mtu\_evt\_param* **cfg\_mtu**

Gatt client callback param of ESP\_GATTC\_CFG\_MTU\_EVT

struct *esp\_ble\_gattc\_cb\_param\_t::gattc\_search\_cmpl\_evt\_param* **search\_cmpl**

Gatt client callback param of ESP\_GATTC\_SEARCH\_CMPL\_EVT

struct *esp\_ble\_gattc\_cb\_param\_t::gattc\_search\_res\_evt\_param* **search\_res**

Gatt client callback param of ESP\_GATTC\_SEARCH\_RES\_EVT

struct *esp\_ble\_gattc\_cb\_param\_t::gattc\_read\_char\_evt\_param* **read**

Gatt client callback param of ESP\_GATTC\_READ\_CHAR\_EVT

struct *esp\_ble\_gattc\_cb\_param\_t::gattc\_write\_evt\_param* **write**

Gatt client callback param of ESP\_GATTC\_WRITE\_DESCR\_EVT

struct *esp\_ble\_gattc\_cb\_param\_t::gattc\_exec\_cmpl\_evt\_param* **exec\_cmpl**

Gatt client callback param of ESP\_GATTC\_EXEC\_EVT

struct *esp\_ble\_gattc\_cb\_param\_t::gattc\_notify\_evt\_param* **notify**

Gatt client callback param of ESP\_GATTC\_NOTIFY\_EVT

struct *esp\_ble\_gattc\_cb\_param\_t::gattc\_srvc\_chg\_evt\_param* **srvc\_chg**

Gatt client callback param of ESP\_GATTC\_SRVC\_CHG\_EVT

struct *esp\_ble\_gattc\_cb\_param\_t::gattc\_congest\_evt\_param* **congest**

Gatt client callback param of ESP\_GATTC\_CONGEST\_EVT

struct *esp\_ble\_gattc\_cb\_param\_t::gattc\_reg\_for\_notify\_evt\_param* **reg\_for\_notify**

Gatt client callback param of ESP\_GATTC\_REG\_FOR\_NOTIFY\_EVT

```
struct esp_ble_gattc_cb_param_t::gattc_unreg_for_notify_evt_param unreg_for_notify  
    Gatt client callback param of ESP_GATTC_UNREG_FOR_NOTIFY_EVT
```

```
struct esp_ble_gattc_cb_param_t::gattc_connect_evt_param connect  
    Gatt client callback param of ESP_GATTC_CONNECT_EVT
```

```
struct esp_ble_gattc_cb_param_t::gattc_disconnect_evt_param disconnect  
    Gatt client callback param of ESP_GATTC_DISCONNECT_EVT
```

```
struct esp_ble_gattc_cb_param_t::gattc_set_assoc_addr_cmp_evt_param set_assoc_cmp  
    Gatt client callback param of ESP_GATTC_SET_ASSOC_EVT
```

```
struct esp_ble_gattc_cb_param_t::gattc_get_addr_list_evt_param get_addr_list  
    Gatt client callback param of ESP_GATTC_GET_ADDR_LIST_EVT
```

```
struct esp_ble_gattc_cb_param_t::gattc_queue_full_evt_param queue_full  
    Gatt client callback param of ESP_GATTC_QUEUE_FULL_EVT
```

```
struct esp_ble_gattc_cb_param_t::gattc_dis_srvc_cmpl_evt_param dis_srvc_cmpl  
    Gatt client callback param of ESP_GATTC_DIS_SRVC_CMPL_EVT
```

```
struct gattc_cfg_mtu_evt_param  
    #include <esp_gattc_api.h> ESP_GATTC_CFG_MTU_EVT.
```

### Public Members

*esp\_gatt\_status\_t* **status**  
 Operation status

uint16\_t **conn\_id**  
 Connection id

uint16\_t **mtu**  
 MTU size

```
struct gattc_close_evt_param  
    #include <esp_gattc_api.h> ESP_GATTC_CLOSE_EVT.
```

### Public Members

*esp\_gatt\_status\_t* **status**  
 Operation status

uint16\_t **conn\_id**  
 Connection id

*esp\_bd\_addr\_t* **remote\_bda**

Remote bluetooth device address

*esp\_gatt\_conn\_reason\_t* **reason**

The reason of gatt connection close

struct **gattc\_congest\_evt\_param**

*#include <esp\_gattc\_api.h>* ESP\_GATTC\_CONGEST\_EVT.

### Public Members

uint16\_t **conn\_id**

Connection id

bool **congested**

Congested or not

struct **gattc\_connect\_evt\_param**

*#include <esp\_gattc\_api.h>* ESP\_GATTC\_CONNECT\_EVT.

### Public Members

uint16\_t **conn\_id**

Connection id

uint8\_t **link\_role**

Link role : master role = 0 ; slave role = 1

*esp\_bd\_addr\_t* **remote\_bda**

Remote bluetooth device address

*esp\_gatt\_conn\_params\_t* **conn\_params**

current connection parameters

*esp\_ble\_addr\_type\_t* **ble\_addr\_type**

Remote BLE device address type

uint16\_t **conn\_handle**

HCI connection handle

struct **gattc\_dis\_srvc\_cmpl\_evt\_param**

*#include <esp\_gattc\_api.h>* ESP\_GATTC\_DIS\_SRVC\_CMPL\_EVT.

### Public Members

*esp\_gatt\_status\_t* **status**

Operation status

uint16\_t **conn\_id**

Connection id

struct **gattc\_disconnect\_evt\_param**

*#include <esp\_gattc\_api.h>* ESP\_GATTC\_DISCONNECT\_EVT.

### Public Members

*esp\_gatt\_conn\_reason\_t* **reason**

disconnection reason

uint16\_t **conn\_id**

Connection id

*esp\_bd\_addr\_t* **remote\_bda**

Remote bluetooth device address

struct **gattc\_exec\_cmpl\_evt\_param**

*#include <esp\_gattc\_api.h>* ESP\_GATTC\_EXEC\_EVT.

### Public Members

*esp\_gatt\_status\_t* **status**

Operation status

uint16\_t **conn\_id**

Connection id

struct **gattc\_get\_addr\_list\_evt\_param**

*#include <esp\_gattc\_api.h>* ESP\_GATTC\_GET\_ADDR\_LIST\_EVT.

### Public Members

*esp\_gatt\_status\_t* **status**

Operation status

uint8\_t **num\_addr**

The number of address in the gattc cache address list

*esp\_bd\_addr\_t* \***addr\_list**

The pointer to the address list which has been get from the gattc cache

struct **gattc\_notify\_evt\_param**

*#include <esp\_gattc\_api.h>* ESP\_GATTC\_NOTIFY\_EVT.



**Public Members**

uint16\_t **conn\_id**

Connection id

*esp\_bd\_addr\_t* **remote\_bda**

Remote bluetooth device address

uint16\_t **handle**

The Characteristic or descriptor handle

uint16\_t **value\_len**

Notify attribute value

uint8\_t \***value**

Notify attribute value

bool **is\_notify**

True means notify, false means indicate

struct **gattc\_open\_evt\_param**

*#include <esp\_gattc\_api.h>* ESP\_GATTC\_OPEN\_EVT.

**Public Members**

*esp\_gatt\_status\_t* **status**

Operation status

uint16\_t **conn\_id**

Connection id

*esp\_bd\_addr\_t* **remote\_bda**

Remote bluetooth device address

uint16\_t **mtu**

MTU size

struct **gattc\_queue\_full\_evt\_param**

*#include <esp\_gattc\_api.h>* ESP\_GATTC\_QUEUE\_FULL\_EVT.

**Public Members**

*esp\_gatt\_status\_t* **status**

Operation status

uint16\_t **conn\_id**

Connection id

bool **is\_full**

The gattc command queue is full or not

struct **gattc\_read\_char\_evt\_param**

*#include <esp\_gattc\_api.h>* ESP\_GATTC\_READ\_CHAR\_EVT, ESP\_GATTC\_READ\_DESCR\_EVT,  
ESP\_GATTC\_READ\_MULTIPLE\_EVT, ESP\_GATTC\_READ\_MULTI\_VAR\_EVT.

### Public Members

*esp\_gatt\_status\_t* **status**

Operation status

uint16\_t **conn\_id**

Connection id

uint16\_t **handle**

Characteristic handle

uint8\_t \***value**

Characteristic value

uint16\_t **value\_len**

Characteristic value length

struct **gattc\_reg\_evt\_param**

*#include <esp\_gattc\_api.h>* ESP\_GATTC\_REG\_EVT.

### Public Members

*esp\_gatt\_status\_t* **status**

Operation status

uint16\_t **app\_id**

Application id which input in register API

struct **gattc\_reg\_for\_notify\_evt\_param**

*#include <esp\_gattc\_api.h>* ESP\_GATTC\_REG\_FOR\_NOTIFY\_EVT.

### Public Members

*esp\_gatt\_status\_t* **status**

Operation status

uint16\_t **handle**

The characteristic or descriptor handle

struct **gattc\_search\_cmpl\_evt\_param**

*#include <esp\_gattc\_api.h>* ESP\_GATTC\_SEARCH\_CMPL\_EVT.

### Public Members

*esp\_gatt\_status\_t* **status**

Operation status

uint16\_t **conn\_id**

Connection id

*esp\_service\_source\_t* **searched\_service\_source**

The source of the service information

struct **gattc\_search\_res\_evt\_param**

*#include <esp\_gattc\_api.h>* ESP\_GATTC\_SEARCH\_RES\_EVT.

### Public Members

uint16\_t **conn\_id**

Connection id

uint16\_t **start\_handle**

Service start handle

uint16\_t **end\_handle**

Service end handle

*esp\_gatt\_id\_t* **srvc\_id**

Service id, include service uuid and other information

bool **is\_primary**

True if this is the primary service

struct **gattc\_set\_assoc\_addr\_cmp\_evt\_param**

*#include <esp\_gattc\_api.h>* ESP\_GATTC\_SET\_ASSOC\_EVT.

### Public Members

*esp\_gatt\_status\_t* **status**

Operation status

struct **gattc\_srvc\_chg\_evt\_param**

*#include <esp\_gattc\_api.h>* ESP\_GATTC\_SRVC\_CHG\_EVT.

### Public Members

*esp\_bd\_addr\_t* **remote\_bda**

Remote bluetooth device address

```
struct gattc_unreg_for_notify_evt_param  
    #include <esp_gattc_api.h> ESP_GATTC_UNREG_FOR_NOTIFY_EVT.
```

### Public Members

*esp\_gatt\_status\_t* **status**

Operation status

uint16\_t **handle**

The characteristic or descriptor handle

```
struct gattc_write_evt_param
```

```
    #include <esp_gattc_api.h> ESP_GATTC_WRITE_CHAR_EVT, ESP_GATTC_PREP_WRITE_EVT,  
    ESP_GATTC_WRITE_DESCR_EVT.
```

### Public Members

*esp\_gatt\_status\_t* **status**

Operation status

uint16\_t **conn\_id**

Connection id

uint16\_t **handle**

The Characteristic or descriptor handle

uint16\_t **offset**

The prepare write offset, this value is valid only when prepare write

### Type Definitions

```
typedef void (*esp_gattc_cb_t)(esp_gattc_cb_event_t event, esp_gatt_if_t gattc_if, esp_ble_gattc_cb_param_t  
*param)
```

GATT Client callback function type.

**Param event** : Event type

**Param gattc\_if** : GATT client access interface, normally different gattc\_if correspond to different profile

**Param param** : Point to callback parameter, currently is union type

### Enumerations

```
enum esp_gattc_cb_event_t
```

GATT Client callback function events.

*Values:*

enumerator **ESP\_GATTC\_REG\_EVT**

When GATT client is registered, the event comes

enumerator **ESP\_GATTC\_UNREG\_EVT**

When GATT client is unregistered, the event comes

enumerator **ESP\_GATTC\_OPEN\_EVT**

When GATT virtual connection is set up, the event comes

enumerator **ESP\_GATTC\_READ\_CHAR\_EVT**

When GATT characteristic is read, the event comes

enumerator **ESP\_GATTC\_WRITE\_CHAR\_EVT**

When GATT characteristic write operation completes, the event comes

enumerator **ESP\_GATTC\_CLOSE\_EVT**

When GATT virtual connection is closed, the event comes

enumerator **ESP\_GATTC\_SEARCH\_CMPL\_EVT**

When GATT service discovery is completed, the event comes

enumerator **ESP\_GATTC\_SEARCH\_RES\_EVT**

When GATT service discovery result is got, the event comes

enumerator **ESP\_GATTC\_READ\_DESCR\_EVT**

When GATT characteristic descriptor read completes, the event comes

enumerator **ESP\_GATTC\_WRITE\_DESCR\_EVT**

When GATT characteristic descriptor write completes, the event comes

enumerator **ESP\_GATTC\_NOTIFY\_EVT**

When GATT notification or indication arrives, the event comes

enumerator **ESP\_GATTC\_PREP\_WRITE\_EVT**

When GATT prepare-write operation completes, the event comes

enumerator **ESP\_GATTC\_EXEC\_EVT**

When write execution completes, the event comes

enumerator **ESP\_GATTC\_ACL\_EVT**

When ACL connection is up, the event comes

enumerator **ESP\_GATTC\_CANCEL\_OPEN\_EVT**

When GATT client ongoing connection is cancelled, the event comes

enumerator **ESP\_GATTC\_SRVC\_CHG\_EVT**

When "service changed" occurs, the event comes

enumerator **ESP\_GATTC\_ENC\_CMPL\_CB\_EVT**

When encryption procedure completes, the event comes

enumerator **ESP\_GATTC\_CFG\_MTU\_EVT**

When configuration of MTU completes, the event comes

enumerator **ESP\_GATTC\_ADV\_DATA\_EVT**

When advertising of data, the event comes

enumerator **ESP\_GATTC\_MULT\_ADV\_ENB\_EVT**

When multi-advertising is enabled, the event comes

enumerator **ESP\_GATTC\_MULT\_ADV\_UPD\_EVT**

When multi-advertising parameters are updated, the event comes

enumerator **ESP\_GATTC\_MULT\_ADV\_DATA\_EVT**

When multi-advertising data arrives, the event comes

enumerator **ESP\_GATTC\_MULT\_ADV\_DIS\_EVT**

When multi-advertising is disabled, the event comes

enumerator **ESP\_GATTC\_CONGEST\_EVT**

When GATT connection congestion comes, the event comes

enumerator **ESP\_GATTC\_BTH\_SCAN\_ENB\_EVT**

When batch scan is enabled, the event comes

enumerator **ESP\_GATTC\_BTH\_SCAN\_CFG\_EVT**

When batch scan storage is configured, the event comes

enumerator **ESP\_GATTC\_BTH\_SCAN\_RD\_EVT**

When Batch scan read event is reported, the event comes

enumerator **ESP\_GATTC\_BTH\_SCAN\_THR\_EVT**

When Batch scan threshold is set, the event comes

enumerator **ESP\_GATTC\_BTH\_SCAN\_PARAM\_EVT**

When Batch scan parameters are set, the event comes

enumerator **ESP\_GATTC\_BTH\_SCAN\_DIS\_EVT**

When Batch scan is disabled, the event comes

enumerator **ESP\_GATTC\_SCAN\_FLT\_CFG\_EVT**

When Scan filter configuration completes, the event comes

enumerator **ESP\_GATTC\_SCAN\_FLT\_PARAM\_EVT**

When Scan filter parameters are set, the event comes

enumerator **ESP\_GATTC\_SCAN\_FLT\_STATUS\_EVT**

When Scan filter status is reported, the event comes

enumerator **ESP\_GATTC\_ADV\_VSC\_EVT**

When advertising vendor spec content event is reported, the event comes

enumerator **ESP\_GATTC\_REG\_FOR\_NOTIFY\_EVT**

When register for notification of a service completes, the event comes

enumerator **ESP\_GATTC\_UNREG\_FOR\_NOTIFY\_EVT**

When unregister for notification of a service completes, the event comes

enumerator **ESP\_GATTC\_CONNECT\_EVT**

When the ble physical connection is set up, the event comes

enumerator **ESP\_GATTC\_DISCONNECT\_EVT**

When the ble physical connection disconnected, the event comes

enumerator **ESP\_GATTC\_READ\_MULTIPLE\_EVT**

When the ble characteristic or descriptor multiple complete, the event comes

enumerator **ESP\_GATTC\_QUEUE\_FULL\_EVT**

When the gattc command queue full, the event comes

enumerator **ESP\_GATTC\_SET\_ASSOC\_EVT**

When the ble gattc set the associated address complete, the event comes

enumerator **ESP\_GATTC\_GET\_ADDR\_LIST\_EVT**

When the ble get gattc address list in cache finish, the event comes

enumerator **ESP\_GATTC\_DIS\_SRVC\_CMPL\_EVT**

When the ble discover service complete, the event comes

enumerator **ESP\_GATTC\_READ\_MULTI\_VAR\_EVT**

When read multiple variable characteristic complete, the event comes

### 2.3.3 Controller && VHCI

#### Application Example

Check [bluetooth/hci](#) folder in ESP-IDF examples, which contains the following application:

- This is a Bluetooth® Low Energy (Bluetooth LE) advertising demo with virtual HCI interface. Send Reset/ADV\_PARAM/ADV\_DATA/ADV\_ENABLE HCI command for Bluetooth Low Energy advertising - [bluetooth/hci/controller\\_vhci\\_ble\\_adv](#).

#### API Reference

##### Header File

- [components/bt/include/esp32h2/include/esp\\_bt.h](#)
- This header file can be included with:

```
#include "esp_bt.h"
```

- This header file is a part of the API provided by the `bt` component. To declare that your component depends on `bt`, add the following to your `CMakeLists.txt`:

```
REQUIRES bt
```

or

```
PRIV_REQUIRES bt
```

## Functions

*esp\_err\_t* **esp\_ble\_tx\_power\_set** (*esp\_ble\_power\_type\_t* power\_type, *esp\_power\_level\_t* power\_level)

Set BLE TX power Connection Tx power should only be set after connection created.

### 参数

- **power\_type** -- : The type of which tx power, could set Advertising/Connection/Default and etc
- **power\_level** -- Power level(index) corresponding to absolute value(dbm)

返回 ESP\_OK - success, other - failed

*esp\_power\_level\_t* **esp\_ble\_tx\_power\_get** (*esp\_ble\_power\_type\_t* power\_type)

Get BLE TX power Connection Tx power should only be get after connection created.

参数 **power\_type** -- : The type of which tx power, could set Advertising/Connection/Default and etc

返回  $\geq 0$  - Power level,  $< 0$  - Invalid

*esp\_err\_t* **esp\_ble\_tx\_power\_set\_enhanced** (*esp\_ble\_enhanced\_power\_type\_t* power\_type, uint16\_t handle, *esp\_power\_level\_t* power\_level)

ENHANCED API for Setting BLE TX power Connection Tx power should only be set after connection created.

### 参数

- **power\_type** -- : The enhanced type of which tx power, could set Advertising/Connection/Default and etc
- **handle** -- : The handle of Advertising or Connection and the value 0 for other enhanced power types.
- **power\_level** -- Power level(index) corresponding to absolute value(dbm)

返回 ESP\_OK - success, other - failed

*esp\_power\_level\_t* **esp\_ble\_tx\_power\_get\_enhanced** (*esp\_ble\_enhanced\_power\_type\_t* power\_type, uint16\_t handle)

ENHANCED API of Getting BLE TX power Connection Tx power should only be get after connection created.

### 参数

- **power\_type** -- : The enhanced type of which tx power, could set Advertising/Connection/Default and etc
- **handle** -- : The handle of Advertising or Connection and the value 0 for other enhanced power types.

返回  $\geq 0$  - Power level,  $< 0$  - Invalid

*esp\_err\_t* **esp\_bt\_controller\_init** (*esp\_bt\_controller\_config\_t* \*cfg)

Initialize BT controller to allocate task and other resource. This function should be called only once, before any other BT functions are called.

参数 **cfg** -- Initial configuration of BT controller.

返回 ESP\_OK - success, other - failed

*esp\_bt\_controller\_status\_t* **esp\_bt\_controller\_get\_status** (void)

Get BT controller is initialised/de-initialised/enabled/disabled.

返回 status value



**esp\_err\_t esp\_bt\_controller\_deinit** (void)

De-initialize BT controller to free resource and delete task. You should stop advertising and scanning, as well as disconnect all existing connections before de-initializing BT controller.

This function should be called only once, after any other BT functions are called. This function is not whole completed, esp\_bt\_controller\_init cannot called after this function.

返回 ESP\_OK - success, other - failed

**esp\_err\_t esp\_bt\_controller\_enable** (esp\_bt\_mode\_t mode)

Enable BT controller. Due to a known issue, you cannot call esp\_bt\_controller\_enable() a second time to change the controller mode dynamically. To change controller mode, call esp\_bt\_controller\_disable() and then call esp\_bt\_controller\_enable() with the new mode.

参数 **mode** -- : the mode(BLE/BT/BTDM) to enable. For compatible of API, retain this argument.

返回 ESP\_OK - success, other - failed

**esp\_err\_t esp\_bt\_controller\_disable** (void)

Disable BT controller.

返回 ESP\_OK - success, other - failed

**bool esp\_vhci\_host\_check\_send\_available** (void)

esp\_vhci\_host\_check\_send\_available used for check actively if the host can send packet to controller or not.

返回 true for ready to send, false means cannot send packet

**void esp\_vhci\_host\_send\_packet** (uint8\_t \*data, uint16\_t len)

esp\_vhci\_host\_send\_packet host send packet to controller

Should not call this function from within a critical section or when the scheduler is suspended.

参数

- **data** -- the packet point
- **len** -- the packet length

**esp\_err\_t esp\_vhci\_host\_register\_callback** (const esp\_vhci\_host\_callback\_t \*callback)

esp\_vhci\_host\_register\_callback register the vhc reference callback struct defined by vhc\_host\_callback structure.

参数 **callback** -- esp\_vhci\_host\_callback type variable

返回 ESP\_OK - success, ESP\_FAIL - failed

**esp\_err\_t esp\_bt\_controller\_mem\_release** (esp\_bt\_mode\_t mode)

esp\_bt\_controller\_mem\_release release the controller memory as per the mode

This function releases the BSS, data and other sections of the controller to heap. The total size is about 70k bytes.

esp\_bt\_controller\_mem\_release(mode) should be called only before esp\_bt\_controller\_init() or after esp\_bt\_controller\_deinit().

Note that once BT controller memory is released, the process cannot be reversed. It means you cannot use the bluetooth mode which you have released by this function.

If your firmware will later upgrade the Bluetooth controller mode (BLE -> BT Classic or disabled -> enabled) then do not call this function.

If the app calls esp\_bt\_controller\_enable(ESP\_BT\_MODE\_BLE) to use BLE only then it is safe to call esp\_bt\_controller\_mem\_release(ESP\_BT\_MODE\_CLASSIC\_BT) at initialization time to free unused BT Classic memory.

If the mode is ESP\_BT\_MODE\_BTDM, then it may be useful to call API esp\_bt\_mem\_release(ESP\_BT\_MODE\_BTDM) instead, which internally calls esp\_bt\_controller\_mem\_release(ESP\_BT\_MODE\_BTDM) and additionally releases the BSS and data

consumed by the BT/BLE host stack to heap. For more details about usage please refer to the documentation of `esp_bt_mem_release()` function

**参数 mode** -- : the mode want to release memory

**返回** ESP\_OK - success, other - failed

*esp\_err\_t* **esp\_bt\_mem\_release** (*esp\_bt\_mode\_t* mode)

`esp_bt_mem_release` release controller memory and BSS and data section of the BT/BLE host stack as per the mode

This function first releases controller memory by internally calling `esp_bt_controller_mem_release()`. Additionally, if the mode is set to `ESP_BT_MODE_BTDM`, it also releases the BSS and data consumed by the BT/BLE host stack to heap

Note that once BT memory is released, the process cannot be reversed. It means you cannot use the bluetooth mode which you have released by this function.

If your firmware will later upgrade the Bluetooth controller mode (BLE -> BT Classic or disabled -> enabled) then do not call this function.

If you never intend to use bluetooth in a current boot-up cycle, you can call `esp_bt_mem_release(ESP_BT_MODE_BTDM)` before `esp_bt_controller_init` or after `esp_bt_controller_deinit`.

For example, if a user only uses bluetooth for setting the WiFi configuration, and does not use bluetooth in the rest of the product operation". In such cases, after receiving the WiFi configuration, you can disable/deinit bluetooth and release its memory. Below is the sequence of APIs to be called for such scenarios:

```
esp_bluedroid_disable();
esp_bluedroid_deinit();
esp_bt_controller_disable();
esp_bt_controller_deinit();
esp_bt_mem_release(ESP_BT_MODE_BTDM);
```

**参数 mode** -- : the mode whose memory is to be released

**返回** ESP\_OK - success, other - failed

int **esp\_ble\_hw\_get\_static\_addr** (*esp\_ble\_addr\_t* \*addr)

Returns random static address or -1 if not present.

**返回** ESP\_OK - success, other - failed

## Structures

struct **esp\_ble\_addr\_t**

Address type and address value.

## Public Members

uint8\_t **type**

Type of the Bluetooth address (public, random, etc.)

uint8\_t **val**[6]

Array containing the 6-byte Bluetooth address value

struct **esp\_bt\_controller\_config\_t**

Controller config options, depend on config mask. Config mask indicate which functions enabled, this means some options or parameters of some functions enabled by config mask.

**Public Members****uint32\_t config\_version**

Version number of the defined structure

**uint16\_t ble\_11\_resolv\_list\_size**

Size of the resolvable private address list

**uint16\_t ble\_hci\_evt\_hi\_buf\_count**

Count of high buffers for HCI events

**uint16\_t ble\_hci\_evt\_lo\_buf\_count**

Count of low buffers for HCI events

**uint8\_t ble\_11\_sync\_list\_cnt**

Number of synchronization lists

**uint8\_t ble\_11\_sync\_cnt**

Number of synchronizations

**uint16\_t ble\_11\_rsp\_dup\_list\_count**

Count of duplicated lists for scan response packets

**uint16\_t ble\_11\_adv\_dup\_list\_count**

Count of duplicated lists for advertising packets

**uint8\_t ble\_11\_tx\_pwr\_dbm**

Tx power (transmit power) in dBm

**uint64\_t rtc\_freq**

Frequency of RTC (Real-Time Clock)

**uint16\_t ble\_11\_sca**

Sleep Clock Accuracy (SCA) parameter

**uint8\_t ble\_11\_scan\_phy\_number**

Number of PHYs supported for scanning

**uint16\_t ble\_11\_conn\_def\_auth\_pyld\_tmo**

Connection default authentication payload timeout

**uint8\_t ble\_11\_jitter\_usecs**

Jitter time in microseconds

**uint16\_t ble\_11\_sched\_max\_adv\_pdu\_usecs**

Maximum time in microseconds for advertising PDU scheduling

**uint16\_t ble\_11\_sched\_direct\_adv\_max\_usecs**

Maximum time in microseconds for directed advertising scheduling

<code>uint16_t ble_ll_sched_adv_max_usecs</code>	Maximum time in microseconds for advertising scheduling
<code>uint16_t ble_scan_rsp_data_max_len</code>	Maximum length of scan response data
<code>uint8_t ble_ll_cfg_num_hci_cmd_pkts</code>	Number of HCI command packets that can be queued
<code>uint32_t ble_ll_ctrl_proc_timeout_ms</code>	Control processing timeout in milliseconds
<code>uint16_t nimble_max_connections</code>	Maximum number of connections supported
<code>uint8_t ble_whitelist_size</code>	Size of the white list
<code>uint16_t ble_acl_buf_size</code>	Buffer size of ACL (Asynchronous Connection-Less) data
<code>uint16_t ble_acl_buf_count</code>	Buffer count of ACL data
<code>uint16_t ble_hci_evt_buf_size</code>	Buffer size for HCI event data
<code>uint16_t ble_multi_adv_instances</code>	Number of advertising instances
<code>uint16_t ble_ext_adv_max_size</code>	Maximum size of extended advertising data
<code>uint16_t controller_task_stack_size</code>	Size of Bluetooth controller task stack
<code>uint8_t controller_task_prio</code>	Priority of the Bluetooth task
<code>uint8_t controller_run_cpu</code>	CPU number on which the Bluetooth controller task runs
<code>uint8_t enable_qa_test</code>	Enable for QA test
<code>uint8_t enable_bqb_test</code>	Enable for BQB test

uint8\_t **enable\_tx\_cca**

Enable Clear Channel Assessment (CCA) when transmitting

uint8\_t **cca\_rssi\_thresh**

RSSI threshold for CCA

uint8\_t **sleep\_en**

Enable sleep functionality

uint8\_t **coex\_phy\_coded\_tx\_rx\_time\_limit**

Coexistence PHY coded TX and RX time limit

uint8\_t **dis\_scan\_backoff**

Disable scan backoff

uint8\_t **ble\_scan\_classify\_filter\_enable**

Enable classification filter for BLE scan

uint8\_t **cca\_drop\_mode**

CCA drop mode

int8\_t **cca\_low\_tx\_pwr**

Low TX power setting for CCA

uint8\_t **main\_xtal\_freq**

Main crystal frequency

uint8\_t **cpu\_freq\_mhz**

CPU frequency in megahertz

uint8\_t **ignore\_wl\_for\_direct\_adv**

Ignore the white list for directed advertising

uint8\_t **enable\_pcl**

Enable power control

uint8\_t **csa2\_select**

Select CSA#2

uint32\_t **config\_magic**

Configuration magic value

struct **esp\_vhci\_host\_callback**

*esp\_vhci\_host\_callback* used for vhci call host function to notify what host need to do

### Public Members

void (**\*notify\_host\_send\_available**)(void)  
callback used to notify that the host can send packet to controller

int (**\*notify\_host\_recv**)(uint8\_t \*data, uint16\_t len)  
callback used to notify that the controller has a packet to send to the host

## Macros

**CONFIG\_VERSION**

**CONFIG\_MAGIC**

**BT\_CONTROLLER\_INIT\_CONFIG\_DEFAULT** ()

## Type Definitions

typedef struct *esp\_vhci\_host\_callback* **esp\_vhci\_host\_callback\_t**  
*esp\_vhci\_host\_callback* used for vhci call host function to notify what host need to do

## Enumerations

enum **esp\_bt\_mode\_t**  
Bluetooth mode for controller enable/disable.

*Values:*

enumerator **ESP\_BT\_MODE\_IDLE**  
Bluetooth is not running

enumerator **ESP\_BT\_MODE\_BLE**  
Run BLE mode

enumerator **ESP\_BT\_MODE\_CLASSIC\_BT**  
Run Classic BT mode

enumerator **ESP\_BT\_MODE\_BTDM**  
Run dual mode

enum **esp\_bt\_controller\_status\_t**  
Bluetooth controller enable/disable/initialised/de-initialised status.

*Values:*

enumerator **ESP\_BT\_CONTROLLER\_STATUS\_IDLE**  
Controller is in idle state

enumerator **ESP\_BT\_CONTROLLER\_STATUS\_INITED**  
Controller is in initialising state

enumerator **ESP\_BT\_CONTROLLER\_STATUS\_ENABLED**  
Controller is in enabled state

enumerator **ESP\_BT\_CONTROLLER\_STATUS\_NUM**

Controller is in disabled state

enum **esp\_ble\_power\_type\_t**

BLE tx power type ESP\_BLE\_PWR\_TYPE\_CONN\_HDL0-8: for each connection, and only be set after connection completed. when disconnect, the correspond TX power is not effected. ESP\_BLE\_PWR\_TYPE\_ADV : for advertising/scan response. ESP\_BLE\_PWR\_TYPE\_SCAN : for scan. ESP\_BLE\_PWR\_TYPE\_DEFAULT : if each connection's TX power is not set, it will use this default value. if neither in scan mode nor in adv mode, it will use this default value. If none of power type is set, system will use ESP\_PWR\_LVL\_P3 as default for ADV/SCAN/CONN0-9.

*Values:*

enumerator **ESP\_BLE\_PWR\_TYPE\_CONN\_HDL0**

For connection handle 0

enumerator **ESP\_BLE\_PWR\_TYPE\_CONN\_HDL1**

For connection handle 1

enumerator **ESP\_BLE\_PWR\_TYPE\_CONN\_HDL2**

For connection handle 2

enumerator **ESP\_BLE\_PWR\_TYPE\_CONN\_HDL3**

For connection handle 3

enumerator **ESP\_BLE\_PWR\_TYPE\_CONN\_HDL4**

For connection handle 4

enumerator **ESP\_BLE\_PWR\_TYPE\_CONN\_HDL5**

For connection handle 5

enumerator **ESP\_BLE\_PWR\_TYPE\_CONN\_HDL6**

For connection handle 6

enumerator **ESP\_BLE\_PWR\_TYPE\_CONN\_HDL7**

For connection handle 7

enumerator **ESP\_BLE\_PWR\_TYPE\_CONN\_HDL8**

For connection handle 8

enumerator **ESP\_BLE\_PWR\_TYPE\_ADV**

For advertising

enumerator **ESP\_BLE\_PWR\_TYPE\_SCAN**

For scan

enumerator **ESP\_BLE\_PWR\_TYPE\_DEFAULT**

For default, if not set other, it will use default value

enumerator **ESP\_BLE\_PWR\_TYPE\_NUM**

TYPE numbers

enum **esp\_power\_level\_t**

Bluetooth TX power level(index), it's just a index corresponding to power(dbm).

*Values:*

enumerator **ESP\_PWR\_LVL\_N24**

Corresponding to -24dbm

enumerator **ESP\_PWR\_LVL\_N21**

Corresponding to -21dbm

enumerator **ESP\_PWR\_LVL\_N18**

Corresponding to -18dbm

enumerator **ESP\_PWR\_LVL\_N15**

Corresponding to -15dbm

enumerator **ESP\_PWR\_LVL\_N12**

Corresponding to -12dbm

enumerator **ESP\_PWR\_LVL\_N9**

Corresponding to -9dbm

enumerator **ESP\_PWR\_LVL\_N6**

Corresponding to -6dbm

enumerator **ESP\_PWR\_LVL\_N3**

Corresponding to -3dbm

enumerator **ESP\_PWR\_LVL\_N0**

Corresponding to 0dbm

enumerator **ESP\_PWR\_LVL\_P3**

Corresponding to +3dbm

enumerator **ESP\_PWR\_LVL\_P6**

Corresponding to +6dbm

enumerator **ESP\_PWR\_LVL\_P9**

Corresponding to +9dbm

enumerator **ESP\_PWR\_LVL\_P12**

Corresponding to +12dbm

enumerator **ESP\_PWR\_LVL\_P15**

Corresponding to +15dbm



enumerator **ESP\_PWR\_LVL\_P16**

Corresponding to +18dbm, this enum variable has been deprecated

enumerator **ESP\_PWR\_LVL\_P17**

Corresponding to +18dbm, this enum variable has been deprecated

enumerator **ESP\_PWR\_LVL\_P18**

Corresponding to +18dbm

enumerator **ESP\_PWR\_LVL\_P19**

Corresponding to +20dbm, this enum variable has been deprecated

enumerator **ESP\_PWR\_LVL\_P20**

Corresponding to +20dbm

enumerator **ESP\_PWR\_LVL\_INVALID**

Indicates an invalid value

enum **esp\_ble\_enhanced\_power\_type\_t**

The enhanced type of which tx power, could set Advertising/Connection/Default and etc.

*Values:*

enumerator **ESP\_BLE\_ENHANCED\_PWR\_TYPE\_DEFAULT**

enumerator **ESP\_BLE\_ENHANCED\_PWR\_TYPE\_ADV**

enumerator **ESP\_BLE\_ENHANCED\_PWR\_TYPE\_SCAN**

enumerator **ESP\_BLE\_ENHANCED\_PWR\_TYPE\_INIT**

enumerator **ESP\_BLE\_ENHANCED\_PWR\_TYPE\_CONN**

enumerator **ESP\_BLE\_ENHANCED\_PWR\_TYPE\_MAX**

enum **esp\_ble\_log\_buf\_t**

Select buffers.

*Values:*

enumerator **ESP\_BLE\_LOG\_BUF\_HCI**

enumerator **ESP\_BLE\_LOG\_BUF\_CONTROLLER**

### 2.3.4 ESP-BLE-MESH

---

**备注:** The current ESP-BLE-MESH v1.1 related code is a preview version, so the Mesh Protocol v1.1 related Structures, MACROS, and APIs involved in the code may be changed.

---

With various features of ESP-BLE-MESH, users can create a managed flooding mesh network for several scenarios, such as lighting, sensor and etc.

For an ESP32 to join and work on a ESP-BLE-MESH network, it must be provisioned firstly. By provisioning, the ESP32, as an unprovisioned device, will join the ESP-BLE-MESH network and become a ESP-BLE-MESH node, communicating with other nodes within or beyond the radio range.

Apart from ESP-BLE-MESH nodes, inside ESP-BLE-MESH network, there is also ESP32 that works as ESP-BLE-MESH provisioner, which could provision unprovisioned devices into ESP-BLE-MESH nodes and configure the nodes with various features.

For information how to start using ESP32 and ESP-BLE-MESH, please see the Section [ESP-BLE-MESH 快速入门](#). If you are interested in information on ESP-BLE-MESH architecture, including some details of software implementation, please see Section [ESP-BLE-MESH 架构](#).

## Application Examples and Demos

Please refer to Sections [ESP-BLE-MESH 示例](#) and [ESP-BLE-MESH 演示视频](#).

## API Reference

ESP-BLE-MESH APIs are divided into the following parts:

- [ESP-BLE-MESH Definitions](#)
- [ESP-BLE-MESH Core API Reference](#)
- [ESP-BLE-MESH Models API Reference](#)
- [ESP-BLE-MESH \(v1.1\) Core API Reference](#)

## ESP-BLE-MESH Definitions

This section contains only one header file, which lists the following items of ESP-BLE-MESH.

- ID of all the models and related message opcodes
- Structs of model, element and Composition Data
- Structs of used by ESP-BLE-MESH Node/Provisioner for provisioning
- Structs used to transmit/receive messages
- Event types and related event parameters

## Header File

- [components/bt/esp\\_ble\\_mesh/api/esp\\_ble\\_mesh\\_defs.h](#)
- This header file can be included with:

```
#include "esp_ble_mesh_defs.h"
```

- This header file is a part of the API provided by the `bt` component. To declare that your component depends on `bt`, add the following to your CMakeLists.txt:

```
REQUIRES bt
```

or

```
PRIV_REQUIRES bt
```

## Unions

union `esp_ble_mesh_prov_cb_param_t`

`#include <esp_ble_mesh_defs.h>` BLE Mesh Node/Provisioner callback parameters union.

**Public Members**

struct *esp\_ble\_mesh\_prov\_cb\_param\_t::ble\_mesh\_prov\_register\_comp\_param* **prov\_register\_comp**  
Event parameter of ESP\_BLE\_MESH\_PROV\_REGISTER\_COMP\_EVT

struct *esp\_ble\_mesh\_prov\_cb\_param\_t::ble\_mesh\_set\_unprov\_dev\_name\_comp\_param*  
**node\_set\_unprov\_dev\_name\_comp**  
Event parameter of ESP\_BLE\_MESH\_NODE\_SET\_UNPROV\_DEV\_NAME\_COMP\_EVT

struct *esp\_ble\_mesh\_prov\_cb\_param\_t::ble\_mesh\_prov\_enable\_comp\_param*  
**node\_prov\_enable\_comp**  
Event parameter of ESP\_BLE\_MESH\_NODE\_PROV\_ENABLE\_COMP\_EVT

struct *esp\_ble\_mesh\_prov\_cb\_param\_t::ble\_mesh\_prov\_disable\_comp\_param*  
**node\_prov\_disable\_comp**  
Event parameter of ESP\_BLE\_MESH\_NODE\_PROV\_DISABLE\_COMP\_EVT

struct *esp\_ble\_mesh\_prov\_cb\_param\_t::ble\_mesh\_link\_open\_evt\_param* **node\_prov\_link\_open**  
Event parameter of ESP\_BLE\_MESH\_NODE\_PROV\_LINK\_OPEN\_EVT

struct *esp\_ble\_mesh\_prov\_cb\_param\_t::ble\_mesh\_link\_close\_evt\_param* **node\_prov\_link\_close**  
Event parameter of ESP\_BLE\_MESH\_NODE\_PROV\_LINK\_CLOSE\_EVT

struct *esp\_ble\_mesh\_prov\_cb\_param\_t::ble\_mesh\_output\_num\_evt\_param* **node\_prov\_output\_num**  
Event parameter of ESP\_BLE\_MESH\_NODE\_PROV\_OUTPUT\_NUMBER\_EVT

struct *esp\_ble\_mesh\_prov\_cb\_param\_t::ble\_mesh\_output\_str\_evt\_param* **node\_prov\_output\_str**  
Event parameter of ESP\_BLE\_MESH\_NODE\_PROV\_OUTPUT\_STRING\_EVT

struct *esp\_ble\_mesh\_prov\_cb\_param\_t::ble\_mesh\_input\_evt\_param* **node\_prov\_input**  
Event parameter of ESP\_BLE\_MESH\_NODE\_PROV\_INPUT\_EVT

struct *esp\_ble\_mesh\_prov\_cb\_param\_t::ble\_mesh\_provision\_complete\_evt\_param* **node\_prov\_complete**  
Event parameter of ESP\_BLE\_MESH\_NODE\_PROV\_COMPLETE\_EVT

struct *esp\_ble\_mesh\_prov\_cb\_param\_t::ble\_mesh\_provision\_reset\_param* **node\_prov\_reset**  
Event parameter of ESP\_BLE\_MESH\_NODE\_PROV\_RESET\_EVT

struct *esp\_ble\_mesh\_prov\_cb\_param\_t::ble\_mesh\_set\_oob\_pub\_key\_comp\_param*  
**node\_prov\_set\_oob\_pub\_key\_comp**  
Event parameter of ESP\_BLE\_MESH\_NODE\_PROV\_SET\_OOB\_PUB\_KEY\_COMP\_EVT

struct *esp\_ble\_mesh\_prov\_cb\_param\_t::ble\_mesh\_input\_number\_comp\_param*  
**node\_prov\_input\_num\_comp**  
Event parameter of ESP\_BLE\_MESH\_NODE\_PROV\_INPUT\_NUM\_COMP\_EVT

struct *esp\_ble\_mesh\_prov\_cb\_param\_t::ble\_mesh\_input\_string\_comp\_param*  
**node\_prov\_input\_str\_comp**  
Event parameter of ESP\_BLE\_MESH\_NODE\_PROV\_INPUT\_STR\_COMP\_EVT

```
struct esp_ble_mesh_prov_cb_param_t::ble_mesh_proxy_identity_enable_comp_param
node_proxy_identity_enable_comp
```

Event parameter of ESP\_BLE\_MESH\_NODE\_PROXY\_IDENTITY\_ENABLE\_COMP\_EVT

```
struct esp_ble_mesh_prov_cb_param_t::ble_mesh_proxy_gatt_enable_comp_param
node_proxy_gatt_enable_comp
```

Event parameter of ESP\_BLE\_MESH\_NODE\_PROXY\_GATT\_ENABLE\_COMP\_EVT

```
struct esp_ble_mesh_prov_cb_param_t::ble_mesh_proxy_gatt_disable_comp_param
node_proxy_gatt_disable_comp
```

Event parameter of ESP\_BLE\_MESH\_NODE\_PROXY\_GATT\_DISABLE\_COMP\_EVT

```
struct esp_ble_mesh_prov_cb_param_t::ble_mesh_proxy_private_identity_enable_comp_param
node_private_proxy_identity_enable_comp
```

Event parameter of ESP\_BLE\_MESH\_NODE\_PRIVATE\_PROXY\_IDENTITY\_ENABLE\_COMP\_EVT

```
struct esp_ble_mesh_prov_cb_param_t::ble_mesh_proxy_private_identity_disable_comp_param
node_private_proxy_identity_disable_comp
```

Event parameter of ESP\_BLE\_MESH\_NODE\_PRIVATE\_PROXY\_IDENTITY\_DISABLE\_COMP\_EVT

```
struct esp_ble_mesh_prov_cb_param_t::ble_mesh_node_add_local_net_key_comp_param
node_add_net_key_comp
```

Event parameter of ESP\_BLE\_MESH\_NODE\_ADD\_LOCAL\_NET\_KEY\_COMP\_EVT

```
struct esp_ble_mesh_prov_cb_param_t::ble_mesh_node_add_local_app_key_comp_param
node_add_app_key_comp
```

Event parameter of ESP\_BLE\_MESH\_NODE\_ADD\_LOCAL\_APP\_KEY\_COMP\_EVT

```
struct esp_ble_mesh_prov_cb_param_t::ble_mesh_node_bind_local_mod_app_comp_param
node_bind_app_key_to_model_comp
```

Event parameter of ESP\_BLE\_MESH\_NODE\_BIND\_APP\_KEY\_TO\_MODEL\_COMP\_EVT

```
struct esp_ble_mesh_prov_cb_param_t::ble_mesh_provisioner_rcv_unprov_adv_pkt_param
provisioner_rcv_unprov_adv_pkt
```

Event parameter of ESP\_BLE\_MESH\_PROVISIONER\_RECV\_UNPROV\_ADV\_PKT\_EVT

```
struct esp_ble_mesh_prov_cb_param_t::ble_mesh_provisioner_prov_enable_comp_param
provisioner_prov_enable_comp
```

Event parameter of ESP\_BLE\_MESH\_PROVISIONER\_PROV\_ENABLE\_COMP\_EVT

```
struct esp_ble_mesh_prov_cb_param_t::ble_mesh_provisioner_prov_disable_comp_param
provisioner_prov_disable_comp
```

Event parameter of ESP\_BLE\_MESH\_PROVISIONER\_PROV\_DISABLE\_COMP\_EVT

```
struct esp_ble_mesh_prov_cb_param_t::ble_mesh_provisioner_link_open_evt_param
provisioner_prov_link_open
```

Event parameter of ESP\_BLE\_MESH\_PROVISIONER\_PROV\_LINK\_OPEN\_EVT

```
struct esp_ble_mesh_prov_cb_param_t::ble_mesh_provisioner_prov_read_oob_pub_key_evt_param
provisioner_prov_read_oob_pub_key
```

Event parameter of ESP\_BLE\_MESH\_PROVISIONER\_PROV\_READ\_OOB\_PUB\_KEY\_EVT

```
struct esp_ble_mesh_prov_cb_param_t::ble_mesh_provisioner_prov_input_evt_param  
provisioner_prov_input
```

Event parameter of ESP\_BLE\_MESH\_PROVISIONER\_PROV\_INPUT\_EVT

```
struct esp_ble_mesh_prov_cb_param_t::ble_mesh_provisioner_prov_output_evt_param  
provisioner_prov_output
```

Event parameter of ESP\_BLE\_MESH\_PROVISIONER\_PROV\_OUTPUT\_EVT

```
struct esp_ble_mesh_prov_cb_param_t::ble_mesh_provisioner_link_close_evt_param  
provisioner_prov_link_close
```

Event parameter of ESP\_BLE\_MESH\_PROVISIONER\_PROV\_LINK\_CLOSE\_EVT

```
struct esp_ble_mesh_prov_cb_param_t::ble_mesh_provisioner_prov_comp_param  
provisioner_prov_complete
```

Event parameter of ESP\_BLE\_MESH\_PROVISIONER\_PROV\_COMPLETE\_EVT

```
struct esp_ble_mesh_prov_cb_param_t::ble_mesh_provisioner_cert_based_prov_start_evt_param  
provisioner_cert_based_prov_start
```

Event parameter of ESP\_BLE\_MESH\_PROVISIONER\_CERT\_BASED\_PROV\_START\_EVT

```
struct esp_ble_mesh_prov_cb_param_t::ble_mesh_provisioner_rcv_prov_records_list_evt_param  
rcv_provisioner_records_list
```

Event parameter of ESP\_BLE\_MESH\_PROVISIONER\_RECV\_PROV\_RECORDS\_LIST\_EVT

```
struct esp_ble_mesh_prov_cb_param_t::ble_mesh_provisioner_prov_record_rcv_comp_evt_param  
provisioner_prov_record_rcv_comp
```

Event parameter of ESP\_BLE\_MESH\_PROVISIONER\_PROV\_RECORD\_RECV\_COMP\_EVT

```
struct esp_ble_mesh_prov_cb_param_t::ble_mesh_provisioner_send_prov_records_get_evt_param  
provisioner_send_records_get
```

Event parameter of ESP\_BLE\_MESH\_PROVISIONER\_SEND\_PROV\_RECORDS\_GET\_EVT

```
struct esp_ble_mesh_prov_cb_param_t::ble_mesh_provisioner_send_prov_record_req_evt_param  
provisioner_send_record_req
```

Event parameter of ESP\_BLE\_MESH\_PROVISIONER\_SEND\_PROV\_RECORD\_REQUEST\_EVT

```
struct esp_ble_mesh_prov_cb_param_t::ble_mesh_provisioner_send_prov_invite_evt_param  
provisioner_send_prov_invite
```

Event parameter of ESP\_BLE\_MESH\_PROVISIONER\_SEND\_PROV\_INVITE\_EVT

```
struct esp_ble_mesh_prov_cb_param_t::ble_mesh_provisioner_send_link_close_evt_param  
provisioner_send_link_close
```

Event parameter of ESP\_BLE\_MESH\_PROVISIONER\_SEND\_LINK\_CLOSE\_EVT

```
struct esp_ble_mesh_prov_cb_param_t::ble_mesh_provisioner_add_unprov_dev_comp_param  
provisioner_add_unprov_dev_comp
```

Event parameter of ESP\_BLE\_MESH\_PROVISIONER\_ADD\_UNPROV\_DEV\_COMP\_EVT

```
struct esp_ble_mesh_prov_cb_param_t::ble_mesh_provisioner_prov_dev_with_addr_comp_param  
provisioner_prov_dev_with_addr_comp
```

Event parameter of ESP\_BLE\_MESH\_PROVISIONER\_PROV\_DEV\_WITH\_ADDR\_COMP\_EVT

```
struct esp_ble_mesh_prov_cb_param_t::ble_mesh_provisioner_delete_dev_comp_param  
provisioner_delete_dev_comp
```

Event parameter of ESP\_BLE\_MESH\_PROVISIONER\_DELETE\_DEV\_COMP\_EVT

```
struct esp_ble_mesh_prov_cb_param_t::ble_mesh_provisioner_set_dev_uuid_match_comp_param  
provisioner_set_dev_uuid_match_comp
```

Event parameter of ESP\_BLE\_MESH\_PROVISIONER\_SET\_DEV\_UUID\_MATCH\_COMP\_EVT

```
struct esp_ble_mesh_prov_cb_param_t::ble_mesh_provisioner_set_prov_data_info_comp_param  
provisioner_set_prov_data_info_comp
```

Event parameter of ESP\_BLE\_MESH\_PROVISIONER\_SET\_PROV\_DATA\_INFO\_COMP\_EVT

```
struct esp_ble_mesh_prov_cb_param_t::ble_mesh_provisioner_set_static_oob_val_comp_param  
provisioner_set_static_oob_val_comp
```

Event parameter of ESP\_BLE\_MESH\_PROVISIONER\_SET\_STATIC\_OOB\_VALUE\_COMP\_EVT

```
struct esp_ble_mesh_prov_cb_param_t::ble_mesh_provisioner_set_primary_elem_addr_comp_param  
provisioner_set_primary_elem_addr_comp
```

Event parameter of ESP\_BLE\_MESH\_PROVISIONER\_SET\_PRIMARY\_ELEM\_ADDR\_COMP\_EVT

```
struct esp_ble_mesh_prov_cb_param_t::ble_mesh_provisioner_prov_read_oob_pub_key_comp_param  
provisioner_prov_read_oob_pub_key_comp
```

Event parameter of ESP\_BLE\_MESH\_PROVISIONER\_PROV\_READ\_OOB\_PUB\_KEY\_COMP\_EVT

```
struct esp_ble_mesh_prov_cb_param_t::ble_mesh_provisioner_prov_input_num_comp_param  
provisioner_prov_input_num_comp
```

Event parameter of ESP\_BLE\_MESH\_PROVISIONER\_PROV\_INPUT\_NUMBER\_COMP\_EVT

```
struct esp_ble_mesh_prov_cb_param_t::ble_mesh_provisioner_prov_input_str_comp_param  
provisioner_prov_input_str_comp
```

Event parameter of ESP\_BLE\_MESH\_PROVISIONER\_PROV\_INPUT\_STRING\_COMP\_EVT

```
struct esp_ble_mesh_prov_cb_param_t::ble_mesh_provisioner_set_node_name_comp_param  
provisioner_set_node_name_comp
```

Event parameter of ESP\_BLE\_MESH\_PROVISIONER\_SET\_NODE\_NAME\_COMP\_EVT

```
struct esp_ble_mesh_prov_cb_param_t::ble_mesh_provisioner_add_local_app_key_comp_param  
provisioner_add_app_key_comp
```

Event parameter of ESP\_BLE\_MESH\_PROVISIONER\_ADD\_LOCAL\_APP\_KEY\_COMP\_EVT

```
struct esp_ble_mesh_prov_cb_param_t::ble_mesh_provisioner_update_local_app_key_comp_param  
provisioner_update_app_key_comp
```

Event parameter of ESP\_BLE\_MESH\_PROVISIONER\_UPDATE\_LOCAL\_APP\_KEY\_COMP\_EVT

```
struct esp_ble_mesh_prov_cb_param_t::ble_mesh_provisioner_bind_local_mod_app_comp_param  
provisioner_bind_app_key_to_model_comp
```

Event parameter of ESP\_BLE\_MESH\_PROVISIONER\_BIND\_APP\_KEY\_TO\_MODEL\_COMP\_EVT

```
struct esp_ble_mesh_prov_cb_param_t::ble_mesh_provisioner_add_local_net_key_comp_param  
provisioner_add_net_key_comp
```

Event parameter of ESP\_BLE\_MESH\_PROVISIONER\_ADD\_LOCAL\_NET\_KEY\_COMP\_EVT

```
struct esp_ble_mesh_prov_cb_param_t::ble_mesh_provisioner_update_local_net_key_comp_param
provisioner_update_net_key_comp
```

Event parameter of ESP\_BLE\_MESH\_PROVISIONER\_UPDATE\_LOCAL\_NET\_KEY\_COMP\_EVT

```
struct esp_ble_mesh_prov_cb_param_t::ble_mesh_provisioner_store_node_comp_data_comp_param
provisioner_store_node_comp_data_comp
```

Event parameter of ESP\_BLE\_MESH\_PROVISIONER\_STORE\_NODE\_COMP\_DATA\_COMP\_EVT

```
struct esp_ble_mesh_prov_cb_param_t::ble_mesh_provisioner_delete_node_with_uuid_comp_param
provisioner_delete_node_with_uuid_comp
```

Event parameter of ESP\_BLE\_MESH\_PROVISIONER\_DELETE\_NODE\_WITH\_UUID\_COMP\_EVT

```
struct esp_ble_mesh_prov_cb_param_t::ble_mesh_provisioner_delete_node_with_addr_comp_param
provisioner_delete_node_with_addr_comp
```

Event parameter of ESP\_BLE\_MESH\_PROVISIONER\_DELETE\_NODE\_WITH\_ADDR\_COMP\_EVT

int **err\_code**

Indicate the result of enabling/disabling to receive heartbeat messages by the Provisioner

Indicate the result of setting the heartbeat filter type by the Provisioner

Indicate the result of setting the heartbeat filter address by the Provisioner

Indicate the result of directly erasing settings by the Provisioner

Indicate the result of opening settings with index by the Provisioner

Indicate the result of opening settings with user id by the Provisioner

Indicate the result of closing settings with index by the Provisioner

Indicate the result of closing settings with user id by the Provisioner

Indicate the result of deleting settings with index by the Provisioner

Indicate the result of deleting settings with user id by the Provisioner

Indicate the result of Proxy Client send Solicitation PDU

bool **enable**

Indicate enabling or disabling receiving heartbeat messages

```
struct esp_ble_mesh_prov_cb_param_t::[anonymous]
provisioner_enable_heartbeat_recv_comp
```

ESP\_BLE\_MESH\_PROVISIONER\_ENABLE\_HEARTBEAT\_RECV\_COMP\_EVT.

Event parameters of ESP\_BLE\_MESH\_PROVISIONER\_ENABLE\_HEARTBEAT\_RECV\_COMP\_EVT

uint8\_t **type**

Type of the filter used for receiving heartbeat messages

```
struct esp_ble_mesh_prov_cb_param_t::[anonymous]
provisioner_set_heartbeat_filter_type_comp
```

ESP\_BLE\_MESH\_PROVISIONER\_SET\_HEARTBEAT\_FILTER\_TYPE\_COMP\_EVT.

Event parameters of ESP\_BLE\_MESH\_PROVISIONER\_SET\_HEARTBEAT\_FILTER\_TYPE\_COMP\_EVT

uint8\_t **op**

Operation (add, remove, clean)

uint16\_t **hb\_src**

Heartbeat source address

uint16\_t **hb\_dst**

Heartbeat destination address

struct *esp\_ble\_mesh\_prov\_cb\_param\_t*::[anonymous]

**provisioner\_set\_heartbeat\_filter\_info\_comp**

ESP\_BLE\_MESH\_PROVISIONER\_SET\_HEARTBEAT\_FILTER\_INFO\_COMP\_EVT.

Event parameters of ESP\_BLE\_MESH\_PROVISIONER\_SET\_HEARTBEAT\_FILTER\_INFO\_COMP\_EVT

uint8\_t **init\_ttl**

Heartbeat InitTTL

uint8\_t **rx\_ttl**

Heartbeat RxTTL

uint8\_t **hops**

Heartbeat hops (InitTTL - RxTTL + 1)

uint16\_t **feature**

Bit field of currently active features of the node

int8\_t **rss\_i**

RSSI of the heartbeat message

struct *esp\_ble\_mesh\_prov\_cb\_param\_t*::[anonymous] **provisioner\_recv\_heartbeat**

ESP\_BLE\_MESH\_PROVISIONER\_RECV\_HEARTBEAT\_MESSAGE\_EVT.

Event parameters of ESP\_BLE\_MESH\_PROVISIONER\_RECV\_HEARTBEAT\_MESSAGE\_EVT

struct *esp\_ble\_mesh\_prov\_cb\_param\_t*::[anonymous]

**provisioner\_direct\_erase\_settings\_comp**

ESP\_BLE\_MESH\_PROVISIONER\_DIRECT\_ERASE\_SETTINGS\_COMP\_EVT.

Event parameters of ESP\_BLE\_MESH\_PROVISIONER\_DIRECT\_ERASE\_SETTINGS\_COMP\_EVT

uint8\_t **index**

Index of Provisioner settings

struct *esp\_ble\_mesh\_prov\_cb\_param\_t*::[anonymous]

**provisioner\_open\_settings\_with\_index\_comp**

ESP\_BLE\_MESH\_PROVISIONER\_OPEN\_SETTINGS\_WITH\_INDEX\_COMP\_EVT.

Event parameter of ESP\_BLE\_MESH\_PROVISIONER\_OPEN\_SETTINGS\_WITH\_INDEX\_COMP\_EVT

char **uid**[ESP\_BLE\_MESH\_SETTINGS\_UID\_SIZE + 1]

Provisioner settings user id

struct *esp\_ble\_mesh\_prov\_cb\_param\_t*::[anonymous]

**provisioner\_open\_settings\_with\_uid\_comp**



ESP\_BLE\_MESH\_PROVISIONER\_OPEN\_SETTINGS\_WITH\_UID\_COMP\_EVT.

Event parameters of ESP\_BLE\_MESH\_PROVISIONER\_OPEN\_SETTINGS\_WITH\_UID\_COMP\_EVT

```
struct esp_ble_mesh_prov_cb_param_t::[anonymous]
```

**provisioner\_close\_settings\_with\_index\_comp**

ESP\_BLE\_MESH\_PROVISIONER\_CLOSE\_SETTINGS\_WITH\_INDEX\_COMP\_EVT.

Event parameter of ESP\_BLE\_MESH\_PROVISIONER\_CLOSE\_SETTINGS\_WITH\_INDEX\_COMP\_EVT

```
struct esp_ble_mesh_prov_cb_param_t::[anonymous]
```

**provisioner\_close\_settings\_with\_uid\_comp**

ESP\_BLE\_MESH\_PROVISIONER\_CLOSE\_SETTINGS\_WITH\_UID\_COMP\_EVT.

Event parameters of ESP\_BLE\_MESH\_PROVISIONER\_CLOSE\_SETTINGS\_WITH\_UID\_COMP\_EVT

```
struct esp_ble_mesh_prov_cb_param_t::[anonymous]
```

**provisioner\_delete\_settings\_with\_index\_comp**

ESP\_BLE\_MESH\_PROVISIONER\_DELETE\_SETTINGS\_WITH\_INDEX\_COMP\_EVT.

Event parameter of ESP\_BLE\_MESH\_PROVISIONER\_DELETE\_SETTINGS\_WITH\_INDEX\_COMP\_EVT

```
struct esp_ble_mesh_prov_cb_param_t::[anonymous]
```

**provisioner\_delete\_settings\_with\_uid\_comp**

ESP\_BLE\_MESH\_PROVISIONER\_DELETE\_SETTINGS\_WITH\_UID\_COMP\_EVT.

Event parameters of ESP\_BLE\_MESH\_PROVISIONER\_DELETE\_SETTINGS\_WITH\_UID\_COMP\_EVT

```
struct esp_ble_mesh_prov_cb_param_t::ble_mesh_set_fast_prov_info_comp_param
```

**set\_fast\_prov\_info\_comp**

Event parameter of ESP\_BLE\_MESH\_SET\_FAST\_PROV\_INFO\_COMP\_EVT

```
struct esp_ble_mesh_prov_cb_param_t::ble_mesh_set_fast_prov_action_comp_param
```

**set\_fast\_prov\_action\_comp**

Event parameter of ESP\_BLE\_MESH\_SET\_FAST\_PROV\_ACTION\_COMP\_EVT

```
struct esp_ble_mesh_prov_cb_param_t::ble_mesh_heartbeat_msg_rcv_param heartbeat_msg_rcv
```

Event parameter of ESP\_BLE\_MESH\_HEARTBEAT\_MESSAGE\_RECV\_EVT

```
struct esp_ble_mesh_prov_cb_param_t::ble_mesh_lpn_enable_comp_param lpn_enable_comp
```

Event parameter of ESP\_BLE\_MESH\_LPN\_ENABLE\_COMP\_EVT

```
struct esp_ble_mesh_prov_cb_param_t::ble_mesh_lpn_disable_comp_param lpn_disable_comp
```

Event parameter of ESP\_BLE\_MESH\_LPN\_DISABLE\_COMP\_EVT

```
struct esp_ble_mesh_prov_cb_param_t::ble_mesh_lpn_poll_comp_param lpn_poll_comp
```

Event parameter of ESP\_BLE\_MESH\_LPN\_POLL\_COMP\_EVT

```
struct esp_ble_mesh_prov_cb_param_t::ble_mesh_lpn_friendship_establish_param
```

**lpn\_friendship\_establish**

Event parameter of ESP\_BLE\_MESH\_LPN\_FRIENDSHIP\_ESTABLISH\_EVT

```
struct esp_ble_mesh_prov_cb_param_t::ble_mesh_lpn_friendship_terminate_param
```

**lpn\_friendship\_terminate**

Event parameter of ESP\_BLE\_MESH\_LPN\_FRIENDSHIP\_TERMINATE\_EVT

```
struct esp_ble_mesh_prov_cb_param_t::ble_mesh_friend_friendship_establish_param  
frnd_friendship_establish
```

Event parameter of ESP\_BLE\_MESH\_FRIEND\_FRIENDSHIP\_ESTABLISH\_EVT

```
struct esp_ble_mesh_prov_cb_param_t::ble_mesh_friend_friendship_terminate_param  
frnd_friendship_terminate
```

Event parameter of ESP\_BLE\_MESH\_FRIEND\_FRIENDSHIP\_TERMINATE\_EVT

```
struct esp_ble_mesh_prov_cb_param_t::ble_mesh_proxy_client_rcv_adv_pkt_param  
proxy_client_rcv_adv_pkt
```

Event parameter of ESP\_BLE\_MESH\_PROXY\_CLIENT\_RECV\_ADV\_PKT\_EVT

```
struct esp_ble_mesh_prov_cb_param_t::ble_mesh_proxy_client_connected_param  
proxy_client_connected
```

Event parameter of ESP\_BLE\_MESH\_PROXY\_CLIENT\_CONNECTED\_EVT

```
struct esp_ble_mesh_prov_cb_param_t::ble_mesh_proxy_client_disconnected_param  
proxy_client_disconnected
```

Event parameter of ESP\_BLE\_MESH\_PROXY\_CLIENT\_DISCONNECTED\_EVT

```
struct esp_ble_mesh_prov_cb_param_t::ble_mesh_proxy_client_rcv_filter_status_param  
proxy_client_rcv_filter_status
```

Event parameter of ESP\_BLE\_MESH\_PROXY\_CLIENT\_RECV\_FILTER\_STATUS\_EVT

```
struct esp_ble_mesh_prov_cb_param_t::ble_mesh_proxy_client_connect_comp_param  
proxy_client_connect_comp
```

Event parameter of ESP\_BLE\_MESH\_PROXY\_CLIENT\_CONNECT\_COMP\_EVT

```
struct esp_ble_mesh_prov_cb_param_t::ble_mesh_proxy_client_disconnect_comp_param  
proxy_client_disconnect_comp
```

Event parameter of ESP\_BLE\_MESH\_PROXY\_CLIENT\_DISCONNECT\_COMP\_EVT

```
struct esp_ble_mesh_prov_cb_param_t::ble_mesh_proxy_client_set_filter_type_comp_param  
proxy_client_set_filter_type_comp
```

Event parameter of ESP\_BLE\_MESH\_PROXY\_CLIENT\_SET\_FILTER\_TYPE\_COMP\_EVT

```
struct esp_ble_mesh_prov_cb_param_t::ble_mesh_proxy_client_add_filter_addr_comp_param  
proxy_client_add_filter_addr_comp
```

Event parameter of ESP\_BLE\_MESH\_PROXY\_CLIENT\_ADD\_FILTER\_ADDR\_COMP\_EVT

```
struct esp_ble_mesh_prov_cb_param_t::ble_mesh_proxy_client_remove_filter_addr_comp_param  
proxy_client_remove_filter_addr_comp
```

Event parameter of ESP\_BLE\_MESH\_PROXY\_CLIENT\_REMOVE\_FILTER\_ADDR\_COMP\_EVT

```
struct esp_ble_mesh_prov_cb_param_t::ble_mesh_proxy_client_directed_proxy_set_param  
proxy_client_directed_proxy_set_comp
```

Event parameter of ESP\_BLE\_MESH\_PROXY\_CLIENT\_DIRECTED\_PROXY\_SET\_COMP\_EVT

```
struct esp_ble_mesh_prov_cb_param_t::ble_mesh_proxy_server_connected_param  
proxy_server_connected
```

Event parameter of ESP\_BLE\_MESH\_PROXY\_SERVER\_CONNECTED\_EVT

```
struct esp_ble_mesh_prov_cb_param_t::ble_mesh_proxy_server_disconnected_param
proxy_server_disconnected
    Event parameter of ESP_BLE_MESH_PROXY_SERVER_DISCONNECTED_EVT
```

```
uint16_t net_idx
    Corresponding NetKey Index
```

```
uint16_t ssrc
    Solicitation SRC
```

```
uint16_t dst
    Solicitation DST
```

```
struct esp_ble_mesh_prov_cb_param_t::[anonymous] proxy_client_send_solic_pdu_comp
    ESP_BLE_MESH_PROXY_CLIENT_SEND_SOLIC_PDU_COMP_EVT.
    Event parameter of ESP_BLE_MESH_PROXY_CLIENT_SEND_SOLIC_PDU_COMP_EVT
```

```
struct esp_ble_mesh_prov_cb_param_t::ble_mesh_model_sub_group_addr_comp_param
model_sub_group_addr_comp
    Event parameters of ESP_BLE_MESH_MODEL_SUBSCRIBE_GROUP_ADDR_COMP_EVT
```

```
struct esp_ble_mesh_prov_cb_param_t::ble_mesh_model_unsub_group_addr_comp_param
model_unsub_group_addr_comp
    Event parameters of ESP_BLE_MESH_MODEL_UNSUBSCRIBE_GROUP_ADDR_COMP_EVT
```

```
struct esp_ble_mesh_prov_cb_param_t::ble_mesh_deinit_mesh_comp_param deinit_mesh_comp
    Event parameter of ESP_BLE_MESH_DEINIT_MESH_COMP_EVT
```

```
struct ble_mesh_deinit_mesh_comp_param
    #include <esp_ble_mesh_defs.h> ESP_BLE_MESH_DEINIT_MESH_COMP_EVT.
```

### Public Members

```
int err_code
    Indicate the result of BLE Mesh deinitialization
```

```
struct ble_mesh_friend_friendship_establish_param
    #include <esp_ble_mesh_defs.h> ESP_BLE_MESH_FRIEND_FRIENDSHIP_ESTABLISH_EVT.
```

### Public Members

```
uint16_t lpn_addr
    Low Power Node unicast address
```

```
struct ble_mesh_friend_friendship_terminate_param
    #include <esp_ble_mesh_defs.h> ESP_BLE_MESH_FRIEND_FRIENDSHIP_TERMINATE_EVT.
```

## Public Types

enum **[anonymous]**

This enum value is the reason of friendship termination on the friend node side

*Values:*

enumerator **ESP\_BLE\_MESH\_FRND\_FRIENDSHIP\_TERMINATE\_ESTABLISH\_FAIL**

Friend Offer has been sent, but Friend Offer is not received within 1 second, friendship fails to be established

enumerator **ESP\_BLE\_MESH\_FRND\_FRIENDSHIP\_TERMINATE\_POLL\_TIMEOUT**

Friendship is established, PollTimeout timer expires and no Friend Poll/Sub Add/Sub Remove is received

enumerator **ESP\_BLE\_MESH\_FRND\_FRIENDSHIP\_TERMINATE\_RECV\_FRND\_REQ**

Receive Friend Request from existing Low Power Node

enumerator **ESP\_BLE\_MESH\_FRND\_FRIENDSHIP\_TERMINATE\_RECV\_FRND\_CLEAR**

Receive Friend Clear from other friend node

enumerator **ESP\_BLE\_MESH\_FRND\_FRIENDSHIP\_TERMINATE\_DISABLE**

Friend feature disabled or corresponding NetKey is deleted

## Public Members

uint16\_t **lpn\_addr**

Low Power Node unicast address

enum *esp\_ble\_mesh\_prov\_cb\_param\_t::ble\_mesh\_friend\_friendship\_terminate\_param::[anonymous]*  
**reason**

This enum value is the reason of friendship termination on the friend node side Friendship terminated reason

struct **ble\_mesh\_heartbeat\_msg\_rcv\_param**

*#include <esp\_ble\_mesh\_defs.h>* ESP\_BLE\_MESH\_HEARTBEAT\_MESSAGE\_RECV\_EVT.

## Public Members

uint8\_t **hops**

Heartbeat hops (InitTTL - RxTTL + 1)

uint16\_t **feature**

Bit field of currently active features of the node

struct **ble\_mesh\_input\_evt\_param**

*#include <esp\_ble\_mesh\_defs.h>* ESP\_BLE\_MESH\_NODE\_PROV\_INPUT\_EVT.

**Public Members**

*esp\_ble\_mesh\_input\_action\_t* **action**

Action of Input OOB Authentication

uint8\_t **size**

Size of Input OOB Authentication

struct **ble\_mesh\_input\_number\_comp\_param**

*#include <esp\_ble\_mesh\_defs.h>* ESP\_BLE\_MESH\_NODE\_PROV\_INPUT\_NUM\_COMP\_EVT.

**Public Members**

int **err\_code**

Indicate the result of inputting number

struct **ble\_mesh\_input\_string\_comp\_param**

*#include <esp\_ble\_mesh\_defs.h>* ESP\_BLE\_MESH\_NODE\_PROV\_INPUT\_STR\_COMP\_EVT.

**Public Members**

int **err\_code**

Indicate the result of inputting string

struct **ble\_mesh\_link\_close\_evt\_param**

*#include <esp\_ble\_mesh\_defs.h>* ESP\_BLE\_MESH\_NODE\_PROV\_LINK\_CLOSE\_EVT.

**Public Members**

*esp\_ble\_mesh\_prov\_bearer\_t* **bearer**

Type of the bearer used when device link is closed

uint8\_t **reason**

Reason of the closed provisioning link

struct **ble\_mesh\_link\_open\_evt\_param**

*#include <esp\_ble\_mesh\_defs.h>* ESP\_BLE\_MESH\_NODE\_PROV\_LINK\_OPEN\_EVT.

**Public Members**

*esp\_ble\_mesh\_prov\_bearer\_t* **bearer**

Type of the bearer used when device link is open

struct **ble\_mesh\_lpn\_disable\_comp\_param**

*#include <esp\_ble\_mesh\_defs.h>* ESP\_BLE\_MESH\_LPN\_DISABLE\_COMP\_EVT.

**Public Members**

int **err\_code**

Indicate the result of disabling LPN functionality

struct **ble\_mesh\_lpn\_enable\_comp\_param**

*#include <esp\_ble\_mesh\_defs.h>* ESP\_BLE\_MESH\_LPN\_ENABLE\_COMP\_EVT.

**Public Members**

int **err\_code**

Indicate the result of enabling LPN functionality

struct **ble\_mesh\_lpn\_friendship\_establish\_param**

*#include <esp\_ble\_mesh\_defs.h>* ESP\_BLE\_MESH\_LPN\_FRIENDSHIP\_ESTABLISH\_EVT.

**Public Members**

uint16\_t **friend\_addr**

Friend Node unicast address

struct **ble\_mesh\_lpn\_friendship\_terminate\_param**

*#include <esp\_ble\_mesh\_defs.h>* ESP\_BLE\_MESH\_LPN\_FRIENDSHIP\_TERMINATE\_EVT.

**Public Members**

uint16\_t **friend\_addr**

Friend Node unicast address

struct **ble\_mesh\_lpn\_poll\_comp\_param**

*#include <esp\_ble\_mesh\_defs.h>* ESP\_BLE\_MESH\_LPN\_POLL\_COMP\_EVT.

**Public Members**

int **err\_code**

Indicate the result of sending Friend Poll

struct **ble\_mesh\_model\_sub\_group\_addr\_comp\_param**

*#include <esp\_ble\_mesh\_defs.h>* ESP\_BLE\_MESH\_MODEL\_SUBSCRIBE\_GROUP\_ADDR\_COMP\_EVT.

**Public Members**

int **err\_code**

Indicate the result of local model subscribing group address

uint16\_t **element\_addr**

Element address

uint16\_t **company\_id**

Company ID

uint16\_t **model\_id**

Model ID

uint16\_t **group\_addr**

Group Address

struct **ble\_mesh\_model\_unsub\_group\_addr\_comp\_param**

*#include <esp\_ble\_mesh\_defs.h>* ESP\_BLE\_MESH\_MODEL\_UNSUBSCRIBE\_GROUP\_ADDR\_COMP\_EVT.

### Public Members

int **err\_code**

Indicate the result of local model unsubscribing group address

uint16\_t **element\_addr**

Element address

uint16\_t **company\_id**

Company ID

uint16\_t **model\_id**

Model ID

uint16\_t **group\_addr**

Group Address

struct **ble\_mesh\_node\_add\_local\_app\_key\_comp\_param**

*#include <esp\_ble\_mesh\_defs.h>* ESP\_BLE\_MESH\_NODE\_ADD\_LOCAL\_APP\_KEY\_COMP\_EVT.

### Public Members

int **err\_code**

Indicate the result of adding local AppKey by the node

uint16\_t **net\_idx**

NetKey Index

uint16\_t **app\_idx**

AppKey Index

struct **ble\_mesh\_node\_add\_local\_net\_key\_comp\_param**

*#include <esp\_ble\_mesh\_defs.h>* ESP\_BLE\_MESH\_NODE\_ADD\_LOCAL\_NET\_KEY\_COMP\_EVT.

**Public Members****int err\_code**

Indicate the result of adding local NetKey by the node

**uint16\_t net\_idx**

NetKey Index

struct **ble\_mesh\_node\_bind\_local\_mod\_app\_comp\_param***#include <esp\_ble\_mesh\_defs.h>* ESP\_BLE\_MESH\_NODE\_BIND\_APP\_KEY\_TO\_MODEL\_COMP\_EVT.**Public Members****int err\_code**

Indicate the result of binding AppKey with model by the node

**uint16\_t element\_addr**

Element address

**uint16\_t app\_idx**

AppKey Index

**uint16\_t company\_id**

Company ID

**uint16\_t model\_id**

Model ID

struct **ble\_mesh\_output\_num\_evt\_param***#include <esp\_ble\_mesh\_defs.h>* ESP\_BLE\_MESH\_NODE\_PROV\_OUTPUT\_NUMBER\_EVT.**Public Members***esp\_ble\_mesh\_output\_action\_t* **action**

Action of Output OOB Authentication

**uint32\_t number**

Number of Output OOB Authentication

struct **ble\_mesh\_output\_str\_evt\_param***#include <esp\_ble\_mesh\_defs.h>* ESP\_BLE\_MESH\_NODE\_PROV\_OUTPUT\_STRING\_EVT.**Public Members**char **string**[8]

String of Output OOB Authentication



```
struct ble_mesh_prov_disable_comp_param  
    #include <esp_ble_mesh_defs.h> ESP_BLE_MESH_NODE_PROV_DISABLE_COMP_EVT.
```

### Public Members

```
int err_code  
    Indicate the result of disabling BLE Mesh device
```

```
struct ble_mesh_prov_enable_comp_param  
    #include <esp_ble_mesh_defs.h> ESP_BLE_MESH_NODE_PROV_ENABLE_COMP_EVT.
```

### Public Members

```
int err_code  
    Indicate the result of enabling BLE Mesh device
```

```
struct ble_mesh_prov_register_comp_param  
    #include <esp_ble_mesh_defs.h> ESP_BLE_MESH_PROV_REGISTER_COMP_EVT.
```

### Public Members

```
int err_code  
    Indicate the result of BLE Mesh initialization
```

```
struct ble_mesh_provision_complete_evt_param  
    #include <esp_ble_mesh_defs.h> ESP_BLE_MESH_NODE_PROV_COMPLETE_EVT.
```

### Public Members

```
uint16_t net_idx  
    NetKey Index
```

```
uint8_t net_key[16]  
    NetKey
```

```
uint16_t addr  
    Primary address
```

```
uint8_t flags  
    Flags
```

```
uint32_t iv_index  
    IV Index
```

```
struct ble_mesh_provision_reset_param  
    #include <esp_ble_mesh_defs.h> ESP_BLE_MESH_NODE_PROV_RESET_EVT.
```

```
struct ble_mesh_provisioner_add_local_app_key_comp_param  
    #include <esp_ble_mesh_defs.h>ESP_BLE_MESH_PROVISIONER_ADD_LOCAL_APP_KEY_COMP_EVT.
```

### Public Members

int **err\_code**  
 Indicate the result of adding local AppKey by the Provisioner

uint16\_t **net\_idx**  
 NetKey Index

uint16\_t **app\_idx**  
 AppKey Index

```
struct ble_mesh_provisioner_add_local_net_key_comp_param  
    #include <esp_ble_mesh_defs.h>ESP_BLE_MESH_PROVISIONER_ADD_LOCAL_NET_KEY_COMP_EVT.
```

### Public Members

int **err\_code**  
 Indicate the result of adding local NetKey by the Provisioner

uint16\_t **net\_idx**  
 NetKey Index

```
struct ble_mesh_provisioner_add_unprov_dev_comp_param  
    #include <esp_ble_mesh_defs.h>ESP_BLE_MESH_PROVISIONER_ADD_UNPROV_DEV_COMP_EVT.
```

### Public Members

int **err\_code**  
 Indicate the result of adding device into queue by the Provisioner

```
struct ble_mesh_provisioner_bind_local_mod_app_comp_param  
    #include <esp_ble_mesh_defs.h>ESP_BLE_MESH_PROVISIONER_BIND_APP_KEY_TO_MODEL_COMP_EVT.
```

### Public Members

int **err\_code**  
 Indicate the result of binding AppKey with model by the Provisioner

uint16\_t **element\_addr**  
 Element address

uint16\_t **app\_idx**  
 AppKey Index

uint16\_t **company\_id**

Company ID

uint16\_t **model\_id**

Model ID

struct **ble\_mesh\_provisioner\_cert\_based\_prov\_start\_evt\_param**

*#include <esp\_ble\_mesh\_defs.h>* ESP\_BLE\_MESH\_PROVISIONER\_CERT\_BASED\_PROV\_START\_EVT.

### Public Members

uint16\_t **link\_idx**

Index of the provisioning link

struct **ble\_mesh\_provisioner\_delete\_dev\_comp\_param**

*#include <esp\_ble\_mesh\_defs.h>* ESP\_BLE\_MESH\_PROVISIONER\_DELETE\_DEV\_COMP\_EVT.

### Public Members

int **err\_code**

Indicate the result of deleting device by the Provisioner

struct **ble\_mesh\_provisioner\_delete\_node\_with\_addr\_comp\_param**

*#include <esp\_ble\_mesh\_defs.h>* ESP\_BLE\_MESH\_PROVISIONER\_DELETE\_NODE\_WITH\_ADDR\_COMP\_EVT.

### Public Members

int **err\_code**

Indicate the result of deleting node with unicast address by the Provisioner

uint16\_t **unicast\_addr**

Node unicast address

struct **ble\_mesh\_provisioner\_delete\_node\_with\_uuid\_comp\_param**

*#include <esp\_ble\_mesh\_defs.h>* ESP\_BLE\_MESH\_PROVISIONER\_DELETE\_NODE\_WITH\_UUID\_COMP\_EVT.

### Public Members

int **err\_code**

Indicate the result of deleting node with uuid by the Provisioner

uint8\_t **uuid**[16]

Node device uuid

struct **ble\_mesh\_provisioner\_link\_close\_evt\_param**

*#include <esp\_ble\_mesh\_defs.h>* ESP\_BLE\_MESH\_PROVISIONER\_PROV\_LINK\_CLOSE\_EVT.

### Public Members

*esp\_ble\_mesh\_prov\_bearer\_t* **bearer**

Type of the bearer used when Provisioner link is closed

uint8\_t **reason**

Reason of the closed provisioning link

struct **ble\_mesh\_provisioner\_link\_open\_evt\_param**

*#include <esp\_ble\_mesh\_defs.h>* ESP\_BLE\_MESH\_PROVISIONER\_PROV\_LINK\_OPEN\_EVT.

### Public Members

*esp\_ble\_mesh\_prov\_bearer\_t* **bearer**

Type of the bearer used when Provisioner link is opened

struct **ble\_mesh\_provisioner\_prov\_comp\_param**

*#include <esp\_ble\_mesh\_defs.h>* ESP\_BLE\_MESH\_PROVISIONER\_PROV\_COMPLETE\_EVT.

### Public Members

uint16\_t **node\_idx**

Index of the provisioned device

*esp\_ble\_mesh\_octet16\_t* **device\_uuid**

Device UUID of the provisioned device

uint16\_t **unicast\_addr**

Primary address of the provisioned device

uint8\_t **element\_num**

Element count of the provisioned device

uint16\_t **netkey\_idx**

NetKey Index of the provisioned device

struct **ble\_mesh\_provisioner\_prov\_dev\_with\_addr\_comp\_param**

*#include <esp\_ble\_mesh\_defs.h>* ESP\_BLE\_MESH\_PROVISIONER\_PROV\_DEV\_WITH\_ADDR\_COMP\_EVT.

### Public Members

int **err\_code**

Indicate the result of Provisioner starting to provision a device

struct **ble\_mesh\_provisioner\_prov\_disable\_comp\_param**

*#include <esp\_ble\_mesh\_defs.h>* ESP\_BLE\_MESH\_PROVISIONER\_PROV\_DISABLE\_COMP\_EVT.

### Public Members

int **err\_code**

Indicate the result of disabling BLE Mesh Provisioner

struct **ble\_mesh\_provisioner\_prov\_enable\_comp\_param**

*#include <esp\_ble\_mesh\_defs.h>* ESP\_BLE\_MESH\_PROVISIONER\_PROV\_ENABLE\_COMP\_EVT.

### Public Members

int **err\_code**

Indicate the result of enabling BLE Mesh Provisioner

struct **ble\_mesh\_provisioner\_prov\_input\_evt\_param**

*#include <esp\_ble\_mesh\_defs.h>* ESP\_BLE\_MESH\_PROVISIONER\_PROV\_INPUT\_EVT.

### Public Members

*esp\_ble\_mesh\_oob\_method\_t* **method**

Method of device Output OOB Authentication

*esp\_ble\_mesh\_output\_action\_t* **action**

Action of device Output OOB Authentication

uint8\_t **size**

Size of device Output OOB Authentication

uint8\_t **link\_idx**

Index of the provisioning link

struct **ble\_mesh\_provisioner\_prov\_input\_num\_comp\_param**

*#include <esp\_ble\_mesh\_defs.h>* ESP\_BLE\_MESH\_PROVISIONER\_PROV\_INPUT\_NUMBER\_COMP\_EVT.

### Public Members

int **err\_code**

Indicate the result of inputting number by the Provisioner

struct **ble\_mesh\_provisioner\_prov\_input\_str\_comp\_param**

*#include <esp\_ble\_mesh\_defs.h>* ESP\_BLE\_MESH\_PROVISIONER\_PROV\_INPUT\_STRING\_COMP\_EVT.

### Public Members

int **err\_code**

Indicate the result of inputting string by the Provisioner

```
struct ble_mesh_provisioner_prov_output_evt_param  
    #include <esp_ble_mesh_defs.h> ESP_BLE_MESH_PROVISIONER_PROV_OUTPUT_EVT.
```

### Public Members

[\*esp\\_ble\\_mesh\\_oob\\_method\\_t\*](#) **method**  
Method of device Input OOB Authentication

[\*esp\\_ble\\_mesh\\_input\\_action\\_t\*](#) **action**  
Action of device Input OOB Authentication

**uint8\_t size**  
Size of device Input OOB Authentication

**uint8\_t link\_idx**  
Index of the provisioning link

char **string**[8]  
String output by the Provisioner

**uint32\_t number**  
Number output by the Provisioner

union [\*esp\\_ble\\_mesh\\_prov\\_cb\\_param\\_t::ble\\_mesh\\_provisioner\\_prov\\_output\\_evt\\_param::\*](#)[anonymous]  
**[anonymous]**  
Union of output OOB

```
struct ble_mesh_provisioner_prov_read_oob_pub_key_comp_param  
    #include <esp_ble_mesh_defs.h> ESP_BLE_MESH_PROVISIONER_PROV_READ_OOB_PUB_KEY_COMP_EVT.
```

### Public Members

int **err\_code**  
Indicate the result of setting OOB Public Key by the Provisioner

```
struct ble_mesh_provisioner_prov_read_oob_pub_key_evt_param  
    #include <esp_ble_mesh_defs.h> ESP_BLE_MESH_PROVISIONER_PROV_READ_OOB_PUB_KEY_EVT.
```

### Public Members

**uint8\_t link\_idx**  
Index of the provisioning link

```
struct ble_mesh_provisioner_prov_record_rcv_comp_evt_param  
    #include <esp_ble_mesh_defs.h> ESP_BLE_MESH_PROVISIONER_PROV_RECORD_RECV_COMP_EVT.
```

### Public Members

uint8\_t **status**

Indicates whether or not the request was handled successfully

uint16\_t **link\_idx**

Index of the provisioning link

uint16\_t **record\_id**

Identifies the provisioning record for which the request is made

uint16\_t **frag\_offset**

The starting offset of the requested fragment in the provisioning record data

uint16\_t **total\_len**

Total length of the provisioning record data stored on the Provisionee

uint8\_t \***record**

Provisioning record data fragment

struct **ble\_mesh\_provisioner\_rcv\_prov\_records\_list\_evt\_param**

*#include <esp\_ble\_mesh\_defs.h>* ESP\_BLE\_MESH\_PROVISIONER\_RECV\_PROV\_RECORDS\_LIST\_EVT.

### Public Members

uint16\_t **link\_idx**

Index of the provisioning link

uint16\_t **len**

Length of message

uint8\_t \***msg**

Lists the Record IDs of the provisioning records stored on the Provisionee

struct **ble\_mesh\_provisioner\_rcv\_unprov\_adv\_pkt\_param**

*#include <esp\_ble\_mesh\_defs.h>* ESP\_BLE\_MESH\_PROVISIONER\_RECV\_UNPROV\_ADV\_PKT\_EVT.

### Public Members

uint8\_t **dev\_uuid**[16]

Device UUID of the unprovisioned device

*esp\_ble\_mesh\_bd\_addr\_t* **addr**

Device address of the unprovisioned device

*esp\_ble\_mesh\_addr\_type\_t* **addr\_type**

Device address type

uint16\_t **oob\_info**

OOB Info of the unprovisioned device

uint8\_t **adv\_type**

Advertising type of the unprovisioned device

*esp\_ble\_mesh\_prov\_bearer\_t* **bearer**

Bearer of the unprovisioned device

int8\_t **rssi**

RSSI of the received advertising packet

struct **ble\_mesh\_provisioner\_send\_link\_close\_evt\_param**

*#include <esp\_ble\_mesh\_defs.h>* ESP\_BLE\_MESH\_PROVISIONER\_SEND\_LINK\_CLOSE\_EVT.

### Public Members

uint16\_t **link\_idx**

Index of the provisioning link

int **err\_code**

Indicate the result of send Link Close message

struct **ble\_mesh\_provisioner\_send\_prov\_invite\_evt\_param**

*#include <esp\_ble\_mesh\_defs.h>* ESP\_BLE\_MESH\_PROVISIONER\_SEND\_PROV\_INVITE\_EVT.

### Public Members

uint16\_t **link\_idx**

Index of the provisioning link

int **err\_code**

Indicate the result of send Provisioning Invite message

struct **ble\_mesh\_provisioner\_send\_prov\_record\_req\_evt\_param**

*#include <esp\_ble\_mesh\_defs.h>* ESP\_BLE\_MESH\_PROVISIONER\_SEND\_PROV\_RECORD\_REQUEST\_EVT.

### Public Members

int **err\_code**

Indicate the result of send Provisioning Record Request message

uint16\_t **link\_idx**

Index of the provisioning link



uint16\_t **record\_id**

Identifies the provisioning record for which the request is made

uint16\_t **frag\_offset**

The starting offset of the requested fragment in the provisioning record data

uint16\_t **max\_size**

The maximum size of the provisioning record fragment that the Provisioner can receive

struct **ble\_mesh\_provisioner\_send\_prov\_records\_get\_evt\_param**

*#include <esp\_ble\_mesh\_defs.h>* ESP\_BLE\_MESH\_PROVISIONER\_SEND\_PROV\_RECORDS\_GET\_EVT.

### Public Members

int **err\_code**

Indicate the result of send Provisioning Records List Get message

uint16\_t **link\_idx**

Index of the provisioning link

struct **ble\_mesh\_provisioner\_set\_dev\_uuid\_match\_comp\_param**

*#include <esp\_ble\_mesh\_defs.h>* ESP\_BLE\_MESH\_PROVISIONER\_SET\_DEV\_UUID\_MATCH\_COMP\_EVT.

### Public Members

int **err\_code**

Indicate the result of setting Device UUID match value by the Provisioner

struct **ble\_mesh\_provisioner\_set\_node\_name\_comp\_param**

*#include <esp\_ble\_mesh\_defs.h>* ESP\_BLE\_MESH\_PROVISIONER\_SET\_NODE\_NAME\_COMP\_EVT.

### Public Members

int **err\_code**

Indicate the result of setting provisioned device name by the Provisioner

uint16\_t **node\_index**

Index of the provisioned device

struct **ble\_mesh\_provisioner\_set\_primary\_elem\_addr\_comp\_param**

*#include <esp\_ble\_mesh\_defs.h>* ESP\_BLE\_MESH\_PROVISIONER\_SET\_PRIMARY\_ELEM\_ADDR\_COMP\_EVT.

### Public Members

int **err\_code**

Indicate the result of setting unicast address of primary element by the Provisioner

```
struct ble_mesh_provisioner_set_prov_data_info_comp_param  
    #include <esp_ble_mesh_defs.h>ESP_BLE_MESH_PROVISIONER_SET_PROV_DATA_INFO_COMP_EVT.
```

### Public Members

int **err\_code**  
 Indicate the result of setting provisioning info by the Provisioner

```
struct ble_mesh_provisioner_set_static_oob_val_comp_param  
    #include <esp_ble_mesh_defs.h>ESP_BLE_MESH_PROVISIONER_SET_STATIC_OOB_VALUE_COMP_EVT.
```

### Public Members

int **err\_code**  
 Indicate the result of setting static oob value by the Provisioner

```
struct ble_mesh_provisioner_store_node_comp_data_comp_param  
    #include <esp_ble_mesh_defs.h>ESP_BLE_MESH_PROVISIONER_STORE_NODE_COMP_DATA_COMP_EVT.
```

### Public Members

int **err\_code**  
 Indicate the result of storing node composition data by the Provisioner

uint16\_t **addr**  
 Node element address

```
struct ble_mesh_provisioner_update_local_app_key_comp_param  
    #include <esp_ble_mesh_defs.h>ESP_BLE_MESH_PROVISIONER_UPDATE_LOCAL_APP_KEY_COMP_EVT.
```

### Public Members

int **err\_code**  
 Indicate the result of updating local AppKey by the Provisioner

uint16\_t **net\_idx**  
 NetKey Index

uint16\_t **app\_idx**  
 AppKey Index

```
struct ble_mesh_provisioner_update_local_net_key_comp_param  
    #include <esp_ble_mesh_defs.h>ESP_BLE_MESH_PROVISIONER_UPDATE_LOCAL_NET_KEY_COMP_EVT.
```

**Public Members****int err\_code**

Indicate the result of updating local NetKey by the Provisioner

**uint16\_t net\_idx**

NetKey Index

**struct ble\_mesh\_proxy\_client\_add\_filter\_addr\_comp\_param***#include <esp\_ble\_mesh\_defs.h>* ESP\_BLE\_MESH\_PROXY\_CLIENT\_ADD\_FILTER\_ADDR\_COMP\_EVT.**Public Members****int err\_code**

Indicate the result of Proxy Client add filter address

**uint8\_t conn\_handle**

Proxy connection handle

**uint16\_t net\_idx**

Corresponding NetKey Index

**struct ble\_mesh\_proxy\_client\_connect\_comp\_param***#include <esp\_ble\_mesh\_defs.h>* ESP\_BLE\_MESH\_PROXY\_CLIENT\_CONNECT\_COMP\_EVT.**Public Members****int err\_code**

Indicate the result of Proxy Client connect

*esp\_ble\_mesh\_bd\_addr\_t* **addr**

Device address of the Proxy Server

*esp\_ble\_mesh\_addr\_type\_t* **addr\_type**

Device address type

**uint16\_t net\_idx**

Corresponding NetKey Index

**struct ble\_mesh\_proxy\_client\_connected\_param***#include <esp\_ble\_mesh\_defs.h>* ESP\_BLE\_MESH\_PROXY\_CLIENT\_CONNECTED\_EVT.**Public Members***esp\_ble\_mesh\_bd\_addr\_t* **addr**

Device address of the Proxy Server

*esp\_ble\_mesh\_addr\_type\_t* **addr\_type**

Device address type

uint8\_t **conn\_handle**

Proxy connection handle

uint16\_t **net\_idx**

Corresponding NetKey Index

struct **ble\_mesh\_proxy\_client\_directed\_proxy\_set\_param**

*#include <esp\_ble\_mesh\_defs.h>* ESP\_BLE\_MESH\_PROXY\_CLIENT\_DIRECTED\_PROXY\_CONTROL\_COMP\_EVT

### Public Members

int **err\_code**

Indicate the result of Proxy Client directed proxy control address

uint8\_t **conn\_handle**

Proxy connection handle

uint16\_t **net\_idx**

Corresponding NetKey Index

struct **ble\_mesh\_proxy\_client\_disconnect\_comp\_param**

*#include <esp\_ble\_mesh\_defs.h>* ESP\_BLE\_MESH\_PROXY\_CLIENT\_DISCONNECT\_COMP\_EVT.

### Public Members

int **err\_code**

Indicate the result of Proxy Client disconnect

uint8\_t **conn\_handle**

Proxy connection handle

struct **ble\_mesh\_proxy\_client\_disconnected\_param**

*#include <esp\_ble\_mesh\_defs.h>* ESP\_BLE\_MESH\_PROXY\_CLIENT\_DISCONNECTED\_EVT.

### Public Members

*esp\_ble\_mesh\_bd\_addr\_t* **addr**

Device address of the Proxy Server

*esp\_ble\_mesh\_addr\_type\_t* **addr\_type**

Device address type

uint8\_t **conn\_handle**

Proxy connection handle

uint16\_t **net\_idx**

Corresponding NetKey Index

uint8\_t **reason**

Proxy disconnect reason

struct **ble\_mesh\_proxy\_client\_rcv\_adv\_pkt\_param**

*#include <esp\_ble\_mesh\_defs.h>* ESP\_BLE\_MESH\_PROXY\_CLIENT\_RECV\_ADV\_PKT\_EVT.

### Public Members

*esp\_ble\_mesh\_bd\_addr\_t* **addr**

Device address

*esp\_ble\_mesh\_addr\_type\_t* **addr\_type**

Device address type

uint16\_t **net\_idx**

Network ID related NetKey Index

uint8\_t **net\_id**[8]

Network ID contained in the advertising packet

int8\_t **rss\_i**

RSSI of the received advertising packet

struct **ble\_mesh\_proxy\_client\_rcv\_filter\_status\_param**

*#include <esp\_ble\_mesh\_defs.h>* ESP\_BLE\_MESH\_PROXY\_CLIENT\_RECV\_FILTER\_STATUS\_EVT.

### Public Members

uint8\_t **conn\_handle**

Proxy connection handle

uint16\_t **server\_addr**

Proxy Server primary element address

uint16\_t **net\_idx**

Corresponding NetKey Index

uint8\_t **filter\_type**

Proxy Server filter type(whitelist or blacklist)

uint16\_t **list\_size**

Number of addresses in the Proxy Server filter list

struct **ble\_mesh\_proxy\_client\_remove\_filter\_addr\_comp\_param**

*#include <esp\_ble\_mesh\_defs.h>* ESP\_BLE\_MESH\_PROXY\_CLIENT\_REMOVE\_FILTER\_ADDR\_COMP\_EVT.

### Public Members

int **err\_code**

Indicate the result of Proxy Client remove filter address

uint8\_t **conn\_handle**

Proxy connection handle

uint16\_t **net\_idx**

Corresponding NetKey Index

struct **ble\_mesh\_proxy\_client\_set\_filter\_type\_comp\_param**

*#include <esp\_ble\_mesh\_defs.h>* ESP\_BLE\_MESH\_PROXY\_CLIENT\_SET\_FILTER\_TYPE\_COMP\_EVT.

### Public Members

int **err\_code**

Indicate the result of Proxy Client set filter type

uint8\_t **conn\_handle**

Proxy connection handle

uint16\_t **net\_idx**

Corresponding NetKey Index

struct **ble\_mesh\_proxy\_gatt\_disable\_comp\_param**

*#include <esp\_ble\_mesh\_defs.h>* ESP\_BLE\_MESH\_NODE\_PROXY\_GATT\_DISABLE\_COMP\_EVT.

### Public Members

int **err\_code**

Indicate the result of disabling Mesh Proxy Service

struct **ble\_mesh\_proxy\_gatt\_enable\_comp\_param**

*#include <esp\_ble\_mesh\_defs.h>* ESP\_BLE\_MESH\_NODE\_PROXY\_GATT\_ENABLE\_COMP\_EVT.

### Public Members

int **err\_code**

Indicate the result of enabling Mesh Proxy Service

```
struct ble_mesh_proxy_identity_enable_comp_param  
    #include <esp_ble_mesh_defs.h> ESP_BLE_MESH_NODE_PROXY_IDENTITY_ENABLE_COMP_EVT.
```

### Public Members

int **err\_code**  
 Indicate the result of enabling Mesh Proxy advertising

```
struct ble_mesh_proxy_private_identity_disable_comp_param  
    #include <esp_ble_mesh_defs.h> ESP_BLE_MESH_NODE_PRIVATE_PROXY_IDENTITY_DISABLE_COMP_EVT.
```

### Public Members

int **err\_code**  
 Indicate the result of disabling Mesh Proxy private advertising

```
struct ble_mesh_proxy_private_identity_enable_comp_param  
    #include <esp_ble_mesh_defs.h> ESP_BLE_MESH_NODE_PRIVATE_PROXY_IDENTITY_ENABLE_COMP_EVT.
```

### Public Members

int **err\_code**  
 Indicate the result of enabling Mesh Proxy private advertising

```
struct ble_mesh_proxy_server_connected_param  
    #include <esp_ble_mesh_defs.h> ESP_BLE_MESH_PROXY_SERVER_CONNECTED_EVT.
```

### Public Members

uint8\_t **conn\_handle**  
 Proxy connection handle

```
struct ble_mesh_proxy_server_disconnected_param  
    #include <esp_ble_mesh_defs.h> ESP_BLE_MESH_PROXY_SERVER_DISCONNECTED_EVT.
```

### Public Members

uint8\_t **conn\_handle**  
 Proxy connection handle

uint8\_t **reason**  
 Proxy disconnect reason

```
struct ble_mesh_set_fast_prov_action_comp_param  
    #include <esp_ble_mesh_defs.h> ESP_BLE_MESH_SET_FAST_PROV_ACTION_COMP_EVT.
```

### Public Members

uint8\_t **status\_action**

Indicate the result of setting action of fast provisioning

struct **ble\_mesh\_set\_fast\_prov\_info\_comp\_param**

*#include <esp\_ble\_mesh\_defs.h>* ESP\_BLE\_MESH\_SET\_FAST\_PROV\_INFO\_COMP\_EVT.

### Public Members

uint8\_t **status\_unicast**

Indicate the result of setting unicast address range of fast provisioning

uint8\_t **status\_net\_idx**

Indicate the result of setting NetKey Index of fast provisioning

uint8\_t **status\_match**

Indicate the result of setting matching Device UUID of fast provisioning

struct **ble\_mesh\_set\_oob\_pub\_key\_comp\_param**

*#include <esp\_ble\_mesh\_defs.h>* ESP\_BLE\_MESH\_NODE\_PROV\_SET\_OOB\_PUB\_KEY\_COMP\_EVT.

### Public Members

int **err\_code**

Indicate the result of setting OOB Public Key

struct **ble\_mesh\_set\_unprov\_dev\_name\_comp\_param**

*#include <esp\_ble\_mesh\_defs.h>* ESP\_BLE\_MESH\_NODE\_SET\_UNPROV\_DEV\_NAME\_COMP\_EVT.

### Public Members

int **err\_code**

Indicate the result of setting BLE Mesh device name

union **esp\_ble\_mesh\_server\_state\_value\_t**

*#include <esp\_ble\_mesh\_defs.h>* Server model state value union.

### Public Members

uint8\_t **onoff**

The value of the Generic OnOff state

The value of the Light LC Light OnOff state

struct *esp\_ble\_mesh\_server\_state\_value\_t*::[anonymous] **gen\_onoff**

The Generic OnOff state



**int16\_t level**

The value of the Generic Level state

struct *esp\_ble\_mesh\_server\_state\_value\_t*::[anonymous] **gen\_level**

The Generic Level state

**uint8\_t onpowerup**

The value of the Generic OnPowerUp state

struct *esp\_ble\_mesh\_server\_state\_value\_t*::[anonymous] **gen\_onpowerup**

The Generic OnPowerUp state

**uint16\_t power**

The value of the Generic Power Actual state

struct *esp\_ble\_mesh\_server\_state\_value\_t*::[anonymous] **gen\_power\_actual**

The Generic Power Actual state

**uint16\_t lightness**

The value of the Light Lightness Actual state

The value of the Light Lightness Linear state

The value of the Light CTL Lightness state

The value of the Light HSL Lightness state

The value of the Light xyL Lightness state

struct *esp\_ble\_mesh\_server\_state\_value\_t*::[anonymous] **light\_lightness\_actual**

The Light Lightness Actual state

struct *esp\_ble\_mesh\_server\_state\_value\_t*::[anonymous] **light\_lightness\_linear**

The Light Lightness Linear state

struct *esp\_ble\_mesh\_server\_state\_value\_t*::[anonymous] **light\_ctl\_lightness**

The Light CTL Lightness state

**uint16\_t temperature**

The value of the Light CTL Temperature state

**int16\_t delta\_uv**

The value of the Light CTL Delta UV state

struct *esp\_ble\_mesh\_server\_state\_value\_t*::[anonymous] **light\_ctl\_temp\_delta\_uv**

The Light CTL Temperature & Delta UV states

**uint16\_t hue**

The value of the Light HSL Hue state

**uint16\_t saturation**

The value of the Light HSL Saturation state

```
struct esp_ble_mesh_server_state_value_t::[anonymous] light_hsl
```

The Light HSL composite state

```
struct esp_ble_mesh_server_state_value_t::[anonymous] light_hsl_lightness
```

The Light HSL Lightness state

```
struct esp_ble_mesh_server_state_value_t::[anonymous] light_hsl_hue
```

The Light HSL Hue state

```
struct esp_ble_mesh_server_state_value_t::[anonymous] light_hsl_saturation
```

The Light HSL Saturation state

```
struct esp_ble_mesh_server_state_value_t::[anonymous] light_xyl_lightness
```

The Light xyL Lightness state

```
struct esp_ble_mesh_server_state_value_t::[anonymous] light_lc_light_onoff
```

The Light LC Light OnOff state

```
union esp_ble_mesh_model_cb_param_t
```

*#include <esp\_ble\_mesh\_defs.h>* BLE Mesh model callback parameters union.

### Public Members

```
struct esp_ble_mesh_model_cb_param_t::ble_mesh_model_operation_evt_param model_operation
```

Event parameter of ESP\_BLE\_MESH\_MODEL\_OPERATION\_EVT

```
struct esp_ble_mesh_model_cb_param_t::ble_mesh_model_send_comp_param model_send_comp
```

Event parameter of ESP\_BLE\_MESH\_MODEL\_SEND\_COMP\_EVT

```
struct esp_ble_mesh_model_cb_param_t::ble_mesh_model_publish_comp_param model_publish_comp
```

Event parameter of ESP\_BLE\_MESH\_MODEL\_PUBLISH\_COMP\_EVT

```
struct esp_ble_mesh_model_cb_param_t::ble_mesh_mod_rcv_publish_msg_param
```

```
client_rcv_publish_msg
```

Event parameter of ESP\_BLE\_MESH\_CLIENT\_MODEL\_RECV\_PUBLISH\_MSG\_EVT

```
struct esp_ble_mesh_model_cb_param_t::ble_mesh_client_model_send_timeout_param
```

```
client_send_timeout
```

Event parameter of ESP\_BLE\_MESH\_CLIENT\_MODEL\_SEND\_TIMEOUT\_EVT

```
struct esp_ble_mesh_model_cb_param_t::ble_mesh_model_publish_update_evt_param
```

```
model_publish_update
```

Event parameter of ESP\_BLE\_MESH\_MODEL\_PUBLISH\_UPDATE\_EVT

```
struct esp_ble_mesh_model_cb_param_t::ble_mesh_server_model_update_state_comp_param
```

```
server_model_update_state
```

Event parameter of ESP\_BLE\_MESH\_SERVER\_MODEL\_UPDATE\_STATE\_COMP\_EVT

```
struct ble_mesh_client_model_send_timeout_param
```

*#include <esp\_ble\_mesh\_defs.h>* ESP\_BLE\_MESH\_CLIENT\_MODEL\_SEND\_TIMEOUT\_EVT.

### Public Members

uint32\_t **opcode**

Opcode of the previously sent message

*esp\_ble\_mesh\_model\_t* \***model**

Pointer to the model which sends the previous message

*esp\_ble\_mesh\_msg\_ctx\_t* \***ctx**

Pointer to the context of the previous message

struct **ble\_mesh\_mod\_rcv\_publish\_msg\_param**

*#include <esp\_ble\_mesh\_defs.h>* ESP\_BLE\_MESH\_CLIENT\_MODEL\_RECV\_PUBLISH\_MSG\_EVT.

### Public Members

uint32\_t **opcode**

Opcode of the unsolicited received message

*esp\_ble\_mesh\_model\_t* \***model**

Pointer to the model which receives the message

*esp\_ble\_mesh\_msg\_ctx\_t* \***ctx**

Pointer to the context of the message

uint16\_t **length**

Length of the received message

uint8\_t \***msg**

Value of the received message

struct **ble\_mesh\_model\_operation\_evt\_param**

*#include <esp\_ble\_mesh\_defs.h>* ESP\_BLE\_MESH\_MODEL\_OPERATION\_EVT.

### Public Members

uint32\_t **opcode**

Opcode of the received message

*esp\_ble\_mesh\_model\_t* \***model**

Pointer to the model which receives the message

*esp\_ble\_mesh\_msg\_ctx\_t* \***ctx**

Pointer to the context of the received message

uint16\_t **length**

Length of the received message

uint8\_t \***msg**

Value of the received message

struct **ble\_mesh\_model\_publish\_comp\_param**

*#include <esp\_ble\_mesh\_defs.h>* ESP\_BLE\_MESH\_MODEL\_PUBLISH\_COMP\_EVT.

### Public Members

int **err\_code**

Indicate the result of publishing a message

*esp\_ble\_mesh\_model\_t* \***model**

Pointer to the model which publishes the message

struct **ble\_mesh\_model\_publish\_update\_evt\_param**

*#include <esp\_ble\_mesh\_defs.h>* ESP\_BLE\_MESH\_MODEL\_PUBLISH\_UPDATE\_EVT.

### Public Members

*esp\_ble\_mesh\_model\_t* \***model**

Pointer to the model which is going to update its publish message

struct **ble\_mesh\_model\_send\_comp\_param**

*#include <esp\_ble\_mesh\_defs.h>* ESP\_BLE\_MESH\_MODEL\_SEND\_COMP\_EVT.

### Public Members

int **err\_code**

Indicate the result of sending a message

uint32\_t **opcode**

Opcode of the message

*esp\_ble\_mesh\_model\_t* \***model**

Pointer to the model which sends the message

*esp\_ble\_mesh\_msg\_ctx\_t* \***ctx**

Context of the message

struct **ble\_mesh\_server\_model\_update\_state\_comp\_param**

*#include <esp\_ble\_mesh\_defs.h>* ESP\_BLE\_MESH\_SERVER\_MODEL\_UPDATE\_STATE\_COMP\_EVT.

### Public Members

int **err\_code**

Indicate the result of updating server model state

*esp\_ble\_mesh\_model\_t* \*model

Pointer to the server model which state value is updated

*esp\_ble\_mesh\_server\_state\_type\_t* type

Type of the updated server state

## Structures

struct **esp\_ble\_mesh\_deinit\_param\_t**

BLE Mesh deinit parameters

## Public Members

bool **erase\_flash**

Indicate if erasing flash when deinit mesh stack

struct **esp\_ble\_mesh\_uar\_t**

Format of Unicast Address Range

## Public Members

uint16\_t **len\_present**

Indicate the presence or absence of the RangeLength field

uint16\_t **range\_start**

15 least significant bits of the starting unicast address

uint8\_t **range\_length**

Number of addresses in the range (0x02 - 0xFF)

struct **esp\_ble\_mesh\_elem\_t**

Abstraction that describes a BLE Mesh Element. This structure is associated with struct `bt_mesh_elem` in `mesh_access.h`

## Public Members

uint16\_t **element\_addr**

Element Address, assigned during provisioning.

const uint16\_t **location**

Location Descriptor (GATT Bluetooth Namespace Descriptors)

const uint8\_t **sig\_model\_count**

SIG Model count

const uint8\_t **vnd\_model\_count**

Vendor Model count

*esp\_ble\_mesh\_model\_t* \***sig\_models**

SIG Models

*esp\_ble\_mesh\_model\_t* \***vnd\_models**

Vendor Models

struct **esp\_ble\_mesh\_model\_pub\_t**

Abstraction that describes a model publication context. This structure is associated with struct `bt_mesh_model_pub` in `mesh_access.h`

### Public Members

*esp\_ble\_mesh\_model\_t* \***model**

Pointer to the model to which the context belongs. Initialized by the stack.

uint16\_t **publish\_addr**

Publish Address.

uint16\_t **app\_idx**

Publish AppKey Index.

uint16\_t **cred**

Friendship Credentials Flag.

uint16\_t **send\_rel**

Force reliable sending (segment acks)

uint16\_t **send\_szmic**

Size of TransMIC when publishing a Segmented Access message

uint8\_t **ttl**

Publish Time to Live.

uint8\_t **retransmit**

Retransmit Count & Interval Steps.

uint8\_t **period**

Publish Period.

uint8\_t **period\_div**

Divisor for the Period.

uint8\_t **fast\_period**

Use FastPeriodDivisor

uint8\_t **count**

Retransmissions left.

uint32\_t **period\_start**

Start of the current period.

struct net\_buf\_simple \***msg**

Publication buffer, containing the publication message.

This will get correctly created when the publication context has been defined using the `ESP_BLE_MESH_MODEL_PUB_DEFINE` macro.

`ESP_BLE_MESH_MODEL_PUB_DEFINE(name, size);`

*esp\_ble\_mesh\_cb\_t* **update**

Callback used to update publish message. Initialized by the stack.

struct k\_delayed\_work **timer**

Publish Period Timer. Initialized by the stack.

uint8\_t **dev\_role**

Role of the device that is going to publish messages

struct **esp\_ble\_mesh\_model\_op\_t**

Abstraction that describes a model operation context. This structure is associated with struct `bt_mesh_model_op` in `mesh_access.h`

### Public Members

const uint32\_t **opcode**

Message opcode

const size\_t **min\_len**

Message minimum length

*esp\_ble\_mesh\_cb\_t* **param\_cb**

Callback used to handle message. Initialized by the stack.

struct **esp\_ble\_mesh\_model\_cbs\_t**

Abstraction that describes a model callback structure. This structure is associated with struct `bt_mesh_model_cb` in `mesh_access.h`.

### Public Members

*esp\_ble\_mesh\_cb\_t* **init\_cb**

Callback used during model initialization. Initialized by the stack.

struct **esp\_ble\_mesh\_model**

Abstraction that describes a Mesh Model instance. This structure is associated with struct `bt_mesh_model` in `mesh_access.h`

**Public Members**

const uint16\_t **model\_id**

16-bit model identifier

uint16\_t **company\_id**

16-bit company identifier

uint16\_t **model\_id**

16-bit model identifier

struct *esp\_ble\_mesh\_model\_t*::[anonymous]::[anonymous] **vnd**

Structure encapsulating a model ID with a company ID

union *esp\_ble\_mesh\_model\_t*::[anonymous] **[anonymous]**

Model ID

uint8\_t **element\_idx**

Internal information, mainly for persistent storage Belongs to Nth element

uint8\_t **model\_idx**

Is the Nth model in the element

uint16\_t **flags**

Information about what has changed

*esp\_ble\_mesh\_elem\_t* \***element**

The Element to which this Model belongs

*esp\_ble\_mesh\_model\_pub\_t* \*const **pub**

Model Publication

uint16\_t **keys**[CONFIG\_BLE\_MESH\_MODEL\_KEY\_COUNT]

AppKey List

uint16\_t **groups**[CONFIG\_BLE\_MESH\_MODEL\_GROUP\_COUNT]

Subscription List (group or virtual addresses)

*esp\_ble\_mesh\_model\_op\_t* \***op**

Model operation context

*esp\_ble\_mesh\_model\_cbs\_t* \***cb**

Model callback structure

void \***user\_data**

Model-specific user data

struct **esp\_ble\_mesh\_msg\_ctx\_t**

Message sending context. This structure is associated with struct *bt\_mesh\_msg\_ctx* in *mesh\_access.h*



**Public Members****uint16\_t net\_idx**

NetKey Index of the subnet through which to send the message.

**uint16\_t app\_idx**

AppKey Index for message encryption.

**uint16\_t addr**

Remote address.

**uint16\_t recv\_dst**

Destination address of a received message. Not used for sending.

**int8\_t recv\_rssi**

RSSI of a received message. Not used for sending.

**uint32\_t recv\_op**

Opcode of a received message. Not used for sending.

**uint8\_t recv\_ttl**

Received TTL value. Not used for sending.

**uint8\_t recv\_cred**

Security credentials of a received message. Not used for sending.

**uint8\_t recv\_tag**

Tag of a received message. Not used for sending.

**uint8\_t send\_rel**

Force sending reliably by using segment acknowledgement.

**uint8\_t send\_szmic**

Size of TransMIC when sending a Segmented Access message.

**uint8\_t send\_ttl**

TTL, or ESP\_BLE\_MESH\_TTL\_DEFAULT for default TTL.

**uint8\_t send\_cred**

Security credentials used for sending the message

**uint8\_t send\_tag**

Tag used for sending the message.

***esp\_ble\_mesh\_model\_t* \*model**

Model corresponding to the message, no need to be initialized before sending message

**bool srv\_send**

Indicate if the message is sent by a node server model, no need to be initialized before sending message

struct **esp\_ble\_mesh\_prov\_t**

Provisioning properties & capabilities. This structure is associated with struct `bt_mesh_prov` in `mesh_access.h`

struct **esp\_ble\_mesh\_comp\_t**

Node Composition data context. This structure is associated with struct `bt_mesh_comp` in `mesh_access.h`

### Public Members

uint16\_t **cid**

16-bit SIG-assigned company identifier

uint16\_t **pid**

16-bit vendor-assigned product identifier

uint16\_t **vid**

16-bit vendor-assigned product version identifier

size\_t **element\_count**

Element count

*esp\_ble\_mesh\_elem\_t* \***elements**

A sequence of elements

struct **esp\_ble\_mesh\_unprov\_dev\_add\_t**

Information of the device which is going to be added for provisioning.

### Public Members

*esp\_ble\_mesh\_bd\_addr\_t* **addr**

Device address

*esp\_ble\_mesh\_addr\_type\_t* **addr\_type**

Device address type

uint8\_t **uuid**[16]

Device UUID

uint16\_t **oob\_info**

Device OOB Info `ADD_DEV_START_PROV_NOW_FLAG` shall not be set if the bearer has both PB-ADV and PB-GATT enabled

*esp\_ble\_mesh\_prov\_bearer\_t* **bearer**

Provisioning Bearer

struct **esp\_ble\_mesh\_device\_delete\_t**

Information of the device which is going to be deleted.

**Public Members**

*esp\_ble\_mesh\_bd\_addr\_t* **addr**

Device address

*esp\_ble\_mesh\_addr\_type\_t* **addr\_type**

Device address type

uint8\_t **uuid**[16]

Device UUID

union *esp\_ble\_mesh\_device\_delete\_t*::[anonymous] [**anonymous**]

Union of Device information

uint8\_t **flag**

BIT0: device address; BIT1: device UUID

struct **esp\_ble\_mesh\_prov\_data\_info\_t**

Information of the provisioner which is going to be updated.

**Public Members**

uint16\_t **net\_idx**

NetKey Index

uint8\_t **flags**

Flags

uint32\_t **iv\_index**

IV Index

union *esp\_ble\_mesh\_prov\_data\_info\_t*::[anonymous] [**anonymous**]

Provisioning data

uint8\_t **flag**

BIT0: net\_idx; BIT1: flags; BIT2: iv\_index

struct **esp\_ble\_mesh\_node\_t**

Information of the provisioned node

**Public Members**

*esp\_ble\_mesh\_bd\_addr\_t* **addr**

Node device address

*esp\_ble\_mesh\_addr\_type\_t* **addr\_type**

Node device address type

uint8\_t **dev\_uuid**[16]

Device UUID

uint16\_t **oob\_info**

Node OOB information

uint16\_t **unicast\_addr**

Node unicast address

uint8\_t **element\_num**

Node element number

uint16\_t **net\_idx**

Node NetKey Index

uint8\_t **flags**

Node key refresh flag and iv update flag

uint32\_t **iv\_index**

Node IV Index

uint8\_t **dev\_key**[16]

Node device key

char **name**[ESP\_BLE\_MESH\_NODE\_NAME\_MAX\_LEN + 1]

Node name

uint16\_t **comp\_length**

Length of Composition Data

uint8\_t \***comp\_data**

Value of Composition Data

struct **esp\_ble\_mesh\_fast\_prov\_info\_t**

Context of fast provisioning which need to be set.

### Public Members

uint16\_t **unicast\_min**

Minimum unicast address used for fast provisioning

uint16\_t **unicast\_max**

Maximum unicast address used for fast provisioning

uint16\_t **net\_idx**

Netkey index used for fast provisioning

`uint8_t flags`

Flags used for fast provisioning

`uint32_t iv_index`

IV Index used for fast provisioning

`uint8_t offset`

Offset of the UUID to be compared

`uint8_t match_len`

Length of the UUID to be compared

`uint8_t match_val[16]`

Value of UUID to be compared

struct `esp_ble_mesh_heartbeat_filter_info_t`

Context of Provisioner heartbeat filter information to be set

### Public Members

`uint16_t hb_src`

Heartbeat source address (unicast address)

`uint16_t hb_dst`

Heartbeat destination address (unicast address or group address)

struct `esp_ble_mesh_client_op_pair_t`

BLE Mesh client models related definitions.

Client model Get/Set message opcode and corresponding Status message opcode

### Public Members

`uint32_t cli_op`

The client message opcode

`uint32_t status_op`

The server status opcode corresponding to the client message opcode

struct `esp_ble_mesh_client_t`

Client Model user data context.

### Public Members

`esp_ble_mesh_model_t *model`

Pointer to the client model. Initialized by the stack.

uint32\_t **op\_pair\_size**

Size of the op\_pair

const *esp\_ble\_mesh\_client\_op\_pair\_t* \***op\_pair**

Table containing get/set message opcode and corresponding status message opcode

uint32\_t **publish\_status**

Callback used to handle the received unsolicited message. Initialized by the stack.

void \***internal\_data**

Pointer to the internal data of client model

void \***vendor\_data**

Pointer to the vendor data of client model

uint8\_t **msg\_role**

Role of the device (Node/Provisioner) that is going to send messages

struct **esp\_ble\_mesh\_client\_common\_param\_t**

Common parameters of the messages sent by Client Model.

### Public Members

*esp\_ble\_mesh\_opcode\_t* **opcode**

Message opcode

*esp\_ble\_mesh\_model\_t* \***model**

Pointer to the client model structure

*esp\_ble\_mesh\_msg\_ctx\_t* **ctx**

The context used to send message

int32\_t **msg\_timeout**

Timeout value (ms) to get response to the sent message Note: if using default timeout value in menuconfig, make sure to set this value to 0

uint8\_t **msg\_role**

Role of the device - Node/Provisioner

struct **esp\_ble\_mesh\_state\_transition\_t**

Parameters of the server model state transition

### Public Functions

**BLE\_MESH\_ATOMIC\_DEFINE** (flag, *ESP\_BLE\_MESH\_SERVER\_FLAG\_MAX*)

Flag used to indicate if the transition timer has been started internally.

If the model which contains *esp\_ble\_mesh\_state\_transition\_t* sets "set\_auto\_rsp" to *ESP\_BLE\_MESH\_SERVER\_RSP\_BY\_APP*, the handler of the timer shall be initialized by the users.

And users can use this flag to indicate whether the timer is started or not.

### Public Members

bool **just\_started**

Indicate if the state transition has just started

uint8\_t **trans\_time**

State transition time

uint8\_t **remain\_time**

Remaining time of state transition

uint8\_t **delay**

Delay before starting state transition

uint32\_t **quo\_tt**

Duration of each divided transition step

uint32\_t **counter**

Number of steps which the transition duration is divided

uint32\_t **total\_duration**

State transition total duration

int64\_t **start\_timestamp**

Time when the state transition is started

struct k\_delayed\_work **timer**

Timer used for state transition

struct **esp\_ble\_mesh\_last\_msg\_info\_t**

Parameters of the server model received last same set message.

### Public Members

uint8\_t **tid**

Transaction number of the last message

uint16\_t **src**

Source address of the last message

uint16\_t **dst**

Destination address of the last message

int64\_t **timestamp**

Time when the last message is received

struct **esp\_ble\_mesh\_server\_rsp\_ctrl\_t**

Parameters of the Server Model response control

### Public Members

uint8\_t **get\_auto\_rsp**

BLE Mesh Server Response Option.

- i. If `get_auto_rsp` is set to `ESP_BLE_MESH_SERVER_RSP_BY_APP`, then the response of Client Get messages need to be replied by the application;
- ii. If `get_auto_rsp` is set to `ESP_BLE_MESH_SERVER_AUTO_RSP`, then the response of Client Get messages will be replied by the server models;
- iii. If `set_auto_rsp` is set to `ESP_BLE_MESH_SERVER_RSP_BY_APP`, then the response of Client Set messages need to be replied by the application;
- iv. If `set_auto_rsp` is set to `ESP_BLE_MESH_SERVER_AUTO_RSP`, then the response of Client Set messages will be replied by the server models;
- v. If `status_auto_rsp` is set to `ESP_BLE_MESH_SERVER_RSP_BY_APP`, then the response of Server Status messages need to be replied by the application;
- vi. If `status_auto_rsp` is set to `ESP_BLE_MESH_SERVER_AUTO_RSP`, then the response of Server Status messages will be replied by the server models; Response control for Client Get messages

uint8\_t **set\_auto\_rsp**

Response control for Client Set messages

uint8\_t **status\_auto\_rsp**

Response control for Server Status messages

### Macros

**ESP\_BLE\_MESH\_SDU\_MAX\_LEN**

< The maximum length of a BLE Mesh message, including Opcode, Payload and TransMIC Length of a short Mesh MIC.

**ESP\_BLE\_MESH\_MIC\_SHORT**

Length of a long Mesh MIC.

**ESP\_BLE\_MESH\_MIC\_LONG**

The maximum length of a BLE Mesh provisioned node name

**ESP\_BLE\_MESH\_NODE\_NAME\_MAX\_LEN**

The maximum length of a BLE Mesh unprovisioned device name

**ESP\_BLE\_MESH\_DEVICE\_NAME\_MAX\_LEN**

The maximum length of settings user id

**ESP\_BLE\_MESH\_SETTINGS\_UID\_SIZE**

The default value of Random Update Interval Steps

**ESP\_BLE\_MESH\_RAND\_UPDATE\_INTERVAL\_DEFAULT**

Invalid settings index



**ESP\_BLE\_MESH\_INVALID\_SETTINGS\_IDX**

Define the BLE Mesh octet 16 bytes size

**ESP\_BLE\_MESH\_OCTET16\_LEN**

**ESP\_BLE\_MESH\_OCTET8\_LEN**

**ESP\_BLE\_MESH\_CID\_NVAL**

Special TTL value to request using configured default TTL

**ESP\_BLE\_MESH\_TTL\_DEFAULT**

Maximum allowed TTL value

**ESP\_BLE\_MESH\_TTL\_MAX**

**ESP\_BLE\_MESH\_ADDR\_UNASSIGNED**

**ESP\_BLE\_MESH\_ADDR\_ALL\_NODES**

**ESP\_BLE\_MESH\_ADDR\_PROXIES**

**ESP\_BLE\_MESH\_ADDR\_FRIENDS**

**ESP\_BLE\_MESH\_ADDR\_RELAYS**

**ESP\_BLE\_MESH\_KEY\_UNUSED**

**ESP\_BLE\_MESH\_KEY\_DEV**

**ESP\_BLE\_MESH\_KEY\_PRIMARY**

**ESP\_BLE\_MESH\_KEY\_ANY**

Internal macros used to initialize array members

**ESP\_BLE\_MESH\_KEY\_UNUSED\_ELT\_ (IDX, \_)**

**ESP\_BLE\_MESH\_ADDR\_UNASSIGNED\_ELT\_ (IDX, \_)**

**ESP\_BLE\_MESH\_MODEL\_KEYS\_UNUSED**

**ESP\_BLE\_MESH\_MODEL\_GROUPS\_UNASSIGNED**

Primary Network Key index

**ESP\_BLE\_MESH\_NET\_PRIMARY**

Relay state value

**ESP\_BLE\_MESH\_RELAY\_DISABLED**

**ESP\_BLE\_MESH\_RELAY\_ENABLED**

**ESP\_BLE\_MESH\_RELAY\_NOT\_SUPPORTED**

Beacon state value

**ESP\_BLE\_MESH\_BEACON\_DISABLED**

**ESP\_BLE\_MESH\_BEACON\_ENABLED**

**ESP\_BLE\_MESH\_PRIVATE\_BEACON\_DISABLE**

**ESP\_BLE\_MESH\_PRIVATE\_BEACON\_ENABLE**

GATT Proxy state value

**ESP\_BLE\_MESH\_GATT\_PROXY\_DISABLED**

**ESP\_BLE\_MESH\_GATT\_PROXY\_ENABLED**

**ESP\_BLE\_MESH\_GATT\_PROXY\_NOT\_SUPPORTED**

**ESP\_BLE\_MESH\_PRIVATE\_GATT\_PROXY\_DISABLED**

**ESP\_BLE\_MESH\_PRIVATE\_GATT\_PROXY\_ENABLED**

**ESP\_BLE\_MESH\_PRIVATE\_GATT\_PROXY\_NOT\_SUPPORTED**

**ESP\_BLE\_MESH\_PRIVATE\_NODE\_IDENTITY\_DISABLED**

**ESP\_BLE\_MESH\_PRIVATE\_NODE\_IDENTITY\_ENABLED**

**ESP\_BLE\_MESH\_PRIVATE\_NODE\_IDENTITY\_NOT\_SUPPORTED**

Friend state value

**ESP\_BLE\_MESH\_FRIEND\_DISABLED**

**ESP\_BLE\_MESH\_FRIEND\_ENABLED**

**ESP\_BLE\_MESH\_FRIEND\_NOT\_SUPPORTED**

Node identity state value

**ESP\_BLE\_MESH\_NODE\_IDENTITY\_STOPPED**

**ESP\_BLE\_MESH\_NODE\_IDENTITY\_RUNNING**

**ESP\_BLE\_MESH\_NODE\_IDENTITY\_NOT\_SUPPORTED**

Subnet Bridge state value

**ESP\_BLE\_MESH\_SUBNET\_BRIDGE\_DISABLED**

**ESP\_BLE\_MESH\_SUBNET\_BRIDGE\_ENABLED**

Supported features

**ESP\_BLE\_MESH\_FEATURE\_RELAY**

**ESP\_BLE\_MESH\_FEATURE\_PROXY**

**ESP\_BLE\_MESH\_FEATURE\_FRIEND**

**ESP\_BLE\_MESH\_FEATURE\_LOW\_POWER**

**ESP\_BLE\_MESH\_FEATURE\_ALL\_SUPPORTED**

**ESP\_BLE\_MESH\_ADDR\_IS\_UNICAST** (addr)

**ESP\_BLE\_MESH\_ADDR\_IS\_GROUP** (addr)

**ESP\_BLE\_MESH\_ADDR\_IS\_VIRTUAL** (addr)

**ESP\_BLE\_MESH\_ADDR\_IS\_RFU** (addr)

**ESP\_BLE\_MESH\_INVALID\_NODE\_INDEX**

**ESP\_BLE\_MESH\_PROV\_RECORD\_MAX\_ID**

**ESP\_BLE\_MESH\_TRANSMIT** (count, int\_ms)

Encode transmission count & interval steps.

---

**备注:** For example, `ESP_BLE_MESH_TRANSMIT(2, 20)` means that the message will be sent about 90ms(count is 3, step is 1, interval is 30 ms which includes 10ms of advertising interval random delay).

---

#### 参数

- **count** -- Number of retransmissions (first transmission is excluded).
- **int\_ms** -- Interval steps in milliseconds. Must be greater than 0 and a multiple of 10.

**返回** BLE Mesh transmit value that can be used e.g. for the default values of the Configuration Model data.

**ESP\_BLE\_MESH\_GET\_TRANSMIT\_COUNT** (transmit)

Decode transmit count from a transmit value.

#### 参数

- **transmit** -- Encoded transmit count & interval value.

**返回** Transmission count (actual transmissions equal to N + 1).

**ESP\_BLE\_MESH\_GET\_TRANSMIT\_INTERVAL** (transmit)

Decode transmit interval from a transmit value.

#### 参数

- **transmit** -- Encoded transmit count & interval value.

**返回** Transmission interval in milliseconds.

**ESP\_BLE\_MESH\_PUBLISH\_TRANSMIT** (count, int\_ms)

Encode Publish Retransmit count & interval steps.

**参数**

- **count** -- Number of retransmissions (first transmission is excluded).
- **int\_ms** -- Interval steps in milliseconds. Must be greater than 0 and a multiple of 50.

**返回** BLE Mesh transmit value that can be used e.g. for the default values of the Configuration Model data.

**ESP\_BLE\_MESH\_GET\_PUBLISH\_TRANSMIT\_COUNT** (transmit)

Decode Publish Retransmit count from a given value.

**参数**

- **transmit** -- Encoded Publish Retransmit count & interval value.

**返回** Retransmission count (actual transmissions equal to N + 1).

**ESP\_BLE\_MESH\_GET\_PUBLISH\_TRANSMIT\_INTERVAL** (transmit)

Decode Publish Retransmit interval from a given value.

Callbacks which are not needed to be initialized by users (set with 0 and will be initialized internally)

**参数**

- **transmit** -- Encoded Publish Retransmit count & interval value.

**返回** Transmission interval in milliseconds.

**ESP\_BLE\_MESH\_PROV\_STATIC\_OOB\_MAX\_LEN**

Maximum length of string used by Output OOB authentication

**ESP\_BLE\_MESH\_PROV\_OUTPUT\_OOB\_MAX\_LEN**

Maximum length of string used by Output OOB authentication

**ESP\_BLE\_MESH\_PROV\_INPUT\_OOB\_MAX\_LEN**

Macros used to define message opcode

**ESP\_BLE\_MESH\_MODEL\_OP\_1** (b0)

**ESP\_BLE\_MESH\_MODEL\_OP\_2** (b0, b1)

**ESP\_BLE\_MESH\_MODEL\_OP\_3** (b0, cid)

This macro is associated with BLE\_MESH\_MODEL\_CB in mesh\_access.h

**ESP\_BLE\_MESH\_SIG\_MODEL** (\_id, \_op, \_pub, \_user\_data)

This macro is associated with BLE\_MESH\_MODEL\_VND\_CB in mesh\_access.h

**ESP\_BLE\_MESH\_VENDOR\_MODEL** (\_company, \_id, \_op, \_pub, \_user\_data)

**ESP\_BLE\_MESH\_ELEMENT** (\_loc, \_mods, \_vnd\_mods)

Helper to define a BLE Mesh element within an array.

In case the element has no SIG or Vendor models, the helper macro ESP\_BLE\_MESH\_MODEL\_NONE can be given instead.

---

**备注:** This macro is associated with BLE\_MESH\_ELEM in mesh\_access.h

---

**参数**

- **\_loc** -- Location Descriptor.
- **\_mods** -- Array of SIG models.
- **\_vnd\_mods** -- Array of vendor models.

**ESP\_BLE\_MESH\_PROV** (uuid, sta\_val, sta\_val\_len, out\_size, out\_act, in\_size, in\_act)

**BT\_OCTET32\_LEN**

**BD\_ADDR\_LEN**

**ESP\_BLE\_MESH\_ADDR\_TYPE\_PUBLIC**

**ESP\_BLE\_MESH\_ADDR\_TYPE\_RANDOM**

**ESP\_BLE\_MESH\_ADDR\_TYPE\_RPA\_PUBLIC**

**ESP\_BLE\_MESH\_ADDR\_TYPE\_RPA\_RANDOM**

**ESP\_BLE\_MESH\_DIRECTED\_FORWARDING\_DISABLED**

**ESP\_BLE\_MESH\_DIRECTED\_FORWARDING\_ENABLED**

**ESP\_BLE\_MESH\_DIRECTED\_RELAY\_DISABLED**

**ESP\_BLE\_MESH\_DIRECTED\_RELAY\_ENABLED**

**ESP\_BLE\_MESH\_DIRECTED\_PROXY\_IGNORE**

**ESP\_BLE\_MESH\_DIRECTED\_PROXY\_USE\_DEFAULT\_IGNORE**

**ESP\_BLE\_MESH\_DIRECTED\_FRIEND\_IGNORE**

**ESP\_BLE\_MESH\_DIRECTED\_PROXY\_DISABLED**

**ESP\_BLE\_MESH\_DIRECTED\_PROXY\_ENABLED**

**ESP\_BLE\_MESH\_DIRECTED\_PROXY\_NOT\_SUPPORTED**

**ESP\_BLE\_MESH\_DIRECTED\_PROXY\_USE\_DEF\_DISABLED**

**ESP\_BLE\_MESH\_DIRECTED\_PROXY\_USE\_DEF\_ENABLED**

**ESP\_BLE\_MESH\_DIRECTED\_PROXY\_USE\_DEF\_NOT\_SUPPORTED**

**ESP\_BLE\_MESH\_DIRECTED\_FRIEND\_DISABLED**

**ESP\_BLE\_MESH\_DIRECTED\_FRIEND\_ENABLED**

**ESP\_BLE\_MESH\_DIRECTED\_FRIEND\_NOT\_SUPPORTED**

**ESP\_BLE\_MESH\_DIRECTED\_PUB\_POLICY\_FLOODING**

**ESP\_BLE\_MESH\_DIRECTED\_PUB\_POLICY\_FORWARD**

**ESP\_BLE\_MESH\_PROXY\_USE\_DIRECTED\_DISABLED**

**ESP\_BLE\_MESH\_PROXY\_USE\_DIRECTED\_ENABLED**

**ESP\_BLE\_MESH\_FLOODING\_CRED**

**ESP\_BLE\_MESH\_FRIENDSHIP\_CRED**

**ESP\_BLE\_MESH\_DIRECTED\_CRED**

**ESP\_BLE\_MESH\_TAG\_SEND\_SEGMENTED**

**ESP\_BLE\_MESH\_TAG\_IMMUTABLE\_CRED**

**ESP\_BLE\_MESH\_TAG\_USE\_DIRECTED**

**ESP\_BLE\_MESH\_TAG\_RELAY**

**ESP\_BLE\_MESH\_TAG\_FRIENDSHIP**

**ESP\_BLE\_MESH\_SEG\_SZMIC\_SHORT**

**ESP\_BLE\_MESH\_SEG\_SZMIC\_LONG**

**ESP\_BLE\_MESH\_MODEL\_PUB\_DEFINE** (*\_name*, *\_msg\_len*, *\_role*)

Define a model publication context.

**参数**

- **\_name** -- Variable name given to the context.
- **\_msg\_len** -- Length of the publication message.
- **\_role** -- Role of the device which contains the model.

**ESP\_BLE\_MESH\_MODEL\_OP** (*\_opcode*, *\_min\_len*)

Define a model operation context.

**参数**

- **\_opcode** -- Message opcode.
- **\_min\_len** -- Message minimum length.

**ESP\_BLE\_MESH\_MODEL\_OP\_END**

Define the terminator for the model operation table. Each model operation struct array must use this terminator as the end tag of the operation unit.

**ESP\_BLE\_MESH\_MODEL\_NONE**

Helper to define an empty model array. This structure is associated with BLE\_MESH\_MODEL\_NONE in mesh\_access.h

**ADD\_DEV\_RM\_AFTER\_PROV\_FLAG**

Device will be removed from queue after provisioned successfully

**ADD\_DEV\_START\_PROV\_NOW\_FLAG**

Start provisioning device immediately

**ADD\_DEV\_FLUSHABLE\_DEV\_FLAG**

Device can be remove when queue is full and new device is going to added

**DEL\_DEV\_ADDR\_FLAG**

**DEL\_DEV\_UUID\_FLAG**

**PROV\_DATA\_NET\_IDX\_FLAG**

**PROV\_DATA\_FLAGS\_FLAG**

**PROV\_DATA\_IV\_INDEX\_FLAG**

**ESP\_BLE\_MESH\_HEARTBEAT\_FILTER\_ACCEPTLIST**

**ESP\_BLE\_MESH\_HEARTBEAT\_FILTER\_REJECTLIST**

Provisioner heartbeat filter operation

**ESP\_BLE\_MESH\_HEARTBEAT\_FILTER\_ADD**

**ESP\_BLE\_MESH\_HEARTBEAT\_FILTER\_REMOVE**

**ESP\_BLE\_MESH\_MODEL\_ID\_CONFIG\_SRV**

BLE Mesh models related Model ID and Opcode definitions.

< Foundation Models

**ESP\_BLE\_MESH\_MODEL\_ID\_CONFIG\_CLI**

**ESP\_BLE\_MESH\_MODEL\_ID\_HEALTH\_SRV**

**ESP\_BLE\_MESH\_MODEL\_ID\_HEALTH\_CLI**

**ESP\_BLE\_MESH\_MODEL\_ID\_RPR\_SRV**

**ESP\_BLE\_MESH\_MODEL\_ID\_RPR\_CLI**

**ESP\_BLE\_MESH\_MODEL\_ID\_DF\_SRV**

**ESP\_BLE\_MESH\_MODEL\_ID\_DF\_CLI**

ESP\_BLE\_MESH\_MODEL\_ID\_BRC\_SRV

ESP\_BLE\_MESH\_MODEL\_ID\_BRC\_CLI

ESP\_BLE\_MESH\_MODEL\_ID\_PRB\_SRV

ESP\_BLE\_MESH\_MODEL\_ID\_PRB\_CLI

ESP\_BLE\_MESH\_MODEL\_ID\_ODP\_SRV

ESP\_BLE\_MESH\_MODEL\_ID\_ODP\_CLI

ESP\_BLE\_MESH\_MODEL\_ID\_SAR\_SRV

ESP\_BLE\_MESH\_MODEL\_ID\_SAR\_CLI

ESP\_BLE\_MESH\_MODEL\_ID\_AGG\_SRV

ESP\_BLE\_MESH\_MODEL\_ID\_AGG\_CLI

ESP\_BLE\_MESH\_MODEL\_ID\_LCD\_SRV

ESP\_BLE\_MESH\_MODEL\_ID\_LCD\_CLI

ESP\_BLE\_MESH\_MODEL\_ID\_SRPL\_SRV

ESP\_BLE\_MESH\_MODEL\_ID\_SRPL\_CLI

Models from the Mesh Model Specification

ESP\_BLE\_MESH\_MODEL\_ID\_GEN\_ONOFF\_SRV

ESP\_BLE\_MESH\_MODEL\_ID\_GEN\_ONOFF\_CLI

ESP\_BLE\_MESH\_MODEL\_ID\_GEN\_LEVEL\_SRV

ESP\_BLE\_MESH\_MODEL\_ID\_GEN\_LEVEL\_CLI

ESP\_BLE\_MESH\_MODEL\_ID\_GEN\_DEF\_TRANS\_TIME\_SRV

ESP\_BLE\_MESH\_MODEL\_ID\_GEN\_DEF\_TRANS\_TIME\_CLI

ESP\_BLE\_MESH\_MODEL\_ID\_GEN\_POWER\_ONOFF\_SRV

ESP\_BLE\_MESH\_MODEL\_ID\_GEN\_POWER\_ONOFF\_SETUP\_SRV



ESP\_BLE\_MESH\_MODEL\_ID\_GEN\_POWER\_ONOFF\_CLI

ESP\_BLE\_MESH\_MODEL\_ID\_GEN\_POWER\_LEVEL\_SRV

ESP\_BLE\_MESH\_MODEL\_ID\_GEN\_POWER\_LEVEL\_SETUP\_SRV

ESP\_BLE\_MESH\_MODEL\_ID\_GEN\_POWER\_LEVEL\_CLI

ESP\_BLE\_MESH\_MODEL\_ID\_GEN\_BATTERY\_SRV

ESP\_BLE\_MESH\_MODEL\_ID\_GEN\_BATTERY\_CLI

ESP\_BLE\_MESH\_MODEL\_ID\_GEN\_LOCATION\_SRV

ESP\_BLE\_MESH\_MODEL\_ID\_GEN\_LOCATION\_SETUP\_SRV

ESP\_BLE\_MESH\_MODEL\_ID\_GEN\_LOCATION\_CLI

ESP\_BLE\_MESH\_MODEL\_ID\_GEN\_ADMIN\_PROP\_SRV

ESP\_BLE\_MESH\_MODEL\_ID\_GEN\_MANUFACTURER\_PROP\_SRV

ESP\_BLE\_MESH\_MODEL\_ID\_GEN\_USER\_PROP\_SRV

ESP\_BLE\_MESH\_MODEL\_ID\_GEN\_CLIENT\_PROP\_SRV

ESP\_BLE\_MESH\_MODEL\_ID\_GEN\_PROP\_CLI

ESP\_BLE\_MESH\_MODEL\_ID\_SENSOR\_SRV

ESP\_BLE\_MESH\_MODEL\_ID\_SENSOR\_SETUP\_SRV

ESP\_BLE\_MESH\_MODEL\_ID\_SENSOR\_CLI

ESP\_BLE\_MESH\_MODEL\_ID\_TIME\_SRV

ESP\_BLE\_MESH\_MODEL\_ID\_TIME\_SETUP\_SRV

ESP\_BLE\_MESH\_MODEL\_ID\_TIME\_CLI

ESP\_BLE\_MESH\_MODEL\_ID\_SCENE\_SRV

ESP\_BLE\_MESH\_MODEL\_ID\_SCENE\_SETUP\_SRV

ESP\_BLE\_MESH\_MODEL\_ID\_SCENE\_CLI

ESP\_BLE\_MESH\_MODEL\_ID\_SCHEDULER\_SRV

ESP\_BLE\_MESH\_MODEL\_ID\_SCHEDULER\_SETUP\_SRV

ESP\_BLE\_MESH\_MODEL\_ID\_SCHEDULER\_CLI

ESP\_BLE\_MESH\_MODEL\_ID\_LIGHT\_LIGHTNESS\_SRV

ESP\_BLE\_MESH\_MODEL\_ID\_LIGHT\_LIGHTNESS\_SETUP\_SRV

ESP\_BLE\_MESH\_MODEL\_ID\_LIGHT\_LIGHTNESS\_CLI

ESP\_BLE\_MESH\_MODEL\_ID\_LIGHT\_CTL\_SRV

ESP\_BLE\_MESH\_MODEL\_ID\_LIGHT\_CTL\_SETUP\_SRV

ESP\_BLE\_MESH\_MODEL\_ID\_LIGHT\_CTL\_CLI

ESP\_BLE\_MESH\_MODEL\_ID\_LIGHT\_CTL\_TEMP\_SRV

ESP\_BLE\_MESH\_MODEL\_ID\_LIGHT\_HSL\_SRV

ESP\_BLE\_MESH\_MODEL\_ID\_LIGHT\_HSL\_SETUP\_SRV

ESP\_BLE\_MESH\_MODEL\_ID\_LIGHT\_HSL\_CLI

ESP\_BLE\_MESH\_MODEL\_ID\_LIGHT\_HSL\_HUE\_SRV

ESP\_BLE\_MESH\_MODEL\_ID\_LIGHT\_HSL\_SAT\_SRV

ESP\_BLE\_MESH\_MODEL\_ID\_LIGHT\_XYL\_SRV

ESP\_BLE\_MESH\_MODEL\_ID\_LIGHT\_XYL\_SETUP\_SRV

ESP\_BLE\_MESH\_MODEL\_ID\_LIGHT\_XYL\_CLI

ESP\_BLE\_MESH\_MODEL\_ID\_LIGHT\_LC\_SRV

ESP\_BLE\_MESH\_MODEL\_ID\_LIGHT\_LC\_SETUP\_SRV

ESP\_BLE\_MESH\_MODEL\_ID\_LIGHT\_LC\_CLI

ESP\_BLE\_MESH\_MODEL\_ID\_MBT\_SRV

ESP\_BLE\_MESH\_MODEL\_ID\_MBT\_CLI

**ESP\_BLE\_MESH\_MODEL\_OP\_BEACON\_GET**

Config Beacon Get

**ESP\_BLE\_MESH\_MODEL\_OP\_COMPOSITION\_DATA\_GET**

Config Composition Data Get

**ESP\_BLE\_MESH\_MODEL\_OP\_DEFAULT\_TTL\_GET**

Config Default TTL Get

**ESP\_BLE\_MESH\_MODEL\_OP\_GATT\_PROXY\_GET**

Config GATT Proxy Get

**ESP\_BLE\_MESH\_MODEL\_OP\_RELAY\_GET**

Config Relay Get

**ESP\_BLE\_MESH\_MODEL\_OP\_MODEL\_PUB\_GET**

Config Model Publication Get

**ESP\_BLE\_MESH\_MODEL\_OP\_FRIEND\_GET**

Config Friend Get

**ESP\_BLE\_MESH\_MODEL\_OP\_HEARTBEAT\_PUB\_GET**

Config Heartbeat Publication Get

**ESP\_BLE\_MESH\_MODEL\_OP\_HEARTBEAT\_SUB\_GET**

Config Heartbeat Subscription Get

**ESP\_BLE\_MESH\_MODEL\_OP\_NET\_KEY\_GET**

Config NetKey Get

**ESP\_BLE\_MESH\_MODEL\_OP\_APP\_KEY\_GET**

Config AppKey Get

**ESP\_BLE\_MESH\_MODEL\_OP\_NODE\_IDENTITY\_GET**

Config Node Identity Get

**ESP\_BLE\_MESH\_MODEL\_OP\_SIG\_MODEL\_SUB\_GET**

Config SIG Model Subscription Get

**ESP\_BLE\_MESH\_MODEL\_OP\_VENDOR\_MODEL\_SUB\_GET**

Config Vendor Model Subscription Get

**ESP\_BLE\_MESH\_MODEL\_OP\_SIG\_MODEL\_APP\_GET**

Config SIG Model App Get

**ESP\_BLE\_MESH\_MODEL\_OP\_VENDOR\_MODEL\_APP\_GET**

Config Vendor Model App Get

**ESP\_BLE\_MESH\_MODEL\_OP\_KEY\_REFRESH\_PHASE\_GET**

Config Key Refresh Phase Get

**ESP\_BLE\_MESH\_MODEL\_OP\_LPN\_POLLTIMEOUT\_GET**

Config Low Power Node PollTimeout Get

**ESP\_BLE\_MESH\_MODEL\_OP\_NETWORK\_TRANSMIT\_GET**

Config Network Transmit Get

**ESP\_BLE\_MESH\_MODEL\_OP\_BEACON\_SET**

Config Beacon Set

**ESP\_BLE\_MESH\_MODEL\_OP\_DEFAULT\_TTL\_SET**

Config Default TTL Set

**ESP\_BLE\_MESH\_MODEL\_OP\_GATT\_PROXY\_SET**

Config GATT Proxy Set

**ESP\_BLE\_MESH\_MODEL\_OP\_RELAY\_SET**

Config Relay Set

**ESP\_BLE\_MESH\_MODEL\_OP\_MODEL\_PUB\_SET**

Config Model Publication Set

**ESP\_BLE\_MESH\_MODEL\_OP\_MODEL\_SUB\_ADD**

Config Model Subscription Add

**ESP\_BLE\_MESH\_MODEL\_OP\_MODEL\_SUB\_VIRTUAL\_ADDR\_ADD**

Config Model Subscription Virtual Address Add

**ESP\_BLE\_MESH\_MODEL\_OP\_MODEL\_SUB\_DELETE**

Config Model Subscription Delete

**ESP\_BLE\_MESH\_MODEL\_OP\_MODEL\_SUB\_VIRTUAL\_ADDR\_DELETE**

Config Model Subscription Virtual Address Delete

**ESP\_BLE\_MESH\_MODEL\_OP\_MODEL\_SUB\_OVERWRITE**

Config Model Subscription Overwrite

**ESP\_BLE\_MESH\_MODEL\_OP\_MODEL\_SUB\_VIRTUAL\_ADDR\_OVERWRITE**

Config Model Subscription Virtual Address Overwrite

**ESP\_BLE\_MESH\_MODEL\_OP\_NET\_KEY\_ADD**

Config NetKey Add

**ESP\_BLE\_MESH\_MODEL\_OP\_APP\_KEY\_ADD**

Config AppKey Add

**ESP\_BLE\_MESH\_MODEL\_OP\_MODEL\_APP\_BIND**

Config Model App Bind

**ESP\_BLE\_MESH\_MODEL\_OP\_NODE\_RESET**

Config Node Reset

**ESP\_BLE\_MESH\_MODEL\_OP\_FRIEND\_SET**

Config Friend Set

**ESP\_BLE\_MESH\_MODEL\_OP\_HEARTBEAT\_PUB\_SET**

Config Heartbeat Publication Set

**ESP\_BLE\_MESH\_MODEL\_OP\_HEARTBEAT\_SUB\_SET**

Config Heartbeat Subscription Set

**ESP\_BLE\_MESH\_MODEL\_OP\_NET\_KEY\_UPDATE**

Config NetKey Update

**ESP\_BLE\_MESH\_MODEL\_OP\_NET\_KEY\_DELETE**

Config NetKey Delete

**ESP\_BLE\_MESH\_MODEL\_OP\_APP\_KEY\_UPDATE**

Config AppKey Update

**ESP\_BLE\_MESH\_MODEL\_OP\_APP\_KEY\_DELETE**

Config AppKey Delete

**ESP\_BLE\_MESH\_MODEL\_OP\_NODE\_IDENTITY\_SET**

Config Node Identity Set

**ESP\_BLE\_MESH\_MODEL\_OP\_KEY\_REFRESH\_PHASE\_SET**

Config Key Refresh Phase Set

**ESP\_BLE\_MESH\_MODEL\_OP\_MODEL\_PUB\_VIRTUAL\_ADDR\_SET**

Config Model Publication Virtual Address Set

**ESP\_BLE\_MESH\_MODEL\_OP\_MODEL\_SUB\_DELETE\_ALL**

Config Model Subscription Delete All

**ESP\_BLE\_MESH\_MODEL\_OP\_MODEL\_APP\_UNBIND**

Config Model App Unbind

**ESP\_BLE\_MESH\_MODEL\_OP\_NETWORK\_TRANSMIT\_SET**

Config Network Transmit Set

**ESP\_BLE\_MESH\_MODEL\_OP\_BEACON\_STATUS**

**ESP\_BLE\_MESH\_MODEL\_OP\_COMPOSITION\_DATA\_STATUS**

ESP\_BLE\_MESH\_MODEL\_OP\_DEFAULT\_TTL\_STATUS

ESP\_BLE\_MESH\_MODEL\_OP\_GATT\_PROXY\_STATUS

ESP\_BLE\_MESH\_MODEL\_OP\_RELAY\_STATUS

ESP\_BLE\_MESH\_MODEL\_OP\_MODEL\_PUB\_STATUS

ESP\_BLE\_MESH\_MODEL\_OP\_MODEL\_SUB\_STATUS

ESP\_BLE\_MESH\_MODEL\_OP\_SIG\_MODEL\_SUB\_LIST

ESP\_BLE\_MESH\_MODEL\_OP\_VENDOR\_MODEL\_SUB\_LIST

ESP\_BLE\_MESH\_MODEL\_OP\_NET\_KEY\_STATUS

ESP\_BLE\_MESH\_MODEL\_OP\_NET\_KEY\_LIST

ESP\_BLE\_MESH\_MODEL\_OP\_APP\_KEY\_STATUS

ESP\_BLE\_MESH\_MODEL\_OP\_APP\_KEY\_LIST

ESP\_BLE\_MESH\_MODEL\_OP\_NODE\_IDENTITY\_STATUS

ESP\_BLE\_MESH\_MODEL\_OP\_MODEL\_APP\_STATUS

ESP\_BLE\_MESH\_MODEL\_OP\_SIG\_MODEL\_APP\_LIST

ESP\_BLE\_MESH\_MODEL\_OP\_VENDOR\_MODEL\_APP\_LIST

ESP\_BLE\_MESH\_MODEL\_OP\_NODE\_RESET\_STATUS

ESP\_BLE\_MESH\_MODEL\_OP\_FRIEND\_STATUS

ESP\_BLE\_MESH\_MODEL\_OP\_KEY\_REFRESH\_PHASE\_STATUS

ESP\_BLE\_MESH\_MODEL\_OP\_HEARTBEAT\_PUB\_STATUS

ESP\_BLE\_MESH\_MODEL\_OP\_HEARTBEAT\_SUB\_STATUS

ESP\_BLE\_MESH\_MODEL\_OP\_LPN\_POLLTIMEOUT\_STATUS

ESP\_BLE\_MESH\_MODEL\_OP\_NETWORK\_TRANSMIT\_STATUS

ESP\_BLE\_MESH\_CFG\_STATUS\_SUCCESS

ESP\_BLE\_MESH\_CFG\_STATUS\_INVALID\_ADDRESS

ESP\_BLE\_MESH\_CFG\_STATUS\_INVALID\_MODEL

ESP\_BLE\_MESH\_CFG\_STATUS\_INVALID\_APPKEY

ESP\_BLE\_MESH\_CFG\_STATUS\_INVALID\_NETKEY

ESP\_BLE\_MESH\_CFG\_STATUS\_INSUFFICIENT\_RESOURCES

ESP\_BLE\_MESH\_CFG\_STATUS\_KEY\_INDEX\_ALREADY\_STORED

ESP\_BLE\_MESH\_CFG\_STATUS\_INVALID\_PUBLISH\_PARAMETERS

ESP\_BLE\_MESH\_CFG\_STATUS\_NOT\_A\_SUBSCRIBE\_MODEL

ESP\_BLE\_MESH\_CFG\_STATUS\_STORAGE\_FAILURE

ESP\_BLE\_MESH\_CFG\_STATUS\_FEATURE\_NOT\_SUPPORTED

ESP\_BLE\_MESH\_CFG\_STATUS\_CANNOT\_UPDATE

ESP\_BLE\_MESH\_CFG\_STATUS\_CANNOT\_REMOVE

ESP\_BLE\_MESH\_CFG\_STATUS\_CANNOT\_BIND

ESP\_BLE\_MESH\_CFG\_STATUS\_TEMP\_UNABLE\_TO\_CHANGE\_STATE

ESP\_BLE\_MESH\_CFG\_STATUS\_CANNOT\_SET

ESP\_BLE\_MESH\_CFG\_STATUS\_UNSPECIFIED\_ERROR

ESP\_BLE\_MESH\_CFG\_STATUS\_INVALID\_BINDING

ESP\_BLE\_MESH\_CFG\_STATUS\_INVALID\_PATH\_ENTRY

ESP\_BLE\_MESH\_CFG\_STATUS\_CANNOT\_GET

ESP\_BLE\_MESH\_CFG\_STATUS\_OBSOLETE\_INFO

ESP\_BLE\_MESH\_CFG\_STATUS\_INVALID\_BEARER

ESP\_BLE\_MESH\_MODEL\_OP\_HEALTH\_FAULT\_GET

Health Fault Get

**ESP\_BLE\_MESH\_MODEL\_OP\_HEALTH\_PERIOD\_GET**

Health Period Get

**ESP\_BLE\_MESH\_MODEL\_OP\_ATTENTION\_GET**

Health Attention Get

**ESP\_BLE\_MESH\_MODEL\_OP\_HEALTH\_FAULT\_CLEAR**

Health Fault Clear

**ESP\_BLE\_MESH\_MODEL\_OP\_HEALTH\_FAULT\_CLEAR\_UNACK**

Health Fault Clear Unacknowledged

**ESP\_BLE\_MESH\_MODEL\_OP\_HEALTH\_FAULT\_TEST**

Health Fault Test

**ESP\_BLE\_MESH\_MODEL\_OP\_HEALTH\_FAULT\_TEST\_UNACK**

Health Fault Test Unacknowledged

**ESP\_BLE\_MESH\_MODEL\_OP\_HEALTH\_PERIOD\_SET**

Health Period Set

**ESP\_BLE\_MESH\_MODEL\_OP\_HEALTH\_PERIOD\_SET\_UNACK**

Health Period Set Unacknowledged

**ESP\_BLE\_MESH\_MODEL\_OP\_ATTENTION\_SET**

Health Attention Set

**ESP\_BLE\_MESH\_MODEL\_OP\_ATTENTION\_SET\_UNACK**

Health Attention Set Unacknowledged

**ESP\_BLE\_MESH\_MODEL\_OP\_HEALTH\_CURRENT\_STATUS**

**ESP\_BLE\_MESH\_MODEL\_OP\_HEALTH\_FAULT\_STATUS**

**ESP\_BLE\_MESH\_MODEL\_OP\_HEALTH\_PERIOD\_STATUS**

**ESP\_BLE\_MESH\_MODEL\_OP\_ATTENTION\_STATUS**

**ESP\_BLE\_MESH\_MODEL\_OP\_GEN\_ONOFF\_GET**

**ESP\_BLE\_MESH\_MODEL\_OP\_GEN\_ONOFF\_SET**

**ESP\_BLE\_MESH\_MODEL\_OP\_GEN\_ONOFF\_SET\_UNACK**

**ESP\_BLE\_MESH\_MODEL\_OP\_GEN\_ONOFF\_STATUS**

Generic Level Message Opcode



ESP\_BLE\_MESH\_MODEL\_OP\_GEN\_LEVEL\_GET

ESP\_BLE\_MESH\_MODEL\_OP\_GEN\_LEVEL\_SET

ESP\_BLE\_MESH\_MODEL\_OP\_GEN\_LEVEL\_SET\_UNACK

ESP\_BLE\_MESH\_MODEL\_OP\_GEN\_LEVEL\_STATUS

ESP\_BLE\_MESH\_MODEL\_OP\_GEN\_DELTA\_SET

ESP\_BLE\_MESH\_MODEL\_OP\_GEN\_DELTA\_SET\_UNACK

ESP\_BLE\_MESH\_MODEL\_OP\_GEN\_MOVE\_SET

ESP\_BLE\_MESH\_MODEL\_OP\_GEN\_MOVE\_SET\_UNACK

Generic Default Transition Time Message Opcode

ESP\_BLE\_MESH\_MODEL\_OP\_GEN\_DEF\_TRANS\_TIME\_GET

ESP\_BLE\_MESH\_MODEL\_OP\_GEN\_DEF\_TRANS\_TIME\_SET

ESP\_BLE\_MESH\_MODEL\_OP\_GEN\_DEF\_TRANS\_TIME\_SET\_UNACK

ESP\_BLE\_MESH\_MODEL\_OP\_GEN\_DEF\_TRANS\_TIME\_STATUS

Generic Power OnOff Message Opcode

ESP\_BLE\_MESH\_MODEL\_OP\_GEN\_ONPOWERUP\_GET

ESP\_BLE\_MESH\_MODEL\_OP\_GEN\_ONPOWERUP\_STATUS

Generic Power OnOff Setup Message Opcode

ESP\_BLE\_MESH\_MODEL\_OP\_GEN\_ONPOWERUP\_SET

ESP\_BLE\_MESH\_MODEL\_OP\_GEN\_ONPOWERUP\_SET\_UNACK

Generic Power Level Message Opcode

ESP\_BLE\_MESH\_MODEL\_OP\_GEN\_POWER\_LEVEL\_GET

ESP\_BLE\_MESH\_MODEL\_OP\_GEN\_POWER\_LEVEL\_SET

ESP\_BLE\_MESH\_MODEL\_OP\_GEN\_POWER\_LEVEL\_SET\_UNACK

ESP\_BLE\_MESH\_MODEL\_OP\_GEN\_POWER\_LEVEL\_STATUS

ESP\_BLE\_MESH\_MODEL\_OP\_GEN\_POWER\_LAST\_GET

**ESP\_BLE\_MESH\_MODEL\_OP\_GEN\_POWER\_LAST\_STATUS**

**ESP\_BLE\_MESH\_MODEL\_OP\_GEN\_POWER\_DEFAULT\_GET**

**ESP\_BLE\_MESH\_MODEL\_OP\_GEN\_POWER\_DEFAULT\_STATUS**

**ESP\_BLE\_MESH\_MODEL\_OP\_GEN\_POWER\_RANGE\_GET**

**ESP\_BLE\_MESH\_MODEL\_OP\_GEN\_POWER\_RANGE\_STATUS**

Generic Power Level Setup Message Opcode

**ESP\_BLE\_MESH\_MODEL\_OP\_GEN\_POWER\_DEFAULT\_SET**

**ESP\_BLE\_MESH\_MODEL\_OP\_GEN\_POWER\_DEFAULT\_SET\_UNACK**

**ESP\_BLE\_MESH\_MODEL\_OP\_GEN\_POWER\_RANGE\_SET**

**ESP\_BLE\_MESH\_MODEL\_OP\_GEN\_POWER\_RANGE\_SET\_UNACK**

Generic Battery Message Opcode

**ESP\_BLE\_MESH\_MODEL\_OP\_GEN\_BATTERY\_GET**

**ESP\_BLE\_MESH\_MODEL\_OP\_GEN\_BATTERY\_STATUS**

Generic Location Message Opcode

**ESP\_BLE\_MESH\_MODEL\_OP\_GEN\_LOC\_GLOBAL\_GET**

**ESP\_BLE\_MESH\_MODEL\_OP\_GEN\_LOC\_GLOBAL\_STATUS**

**ESP\_BLE\_MESH\_MODEL\_OP\_GEN\_LOC\_LOCAL\_GET**

**ESP\_BLE\_MESH\_MODEL\_OP\_GEN\_LOC\_LOCAL\_STATUS**

Generic Location Setup Message Opcode

**ESP\_BLE\_MESH\_MODEL\_OP\_GEN\_LOC\_GLOBAL\_SET**

**ESP\_BLE\_MESH\_MODEL\_OP\_GEN\_LOC\_GLOBAL\_SET\_UNACK**

**ESP\_BLE\_MESH\_MODEL\_OP\_GEN\_LOC\_LOCAL\_SET**

**ESP\_BLE\_MESH\_MODEL\_OP\_GEN\_LOC\_LOCAL\_SET\_UNACK**

Generic Manufacturer Property Message Opcode

**ESP\_BLE\_MESH\_MODEL\_OP\_GEN\_MANUFACTURER\_PROPERTIES\_GET**

**ESP\_BLE\_MESH\_MODEL\_OP\_GEN\_MANUFACTURER\_PROPERTIES\_STATUS**

ESP\_BLE\_MESH\_MODEL\_OP\_GEN\_MANUFACTURER\_PROPERTY\_GET

ESP\_BLE\_MESH\_MODEL\_OP\_GEN\_MANUFACTURER\_PROPERTY\_SET

ESP\_BLE\_MESH\_MODEL\_OP\_GEN\_MANUFACTURER\_PROPERTY\_SET\_UNACK

ESP\_BLE\_MESH\_MODEL\_OP\_GEN\_MANUFACTURER\_PROPERTY\_STATUS

Generic Admin Property Message Opcode

ESP\_BLE\_MESH\_MODEL\_OP\_GEN\_ADMIN\_PROPERTIES\_GET

ESP\_BLE\_MESH\_MODEL\_OP\_GEN\_ADMIN\_PROPERTIES\_STATUS

ESP\_BLE\_MESH\_MODEL\_OP\_GEN\_ADMIN\_PROPERTY\_GET

ESP\_BLE\_MESH\_MODEL\_OP\_GEN\_ADMIN\_PROPERTY\_SET

ESP\_BLE\_MESH\_MODEL\_OP\_GEN\_ADMIN\_PROPERTY\_SET\_UNACK

ESP\_BLE\_MESH\_MODEL\_OP\_GEN\_ADMIN\_PROPERTY\_STATUS

Generic User Property Message Opcode

ESP\_BLE\_MESH\_MODEL\_OP\_GEN\_USER\_PROPERTIES\_GET

ESP\_BLE\_MESH\_MODEL\_OP\_GEN\_USER\_PROPERTIES\_STATUS

ESP\_BLE\_MESH\_MODEL\_OP\_GEN\_USER\_PROPERTY\_GET

ESP\_BLE\_MESH\_MODEL\_OP\_GEN\_USER\_PROPERTY\_SET

ESP\_BLE\_MESH\_MODEL\_OP\_GEN\_USER\_PROPERTY\_SET\_UNACK

ESP\_BLE\_MESH\_MODEL\_OP\_GEN\_USER\_PROPERTY\_STATUS

Generic Client Property Message Opcode

ESP\_BLE\_MESH\_MODEL\_OP\_GEN\_CLIENT\_PROPERTIES\_GET

ESP\_BLE\_MESH\_MODEL\_OP\_GEN\_CLIENT\_PROPERTIES\_STATUS

ESP\_BLE\_MESH\_MODEL\_OP\_SENSOR\_DESCRIPTOR\_GET

ESP\_BLE\_MESH\_MODEL\_OP\_SENSOR\_DESCRIPTOR\_STATUS

ESP\_BLE\_MESH\_MODEL\_OP\_SENSOR\_GET

ESP\_BLE\_MESH\_MODEL\_OP\_SENSOR\_STATUS

ESP\_BLE\_MESH\_MODEL\_OP\_SENSOR\_COLUMN\_GET

ESP\_BLE\_MESH\_MODEL\_OP\_SENSOR\_COLUMN\_STATUS

ESP\_BLE\_MESH\_MODEL\_OP\_SENSOR\_SERIES\_GET

ESP\_BLE\_MESH\_MODEL\_OP\_SENSOR\_SERIES\_STATUS

Sensor Setup Message Opcode

ESP\_BLE\_MESH\_MODEL\_OP\_SENSOR\_CADENCE\_GET

ESP\_BLE\_MESH\_MODEL\_OP\_SENSOR\_CADENCE\_SET

ESP\_BLE\_MESH\_MODEL\_OP\_SENSOR\_CADENCE\_SET\_UNACK

ESP\_BLE\_MESH\_MODEL\_OP\_SENSOR\_CADENCE\_STATUS

ESP\_BLE\_MESH\_MODEL\_OP\_SENSOR\_SETTINGS\_GET

ESP\_BLE\_MESH\_MODEL\_OP\_SENSOR\_SETTINGS\_STATUS

ESP\_BLE\_MESH\_MODEL\_OP\_SENSOR\_SETTING\_GET

ESP\_BLE\_MESH\_MODEL\_OP\_SENSOR\_SETTING\_SET

ESP\_BLE\_MESH\_MODEL\_OP\_SENSOR\_SETTING\_SET\_UNACK

ESP\_BLE\_MESH\_MODEL\_OP\_SENSOR\_SETTING\_STATUS

ESP\_BLE\_MESH\_MODEL\_OP\_TIME\_GET

ESP\_BLE\_MESH\_MODEL\_OP\_TIME\_SET

ESP\_BLE\_MESH\_MODEL\_OP\_TIME\_STATUS

ESP\_BLE\_MESH\_MODEL\_OP\_TIME\_ROLE\_GET

ESP\_BLE\_MESH\_MODEL\_OP\_TIME\_ROLE\_SET

ESP\_BLE\_MESH\_MODEL\_OP\_TIME\_ROLE\_STATUS

ESP\_BLE\_MESH\_MODEL\_OP\_TIME\_ZONE\_GET

ESP\_BLE\_MESH\_MODEL\_OP\_TIME\_ZONE\_SET

**ESP\_BLE\_MESH\_MODEL\_OP\_TIME\_ZONE\_STATUS**

**ESP\_BLE\_MESH\_MODEL\_OP\_TAI\_UTC\_DELTA\_GET**

**ESP\_BLE\_MESH\_MODEL\_OP\_TAI\_UTC\_DELTA\_SET**

**ESP\_BLE\_MESH\_MODEL\_OP\_TAI\_UTC\_DELTA\_STATUS**

Scene Message Opcode

**ESP\_BLE\_MESH\_MODEL\_OP\_SCENE\_GET**

**ESP\_BLE\_MESH\_MODEL\_OP\_SCENE\_RECALL**

**ESP\_BLE\_MESH\_MODEL\_OP\_SCENE\_RECALL\_UNACK**

**ESP\_BLE\_MESH\_MODEL\_OP\_SCENE\_STATUS**

**ESP\_BLE\_MESH\_MODEL\_OP\_SCENE\_REGISTER\_GET**

**ESP\_BLE\_MESH\_MODEL\_OP\_SCENE\_REGISTER\_STATUS**

Scene Setup Message Opcode

**ESP\_BLE\_MESH\_MODEL\_OP\_SCENE\_STORE**

**ESP\_BLE\_MESH\_MODEL\_OP\_SCENE\_STORE\_UNACK**

**ESP\_BLE\_MESH\_MODEL\_OP\_SCENE\_DELETE**

**ESP\_BLE\_MESH\_MODEL\_OP\_SCENE\_DELETE\_UNACK**

Scheduler Message Opcode

**ESP\_BLE\_MESH\_MODEL\_OP\_SCHEDULER\_ACT\_GET**

**ESP\_BLE\_MESH\_MODEL\_OP\_SCHEDULER\_ACT\_STATUS**

**ESP\_BLE\_MESH\_MODEL\_OP\_SCHEDULER\_GET**

**ESP\_BLE\_MESH\_MODEL\_OP\_SCHEDULER\_STATUS**

Scheduler Setup Message Opcode

**ESP\_BLE\_MESH\_MODEL\_OP\_SCHEDULER\_ACT\_SET**

**ESP\_BLE\_MESH\_MODEL\_OP\_SCHEDULER\_ACT\_SET\_UNACK**

**ESP\_BLE\_MESH\_MODEL\_OP\_LIGHT\_LIGHTNESS\_GET**

ESP\_BLE\_MESH\_MODEL\_OP\_LIGHT\_LIGHTNESS\_SET

ESP\_BLE\_MESH\_MODEL\_OP\_LIGHT\_LIGHTNESS\_SET\_UNACK

ESP\_BLE\_MESH\_MODEL\_OP\_LIGHT\_LIGHTNESS\_STATUS

ESP\_BLE\_MESH\_MODEL\_OP\_LIGHT\_LIGHTNESS\_LINEAR\_GET

ESP\_BLE\_MESH\_MODEL\_OP\_LIGHT\_LIGHTNESS\_LINEAR\_SET

ESP\_BLE\_MESH\_MODEL\_OP\_LIGHT\_LIGHTNESS\_LINEAR\_SET\_UNACK

ESP\_BLE\_MESH\_MODEL\_OP\_LIGHT\_LIGHTNESS\_LINEAR\_STATUS

ESP\_BLE\_MESH\_MODEL\_OP\_LIGHT\_LIGHTNESS\_LAST\_GET

ESP\_BLE\_MESH\_MODEL\_OP\_LIGHT\_LIGHTNESS\_LAST\_STATUS

ESP\_BLE\_MESH\_MODEL\_OP\_LIGHT\_LIGHTNESS\_DEFAULT\_GET

ESP\_BLE\_MESH\_MODEL\_OP\_LIGHT\_LIGHTNESS\_DEFAULT\_STATUS

ESP\_BLE\_MESH\_MODEL\_OP\_LIGHT\_LIGHTNESS\_RANGE\_GET

ESP\_BLE\_MESH\_MODEL\_OP\_LIGHT\_LIGHTNESS\_RANGE\_STATUS

Light Lightness Setup Message Opcode

ESP\_BLE\_MESH\_MODEL\_OP\_LIGHT\_LIGHTNESS\_DEFAULT\_SET

ESP\_BLE\_MESH\_MODEL\_OP\_LIGHT\_LIGHTNESS\_DEFAULT\_SET\_UNACK

ESP\_BLE\_MESH\_MODEL\_OP\_LIGHT\_LIGHTNESS\_RANGE\_SET

ESP\_BLE\_MESH\_MODEL\_OP\_LIGHT\_LIGHTNESS\_RANGE\_SET\_UNACK

Light CTL Message Opcode

ESP\_BLE\_MESH\_MODEL\_OP\_LIGHT\_CTL\_GET

ESP\_BLE\_MESH\_MODEL\_OP\_LIGHT\_CTL\_SET

ESP\_BLE\_MESH\_MODEL\_OP\_LIGHT\_CTL\_SET\_UNACK

ESP\_BLE\_MESH\_MODEL\_OP\_LIGHT\_CTL\_STATUS

ESP\_BLE\_MESH\_MODEL\_OP\_LIGHT\_CTL\_TEMPERATURE\_GET

ESP\_BLE\_MESH\_MODEL\_OP\_LIGHT\_CTL\_TEMPERATURE\_RANGE\_GET

ESP\_BLE\_MESH\_MODEL\_OP\_LIGHT\_CTL\_TEMPERATURE\_RANGE\_STATUS

ESP\_BLE\_MESH\_MODEL\_OP\_LIGHT\_CTL\_TEMPERATURE\_SET

ESP\_BLE\_MESH\_MODEL\_OP\_LIGHT\_CTL\_TEMPERATURE\_SET\_UNACK

ESP\_BLE\_MESH\_MODEL\_OP\_LIGHT\_CTL\_TEMPERATURE\_STATUS

ESP\_BLE\_MESH\_MODEL\_OP\_LIGHT\_CTL\_DEFAULT\_GET

ESP\_BLE\_MESH\_MODEL\_OP\_LIGHT\_CTL\_DEFAULT\_STATUS

Light CTL Setup Message Opcode

ESP\_BLE\_MESH\_MODEL\_OP\_LIGHT\_CTL\_DEFAULT\_SET

ESP\_BLE\_MESH\_MODEL\_OP\_LIGHT\_CTL\_DEFAULT\_SET\_UNACK

ESP\_BLE\_MESH\_MODEL\_OP\_LIGHT\_CTL\_TEMPERATURE\_RANGE\_SET

ESP\_BLE\_MESH\_MODEL\_OP\_LIGHT\_CTL\_TEMPERATURE\_RANGE\_SET\_UNACK

Light HSL Message Opcode

ESP\_BLE\_MESH\_MODEL\_OP\_LIGHT\_HSL\_GET

ESP\_BLE\_MESH\_MODEL\_OP\_LIGHT\_HSL\_HUE\_GET

ESP\_BLE\_MESH\_MODEL\_OP\_LIGHT\_HSL\_HUE\_SET

ESP\_BLE\_MESH\_MODEL\_OP\_LIGHT\_HSL\_HUE\_SET\_UNACK

ESP\_BLE\_MESH\_MODEL\_OP\_LIGHT\_HSL\_HUE\_STATUS

ESP\_BLE\_MESH\_MODEL\_OP\_LIGHT\_HSL\_SATURATION\_GET

ESP\_BLE\_MESH\_MODEL\_OP\_LIGHT\_HSL\_SATURATION\_SET

ESP\_BLE\_MESH\_MODEL\_OP\_LIGHT\_HSL\_SATURATION\_SET\_UNACK

ESP\_BLE\_MESH\_MODEL\_OP\_LIGHT\_HSL\_SATURATION\_STATUS

ESP\_BLE\_MESH\_MODEL\_OP\_LIGHT\_HSL\_SET

ESP\_BLE\_MESH\_MODEL\_OP\_LIGHT\_HSL\_SET\_UNACK

ESP\_BLE\_MESH\_MODEL\_OP\_LIGHT\_HSL\_STATUS

ESP\_BLE\_MESH\_MODEL\_OP\_LIGHT\_HSL\_TARGET\_GET

ESP\_BLE\_MESH\_MODEL\_OP\_LIGHT\_HSL\_TARGET\_STATUS

ESP\_BLE\_MESH\_MODEL\_OP\_LIGHT\_HSL\_DEFAULT\_GET

ESP\_BLE\_MESH\_MODEL\_OP\_LIGHT\_HSL\_DEFAULT\_STATUS

ESP\_BLE\_MESH\_MODEL\_OP\_LIGHT\_HSL\_RANGE\_GET

ESP\_BLE\_MESH\_MODEL\_OP\_LIGHT\_HSL\_RANGE\_STATUS

Light HSL Setup Message Opcode

ESP\_BLE\_MESH\_MODEL\_OP\_LIGHT\_HSL\_DEFAULT\_SET

ESP\_BLE\_MESH\_MODEL\_OP\_LIGHT\_HSL\_DEFAULT\_SET\_UNACK

ESP\_BLE\_MESH\_MODEL\_OP\_LIGHT\_HSL\_RANGE\_SET

ESP\_BLE\_MESH\_MODEL\_OP\_LIGHT\_HSL\_RANGE\_SET\_UNACK

Light xyL Message Opcode

ESP\_BLE\_MESH\_MODEL\_OP\_LIGHT\_XYL\_GET

ESP\_BLE\_MESH\_MODEL\_OP\_LIGHT\_XYL\_SET

ESP\_BLE\_MESH\_MODEL\_OP\_LIGHT\_XYL\_SET\_UNACK

ESP\_BLE\_MESH\_MODEL\_OP\_LIGHT\_XYL\_STATUS

ESP\_BLE\_MESH\_MODEL\_OP\_LIGHT\_XYL\_TARGET\_GET

ESP\_BLE\_MESH\_MODEL\_OP\_LIGHT\_XYL\_TARGET\_STATUS

ESP\_BLE\_MESH\_MODEL\_OP\_LIGHT\_XYL\_DEFAULT\_GET

ESP\_BLE\_MESH\_MODEL\_OP\_LIGHT\_XYL\_DEFAULT\_STATUS

ESP\_BLE\_MESH\_MODEL\_OP\_LIGHT\_XYL\_RANGE\_GET

ESP\_BLE\_MESH\_MODEL\_OP\_LIGHT\_XYL\_RANGE\_STATUS

Light xyL Setup Message Opcode

ESP\_BLE\_MESH\_MODEL\_OP\_LIGHT\_XYL\_DEFAULT\_SET



ESP\_BLE\_MESH\_MODEL\_OP\_LIGHT\_XYL\_DEFAULT\_SET\_UNACK

ESP\_BLE\_MESH\_MODEL\_OP\_LIGHT\_XYL\_RANGE\_SET

ESP\_BLE\_MESH\_MODEL\_OP\_LIGHT\_XYL\_RANGE\_SET\_UNACK

Light Control Message Opcode

ESP\_BLE\_MESH\_MODEL\_OP\_LIGHT\_LC\_MODE\_GET

ESP\_BLE\_MESH\_MODEL\_OP\_LIGHT\_LC\_MODE\_SET

ESP\_BLE\_MESH\_MODEL\_OP\_LIGHT\_LC\_MODE\_SET\_UNACK

ESP\_BLE\_MESH\_MODEL\_OP\_LIGHT\_LC\_MODE\_STATUS

ESP\_BLE\_MESH\_MODEL\_OP\_LIGHT\_LC\_OM\_GET

ESP\_BLE\_MESH\_MODEL\_OP\_LIGHT\_LC\_OM\_SET

ESP\_BLE\_MESH\_MODEL\_OP\_LIGHT\_LC\_OM\_SET\_UNACK

ESP\_BLE\_MESH\_MODEL\_OP\_LIGHT\_LC\_OM\_STATUS

ESP\_BLE\_MESH\_MODEL\_OP\_LIGHT\_LC\_LIGHT\_ONOFF\_GET

ESP\_BLE\_MESH\_MODEL\_OP\_LIGHT\_LC\_LIGHT\_ONOFF\_SET

ESP\_BLE\_MESH\_MODEL\_OP\_LIGHT\_LC\_LIGHT\_ONOFF\_SET\_UNACK

ESP\_BLE\_MESH\_MODEL\_OP\_LIGHT\_LC\_LIGHT\_ONOFF\_STATUS

ESP\_BLE\_MESH\_MODEL\_OP\_LIGHT\_LC\_PROPERTY\_GET

ESP\_BLE\_MESH\_MODEL\_OP\_LIGHT\_LC\_PROPERTY\_SET

ESP\_BLE\_MESH\_MODEL\_OP\_LIGHT\_LC\_PROPERTY\_SET\_UNACK

ESP\_BLE\_MESH\_MODEL\_OP\_LIGHT\_LC\_PROPERTY\_STATUS

ESP\_BLE\_MESH\_MODEL\_STATUS\_SUCCESS

ESP\_BLE\_MESH\_MODEL\_STATUS\_CANNOT\_SET\_RANGE\_MIN

ESP\_BLE\_MESH\_MODEL\_STATUS\_CANNOT\_SET\_RANGE\_MAX

**ESP\_BLE\_MESH\_SERVER\_RSP\_BY\_APP**

Response need to be sent in the application

**ESP\_BLE\_MESH\_SERVER\_AUTO\_RSP**

Response will be sent internally

**Type Definitions**

```
typedef uint8_t esp_ble_mesh_octet16_t[ESP_BLE_MESH_OCTET16_LEN]
```

Define the BLE Mesh octet 8 bytes size

```
typedef uint8_t esp_ble_mesh_octet8_t[ESP_BLE_MESH_OCTET8_LEN]
```

Invalid Company ID

```
typedef uint32_t esp_ble_mesh_cb_t
```

```
typedef uint8_t UINT8
```

```
typedef uint16_t UINT16
```

```
typedef uint32_t UINT32
```

```
typedef uint64_t UINT64
```

```
typedef UINT8 BT_OCTET32[BT_OCTET32_LEN]
```

```
typedef uint8_t BD_ADDR[BD_ADDR_LEN]
```

```
typedef uint8_t esp_ble_mesh_bd_addr_t[BD_ADDR_LEN]
```

```
typedef uint8_t esp_ble_mesh_addr_type_t
```

BLE device address type.

```
typedef struct esp_ble_mesh_model esp_ble_mesh_model_t
```

```
typedef uint8_t esp_ble_mesh_dev_add_flag_t
```

```
typedef uint32_t esp_ble_mesh_opcode_config_client_get_t
```

esp\_ble\_mesh\_opcode\_config\_client\_get\_t belongs to esp\_ble\_mesh\_opcode\_t, this typedef is only used to locate the opcodes used by esp\_ble\_mesh\_config\_client\_get\_state. The following opcodes will only be used in the esp\_ble\_mesh\_config\_client\_get\_state function.

```
typedef uint32_t esp_ble_mesh_opcode_config_client_set_t
```

esp\_ble\_mesh\_opcode\_config\_client\_set\_t belongs to esp\_ble\_mesh\_opcode\_t, this typedef is only used to locate the opcodes used by esp\_ble\_mesh\_config\_client\_set\_state. The following opcodes will only be used in the esp\_ble\_mesh\_config\_client\_set\_state function.

typedef uint32\_t **esp\_ble\_mesh\_opcode\_config\_status\_t**

esp\_ble\_mesh\_opcode\_config\_status\_t belongs to esp\_ble\_mesh\_opcode\_t, this typedef is only used to locate the opcodes used by the Config Model messages. The following opcodes are used by the BLE Mesh Config Server Model internally to respond to the Config Client Model's request messages.

typedef uint8\_t **esp\_ble\_mesh\_cfg\_status\_t**

This typedef is only used to indicate the status code contained in some of the Configuration Server Model status message.

typedef uint32\_t **esp\_ble\_mesh\_opcode\_health\_client\_get\_t**

esp\_ble\_mesh\_opcode\_health\_client\_get\_t belongs to esp\_ble\_mesh\_opcode\_t, this typedef is only used to locate the opcodes used by esp\_ble\_mesh\_health\_client\_get\_state. The following opcodes will only be used in the esp\_ble\_mesh\_health\_client\_get\_state function.

typedef uint32\_t **esp\_ble\_mesh\_opcode\_health\_client\_set\_t**

esp\_ble\_mesh\_opcode\_health\_client\_set\_t belongs to esp\_ble\_mesh\_opcode\_t, this typedef is only used to locate the opcodes used by esp\_ble\_mesh\_health\_client\_set\_state. The following opcodes will only be used in the esp\_ble\_mesh\_health\_client\_set\_state function.

typedef uint32\_t **esp\_ble\_mesh\_health\_model\_status\_t**

esp\_ble\_mesh\_health\_model\_status\_t belongs to esp\_ble\_mesh\_opcode\_t, this typedef is only used to locate the opcodes used by the Health Model messages. The following opcodes are used by the BLE Mesh Health Server Model internally to respond to the Health Client Model's request messages.

typedef uint32\_t **esp\_ble\_mesh\_generic\_message\_opcode\_t**

esp\_ble\_mesh\_generic\_message\_opcode\_t belongs to esp\_ble\_mesh\_opcode\_t, this typedef is only used to locate the opcodes used by functions esp\_ble\_mesh\_generic\_client\_get\_state & esp\_ble\_mesh\_generic\_client\_set\_state. Generic OnOff Message Opcode

typedef uint32\_t **esp\_ble\_mesh\_sensor\_message\_opcode\_t**

esp\_ble\_mesh\_sensor\_message\_opcode\_t belongs to esp\_ble\_mesh\_opcode\_t, this typedef is only used to locate the opcodes used by functions esp\_ble\_mesh\_sensor\_client\_get\_state & esp\_ble\_mesh\_sensor\_client\_set\_state. Sensor Message Opcode

typedef uint32\_t **esp\_ble\_mesh\_time\_scene\_message\_opcode\_t**

esp\_ble\_mesh\_time\_scene\_message\_opcode\_t belongs to esp\_ble\_mesh\_opcode\_t, this typedef is only used to locate the opcodes used by functions esp\_ble\_mesh\_time\_scene\_client\_get\_state & esp\_ble\_mesh\_time\_scene\_client\_set\_state. Time Message Opcode

typedef uint32\_t **esp\_ble\_mesh\_light\_message\_opcode\_t**

esp\_ble\_mesh\_light\_message\_opcode\_t belongs to esp\_ble\_mesh\_opcode\_t, this typedef is only used to locate the opcodes used by functions esp\_ble\_mesh\_light\_client\_get\_state & esp\_ble\_mesh\_light\_client\_set\_state. Light Lightness Message Opcode

typedef uint32\_t **esp\_ble\_mesh\_opcode\_t**

End of defines of esp\_ble\_mesh\_opcode\_t

typedef uint8\_t **esp\_ble\_mesh\_model\_status\_t**

This typedef is only used to indicate the status code contained in some of the server models (e.g. Generic Server Model) status message.

**Enumerations**enum **esp\_ble\_mesh\_cb\_type\_t***Values:*enumerator **ESP\_BLE\_MESH\_TYPE\_PROV\_CB**enumerator **ESP\_BLE\_MESH\_TYPE\_OUTPUT\_NUM\_CB**enumerator **ESP\_BLE\_MESH\_TYPE\_OUTPUT\_STR\_CB**enumerator **ESP\_BLE\_MESH\_TYPE\_INTPUT\_CB**enumerator **ESP\_BLE\_MESH\_TYPE\_LINK\_OPEN\_CB**enumerator **ESP\_BLE\_MESH\_TYPE\_LINK\_CLOSE\_CB**enumerator **ESP\_BLE\_MESH\_TYPE\_COMPLETE\_CB**enumerator **ESP\_BLE\_MESH\_TYPE\_RESET\_CB**enum **esp\_ble\_mesh\_oob\_method\_t***Values:*enumerator **ESP\_BLE\_MESH\_NO\_OOB**enumerator **ESP\_BLE\_MESH\_STATIC\_OOB**enumerator **ESP\_BLE\_MESH\_OUTPUT\_OOB**enumerator **ESP\_BLE\_MESH\_INPUT\_OOB**enum **esp\_ble\_mesh\_output\_action\_t***Values:*enumerator **ESP\_BLE\_MESH\_NO\_OUTPUT**enumerator **ESP\_BLE\_MESH\_BLINK**enumerator **ESP\_BLE\_MESH\_BEEP**enumerator **ESP\_BLE\_MESH\_VIBRATE**enumerator **ESP\_BLE\_MESH\_DISPLAY\_NUMBER**enumerator **ESP\_BLE\_MESH\_DISPLAY\_STRING**

enum **esp\_ble\_mesh\_input\_action\_t**

*Values:*

enumerator **ESP\_BLE\_MESH\_NO\_INPUT**

enumerator **ESP\_BLE\_MESH\_PUSH**

enumerator **ESP\_BLE\_MESH\_TWIST**

enumerator **ESP\_BLE\_MESH\_ENTER\_NUMBER**

enumerator **ESP\_BLE\_MESH\_ENTER\_STRING**

enum **esp\_ble\_mesh\_prov\_bearer\_t**

*Values:*

enumerator **ESP\_BLE\_MESH\_PROV\_ADV**

enumerator **ESP\_BLE\_MESH\_PROV\_GATT**

enum **esp\_ble\_mesh\_prov\_oob\_info\_t**

*Values:*

enumerator **ESP\_BLE\_MESH\_PROV\_OOB\_OTHER**

enumerator **ESP\_BLE\_MESH\_PROV\_OOB\_URI**

enumerator **ESP\_BLE\_MESH\_PROV\_OOB\_2D\_CODE**

enumerator **ESP\_BLE\_MESH\_PROV\_OOB\_BAR\_CODE**

enumerator **ESP\_BLE\_MESH\_PROV\_OOB\_NFC**

enumerator **ESP\_BLE\_MESH\_PROV\_OOB\_NUMBER**

enumerator **ESP\_BLE\_MESH\_PROV\_OOB\_STRING**

enumerator **ESP\_BLE\_MESH\_PROV\_CERT\_BASED**

enumerator **ESP\_BLE\_MESH\_PROV\_RECORDS**

enumerator **ESP\_BLE\_MESH\_PROV\_OOB\_ON\_BOX**

enumerator **ESP\_BLE\_MESH\_PROV\_OOB\_IN\_BOX**

enumerator **ESP\_BLE\_MESH\_PROV\_OOB\_ON\_PAPER**

enumerator **ESP\_BLE\_MESH\_PROV\_OOB\_IN\_MANUAL**

enumerator **ESP\_BLE\_MESH\_PROV\_OOB\_ON\_DEV**

enum **esp\_ble\_mesh\_dev\_role\_t**

*Values:*

enumerator **ROLE\_NODE**

enumerator **ROLE\_PROVISIONER**

enumerator **ROLE\_FAST\_PROV**

enum **esp\_ble\_mesh\_fast\_prov\_action\_t**

*Values:*

enumerator **FAST\_PROV\_ACT\_NONE**

enumerator **FAST\_PROV\_ACT\_ENTER**

enumerator **FAST\_PROV\_ACT\_SUSPEND**

enumerator **FAST\_PROV\_ACT\_EXIT**

enumerator **FAST\_PROV\_ACT\_MAX**

enum **esp\_ble\_mesh\_proxy\_filter\_type\_t**

*Values:*

enumerator **PROXY\_FILTER\_WHITELIST**

enumerator **PROXY\_FILTER\_BLACKLIST**

enum **esp\_ble\_mesh\_prov\_cb\_event\_t**

*Values:*

enumerator **ESP\_BLE\_MESH\_PROV\_REGISTER\_COMP\_EVT**

Initialize BLE Mesh provisioning capabilities and internal data information completion event

enumerator **ESP\_BLE\_MESH\_NODE\_SET\_UNPROV\_DEV\_NAME\_COMP\_EVT**

Set the unprovisioned device name completion event

enumerator **ESP\_BLE\_MESH\_NODE\_PROV\_ENABLE\_COMP\_EVT**

Enable node provisioning functionality completion event

enumerator **ESP\_BLE\_MESH\_NODE\_PROV\_DISABLE\_COMP\_EVT**

Disable node provisioning functionality completion event

- enumerator **ESP\_BLE\_MESH\_NODE\_PROV\_LINK\_OPEN\_EVT**  
Establish a BLE Mesh link event
- enumerator **ESP\_BLE\_MESH\_NODE\_PROV\_LINK\_CLOSE\_EVT**  
Close a BLE Mesh link event
- enumerator **ESP\_BLE\_MESH\_NODE\_PROV\_OOB\_PUB\_KEY\_EVT**  
Generate Node input OOB public key event
- enumerator **ESP\_BLE\_MESH\_NODE\_PROV\_OUTPUT\_NUMBER\_EVT**  
Generate Node Output Number event
- enumerator **ESP\_BLE\_MESH\_NODE\_PROV\_OUTPUT\_STRING\_EVT**  
Generate Node Output String event
- enumerator **ESP\_BLE\_MESH\_NODE\_PROV\_INPUT\_EVT**  
Event requiring the user to input a number or string
- enumerator **ESP\_BLE\_MESH\_NODE\_PROV\_COMPLETE\_EVT**  
Provisioning done event
- enumerator **ESP\_BLE\_MESH\_NODE\_PROV\_RESET\_EVT**  
Provisioning reset event
- enumerator **ESP\_BLE\_MESH\_NODE\_PROV\_SET\_OOB\_PUB\_KEY\_COMP\_EVT**  
Node set oob public key completion event
- enumerator **ESP\_BLE\_MESH\_NODE\_PROV\_INPUT\_NUMBER\_COMP\_EVT**  
Node input number completion event
- enumerator **ESP\_BLE\_MESH\_NODE\_PROV\_INPUT\_STRING\_COMP\_EVT**  
Node input string completion event
- enumerator **ESP\_BLE\_MESH\_NODE\_PROXY\_IDENTITY\_ENABLE\_COMP\_EVT**  
Enable BLE Mesh Proxy Identity advertising completion event
- enumerator **ESP\_BLE\_MESH\_NODE\_PRIVATE\_PROXY\_IDENTITY\_ENABLE\_COMP\_EVT**  
Enable BLE Mesh Private Proxy Identity advertising completion event
- enumerator **ESP\_BLE\_MESH\_NODE\_PRIVATE\_PROXY\_IDENTITY\_DISABLE\_COMP\_EVT**  
Disable BLE Mesh Private Proxy Identity advertising completion event
- enumerator **ESP\_BLE\_MESH\_NODE\_PROXY\_GATT\_ENABLE\_COMP\_EVT**  
Enable BLE Mesh GATT Proxy Service completion event
- enumerator **ESP\_BLE\_MESH\_NODE\_PROXY\_GATT\_DISABLE\_COMP\_EVT**  
Disable BLE Mesh GATT Proxy Service completion event

- enumerator **ESP\_BLE\_MESH\_NODE\_ADD\_LOCAL\_NET\_KEY\_COMP\_EVT**  
Node add NetKey locally completion event
- enumerator **ESP\_BLE\_MESH\_NODE\_ADD\_LOCAL\_APP\_KEY\_COMP\_EVT**  
Node add AppKey locally completion event
- enumerator **ESP\_BLE\_MESH\_NODE\_BIND\_APP\_KEY\_TO\_MODEL\_COMP\_EVT**  
Node bind AppKey to model locally completion event
- enumerator **ESP\_BLE\_MESH\_PROVISIONER\_PROV\_ENABLE\_COMP\_EVT**  
Provisioner enable provisioning functionality completion event
- enumerator **ESP\_BLE\_MESH\_PROVISIONER\_PROV\_DISABLE\_COMP\_EVT**  
Provisioner disable provisioning functionality completion event
- enumerator **ESP\_BLE\_MESH\_PROVISIONER\_RECV\_UNPROV\_ADV\_PKT\_EVT**  
Provisioner receives unprovisioned device beacon event
- enumerator **ESP\_BLE\_MESH\_PROVISIONER\_PROV\_READ\_OOB\_PUB\_KEY\_EVT**  
Provisioner read unprovisioned device OOB public key event
- enumerator **ESP\_BLE\_MESH\_PROVISIONER\_PROV\_INPUT\_EVT**  
Provisioner input value for provisioning procedure event
- enumerator **ESP\_BLE\_MESH\_PROVISIONER\_PROV\_OUTPUT\_EVT**  
Provisioner output value for provisioning procedure event
- enumerator **ESP\_BLE\_MESH\_PROVISIONER\_PROV\_LINK\_OPEN\_EVT**  
Provisioner establish a BLE Mesh link event
- enumerator **ESP\_BLE\_MESH\_PROVISIONER\_PROV\_LINK\_CLOSE\_EVT**  
Provisioner close a BLE Mesh link event
- enumerator **ESP\_BLE\_MESH\_PROVISIONER\_PROV\_COMPLETE\_EVT**  
Provisioner provisioning done event
- enumerator **ESP\_BLE\_MESH\_PROVISIONER\_CERT\_BASED\_PROV\_START\_EVT**  
Provisioner initiate a certificate based provisioning
- enumerator **ESP\_BLE\_MESH\_PROVISIONER\_RECV\_PROV\_RECORDS\_LIST\_EVT**  
Provisioner receive provisioning records list event
- enumerator **ESP\_BLE\_MESH\_PROVISIONER\_PROV\_RECORD\_RECV\_COMP\_EVT**  
Provisioner receive provisioning record complete event
- enumerator **ESP\_BLE\_MESH\_PROVISIONER\_SEND\_PROV\_RECORDS\_GET\_EVT**  
Provisioner send provisioning records get to device event



- enumerator **ESP\_BLE\_MESH\_PROVISIONER\_SEND\_PROV\_RECORD\_REQUEST\_EVT**  
Provisioner send provisioning record request to device event
- enumerator **ESP\_BLE\_MESH\_PROVISIONER\_SEND\_PROV\_INVITE\_EVT**  
Provisioner send provisioning invite to device event
- enumerator **ESP\_BLE\_MESH\_PROVISIONER\_SEND\_LINK\_CLOSE\_EVT**  
Provisioner send link close to device event
- enumerator **ESP\_BLE\_MESH\_PROVISIONER\_ADD\_UNPROV\_DEV\_COMP\_EVT**  
Provisioner add a device to the list which contains devices that are waiting/going to be provisioned completion event
- enumerator **ESP\_BLE\_MESH\_PROVISIONER\_PROV\_DEV\_WITH\_ADDR\_COMP\_EVT**  
Provisioner start to provision an unprovisioned device completion event
- enumerator **ESP\_BLE\_MESH\_PROVISIONER\_DELETE\_DEV\_COMP\_EVT**  
Provisioner delete a device from the list, close provisioning link with the device completion event
- enumerator **ESP\_BLE\_MESH\_PROVISIONER\_SET\_DEV\_UUID\_MATCH\_COMP\_EVT**  
Provisioner set the value to be compared with part of the unprovisioned device UUID completion event
- enumerator **ESP\_BLE\_MESH\_PROVISIONER\_SET\_PROV\_DATA\_INFO\_COMP\_EVT**  
Provisioner set net\_idx/flags/iv\_index used for provisioning completion event
- enumerator **ESP\_BLE\_MESH\_PROVISIONER\_SET\_STATIC\_OOB\_VALUE\_COMP\_EVT**  
Provisioner set static oob value used for provisioning completion event
- enumerator **ESP\_BLE\_MESH\_PROVISIONER\_SET\_PRIMARY\_ELEM\_ADDR\_COMP\_EVT**  
Provisioner set unicast address of primary element completion event
- enumerator **ESP\_BLE\_MESH\_PROVISIONER\_PROV\_READ\_OOB\_PUB\_KEY\_COMP\_EVT**  
Provisioner read unprovisioned device OOB public key completion event
- enumerator **ESP\_BLE\_MESH\_PROVISIONER\_PROV\_INPUT\_NUMBER\_COMP\_EVT**  
Provisioner input number completion event
- enumerator **ESP\_BLE\_MESH\_PROVISIONER\_PROV\_INPUT\_STRING\_COMP\_EVT**  
Provisioner input string completion event
- enumerator **ESP\_BLE\_MESH\_PROVISIONER\_SET\_NODE\_NAME\_COMP\_EVT**  
Provisioner set node name completion event
- enumerator **ESP\_BLE\_MESH\_PROVISIONER\_ADD\_LOCAL\_APP\_KEY\_COMP\_EVT**  
Provisioner add local app key completion event
- enumerator **ESP\_BLE\_MESH\_PROVISIONER\_UPDATE\_LOCAL\_APP\_KEY\_COMP\_EVT**  
Provisioner update local app key completion event

- enumerator **ESP\_BLE\_MESH\_PROVISIONER\_BIND\_APP\_KEY\_TO\_MODEL\_COMP\_EVT**  
Provisioner bind local model with local app key completion event
- enumerator **ESP\_BLE\_MESH\_PROVISIONER\_ADD\_LOCAL\_NET\_KEY\_COMP\_EVT**  
Provisioner add local network key completion event
- enumerator **ESP\_BLE\_MESH\_PROVISIONER\_UPDATE\_LOCAL\_NET\_KEY\_COMP\_EVT**  
Provisioner update local network key completion event
- enumerator **ESP\_BLE\_MESH\_PROVISIONER\_STORE\_NODE\_COMP\_DATA\_COMP\_EVT**  
Provisioner store node composition data completion event
- enumerator **ESP\_BLE\_MESH\_PROVISIONER\_DELETE\_NODE\_WITH\_UUID\_COMP\_EVT**  
Provisioner delete node with uuid completion event
- enumerator **ESP\_BLE\_MESH\_PROVISIONER\_DELETE\_NODE\_WITH\_ADDR\_COMP\_EVT**  
Provisioner delete node with unicast address completion event
- enumerator **ESP\_BLE\_MESH\_PROVISIONER\_ENABLE\_HEARTBEAT\_RECV\_COMP\_EVT**  
Provisioner start to receive heartbeat message completion event
- enumerator **ESP\_BLE\_MESH\_PROVISIONER\_SET\_HEARTBEAT\_FILTER\_TYPE\_COMP\_EVT**  
Provisioner set the heartbeat filter type completion event
- enumerator **ESP\_BLE\_MESH\_PROVISIONER\_SET\_HEARTBEAT\_FILTER\_INFO\_COMP\_EVT**  
Provisioner set the heartbeat filter information completion event
- enumerator **ESP\_BLE\_MESH\_PROVISIONER\_RECV\_HEARTBEAT\_MESSAGE\_EVT**  
Provisioner receive heartbeat message event
- enumerator **ESP\_BLE\_MESH\_PROVISIONER\_DIRECT\_ERASE\_SETTINGS\_COMP\_EVT**  
Provisioner directly erase settings completion event
- enumerator **ESP\_BLE\_MESH\_PROVISIONER\_OPEN\_SETTINGS\_WITH\_INDEX\_COMP\_EVT**  
Provisioner open settings with index completion event
- enumerator **ESP\_BLE\_MESH\_PROVISIONER\_OPEN\_SETTINGS\_WITH\_UID\_COMP\_EVT**  
Provisioner open settings with user id completion event
- enumerator **ESP\_BLE\_MESH\_PROVISIONER\_CLOSE\_SETTINGS\_WITH\_INDEX\_COMP\_EVT**  
Provisioner close settings with index completion event
- enumerator **ESP\_BLE\_MESH\_PROVISIONER\_CLOSE\_SETTINGS\_WITH\_UID\_COMP\_EVT**  
Provisioner close settings with user id completion event
- enumerator **ESP\_BLE\_MESH\_PROVISIONER\_DELETE\_SETTINGS\_WITH\_INDEX\_COMP\_EVT**  
Provisioner delete settings with index completion event

enumerator **ESP\_BLE\_MESH\_PROVISIONER\_DELETE\_SETTINGS\_WITH\_UID\_COMP\_EVT**

Provisioner delete settings with user id completion event

enumerator **ESP\_BLE\_MESH\_SET\_FAST\_PROV\_INFO\_COMP\_EVT**

Set fast provisioning information (e.g. unicast address range, net\_idx, etc.) completion event

enumerator **ESP\_BLE\_MESH\_SET\_FAST\_PROV\_ACTION\_COMP\_EVT**

Set fast provisioning action completion event

enumerator **ESP\_BLE\_MESH\_HEARTBEAT\_MESSAGE\_RECV\_EVT**

Receive Heartbeat message event

enumerator **ESP\_BLE\_MESH\_LPN\_ENABLE\_COMP\_EVT**

Enable Low Power Node completion event

enumerator **ESP\_BLE\_MESH\_LPN\_DISABLE\_COMP\_EVT**

Disable Low Power Node completion event

enumerator **ESP\_BLE\_MESH\_LPN\_POLL\_COMP\_EVT**

Low Power Node send Friend Poll completion event

enumerator **ESP\_BLE\_MESH\_LPN\_FRIENDSHIP\_ESTABLISH\_EVT**

Low Power Node establishes friendship event

enumerator **ESP\_BLE\_MESH\_LPN\_FRIENDSHIP\_TERMINATE\_EVT**

Low Power Node terminates friendship event

enumerator **ESP\_BLE\_MESH\_FRIEND\_FRIENDSHIP\_ESTABLISH\_EVT**

Friend Node establishes friendship event

enumerator **ESP\_BLE\_MESH\_FRIEND\_FRIENDSHIP\_TERMINATE\_EVT**

Friend Node terminates friendship event

enumerator **ESP\_BLE\_MESH\_PROXY\_CLIENT\_RECV\_ADV\_PKT\_EVT**

Proxy Client receives Network ID advertising packet event

enumerator **ESP\_BLE\_MESH\_PROXY\_CLIENT\_CONNECTED\_EVT**

Proxy Client establishes connection successfully event

enumerator **ESP\_BLE\_MESH\_PROXY\_CLIENT\_DISCONNECTED\_EVT**

Proxy Client terminates connection successfully event

enumerator **ESP\_BLE\_MESH\_PROXY\_CLIENT\_RECV\_FILTER\_STATUS\_EVT**

Proxy Client receives Proxy Filter Status event

enumerator **ESP\_BLE\_MESH\_PROXY\_CLIENT\_CONNECT\_COMP\_EVT**

Proxy Client connect completion event

enumerator **ESP\_BLE\_MESH\_PROXY\_CLIENT\_DISCONNECT\_COMP\_EVT**

Proxy Client disconnect completion event

enumerator **ESP\_BLE\_MESH\_PROXY\_CLIENT\_SET\_FILTER\_TYPE\_COMP\_EVT**

Proxy Client set filter type completion event

enumerator **ESP\_BLE\_MESH\_PROXY\_CLIENT\_ADD\_FILTER\_ADDR\_COMP\_EVT**

Proxy Client add filter address completion event

enumerator **ESP\_BLE\_MESH\_PROXY\_CLIENT\_REMOVE\_FILTER\_ADDR\_COMP\_EVT**

Proxy Client remove filter address completion event

enumerator **ESP\_BLE\_MESH\_PROXY\_CLIENT\_DIRECTED\_PROXY\_SET\_COMP\_EVT**

Proxy Client directed proxy set completion event

enumerator **ESP\_BLE\_MESH\_PROXY\_SERVER\_CONNECTED\_EVT**

Proxy Server establishes connection successfully event

enumerator **ESP\_BLE\_MESH\_PROXY\_SERVER\_DISCONNECTED\_EVT**

Proxy Server terminates connection successfully event

enumerator **ESP\_BLE\_MESH\_PROXY\_CLIENT\_SEND\_SOLIC\_PDU\_COMP\_EVT**

Proxy Client send Solicitation PDU completion event

enumerator **ESP\_BLE\_MESH\_MODEL\_SUBSCRIBE\_GROUP\_ADDR\_COMP\_EVT**

Local model subscribes group address completion event

enumerator **ESP\_BLE\_MESH\_MODEL\_UNSUBSCRIBE\_GROUP\_ADDR\_COMP\_EVT**

Local model unsubscribes group address completion event

enumerator **ESP\_BLE\_MESH\_DEINIT\_MESH\_COMP\_EVT**

De-initialize BLE Mesh stack completion event

enumerator **ESP\_BLE\_MESH\_PROV\_EVT\_MAX**

enum [**anonymous**]

BLE Mesh server models related definitions.

This enum value is the flag of transition timer operation

*Values:*

enumerator **ESP\_BLE\_MESH\_SERVER\_TRANS\_TIMER\_START**

enumerator **ESP\_BLE\_MESH\_SERVER\_FLAG\_MAX**

enum **esp\_ble\_mesh\_server\_state\_type\_t**

This enum value is the type of server model states

*Values:*

enumerator **ESP\_BLE\_MESH\_GENERIC\_ONOFF\_STATE**

enumerator **ESP\_BLE\_MESH\_GENERIC\_LEVEL\_STATE**

enumerator **ESP\_BLE\_MESH\_GENERIC\_ONPOWERUP\_STATE**

enumerator **ESP\_BLE\_MESH\_GENERIC\_POWER\_ACTUAL\_STATE**

enumerator **ESP\_BLE\_MESH\_LIGHT\_LIGHTNESS\_ACTUAL\_STATE**

enumerator **ESP\_BLE\_MESH\_LIGHT\_LIGHTNESS\_LINEAR\_STATE**

enumerator **ESP\_BLE\_MESH\_LIGHT\_CTL\_LIGHTNESS\_STATE**

enumerator **ESP\_BLE\_MESH\_LIGHT\_CTL\_TEMP\_DELTA\_UV\_STATE**

enumerator **ESP\_BLE\_MESH\_LIGHT\_HSL\_STATE**

enumerator **ESP\_BLE\_MESH\_LIGHT\_HSL\_LIGHTNESS\_STATE**

enumerator **ESP\_BLE\_MESH\_LIGHT\_HSL\_HUE\_STATE**

enumerator **ESP\_BLE\_MESH\_LIGHT\_HSL\_SATURATION\_STATE**

enumerator **ESP\_BLE\_MESH\_LIGHT\_XYL\_LIGHTNESS\_STATE**

enumerator **ESP\_BLE\_MESH\_LIGHT\_LC\_LIGHT\_ONOFF\_STATE**

enumerator **ESP\_BLE\_MESH\_SERVER\_MODEL\_STATE\_MAX**

enum **esp\_ble\_mesh\_model\_cb\_event\_t**

*Values:*

enumerator **ESP\_BLE\_MESH\_MODEL\_OPERATION\_EVT**

User-defined models receive messages from peer devices (e.g. get, set, status, etc) event

enumerator **ESP\_BLE\_MESH\_MODEL\_SEND\_COMP\_EVT**

User-defined models send messages completion event

enumerator **ESP\_BLE\_MESH\_MODEL\_PUBLISH\_COMP\_EVT**

User-defined models publish messages completion event

enumerator **ESP\_BLE\_MESH\_CLIENT\_MODEL\_RECV\_PUBLISH\_MSG\_EVT**

User-defined client models receive publish messages event

enumerator **ESP\_BLE\_MESH\_CLIENT\_MODEL\_SEND\_TIMEOUT\_EVT**

Timeout event for the user-defined client models that failed to receive response from peer server models

enumerator **ESP\_BLE\_MESH\_MODEL\_PUBLISH\_UPDATE\_EVT**

When a model is configured to publish messages periodically, this event will occur during every publish period

enumerator **ESP\_BLE\_MESH\_SERVER\_MODEL\_UPDATE\_STATE\_COMP\_EVT**

Server models update state value completion event

enumerator **ESP\_BLE\_MESH\_MODEL\_EVT\_MAX**

## ESP-BLE-MESH Core API Reference

This section contains ESP-BLE-MESH Core related APIs, which can be used to initialize ESP-BLE-MESH stack, provision, send/publish messages, etc.

This API reference covers six components:

- *ESP-BLE-MESH Stack Initialization*
- *Reading of Local Data Information*
- *Low Power Operation (Updating)*
- *Send/Publish Messages, add Local AppKey, etc.*
- *ESP-BLE-MESH Node/Provisioner Provisioning*
- *ESP-BLE-MESH GATT Proxy Server*

## ESP-BLE-MESH Stack Initialization

### Header File

- `components/bt/esp_ble_mesh/api/core/include/esp_ble_mesh_common_api.h`
- This header file can be included with:

```
#include "esp_ble_mesh_common_api.h"
```

- This header file is a part of the API provided by the `bt` component. To declare that your component depends on `bt`, add the following to your `CMakeLists.txt`:

```
REQUIRES bt
```

or

```
PRIV_REQUIRES bt
```

### Functions

`esp_err_t esp_ble_mesh_init(esp_ble_mesh_prov_t *prov, esp_ble_mesh_comp_t *comp)`

Initialize BLE Mesh module. This API initializes provisioning capabilities and composition data information.

---

**备注:** After calling this API, the device needs to call `esp_ble_mesh_prov_enable()` to enable provisioning functionality again.

---

#### 参数

- **prov** -- **[in]** Pointer to the device provisioning capabilities. This pointer must remain valid during the lifetime of the BLE Mesh device.
- **comp** -- **[in]** Pointer to the device composition data information. This pointer must remain valid during the lifetime of the BLE Mesh device.

**返回** `ESP_OK` on success or error code otherwise.

`esp_err_t esp_ble_mesh_deinit` (`esp_ble_mesh_deinit_param_t *param`)

De-initialize BLE Mesh module.

---

**备注:**

- a. This function shall be invoked after `esp_ble_mesh_client_model_deinit()`.
  - b. This function is strictly forbidden to run in any BTC Task Context (e.g. registered Mesh Event Callback).
- 

**参数** `param` -- [in] Pointer to the structure of BLE Mesh deinit parameters.

**返回** ESP\_OK on success or error code otherwise.

## Reading of Local Data Information

### Header File

- `components/bt/esp_ble_mesh/api/core/include/esp_ble_mesh_local_data_operation_api.h`
- This header file can be included with:

```
#include "esp_ble_mesh_local_data_operation_api.h"
```

- This header file is a part of the API provided by the `bt` component. To declare that your component depends on `bt`, add the following to your `CMakeLists.txt`:

```
REQUIRES bt
```

or

```
PRIV_REQUIRES bt
```

### Functions

`int32_t esp_ble_mesh_get_model_publish_period` (`esp_ble_mesh_model_t *model`)

Get the model publish period, the unit is ms.

**参数** `model` -- [in] Model instance pointer.

**返回** Publish period value on success, 0 or (negative) error code from `errno.h` on failure.

`uint16_t esp_ble_mesh_get_primary_element_address` (void)

Get the address of the primary element.

**返回** Address of the primary element on success, or `ESP_BLE_MESH_ADDR_UNASSIGNED` on failure which means the device has not been provisioned.

`uint16_t *esp_ble_mesh_is_model_subscribed_to_group` (`esp_ble_mesh_model_t *model`, `uint16_t group_addr`)

Check if the model has subscribed to the given group address. Note: E.g., once a status message is received and the destination address is a group address, the model uses this API to check if it is successfully subscribed to the given group address.

**参数**

- `model` -- [in] Pointer to the model.
- `group_addr` -- [in] Group address.

**返回** Pointer to the group address within the Subscription List of the model on success, or NULL on failure which means the model has not subscribed to the given group address. Note: With the pointer to the group address returned, you can reset the group address to 0x0000 in order to unsubscribe the model from the group.

`esp_ble_mesh_elem_t *esp_ble_mesh_find_element` (`uint16_t element_addr`)

Find the BLE Mesh element pointer via the element address.

**参数** `element_addr` -- [in] Element address.

**返回** Pointer to the element on success, or NULL on failure.

`uint8_t esp_ble_mesh_get_element_count` (void)

Get the number of elements that have been registered.

**返回** Number of elements.

`esp_ble_mesh_model_t *esp_ble_mesh_find_vendor_model` (const `esp_ble_mesh_elem_t` \*element, `uint16_t` company\_id, `uint16_t` model\_id)

Find the Vendor specific model with the given element, the company ID and the Vendor Model ID.

**参数**

- **element** -- **[in]** Element to which the model belongs.
- **company\_id** -- **[in]** A 16-bit company identifier assigned by the Bluetooth SIG.
- **model\_id** -- **[in]** A 16-bit vendor-assigned model identifier.

**返回** Pointer to the Vendor Model on success, or NULL on failure which means the Vendor Model is not found.

`esp_ble_mesh_model_t *esp_ble_mesh_find_sig_model` (const `esp_ble_mesh_elem_t` \*element, `uint16_t` model\_id)

Find the SIG model with the given element and Model id.

**参数**

- **element** -- **[in]** Element to which the model belongs.
- **model\_id** -- **[in]** SIG model identifier.

**返回** Pointer to the SIG Model on success, or NULL on failure which means the SIG Model is not found.

const `esp_ble_mesh_comp_t *esp_ble_mesh_get_composition_data` (void)

Get the Composition data which has been registered.

**返回** Pointer to the Composition data on success, or NULL on failure which means the Composition data is not initialized.

`esp_err_t esp_ble_mesh_model_subscribe_group_addr` (`uint16_t` element\_addr, `uint16_t` company\_id, `uint16_t` model\_id, `uint16_t` group\_addr)

A local model of node or Provisioner subscribes a group address.

---

**备注:** This function shall not be invoked before node is provisioned or Provisioner is enabled.

---

**参数**

- **element\_addr** -- **[in]** Unicast address of the element to which the model belongs.
- **company\_id** -- **[in]** A 16-bit company identifier.
- **model\_id** -- **[in]** A 16-bit model identifier.
- **group\_addr** -- **[in]** The group address to be subscribed.

**返回** ESP\_OK on success or error code otherwise.

`esp_err_t esp_ble_mesh_model_unsubscribe_group_addr` (`uint16_t` element\_addr, `uint16_t` company\_id, `uint16_t` model\_id, `uint16_t` group\_addr)

A local model of node or Provisioner unsubscribes a group address.

---

**备注:** This function shall not be invoked before node is provisioned or Provisioner is enabled.

---

**参数**

- **element\_addr** -- **[in]** Unicast address of the element to which the model belongs.
- **company\_id** -- **[in]** A 16-bit company identifier.



- **model\_id** -- [in] A 16-bit model identifier.
  - **group\_addr** -- [in] The subscribed group address.
- 返回 ESP\_OK on success or error code otherwise.

const uint8\_t \***esp\_ble\_mesh\_node\_get\_local\_net\_key** (uint16\_t net\_idx)

This function is called by Node to get the local NetKey.

- 参数 **net\_idx** -- [in] NetKey index.  
返回 NetKey on success, or NULL on failure.

const uint8\_t \***esp\_ble\_mesh\_node\_get\_local\_app\_key** (uint16\_t app\_idx)

This function is called by Node to get the local AppKey.

- 参数 **app\_idx** -- [in] AppKey index.  
返回 AppKey on success, or NULL on failure.

*esp\_err\_t* **esp\_ble\_mesh\_node\_add\_local\_net\_key** (const uint8\_t net\_key[16], uint16\_t net\_idx)

This function is called by Node to add a local NetKey.

---

备注: This function can only be called after the device is provisioned.

---

#### 参数

- **net\_key** -- [in] NetKey to be added.
  - **net\_idx** -- [in] NetKey Index.
- 返回 ESP\_OK on success or error code otherwise.

*esp\_err\_t* **esp\_ble\_mesh\_node\_add\_local\_app\_key** (const uint8\_t app\_key[16], uint16\_t net\_idx,  
uint16\_t app\_idx)

This function is called by Node to add a local AppKey.

---

备注: The net\_idx must be an existing one. This function can only be called after the device is provisioned.

---

#### 参数

- **app\_key** -- [in] AppKey to be added.
  - **net\_idx** -- [in] NetKey Index.
  - **app\_idx** -- [in] AppKey Index.
- 返回 ESP\_OK on success or error code otherwise.

*esp\_err\_t* **esp\_ble\_mesh\_node\_bind\_app\_key\_to\_local\_model** (uint16\_t element\_addr, uint16\_t  
company\_id, uint16\_t model\_id,  
uint16\_t app\_idx)

This function is called by Node to bind AppKey to model locally.

---

备注: If going to bind app\_key with local vendor model, the company\_id shall be set to 0xFFFF. This function can only be called after the device is provisioned.

---

#### 参数

- **element\_addr** -- [in] Node local element address
  - **company\_id** -- [in] Node local company id
  - **model\_id** -- [in] Node local model id
  - **app\_idx** -- [in] Node local appkey index
- 返回 ESP\_OK on success or error code otherwise.

## Low Power Operation (Updating)

## Header File

- [components/bt/esp\\_ble\\_mesh/api/core/include/esp\\_ble\\_mesh\\_low\\_power\\_api.h](#)
- This header file can be included with:

```
#include "esp_ble_mesh_low_power_api.h"
```

- This header file is a part of the API provided by the `bt` component. To declare that your component depends on `bt`, add the following to your `CMakeLists.txt`:

```
REQUIRES bt
```

or

```
PRIV_REQUIRES bt
```

## Functions

*esp\_err\_t* **esp\_ble\_mesh\_lpn\_enable** (void)

Enable BLE Mesh device LPN functionality.

---

**备注:** This API enables LPN functionality. Once called, the proper Friend Request will be sent.

---

**返回** ESP\_OK on success or error code otherwise.

*esp\_err\_t* **esp\_ble\_mesh\_lpn\_disable** (bool force)

Disable BLE Mesh device LPN functionality.

**参数** **force** -- [in] when disabling LPN functionality, use this flag to indicate whether directly clear corresponding information or just send friend clear to disable it if friendship has already been established.

**返回** ESP\_OK on success or error code otherwise.

*esp\_err\_t* **esp\_ble\_mesh\_lpn\_poll** (void)

LPN tries to poll messages from the Friend Node.

---

**备注:** The Friend Poll message is sent by a Low Power node to ask the Friend node to send a message that it has stored for the Low Power node. Users can call this API to send Friend Poll message manually. If this API is not invoked, the bottom layer of the Low Power node will send Friend Poll before the PollTimeout timer expires. If the corresponding Friend Update is received and MD is set to 0, which means there are no messages for the Low Power node, then the Low Power node will stop scanning.

---

**返回** ESP\_OK on success or error code otherwise.

## Send/Publish Messages, Add Local AppKey, Etc.

### Header File

- [components/bt/esp\\_ble\\_mesh/api/core/include/esp\\_ble\\_mesh\\_networking\\_api.h](#)
- This header file can be included with:

```
#include "esp_ble_mesh_networking_api.h"
```

- This header file is a part of the API provided by the `bt` component. To declare that your component depends on `bt`, add the following to your `CMakeLists.txt`:

```
REQUIRES bt
```

or

---

```
PRIV_REQUIRES bt
```

---

## Functions

*esp\_err\_t* **esp\_ble\_mesh\_register\_custom\_model\_callback** (*esp\_ble\_mesh\_model\_cb\_t* callback)

Register BLE Mesh callback for user-defined models' operations. This callback can report the following events generated for the user-defined models:

- Call back the messages received by user-defined client and server models to the application layer;
- If users call `esp_ble_mesh_server/client_model_send`, this callback notifies the application layer of the `send_complete` event;
- If user-defined client model sends a message that requires response, and the response message is received after the timer expires, the response message will be reported to the application layer as published by a peer device;
- If the user-defined client model fails to receive the response message during a specified period of time, a timeout event will be reported to the application layer.

---

**备注:** The client models (i.e. Config Client model, Health Client model, Generic Client models, Sensor Client model, Scene Client model and Lighting Client models) that have been realized internally have their specific register functions. For example, `esp_ble_mesh_register_config_client_callback` is the register function for Config Client Model.

---

**参数** `callback` -- [in] Pointer to the callback function.

**返回** ESP\_OK on success or error code otherwise.

*esp\_err\_t* **esp\_ble\_mesh\_model\_msg\_opcode\_init** (uint8\_t \*data, uint32\_t opcode)

Add the message opcode to the beginning of the model message before sending or publishing the model message.

---

**备注:** This API is only used to set the opcode of the message.

---

**参数**

- `data` -- [in] Pointer to the message data.
- `opcode` -- [in] The message opcode.

**返回** ESP\_OK on success or error code otherwise.

*esp\_err\_t* **esp\_ble\_mesh\_client\_model\_init** (*esp\_ble\_mesh\_model\_t* \*model)

Initialize the user-defined client model. All user-defined client models shall call this function to initialize the client model internal data. Node: Before calling this API, the `op_pair_size` and `op_pair` variables within the `user_data` (defined using `esp_ble_mesh_client_t_`) of the client model need to be initialized.

**参数** `model` -- [in] BLE Mesh Client model to which the message belongs.

**返回** ESP\_OK on success or error code otherwise.

*esp\_err\_t* **esp\_ble\_mesh\_client\_model\_deinit** (*esp\_ble\_mesh\_model\_t* \*model)

De-initialize the user-defined client model.

---

**备注:** This function shall be invoked before `esp_ble_mesh_deinit()` is called.

---

**参数** `model` -- [in] Pointer of the Client model.

**返回** ESP\_OK on success or error code otherwise.

```
esp_err_t esp_ble_mesh_server_model_send_msg(esp_ble_mesh_model_t *model,
                                             esp_ble_mesh_msg_ctx_t *ctx, uint32_t opcode,
                                             uint16_t length, uint8_t *data)
```

Send server model messages(such as server model status messages).

#### 参数

- **model** -- [in] BLE Mesh Server Model to which the message belongs.
- **ctx** -- [in] Message context, includes keys, TTL, etc.
- **opcode** -- [in] Message opcode.
- **length** -- [in] Message length (exclude the message opcode).
- **data** -- [in] Parameters of Access Payload (exclude the message opcode) to be sent.

返回 ESP\_OK on success or error code otherwise.

```
esp_err_t esp_ble_mesh_client_model_send_msg(esp_ble_mesh_model_t *model,
                                             esp_ble_mesh_msg_ctx_t *ctx, uint32_t opcode,
                                             uint16_t length, uint8_t *data, int32_t
                                             msg_timeout, bool need_rsp,
                                             esp_ble_mesh_dev_role_t device_role)
```

Send client model message (such as model get, set, etc).

#### 参数

- **model** -- [in] BLE Mesh Client Model to which the message belongs.
- **ctx** -- [in] Message context, includes keys, TTL, etc.
- **opcode** -- [in] Message opcode.
- **length** -- [in] Message length (exclude the message opcode).
- **data** -- [in] Parameters of the Access Payload (exclude the message opcode) to be sent.
- **msg\_timeout** -- [in] Time to get response to the message (in milliseconds).
- **need\_rsp** -- [in] TRUE if the opcode requires the peer device to reply, FALSE otherwise.
- **device\_role** -- [in] Role of the device (Node/Provisioner) that sends the message.

返回 ESP\_OK on success or error code otherwise.

```
esp_err_t esp_ble_mesh_model_publish(esp_ble_mesh_model_t *model, uint32_t opcode, uint16_t
                                     length, uint8_t *data, esp_ble_mesh_dev_role_t device_role)
```

Send a model publication message.

---

**备注:** Before calling this function, the user needs to ensure that the model publication message (*esp\_ble\_mesh\_model\_pub\_t::msg*) contains a valid message to be sent. And if users want to update the publishing message, this API should be called in ESP\_BLE\_MESH\_MODEL\_PUBLISH\_UPDATE\_EVT with the message updated.

---

#### 参数

- **model** -- [in] Mesh (client) Model publishing the message.
- **opcode** -- [in] Message opcode.
- **length** -- [in] Message length (exclude the message opcode).
- **data** -- [in] Parameters of the Access Payload (exclude the message opcode) to be sent.
- **device\_role** -- [in] Role of the device (node/provisioner) publishing the message of the type *esp\_ble\_mesh\_dev\_role\_t*.

返回 ESP\_OK on success or error code otherwise.

```
esp_err_t esp_ble_mesh_server_model_update_state(esp_ble_mesh_model_t *model,
                                                  esp_ble_mesh_server_state_type_t type,
                                                  esp_ble_mesh_server_state_value_t *value)
```

Update a server model state value. If the model publication state is set properly (e.g. publish address is set to a valid address), it will publish corresponding status message.

---

**备注:** Currently this API is used to update bound state value, not for all server model states.

---

**参数**

- **model** -- **[in]** Server model which is going to update the state.
- **type** -- **[in]** Server model state type.
- **value** -- **[in]** Server model state value.

**返回** ESP\_OK on success or error code otherwise.

*esp\_err\_t* **esp\_ble\_mesh\_node\_local\_reset** (void)

Reset the provisioning procedure of the local BLE Mesh node.

---

**备注:** All provisioning information in this node will be deleted and the node needs to be re-provisioned. The API function `esp_ble_mesh_node_prov_enable()` needs to be called to start a new provisioning procedure.

---

**返回** ESP\_OK on success or error code otherwise.

*esp\_err\_t* **esp\_ble\_mesh\_provisioner\_set\_node\_name** (uint16\_t index, const char \*name)

This function is called to set the node (provisioned device) name.

---

**备注:** index is obtained from the parameters of ESP\_BLE\_MESH\_PROVISIONER\_PROV\_COMPLETE\_EVT.

---

**参数**

- **index** -- **[in]** Index of the node in the node queue.
- **name** -- **[in]** Name (end by '\0') to be set for the node.

**返回** ESP\_OK on success or error code otherwise.

const char \***esp\_ble\_mesh\_provisioner\_get\_node\_name** (uint16\_t index)

This function is called to get the node (provisioned device) name.

---

**备注:** index is obtained from the parameters of ESP\_BLE\_MESH\_PROVISIONER\_PROV\_COMPLETE\_EVT.

---

**参数** **index** -- **[in]** Index of the node in the node queue.

**返回** Node name on success, or NULL on failure.

uint16\_t **esp\_ble\_mesh\_provisioner\_get\_node\_index** (const char \*name)

This function is called to get the node (provisioned device) index.

**参数** **name** -- **[in]** Name of the node (end by '\0').

**返回** Node index on success, or an invalid value (0xFFFF) on failure.

*esp\_err\_t* **esp\_ble\_mesh\_provisioner\_store\_node\_comp\_data** (uint16\_t unicast\_addr, uint8\_t \*data, uint16\_t length)

This function is called to store the Composition Data of the node.

**参数**

- **unicast\_addr** -- **[in]** Element address of the node
- **data** -- **[in]** Pointer of Composition Data
- **length** -- **[in]** Length of Composition Data

**返回** ESP\_OK on success or error code otherwise.

*esp\_ble\_mesh\_node\_t* \***esp\_ble\_mesh\_provisioner\_get\_node\_with\_uuid** (const uint8\_t uuid[16])

This function is called to get the provisioned node information with the node device uuid.

**参数** **uuid** -- [in] Device UUID of the node  
**返回** Pointer of the node info struct or NULL on failure.

*esp\_ble\_mesh\_node\_t* \***esp\_ble\_mesh\_provisioner\_get\_node\_with\_addr** (uint16\_t unicast\_addr)

This function is called to get the provisioned node information with the node unicast address.

**参数** **unicast\_addr** -- [in] Unicast address of the node  
**返回** Pointer of the node info struct or NULL on failure.

*esp\_ble\_mesh\_node\_t* \***esp\_ble\_mesh\_provisioner\_get\_node\_with\_name** (const char \*name)

This function is called to get the provisioned node information with the node name.

**参数** **name** -- [in] Name of the node (end by '\0').  
**返回** Pointer of the node info struct or NULL on failure.

uint16\_t **esp\_ble\_mesh\_provisioner\_get\_prov\_node\_count** (void)

This function is called by Provisioner to get provisioned node count.

**返回** Number of the provisioned nodes.

const *esp\_ble\_mesh\_node\_t* \*\***esp\_ble\_mesh\_provisioner\_get\_node\_table\_entry** (void)

This function is called by Provisioner to get the entry of the node table.

---

**备注:** After invoking the function to get the entry of nodes, users can use the "for" loop combined with the macro `CONFIG_BLE_MESH_MAX_PROV_NODES` to get each node's information. Before trying to read the node's information, users need to check if the node exists, i.e. if the `*(esp_ble_mesh_node_t **node)` is NULL. For example: “ const *esp\_ble\_mesh\_node\_t* \*\*entry = esp\_ble\_mesh\_provisioner\_get\_node\_table\_entry(); for (int i = 0; i < CONFIG\_BLE\_MESH\_MAX\_PROV\_NODES; i++) { const *esp\_ble\_mesh\_node\_t* \*node = entry[i]; if (node) { ..... } } ”

---

**返回** Pointer to the start of the node table.

*esp\_err\_t* **esp\_ble\_mesh\_provisioner\_delete\_node\_with\_uuid** (const uint8\_t uuid[16])

This function is called to delete the provisioned node information with the node device uuid.

**参数** **uuid** -- [in] Device UUID of the node  
**返回** ESP\_OK on success or error code otherwise.

*esp\_err\_t* **esp\_ble\_mesh\_provisioner\_delete\_node\_with\_addr** (uint16\_t unicast\_addr)

This function is called to delete the provisioned node information with the node unicast address.

**参数** **unicast\_addr** -- [in] Unicast address of the node  
**返回** ESP\_OK on success or error code otherwise.

*esp\_err\_t* **esp\_ble\_mesh\_provisioner\_add\_local\_app\_key** (const uint8\_t app\_key[16], uint16\_t net\_idx, uint16\_t app\_idx)

This function is called to add a local AppKey for Provisioner.

---

**备注:** **app\_key:** If set to NULL, app\_key will be generated internally. **net\_idx:** Should be an existing one. **app\_idx:** If it is going to be generated internally, it should be set to 0xFFFF, and the new app\_idx will be reported via an event.

---

**参数**

- **app\_key** -- [in] The app key to be set for the local BLE Mesh stack.
- **net\_idx** -- [in] The network key index.

- **app\_idx** -- [in] The app key index.
- 返回 ESP\_OK on success or error code otherwise.

*esp\_err\_t* **esp\_ble\_mesh\_provisioner\_update\_local\_app\_key** (const uint8\_t app\_key[16],  
uint16\_t net\_idx, uint16\_t  
app\_idx)

This function is used to update a local AppKey for Provisioner.

#### 参数

- **app\_key** -- [in] Value of the AppKey.
- **net\_idx** -- [in] Corresponding NetKey Index.
- **app\_idx** -- [in] The AppKey Index

返回 ESP\_OK on success or error code otherwise.

const uint8\_t \***esp\_ble\_mesh\_provisioner\_get\_local\_app\_key** (uint16\_t net\_idx, uint16\_t  
app\_idx)

This function is called by Provisioner to get the local app key value.

#### 参数

- **net\_idx** -- [in] Network key index.
- **app\_idx** -- [in] Application key index.

返回 App key on success, or NULL on failure.

*esp\_err\_t* **esp\_ble\_mesh\_provisioner\_bind\_app\_key\_to\_local\_model** (uint16\_t element\_addr,  
uint16\_t app\_idx,  
uint16\_t model\_id,  
uint16\_t company\_id)

This function is called by Provisioner to bind own model with proper app key.

---

**备注:** company\_id: If going to bind app\_key with local vendor model, company\_id should be set to 0xFFFFF.

---

#### 参数

- **element\_addr** -- [in] Provisioner local element address
- **app\_idx** -- [in] Provisioner local appkey index
- **model\_id** -- [in] Provisioner local model id
- **company\_id** -- [in] Provisioner local company id

返回 ESP\_OK on success or error code otherwise.

*esp\_err\_t* **esp\_ble\_mesh\_provisioner\_add\_local\_net\_key** (const uint8\_t net\_key[16], uint16\_t  
net\_idx)

This function is called by Provisioner to add local network key.

---

**备注:** net\_key: If set to NULL, net\_key will be generated internally. net\_idx: If it is going to be generated internally, it should be set to 0xFFFF, and the new net\_idx will be reported via an event.

---

#### 参数

- **net\_key** -- [in] The network key to be added to the Provisioner local BLE Mesh stack.
- **net\_idx** -- [in] The network key index.

返回 ESP\_OK on success or error code otherwise.

*esp\_err\_t* **esp\_ble\_mesh\_provisioner\_update\_local\_net\_key** (const uint8\_t net\_key[16],  
uint16\_t net\_idx)

This function is called by Provisioner to update a local network key.

#### 参数

- **net\_key** -- [in] Value of the NetKey.

- **net\_idx** -- [in] The NetKey Index.

返回 ESP\_OK on success or error code otherwise.

const uint8\_t \***esp\_ble\_mesh\_provisioner\_get\_local\_net\_key** (uint16\_t net\_idx)

This function is called by Provisioner to get the local network key value.

参数 **net\_idx** -- [in] Network key index.

返回 Network key on success, or NULL on failure.

*esp\_err\_t* **esp\_ble\_mesh\_provisioner\_recv\_heartbeat** (bool enable)

This function is called by Provisioner to enable or disable receiving heartbeat messages.

---

**备注:** If enabling receiving heartbeat message successfully, the filter will be an empty rejectlist by default, which means all heartbeat messages received by the Provisioner will be reported to the application layer.

---

参数 **enable** -- [in] Enable or disable receiving heartbeat messages.

返回 ESP\_OK on success or error code otherwise.

*esp\_err\_t* **esp\_ble\_mesh\_provisioner\_set\_heartbeat\_filter\_type** (uint8\_t type)

This function is called by Provisioner to set the heartbeat filter type.

---

**备注:** 1. If the filter type is not the same with the current value, then all the filter entries will be cleaned.

- If the previous type is rejectlist, and changed to acceptlist, then the filter will be an empty acceptlist, which means no heartbeat messages will be reported. Users need to add SRC or DST into the filter entry, then heartbeat messages from the SRC or to the DST will be reported.
- 

参数 **type** -- [in] Heartbeat filter type (acceptlist or rejectlist).

返回 ESP\_OK on success or error code otherwise.

*esp\_err\_t* **esp\_ble\_mesh\_provisioner\_set\_heartbeat\_filter\_info** (uint8\_t op,  
*esp\_ble\_mesh\_heartbeat\_filter\_info\_t*  
 \*info))

This function is called by Provisioner to add or remove a heartbeat filter entry.

- If the operation is "REMOVE", the "hb\_src" can be set to the SRC (can only be a unicast address) of heartbeat messages, and the "hb\_dst" can be set to the DST (unicast address or group address), at least one of them needs to be set.
    - The filter entry with the same SRC or DST will be removed.
- 

**备注:** 1. If the operation is "ADD", the "hb\_src" can be set to the SRC (can only be a unicast address) of heartbeat messages, and the "hb\_dst" can be set to the DST (unicast address or group address), at least one of them needs to be set.

- If only one of them is set, the filter entry will only use the configured SRC or DST to filter heartbeat messages.
  - If both of them are set, the SRC and DST will both be used to decide if a heartbeat message will be handled.
  - If SRC or DST already exists in some filter entry, then the corresponding entry will be cleaned firstly, then a new entry will be allocated to store the information.
- 

参数

- **op** -- [in] Add or REMOVE



- **info** -- **[in]** Heartbeat filter entry information, including: hb\_src - Heartbeat source address; hb\_dst - Heartbeat destination address;
- 返回 ESP\_OK on success or error code otherwise.

*esp\_err\_t* **esp\_ble\_mesh\_provisioner\_direct\_erase\_settings** (void)

This function is called by Provisioner to directly erase the mesh information from nvs namespace.

---

**备注:** This function can be invoked when the mesh stack is not initialized or has been de-initialized.

---

返回 ESP\_OK on success or error code otherwise.

*esp\_err\_t* **esp\_ble\_mesh\_provisioner\_open\_settings\_with\_index** (uint8\_t index)

This function is called by Provisioner to open a nvs namespace for storing mesh information.

---

**备注:** Before open another nvs namespace, the previously opened nvs namespace must be closed firstly.

---

**参数 index** -- **[in]** Settings index.

返回 ESP\_OK on success or error code otherwise.

*esp\_err\_t* **esp\_ble\_mesh\_provisioner\_open\_settings\_with\_uid** (const char \*uid)

This function is called by Provisioner to open a nvs namespace for storing mesh information.

---

**备注:** Before open another nvs namespace, the previously opened nvs namespace must be closed firstly.

---

**参数 uid** -- **[in]** Settings user id.

返回 ESP\_OK on success or error code otherwise.

*esp\_err\_t* **esp\_ble\_mesh\_provisioner\_close\_settings\_with\_index** (uint8\_t index, bool erase)

This function is called by Provisioner to close a nvs namespace which is opened previously for storing mesh information.

---

**备注:** 1. Before closing the nvs namespace, it must be open.

- When the function is invoked, the Provisioner functionality will be disabled firstly, and: a) If the "erase" flag is set to false, the mesh information will be cleaned (e.g. removing NetKey, AppKey, nodes, etc) from the mesh stack. b) If the "erase" flag is set to true, the mesh information stored in the nvs namespace will also be erased besides been cleaned from the mesh stack.
  - If Provisioner tries to work properly again, we can invoke the open function to open a new nvs namespace or a previously added one, and restore the mesh information from it if not erased.
  - The working process shall be as following: a) Open settings A b) Start to provision and control nodes c) Close settings A d) Open settings B e) Start to provision and control other nodes f) Close settings B g) .....
- 

**参数**

- **index** -- **[in]** Settings index.
- **erase** -- **[in]** Indicate if erasing mesh information.

返回 ESP\_OK on success or error code otherwise.

`esp_err_t esp_ble_mesh_provisioner_close_settings_with_uid` (const char \*uid, bool erase)

This function is called by Provisioner to close a nvs namespace which is opened previously for storing mesh information.

---

**备注:** 1. Before closing the nvs namespace, it must be open.

- a. When the function is invoked, the Provisioner functionality will be disabled firstly, and: a) If the "erase" flag is set to false, the mesh information will be cleaned (e.g. removing NetKey, AppKey, nodes, etc) from the mesh stack. b) If the "erase" flag is set to true, the mesh information stored in the nvs namespace will also be erased besides been cleaned from the mesh stack.
- b. If Provisioner tries to work properly again, we can invoke the open function to open a new nvs namespace or a previously added one, and restore the mesh information from it if not erased.
- c. The working process shall be as following: a) Open settings A b) Start to provision and control nodes c) Close settings A d) Open settings B e) Start to provision and control other nodes f) Close settings B g) .....

---

**参数**

- **uid** -- [in] Settings user id.
- **erase** -- [in] Indicate if erasing mesh information.

**返回** ESP\_OK on success or error code otherwise.

`esp_err_t esp_ble_mesh_provisioner_delete_settings_with_index` (uint8\_t index)

This function is called by Provisioner to erase the mesh information and settings user id from a nvs namespace.

---

**备注:** When this function is called, the nvs namespace must not be open. This function is used to erase the mesh information and settings user id which are not used currently.

---

**参数** **index** -- [in] Settings index.

**返回** ESP\_OK on success or error code otherwise.

`esp_err_t esp_ble_mesh_provisioner_delete_settings_with_uid` (const char \*uid)

This function is called by Provisioner to erase the mesh information and settings user id from a nvs namespace.

---

**备注:** When this function is called, the nvs namespace must not be open. This function is used to erase the mesh information and settings user id which are not used currently.

---

**参数** **uid** -- [in] Settings user id.

**返回** ESP\_OK on success or error code otherwise.

const char \*`esp_ble_mesh_provisioner_get_settings_uid` (uint8\_t index)

This function is called by Provisioner to get settings user id.

**参数** **index** -- [in] Settings index.

**返回** Setting user id on success or NULL on failure.

uint8\_t `esp_ble_mesh_provisioner_get_settings_index` (const char \*uid)

This function is called by Provisioner to get settings index.

**参数** **uid** -- [in] Settings user id.

**返回** Settings index.

uint8\_t `esp_ble_mesh_provisioner_get_free_settings_count` (void)

This function is called by Provisioner to get the number of free settings user id.

**返回** Number of free settings user id.

```
const uint8_t *esp_ble_mesh_get_fast_prov_app_key (uint16_t net_idx, uint16_t app_idx)
```

This function is called to get fast provisioning application key.

#### 参数

- **net\_idx** -- [in] Network key index.
- **app\_idx** -- [in] Application key index.

返回 Application key on success, or NULL on failure.

### Type Definitions

```
typedef void (*esp_ble_mesh_model_cb_t)(esp_ble_mesh_model_cb_event_t event,  
esp_ble_mesh_model_cb_param_t *param)
```

: event, event code of user-defined model events; param, parameters of user-defined model events

### ESP-BLE-MESH Node/Provisioner Provisioning

#### Header File

- components/bt/esp\_ble\_mesh/api/core/include/esp\_ble\_mesh\_provisioning\_api.h
- This header file can be included with:

```
#include "esp_ble_mesh_provisioning_api.h"
```

- This header file is a part of the API provided by the `bt` component. To declare that your component depends on `bt`, add the following to your CMakeLists.txt:

```
REQUIRES bt
```

or

```
PRIV_REQUIRES bt
```

#### Functions

```
esp_err_t esp_ble_mesh_register_prov_callback (esp_ble_mesh_prov_cb_t callback)
```

Register BLE Mesh provisioning callback.

参数 **callback** -- [in] Pointer to the callback function.

返回 ESP\_OK on success or error code otherwise.

```
bool esp_ble_mesh_node_is_provisioned (void)
```

Check if a device has been provisioned.

返回 TRUE if the device is provisioned, FALSE if the device is unprovisioned.

```
esp_err_t esp_ble_mesh_node_prov_enable (esp_ble_mesh_prov_bearer_t bearers)
```

Enable specific provisioning bearers to get the device ready for provisioning.

---

备注: PB-ADV: send unprovisioned device beacon. PB-GATT: send connectable advertising packets.

---

参数 **bearers** -- Bit-wise OR of provisioning bearers.

返回 ESP\_OK on success or error code otherwise.

```
esp_err_t esp_ble_mesh_node_prov_disable (esp_ble_mesh_prov_bearer_t bearers)
```

Disable specific provisioning bearers to make a device inaccessible for provisioning.

参数 **bearers** -- Bit-wise OR of provisioning bearers.

返回 ESP\_OK on success or error code otherwise.

*esp\_err\_t* **esp\_ble\_mesh\_node\_set\_oob\_pub\_key** (uint8\_t pub\_key\_x[32], uint8\_t pub\_key\_y[32],  
uint8\_t private\_key[32])

Unprovisioned device set own oob public key & private key pair.

---

**备注:** In order to avoid suffering brute-forcing attack (CVE-2020-26559). The Bluetooth SIG recommends that potentially vulnerable mesh provisioners use an out-of-band mechanism to exchange the public keys. So as an unprovisioned device, it should use this function to input the Public Key exchanged through the out-of-band mechanism.

---

**参数**

- **pub\_key\_x** -- [in] Unprovisioned device's Public Key X
- **pub\_key\_y** -- [in] Unprovisioned device's Public Key Y
- **private\_key** -- [in] Unprovisioned device's Private Key

**返回** ESP\_OK on success or error code otherwise.

*esp\_err\_t* **esp\_ble\_mesh\_node\_input\_number** (uint32\_t number)

Provide provisioning input OOB number.

---

**备注:** This is intended to be called if the user has received ESP\_BLE\_MESH\_NODE\_PROV\_INPUT\_EVT with ESP\_BLE\_MESH\_ENTER\_NUMBER as the action.

---

**参数** **number** -- [in] Number input by device.

**返回** ESP\_OK on success or error code otherwise.

*esp\_err\_t* **esp\_ble\_mesh\_node\_input\_string** (const char \*string)

Provide provisioning input OOB string.

---

**备注:** This is intended to be called if the user has received ESP\_BLE\_MESH\_NODE\_PROV\_INPUT\_EVT with ESP\_BLE\_MESH\_ENTER\_STRING as the action.

---

**参数** **string** -- [in] String input by device.

**返回** ESP\_OK on success or error code otherwise.

*esp\_err\_t* **esp\_ble\_mesh\_set\_unprovisioned\_device\_name** (const char \*name)

Using this function, an unprovisioned device can set its own device name, which will be broadcasted in its advertising data.

---

**备注:** This API applicable to PB-GATT mode only by setting the name to the scan response data, it doesn't apply to PB-ADV mode.

---

**参数** **name** -- [in] Unprovisioned device name

**返回** ESP\_OK on success or error code otherwise.

*esp\_err\_t* **esp\_ble\_mesh\_provisioner\_read\_oob\_pub\_key** (uint8\_t link\_idx, uint8\_t pub\_key\_x[32],  
uint8\_t pub\_key\_y[32])

Provisioner inputs unprovisioned device's oob public key.

---

**备注:** In order to avoid suffering brute-forcing attack (CVE-2020-26559). The Bluetooth SIG recommends that potentially vulnerable mesh provisioners use an out-of-band mechanism to exchange the public keys.

---

**参数**

- **link\_idx** -- [in] The provisioning link index
- **pub\_key\_x** -- [in] Unprovisioned device's Public Key X
- **pub\_key\_y** -- [in] Unprovisioned device's Public Key Y

返回 ESP\_OK on success or error code otherwise.

*esp\_err\_t* **esp\_ble\_mesh\_provisioner\_input\_string** (const char \*string, uint8\_t link\_idx)

Provide provisioning input OOB string.

```

        This is intended to be called after the esp_ble_mesh_prov_t prov_
        ↪input_num
        callback has been called with ESP_BLE_MESH_ENTER_STRING as the_
        ↪action.

```

**参数**

- **string** -- [in] String input by Provisioner.
- **link\_idx** -- [in] The provisioning link index.

返回 ESP\_OK on success or error code otherwise.

*esp\_err\_t* **esp\_ble\_mesh\_provisioner\_input\_number** (uint32\_t number, uint8\_t link\_idx)

Provide provisioning input OOB number.

```

        This is intended to be called after the esp_ble_mesh_prov_t prov_
        ↪input_num
        callback has been called with ESP_BLE_MESH_ENTER_NUMBER as the_
        ↪action.

```

**参数**

- **number** -- [in] Number input by Provisioner.
- **link\_idx** -- [in] The provisioning link index.

返回 ESP\_OK on success or error code otherwise.

*esp\_err\_t* **esp\_ble\_mesh\_provisioner\_prov\_enable** (*esp\_ble\_mesh\_prov\_bearer\_t* bearers)

Enable one or more provisioning bearers.

---

**备注:** PB-ADV: Enable BLE scan. PB-GATT: Initialize corresponding BLE Mesh Proxy info.

---

**参数 bearers** -- [in] Bit-wise OR of provisioning bearers.

返回 ESP\_OK on success or error code otherwise.

*esp\_err\_t* **esp\_ble\_mesh\_provisioner\_prov\_disable** (*esp\_ble\_mesh\_prov\_bearer\_t* bearers)

Disable one or more provisioning bearers.

---

**备注:** PB-ADV: Disable BLE scan. PB-GATT: Break any existing BLE Mesh Provisioning connections.

---

**参数 bearers** -- [in] Bit-wise OR of provisioning bearers.

返回 ESP\_OK on success or error code otherwise.

*esp\_err\_t* **esp\_ble\_mesh\_provisioner\_add\_unprov\_dev** (*esp\_ble\_mesh\_unprov\_dev\_add\_t* \*add\_dev, *esp\_ble\_mesh\_dev\_add\_flag\_t* flags)

Add unprovisioned device info to the unprov\_dev queue.

---

**备注:** : 1. Currently address type only supports public address and static random address.

---

- a. If device UUID and/or device address as well as address type already exist in the device queue, but the bearer is different from the existing one, add operation will also be successful and it will update the provision bearer supported by the device.
- b. For example, if the Provisioner wants to add an unprovisioned device info before receiving its unprovisioned device beacon or Mesh Provisioning advertising packets, the Provisioner can use this API to add the device info with each one or both of device UUID and device address added. When the Provisioner gets the device's advertising packets, it will start provisioning the device internally.
  - In this situation, the Provisioner can set bearers with each one or both of ESP\_BLE\_MESH\_PROV\_ADV and ESP\_BLE\_MESH\_PROV\_GATT enabled, and cannot set flags with ADD\_DEV\_START\_PROV\_NOW\_FLAG enabled.
- c. Another example is when the Provisioner receives the unprovisioned device's beacon or Mesh Provisioning advertising packets, the advertising packets will be reported on to the application layer using the callback registered by the function `esp_ble_mesh_register_prov_callback`. And in the callback, the Provisioner can call this API to start provisioning the device.
  - If the Provisioner uses PB-ADV to provision, either one or both of device UUID and device address can be added, bearers shall be set with ESP\_BLE\_MESH\_PROV\_ADV enabled and the flags shall be set with ADD\_DEV\_START\_PROV\_NOW\_FLAG enabled.
  - If the Provisioner uses PB-GATT to provision, both the device UUID and device address need to be added, bearers shall be set with ESP\_BLE\_MESH\_PROV\_GATT enabled, and the flags shall be set with ADD\_DEV\_START\_PROV\_NOW\_FLAG enabled.
  - If the Provisioner just wants to store the unprovisioned device info when receiving its advertising packets and start to provision it the next time (e.g. after receiving its advertising packets again), then it can add the device info with either one or both of device UUID and device address included. Bearers can be set with either one or both of ESP\_BLE\_MESH\_PROV\_ADV and ESP\_BLE\_MESH\_PROV\_GATT enabled (recommend to enable the bearer which will receive its advertising packets, because if the other bearer is enabled, the Provisioner is not aware if the device supports the bearer), and flags cannot be set with ADD\_DEV\_START\_PROV\_NOW\_FLAG enabled.
  - Note: ESP\_BLE\_MESH\_PROV\_ADV, ESP\_BLE\_MESH\_PROV\_GATT and ADD\_DEV\_START\_PROV\_NOW\_FLAG can not be enabled at the same time.

### 参数

- **add\_dev** -- [in] Pointer to a struct containing the device information
- **flags** -- [in] Flags indicate several operations on the device information
  - Remove device information from queue after device has been provisioned (BIT0)
  - Start provisioning immediately after device is added to queue (BIT1)
  - Device can be removed if device queue is full (BIT2)

返回 ESP\_OK on success or error code otherwise.

`esp_err_t esp_ble_mesh_provisioner_prov_device_with_addr` (const uint8\_t uuid[16],  
`esp_ble_mesh_bd_addr_t` addr,  
`esp_ble_mesh_addr_type_t`  
 addr\_type,  
`esp_ble_mesh_prov_bearer_t`  
 bearer, uint16\_t oob\_info,  
 uint16\_t unicast\_addr)

Provision an unprovisioned device and assign a fixed unicast address for it in advance.

**备注:** : 1. Currently address type only supports public address and static random address.

- a. Bearer must be equal to ESP\_BLE\_MESH\_PROV\_ADV or ESP\_BLE\_MESH\_PROV\_GATT, since Provisioner will start to provision a device immediately once this function is invoked. And the input bearer must be identical with the one within the parameters of the ESP\_BLE\_MESH\_PROVISIONER\_RECV\_UNPROV\_ADV\_PKT\_EVT event.
- b. If this function is used by a Provisioner to provision devices, the application should take care of the assigned unicast address and avoid overlap of the unicast addresses of different nodes.

- c. Recommend to use only one of the functions "esp\_ble\_mesh\_provisioner\_add\_unprov\_dev" and "esp\_ble\_mesh\_provisioner\_prov\_device\_with\_addr" by a Provisioner.

#### 参数

- **uuid** -- [in] Device UUID of the unprovisioned device
- **addr** -- [in] Device address of the unprovisioned device
- **addr\_type** -- [in] Device address type of the unprovisioned device
- **bearer** -- [in] Provisioning bearer going to be used by Provisioner
- **oob\_info** -- [in] OOB info of the unprovisioned device
- **unicast\_addr** -- [in] Unicast address going to be allocated for the unprovisioned device

返回 Zero on success or (negative) error code otherwise.

*esp\_err\_t* **esp\_ble\_mesh\_provisioner\_delete\_dev** (*esp\_ble\_mesh\_device\_delete\_t* \*del\_dev)

Delete device from queue, and reset current provisioning link with the device.

**备注:** If the device is in the queue, remove it from the queue; if the device is being provisioned, terminate the provisioning procedure. Either one of the device address or device UUID can be used as input.

参数 **del\_dev** -- [in] Pointer to a struct containing the device information.

返回 ESP\_OK on success or error code otherwise.

*esp\_err\_t* **esp\_ble\_mesh\_provisioner\_set\_dev\_uuid\_match** (const uint8\_t \*match\_val, uint8\_t match\_len, uint8\_t offset, bool prov\_after\_match)

This function is called by Provisioner to set the part of the device UUID to be compared before starting to provision.

#### 参数

- **match\_val** -- [in] Value to be compared with the part of the device UUID.
- **match\_len** -- [in] Length of the compared match value.
- **offset** -- [in] Offset of the device UUID to be compared (based on zero).
- **prov\_after\_match** -- [in] Flag used to indicate whether provisioner should start to provision the device immediately if the part of the UUID matches.

返回 ESP\_OK on success or error code otherwise.

*esp\_err\_t* **esp\_ble\_mesh\_provisioner\_set\_prov\_data\_info** (*esp\_ble\_mesh\_prov\_data\_info\_t* \*prov\_data\_info)

This function is called by Provisioner to set provisioning data information before starting to provision.

参数 **prov\_data\_info** -- [in] Pointer to a struct containing net\_idx or flags or iv\_index.

返回 ESP\_OK on success or error code otherwise.

*esp\_err\_t* **esp\_ble\_mesh\_provisioner\_set\_static\_oob\_value** (const uint8\_t \*value, uint8\_t length)

This function is called by Provisioner to set static oob value used for provisioning.

AuthValues selected using a cryptographically secure random or pseudorandom number generator and having the maximum permitted entropy (128-bits) will be most difficult to brute-force. AuthValues with reduced entropy or generated in a predictable manner will not grant the same level of protection against this vulnerability. Selecting a new AuthValue with each provisioning attempt can also make it more difficult to launch a brute-force attack by requiring the attacker to restart the search with each provisioning attempt (CVE-2020-26556).

**备注:** The Bluetooth SIG recommends that mesh implementations enforce a randomly selected AuthValue using all of the available bits, where permitted by the implementation. A large entropy helps ensure that a



brute-force of the AuthValue, even a static AuthValue, cannot normally be completed in a reasonable time (CVE-2020-26557).

#### 参数

- **value** -- **[in]** Pointer to the static oob value.
- **length** -- **[in]** Length of the static oob value.

返回 ESP\_OK on success or error code otherwise.

*esp\_err\_t* **esp\_ble\_mesh\_provisioner\_set\_primary\_elem\_addr** (uint16\_t addr)

This function is called by Provisioner to set own Primary element address.

---

**备注:** This API must be invoked when BLE Mesh initialization is completed successfully, and can be invoked before Provisioner functionality is enabled. Once this API is invoked successfully, the prov\_unicast\_addr value in the struct *esp\_ble\_mesh\_prov\_t* will be ignored, and Provisioner will use this address as its own primary element address. And if the unicast address going to assigned for the next unprovisioned device is smaller than the input address + element number of Provisioner, then the address for the next unprovisioned device will be recalculated internally.

---

参数 **addr** -- **[in]** Unicast address of the Primary element of Provisioner.

返回 ESP\_OK on success or error code otherwise.

*esp\_err\_t* **esp\_ble\_mesh\_set\_fast\_prov\_info** (*esp\_ble\_mesh\_fast\_prov\_info\_t* \*fast\_prov\_info)

This function is called to set provisioning data information before starting fast provisioning.

参数 **fast\_prov\_info** -- **[in]** Pointer to a struct containing unicast address range, net\_idx, etc.

返回 ESP\_OK on success or error code otherwise.

*esp\_err\_t* **esp\_ble\_mesh\_set\_fast\_prov\_action** (*esp\_ble\_mesh\_fast\_prov\_action\_t* action)

This function is called to start/suspend/exit fast provisioning.

参数 **action** -- **[in]** fast provisioning action (i.e. enter, suspend, exit).

返回 ESP\_OK on success or error code otherwise.

### Type Definitions

```
typedef void (*esp_ble_mesh_prov_cb_t)(esp_ble_mesh_prov_cb_event_t event,
esp_ble_mesh_prov_cb_param_t *param)
```

: event, event code of provisioning events; param, parameters of provisioning events

```
typedef void (*esp_ble_mesh_prov_adv_cb_t)(const esp_ble_mesh_bd_addr_t addr, const
esp_ble_mesh_addr_type_t addr_type, const uint8_t adv_type, const uint8_t *dev_uuid, uint16_t oob_info,
esp_ble_mesh_prov_bearer_t bearer)
```

Callback for Provisioner that received advertising packets from unprovisioned devices which are not in the unprovisioned device queue.

Report on the unprovisioned device beacon and mesh provisioning service adv data to application.

**Param addr** **[in]** Pointer to the unprovisioned device address.

**Param addr\_type** **[in]** Unprovisioned device address type.

**Param adv\_type** **[in]** Adv packet type(ADV\_IND or ADV\_NONCONN\_IND).

**Param dev\_uuid** **[in]** Unprovisioned device UUID pointer.

**Param oob\_info** **[in]** OOB information of the unprovisioned device.

**Param bearer** **[in]** Adv packet received from PB-GATT or PB-ADV bearer.

### ESP-BLE-MESH GATT Proxy Server



## Header File

- `components/bt/esp_ble_mesh/api/core/include/esp_ble_mesh_proxy_api.h`
- This header file can be included with:

```
#include "esp_ble_mesh_proxy_api.h"
```

- This header file is a part of the API provided by the `bt` component. To declare that your component depends on `bt`, add the following to your `CMakeLists.txt`:

```
REQUIRES bt
```

or

```
PRIV_REQUIRES bt
```

## Functions

*esp\_err\_t* **esp\_ble\_mesh\_proxy\_identity\_enable** (void)

Enable advertising with Node Identity.

---

**备注:** This API requires that GATT Proxy support be enabled. Once called, each subnet starts advertising using Node Identity for the next 60 seconds, and after 60s Network ID will be advertised. Under normal conditions, the BLE Mesh Proxy Node Identity and Network ID advertising will be enabled automatically by BLE Mesh stack after the device is provisioned.

---

返回 ESP\_OK on success or error code otherwise.

*esp\_err\_t* **esp\_ble\_mesh\_proxy\_gatt\_enable** (void)

Enable BLE Mesh GATT Proxy Service.

返回 ESP\_OK on success or error code otherwise.

*esp\_err\_t* **esp\_ble\_mesh\_proxy\_gatt\_disable** (void)

Disconnect the BLE Mesh GATT Proxy connection if there is any, and disable the BLE Mesh GATT Proxy Service.

返回 ESP\_OK on success or error code otherwise.

*esp\_err\_t* **esp\_ble\_mesh\_private\_proxy\_identity\_enable** (void)

Enable advertising with Private Node Identity.

---

**备注:** This API requires that GATT Proxy support be enabled. Once called, each subnet starts advertising using Private Node Identity for the next 60 seconds, and after 60s Private Network ID will be advertised. Under normal conditions, the BLE Mesh Proxy Node Identity, Network ID advertising, Proxy Private Node Identity and Private Network ID advertising will be enabled automatically by BLE Mesh stack after the device is provisioned.

---

返回 ESP\_OK on success or error code otherwise.

*esp\_err\_t* **esp\_ble\_mesh\_private\_proxy\_identity\_disable** (void)

Disable advertising with Private Node Identity.

返回 ESP\_OK on success or error code otherwise.

*esp\_err\_t* **esp\_ble\_mesh\_proxy\_client\_connect** (*esp\_ble\_mesh\_bd\_addr\_t* addr,  
*esp\_ble\_mesh\_addr\_type\_t* addr\_type, uint16\_t  
net\_idx)

Proxy Client creates a connection with the Proxy Server.

**参数**

- **addr** -- **[in]** Device address of the Proxy Server.
- **addr\_type** -- **[in]** Device address type(public or static random).
- **net\_idx** -- **[in]** NetKey Index related with Network ID in the Mesh Proxy advertising packet.

**返回** ESP\_OK on success or error code otherwise.

*esp\_err\_t* **esp\_ble\_mesh\_proxy\_client\_disconnect** (uint8\_t conn\_handle)

Proxy Client terminates a connection with the Proxy Server.

**参数** **conn\_handle** -- **[in]** Proxy connection handle.

**返回** ESP\_OK on success or error code otherwise.

*esp\_err\_t* **esp\_ble\_mesh\_proxy\_client\_set\_filter\_type** (uint8\_t conn\_handle, uint16\_t net\_idx, *esp\_ble\_mesh\_proxy\_filter\_type\_t* filter\_type)

Proxy Client sets the filter type of the Proxy Server.

**参数**

- **conn\_handle** -- **[in]** Proxy connection handle.
- **net\_idx** -- **[in]** Corresponding NetKey Index.
- **filter\_type** -- **[in]** whitelist or blacklist.

**返回** ESP\_OK on success or error code otherwise.

*esp\_err\_t* **esp\_ble\_mesh\_proxy\_client\_add\_filter\_addr** (uint8\_t conn\_handle, uint16\_t net\_idx, uint16\_t \*addr, uint16\_t addr\_num)

Proxy Client adds address to the Proxy Server filter list.

**参数**

- **conn\_handle** -- **[in]** Proxy connection handle.
- **net\_idx** -- **[in]** Corresponding NetKey Index.
- **addr** -- **[in]** Pointer to the filter address.
- **addr\_num** -- **[in]** Number of the filter address.

**返回** ESP\_OK on success or error code otherwise.

*esp\_err\_t* **esp\_ble\_mesh\_proxy\_client\_remove\_filter\_addr** (uint8\_t conn\_handle, uint16\_t net\_idx, uint16\_t \*addr, uint16\_t addr\_num)

Proxy Client removes address from the Proxy Server filter list.

**参数**

- **conn\_handle** -- **[in]** Proxy connection handle.
- **net\_idx** -- **[in]** Corresponding NetKey Index.
- **addr** -- **[in]** Pointer to the filter address.
- **addr\_num** -- **[in]** Number of the filter address.

**返回** ESP\_OK on success or error code otherwise.

*esp\_err\_t* **esp\_ble\_mesh\_proxy\_client\_directed\_proxy\_set** (uint8\_t conn\_handle, uint16\_t net\_idx, uint8\_t use\_directed)

Proxy Client sets whether or not the Directed Proxy Server uses directed forwarding for Directed Proxy Client messages.

**参数**

- **conn\_handle** -- **[in]** Proxy connection handle.
- **net\_idx** -- **[in]** Corresponding NetKey Index.
- **use\_directed** -- **[in]** Whether or not to send message by directed forwarding.

**返回** ESP\_OK on success or error code otherwise.

*esp\_err\_t* **esp\_ble\_mesh\_proxy\_client\_send\_solic\_pdu** (uint8\_t net\_idx, uint16\_t src, uint16\_t dst)

Proxy Client sends Solicitation PDU.

**参数**

- **net\_idx** -- **[in]** Corresponding NetKey Index.
- **ssrc** -- **[in]** Solicitation SRC, shall be one of its element address.
- **dst** -- **[in]** Solicitation DST (TBD).

返回 ESP\_OK on success or error code otherwise.

**Macros**

ESP\_BLE\_MESH\_PROXY\_CLI\_DIRECTED\_FORWARDING\_ENABLE

ESP\_BLE\_MESH\_PROXY\_CLI\_DIRECTED\_FORWARDING\_DISABLE

**ESP-BLE-MESH Models API Reference**

This section contains ESP-BLE-MESH Model related APIs, event types, event parameters, etc.

There are six categories of models:

- *Configuration Client/Server Models*
- *Health Client/Server Models*
- *Generic Client/Server Models*
- *Sensor Client/Server Models*
- *Time and Scenes Client/Server Models*
- *Lighting Client/Server Models*

---

备注: Definitions related to Server Models are being updated, and will be released soon.

---

**Configuration Client/Server Models****Header File**

- `components/bt/esp_ble_mesh/api/models/include/esp_ble_mesh_config_model_api.h`
- This header file can be included with:

```
#include "esp_ble_mesh_config_model_api.h"
```

- This header file is a part of the API provided by the `bt` component. To declare that your component depends on `bt`, add the following to your `CMakeLists.txt`:

```
REQUIRES bt
```

or

```
PRIV_REQUIRES bt
```

**Functions**

`esp_err_t esp_ble_mesh_register_config_client_callback` (`esp_ble_mesh_cfg_client_cb_t` callback)

Register BLE Mesh Config Client Model callback.

参数 **callback** -- **[in]** Pointer to the callback function.

返回 ESP\_OK on success or error code otherwise.

`esp_err_t esp_ble_mesh_register_config_server_callback` (`esp_ble_mesh_cfg_server_cb_t` callback)

Register BLE Mesh Config Server Model callback.

参数 **callback** -- **[in]** Pointer to the callback function.

返回 ESP\_OK on success or error code otherwise.

*esp\_err\_t* **esp\_ble\_mesh\_config\_client\_get\_state** (*esp\_ble\_mesh\_client\_common\_param\_t* \*params, *esp\_ble\_mesh\_cfg\_client\_get\_state\_t* \*get\_state)

Get the value of Config Server Model states using the Config Client Model get messages.

---

备注: If you want to find the opcodes and corresponding meanings accepted by this API, please refer to *esp\_ble\_mesh\_opcode\_config\_client\_get\_t* in *esp\_ble\_mesh\_defs.h*

---

参数

- **params** -- **[in]** Pointer to BLE Mesh common client parameters.
- **get\_state** -- **[in]** Pointer to a union, each kind of opcode corresponds to one structure inside. Shall not be set to NULL.

返回 ESP\_OK on success or error code otherwise.

*esp\_err\_t* **esp\_ble\_mesh\_config\_client\_set\_state** (*esp\_ble\_mesh\_client\_common\_param\_t* \*params, *esp\_ble\_mesh\_cfg\_client\_set\_state\_t* \*set\_state)

Set the value of the Configuration Server Model states using the Config Client Model set messages.

---

备注: If you want to find the opcodes and corresponding meanings accepted by this API, please refer to *esp\_ble\_mesh\_opcode\_config\_client\_set\_t* in *esp\_ble\_mesh\_defs.h*

---

参数

- **params** -- **[in]** Pointer to BLE Mesh common client parameters.
- **set\_state** -- **[in]** Pointer to a union, each kind of opcode corresponds to one structure inside. Shall not be set to NULL.

返回 ESP\_OK on success or error code otherwise.

## Unions

union **esp\_ble\_mesh\_cfg\_client\_get\_state\_t**

```
#include <esp_ble_mesh_config_model_api.h> For ESP_BLE_MESH_MODEL_OP_BEACON_GET
ESP_BLE_MESH_MODEL_OP_COMPOSITION_DATA_GET ESP_BLE_MESH_MODEL_OP_DEFAULT_TTL_GET
ESP_BLE_MESH_MODEL_OP_GATT_PROXY_GET ESP_BLE_MESH_MODEL_OP_RELAY_GET
ESP_BLE_MESH_MODEL_OP_MODEL_PUB_GET ESP_BLE_MESH_MODEL_OP_FRIEND_GET
ESP_BLE_MESH_MODEL_OP_HEARTBEAT_PUB_GET ESP_BLE_MESH_MODEL_OP_HEARTBEAT_SUB_GET
the get_state parameter in the esp_ble_mesh_config_client_get_state function should not be set to NULL.
```

## Public Members

*esp\_ble\_mesh\_cfg\_model\_pub\_get\_t* **model\_pub\_get**

For ESP\_BLE\_MESH\_MODEL\_OP\_MODEL\_PUB\_GET.

*esp\_ble\_mesh\_cfg\_composition\_data\_get\_t* **comp\_data\_get**

For ESP\_BLE\_MESH\_MODEL\_OP\_COMPOSITION\_DATA\_GET.

*esp\_ble\_mesh\_cfg\_sig\_model\_sub\_get\_t* **sig\_model\_sub\_get**

For ESP\_BLE\_MESH\_MODEL\_OP\_SIG\_MODEL\_SUB\_GET

*esp\_ble\_mesh\_cfg\_vnd\_model\_sub\_get\_t* **vnd\_model\_sub\_get**

For ESP\_BLE\_MESH\_MODEL\_OP\_VENDOR\_MODEL\_SUB\_GET

*esp\_ble\_mesh\_cfg\_app\_key\_get\_t* **app\_key\_get**

For ESP\_BLE\_MESH\_MODEL\_OP\_APP\_KEY\_GET.

*esp\_ble\_mesh\_cfg\_node\_identity\_get\_t* **node\_identity\_get**

For ESP\_BLE\_MESH\_MODEL\_OP\_NODE\_IDENTITY\_GET.

*esp\_ble\_mesh\_cfg\_sig\_model\_app\_get\_t* **sig\_model\_app\_get**

For ESP\_BLE\_MESH\_MODEL\_OP\_SIG\_MODEL\_APP\_GET

*esp\_ble\_mesh\_cfg\_vnd\_model\_app\_get\_t* **vnd\_model\_app\_get**

For ESP\_BLE\_MESH\_MODEL\_OP\_VENDOR\_MODEL\_APP\_GET

*esp\_ble\_mesh\_cfg\_kr\_phase\_get\_t* **kr\_phase\_get**

For ESP\_BLE\_MESH\_MODEL\_OP\_KEY\_REFRESH\_PHASE\_GET

*esp\_ble\_mesh\_cfg\_lpn\_polltimeout\_get\_t* **lpn\_pollto\_get**

For ESP\_BLE\_MESH\_MODEL\_OP\_LPN\_POLLTIMEOUT\_GET

union **esp\_ble\_mesh\_cfg\_client\_set\_state\_t**

```
#include <esp_ble_mesh_config_model_api.h> For ESP_BLE_MESH_MODEL_OP_BEACON_SET
ESP_BLE_MESH_MODEL_OP_DEFAULT_TTL_SET ESP_BLE_MESH_MODEL_OP_GATT_PROXY_SET
ESP_BLE_MESH_MODEL_OP_RELAY_SET ESP_BLE_MESH_MODEL_OP_MODEL_PUB_SET
ESP_BLE_MESH_MODEL_OP_MODEL_SUB_ADD ESP_BLE_MESH_MODEL_OP_MODEL_SUB_VIRTUAL_ADDR
ESP_BLE_MESH_MODEL_OP_MODEL_SUB_DELETE ESP_BLE_MESH_MODEL_OP_MODEL_SUB_VIRTUAL_AD
ESP_BLE_MESH_MODEL_OP_MODEL_SUB_OVERWRITE ESP_BLE_MESH_MODEL_OP_MODEL_SUB_VIRTUAL
ESP_BLE_MESH_MODEL_OP_NET_KEY_ADD ESP_BLE_MESH_MODEL_OP_APP_KEY_ADD
ESP_BLE_MESH_MODEL_OP_MODEL_APP_BIND ESP_BLE_MESH_MODEL_OP_NODE_RESET
ESP_BLE_MESH_MODEL_OP_FRIEND_SET ESP_BLE_MESH_MODEL_OP_HEARTBEAT_PUB_SET
ESP_BLE_MESH_MODEL_OP_HEARTBEAT_SUB_SET the set_state parameter in the
esp_ble_mesh_config_client_set_state function should not be set to NULL.
```

## Public Members

*esp\_ble\_mesh\_cfg\_beacon\_set\_t* **beacon\_set**

For ESP\_BLE\_MESH\_MODEL\_OP\_BEACON\_SET

*esp\_ble\_mesh\_cfg\_default\_ttl\_set\_t* **default\_ttl\_set**

For ESP\_BLE\_MESH\_MODEL\_OP\_DEFAULT\_TTL\_SET

*esp\_ble\_mesh\_cfg\_friend\_set\_t* **friend\_set**

For ESP\_BLE\_MESH\_MODEL\_OP\_FRIEND\_SET

*esp\_ble\_mesh\_cfg\_gatt\_proxy\_set\_t* **gatt\_proxy\_set**

For ESP\_BLE\_MESH\_MODEL\_OP\_GATT\_PROXY\_SET

*esp\_ble\_mesh\_cfg\_relay\_set\_t* **relay\_set**

For ESP\_BLE\_MESH\_MODEL\_OP\_RELAY\_SET

*esp\_ble\_mesh\_cfg\_net\_key\_add\_t* **net\_key\_add**

For ESP\_BLE\_MESH\_MODEL\_OP\_NET\_KEY\_ADD

*esp\_ble\_mesh\_cfg\_app\_key\_add\_t* **app\_key\_add**

For ESP\_BLE\_MESH\_MODEL\_OP\_APP\_KEY\_ADD

*esp\_ble\_mesh\_cfg\_model\_app\_bind\_t* **model\_app\_bind**

For ESP\_BLE\_MESH\_MODEL\_OP\_MODEL\_APP\_BIND

*esp\_ble\_mesh\_cfg\_model\_pub\_set\_t* **model\_pub\_set**

For ESP\_BLE\_MESH\_MODEL\_OP\_MODEL\_PUB\_SET

*esp\_ble\_mesh\_cfg\_model\_sub\_add\_t* **model\_sub\_add**

For ESP\_BLE\_MESH\_MODEL\_OP\_MODEL\_SUB\_ADD

*esp\_ble\_mesh\_cfg\_model\_sub\_delete\_t* **model\_sub\_delete**

For ESP\_BLE\_MESH\_MODEL\_OP\_MODEL\_SUB\_DELETE

*esp\_ble\_mesh\_cfg\_model\_sub\_overwrite\_t* **model\_sub\_overwrite**

For ESP\_BLE\_MESH\_MODEL\_OP\_MODEL\_SUB\_OVERWRITE

*esp\_ble\_mesh\_cfg\_model\_sub\_va\_add\_t* **model\_sub\_va\_add**

For ESP\_BLE\_MESH\_MODEL\_OP\_MODEL\_SUB\_VIRTUAL\_ADDR\_ADD

*esp\_ble\_mesh\_cfg\_model\_sub\_va\_delete\_t* **model\_sub\_va\_delete**

For ESP\_BLE\_MESH\_MODEL\_OP\_MODEL\_SUB\_VIRTUAL\_ADDR\_DELETE

*esp\_ble\_mesh\_cfg\_model\_sub\_va\_overwrite\_t* **model\_sub\_va\_overwrite**

For ESP\_BLE\_MESH\_MODEL\_OP\_MODEL\_SUB\_VIRTUAL\_ADDR\_OVERWRITE

*esp\_ble\_mesh\_cfg\_heartbeat\_pub\_set\_t* **heartbeat\_pub\_set**

For ESP\_BLE\_MESH\_MODEL\_OP\_HEARTBEAT\_PUB\_SET

*esp\_ble\_mesh\_cfg\_heartbeat\_sub\_set\_t* **heartbeat\_sub\_set**

For ESP\_BLE\_MESH\_MODEL\_OP\_HEARTBEAT\_SUB\_SET

*esp\_ble\_mesh\_cfg\_model\_pub\_va\_set\_t* **model\_pub\_va\_set**

For ESP\_BLE\_MESH\_MODEL\_OP\_MODEL\_PUB\_VIRTUAL\_ADDR\_SET

*esp\_ble\_mesh\_cfg\_model\_sub\_delete\_all\_t* **model\_sub\_delete\_all**

For ESP\_BLE\_MESH\_MODEL\_OP\_MODEL\_SUB\_DELETE\_ALL

*esp\_ble\_mesh\_cfg\_net\_key\_update\_t* **net\_key\_update**

For ESP\_BLE\_MESH\_MODEL\_OP\_NET\_KEY\_UPDATE

*esp\_ble\_mesh\_cfg\_net\_key\_delete\_t* **net\_key\_delete**

For ESP\_BLE\_MESH\_MODEL\_OP\_NET\_KEY\_DELETE

*esp\_ble\_mesh\_cfg\_app\_key\_update\_t* **app\_key\_update**

For ESP\_BLE\_MESH\_MODEL\_OP\_APP\_KEY\_UPDATE

*esp\_ble\_mesh\_cfg\_app\_key\_delete\_t* **app\_key\_delete**

For ESP\_BLE\_MESH\_MODEL\_OP\_APP\_KEY\_DELETE

*esp\_ble\_mesh\_cfg\_node\_identity\_set\_t* **node\_identity\_set**

For ESP\_BLE\_MESH\_MODEL\_OP\_NODE\_IDENTITY\_SET

*esp\_ble\_mesh\_cfg\_model\_app\_unbind\_t* **model\_app\_unbind**

For ESP\_BLE\_MESH\_MODEL\_OP\_MODEL\_APP\_UNBIND

*esp\_ble\_mesh\_cfg\_kr\_phase\_set\_t* **kr\_phase\_set**

For ESP\_BLE\_MESH\_MODEL\_OP\_KEY\_REFRESH\_PHASE\_SET

*esp\_ble\_mesh\_cfg\_net\_transmit\_set\_t* **net\_transmit\_set**

For ESP\_BLE\_MESH\_MODEL\_OP\_NETWORK\_TRANSMIT\_SET

union **esp\_ble\_mesh\_cfg\_client\_common\_cb\_param\_t**

*#include <esp\_ble\_mesh\_config\_model\_api.h>* Configuration Client Model received message union.

### Public Members

*esp\_ble\_mesh\_cfg\_beacon\_status\_cb\_t* **beacon\_status**

The beacon status value

*esp\_ble\_mesh\_cfg\_comp\_data\_status\_cb\_t* **comp\_data\_status**

The composition data status value

*esp\_ble\_mesh\_cfg\_default\_ttl\_status\_cb\_t* **default\_ttl\_status**

The default\_ttl status value

*esp\_ble\_mesh\_cfg\_gatt\_proxy\_status\_cb\_t* **gatt\_proxy\_status**

The gatt\_proxy status value

*esp\_ble\_mesh\_cfg\_relay\_status\_cb\_t* **relay\_status**

The relay status value

*esp\_ble\_mesh\_cfg\_model\_pub\_status\_cb\_t* **model\_pub\_status**

The model publication status value

*esp\_ble\_mesh\_cfg\_model\_sub\_status\_cb\_t* **model\_sub\_status**

The model subscription status value

*esp\_ble\_mesh\_cfg\_net\_key\_status\_cb\_t* **netkey\_status**

The netkey status value

*esp\_ble\_mesh\_cfg\_app\_key\_status\_cb\_t* **appkey\_status**

The appkey status value

*esp\_ble\_mesh\_cfg\_mod\_app\_status\_cb\_t* **model\_app\_status**

The model app status value

*esp\_ble\_mesh\_cfg\_friend\_status\_cb\_t* **friend\_status**

The friend status value

*esp\_ble\_mesh\_cfg\_hb\_pub\_status\_cb\_t* **heartbeat\_pub\_status**

The heartbeat publication status value

*esp\_ble\_mesh\_cfg\_hb\_sub\_status\_cb\_t* **heartbeat\_sub\_status**

The heartbeat subscription status value

*esp\_ble\_mesh\_cfg\_net\_trans\_status\_cb\_t* **net\_transmit\_status**

The network transmit status value

*esp\_ble\_mesh\_cfg\_model\_sub\_list\_cb\_t* **model\_sub\_list**

The model subscription list value

*esp\_ble\_mesh\_cfg\_net\_key\_list\_cb\_t* **netkey\_list**

The network key index list value

*esp\_ble\_mesh\_cfg\_app\_key\_list\_cb\_t* **appkey\_list**

The application key index list value

*esp\_ble\_mesh\_cfg\_node\_id\_status\_cb\_t* **node\_identity\_status**

The node identity status value

*esp\_ble\_mesh\_cfg\_model\_app\_list\_cb\_t* **model\_app\_list**

The model application key index list value

*esp\_ble\_mesh\_cfg\_kr\_phase\_status\_cb\_t* **kr\_phase\_status**

The key refresh phase status value

*esp\_ble\_mesh\_cfg\_lpn\_pollto\_status\_cb\_t* **lpn\_timeout\_status**

The low power node poll timeout status value

union **esp\_ble\_mesh\_cfg\_server\_state\_change\_t**

*#include <esp\_ble\_mesh\_config\_model\_api.h>* Configuration Server model state change value union.

### Public Members

*esp\_ble\_mesh\_state\_change\_cfg\_mod\_pub\_set\_t* **mod\_pub\_set**

The `recv_op` in `ctx` can be used to decide which state is changed. Config Model Publication Set



*esp\_ble\_mesh\_state\_change\_cfg\_mod\_pub\_va\_set\_t* **mod\_pub\_va\_set**

Config Model Publication Virtual Address Set

*esp\_ble\_mesh\_state\_change\_cfg\_model\_sub\_add\_t* **mod\_sub\_add**

Config Model Subscription Add

*esp\_ble\_mesh\_state\_change\_cfg\_model\_sub\_delete\_t* **mod\_sub\_delete**

Config Model Subscription Delete

*esp\_ble\_mesh\_state\_change\_cfg\_netkey\_add\_t* **netkey\_add**

Config NetKey Add

*esp\_ble\_mesh\_state\_change\_cfg\_netkey\_update\_t* **netkey\_update**

Config NetKey Update

*esp\_ble\_mesh\_state\_change\_cfg\_netkey\_delete\_t* **netkey\_delete**

Config NetKey Delete

*esp\_ble\_mesh\_state\_change\_cfg\_appkey\_add\_t* **appkey\_add**

Config AppKey Add

*esp\_ble\_mesh\_state\_change\_cfg\_appkey\_update\_t* **appkey\_update**

Config AppKey Update

*esp\_ble\_mesh\_state\_change\_cfg\_appkey\_delete\_t* **appkey\_delete**

Config AppKey Delete

*esp\_ble\_mesh\_state\_change\_cfg\_model\_app\_bind\_t* **mod\_app\_bind**

Config Model App Bind

*esp\_ble\_mesh\_state\_change\_cfg\_model\_app\_unbind\_t* **mod\_app\_unbind**

Config Model App Unbind

*esp\_ble\_mesh\_state\_change\_cfg\_kr\_phase\_set\_t* **kr\_phase\_set**

Config Key Refresh Phase Set

union **esp\_ble\_mesh\_cfg\_server\_cb\_value\_t**

*#include <esp\_ble\_mesh\_config\_model\_api.h>* Configuration Server model callback value union.

### Public Members

*esp\_ble\_mesh\_cfg\_server\_state\_change\_t* **state\_change**

ESP\_BLE\_MESH\_CFG\_SERVER\_STATE\_CHANGE\_EVT

### Structures

struct **esp\_ble\_mesh\_cfg\_srv\_t**

Configuration Server Model context

**Public Members**

*esp\_ble\_mesh\_model\_t* \***model**

Pointer to Configuration Server Model

uint8\_t **net\_transmit**

Network Transmit state

uint8\_t **relay**

Relay Mode state

uint8\_t **relay\_retransmit**

Relay Retransmit state

uint8\_t **beacon**

Secure Network Beacon state

uint8\_t **gatt\_proxy**

GATT Proxy state

uint8\_t **friend\_state**

Friend state

uint8\_t **default\_ttl**

Default TTL

struct k\_delayed\_work **timer**

Heartbeat Publication timer

uint16\_t **dst**

Destination address for Heartbeat messages

uint16\_t **count**

Number of Heartbeat messages to be sent

Number of Heartbeat messages received

uint8\_t **period**

Period for sending Heartbeat messages

uint8\_t **ttl**

TTL to be used when sending Heartbeat messages

uint16\_t **feature**

Bit field indicating features that trigger Heartbeat messages when changed

uint16\_t **net\_idx**

NetKey Index used by Heartbeat Publication

struct *esp\_ble\_mesh\_cfg\_srv\_t*::[anonymous] **heartbeat\_pub**  
Heartbeat Publication

int64\_t **expiry**  
Timestamp when Heartbeat subscription period is expired

uint16\_t **src**  
Source address for Heartbeat messages

uint8\_t **min\_hops**  
Minimum hops when receiving Heartbeat messages

uint8\_t **max\_hops**  
Maximum hops when receiving Heartbeat messages

*esp\_ble\_mesh\_cb\_t* **heartbeat\_rcv\_cb**  
Optional heartbeat subscription tracking function

struct *esp\_ble\_mesh\_cfg\_srv\_t*::[anonymous] **heartbeat\_sub**  
Heartbeat Subscription

struct **esp\_ble\_mesh\_cfg\_composition\_data\_get\_t**  
Parameters of Config Composition Data Get.

### Public Members

uint8\_t **page**  
Page number of the Composition Data.

struct **esp\_ble\_mesh\_cfg\_model\_pub\_get\_t**  
Parameters of Config Model Publication Get.

### Public Members

uint16\_t **element\_addr**  
The element address

uint16\_t **model\_id**  
The model id

uint16\_t **company\_id**  
The company id, if not a vendor model, shall set to 0xFFFF

struct **esp\_ble\_mesh\_cfg\_sig\_model\_sub\_get\_t**  
Parameters of Config SIG Model Subscription Get.

### Public Members

uint16\_t **element\_addr**

The element address

uint16\_t **model\_id**

The model id

struct **esp\_ble\_mesh\_cfg\_vnd\_model\_sub\_get\_t**

Parameters of Config Vendor Model Subscription Get.

### Public Members

uint16\_t **element\_addr**

The element address

uint16\_t **model\_id**

The model id

uint16\_t **company\_id**

The company id, if not a vendor model, shall set to 0xFFFF

struct **esp\_ble\_mesh\_cfg\_app\_key\_get\_t**

Parameters of Config AppKey Get.

### Public Members

uint16\_t **net\_idx**

The network key index

struct **esp\_ble\_mesh\_cfg\_node\_identity\_get\_t**

Parameters of Config Node Identity Get.

### Public Members

uint16\_t **net\_idx**

The network key index

struct **esp\_ble\_mesh\_cfg\_sig\_model\_app\_get\_t**

Parameters of Config SIG Model App Get.

### Public Members

uint16\_t **element\_addr**

The element address

uint16\_t **model\_id**

The model id

struct **esp\_ble\_mesh\_cfg\_vnd\_model\_app\_get\_t**

Parameters of Config Vendor Model App Get.

### Public Members

uint16\_t **element\_addr**

The element address

uint16\_t **model\_id**

The model id

uint16\_t **company\_id**

The company id, if not a vendor model, shall set to 0xFFFF

struct **esp\_ble\_mesh\_cfg\_kr\_phase\_get\_t**

Parameters of Config Key Refresh Phase Get.

### Public Members

uint16\_t **net\_idx**

The network key index

struct **esp\_ble\_mesh\_cfg\_lpn\_polltimeout\_get\_t**

Parameters of Config Low Power Node PollTimeout Get.

### Public Members

uint16\_t **lpn\_addr**

The unicast address of the Low Power node

struct **esp\_ble\_mesh\_cfg\_beacon\_set\_t**

Parameters of Config Beacon Set.

### Public Members

uint8\_t **beacon**

New Secure Network Beacon state

struct **esp\_ble\_mesh\_cfg\_default\_ttl\_set\_t**

Parameters of Config Default TTL Set.

**Public Members**`uint8_t ttl`

The default TTL state value

struct `esp_ble_mesh_cfg_friend_set_t`

Parameters of Config Friend Set.

**Public Members**`uint8_t friend_state`

The friend state value

struct `esp_ble_mesh_cfg_gatt_proxy_set_t`

Parameters of Config GATT Proxy Set.

**Public Members**`uint8_t gatt_proxy`

The GATT Proxy state value

struct `esp_ble_mesh_cfg_relay_set_t`

Parameters of Config Relay Set.

**Public Members**`uint8_t relay`

The relay value

`uint8_t relay_retransmit`

The relay retransmit value

struct `esp_ble_mesh_cfg_net_key_add_t`

Parameters of Config NetKey Add.

**Public Members**`uint16_t net_idx`

The network key index

`uint8_t net_key[16]`

The network key value

struct `esp_ble_mesh_cfg_app_key_add_t`

Parameters of Config AppKey Add.

**Public Members****uint16\_t net\_idx**

The network key index

**uint16\_t app\_idx**

The app key index

**uint8\_t app\_key[16]**

The app key value

struct **esp\_ble\_mesh\_cfg\_model\_app\_bind\_t**

Parameters of Config Model App Bind.

**Public Members****uint16\_t element\_addr**

The element address

**uint16\_t model\_app\_idx**

Index of the app key to bind with the model

**uint16\_t model\_id**

The model id

**uint16\_t company\_id**

The company id, if not a vendor model, shall set to 0xFFFF

struct **esp\_ble\_mesh\_cfg\_model\_pub\_set\_t**

Parameters of Config Model Publication Set.

**Public Members****uint16\_t element\_addr**

The element address

**uint16\_t publish\_addr**

Value of the publish address

**uint16\_t publish\_app\_idx**

Index of the application key

**bool cred\_flag**

Value of the Friendship Credential Flag

**uint8\_t publish\_ttl**

Default TTL value for the publishing messages

uint8\_t **publish\_period**

Period for periodic status publishing

uint8\_t **publish\_retransmit**

Number of retransmissions and number of 50-millisecond steps between retransmissions

uint16\_t **model\_id**

The model id

uint16\_t **company\_id**

The company id, if not a vendor model, shall set to 0xFFFF

struct **esp\_ble\_mesh\_cfg\_model\_sub\_add\_t**

Parameters of Config Model Subscription Add.

### Public Members

uint16\_t **element\_addr**

The element address

uint16\_t **sub\_addr**

The address to be added to the Subscription List

uint16\_t **model\_id**

The model id

uint16\_t **company\_id**

The company id, if not a vendor model, shall set to 0xFFFF

struct **esp\_ble\_mesh\_cfg\_model\_sub\_delete\_t**

Parameters of Config Model Subscription Delete.

### Public Members

uint16\_t **element\_addr**

The element address

uint16\_t **sub\_addr**

The address to be removed from the Subscription List

uint16\_t **model\_id**

The model id

uint16\_t **company\_id**

The company id, if not a vendor model, shall set to 0xFFFF

struct **esp\_ble\_mesh\_cfg\_model\_sub\_overwrite\_t**

Parameters of Config Model Subscription Overwrite.



**Public Members****uint16\_t element\_addr**

The element address

**uint16\_t sub\_addr**

The address to be added to the Subscription List

**uint16\_t model\_id**

The model id

**uint16\_t company\_id**

The company id, if not a vendor model, shall set to 0xFFFF

struct **esp\_ble\_mesh\_cfg\_model\_sub\_va\_add\_t**

Parameters of Config Model Subscription Virtual Address Add.

**Public Members****uint16\_t element\_addr**

The element address

**uint8\_t label\_uuid[16]**

The Label UUID of the virtual address to be added to the Subscription List

**uint16\_t model\_id**

The model id

**uint16\_t company\_id**

The company id, if not a vendor model, shall set to 0xFFFF

struct **esp\_ble\_mesh\_cfg\_model\_sub\_va\_delete\_t**

Parameters of Config Model Subscription Virtual Address Delete.

**Public Members****uint16\_t element\_addr**

The element address

**uint8\_t label\_uuid[16]**

The Label UUID of the virtual address to be removed from the Subscription List

**uint16\_t model\_id**

The model id

**uint16\_t company\_id**

The company id, if not a vendor model, shall set to 0xFFFF

struct **esp\_ble\_mesh\_cfg\_model\_sub\_va\_overwrite\_t**

Parameters of Config Model Subscription Virtual Address Overwrite.

### Public Members

uint16\_t **element\_addr**

The element address

uint8\_t **label\_uuid**[16]

The Label UUID of the virtual address to be added to the Subscription List

uint16\_t **model\_id**

The model id

uint16\_t **company\_id**

The company id, if not a vendor model, shall set to 0xFFFF

struct **esp\_ble\_mesh\_cfg\_model\_pub\_va\_set\_t**

Parameters of Config Model Publication Virtual Address Set.

### Public Members

uint16\_t **element\_addr**

The element address

uint8\_t **label\_uuid**[16]

Value of the Label UUID publish address

uint16\_t **publish\_app\_idx**

Index of the application key

bool **cred\_flag**

Value of the Friendship Credential Flag

uint8\_t **publish\_ttl**

Default TTL value for the publishing messages

uint8\_t **publish\_period**

Period for periodic status publishing

uint8\_t **publish\_retransmit**

Number of retransmissions and number of 50-millisecond steps between retransmissions

uint16\_t **model\_id**

The model id

uint16\_t **company\_id**

The company id, if not a vendor model, shall set to 0xFFFF

struct **esp\_ble\_mesh\_cfg\_model\_sub\_delete\_all\_t**

Parameters of Config Model Subscription Delete All.

### Public Members

uint16\_t **element\_addr**

The element address

uint16\_t **model\_id**

The model id

uint16\_t **company\_id**

The company id, if not a vendor model, shall set to 0xFFFF

struct **esp\_ble\_mesh\_cfg\_net\_key\_update\_t**

Parameters of Config NetKey Update.

### Public Members

uint16\_t **net\_idx**

The network key index

uint8\_t **net\_key**[16]

The network key value

struct **esp\_ble\_mesh\_cfg\_net\_key\_delete\_t**

Parameters of Config NetKey Delete.

### Public Members

uint16\_t **net\_idx**

The network key index

struct **esp\_ble\_mesh\_cfg\_app\_key\_update\_t**

Parameters of Config AppKey Update.

### Public Members

uint16\_t **net\_idx**

The network key index

uint16\_t **app\_idx**

The app key index

uint8\_t **app\_key**[16]

The app key value

struct **esp\_ble\_mesh\_cfg\_app\_key\_delete\_t**

Parameters of Config AppKey Delete.

### Public Members

uint16\_t **net\_idx**

The network key index

uint16\_t **app\_idx**

The app key index

struct **esp\_ble\_mesh\_cfg\_node\_identity\_set\_t**

Parameters of Config Node Identity Set.

### Public Members

uint16\_t **net\_idx**

The network key index

uint8\_t **identity**

New Node Identity state

struct **esp\_ble\_mesh\_cfg\_model\_app\_unbind\_t**

Parameters of Config Model App Unbind.

### Public Members

uint16\_t **element\_addr**

The element address

uint16\_t **model\_app\_idx**

Index of the app key to bind with the model

uint16\_t **model\_id**

The model id

uint16\_t **company\_id**

The company id, if not a vendor model, shall set to 0xFFFF

struct **esp\_ble\_mesh\_cfg\_kr\_phase\_set\_t**

Parameters of Config Key Refresh Phase Set.

**Public Members****uint16\_t net\_idx**

The network key index

**uint8\_t transition**

New Key Refresh Phase Transition

struct **esp\_ble\_mesh\_cfg\_net\_transmit\_set\_t**

Parameters of Config Network Transmit Set.

**Public Members****uint8\_t net\_transmit**

Network Transmit State

struct **esp\_ble\_mesh\_cfg\_heartbeat\_pub\_set\_t**

Parameters of Config Model Heartbeat Publication Set.

**Public Members****uint16\_t dst**

Destination address for Heartbeat messages

**uint8\_t count**

Number of Heartbeat messages to be sent

**uint8\_t period**

Period for sending Heartbeat messages

**uint8\_t ttl**

TTL to be used when sending Heartbeat messages

**uint16\_t feature**

Bit field indicating features that trigger Heartbeat messages when changed

**uint16\_t net\_idx**

NetKey Index

struct **esp\_ble\_mesh\_cfg\_heartbeat\_sub\_set\_t**

Parameters of Config Model Heartbeat Subscription Set.

**Public Members****uint16\_t src**

Source address for Heartbeat messages

uint16\_t **dst**

Destination address for Heartbeat messages

uint8\_t **period**

Period for receiving Heartbeat messages

struct **esp\_ble\_mesh\_cfg\_beacon\_status\_cb\_t**

Parameter of Config Beacon Status

### Public Members

uint8\_t **beacon**

Secure Network Beacon state value

struct **esp\_ble\_mesh\_cfg\_comp\_data\_status\_cb\_t**

Parameters of Config Composition Data Status

### Public Members

uint8\_t **page**

Page number of the Composition Data

struct net\_buf\_simple \***composition\_data**

Pointer to Composition Data for the identified page

struct **esp\_ble\_mesh\_cfg\_default\_ttl\_status\_cb\_t**

Parameter of Config Default TTL Status

### Public Members

uint8\_t **default\_ttl**

Default TTL state value

struct **esp\_ble\_mesh\_cfg\_gatt\_proxy\_status\_cb\_t**

Parameter of Config GATT Proxy Status

### Public Members

uint8\_t **gatt\_proxy**

GATT Proxy state value

struct **esp\_ble\_mesh\_cfg\_relay\_status\_cb\_t**

Parameters of Config Relay Status

**Public Members****uint8\_t relay**

Relay state value

**uint8\_t retransmit**

Relay retransmit value(number of retransmissions and number of 10-millisecond steps between retransmissions)

struct **esp\_ble\_mesh\_cfg\_model\_pub\_status\_cb\_t**

Parameters of Config Model Publication Status

**Public Members****uint8\_t status**

Status Code for the request message

**uint16\_t element\_addr**

Address of the element

**uint16\_t publish\_addr**

Value of the publish address

**uint16\_t app\_idx**

Index of the application key

**bool cred\_flag**

Value of the Friendship Credential Flag

**uint8\_t ttl**

Default TTL value for the outgoing messages

**uint8\_t period**

Period for periodic status publishing

**uint8\_t transmit**

Number of retransmissions and number of 50-millisecond steps between retransmissions

**uint16\_t company\_id**

Company ID

**uint16\_t model\_id**

Model ID

struct **esp\_ble\_mesh\_cfg\_model\_sub\_status\_cb\_t**

Parameters of Config Model Subscription Status

**Public Members****uint8\_t status**

Status Code for the request message

**uint16\_t element\_addr**

Address of the element

**uint16\_t sub\_addr**

Value of the address

**uint16\_t company\_id**

Company ID

**uint16\_t model\_id**

Model ID

struct **esp\_ble\_mesh\_cfg\_net\_key\_status\_cb\_t**

Parameters of Config NetKey Status

**Public Members****uint8\_t status**

Status Code for the request message

**uint16\_t net\_idx**

Index of the NetKey

struct **esp\_ble\_mesh\_cfg\_app\_key\_status\_cb\_t**

Parameters of Config AppKey Status

**Public Members****uint8\_t status**

Status Code for the request message

**uint16\_t net\_idx**

Index of the NetKey

**uint16\_t app\_idx**

Index of the application key

struct **esp\_ble\_mesh\_cfg\_mod\_app\_status\_cb\_t**

Parameters of Config Model App Status



**Public Members****uint8\_t status**

Status Code for the request message

**uint16\_t element\_addr**

Address of the element

**uint16\_t app\_idx**

Index of the application key

**uint16\_t company\_id**

Company ID

**uint16\_t model\_id**

Model ID

struct **esp\_ble\_mesh\_cfg\_friend\_status\_cb\_t**

Parameter of Config Friend Status

**Public Members****uint8\_t friend\_state**

Friend state value

struct **esp\_ble\_mesh\_cfg\_hb\_pub\_status\_cb\_t**

Parameters of Config Heartbeat Publication Status

**Public Members****uint8\_t status**

Status Code for the request message

**uint16\_t dst**

Destination address for Heartbeat messages

**uint8\_t count**

Number of Heartbeat messages remaining to be sent

**uint8\_t period**

Period for sending Heartbeat messages

**uint8\_t ttl**

TTL to be used when sending Heartbeat messages

**uint16\_t features**

Features that trigger Heartbeat messages when changed

uint16\_t **net\_idx**

Index of the NetKey

struct **esp\_ble\_mesh\_cfg\_hb\_sub\_status\_cb\_t**

Parameters of Config Heartbeat Subscription Status

### Public Members

uint8\_t **status**

Status Code for the request message

uint16\_t **src**

Source address for Heartbeat messages

uint16\_t **dst**

Destination address for Heartbeat messages

uint8\_t **period**

Remaining Period for processing Heartbeat messages

uint8\_t **count**

Number of Heartbeat messages received

uint8\_t **min\_hops**

Minimum hops when receiving Heartbeat messages

uint8\_t **max\_hops**

Maximum hops when receiving Heartbeat messages

struct **esp\_ble\_mesh\_cfg\_net\_trans\_status\_cb\_t**

Parameters of Config Network Transmit Status

### Public Members

uint8\_t **net\_trans\_count**

Number of transmissions for each Network PDU originating from the node

uint8\_t **net\_trans\_step**

Maximum hops when receiving Heartbeat messages

struct **esp\_ble\_mesh\_cfg\_model\_sub\_list\_cb\_t**

Parameters of Config SIG/Vendor Subscription List

### Public Members

uint8\_t **status**

Status Code for the request message

uint16\_t **element\_addr**

Address of the element

uint16\_t **company\_id**

Company ID

uint16\_t **model\_id**

Model ID

struct net\_buf\_simple \***sub\_addr**

A block of all addresses from the Subscription List

struct **esp\_ble\_mesh\_cfg\_net\_key\_list\_cb\_t**

Parameter of Config NetKey List

### Public Members

struct net\_buf\_simple \***net\_idx**

A list of NetKey Indexes known to the node

struct **esp\_ble\_mesh\_cfg\_app\_key\_list\_cb\_t**

Parameters of Config AppKey List

### Public Members

uint8\_t **status**

Status Code for the request message

uint16\_t **net\_idx**

NetKey Index of the NetKey that the AppKeys are bound to

struct net\_buf\_simple \***app\_idx**

A list of AppKey indexes that are bound to the NetKey identified by NetKeyIndex

struct **esp\_ble\_mesh\_cfg\_node\_id\_status\_cb\_t**

Parameters of Config Node Identity Status

### Public Members

uint8\_t **status**

Status Code for the request message

uint16\_t **net\_idx**

Index of the NetKey

uint8\_t **identity**

Node Identity state

struct **esp\_ble\_mesh\_cfg\_model\_app\_list\_cb\_t**

Parameters of Config SIG/Vendor Model App List

### Public Members

uint8\_t **status**

Status Code for the request message

uint16\_t **element\_addr**

Address of the element

uint16\_t **company\_id**

Company ID

uint16\_t **model\_id**

Model ID

struct net\_buf\_simple \***app\_idx**

All AppKey indexes bound to the Model

struct **esp\_ble\_mesh\_cfg\_kr\_phase\_status\_cb\_t**

Parameters of Config Key Refresh Phase Status

### Public Members

uint8\_t **status**

Status Code for the request message

uint16\_t **net\_idx**

Index of the NetKey

uint8\_t **phase**

Key Refresh Phase state

struct **esp\_ble\_mesh\_cfg\_lpn\_pollto\_status\_cb\_t**

Parameters of Config Low Power Node PollTimeout Status

### Public Members

uint16\_t **lpn\_addr**

The unicast address of the Low Power node

int32\_t **poll\_timeout**

The current value of the PollTimeout timer of the Low Power node

struct **esp\_ble\_mesh\_cfg\_client\_cb\_param\_t**

Configuration Client Model callback parameters

### Public Members

int **error\_code**

Appropriate error code

*esp\_ble\_mesh\_client\_common\_param\_t* \***params**

The client common parameters

*esp\_ble\_mesh\_cfg\_client\_common\_cb\_param\_t* **status\_cb**

The config status message callback values

struct **esp\_ble\_mesh\_state\_change\_cfg\_mod\_pub\_set\_t**

Configuration Server model related context.

Parameters of Config Model Publication Set

### Public Members

uint16\_t **element\_addr**

Element Address

uint16\_t **pub\_addr**

Publish Address

uint16\_t **app\_idx**

AppKey Index

bool **cred\_flag**

Friendship Credential Flag

uint8\_t **pub\_ttl**

Publish TTL

uint8\_t **pub\_period**

Publish Period

uint8\_t **pub\_retransmit**

Publish Retransmit

uint16\_t **company\_id**

Company ID

uint16\_t **model\_id**

Model ID

struct **esp\_ble\_mesh\_state\_change\_cfg\_mod\_pub\_va\_set\_t**

Parameters of Config Model Publication Virtual Address Set

### Public Members

uint16\_t **element\_addr**

Element Address

uint8\_t **label\_uuid**[16]

Label UUID

uint16\_t **app\_idx**

AppKey Index

bool **cred\_flag**

Friendship Credential Flag

uint8\_t **pub\_ttl**

Publish TTL

uint8\_t **pub\_period**

Publish Period

uint8\_t **pub\_retransmit**

Publish Retransmit

uint16\_t **company\_id**

Company ID

uint16\_t **model\_id**

Model ID

struct **esp\_ble\_mesh\_state\_change\_cfg\_model\_sub\_add\_t**

Parameters of Config Model Subscription Add

### Public Members

uint16\_t **element\_addr**

Element Address

uint16\_t **sub\_addr**  
Subscription Address

uint16\_t **company\_id**  
Company ID

uint16\_t **model\_id**  
Model ID

struct **esp\_ble\_mesh\_state\_change\_cfg\_model\_sub\_delete\_t**  
Parameters of Config Model Subscription Delete

### Public Members

uint16\_t **element\_addr**  
Element Address

uint16\_t **sub\_addr**  
Subscription Address

uint16\_t **company\_id**  
Company ID

uint16\_t **model\_id**  
Model ID

struct **esp\_ble\_mesh\_state\_change\_cfg\_netkey\_add\_t**  
Parameters of Config NetKey Add

### Public Members

uint16\_t **net\_idx**  
NetKey Index

uint8\_t **net\_key**[16]  
NetKey

struct **esp\_ble\_mesh\_state\_change\_cfg\_netkey\_update\_t**  
Parameters of Config NetKey Update

### Public Members

uint16\_t **net\_idx**  
NetKey Index

uint8\_t **net\_key**[16]  
NetKey

struct **esp\_ble\_mesh\_state\_change\_cfg\_netkey\_delete\_t**  
Parameter of Config NetKey Delete

### Public Members

uint16\_t **net\_idx**  
NetKey Index

struct **esp\_ble\_mesh\_state\_change\_cfg\_appkey\_add\_t**  
Parameters of Config AppKey Add

### Public Members

uint16\_t **net\_idx**  
NetKey Index

uint16\_t **app\_idx**  
AppKey Index

uint8\_t **app\_key**[16]  
AppKey

struct **esp\_ble\_mesh\_state\_change\_cfg\_appkey\_update\_t**  
Parameters of Config AppKey Update

### Public Members

uint16\_t **net\_idx**  
NetKey Index

uint16\_t **app\_idx**  
AppKey Index

uint8\_t **app\_key**[16]  
AppKey

struct **esp\_ble\_mesh\_state\_change\_cfg\_appkey\_delete\_t**  
Parameters of Config AppKey Delete

### Public Members

uint16\_t **net\_idx**  
NetKey Index



uint16\_t **app\_idx**

AppKey Index

struct **esp\_ble\_mesh\_state\_change\_cfg\_model\_app\_bind\_t**

Parameters of Config Model App Bind

### Public Members

uint16\_t **element\_addr**

Element Address

uint16\_t **app\_idx**

AppKey Index

uint16\_t **company\_id**

Company ID

uint16\_t **model\_id**

Model ID

struct **esp\_ble\_mesh\_state\_change\_cfg\_model\_app\_unbind\_t**

Parameters of Config Model App Unbind

### Public Members

uint16\_t **element\_addr**

Element Address

uint16\_t **app\_idx**

AppKey Index

uint16\_t **company\_id**

Company ID

uint16\_t **model\_id**

Model ID

struct **esp\_ble\_mesh\_state\_change\_cfg\_kr\_phase\_set\_t**

Parameters of Config Key Refresh Phase Set

### Public Members

uint16\_t **net\_idx**

NetKey Index

uint8\_t **kr\_phase**

New Key Refresh Phase Transition

struct **esp\_ble\_mesh\_cfg\_server\_cb\_param\_t**

Configuration Server model callback parameters

### Public Members

*esp\_ble\_mesh\_model\_t* \***model**

Pointer to the server model structure

*esp\_ble\_mesh\_msg\_ctx\_t* **ctx**

Context of the received message

*esp\_ble\_mesh\_cfg\_server\_cb\_value\_t* **value**

Value of the received configuration messages

### Macros

**ESP\_BLE\_MESH\_MODEL\_CFG\_SRV** (srv\_data)

Define a new Config Server Model.

---

**备注:** The Config Server Model can only be included by a Primary Element.

---

#### 参数

- **srv\_data** -- Pointer to a unique Config Server Model user\_data.

**返回** New Config Server Model instance.

**ESP\_BLE\_MESH\_MODEL\_CFG\_CLI** (cli\_data)

Define a new Config Client Model.

---

**备注:** The Config Client Model can only be included by a Primary Element.

---

#### 参数

- **cli\_data** -- Pointer to a unique struct *esp\_ble\_mesh\_client\_t*.

**返回** New Config Client Model instance.

### Type Definitions

typedef void (\***esp\_ble\_mesh\_cfg\_client\_cb\_t**)(*esp\_ble\_mesh\_cfg\_client\_cb\_event\_t* event,  
*esp\_ble\_mesh\_cfg\_client\_cb\_param\_t* \*param)

Bluetooth Mesh Config Client and Server Model functions.

Configuration Client Model callback function type

**Param event** Event type

**Param param** Pointer to callback parameter

typedef void (\***esp\_ble\_mesh\_cfg\_server\_cb\_t**)(*esp\_ble\_mesh\_cfg\_server\_cb\_event\_t* event,  
*esp\_ble\_mesh\_cfg\_server\_cb\_param\_t* \*param)

Configuration Server Model callback function type.

**Param event** Event type  
**Param param** Pointer to callback parameter

### Enumerations

enum **esp\_ble\_mesh\_cfg\_client\_cb\_event\_t**

This enum value is the event of Configuration Client Model

*Values:*

enumerator **ESP\_BLE\_MESH\_CFG\_CLIENT\_GET\_STATE\_EVT**

enumerator **ESP\_BLE\_MESH\_CFG\_CLIENT\_SET\_STATE\_EVT**

enumerator **ESP\_BLE\_MESH\_CFG\_CLIENT\_PUBLISH\_EVT**

enumerator **ESP\_BLE\_MESH\_CFG\_CLIENT\_TIMEOUT\_EVT**

enumerator **ESP\_BLE\_MESH\_CFG\_CLIENT\_EVT\_MAX**

enum **esp\_ble\_mesh\_cfg\_server\_cb\_event\_t**

This enum value is the event of Configuration Server model

*Values:*

enumerator **ESP\_BLE\_MESH\_CFG\_SERVER\_STATE\_CHANGE\_EVT**

enumerator **ESP\_BLE\_MESH\_CFG\_SERVER\_EVT\_MAX**

### Health Client/Server Models

#### Header File

- [components/bt/esp\\_ble\\_mesh/api/models/include/esp\\_ble\\_mesh\\_health\\_model\\_api.h](#)
- This header file can be included with:

```
#include "esp_ble_mesh_health_model_api.h"
```

- This header file is a part of the API provided by the `bt` component. To declare that your component depends on `bt`, add the following to your `CMakeLists.txt`:

```
REQUIRES bt
```

or

```
PRIV_REQUIRES bt
```

#### Functions

`esp_err_t esp_ble_mesh_register_health_client_callback` ([esp\\_ble\\_mesh\\_health\\_client\\_cb\\_t](#) callback)

Register BLE Mesh Health Model callback, the callback will report Health Client & Server Model events.

**参数** `callback` -- [in] Pointer to the callback function.

**返回** `ESP_OK` on success or error code otherwise.

*esp\_err\_t* **esp\_ble\_mesh\_register\_health\_server\_callback** (*esp\_ble\_mesh\_health\_server\_cb\_t* callback)

Register BLE Mesh Health Server Model callback.

**参数** **callback** -- [in] Pointer to the callback function.

**返回** ESP\_OK on success or error code otherwise.

*esp\_err\_t* **esp\_ble\_mesh\_health\_client\_get\_state** (*esp\_ble\_mesh\_client\_common\_param\_t* \*params, *esp\_ble\_mesh\_health\_client\_get\_state\_t* \*get\_state)

This function is called to get the Health Server states using the Health Client Model get messages.

---

**备注:** If you want to find the opcodes and corresponding meanings accepted by this API, please refer to `esp_ble_mesh_opcode_health_client_get_t` in `esp_ble_mesh_defs.h`

---

#### 参数

- **params** -- [in] Pointer to BLE Mesh common client parameters.
- **get\_state** -- [in] Pointer to a union, each kind of opcode corresponds to one structure inside. Shall not be set to NULL.

**返回** ESP\_OK on success or error code otherwise.

*esp\_err\_t* **esp\_ble\_mesh\_health\_client\_set\_state** (*esp\_ble\_mesh\_client\_common\_param\_t* \*params, *esp\_ble\_mesh\_health\_client\_set\_state\_t* \*set\_state)

This function is called to set the Health Server states using the Health Client Model set messages.

---

**备注:** If you want to find the opcodes and corresponding meanings accepted by this API, please refer to `esp_ble_mesh_opcode_health_client_set_t` in `esp_ble_mesh_defs.h`

---

#### 参数

- **params** -- [in] Pointer to BLE Mesh common client parameters.
- **set\_state** -- [in] Pointer to a union, each kind of opcode corresponds to one structure inside. Shall not be set to NULL.

**返回** ESP\_OK on success or error code otherwise.

*esp\_err\_t* **esp\_ble\_mesh\_health\_server\_fault\_update** (*esp\_ble\_mesh\_elem\_t* \*element)

This function is called by the Health Server Model to update the context of its Health Current status.

**参数** **element** -- [in] The element to which the Health Server Model belongs.

**返回** ESP\_OK on success or error code otherwise.

## Unions

union **esp\_ble\_mesh\_health\_client\_get\_state\_t**

`#include <esp_ble_mesh_health_model_api.h>` For ESP\_BLE\_MESH\_MODEL\_OP\_HEALTH\_FAULT\_GET ESP\_BLE\_MESH\_MODEL\_OP\_ATTENTION\_GET ESP\_BLE\_MESH\_MODEL\_OP\_HEALTH\_PERIOD\_GET the `get_state` parameter in the `esp_ble_mesh_health_client_get_state` function should not be set to NULL.

## Public Members

*esp\_ble\_mesh\_health\_fault\_get\_t* **fault\_get**

For ESP\_BLE\_MESH\_MODEL\_OP\_HEALTH\_FAULT\_GET.

union **esp\_ble\_mesh\_health\_client\_set\_state\_t**

*#include <esp\_ble\_mesh\_health\_model\_api.h>* For ESP\_BLE\_MESH\_MODEL\_OP\_HEALTH\_FAULT\_CLEAR  
ESP\_BLE\_MESH\_MODEL\_OP\_HEALTH\_FAULT\_CLEAR\_UNACK ESP\_BLE\_MESH\_MODEL\_OP\_HEALTH\_FAULT\_TEST  
ESP\_BLE\_MESH\_MODEL\_OP\_HEALTH\_FAULT\_TEST\_UNACK ESP\_BLE\_MESH\_MODEL\_OP\_HEALTH\_PERIOD  
ESP\_BLE\_MESH\_MODEL\_OP\_HEALTH\_PERIOD\_SET\_UNACK ESP\_BLE\_MESH\_MODEL\_OP\_ATTENTION\_SET  
ESP\_BLE\_MESH\_MODEL\_OP\_ATTENTION\_SET\_UNACK the set\_state parameter in the  
esp\_ble\_mesh\_health\_client\_set\_state function should not be set to NULL.

### Public Members

*esp\_ble\_mesh\_health\_attention\_set\_t* **attention\_set**

For ESP\_BLE\_MESH\_MODEL\_OP\_ATTENTION\_SET or ESP\_BLE\_MESH\_MODEL\_OP\_ATTENTION\_SET\_UNACK.

*esp\_ble\_mesh\_health\_period\_set\_t* **period\_set**

For ESP\_BLE\_MESH\_MODEL\_OP\_HEALTH\_PERIOD\_SET or  
ESP\_BLE\_MESH\_MODEL\_OP\_HEALTH\_PERIOD\_SET\_UNACK.

*esp\_ble\_mesh\_health\_fault\_test\_t* **fault\_test**

For ESP\_BLE\_MESH\_MODEL\_OP\_HEALTH\_FAULT\_TEST or  
ESP\_BLE\_MESH\_MODEL\_OP\_HEALTH\_FAULT\_TEST\_UNACK.

*esp\_ble\_mesh\_health\_fault\_clear\_t* **fault\_clear**

For ESP\_BLE\_MESH\_MODEL\_OP\_HEALTH\_FAULT\_CLEAR or  
ESP\_BLE\_MESH\_MODEL\_OP\_HEALTH\_FAULT\_CLEAR\_UNACK.

union **esp\_ble\_mesh\_health\_client\_common\_cb\_param\_t**

*#include <esp\_ble\_mesh\_health\_model\_api.h>* Health Client Model received message union.

### Public Members

*esp\_ble\_mesh\_health\_current\_status\_cb\_t* **current\_status**

The health current status value

*esp\_ble\_mesh\_health\_fault\_status\_cb\_t* **fault\_status**

The health fault status value

*esp\_ble\_mesh\_health\_period\_status\_cb\_t* **period\_status**

The health period status value

*esp\_ble\_mesh\_health\_attention\_status\_cb\_t* **attention\_status**

The health attention status value

union **esp\_ble\_mesh\_health\_server\_cb\_param\_t**

*#include <esp\_ble\_mesh\_health\_model\_api.h>* Health Server Model callback parameters union.

### Public Members

*esp\_ble\_mesh\_health\_fault\_update\_cb\_t* **fault\_update\_comp**

ESP\_BLE\_MESH\_HEALTH\_SERVER\_FAULT\_UPDATE\_COMP\_EVT

*esp\_ble\_mesh\_health\_fault\_clear\_cb\_t* **fault\_clear**

ESP\_BLE\_MESH\_HEALTH\_SERVER\_FAULT\_CLEAR\_EVT

*esp\_ble\_mesh\_health\_fault\_test\_cb\_t* **fault\_test**

ESP\_BLE\_MESH\_HEALTH\_SERVER\_FAULT\_TEST\_EVT

*esp\_ble\_mesh\_health\_attention\_on\_cb\_t* **attention\_on**

ESP\_BLE\_MESH\_HEALTH\_SERVER\_ATTENTION\_ON\_EVT

*esp\_ble\_mesh\_health\_attention\_off\_cb\_t* **attention\_off**

ESP\_BLE\_MESH\_HEALTH\_SERVER\_ATTENTION\_OFF\_EVT

## Structures

struct **esp\_ble\_mesh\_health\_srv\_cb\_t**

ESP BLE Mesh Health Server callback

### Public Members

*esp\_ble\_mesh\_cb\_t* **fault\_clear**

Clear health registered faults. Initialized by the stack.

*esp\_ble\_mesh\_cb\_t* **fault\_test**

Run a specific health test. Initialized by the stack.

*esp\_ble\_mesh\_cb\_t* **attention\_on**

Health attention on callback. Initialized by the stack.

*esp\_ble\_mesh\_cb\_t* **attention\_off**

Health attention off callback. Initialized by the stack.

struct **esp\_ble\_mesh\_health\_test\_t**

ESP BLE Mesh Health Server test Context

### Public Members

uint8\_t **id\_count**

Number of Health self-test ID

const uint8\_t \***test\_ids**

Array of Health self-test IDs

uint16\_t **company\_id**

Company ID used to identify the Health Fault state

uint8\_t **prev\_test\_id**

Current test ID of the health fault test

uint8\_t **current\_faults**[ESP\_BLE\_MESH\_HEALTH\_FAULT\_ARRAY\_SIZE]

Array of current faults

uint8\_t **registered\_faults**[ESP\_BLE\_MESH\_HEALTH\_FAULT\_ARRAY\_SIZE]

Array of registered faults

struct **esp\_ble\_mesh\_health\_srv\_t**

ESP BLE Mesh Health Server Model Context

### Public Members

*esp\_ble\_mesh\_model\_t* \***model**

Pointer to Health Server Model

*esp\_ble\_mesh\_health\_srv\_cb\_t* **health\_cb**

Health callback struct

struct k\_delayed\_work **attention\_timer**

Attention Timer state

bool **attention\_timer\_start**

Attention Timer start flag

*esp\_ble\_mesh\_health\_test\_t* **health\_test**

Health Server fault test

struct **esp\_ble\_mesh\_health\_fault\_get\_t**

Parameter of Health Fault Get

### Public Members

uint16\_t **company\_id**

Bluetooth assigned 16-bit Company ID

struct **esp\_ble\_mesh\_health\_attention\_set\_t**

Parameter of Health Attention Set

### Public Members

uint8\_t **attention**

Value of the Attention Timer state

struct **esp\_ble\_mesh\_health\_period\_set\_t**

Parameter of Health Period Set

**Public Members**

uint8\_t **fast\_period\_divisor**

Divider for the Publish Period

struct **esp\_ble\_mesh\_health\_fault\_test\_t**

Parameter of Health Fault Test

**Public Members**

uint16\_t **company\_id**

Bluetooth assigned 16-bit Company ID

uint8\_t **test\_id**

ID of a specific test to be performed

struct **esp\_ble\_mesh\_health\_fault\_clear\_t**

Parameter of Health Fault Clear

**Public Members**

uint16\_t **company\_id**

Bluetooth assigned 16-bit Company ID

struct **esp\_ble\_mesh\_health\_current\_status\_cb\_t**

Parameters of Health Current Status

**Public Members**

uint8\_t **test\_id**

ID of a most recently performed test

uint16\_t **company\_id**

Bluetooth assigned 16-bit Company ID

struct net\_buf\_simple \***fault\_array**

FaultArray field contains a sequence of 1-octet fault values

struct **esp\_ble\_mesh\_health\_fault\_status\_cb\_t**

Parameters of Health Fault Status

**Public Members**

uint8\_t **test\_id**

ID of a most recently performed test



uint16\_t **company\_id**  
Bluetooth assigned 16-bit Company ID

struct net\_buf\_simple \***fault\_array**  
FaultArray field contains a sequence of 1-octet fault values

struct **esp\_ble\_mesh\_health\_period\_status\_cb\_t**  
Parameter of Health Period Status

### Public Members

uint8\_t **fast\_period\_divisor**  
Divider for the Publish Period

struct **esp\_ble\_mesh\_health\_attention\_status\_cb\_t**  
Parameter of Health Attention Status

### Public Members

uint8\_t **attention**  
Value of the Attention Timer state

struct **esp\_ble\_mesh\_health\_client\_cb\_param\_t**  
Health Client Model callback parameters

### Public Members

int **error\_code**  
Appropriate error code

*esp\_ble\_mesh\_client\_common\_param\_t* \***params**  
The client common parameters.

*esp\_ble\_mesh\_health\_client\_common\_cb\_param\_t* **status\_cb**  
The health message status callback values

struct **esp\_ble\_mesh\_health\_fault\_update\_comp\_cb\_t**  
Parameter of publishing Health Current Status completion event

### Public Members

int **error\_code**  
The result of publishing Health Current Status

*esp\_ble\_mesh\_elem\_t* \***element**  
Pointer to the element which contains the Health Server Model

struct **esp\_ble\_mesh\_health\_fault\_clear\_cb\_t**  
Parameters of Health Fault Clear event

#### Public Members

*esp\_ble\_mesh\_model\_t* \***model**  
Pointer to the Health Server Model

uint16\_t **company\_id**  
Bluetooth assigned 16-bit Company ID

struct **esp\_ble\_mesh\_health\_fault\_test\_cb\_t**  
Parameters of Health Fault Test event

#### Public Members

*esp\_ble\_mesh\_model\_t* \***model**  
Pointer to the Health Server Model

uint8\_t **test\_id**  
ID of a specific test to be performed

uint16\_t **company\_id**  
Bluetooth assigned 16-bit Company ID

struct **esp\_ble\_mesh\_health\_attention\_on\_cb\_t**  
Parameter of Health Attention On event

#### Public Members

*esp\_ble\_mesh\_model\_t* \***model**  
Pointer to the Health Server Model

uint8\_t **time**  
Duration of attention timer on (in seconds)

struct **esp\_ble\_mesh\_health\_attention\_off\_cb\_t**  
Parameter of Health Attention Off event

#### Public Members

*esp\_ble\_mesh\_model\_t* \***model**  
Pointer to the Health Server Model

**Macros****ESP\_BLE\_MESH\_MODEL\_HEALTH\_SRV** (srv, pub)

Define a new Health Server Model.

---

**备注:** The Health Server Model can only be included by a Primary Element.

---

**参数**

- **srv** -- Pointer to the unique struct *esp\_ble\_mesh\_health\_srv\_t*.
- **pub** -- Pointer to the unique struct *esp\_ble\_mesh\_model\_pub\_t*.

**返回** New Health Server Model instance.**ESP\_BLE\_MESH\_MODEL\_HEALTH\_CLI** (cli\_data)

Define a new Health Client Model.

---

**备注:** This API needs to be called for each element on which the application needs to have a Health Client Model.

---

**参数**

- **cli\_data** -- Pointer to the unique struct *esp\_ble\_mesh\_client\_t*.

**返回** New Health Client Model instance.**ESP\_BLE\_MESH\_HEALTH\_PUB\_DEFINE** (\_name, \_max, \_role)

A helper to define a health publication context

**参数**

- **\_name** -- Name given to the publication context variable.
- **\_max** -- Maximum number of faults the element can have.
- **\_role** -- Role of the device which contains the model.

**ESP\_BLE\_MESH\_HEALTH\_STANDARD\_TEST**

SIG identifier of Health Fault Test. 0x01 ~ 0xFF: Vendor Specific Test.

**ESP\_BLE\_MESH\_NO\_FAULT**

Fault values of Health Fault Test. 0x33 ~ 0x7F: Reserved for Future Use. 0x80 ~ 0xFF: Vendor Specific Warning/Error.

**ESP\_BLE\_MESH\_BATTERY\_LOW\_WARNING****ESP\_BLE\_MESH\_BATTERY\_LOW\_ERROR****ESP\_BLE\_MESH\_SUPPLY\_VOLTAGE\_TOO\_LOW\_WARNING****ESP\_BLE\_MESH\_SUPPLY\_VOLTAGE\_TOO\_LOW\_ERROR****ESP\_BLE\_MESH\_SUPPLY\_VOLTAGE\_TOO\_HIGH\_WARNING****ESP\_BLE\_MESH\_SUPPLY\_VOLTAGE\_TOO\_HIGH\_ERROR****ESP\_BLE\_MESH\_POWER\_SUPPLY\_INTERRUPTED\_WARNING**

ESP\_BLE\_MESH\_POWER\_SUPPLY\_INTERRUPTED\_ERROR

ESP\_BLE\_MESH\_NO\_LOAD\_WARNING

ESP\_BLE\_MESH\_NO\_LOAD\_ERROR

ESP\_BLE\_MESH\_OVERLOAD\_WARNING

ESP\_BLE\_MESH\_OVERLOAD\_ERROR

ESP\_BLE\_MESH\_OVERHEAT\_WARNING

ESP\_BLE\_MESH\_OVERHEAT\_ERROR

ESP\_BLE\_MESH\_CONDENSATION\_WARNING

ESP\_BLE\_MESH\_CONDENSATION\_ERROR

ESP\_BLE\_MESH\_VIBRATION\_WARNING

ESP\_BLE\_MESH\_VIBRATION\_ERROR

ESP\_BLE\_MESH\_CONFIGURATION\_WARNING

ESP\_BLE\_MESH\_CONFIGURATION\_ERROR

ESP\_BLE\_MESH\_ELEMENT\_NOT\_CALIBRATED\_WARNING

ESP\_BLE\_MESH\_ELEMENT\_NOT\_CALIBRATED\_ERROR

ESP\_BLE\_MESH\_MEMORY\_WARNING

ESP\_BLE\_MESH\_MEMORY\_ERROR

ESP\_BLE\_MESH\_SELF\_TEST\_WARNING

ESP\_BLE\_MESH\_SELF\_TEST\_ERROR

ESP\_BLE\_MESH\_INPUT\_TOO\_LOW\_WARNING

ESP\_BLE\_MESH\_INPUT\_TOO\_LOW\_ERROR

ESP\_BLE\_MESH\_INPUT\_TOO\_HIGH\_WARNING

ESP\_BLE\_MESH\_INPUT\_TOO\_HIGH\_ERROR

ESP\_BLE\_MESH\_INPUT\_NO\_CHANGE\_WARNING

ESP\_BLE\_MESH\_INPUT\_NO\_CHANGE\_ERROR

ESP\_BLE\_MESH\_ACTUATOR\_BLOCKED\_WARNING

ESP\_BLE\_MESH\_ACTUATOR\_BLOCKED\_ERROR

ESP\_BLE\_MESH\_HOUSING\_OPENED\_WARNING

ESP\_BLE\_MESH\_HOUSING\_OPENED\_ERROR

ESP\_BLE\_MESH\_TAMPER\_WARNING

ESP\_BLE\_MESH\_TAMPER\_ERROR

ESP\_BLE\_MESH\_DEVICE\_MOVED\_WARNING

ESP\_BLE\_MESH\_DEVICE\_MOVED\_ERROR

ESP\_BLE\_MESH\_DEVICE\_DROPPED\_WARNING

ESP\_BLE\_MESH\_DEVICE\_DROPPED\_ERROR

ESP\_BLE\_MESH\_OVERFLOW\_WARNING

ESP\_BLE\_MESH\_OVERFLOW\_ERROR

ESP\_BLE\_MESH\_EMPTY\_WARNING

ESP\_BLE\_MESH\_EMPTY\_ERROR

ESP\_BLE\_MESH\_INTERNAL\_BUS\_WARNING

ESP\_BLE\_MESH\_INTERNAL\_BUS\_ERROR

ESP\_BLE\_MESH\_MECHANISM\_JAMMED\_WARNING

ESP\_BLE\_MESH\_MECHANISM\_JAMMED\_ERROR

ESP\_BLE\_MESH\_HEALTH\_FAULT\_ARRAY\_SIZE

## Type Definitions

```
typedef void (*esp_ble_mesh_health_client_cb_t)(esp_ble_mesh_health_client_cb_event_t event,  
esp_ble_mesh_health_client_cb_param_t *param)
```

Bluetooth Mesh Health Client and Server Model function.

Health Client Model callback function type

**Param event** Event type

**Param param** Pointer to callback parameter

```
typedef void (*esp_ble_mesh_health_server_cb_t)(esp_ble_mesh_health_server_cb_event_t event,  
esp_ble_mesh_health_server_cb_param_t *param)
```

Health Server Model callback function type.

**Param event** Event type

**Param param** Pointer to callback parameter

## Enumerations

```
enum esp_ble_mesh_health_client_cb_event_t
```

This enum value is the event of Health Client Model

*Values:*

enumerator **ESP\_BLE\_MESH\_HEALTH\_CLIENT\_GET\_STATE\_EVT**

enumerator **ESP\_BLE\_MESH\_HEALTH\_CLIENT\_SET\_STATE\_EVT**

enumerator **ESP\_BLE\_MESH\_HEALTH\_CLIENT\_PUBLISH\_EVT**

enumerator **ESP\_BLE\_MESH\_HEALTH\_CLIENT\_TIMEOUT\_EVT**

enumerator **ESP\_BLE\_MESH\_HEALTH\_CLIENT\_EVT\_MAX**

```
enum esp_ble_mesh_health_server_cb_event_t
```

This enum value is the event of Health Server Model

*Values:*

enumerator **ESP\_BLE\_MESH\_HEALTH\_SERVER\_FAULT\_UPDATE\_COMP\_EVT**

enumerator **ESP\_BLE\_MESH\_HEALTH\_SERVER\_FAULT\_CLEAR\_EVT**

enumerator **ESP\_BLE\_MESH\_HEALTH\_SERVER\_FAULT\_TEST\_EVT**

enumerator **ESP\_BLE\_MESH\_HEALTH\_SERVER\_ATTENTION\_ON\_EVT**

enumerator **ESP\_BLE\_MESH\_HEALTH\_SERVER\_ATTENTION\_OFF\_EVT**

enumerator **ESP\_BLE\_MESH\_HEALTH\_SERVER\_EVT\_MAX**

## Generic Client/Server Models

**Header File**

- `components/bt/esp_ble_mesh/api/models/include/esp_ble_mesh_generic_model_api.h`
- This header file can be included with:

```
#include "esp_ble_mesh_generic_model_api.h"
```

- This header file is a part of the API provided by the `bt` component. To declare that your component depends on `bt`, add the following to your `CMakeLists.txt`:

```
REQUIRES bt
```

or

```
PRIV_REQUIRES bt
```

**Functions**

*esp\_err\_t* **esp\_ble\_mesh\_register\_generic\_client\_callback** (*esp\_ble\_mesh\_generic\_client\_cb\_t* callback)

Register BLE Mesh Generic Client Model callback.

**参数** `callback` -- **[in]** Pointer to the callback function.

**返回** `ESP_OK` on success or error code otherwise.

*esp\_err\_t* **esp\_ble\_mesh\_generic\_client\_get\_state** (*esp\_ble\_mesh\_client\_common\_param\_t* \*params, *esp\_ble\_mesh\_generic\_client\_get\_state\_t* \*get\_state)

Get the value of Generic Server Model states using the Generic Client Model get messages.

---

**备注:** If you want to find the opcodes and corresponding meanings accepted by this API, please refer to `esp_ble_mesh_generic_message_opcode_t` in `esp_ble_mesh_defs.h`

---

**参数**

- **params** -- **[in]** Pointer to BLE Mesh common client parameters.
- **get\_state** -- **[in]** Pointer to generic get message value. Shall not be set to NULL.

**返回** `ESP_OK` on success or error code otherwise.

*esp\_err\_t* **esp\_ble\_mesh\_generic\_client\_set\_state** (*esp\_ble\_mesh\_client\_common\_param\_t* \*params, *esp\_ble\_mesh\_generic\_client\_set\_state\_t* \*set\_state)

Set the value of Generic Server Model states using the Generic Client Model set messages.

---

**备注:** If you want to find the opcodes and corresponding meanings accepted by this API, please refer to `esp_ble_mesh_generic_message_opcode_t` in `esp_ble_mesh_defs.h`

---

**参数**

- **params** -- **[in]** Pointer to BLE Mesh common client parameters.
- **set\_state** -- **[in]** Pointer to generic set message value. Shall not be set to NULL.

**返回** `ESP_OK` on success or error code otherwise.

*esp\_err\_t* **esp\_ble\_mesh\_register\_generic\_server\_callback** (*esp\_ble\_mesh\_generic\_server\_cb\_t* callback)

Register BLE Mesh Generic Server Model callback.

**参数** `callback` -- **[in]** Pointer to the callback function.

返回 ESP\_OK on success or error code otherwise.

## Unions

union **esp\_ble\_mesh\_generic\_client\_get\_state\_t**  
*#include <esp\_ble\_mesh\_generic\_model\_api.h>* Generic Client Model get message union.

### Public Members

*esp\_ble\_mesh\_gen\_user\_property\_get\_t* **user\_property\_get**  
 For ESP\_BLE\_MESH\_MODEL\_OP\_GEN\_USER\_PROPERTY\_GET

*esp\_ble\_mesh\_gen\_admin\_property\_get\_t* **admin\_property\_get**  
 For ESP\_BLE\_MESH\_MODEL\_OP\_GEN\_ADMIN\_PROPERTY\_GET

*esp\_ble\_mesh\_gen\_manufacturer\_property\_get\_t* **manufacturer\_property\_get**  
 For ESP\_BLE\_MESH\_MODEL\_OP\_GEN\_MANUFACTURER\_PROPERTY\_SET

*esp\_ble\_mesh\_gen\_client\_properties\_get\_t* **client\_properties\_get**  
 For ESP\_BLE\_MESH\_MODEL\_OP\_GEN\_CLIENT\_PROPERTIES\_GET

union **esp\_ble\_mesh\_generic\_client\_set\_state\_t**  
*#include <esp\_ble\_mesh\_generic\_model\_api.h>* Generic Client Model set message union.

### Public Members

*esp\_ble\_mesh\_gen\_onoff\_set\_t* **onoff\_set**  
 For ESP\_BLE\_MESH\_MODEL\_OP\_GEN\_ONOFF\_SET & ESP\_BLE\_MESH\_MODEL\_OP\_GEN\_ONOFF\_SET\_UNACK

*esp\_ble\_mesh\_gen\_level\_set\_t* **level\_set**  
 For ESP\_BLE\_MESH\_MODEL\_OP\_GEN\_LEVEL\_SET & ESP\_BLE\_MESH\_MODEL\_OP\_GEN\_LEVEL\_SET\_UNACK

*esp\_ble\_mesh\_gen\_delta\_set\_t* **delta\_set**  
 For ESP\_BLE\_MESH\_MODEL\_OP\_GEN\_DELTA\_SET & ESP\_BLE\_MESH\_MODEL\_OP\_GEN\_DELTA\_SET\_UNACK

*esp\_ble\_mesh\_gen\_move\_set\_t* **move\_set**  
 For ESP\_BLE\_MESH\_MODEL\_OP\_GEN\_MOVE\_SET & ESP\_BLE\_MESH\_MODEL\_OP\_GEN\_MOVE\_SET\_UNACK

*esp\_ble\_mesh\_gen\_def\_trans\_time\_set\_t* **def\_trans\_time\_set**  
 For ESP\_BLE\_MESH\_MODEL\_OP\_GEN\_DEF\_TRANS\_TIME\_SET &  
 ESP\_BLE\_MESH\_MODEL\_OP\_GEN\_DEF\_TRANS\_TIME\_SET\_UNACK

*esp\_ble\_mesh\_gen\_onpowerup\_set\_t* **power\_set**  
 For ESP\_BLE\_MESH\_MODEL\_OP\_GEN\_ONPOWERUP\_SET &  
 ESP\_BLE\_MESH\_MODEL\_OP\_GEN\_ONPOWERUP\_SET\_UNACK

*esp\_ble\_mesh\_gen\_power\_level\_set\_t* **power\_level\_set**  
 For ESP\_BLE\_MESH\_MODEL\_OP\_GEN\_POWER\_LEVEL\_SET &  
 ESP\_BLE\_MESH\_MODEL\_OP\_GEN\_POWER\_LEVEL\_SET\_UNACK



```

esp_ble_mesh_gen_power_default_set_t power_default_set
    For          ESP_BLE_MESH_MODEL_OP_GEN_POWER_DEFAULT_SET      &
    ESP_BLE_MESH_MODEL_OP_GEN_POWER_DEFAULT_SET_UNACK

esp_ble_mesh_gen_power_range_set_t power_range_set
    For          ESP_BLE_MESH_MODEL_OP_GEN_POWER_RANGE_SET       &
    ESP_BLE_MESH_MODEL_OP_GEN_POWER_RANGE_SET_UNACK

esp_ble_mesh_gen_loc_global_set_t loc_global_set
    For          ESP_BLE_MESH_MODEL_OP_GEN_LOC_GLOBAL_SET        &
    ESP_BLE_MESH_MODEL_OP_GEN_LOC_GLOBAL_SET_UNACK

esp_ble_mesh_gen_loc_local_set_t loc_local_set
    For          ESP_BLE_MESH_MODEL_OP_GEN_LOC_LOCAL_SET         &
    ESP_BLE_MESH_MODEL_OP_GEN_LOC_LOCAL_SET_UNACK

esp_ble_mesh_gen_user_property_set_t user_property_set
    For          ESP_BLE_MESH_MODEL_OP_GEN_USER_PROPERTY_SET     &
    ESP_BLE_MESH_MODEL_OP_GEN_USER_PROPERTY_SET_UNACK

esp_ble_mesh_gen_admin_property_set_t admin_property_set
    For          ESP_BLE_MESH_MODEL_OP_GEN_ADMIN_PROPERTY_SET    &
    ESP_BLE_MESH_MODEL_OP_GEN_ADMIN_PROPERTY_SET_UNACK

esp_ble_mesh_gen_manufacturer_property_set_t manufacturer_property_set
    For          ESP_BLE_MESH_MODEL_OP_GEN_MANUFACTURER_PROPERTY_SET &
    ESP_BLE_MESH_MODEL_OP_GEN_MANUFACTURER_PROPERTY_SET_UNACK

```

```
union esp_ble_mesh_gen_client_status_cb_t
```

```
#include <esp_ble_mesh_generic_model_api.h> Generic Client Model received message union.
```

### Public Members

```

esp_ble_mesh_gen_onoff_status_cb_t onoff_status
    For ESP_BLE_MESH_MODEL_OP_GEN_ONOFF_STATUS

esp_ble_mesh_gen_level_status_cb_t level_status
    For ESP_BLE_MESH_MODEL_OP_GEN_LEVEL_STATUS

esp_ble_mesh_gen_def_trans_time_status_cb_t def_trans_time_status
    For ESP_BLE_MESH_MODEL_OP_GEN_DEF_TRANS_TIME_STATUS

esp_ble_mesh_gen_onpowerup_status_cb_t onpowerup_status
    For ESP_BLE_MESH_MODEL_OP_GEN_ONPOWERUP_STATUS

esp_ble_mesh_gen_power_level_status_cb_t power_level_status
    For ESP_BLE_MESH_MODEL_OP_GEN_POWER_LEVEL_STATUS

```

*esp\_ble\_mesh\_gen\_power\_last\_status\_cb\_t* **power\_last\_status**

For ESP\_BLE\_MESH\_MODEL\_OP\_GEN\_POWER\_LAST\_STATUS

*esp\_ble\_mesh\_gen\_power\_default\_status\_cb\_t* **power\_default\_status**

For ESP\_BLE\_MESH\_MODEL\_OP\_GEN\_POWER\_DEFAULT\_STATUS

*esp\_ble\_mesh\_gen\_power\_range\_status\_cb\_t* **power\_range\_status**

For ESP\_BLE\_MESH\_MODEL\_OP\_GEN\_POWER\_RANGE\_STATUS

*esp\_ble\_mesh\_gen\_battery\_status\_cb\_t* **battery\_status**

For ESP\_BLE\_MESH\_MODEL\_OP\_GEN\_BATTERY\_STATUS

*esp\_ble\_mesh\_gen\_loc\_global\_status\_cb\_t* **location\_global\_status**

For ESP\_BLE\_MESH\_MODEL\_OP\_GEN\_LOC\_GLOBAL\_STATUS

*esp\_ble\_mesh\_gen\_loc\_local\_status\_cb\_t* **location\_local\_status**

ESP\_BLE\_MESH\_MODEL\_OP\_GEN\_LOC\_LOCAL\_STATUS

*esp\_ble\_mesh\_gen\_user\_properties\_status\_cb\_t* **user\_properties\_status**

ESP\_BLE\_MESH\_MODEL\_OP\_GEN\_USER\_PROPERTIES\_STATUS

*esp\_ble\_mesh\_gen\_user\_property\_status\_cb\_t* **user\_property\_status**

ESP\_BLE\_MESH\_MODEL\_OP\_GEN\_USER\_PROPERTY\_STATUS

*esp\_ble\_mesh\_gen\_admin\_properties\_status\_cb\_t* **admin\_properties\_status**

ESP\_BLE\_MESH\_MODEL\_OP\_GEN\_ADMIN\_PROPERTIES\_STATUS

*esp\_ble\_mesh\_gen\_admin\_property\_status\_cb\_t* **admin\_property\_status**

ESP\_BLE\_MESH\_MODEL\_OP\_GEN\_ADMIN\_PROPERTY\_STATUS

*esp\_ble\_mesh\_gen\_manufacturer\_properties\_status\_cb\_t* **manufacturer\_properties\_status**

ESP\_BLE\_MESH\_MODEL\_OP\_GEN\_MANUFACTURER\_PROPERTIES\_STATUS

*esp\_ble\_mesh\_gen\_manufacturer\_property\_status\_cb\_t* **manufacturer\_property\_status**

ESP\_BLE\_MESH\_MODEL\_OP\_GEN\_MANUFACTURER\_PROPERTY\_STATUS

*esp\_ble\_mesh\_gen\_client\_properties\_status\_cb\_t* **client\_properties\_status**

ESP\_BLE\_MESH\_MODEL\_OP\_GEN\_CLIENT\_PROPERTIES\_STATUS

union **esp\_ble\_mesh\_generic\_server\_state\_change\_t**

#include <esp\_ble\_mesh\_generic\_model\_api.h> Generic Server Model state change value union.

## Public Members

*esp\_ble\_mesh\_state\_change\_gen\_onoff\_set\_t* **onoff\_set**

The `recv_op` in `ctx` can be used to decide which state is changed. Generic OnOff Set

*esp\_ble\_mesh\_state\_change\_gen\_level\_set\_t* **level\_set**

Generic Level Set

*esp\_ble\_mesh\_state\_change\_gen\_delta\_set\_t* **delta\_set**

Generic Delta Set

*esp\_ble\_mesh\_state\_change\_gen\_move\_set\_t* **move\_set**

Generic Move Set

*esp\_ble\_mesh\_state\_change\_gen\_def\_trans\_time\_set\_t* **def\_trans\_time\_set**

Generic Default Transition Time Set

*esp\_ble\_mesh\_state\_change\_gen\_onpowerup\_set\_t* **onpowerup\_set**

Generic OnPowerUp Set

*esp\_ble\_mesh\_state\_change\_gen\_power\_level\_set\_t* **power\_level\_set**

Generic Power Level Set

*esp\_ble\_mesh\_state\_change\_gen\_power\_default\_set\_t* **power\_default\_set**

Generic Power Default Set

*esp\_ble\_mesh\_state\_change\_gen\_power\_range\_set\_t* **power\_range\_set**

Generic Power Range Set

*esp\_ble\_mesh\_state\_change\_gen\_loc\_global\_set\_t* **loc\_global\_set**

Generic Location Global Set

*esp\_ble\_mesh\_state\_change\_gen\_loc\_local\_set\_t* **loc\_local\_set**

Generic Location Local Set

*esp\_ble\_mesh\_state\_change\_gen\_user\_property\_set\_t* **user\_property\_set**

Generic User Property Set

*esp\_ble\_mesh\_state\_change\_gen\_admin\_property\_set\_t* **admin\_property\_set**

Generic Admin Property Set

*esp\_ble\_mesh\_state\_change\_gen\_manu\_property\_set\_t* **manu\_property\_set**

Generic Manufacturer Property Set

union **esp\_ble\_mesh\_generic\_server\_rcv\_get\_msg\_t**

*#include <esp\_ble\_mesh\_generic\_model\_api.h>* Generic Server Model received get message union.

### Public Members

*esp\_ble\_mesh\_server\_rcv\_gen\_user\_property\_get\_t* **user\_property**

Generic User Property Get

*esp\_ble\_mesh\_server\_rcv\_gen\_admin\_property\_get\_t* **admin\_property**

Generic Admin Property Get

*esp\_ble\_mesh\_server\_rcv\_gen\_manufacturer\_property\_get\_t* **manu\_property**

Generic Manufacturer Property Get

*esp\_ble\_mesh\_server\_rcv\_gen\_client\_properties\_get\_t* **client\_properties**

Generic Client Properties Get

union **esp\_ble\_mesh\_generic\_server\_rcv\_set\_msg\_t**

*#include <esp\_ble\_mesh\_generic\_model\_api.h>* Generic Server Model received set message union.

### Public Members

*esp\_ble\_mesh\_server\_rcv\_gen\_onoff\_set\_t* **onoff**

Generic OnOff Set/Generic OnOff Set Unack

*esp\_ble\_mesh\_server\_rcv\_gen\_level\_set\_t* **level**

Generic Level Set/Generic Level Set Unack

*esp\_ble\_mesh\_server\_rcv\_gen\_delta\_set\_t* **delta**

Generic Delta Set/Generic Delta Set Unack

*esp\_ble\_mesh\_server\_rcv\_gen\_move\_set\_t* **move**

Generic Move Set/Generic Move Set Unack

*esp\_ble\_mesh\_server\_rcv\_gen\_def\_trans\_time\_set\_t* **def\_trans\_time**

Generic Default Transition Time Set/Generic Default Transition Time Set Unack

*esp\_ble\_mesh\_server\_rcv\_gen\_onpowerup\_set\_t* **onpowerup**

Generic OnPowerUp Set/Generic OnPowerUp Set Unack

*esp\_ble\_mesh\_server\_rcv\_gen\_power\_level\_set\_t* **power\_level**

Generic Power Level Set/Generic Power Level Set Unack

*esp\_ble\_mesh\_server\_rcv\_gen\_power\_default\_set\_t* **power\_default**

Generic Power Default Set/Generic Power Default Set Unack

*esp\_ble\_mesh\_server\_rcv\_gen\_power\_range\_set\_t* **power\_range**

Generic Power Range Set/Generic Power Range Set Unack

*esp\_ble\_mesh\_server\_rcv\_gen\_loc\_global\_set\_t* **location\_global**

Generic Location Global Set/Generic Location Global Set Unack

*esp\_ble\_mesh\_server\_rcv\_gen\_loc\_local\_set\_t* **location\_local**

Generic Location Local Set/Generic Location Local Set Unack

*esp\_ble\_mesh\_server\_rcv\_gen\_user\_property\_set\_t* **user\_property**

Generic User Property Set/Generic User Property Set Unack

*esp\_ble\_mesh\_server\_rcv\_gen\_admin\_property\_set\_t* **admin\_property**

Generic Admin Property Set/Generic Admin Property Set Unack

*esp\_ble\_mesh\_server\_rcv\_gen\_manufacturer\_property\_set\_t* **manu\_property**

Generic Manufacturer Property Set/Generic Manufacturer Property Set Unack

union **esp\_ble\_mesh\_generic\_server\_cb\_value\_t**

*#include <esp\_ble\_mesh\_generic\_model\_api.h>* Generic Server Model callback value union.

### Public Members

*esp\_ble\_mesh\_generic\_server\_state\_change\_t* **state\_change**

ESP\_BLE\_MESH\_GENERIC\_SERVER\_STATE\_CHANGE\_EVT

*esp\_ble\_mesh\_generic\_server\_rcv\_get\_msg\_t* **get**

ESP\_BLE\_MESH\_GENERIC\_SERVER\_RECV\_GET\_MSG\_EVT

*esp\_ble\_mesh\_generic\_server\_rcv\_set\_msg\_t* **set**

ESP\_BLE\_MESH\_GENERIC\_SERVER\_RECV\_SET\_MSG\_EVT

### Structures

struct **esp\_ble\_mesh\_gen\_onoff\_set\_t**

Bluetooth Mesh Generic Client Model Get and Set parameters structure.

Parameters of Generic OnOff Set.

### Public Members

bool **op\_en**

Indicate if optional parameters are included

uint8\_t **onoff**

Target value of Generic OnOff state

uint8\_t **tid**

Transaction ID

uint8\_t **trans\_time**

Time to complete state transition (optional)

uint8\_t **delay**

Indicate message execution delay (C.1)

struct **esp\_ble\_mesh\_gen\_level\_set\_t**

Parameters of Generic Level Set.

**Public Members****bool op\_en**

Indicate if optional parameters are included

**int16\_t level**

Target value of Generic Level state

**uint8\_t tid**

Transaction ID

**uint8\_t trans\_time**

Time to complete state transition (optional)

**uint8\_t delay**

Indicate message execution delay (C.1)

struct **esp\_ble\_mesh\_gen\_delta\_set\_t**

Parameters of Generic Delta Set.

**Public Members****bool op\_en**

Indicate if optional parameters are included

**int32\_t level**

Delta change of Generic Level state

**uint8\_t tid**

Transaction ID

**uint8\_t trans\_time**

Time to complete state transition (optional)

**uint8\_t delay**

Indicate message execution delay (C.1)

struct **esp\_ble\_mesh\_gen\_move\_set\_t**

Parameters of Generic Move Set.

**Public Members****bool op\_en**

Indicate if optional parameters are included

**int16\_t delta\_level**

Delta Level step to calculate Move speed for Generic Level state

`uint8_t tid`

Transaction ID

`uint8_t trans_time`

Time to complete state transition (optional)

`uint8_t delay`

Indicate message execution delay (C.1)

struct `esp_ble_mesh_gen_def_trans_time_set_t`

Parameter of Generic Default Transition Time Set.

### Public Members

`uint8_t trans_time`

The value of the Generic Default Transition Time state

struct `esp_ble_mesh_gen_onpowerup_set_t`

Parameter of Generic OnPowerUp Set.

### Public Members

`uint8_t onpowerup`

The value of the Generic OnPowerUp state

struct `esp_ble_mesh_gen_power_level_set_t`

Parameters of Generic Power Level Set.

### Public Members

bool `op_en`

Indicate if optional parameters are included

`uint16_t power`

Target value of Generic Power Actual state

`uint8_t tid`

Transaction ID

`uint8_t trans_time`

Time to complete state transition (optional)

`uint8_t delay`

Indicate message execution delay (C.1)

struct `esp_ble_mesh_gen_power_default_set_t`

Parameter of Generic Power Default Set.

**Public Members****uint16\_t power**

The value of the Generic Power Default state

struct **esp\_ble\_mesh\_gen\_power\_range\_set\_t**

Parameters of Generic Power Range Set.

**Public Members****uint16\_t range\_min**

Value of Range Min field of Generic Power Range state

**uint16\_t range\_max**

Value of Range Max field of Generic Power Range state

struct **esp\_ble\_mesh\_gen\_loc\_global\_set\_t**

Parameters of Generic Location Global Set.

**Public Members****int32\_t global\_latitude**

Global Coordinates (Latitude)

**int32\_t global\_longitude**

Global Coordinates (Longitude)

**int16\_t global\_altitude**

Global Altitude

struct **esp\_ble\_mesh\_gen\_loc\_local\_set\_t**

Parameters of Generic Location Local Set.

**Public Members****int16\_t local\_north**

Local Coordinates (North)

**int16\_t local\_east**

Local Coordinates (East)

**int16\_t local\_altitude**

Local Altitude

**uint8\_t floor\_number**

Floor Number



uint16\_t **uncertainty**

Uncertainty

struct **esp\_ble\_mesh\_gen\_user\_property\_get\_t**

Parameter of Generic User Property Get.

### Public Members

uint16\_t **property\_id**

Property ID identifying a Generic User Property

struct **esp\_ble\_mesh\_gen\_user\_property\_set\_t**

Parameters of Generic User Property Set.

### Public Members

uint16\_t **property\_id**

Property ID identifying a Generic User Property

struct net\_buf\_simple \***property\_value**

Raw value for the User Property

struct **esp\_ble\_mesh\_gen\_admin\_property\_get\_t**

Parameter of Generic Admin Property Get.

### Public Members

uint16\_t **property\_id**

Property ID identifying a Generic Admin Property

struct **esp\_ble\_mesh\_gen\_admin\_property\_set\_t**

Parameters of Generic Admin Property Set.

### Public Members

uint16\_t **property\_id**

Property ID identifying a Generic Admin Property

uint8\_t **user\_access**

Enumeration indicating user access

struct net\_buf\_simple \***property\_value**

Raw value for the Admin Property

struct **esp\_ble\_mesh\_gen\_manufacturer\_property\_get\_t**

Parameter of Generic Manufacturer Property Get.

**Public Members****uint16\_t property\_id**

Property ID identifying a Generic Manufacturer Property

struct **esp\_ble\_mesh\_gen\_manufacturer\_property\_set\_t**

Parameters of Generic Manufacturer Property Set.

**Public Members****uint16\_t property\_id**

Property ID identifying a Generic Manufacturer Property

**uint8\_t user\_access**

Enumeration indicating user access

struct **esp\_ble\_mesh\_gen\_client\_properties\_get\_t**

Parameter of Generic Client Properties Get.

**Public Members****uint16\_t property\_id**

A starting Client Property ID present within an element

struct **esp\_ble\_mesh\_gen\_onoff\_status\_cb\_t**

Bluetooth Mesh Generic Client Model Get and Set callback parameters structure.

Parameters of Generic OnOff Status.

**Public Members****bool op\_en**

Indicate if optional parameters are included

**uint8\_t present\_onoff**

Current value of Generic OnOff state

**uint8\_t target\_onoff**

Target value of Generic OnOff state (optional)

**uint8\_t remain\_time**

Time to complete state transition (C.1)

struct **esp\_ble\_mesh\_gen\_level\_status\_cb\_t**

Parameters of Generic Level Status.

**Public Members****bool op\_en**

Indicate if optional parameters are included

**int16\_t present\_level**

Current value of Generic Level state

**int16\_t target\_level**

Target value of the Generic Level state (optional)

**uint8\_t remain\_time**

Time to complete state transition (C.1)

struct **esp\_ble\_mesh\_gen\_def\_trans\_time\_status\_cb\_t**

Parameter of Generic Default Transition Time Status.

**Public Members****uint8\_t trans\_time**

The value of the Generic Default Transition Time state

struct **esp\_ble\_mesh\_gen\_onpowerup\_status\_cb\_t**

Parameter of Generic OnPowerUp Status.

**Public Members****uint8\_t onpowerup**

The value of the Generic OnPowerUp state

struct **esp\_ble\_mesh\_gen\_power\_level\_status\_cb\_t**

Parameters of Generic Power Level Status.

**Public Members****bool op\_en**

Indicate if optional parameters are included

**uint16\_t present\_power**

Current value of Generic Power Actual state

**uint16\_t target\_power**

Target value of Generic Power Actual state (optional)

**uint8\_t remain\_time**

Time to complete state transition (C.1)

struct **esp\_ble\_mesh\_gen\_power\_last\_status\_cb\_t**  
Parameter of Generic Power Last Status.

### Public Members

uint16\_t **power**  
The value of the Generic Power Last state

struct **esp\_ble\_mesh\_gen\_power\_default\_status\_cb\_t**  
Parameter of Generic Power Default Status.

### Public Members

uint16\_t **power**  
The value of the Generic Default Last state

struct **esp\_ble\_mesh\_gen\_power\_range\_status\_cb\_t**  
Parameters of Generic Power Range Status.

### Public Members

uint8\_t **status\_code**  
Status Code for the request message

uint16\_t **range\_min**  
Value of Range Min field of Generic Power Range state

uint16\_t **range\_max**  
Value of Range Max field of Generic Power Range state

struct **esp\_ble\_mesh\_gen\_battery\_status\_cb\_t**  
Parameters of Generic Battery Status.

### Public Members

uint32\_t **battery\_level**  
Value of Generic Battery Level state

uint32\_t **time\_to\_discharge**  
Value of Generic Battery Time to Discharge state

uint32\_t **time\_to\_charge**  
Value of Generic Battery Time to Charge state

uint32\_t **flags**  
Value of Generic Battery Flags state

struct **esp\_ble\_mesh\_gen\_loc\_global\_status\_cb\_t**

Parameters of Generic Location Global Status.

### Public Members

int32\_t **global\_latitude**

Global Coordinates (Latitude)

int32\_t **global\_longitude**

Global Coordinates (Longitude)

int16\_t **global\_altitude**

Global Altitude

struct **esp\_ble\_mesh\_gen\_loc\_local\_status\_cb\_t**

Parameters of Generic Location Local Status.

### Public Members

int16\_t **local\_north**

Local Coordinates (North)

int16\_t **local\_east**

Local Coordinates (East)

int16\_t **local\_altitude**

Local Altitude

uint8\_t **floor\_number**

Floor Number

uint16\_t **uncertainty**

Uncertainty

struct **esp\_ble\_mesh\_gen\_user\_properties\_status\_cb\_t**

Parameter of Generic User Properties Status.

### Public Members

struct net\_buf\_simple \***property\_ids**

Buffer contains a sequence of N User Property IDs

struct **esp\_ble\_mesh\_gen\_user\_property\_status\_cb\_t**

Parameters of Generic User Property Status.

**Public Members****bool op\_en**

Indicate if optional parameters are included

**uint16\_t property\_id**

Property ID identifying a Generic User Property

**uint8\_t user\_access**

Enumeration indicating user access (optional)

**struct net\_buf\_simple \*property\_value**

Raw value for the User Property (C.1)

**struct esp\_ble\_mesh\_gen\_admin\_properties\_status\_cb\_t**

Parameter of Generic Admin Properties Status.

**Public Members****struct net\_buf\_simple \*property\_ids**

Buffer contains a sequence of N Admin Property IDs

**struct esp\_ble\_mesh\_gen\_admin\_property\_status\_cb\_t**

Parameters of Generic Admin Property Status.

**Public Members****bool op\_en**

Indicate if optional parameters are included

**uint16\_t property\_id**

Property ID identifying a Generic Admin Property

**uint8\_t user\_access**

Enumeration indicating user access (optional)

**struct net\_buf\_simple \*property\_value**

Raw value for the Admin Property (C.1)

**struct esp\_ble\_mesh\_gen\_manufacturer\_properties\_status\_cb\_t**

Parameter of Generic Manufacturer Properties Status.

**Public Members****struct net\_buf\_simple \*property\_ids**

Buffer contains a sequence of N Manufacturer Property IDs

struct **esp\_ble\_mesh\_gen\_manufacturer\_property\_status\_cb\_t**  
Parameters of Generic Manufacturer Property Status.

### Public Members

bool **op\_en**  
Indicate if optional parameters are included

uint16\_t **property\_id**  
Property ID identifying a Generic Manufacturer Property

uint8\_t **user\_access**  
Enumeration indicating user access (optional)

struct net\_buf\_simple \***property\_value**  
Raw value for the Manufacturer Property (C.1)

struct **esp\_ble\_mesh\_gen\_client\_properties\_status\_cb\_t**  
Parameter of Generic Client Properties Status.

### Public Members

struct net\_buf\_simple \***property\_ids**  
Buffer contains a sequence of N Client Property IDs

struct **esp\_ble\_mesh\_generic\_client\_cb\_param\_t**  
Generic Client Model callback parameters

### Public Members

int **error\_code**  
Appropriate error code

*esp\_ble\_mesh\_client\_common\_param\_t* \***params**  
The client common parameters.

*esp\_ble\_mesh\_gen\_client\_status\_cb\_t* **status\_cb**  
The generic status message callback values

struct **esp\_ble\_mesh\_gen\_onoff\_state\_t**  
Parameters of Generic OnOff state

### Public Members

uint8\_t **onoff**  
The present value of the Generic OnOff state

`uint8_t target_onoff`

The target value of the Generic OnOff state

struct `esp_ble_mesh_gen_onoff_srv_t`

User data of Generic OnOff Server Model

### Public Members

`esp_ble_mesh_model_t *model`

Pointer to the Generic OnOff Server Model. Initialized internally.

`esp_ble_mesh_server_rsp_ctrl_t rsp_ctrl`

Response control of the server model received messages

`esp_ble_mesh_gen_onoff_state_t state`

Parameters of the Generic OnOff state

`esp_ble_mesh_last_msg_info_t last`

Parameters of the last received set message

`esp_ble_mesh_state_transition_t transition`

Parameters of state transition

struct `esp_ble_mesh_gen_level_state_t`

Parameters of Generic Level state

### Public Members

`int16_t level`

The present value of the Generic Level state

`int16_t target_level`

The target value of the Generic Level state

`int16_t last_level`

When a new transaction starts, level should be set to `last_level`, and use "level + incoming delta" to calculate the target level. In another word, "last\_level" is used to record "level" of the last transaction, and "last\_delta" is used to record the previously received delta\_level value. The last value of the Generic Level state

`int32_t last_delta`

The last delta change of the Generic Level state

`bool move_start`

Indicate if the transition of the Generic Level state has been started

`bool positive`

Indicate if the transition is positive or negative



struct **esp\_ble\_mesh\_gen\_level\_srv\_t**

User data of Generic Level Server Model

### Public Members

*esp\_ble\_mesh\_model\_t* \***model**

Pointer to the Generic Level Server Model. Initialized internally.

*esp\_ble\_mesh\_server\_rsp\_ctrl\_t* **rsp\_ctrl**

Response control of the server model received messages

*esp\_ble\_mesh\_gen\_level\_state\_t* **state**

Parameters of the Generic Level state

*esp\_ble\_mesh\_last\_msg\_info\_t* **last**

Parameters of the last received set message

*esp\_ble\_mesh\_state\_transition\_t* **transition**

Parameters of state transition

int32\_t **tt\_delta\_level**

Delta change value of level state transition

struct **esp\_ble\_mesh\_gen\_def\_trans\_time\_state\_t**

Parameter of Generic Default Transition Time state

### Public Members

uint8\_t **trans\_time**

The value of the Generic Default Transition Time state

struct **esp\_ble\_mesh\_gen\_def\_trans\_time\_srv\_t**

User data of Generic Default Transition Time Server Model

### Public Members

*esp\_ble\_mesh\_model\_t* \***model**

Pointer to the Generic Default Transition Time Server Model. Initialized internally.

*esp\_ble\_mesh\_server\_rsp\_ctrl\_t* **rsp\_ctrl**

Response control of the server model received messages

*esp\_ble\_mesh\_gen\_def\_trans\_time\_state\_t* **state**

Parameters of the Generic Default Transition Time state

struct **esp\_ble\_mesh\_gen\_onpowerup\_state\_t**

Parameter of Generic OnPowerUp state

**Public Members****uint8\_t onpowerup**

The value of the Generic OnPowerUp state

struct **esp\_ble\_mesh\_gen\_power\_onoff\_srv\_t**

User data of Generic Power OnOff Server Model

**Public Members***esp\_ble\_mesh\_model\_t* \***model**

Pointer to the Generic Power OnOff Server Model. Initialized internally.

*esp\_ble\_mesh\_server\_rsp\_ctrl\_t* **rsp\_ctrl**

Response control of the server model received messages

*esp\_ble\_mesh\_gen\_onpowerup\_state\_t* \***state**

Parameters of the Generic OnPowerUp state

struct **esp\_ble\_mesh\_gen\_power\_onoff\_setup\_srv\_t**

User data of Generic Power OnOff Setup Server Model

**Public Members***esp\_ble\_mesh\_model\_t* \***model**

Pointer to the Generic Power OnOff Setup Server Model. Initialized internally.

*esp\_ble\_mesh\_server\_rsp\_ctrl\_t* **rsp\_ctrl**

Response control of the server model received messages

*esp\_ble\_mesh\_gen\_onpowerup\_state\_t* \***state**

Parameters of the Generic OnPowerUp state

struct **esp\_ble\_mesh\_gen\_power\_level\_state\_t**

Parameters of Generic Power Level state

**Public Members****uint16\_t power\_actual**

The present value of the Generic Power Actual state

**uint16\_t target\_power\_actual**

The target value of the Generic Power Actual state

**uint16\_t power\_last**

The value of the Generic Power Last state

uint16\_t **power\_default**

The value of the Generic Power Default state

uint8\_t **status\_code**

The status code of setting Generic Power Range state

uint16\_t **power\_range\_min**

The minimum value of the Generic Power Range state

uint16\_t **power\_range\_max**

The maximum value of the Generic Power Range state

struct **esp\_ble\_mesh\_gen\_power\_level\_srv\_t**

User data of Generic Power Level Server Model

### Public Members

*esp\_ble\_mesh\_model\_t* \***model**

Pointer to the Generic Power Level Server Model. Initialized internally.

*esp\_ble\_mesh\_server\_rsp\_ctrl\_t* **rsp\_ctrl**

Response control of the server model received messages

*esp\_ble\_mesh\_gen\_power\_level\_state\_t* \***state**

Parameters of the Generic Power Level state

*esp\_ble\_mesh\_last\_msg\_info\_t* **last**

Parameters of the last received set message

*esp\_ble\_mesh\_state\_transition\_t* **transition**

Parameters of state transition

int32\_t **tt\_delta\_level**

Delta change value of level state transition

struct **esp\_ble\_mesh\_gen\_power\_level\_setup\_srv\_t**

User data of Generic Power Level Setup Server Model

### Public Members

*esp\_ble\_mesh\_model\_t* \***model**

Pointer to the Generic Power Level Setup Server Model. Initialized internally.

*esp\_ble\_mesh\_server\_rsp\_ctrl\_t* **rsp\_ctrl**

Response control of the server model received messages

*esp\_ble\_mesh\_gen\_power\_level\_state\_t* \*state

Parameters of the Generic Power Level state

struct **esp\_ble\_mesh\_gen\_battery\_state\_t**

Parameters of Generic Battery state

### Public Members

uint32\_t **battery\_level**

The value of the Generic Battery Level state

uint32\_t **time\_to\_discharge**

The value of the Generic Battery Time to Discharge state

uint32\_t **time\_to\_charge**

The value of the Generic Battery Time to Charge state

uint32\_t **battery\_flags**

The value of the Generic Battery Flags state

struct **esp\_ble\_mesh\_gen\_battery\_srv\_t**

User data of Generic Battery Server Model

### Public Members

*esp\_ble\_mesh\_model\_t* \*model

Pointer to the Generic Battery Server Model. Initialized internally.

*esp\_ble\_mesh\_server\_rsp\_ctrl\_t* **rsp\_ctrl**

Response control of the server model received messages

*esp\_ble\_mesh\_gen\_battery\_state\_t* **state**

Parameters of the Generic Battery state

struct **esp\_ble\_mesh\_gen\_location\_state\_t**

Parameters of Generic Location state

### Public Members

int32\_t **global\_latitude**

The value of the Global Latitude field

int32\_t **global\_longitude**

The value of the Global Longitude field

`int16_t global_altitude`

The value of the Global Altitude field

`int16_t local_north`

The value of the Local North field

`int16_t local_east`

The value of the Local East field

`int16_t local_altitude`

The value of the Local Altitude field

`uint8_t floor_number`

The value of the Floor Number field

`uint16_t uncertainty`

The value of the Uncertainty field

struct `esp_ble_mesh_gen_location_srv_t`

User data of Generic Location Server Model

### Public Members

`esp_ble_mesh_model_t *model`

Pointer to the Generic Location Server Model. Initialized internally.

`esp_ble_mesh_server_rsp_ctrl_t rsp_ctrl`

Response control of the server model received messages

`esp_ble_mesh_gen_location_state_t *state`

Parameters of the Generic Location state

struct `esp_ble_mesh_gen_location_setup_srv_t`

User data of Generic Location Setup Server Model

### Public Members

`esp_ble_mesh_model_t *model`

Pointer to the Generic Location Setup Server Model. Initialized internally.

`esp_ble_mesh_server_rsp_ctrl_t rsp_ctrl`

Response control of the server model received messages

`esp_ble_mesh_gen_location_state_t *state`

Parameters of the Generic Location state

struct `esp_ble_mesh_generic_property_t`

Parameters of Generic Property states

**Public Members****uint16\_t id**

The value of User/Admin/Manufacturer Property ID

**uint8\_t user\_access**

The value of User Access field

**uint8\_t admin\_access**

The value of Admin Access field

**uint8\_t manu\_access**

The value of Manufacturer Access field

**struct net\_buf\_simple \*val**

The value of User/Admin/Manufacturer Property

**struct esp\_ble\_mesh\_gen\_user\_prop\_srv\_t**

User data of Generic User Property Server Model

**Public Members*****esp\_ble\_mesh\_model\_t* \*model**

Pointer to the Generic User Property Server Model. Initialized internally.

***esp\_ble\_mesh\_server\_rsp\_ctrl\_t* rsp\_ctrl**

Response control of the server model received messages

**uint8\_t property\_count**

Generic User Property count

***esp\_ble\_mesh\_generic\_property\_t* \*properties**

Parameters of the Generic User Property state

**struct esp\_ble\_mesh\_gen\_admin\_prop\_srv\_t**

User data of Generic Admin Property Server Model

**Public Members*****esp\_ble\_mesh\_model\_t* \*model**

Pointer to the Generic Admin Property Server Model. Initialized internally.

***esp\_ble\_mesh\_server\_rsp\_ctrl\_t* rsp\_ctrl**

Response control of the server model received messages

**uint8\_t property\_count**

Generic Admin Property count

*esp\_ble\_mesh\_generic\_property\_t* \***properties**

Parameters of the Generic Admin Property state

struct **esp\_ble\_mesh\_gen\_manu\_prop\_srv\_t**

User data of Generic Manufacturer Property Server Model

### Public Members

*esp\_ble\_mesh\_model\_t* \***model**

Pointer to the Generic Manufacturer Property Server Model. Initialized internally.

*esp\_ble\_mesh\_server\_rsp\_ctrl\_t* **rsp\_ctrl**

Response control of the server model received messages

uint8\_t **property\_count**

Generic Manufacturer Property count

*esp\_ble\_mesh\_generic\_property\_t* \***properties**

Parameters of the Generic Manufacturer Property state

struct **esp\_ble\_mesh\_gen\_client\_prop\_srv\_t**

User data of Generic Client Property Server Model

### Public Members

*esp\_ble\_mesh\_model\_t* \***model**

Pointer to the Generic Client Property Server Model. Initialized internally.

*esp\_ble\_mesh\_server\_rsp\_ctrl\_t* **rsp\_ctrl**

Response control of the server model received messages

uint8\_t **id\_count**

Generic Client Property ID count

uint16\_t \***property\_ids**

Parameters of the Generic Client Property state

struct **esp\_ble\_mesh\_state\_change\_gen\_onoff\_set\_t**

Parameter of Generic OnOff Set state change event

### Public Members

uint8\_t **onoff**

The value of Generic OnOff state

struct **esp\_ble\_mesh\_state\_change\_gen\_level\_set\_t**

Parameter of Generic Level Set state change event

**Public Members****int16\_t level**

The value of Generic Level state

struct **esp\_ble\_mesh\_state\_change\_gen\_delta\_set\_t**

Parameter of Generic Delta Set state change event

**Public Members****int16\_t level**

The value of Generic Level state

struct **esp\_ble\_mesh\_state\_change\_gen\_move\_set\_t**

Parameter of Generic Move Set state change event

**Public Members****int16\_t level**

The value of Generic Level state

struct **esp\_ble\_mesh\_state\_change\_gen\_def\_trans\_time\_set\_t**

Parameter of Generic Default Transition Time Set state change event

**Public Members****uint8\_t trans\_time**

The value of Generic Default Transition Time state

struct **esp\_ble\_mesh\_state\_change\_gen\_onpowerup\_set\_t**

Parameter of Generic OnPowerUp Set state change event

**Public Members****uint8\_t onpowerup**

The value of Generic OnPowerUp state

struct **esp\_ble\_mesh\_state\_change\_gen\_power\_level\_set\_t**

Parameter of Generic Power Level Set state change event

**Public Members****uint16\_t power**

The value of Generic Power Actual state



struct **esp\_ble\_mesh\_state\_change\_gen\_power\_default\_set\_t**  
Parameter of Generic Power Default Set state change event

### Public Members

uint16\_t **power**  
The value of Generic Power Default state

struct **esp\_ble\_mesh\_state\_change\_gen\_power\_range\_set\_t**  
Parameters of Generic Power Range Set state change event

### Public Members

uint16\_t **range\_min**  
The minimum value of Generic Power Range state

uint16\_t **range\_max**  
The maximum value of Generic Power Range state

struct **esp\_ble\_mesh\_state\_change\_gen\_loc\_global\_set\_t**  
Parameters of Generic Location Global Set state change event

### Public Members

int32\_t **latitude**  
The Global Latitude value of Generic Location state

int32\_t **longitude**  
The Global Longitude value of Generic Location state

int16\_t **altitude**  
The Global Altitude value of Generic Location state

struct **esp\_ble\_mesh\_state\_change\_gen\_loc\_local\_set\_t**  
Parameters of Generic Location Local Set state change event

### Public Members

int16\_t **north**  
The Local North value of Generic Location state

int16\_t **east**  
The Local East value of Generic Location state

int16\_t **altitude**  
The Local Altitude value of Generic Location state

uint8\_t **floor\_number**

The Floor Number value of Generic Location state

uint16\_t **uncertainty**

The Uncertainty value of Generic Location state

struct **esp\_ble\_mesh\_state\_change\_gen\_user\_property\_set\_t**

Parameters of Generic User Property Set state change event

### **Public Members**

uint16\_t **id**

The property id of Generic User Property state

struct net\_buf\_simple \***value**

The property value of Generic User Property state

struct **esp\_ble\_mesh\_state\_change\_gen\_admin\_property\_set\_t**

Parameters of Generic Admin Property Set state change event

### **Public Members**

uint16\_t **id**

The property id of Generic Admin Property state

uint8\_t **access**

The property access of Generic Admin Property state

struct net\_buf\_simple \***value**

The property value of Generic Admin Property state

struct **esp\_ble\_mesh\_state\_change\_gen\_manu\_property\_set\_t**

Parameters of Generic Manufacturer Property Set state change event

### **Public Members**

uint16\_t **id**

The property id of Generic Manufacturer Property state

uint8\_t **access**

The property value of Generic Manufacturer Property state

struct **esp\_ble\_mesh\_server\_rcv\_gen\_user\_property\_get\_t**

Context of the received Generic User Property Get message

**Public Members****uint16\_t property\_id**

Property ID identifying a Generic User Property

struct **esp\_ble\_mesh\_server\_rcv\_gen\_admin\_property\_get\_t**

Context of the received Generic Admin Property Get message

**Public Members****uint16\_t property\_id**

Property ID identifying a Generic Admin Property

struct **esp\_ble\_mesh\_server\_rcv\_gen\_manufacturer\_property\_get\_t**

Context of the received Generic Manufacturer Property message

**Public Members****uint16\_t property\_id**

Property ID identifying a Generic Manufacturer Property

struct **esp\_ble\_mesh\_server\_rcv\_gen\_client\_properties\_get\_t**

Context of the received Generic Client Properties Get message

**Public Members****uint16\_t property\_id**

A starting Client Property ID present within an element

struct **esp\_ble\_mesh\_server\_rcv\_gen\_onoff\_set\_t**

Context of the received Generic OnOff Set message

**Public Members****bool op\_en**

Indicate if optional parameters are included

**uint8\_t onoff**

Target value of Generic OnOff state

**uint8\_t tid**

Transaction ID

**uint8\_t trans\_time**

Time to complete state transition (optional)

`uint8_t delay`

Indicate message execution delay (C.1)

struct `esp_ble_mesh_server_rcv_gen_level_set_t`

Context of the received Generic Level Set message

### Public Members

bool `op_en`

Indicate if optional parameters are included

int16\_t `level`

Target value of Generic Level state

uint8\_t `tid`

Transaction ID

uint8\_t `trans_time`

Time to complete state transition (optional)

uint8\_t `delay`

Indicate message execution delay (C.1)

struct `esp_ble_mesh_server_rcv_gen_delta_set_t`

Context of the received Generic Delta Set message

### Public Members

bool `op_en`

Indicate if optional parameters are included

int32\_t `delta_level`

Delta change of Generic Level state

uint8\_t `tid`

Transaction ID

uint8\_t `trans_time`

Time to complete state transition (optional)

uint8\_t `delay`

Indicate message execution delay (C.1)

struct `esp_ble_mesh_server_rcv_gen_move_set_t`

Context of the received Generic Move Set message

**Public Members****bool op\_en**

Indicate if optional parameters are included

**int16\_t delta\_level**

Delta Level step to calculate Move speed for Generic Level state

**uint8\_t tid**

Transaction ID

**uint8\_t trans\_time**

Time to complete state transition (optional)

**uint8\_t delay**

Indicate message execution delay (C.1)

struct **esp\_ble\_mesh\_server\_rcv\_gen\_def\_trans\_time\_set\_t**

Context of the received Generic Default Transition Time Set message

**Public Members****uint8\_t trans\_time**

The value of the Generic Default Transition Time state

struct **esp\_ble\_mesh\_server\_rcv\_gen\_onpowerup\_set\_t**

Context of the received Generic OnPowerUp Set message

**Public Members****uint8\_t onpowerup**

The value of the Generic OnPowerUp state

struct **esp\_ble\_mesh\_server\_rcv\_gen\_power\_level\_set\_t**

Context of the received Generic Power Level Set message

**Public Members****bool op\_en**

Indicate if optional parameters are included

**uint16\_t power**

Target value of Generic Power Actual state

**uint8\_t tid**

Transaction ID

`uint8_t trans_time`

Time to complete state transition (optional)

`uint8_t delay`

Indicate message execution delay (C.1)

struct `esp_ble_mesh_server_rcv_gen_power_default_set_t`

Context of the received Generic Power Default Set message

### Public Members

`uint16_t power`

The value of the Generic Power Default state

struct `esp_ble_mesh_server_rcv_gen_power_range_set_t`

Context of the received Generic Power Range Set message

### Public Members

`uint16_t range_min`

Value of Range Min field of Generic Power Range state

`uint16_t range_max`

Value of Range Max field of Generic Power Range state

struct `esp_ble_mesh_server_rcv_gen_loc_global_set_t`

Context of the received Generic Location Global Set message

### Public Members

`int32_t global_latitude`

Global Coordinates (Latitude)

`int32_t global_longitude`

Global Coordinates (Longitude)

`int16_t global_altitude`

Global Altitude

struct `esp_ble_mesh_server_rcv_gen_loc_local_set_t`

Context of the received Generic Location Local Set message

### Public Members

`int16_t local_north`

Local Coordinates (North)

`int16_t local_east`  
Local Coordinates (East)

`int16_t local_altitude`  
Local Altitude

`uint8_t floor_number`  
Floor Number

`uint16_t uncertainty`  
Uncertainty

struct `esp_ble_mesh_server_rcv_gen_user_property_set_t`  
Context of the received Generic User Property Set message

### Public Members

`uint16_t property_id`  
Property ID identifying a Generic User Property

struct `net_buf_simple *property_value`  
Raw value for the User Property

struct `esp_ble_mesh_server_rcv_gen_admin_property_set_t`  
Context of the received Generic Admin Property Set message

### Public Members

`uint16_t property_id`  
Property ID identifying a Generic Admin Property

`uint8_t user_access`  
Enumeration indicating user access

struct `net_buf_simple *property_value`  
Raw value for the Admin Property

struct `esp_ble_mesh_server_rcv_gen_manufacturer_property_set_t`  
Context of the received Generic Manufacturer Property Set message

### Public Members

`uint16_t property_id`  
Property ID identifying a Generic Manufacturer Property

uint8\_t **user\_access**

Enumeration indicating user access

struct **esp\_ble\_mesh\_generic\_server\_cb\_param\_t**

Generic Server Model callback parameters

### Public Members

*esp\_ble\_mesh\_model\_t* \***model**

Pointer to Generic Server Models

*esp\_ble\_mesh\_msg\_ctx\_t* **ctx**

Context of the received messages

*esp\_ble\_mesh\_generic\_server\_cb\_value\_t* **value**

Value of the received Generic Messages

### Macros

**ESP\_BLE\_MESH\_MODEL\_GEN\_ONOFF\_CLI** (cli\_pub, cli\_data)

Define a new Generic OnOff Client Model.

---

**备注:** This API needs to be called for each element on which the application needs to have a Generic OnOff Client Model.

---

#### 参数

- **cli\_pub** -- Pointer to the unique struct *esp\_ble\_mesh\_model\_pub\_t*.
- **cli\_data** -- Pointer to the unique struct *esp\_ble\_mesh\_client\_t*.

**返回** New Generic OnOff Client Model instance.

**ESP\_BLE\_MESH\_MODEL\_GEN\_LEVEL\_CLI** (cli\_pub, cli\_data)

Define a new Generic Level Client Model.

---

**备注:** This API needs to be called for each element on which the application needs to have a Generic Level Client Model.

---

#### 参数

- **cli\_pub** -- Pointer to the unique struct *esp\_ble\_mesh\_model\_pub\_t*.
- **cli\_data** -- Pointer to the unique struct *esp\_ble\_mesh\_client\_t*.

**返回** New Generic Level Client Model instance.

**ESP\_BLE\_MESH\_MODEL\_GEN\_DEF\_TRANS\_TIME\_CLI** (cli\_pub, cli\_data)

Define a new Generic Default Transition Time Client Model.

---

**备注:** This API needs to be called for each element on which the application needs to have a Generic Default Transition Time Client Model.

---

#### 参数

- **cli\_pub** -- Pointer to the unique struct *esp\_ble\_mesh\_model\_pub\_t*.



- **cli\_data** -- Pointer to the unique struct *esp\_ble\_mesh\_client\_t*.
- 返回 New Generic Default Transition Time Client Model instance.

**ESP\_BLE\_MESH\_MODEL\_GEN\_POWER\_ONOFF\_CLI** (cli\_pub, cli\_data)

Define a new Generic Power OnOff Client Model.

---

**备注:** This API needs to be called for each element on which the application needs to have a Generic Power OnOff Client Model.

---

**参数**

- **cli\_pub** -- Pointer to the unique struct *esp\_ble\_mesh\_model\_pub\_t*.
  - **cli\_data** -- Pointer to the unique struct *esp\_ble\_mesh\_client\_t*.
- 返回 New Generic Power OnOff Client Model instance.

**ESP\_BLE\_MESH\_MODEL\_GEN\_POWER\_LEVEL\_CLI** (cli\_pub, cli\_data)

Define a new Generic Power Level Client Model.

---

**备注:** This API needs to be called for each element on which the application needs to have a Generic Power Level Client Model.

---

**参数**

- **cli\_pub** -- Pointer to the unique struct *esp\_ble\_mesh\_model\_pub\_t*.
  - **cli\_data** -- Pointer to the unique struct *esp\_ble\_mesh\_client\_t*.
- 返回 New Generic Power Level Client Model instance.

**ESP\_BLE\_MESH\_MODEL\_GEN\_BATTERY\_CLI** (cli\_pub, cli\_data)

Define a new Generic Battery Client Model.

---

**备注:** This API needs to be called for each element on which the application needs to have a Generic Battery Client Model.

---

**参数**

- **cli\_pub** -- Pointer to the unique struct *esp\_ble\_mesh\_model\_pub\_t*.
  - **cli\_data** -- Pointer to the unique struct *esp\_ble\_mesh\_client\_t*.
- 返回 New Generic Battery Client Model instance.

**ESP\_BLE\_MESH\_MODEL\_GEN\_LOCATION\_CLI** (cli\_pub, cli\_data)

Define a new Generic Location Client Model.

---

**备注:** This API needs to be called for each element on which the application needs to have a Generic Location Client Model.

---

**参数**

- **cli\_pub** -- Pointer to the unique struct *esp\_ble\_mesh\_model\_pub\_t*.
  - **cli\_data** -- Pointer to the unique struct *esp\_ble\_mesh\_client\_t*.
- 返回 New Generic Location Client Model instance.

**ESP\_BLE\_MESH\_MODEL\_GEN\_PROPERTY\_CLI** (cli\_pub, cli\_data)

Define a new Generic Property Client Model.

---

**备注:** This API needs to be called for each element on which the application needs to have a Generic Property Client Model.

---

**参数**

- **cli\_pub** -- Pointer to the unique struct *esp\_ble\_mesh\_model\_pub\_t*.
- **cli\_data** -- Pointer to the unique struct *esp\_ble\_mesh\_client\_t*.

**返回** New Generic Location Client Model instance.

**ESP\_BLE\_MESH\_MODEL\_GEN\_ONOFF\_SRV** (srv\_pub, srv\_data)

Generic Server Models related context.

Define a new Generic OnOff Server Model.

---

**备注:** 1. The Generic OnOff Server Model is a root model.

- a. This model shall support model publication and model subscription.
- 

**参数**

- **srv\_pub** -- Pointer to the unique struct *esp\_ble\_mesh\_model\_pub\_t*.
- **srv\_data** -- Pointer to the unique struct *esp\_ble\_mesh\_gen\_onoff\_srv\_t*.

**返回** New Generic OnOff Server Model instance.

**ESP\_BLE\_MESH\_MODEL\_GEN\_LEVEL\_SRV** (srv\_pub, srv\_data)

Define a new Generic Level Server Model.

---

**备注:** 1. The Generic Level Server Model is a root model.

- a. This model shall support model publication and model subscription.
- 

**参数**

- **srv\_pub** -- Pointer to the unique struct *esp\_ble\_mesh\_model\_pub\_t*.
- **srv\_data** -- Pointer to the unique struct *esp\_ble\_mesh\_gen\_level\_srv\_t*.

**返回** New Generic Level Server Model instance.

**ESP\_BLE\_MESH\_MODEL\_GEN\_DEF\_TRANS\_TIME\_SRV** (srv\_pub, srv\_data)

Define a new Generic Default Transition Time Server Model.

---

**备注:** 1. The Generic Default Transition Time Server Model is a root model.

- a. This model shall support model publication and model subscription.
- 

**参数**

- **srv\_pub** -- Pointer to the unique struct *esp\_ble\_mesh\_model\_pub\_t*.
- **srv\_data** -- Pointer to the unique struct *esp\_ble\_mesh\_gen\_def\_trans\_time\_srv\_t*.

**返回** New Generic Default Transition Time Server Model instance.

**ESP\_BLE\_MESH\_MODEL\_GEN\_POWER\_ONOFF\_SRV** (srv\_pub, srv\_data)

Define a new Generic Power OnOff Server Model.

---

**备注:** 1. The Generic Power OnOff Server model extends the Generic OnOff Server model. When this model is present on an element, the corresponding Generic Power OnOff Setup Server model shall also be present.

- a. This model may be used to represent a variety of devices that do not fit any of the model descriptions that have been defined but support the generic properties of On/Off.
  - b. This model shall support model publication and model subscription.
- 

**参数**

- **srv\_pub** -- Pointer to the unique struct *esp\_ble\_mesh\_model\_pub\_t*.
- **srv\_data** -- Pointer to the unique struct *esp\_ble\_mesh\_gen\_power\_onoff\_srv\_t*.

**返回** New Generic Power OnOff Server Model instance.

---

**ESP\_BLE\_MESH\_MODEL\_GEN\_POWER\_ONOFF\_SETUP\_SRV** (srv\_pub, srv\_data)

Define a new Generic Power OnOff Setup Server Model.

---

**备注:** 1. The Generic Power OnOff Setup Server model extends the Generic Power OnOff Server model and the Generic Default Transition Time Server model.

- a. This model shall support model subscription.
- 

**参数**

- **srv\_pub** -- Pointer to the unique struct *esp\_ble\_mesh\_model\_pub\_t*.
- **srv\_data** -- Pointer to the unique struct *esp\_ble\_mesh\_gen\_power\_onoff\_setup\_srv\_t*.

**返回** New Generic Power OnOff Setup Server Model instance.

---

**ESP\_BLE\_MESH\_MODEL\_GEN\_POWER\_LEVEL\_SRV** (srv\_pub, srv\_data)

Define a new Generic Power Level Server Model.

---

**备注:** 1. The Generic Power Level Server model extends the Generic Power OnOff Server model and the Generic Level Server model. When this model is present on an Element, the corresponding Generic Power Level Setup Server model shall also be present.

- a. This model shall support model publication and model subscription.
- 

**参数**

- **srv\_pub** -- Pointer to the unique struct *esp\_ble\_mesh\_model\_pub\_t*.
- **srv\_data** -- Pointer to the unique struct *esp\_ble\_mesh\_gen\_power\_level\_srv\_t*.

**返回** New Generic Power Level Server Model instance.

---

**ESP\_BLE\_MESH\_MODEL\_GEN\_POWER\_LEVEL\_SETUP\_SRV** (srv\_pub, srv\_data)

Define a new Generic Power Level Setup Server Model.

---

**备注:** 1. The Generic Power Level Setup Server model extends the Generic Power Level Server model and the Generic Power OnOff Setup Server model.

- a. This model shall support model subscription.
- 

**参数**

- **srv\_pub** -- Pointer to the unique struct *esp\_ble\_mesh\_model\_pub\_t*.
- **srv\_data** -- Pointer to the unique struct *esp\_ble\_mesh\_gen\_power\_level\_setup\_srv\_t*.

**返回** New Generic Power Level Setup Server Model instance.

---

**ESP\_BLE\_MESH\_MODEL\_GEN\_BATTERY\_SRV** (srv\_pub, srv\_data)

Define a new Generic Battery Server Model.

---

**备注:** 1. The Generic Battery Server Model is a root model.

---

- a. This model shall support model publication and model subscription.
  - b. The model may be used to represent an element that is powered by a battery.
- 

**参数**

- **srv\_pub** -- Pointer to the unique struct *esp\_ble\_mesh\_model\_pub\_t*.
- **srv\_data** -- Pointer to the unique struct *esp\_ble\_mesh\_gen\_battery\_srv\_t*.

**返回** New Generic Battery Server Model instance.

---

**ESP\_BLE\_MESH\_MODEL\_GEN\_LOCATION\_SRV** (srv\_pub, srv\_data)

Define a new Generic Location Server Model.

---

**备注:** 1. The Generic Location Server model is a root model. When this model is present on an Element, the corresponding Generic Location Setup Server model shall also be present.

- a. This model shall support model publication and model subscription.
  - b. The model may be used to represent an element that knows its location (global or local).
- 

**参数**

- **srv\_pub** -- Pointer to the unique struct *esp\_ble\_mesh\_model\_pub\_t*.
- **srv\_data** -- Pointer to the unique struct *esp\_ble\_mesh\_gen\_location\_srv\_t*.

**返回** New Generic Location Server Model instance.

---

**ESP\_BLE\_MESH\_MODEL\_GEN\_LOCATION\_SETUP\_SRV** (srv\_pub, srv\_data)

Define a new Generic Location Setup Server Model.

---

**备注:** 1. The Generic Location Setup Server model extends the Generic Location Server model.

- a. This model shall support model subscription.
- 

**参数**

- **srv\_pub** -- Pointer to the unique struct *esp\_ble\_mesh\_model\_pub\_t*.
- **srv\_data** -- Pointer to the unique struct *esp\_ble\_mesh\_gen\_location\_setup\_srv\_t*.

**返回** New Generic Location Setup Server Model instance.

---

**ESP\_BLE\_MESH\_MODEL\_GEN\_USER\_PROP\_SRV** (srv\_pub, srv\_data)

Define a new Generic User Property Server Model.

---

**备注:** 1. The Generic User Property Server model is a root model.

- a. This model shall support model publication and model subscription.
- 

**参数**

- **srv\_pub** -- Pointer to the unique struct *esp\_ble\_mesh\_model\_pub\_t*.
- **srv\_data** -- Pointer to the unique struct *esp\_ble\_mesh\_gen\_user\_prop\_srv\_t*.

**返回** New Generic User Property Server Model instance.

---

**ESP\_BLE\_MESH\_MODEL\_GEN\_ADMIN\_PROP\_SRV** (srv\_pub, srv\_data)

Define a new Generic Admin Property Server Model.

---

**备注:** 1. The Generic Admin Property Server model extends the Generic User Property Server model.

- a. This model shall support model publication and model subscription.
-

**参数**

- **srv\_pub** -- Pointer to the unique struct *esp\_ble\_mesh\_model\_pub\_t*.
- **srv\_data** -- Pointer to the unique struct *esp\_ble\_mesh\_gen\_admin\_prop\_srv\_t*.

**返回** New Generic Admin Property Server Model instance.

**ESP\_BLE\_MESH\_MODEL\_GEN\_MANUFACTURER\_PROP\_SRV** (srv\_pub, srv\_data)

Define a new Generic Manufacturer Property Server Model.

---

**备注:** 1. The Generic Manufacturer Property Server model extends the Generic User Property Server model.

- a. This model shall support model publication and model subscription.
- 

**参数**

- **srv\_pub** -- Pointer to the unique struct *esp\_ble\_mesh\_model\_pub\_t*.
- **srv\_data** -- Pointer to the unique struct *esp\_ble\_mesh\_gen\_manu\_prop\_srv\_t*.

**返回** New Generic Manufacturer Property Server Model instance.

**ESP\_BLE\_MESH\_MODEL\_GEN\_CLIENT\_PROP\_SRV** (srv\_pub, srv\_data)

Define a new Generic User Property Server Model.

---

**备注:** 1. The Generic Client Property Server model is a root model.

- a. This model shall support model publication and model subscription.
- 

**参数**

- **srv\_pub** -- Pointer to the unique struct *esp\_ble\_mesh\_model\_pub\_t*.
- **srv\_data** -- Pointer to the unique struct *esp\_ble\_mesh\_gen\_client\_prop\_srv\_t*.

**返回** New Generic Client Property Server Model instance.

## Type Definitions

```
typedef void (*esp_ble_mesh_generic_client_cb_t)(esp_ble_mesh_generic_client_cb_event_t event,  
esp_ble_mesh_generic_client_cb_param_t *param)
```

Bluetooth Mesh Generic Client Model function.

Generic Client Model callback function type

**Param event** Event type

**Param param** Pointer to callback parameter

```
typedef void (*esp_ble_mesh_generic_server_cb_t)(esp_ble_mesh_generic_server_cb_event_t event,  
esp_ble_mesh_generic_server_cb_param_t *param)
```

Bluetooth Mesh Generic Server Model function.

Generic Server Model callback function type

**Param event** Event type

**Param param** Pointer to callback parameter

## Enumerations

```
enum esp_ble_mesh_generic_client_cb_event_t
```

This enum value is the event of Generic Client Model

*Values:*

enumerator **ESP\_BLE\_MESH\_GENERIC\_CLIENT\_GET\_STATE\_EVT**

enumerator **ESP\_BLE\_MESH\_GENERIC\_CLIENT\_SET\_STATE\_EVT**

enumerator **ESP\_BLE\_MESH\_GENERIC\_CLIENT\_PUBLISH\_EVT**

enumerator **ESP\_BLE\_MESH\_GENERIC\_CLIENT\_TIMEOUT\_EVT**

enumerator **ESP\_BLE\_MESH\_GENERIC\_CLIENT\_EVT\_MAX**

enum **esp\_ble\_mesh\_gen\_user\_prop\_access\_t**

This enum value is the access value of Generic User Property

*Values:*

enumerator **ESP\_BLE\_MESH\_GEN\_USER\_ACCESS\_PROHIBIT**

enumerator **ESP\_BLE\_MESH\_GEN\_USER\_ACCESS\_READ**

enumerator **ESP\_BLE\_MESH\_GEN\_USER\_ACCESS\_WRITE**

enumerator **ESP\_BLE\_MESH\_GEN\_USER\_ACCESS\_READ\_WRITE**

enum **esp\_ble\_mesh\_gen\_admin\_prop\_access\_t**

This enum value is the access value of Generic Admin Property

*Values:*

enumerator **ESP\_BLE\_MESH\_GEN\_ADMIN\_NOT\_USER\_PROP**

enumerator **ESP\_BLE\_MESH\_GEN\_ADMIN\_ACCESS\_READ**

enumerator **ESP\_BLE\_MESH\_GEN\_ADMIN\_ACCESS\_WRITE**

enumerator **ESP\_BLE\_MESH\_GEN\_ADMIN\_ACCESS\_READ\_WRITE**

enum **esp\_ble\_mesh\_gen\_manu\_prop\_access\_t**

This enum value is the access value of Generic Manufacturer Property

*Values:*

enumerator **ESP\_BLE\_MESH\_GEN\_MANU\_NOT\_USER\_PROP**

enumerator **ESP\_BLE\_MESH\_GEN\_MANU\_ACCESS\_READ**

enum **esp\_ble\_mesh\_generic\_server\_cb\_event\_t**

This enum value is the event of Generic Server Model

*Values:*

enumerator **ESP\_BLE\_MESH\_GENERIC\_SERVER\_STATE\_CHANGE\_EVT**

- i. When `get_auto_rsp` is set to `ESP_BLE_MESH_SERVER_AUTO_RSP`, no event will be callback to the application layer when Generic Get messages are received.
- ii. When `set_auto_rsp` is set to `ESP_BLE_MESH_SERVER_AUTO_RSP`, this event will be callback to the application layer when Generic Set/Set Unack messages are received.

enumerator **ESP\_BLE\_MESH\_GENERIC\_SERVER\_RECV\_GET\_MSG\_EVT**

When `get_auto_rsp` is set to `ESP_BLE_MESH_SERVER_RSP_BY_APP`, this event will be callback to the application layer when Generic Get messages are received.

enumerator **ESP\_BLE\_MESH\_GENERIC\_SERVER\_RECV\_SET\_MSG\_EVT**

When `set_auto_rsp` is set to `ESP_BLE_MESH_SERVER_RSP_BY_APP`, this event will be callback to the application layer when Generic Set/Set Unack messages are received.

enumerator **ESP\_BLE\_MESH\_GENERIC\_SERVER\_EVT\_MAX**

## Sensor Client/Server Models

### Header File

- `components/bt/esp_ble_mesh/api/models/include/esp_ble_mesh_sensor_model_api.h`
- This header file can be included with:

```
#include "esp_ble_mesh_sensor_model_api.h"
```

- This header file is a part of the API provided by the `bt` component. To declare that your component depends on `bt`, add the following to your `CMakeLists.txt`:

```
REQUIRES bt
```

or

```
PRIV_REQUIRES bt
```

### Functions

`esp_err_t esp_ble_mesh_register_sensor_client_callback` (`esp_ble_mesh_sensor_client_cb_t` callback)

Register BLE Mesh Sensor Client Model callback.

**参数** `callback` -- **[in]** Pointer to the callback function.

**返回** `ESP_OK` on success or error code otherwise.

`esp_err_t esp_ble_mesh_sensor_client_get_state` (`esp_ble_mesh_client_common_param_t` \*params, `esp_ble_mesh_sensor_client_get_state_t` \*get\_state)

Get the value of Sensor Server Model states using the Sensor Client Model get messages.

---

**备注:** If you want to know the opcodes and corresponding meanings accepted by this API, please refer to `esp_ble_mesh_sensor_message_opcode_t` in `esp_ble_mesh_defs.h`

---

**参数**

- **params** -- **[in]** Pointer to BLE Mesh common client parameters.
- **get\_state** -- **[in]** Pointer to sensor get message value. Shall not be set to `NULL`.

**返回** `ESP_OK` on success or error code otherwise.

*esp\_err\_t* **esp\_ble\_mesh\_sensor\_client\_set\_state** (*esp\_ble\_mesh\_client\_common\_param\_t* \*params, *esp\_ble\_mesh\_sensor\_client\_set\_state\_t* \*set\_state)

Set the value of Sensor Server Model states using the Sensor Client Model set messages.

---

**备注:** If you want to know the opcodes and corresponding meanings accepted by this API, please refer to *esp\_ble\_mesh\_sensor\_message\_opcode\_t* in *esp\_ble\_mesh\_defs.h*

---

#### 参数

- **params** -- [in] Pointer to BLE Mesh common client parameters.
- **set\_state** -- [in] Pointer to sensor set message value. Shall not be set to NULL.

**返回** ESP\_OK on success or error code otherwise.

*esp\_err\_t* **esp\_ble\_mesh\_register\_sensor\_server\_callback** (*esp\_ble\_mesh\_sensor\_server\_cb\_t* callback)

Register BLE Mesh Sensor Server Model callback.

**参数** **callback** -- [in] Pointer to the callback function.

**返回** ESP\_OK on success or error code otherwise.

## Unions

union **esp\_ble\_mesh\_sensor\_client\_get\_state\_t**

#include <esp\_ble\_mesh\_sensor\_model\_api.h> Sensor Client Model get message union.

## Public Members

*esp\_ble\_mesh\_sensor\_descriptor\_get\_t* **descriptor\_get**

For ESP\_BLE\_MESH\_MODEL\_OP\_SENSOR\_DESCRIPTOR\_GET

*esp\_ble\_mesh\_sensor\_cadence\_get\_t* **cadence\_get**

For ESP\_BLE\_MESH\_MODEL\_OP\_SENSOR\_CADENCE\_GET

*esp\_ble\_mesh\_sensor\_settings\_get\_t* **settings\_get**

For ESP\_BLE\_MESH\_MODEL\_OP\_SENSOR\_SETTINGS\_GET

*esp\_ble\_mesh\_sensor\_setting\_get\_t* **setting\_get**

For ESP\_BLE\_MESH\_MODEL\_OP\_SENSOR\_SETTING\_GET

*esp\_ble\_mesh\_sensor\_get\_t* **sensor\_get**

For ESP\_BLE\_MESH\_MODEL\_OP\_SENSOR\_GET

*esp\_ble\_mesh\_sensor\_column\_get\_t* **column\_get**

For ESP\_BLE\_MESH\_MODEL\_OP\_SENSOR\_COLUMN\_GET

*esp\_ble\_mesh\_sensor\_series\_get\_t* **series\_get**

For ESP\_BLE\_MESH\_MODEL\_OP\_SENSOR\_SERIES\_GET

union **esp\_ble\_mesh\_sensor\_client\_set\_state\_t**

#include <esp\_ble\_mesh\_sensor\_model\_api.h> Sensor Client Model set message union.



**Public Members***esp\_ble\_mesh\_sensor\_cadence\_set\_t* **cadence\_set**

For ESP\_BLE\_MESH\_MODEL\_OP\_SENSOR\_CADENCE\_SET &  
 ESP\_BLE\_MESH\_MODEL\_OP\_SENSOR\_CADENCE\_SET\_UNACK

*esp\_ble\_mesh\_sensor\_setting\_set\_t* **setting\_set**

For ESP\_BLE\_MESH\_MODEL\_OP\_SENSOR\_SETTING\_SET &  
 ESP\_BLE\_MESH\_MODEL\_OP\_SENSOR\_SETTING\_SET\_UNACK

union **esp\_ble\_mesh\_sensor\_client\_status\_cb\_t***#include <esp\_ble\_mesh\_sensor\_model\_api.h>* Sensor Client Model received message union.**Public Members***esp\_ble\_mesh\_sensor\_descriptor\_status\_cb\_t* **descriptor\_status**

For ESP\_BLE\_MESH\_MODEL\_OP\_SENSOR\_DESCRIPTOR\_STATUS

*esp\_ble\_mesh\_sensor\_cadence\_status\_cb\_t* **cadence\_status**

For ESP\_BLE\_MESH\_MODEL\_OP\_SENSOR\_CADENCE\_STATUS

*esp\_ble\_mesh\_sensor\_settings\_status\_cb\_t* **settings\_status**

For ESP\_BLE\_MESH\_MODEL\_OP\_SENSOR\_SETTINGS\_STATUS

*esp\_ble\_mesh\_sensor\_setting\_status\_cb\_t* **setting\_status**

For ESP\_BLE\_MESH\_MODEL\_OP\_SENSOR\_SETTING\_STATUS

*esp\_ble\_mesh\_sensor\_status\_cb\_t* **sensor\_status**

For ESP\_BLE\_MESH\_MODEL\_OP\_SENSOR\_STATUS

*esp\_ble\_mesh\_sensor\_column\_status\_cb\_t* **column\_status**

For ESP\_BLE\_MESH\_MODEL\_OP\_SENSOR\_COLUMN\_STATUS

*esp\_ble\_mesh\_sensor\_series\_status\_cb\_t* **series\_status**

For ESP\_BLE\_MESH\_MODEL\_OP\_SENSOR\_SERIES\_STATUS

union **esp\_ble\_mesh\_sensor\_server\_state\_change\_t***#include <esp\_ble\_mesh\_sensor\_model\_api.h>* Sensor Server Model state change value union.**Public Members***esp\_ble\_mesh\_state\_change\_sensor\_cadence\_set\_t* **sensor\_cadence\_set**The *recv\_op* in *ctx* can be used to decide which state is changed. Sensor Cadence Set*esp\_ble\_mesh\_state\_change\_sensor\_setting\_set\_t* **sensor\_setting\_set**

Sensor Setting Set

union **esp\_ble\_mesh\_sensor\_server\_recv\_get\_msg\_t***#include <esp\_ble\_mesh\_sensor\_model\_api.h>* Sensor Server Model received get message union.

**Public Members**

*esp\_ble\_mesh\_server\_rcv\_sensor\_descriptor\_get\_t* **sensor\_descriptor**

Sensor Descriptor Get

*esp\_ble\_mesh\_server\_rcv\_sensor\_cadence\_get\_t* **sensor\_cadence**

Sensor Cadence Get

*esp\_ble\_mesh\_server\_rcv\_sensor\_settings\_get\_t* **sensor\_settings**

Sensor Settings Get

*esp\_ble\_mesh\_server\_rcv\_sensor\_setting\_get\_t* **sensor\_setting**

Sensor Setting Get

*esp\_ble\_mesh\_server\_rcv\_sensor\_ble\_t* **sensor\_data**

Sensor Get

*esp\_ble\_mesh\_server\_rcv\_sensor\_column\_get\_t* **sensor\_column**

Sensor Column Get

*esp\_ble\_mesh\_server\_rcv\_sensor\_series\_get\_t* **sensor\_series**

Sensor Series Get

union **esp\_ble\_mesh\_sensor\_server\_rcv\_set\_msg\_t**

*#include <esp\_ble\_mesh\_sensor\_model\_api.h>* Sensor Server Model received set message union.

**Public Members**

*esp\_ble\_mesh\_server\_rcv\_sensor\_cadence\_set\_t* **sensor\_cadence**

Sensor Cadence Set

*esp\_ble\_mesh\_server\_rcv\_sensor\_setting\_set\_t* **sensor\_setting**

Sensor Setting Set

union **esp\_ble\_mesh\_sensor\_server\_cb\_value\_t**

*#include <esp\_ble\_mesh\_sensor\_model\_api.h>* Sensor Server Model callback value union.

**Public Members**

*esp\_ble\_mesh\_sensor\_server\_state\_change\_t* **state\_change**

ESP\_BLE\_MESH\_SENSOR\_SERVER\_STATE\_CHANGE\_EVT

*esp\_ble\_mesh\_sensor\_server\_rcv\_get\_msg\_t* **get**

ESP\_BLE\_MESH\_SENSOR\_SERVER\_RECV\_GET\_MSG\_EVT

*esp\_ble\_mesh\_sensor\_server\_rcv\_set\_msg\_t* **set**

ESP\_BLE\_MESH\_SENSOR\_SERVER\_RECV\_SET\_MSG\_EVT

## Structures

struct **esp\_ble\_mesh\_sensor\_descriptor\_get\_t**

Bluetooth Mesh Sensor Client Model Get and Set parameters structure.

Parameters of Sensor Descriptor Get

### Public Members

bool **op\_en**

Indicate if optional parameters are included

uint16\_t **property\_id**

Property ID of a sensor (optional)

struct **esp\_ble\_mesh\_sensor\_cadence\_get\_t**

Parameter of Sensor Cadence Get

### Public Members

uint16\_t **property\_id**

Property ID of a sensor

struct **esp\_ble\_mesh\_sensor\_cadence\_set\_t**

Parameters of Sensor Cadence Set

### Public Members

uint16\_t **property\_id**

Property ID for the sensor

uint8\_t **fast\_cadence\_period\_divisor**

Divisor for the publish period

uint8\_t **status\_trigger\_type**

The unit and format of the Status Trigger Delta fields

struct net\_buf\_simple \***status\_trigger\_delta\_down**

Delta down value that triggers a status message

struct net\_buf\_simple \***status\_trigger\_delta\_up**

Delta up value that triggers a status message

uint8\_t **status\_min\_interval**

Minimum interval between two consecutive Status messages

struct net\_buf\_simple \***fast\_cadence\_low**

Low value for the fast cadence range

struct net\_buf\_simple \***fast\_cadence\_high**  
Fast value for the fast cadence range

struct **esp\_ble\_mesh\_sensor\_settings\_get\_t**  
Parameter of Sensor Settings Get

### Public Members

uint16\_t **sensor\_property\_id**  
Property ID of a sensor

struct **esp\_ble\_mesh\_sensor\_setting\_get\_t**  
Parameters of Sensor Setting Get

### Public Members

uint16\_t **sensor\_property\_id**  
Property ID of a sensor

uint16\_t **sensor\_setting\_property\_id**  
Setting ID identifying a setting within a sensor

struct **esp\_ble\_mesh\_sensor\_setting\_set\_t**  
Parameters of Sensor Setting Set

### Public Members

uint16\_t **sensor\_property\_id**  
Property ID identifying a sensor

uint16\_t **sensor\_setting\_property\_id**  
Setting ID identifying a setting within a sensor

struct net\_buf\_simple \***sensor\_setting\_raw**  
Raw value for the setting

struct **esp\_ble\_mesh\_sensor\_get\_t**  
Parameters of Sensor Get

### Public Members

bool **op\_en**  
Indicate if optional parameters are included

uint16\_t **property\_id**  
Property ID for the sensor (optional)

struct **esp\_ble\_mesh\_sensor\_column\_get\_t**

Parameters of Sensor Column Get

### Public Members

uint16\_t **property\_id**

Property identifying a sensor

struct net\_buf\_simple \***raw\_value\_x**

Raw value identifying a column

struct **esp\_ble\_mesh\_sensor\_series\_get\_t**

Parameters of Sensor Series Get

### Public Members

bool **op\_en**

Indicate if optional parameters are included

uint16\_t **property\_id**

Property identifying a sensor

struct net\_buf\_simple \***raw\_value\_x1**

Raw value identifying a starting column (optional)

struct net\_buf\_simple \***raw\_value\_x2**

Raw value identifying an ending column (C.1)

struct **esp\_ble\_mesh\_sensor\_descriptor\_status\_cb\_t**

Bluetooth Mesh Sensor Client Model Get and Set callback parameters structure.

Parameter of Sensor Descriptor Status

### Public Members

struct net\_buf\_simple \***descriptor**

Sequence of 8-octet sensor descriptors (optional)

struct **esp\_ble\_mesh\_sensor\_cadence\_status\_cb\_t**

Parameters of Sensor Cadence Status

### Public Members

uint16\_t **property\_id**

Property for the sensor

struct net\_buf\_simple \***sensor\_cadence\_value**

Value of sensor cadence state

struct **esp\_ble\_mesh\_sensor\_settings\_status\_cb\_t**

Parameters of Sensor Settings Status

### Public Members

uint16\_t **sensor\_property\_id**

Property ID identifying a sensor

struct net\_buf\_simple \***sensor\_setting\_property\_ids**

A sequence of N sensor setting property IDs (optional)

struct **esp\_ble\_mesh\_sensor\_setting\_status\_cb\_t**

Parameters of Sensor Setting Status

### Public Members

bool **op\_en**

Indicate id optional parameters are included

uint16\_t **sensor\_property\_id**

Property ID identifying a sensor

uint16\_t **sensor\_setting\_property\_id**

Setting ID identifying a setting within a sensor

uint8\_t **sensor\_setting\_access**

Read/Write access rights for the setting (optional)

struct net\_buf\_simple \***sensor\_setting\_raw**

Raw value for the setting

struct **esp\_ble\_mesh\_sensor\_status\_cb\_t**

Parameter of Sensor Status

### Public Members

struct net\_buf\_simple \***marshalled\_sensor\_data**

Value of sensor data state (optional)

struct **esp\_ble\_mesh\_sensor\_column\_status\_cb\_t**

Parameters of Sensor Column Status

**Public Members****uint16\_t property\_id**

Property identifying a sensor and the Y axis

**struct net\_buf\_simple \*sensor\_column\_value**

Left values of sensor column status

**struct esp\_ble\_mesh\_sensor\_series\_status\_cb\_t**

Parameters of Sensor Series Status

**Public Members****uint16\_t property\_id**

Property identifying a sensor and the Y axis

**struct net\_buf\_simple \*sensor\_series\_value**

Left values of sensor series status

**struct esp\_ble\_mesh\_sensor\_client\_cb\_param\_t**

Sensor Client Model callback parameters

**Public Members****int error\_code**

0: success, otherwise failure. For the error code values please refer to errno.h file. A negative sign is added to the standard error codes in errno.h.

***esp\_ble\_mesh\_client\_common\_param\_t* \*params**

The client common parameters.

***esp\_ble\_mesh\_sensor\_client\_status\_cb\_t* status\_cb**

The sensor status message callback values

**struct esp\_ble\_mesh\_sensor\_descriptor\_t**

Parameters of Sensor Descriptor state

**Public Members****uint32\_t positive\_tolerance**

The value of Sensor Positive Tolerance field

**uint32\_t negative\_tolerance**

The value of Sensor Negative Tolerance field

**uint32\_t sampling\_function**

The value of Sensor Sampling Function field

`uint8_t measure_period`

The value of Sensor Measurement Period field

`uint8_t update_interval`

The value of Sensor Update Interval field

struct `esp_ble_mesh_sensor_setting_t`

Parameters of Sensor Setting state

### Public Members

`uint16_t property_id`

The value of Sensor Setting Property ID field

`uint8_t access`

The value of Sensor Setting Access field

struct net\_buf\_simple \*`raw`

The value of Sensor Setting Raw field

struct `esp_ble_mesh_sensor_cadence_t`

Parameters of Sensor Cadence state

### Public Members

`uint8_t period_divisor`

The value of Fast Cadence Period Divisor field

`uint8_t trigger_type`

The value of Status Trigger Type field

struct net\_buf\_simple \*`trigger_delta_down`

Note: The parameter "size" in `trigger_delta_down`, `trigger_delta_up`, `fast_cadence_low` & `fast_cadence_high` indicates the exact length of these four parameters, and they are associated with the Sensor Property ID. Users need to initialize the "size" precisely. The value of Status Trigger Delta Down field

struct net\_buf\_simple \*`trigger_delta_up`

The value of Status Trigger Delta Up field

`uint8_t min_interval`

The value of Status Min Interval field

struct net\_buf\_simple \*`fast_cadence_low`

The value of Fast Cadence Low field

struct net\_buf\_simple \*`fast_cadence_high`

The value of Fast Cadence High field



struct **esp\_ble\_mesh\_sensor\_data\_t**

Parameters of Sensor Data state

### Public Members

uint8\_t **format**

Format A: The Length field is a 1-based uint4 value (valid range 0x0–0xF, representing range of 1–16).

Format B: The Length field is a 1-based uint7 value (valid range 0x0–0x7F, representing range of 1–127). The value 0x7F represents a length of zero. The value of the Sensor Data format

uint8\_t **length**

The value of the Sensor Data length

struct net\_buf\_simple \***raw\_value**

The value of Sensor Data raw value

struct **esp\_ble\_mesh\_sensor\_series\_column\_t**

Parameters of Sensor Series Column state

### Public Members

struct net\_buf\_simple \***raw\_value\_x**

The value of Sensor Raw Value X field

struct net\_buf\_simple \***column\_width**

The value of Sensor Column Width field

struct net\_buf\_simple \***raw\_value\_y**

The value of Sensor Raw Value Y field

struct **esp\_ble\_mesh\_sensor\_state\_t**

Parameters of Sensor states

### Public Members

uint16\_t **sensor\_property\_id**

The value of Sensor Property ID field

*esp\_ble\_mesh\_sensor\_descriptor\_t* **descriptor**

Parameters of the Sensor Descriptor state

const uint8\_t **setting\_count**

Multiple Sensor Setting states may be present for each sensor. The Sensor Setting Property ID values shall be unique for each Sensor Property ID that identifies a sensor within an element.

*esp\_ble\_mesh\_sensor\_setting\_t* \***settings**

Parameters of the Sensor Setting state

*esp\_ble\_mesh\_sensor\_cadence\_t* \***cadence**

The Sensor Cadence state may be not supported by sensors based on device properties referencing "non-scalar characteristics" such as "histograms" or "composite characteristics". Parameters of the Sensor Cadence state

*esp\_ble\_mesh\_sensor\_data\_t* **sensor\_data**

Parameters of the Sensor Data state

*esp\_ble\_mesh\_sensor\_series\_column\_t* **series\_column**

Parameters of the Sensor Series Column state

struct **esp\_ble\_mesh\_sensor\_srv\_t**

User data of Sensor Server Model

### Public Members

*esp\_ble\_mesh\_model\_t* \***model**

Pointer to the Sensor Server Model. Initialized internally.

*esp\_ble\_mesh\_server\_rsp\_ctrl\_t* **rsp\_ctrl**

Response control of the server model received messages

const uint8\_t **state\_count**

Sensor state count

*esp\_ble\_mesh\_sensor\_state\_t* \***states**

Parameters of the Sensor states

struct **esp\_ble\_mesh\_sensor\_setup\_srv\_t**

User data of Sensor Setup Server Model

### Public Members

*esp\_ble\_mesh\_model\_t* \***model**

Pointer to the Sensor Setup Server Model. Initialized internally.

*esp\_ble\_mesh\_server\_rsp\_ctrl\_t* **rsp\_ctrl**

Response control of the server model received messages

const uint8\_t **state\_count**

Sensor state count

*esp\_ble\_mesh\_sensor\_state\_t* \***states**

Parameters of the Sensor states

struct **esp\_ble\_mesh\_state\_change\_sensor\_cadence\_set\_t**

Parameters of Sensor Cadence Set state change event

**Public Members****uint16\_t property\_id**

The value of Sensor Property ID state

**uint8\_t period\_divisor**

The value of Fast Cadence Period Divisor state

**uint8\_t trigger\_type**

The value of Status Trigger Type state

**struct net\_buf\_simple \*trigger\_delta\_down**

The value of Status Trigger Delta Down state

**struct net\_buf\_simple \*trigger\_delta\_up**

The value of Status Trigger Delta Up state

**uint8\_t min\_interval**

The value of Status Min Interval state

**struct net\_buf\_simple \*fast\_cadence\_low**

The value of Fast Cadence Low state

**struct net\_buf\_simple \*fast\_cadence\_high**

The value of Fast Cadence High state

**struct esp\_ble\_mesh\_state\_change\_sensor\_setting\_set\_t**

Parameters of Sensor Setting Set state change event

**Public Members****uint16\_t property\_id**

The value of Sensor Property ID state

**uint16\_t setting\_property\_id**

The value of Sensor Setting Property ID state

**struct net\_buf\_simple \*setting\_value**

The value of Sensor Property Value state

**struct esp\_ble\_mesh\_server\_recv\_sensor\_descriptor\_get\_t**

Context of the received Sensor Descriptor Get message

**Public Members****bool op\_en**

Indicate if optional parameters are included

uint16\_t **property\_id**

Property ID of a sensor (optional)

struct **esp\_ble\_mesh\_server\_rcv\_sensor\_cadence\_get\_t**

Context of the received Sensor Cadence Get message

### Public Members

uint16\_t **property\_id**

Property ID of a sensor

struct **esp\_ble\_mesh\_server\_rcv\_sensor\_settings\_get\_t**

Context of the received Sensor Settings Get message

### Public Members

uint16\_t **property\_id**

Property ID of a sensor

struct **esp\_ble\_mesh\_server\_rcv\_sensor\_setting\_get\_t**

Context of the received Sensor Setting Get message

### Public Members

uint16\_t **property\_id**

Property ID of a sensor

uint16\_t **setting\_property\_id**

Setting ID identifying a setting within a sensor

struct **esp\_ble\_mesh\_server\_rcv\_sensor\_get\_t**

Context of the received Sensor Get message

### Public Members

bool **op\_en**

Indicate if optional parameters are included

uint16\_t **property\_id**

Property ID for the sensor (optional)

struct **esp\_ble\_mesh\_server\_rcv\_sensor\_column\_get\_t**

Context of the received Sensor Column Get message

**Public Members**

uint16\_t **property\_id**

Property identifying a sensor

struct net\_buf\_simple \***raw\_value\_x**

Raw value identifying a column

struct **esp\_ble\_mesh\_server\_rcv\_sensor\_series\_get\_t**

Context of the received Sensor Series Get message

**Public Members**

bool **op\_en**

Indicate if optional parameters are included

uint16\_t **property\_id**

Property identifying a sensor

struct net\_buf\_simple \***raw\_value**

Raw value containing X1 and X2 (optional)

struct **esp\_ble\_mesh\_server\_rcv\_sensor\_cadence\_set\_t**

Context of the received Sensor Cadence Set message

**Public Members**

uint16\_t **property\_id**

Property ID for the sensor

struct net\_buf\_simple \***cadence**

Value of Sensor Cadence state

struct **esp\_ble\_mesh\_server\_rcv\_sensor\_setting\_set\_t**

Context of the received Sensor Setting Set message

**Public Members**

uint16\_t **property\_id**

Property ID identifying a sensor

uint16\_t **setting\_property\_id**

Setting ID identifying a setting within a sensor

struct net\_buf\_simple \***setting\_raw**

Raw value for the setting

struct **esp\_ble\_mesh\_sensor\_server\_cb\_param\_t**

Sensor Server Model callback parameters

### Public Members

*esp\_ble\_mesh\_model\_t* \***model**

Pointer to Sensor Server Models

*esp\_ble\_mesh\_msg\_ctx\_t* **ctx**

Context of the received messages

*esp\_ble\_mesh\_sensor\_server\_cb\_value\_t* **value**

Value of the received Sensor Messages

### Macros

**ESP\_BLE\_MESH\_MODEL\_SENSOR\_CLI** (cli\_pub, cli\_data)

Define a new Sensor Client Model.

---

**备注:** This API needs to be called for each element on which the application needs to have a Sensor Client Model.

---

#### 参数

- **cli\_pub** -- Pointer to the unique struct *esp\_ble\_mesh\_model\_pub\_t*.
- **cli\_data** -- Pointer to the unique struct *esp\_ble\_mesh\_client\_t*.

**返回** New Sensor Client Model instance.

**ESP\_BLE\_MESH\_MODEL\_SENSOR\_SRV** (srv\_pub, srv\_data)

Sensor Server Models related context.

Define a new Sensor Server Model.

---

**备注:** 1. The Sensor Server model is a root model. When this model is present on an element, the corresponding Sensor Setup Server model shall also be present.

- a. This model shall support model publication and model subscription.
- 

#### 参数

- **srv\_pub** -- Pointer to the unique struct *esp\_ble\_mesh\_model\_pub\_t*.
- **srv\_data** -- Pointer to the unique struct *esp\_ble\_mesh\_sensor\_srv\_t*.

**返回** New Sensor Server Model instance.

**ESP\_BLE\_MESH\_MODEL\_SENSOR\_SETUP\_SRV** (srv\_pub, srv\_data)

Define a new Sensor Setup Server Model.

---

**备注:** 1. The Sensor Setup Server model extends the Sensor Server model.

- a. This model shall support model publication and model subscription.
- 

#### 参数

- **srv\_pub** -- Pointer to the unique struct *esp\_ble\_mesh\_model\_pub\_t*.

- **srv\_data** -- Pointer to the unique struct *esp\_ble\_mesh\_sensor\_setup\_srv\_t*.  
返回 New Sensor Setup Server Model instance.

**ESP\_BLE\_MESH\_INVALID\_SENSOR\_PROPERTY\_ID**

Invalid Sensor Property ID

**ESP\_BLE\_MESH\_SENSOR\_PROPERTY\_ID\_LEN**

Length of Sensor Property ID

**ESP\_BLE\_MESH\_SENSOR\_DESCRIPTOR\_LEN**

Length of Sensor Descriptor state

**ESP\_BLE\_MESH\_SENSOR\_UNSPECIFIED\_POS\_TOLERANCE**

Unspecified Sensor Positive Tolerance

**ESP\_BLE\_MESH\_SENSOR\_UNSPECIFIED\_NEG\_TOLERANCE**

Unspecified Sensor Negative Tolerance

**ESP\_BLE\_MESH\_SENSOR\_NOT\_APPL\_MEASURE\_PERIOD**

Not applicable Sensor Measurement Period

**ESP\_BLE\_MESH\_SENSOR\_NOT\_APPL\_UPDATE\_INTERVAL**

Not applicable Sensor Update Interval

**ESP\_BLE\_MESH\_INVALID\_SENSOR\_SETTING\_PROPERTY\_ID**

Invalid Sensor Setting Property ID

**ESP\_BLE\_MESH\_SENSOR\_SETTING\_PROPERTY\_ID\_LEN**

Length of Sensor Setting Property ID

**ESP\_BLE\_MESH\_SENSOR\_SETTING\_ACCESS\_LEN**

Length of Sensor Setting Access

**ESP\_BLE\_MESH\_SENSOR\_SETTING\_ACCESS\_READ**

Sensor Setting Access - Read

**ESP\_BLE\_MESH\_SENSOR\_SETTING\_ACCESS\_READ\_WRITE**

Sensor Setting Access - Read & Write

**ESP\_BLE\_MESH\_SENSOR\_DIVISOR\_TRIGGER\_TYPE\_LEN**

Length of Sensor Divisor Trigger Type

**ESP\_BLE\_MESH\_SENSOR\_STATUS\_MIN\_INTERVAL\_LEN**

Length of Sensor Status Min Interval

**ESP\_BLE\_MESH\_SENSOR\_PERIOD\_DIVISOR\_MAX\_VALUE**

Maximum value of Sensor Period Divisor

**ESP\_BLE\_MESH\_SENSOR\_STATUS\_MIN\_INTERVAL\_MAX**

Maximum value of Sensor Status Min Interval

**ESP\_BLE\_MESH\_SENSOR\_STATUS\_TRIGGER\_TYPE\_CHAR**

Sensor Status Trigger Type - Format Type of the characteristic that the Sensor Property ID state references

**ESP\_BLE\_MESH\_SENSOR\_STATUS\_TRIGGER\_TYPE\_UINT16**

Sensor Status Trigger Type - Format Type "uint16"

**ESP\_BLE\_MESH\_SENSOR\_DATA\_FORMAT\_A**

Sensor Data Format A

**ESP\_BLE\_MESH\_SENSOR\_DATA\_FORMAT\_B**

Sensor Data Format B

**ESP\_BLE\_MESH\_SENSOR\_DATA\_FORMAT\_A\_MPID\_LEN**

MPID length of Sensor Data Format A

**ESP\_BLE\_MESH\_SENSOR\_DATA\_FORMAT\_B\_MPID\_LEN**

MPID length of Sensor Data Format B

**ESP\_BLE\_MESH\_SENSOR\_DATA\_ZERO\_LEN**

Zero length of Sensor Data.

Note: The Length field is a 1-based uint7 value (valid range 0x0–0x7F, representing range of 1–127). The value 0x7F represents a length of zero.

**ESP\_BLE\_MESH\_GET\_SENSOR\_DATA\_FORMAT** (\_data)

Get format of the sensor data.

---

**备注:** Multiple sensor data may be concatenated. Make sure the \_data pointer is updated before getting the format of the corresponding sensor data.

---

**参数**

- **\_data** -- Pointer to the start of the sensor data.

**返回** Format of the sensor data.

**ESP\_BLE\_MESH\_GET\_SENSOR\_DATA\_LENGTH** (\_data, \_fmt)

Get length of the sensor data.

---

**备注:** Multiple sensor data may be concatenated. Make sure the \_data pointer is updated before getting the length of the corresponding sensor data.

---

**参数**

- **\_data** -- Pointer to the start of the sensor data.
- **\_fmt** -- Format of the sensor data.

**返回** Length (zero-based) of the sensor data.



**ESP\_BLE\_MESH\_GET\_SENSOR\_DATA\_PROPERTY\_ID** (\_data, \_fmt)

Get Sensor Property ID of the sensor data.

---

**备注:** Multiple sensor data may be concatenated. Make sure the \_data pointer is updated before getting Sensor Property ID of the corresponding sensor data.

---

**参数**

- **\_data** -- Pointer to the start of the sensor data.
- **\_fmt** -- Format of the sensor data.

**返回** Sensor Property ID of the sensor data.

**ESP\_BLE\_MESH\_SENSOR\_DATA\_FORMAT\_A\_MPID** (\_len, \_id)

Generate a MPID value for sensor data with Format A.

---

**备注:** 1. The Format field is 0b0 and indicates that Format A is used.

- a. The Length field is a 1-based uint4 value (valid range 0x0–0xF, representing range of 1–16).
  - b. The Property ID is an 11-bit bit field representing 11 LSB of a Property ID.
  - c. This format may be used for Property Values that are not longer than 16 octets and for Property IDs less than 0x0800.
- 

**参数**

- **\_len** -- Length of Sensor Raw value.
- **\_id** -- Sensor Property ID.

**返回** 2-octet MPID value for sensor data with Format A.

**ESP\_BLE\_MESH\_SENSOR\_DATA\_FORMAT\_B\_MPID** (\_len, \_id)

Generate a MPID value for sensor data with Format B.

---

**备注:** 1. The Format field is 0b1 and indicates Format B is used.

- a. The Length field is a 1-based uint7 value (valid range 0x0–0x7F, representing range of 1–127). The value 0x7F represents a length of zero.
  - b. The Property ID is a 16-bit bit field representing a Property ID.
  - c. This format may be used for Property Values not longer than 128 octets and for any Property IDs. Property values longer than 128 octets are not supported by the Sensor Status message.
  - d. Exclude the generated 1-octet value, the 2-octet Sensor Property ID
- 

**参数**

- **\_len** -- Length of Sensor Raw value.
- **\_id** -- Sensor Property ID.

**返回** 3-octet MPID value for sensor data with Format B.

**Type Definitions**

```
typedef void (*esp_ble_mesh_sensor_client_cb_t)(esp_ble_mesh_sensor_client_cb_event_t event,  
esp_ble_mesh_sensor_client_cb_param_t *param)
```

Bluetooth Mesh Sensor Client Model function.

Sensor Client Model callback function type

**Param event** Event type

**Param param** Pointer to callback parameter

```
typedef void (*esp_ble_mesh_sensor_server_cb_t)(esp_ble_mesh_sensor_server_cb_event_t event,  
esp_ble_mesh_sensor_server_cb_param_t *param)
```

Bluetooth Mesh Sensor Server Model function.

Sensor Server Model callback function type

**Param event** Event type

**Param param** Pointer to callback parameter

### Enumerations

```
enum esp_ble_mesh_sensor_client_cb_event_t
```

This enum value is the event of Sensor Client Model

*Values:*

enumerator **ESP\_BLE\_MESH\_SENSOR\_CLIENT\_GET\_STATE\_EVT**

enumerator **ESP\_BLE\_MESH\_SENSOR\_CLIENT\_SET\_STATE\_EVT**

enumerator **ESP\_BLE\_MESH\_SENSOR\_CLIENT\_PUBLISH\_EVT**

enumerator **ESP\_BLE\_MESH\_SENSOR\_CLIENT\_TIMEOUT\_EVT**

enumerator **ESP\_BLE\_MESH\_SENSOR\_CLIENT\_EVT\_MAX**

```
enum esp_ble_mesh_sensor_sample_func
```

This enum value is value of Sensor Sampling Function

*Values:*

enumerator **ESP\_BLE\_MESH\_SAMPLE\_FUNC\_UNSPECIFIED**

enumerator **ESP\_BLE\_MESH\_SAMPLE\_FUNC\_INSTANTANEOUS**

enumerator **ESP\_BLE\_MESH\_SAMPLE\_FUNC\_ARITHMETIC\_MEAN**

enumerator **ESP\_BLE\_MESH\_SAMPLE\_FUNC\_RMS**

enumerator **ESP\_BLE\_MESH\_SAMPLE\_FUNC\_MAXIMUM**

enumerator **ESP\_BLE\_MESH\_SAMPLE\_FUNC\_MINIMUM**

enumerator **ESP\_BLE\_MESH\_SAMPLE\_FUNC\_ACCUMULATED**

enumerator **ESP\_BLE\_MESH\_SAMPLE\_FUNC\_COUNT**

```
enum esp_ble_mesh_sensor_server_cb_event_t
```

This enum value is the event of Sensor Server Model

*Values:*

enumerator **ESP\_BLE\_MESH\_SENSOR\_SERVER\_STATE\_CHANGE\_EVT**

- i. When `get_auto_rsp` is set to `ESP_BLE_MESH_SERVER_AUTO_RSP`, no event will be callback to the application layer when Sensor Get messages are received.
- ii. When `set_auto_rsp` is set to `ESP_BLE_MESH_SERVER_AUTO_RSP`, this event will be callback to the application layer when Sensor Set/Set Unack messages are received.

enumerator **ESP\_BLE\_MESH\_SENSOR\_SERVER\_RECV\_GET\_MSG\_EVT**

When `get_auto_rsp` is set to `ESP_BLE_MESH_SERVER_RSP_BY_APP`, this event will be callback to the application layer when Sensor Get messages are received.

enumerator **ESP\_BLE\_MESH\_SENSOR\_SERVER\_RECV\_SET\_MSG\_EVT**

When `set_auto_rsp` is set to `ESP_BLE_MESH_SERVER_RSP_BY_APP`, this event will be callback to the application layer when Sensor Set/Set Unack messages are received.

enumerator **ESP\_BLE\_MESH\_SENSOR\_SERVER\_EVT\_MAX**

## Time and Scenes Client/Server Models

### Header File

- [components/bt/esp\\_ble\\_mesh/api/models/include/esp\\_ble\\_mesh\\_time\\_scene\\_model\\_api.h](#)
- This header file can be included with:

```
#include "esp_ble_mesh_time_scene_model_api.h"
```

- This header file is a part of the API provided by the `bt` component. To declare that your component depends on `bt`, add the following to your `CMakeLists.txt`:

```
REQUIRES bt
```

or

```
PRIV_REQUIRES bt
```

### Functions

*esp\_err\_t* **esp\_ble\_mesh\_register\_time\_scene\_client\_callback** (*esp\_ble\_mesh\_time\_scene\_client\_cb\_t* callback)

Register BLE Mesh Time Scene Client Model callback.

**参数** `callback` -- **[in]** Pointer to the callback function.

**返回** `ESP_OK` on success or error code otherwise.

*esp\_err\_t* **esp\_ble\_mesh\_time\_scene\_client\_get\_state** (*esp\_ble\_mesh\_client\_common\_param\_t* \*params, *esp\_ble\_mesh\_time\_scene\_client\_get\_state\_t* \*get\_state)

Get the value of Time Scene Server Model states using the Time Scene Client Model get messages.

---

**备注:** If you want to know the opcodes and corresponding meanings accepted by this API, please refer to `esp_ble_mesh_time_scene_message_opcode_t` in `esp_ble_mesh_defs.h`

---

#### 参数

- **params** -- **[in]** Pointer to BLE Mesh common client parameters.
- **get\_state** -- **[in]** Pointer to time scene get message value. Shall not be set to NULL.

返回 ESP\_OK on success or error code otherwise.

```
esp_err_t esp_ble_mesh_time_scene_client_set_state(esp_ble_mesh_client_common_param_t
                                                    *params,
                                                    esp_ble_mesh_time_scene_client_set_state_t
                                                    *set_state)
```

Set the value of Time Scene Server Model states using the Time Scene Client Model set messages.

---

**备注:** If you want to know the opcodes and corresponding meanings accepted by this API, please refer to `esp_ble_mesh_time_scene_message_opcode_t` in `esp_ble_mesh_defs.h`

---

#### 参数

- **params** -- [in] Pointer to BLE Mesh common client parameters.
- **set\_state** -- [in] Pointer to time scene set message value. Shall not be set to NULL.

返回 ESP\_OK on success or error code otherwise.

```
esp_err_t esp_ble_mesh_register_time_scene_server_callback(esp_ble_mesh_time_scene_server_cb_t
                                                           callback)
```

Register BLE Mesh Time and Scenes Server Model callback.

参数 **callback** -- [in] Pointer to the callback function.

返回 ESP\_OK on success or error code otherwise.

## Unions

```
union esp_ble_mesh_time_scene_client_get_state_t
#include <esp_ble_mesh_time_scene_model_api.h> Time Scene Client Model get message union.
```

### Public Members

```
esp_ble_mesh_scheduler_act_get_t scheduler_act_get
For ESP_BLE_MESH_MODEL_OP_SCHEDULER_ACT_GET
```

```
union esp_ble_mesh_time_scene_client_set_state_t
#include <esp_ble_mesh_time_scene_model_api.h> Time Scene Client Model set message union.
```

### Public Members

```
esp_ble_mesh_time_set_t time_set
For ESP_BLE_MESH_MODEL_OP_TIME_SET
```

```
esp_ble_mesh_time_zone_set_t time_zone_set
For ESP_BLE_MESH_MODEL_OP_TIME_ZONE_SET
```

```
esp_ble_mesh_tai_utc_delta_set_t tai_utc_delta_set
For ESP_BLE_MESH_MODEL_OP_TAI_UTC_DELTA_SET
```

```
esp_ble_mesh_time_role_set_t time_role_set
For ESP_BLE_MESH_MODEL_OP_TIME_ROLE_SET
```

*esp\_ble\_mesh\_scene\_store\_t* **scene\_store**

For ESP\_BLE\_MESH\_MODEL\_OP\_SCENE\_STORE & ESP\_BLE\_MESH\_MODEL\_OP\_SCENE\_STORE\_UNACK

*esp\_ble\_mesh\_scene\_recall\_t* **scene\_recall**

For ESP\_BLE\_MESH\_MODEL\_OP\_SCENE\_RECALL & ESP\_BLE\_MESH\_MODEL\_OP\_SCENE\_RECALL\_UNACK

*esp\_ble\_mesh\_scene\_delete\_t* **scene\_delete**

For ESP\_BLE\_MESH\_MODEL\_OP\_SCENE\_DELETE & ESP\_BLE\_MESH\_MODEL\_OP\_SCENE\_DELETE\_UNACK

*esp\_ble\_mesh\_scheduler\_act\_set\_t* **scheduler\_act\_set**

For ESP\_BLE\_MESH\_MODEL\_OP\_SCHEDULER\_ACT\_SET &  
ESP\_BLE\_MESH\_MODEL\_OP\_SCHEDULER\_ACT\_SET\_UNACK

union **esp\_ble\_mesh\_time\_scene\_client\_status\_cb\_t**

#include <esp\_ble\_mesh\_time\_scene\_model\_api.h> Time Scene Client Model received message union.

### Public Members

*esp\_ble\_mesh\_time\_status\_cb\_t* **time\_status**

For ESP\_BLE\_MESH\_MODEL\_OP\_TIME\_STATUS

*esp\_ble\_mesh\_time\_zone\_status\_cb\_t* **time\_zone\_status**

For ESP\_BLE\_MESH\_MODEL\_OP\_TIME\_ZONE\_STATUS

*esp\_ble\_mesh\_tai\_utc\_delta\_status\_cb\_t* **tai\_utc\_delta\_status**

For ESP\_BLE\_MESH\_MODEL\_OP\_TAI\_UTC\_DELTA\_STATUS

*esp\_ble\_mesh\_time\_role\_status\_cb\_t* **time\_role\_status**

For ESP\_BLE\_MESH\_MODEL\_OP\_TIME\_ROLE\_STATUS

*esp\_ble\_mesh\_scene\_status\_cb\_t* **scene\_status**

For ESP\_BLE\_MESH\_MODEL\_OP\_SCENE\_STATUS

*esp\_ble\_mesh\_scene\_register\_status\_cb\_t* **scene\_register\_status**

For ESP\_BLE\_MESH\_MODEL\_OP\_SCENE\_REGISTER\_STATUS

*esp\_ble\_mesh\_scheduler\_status\_cb\_t* **scheduler\_status**

For ESP\_BLE\_MESH\_MODEL\_OP\_SCHEDULER\_STATUS

*esp\_ble\_mesh\_scheduler\_act\_status\_cb\_t* **scheduler\_act\_status**

For ESP\_BLE\_MESH\_MODEL\_OP\_SCHEDULER\_ACT\_STATUS

union **esp\_ble\_mesh\_time\_scene\_server\_state\_change\_t**

#include <esp\_ble\_mesh\_time\_scene\_model\_api.h> Time Scene Server Model state change value union.

### Public Members

*esp\_ble\_mesh\_state\_change\_time\_set\_t* **time\_set**

The `recv_op` in `ctx` can be used to decide which state is changed. Time Set

*esp\_ble\_mesh\_state\_change\_time\_status\_t* **time\_status**

Time Status

*esp\_ble\_mesh\_state\_change\_time\_zone\_set\_t* **time\_zone\_set**

Time Zone Set

*esp\_ble\_mesh\_state\_change\_tai\_utc\_delta\_set\_t* **tai\_utc\_delta\_set**

TAI UTC Delta Set

*esp\_ble\_mesh\_state\_change\_time\_role\_set\_t* **time\_role\_set**

Time Role Set

*esp\_ble\_mesh\_state\_change\_scene\_store\_t* **scene\_store**

Scene Store

*esp\_ble\_mesh\_state\_change\_scene\_recall\_t* **scene\_recall**

Scene Recall

*esp\_ble\_mesh\_state\_change\_scene\_delete\_t* **scene\_delete**

Scene Delete

*esp\_ble\_mesh\_state\_change\_scheduler\_act\_set\_t* **scheduler\_act\_set**

Scheduler Action Set

union **esp\_ble\_mesh\_time\_scene\_server\_recv\_get\_msg\_t**

`#include <esp_ble_mesh_time_scene_model_api.h>` Time Scene Server Model received get message union.

### Public Members

*esp\_ble\_mesh\_server\_recv\_scheduler\_act\_get\_t* **scheduler\_act**

Scheduler Action Get

union **esp\_ble\_mesh\_time\_scene\_server\_recv\_set\_msg\_t**

`#include <esp_ble_mesh_time_scene_model_api.h>` Time Scene Server Model received set message union.

### Public Members

*esp\_ble\_mesh\_server\_recv\_time\_set\_t* **time**

Time Set

*esp\_ble\_mesh\_server\_recv\_time\_zone\_set\_t* **time\_zone**

Time Zone Set

*esp\_ble\_mesh\_server\_rcv\_tai\_utc\_delta\_set\_t* **tai\_utc\_delta**  
TAI-UTC Delta Set

*esp\_ble\_mesh\_server\_rcv\_time\_role\_set\_t* **time\_role**  
Time Role Set

*esp\_ble\_mesh\_server\_rcv\_scene\_store\_t* **scene\_store**  
Scene Store/Scene Store Unack

*esp\_ble\_mesh\_server\_rcv\_scene\_recall\_t* **scene\_recall**  
Scene Recall/Scene Recall Unack

*esp\_ble\_mesh\_server\_rcv\_scene\_delete\_t* **scene\_delete**  
Scene Delete/Scene Delete Unack

*esp\_ble\_mesh\_server\_rcv\_scheduler\_act\_set\_t* **scheduler\_act**  
Scheduler Action Set/Scheduler Action Set Unack

union **esp\_ble\_mesh\_time\_scene\_server\_rcv\_status\_msg\_t**  
*#include <esp\_ble\_mesh\_time\_scene\_model\_api.h>* Time Scene Server Model received status message union.

### Public Members

*esp\_ble\_mesh\_server\_rcv\_time\_status\_t* **time\_status**  
Time Status

union **esp\_ble\_mesh\_time\_scene\_server\_cb\_value\_t**  
*#include <esp\_ble\_mesh\_time\_scene\_model\_api.h>* Time Scene Server Model callback value union.

### Public Members

*esp\_ble\_mesh\_time\_scene\_server\_state\_change\_t* **state\_change**  
ESP\_BLE\_MESH\_TIME\_SCENE\_SERVER\_STATE\_CHANGE\_EVT

*esp\_ble\_mesh\_time\_scene\_server\_rcv\_get\_msg\_t* **get**  
ESP\_BLE\_MESH\_TIME\_SCENE\_SERVER\_RECV\_GET\_MSG\_EVT

*esp\_ble\_mesh\_time\_scene\_server\_rcv\_set\_msg\_t* **set**  
ESP\_BLE\_MESH\_TIME\_SCENE\_SERVER\_RECV\_SET\_MSG\_EVT

*esp\_ble\_mesh\_time\_scene\_server\_rcv\_status\_msg\_t* **status**  
ESP\_BLE\_MESH\_TIME\_SCENE\_SERVER\_RECV\_STATUS\_MSG\_EVT

### Structures

struct **esp\_ble\_mesh\_time\_set\_t**  
Bluetooth Mesh Time Scene Client Model Get and Set parameters structure.  
Parameters of Time Set

**Public Members****uint8\_t tai\_seconds[5]**

The current TAI time in seconds

**uint8\_t sub\_second**

The sub-second time in units of 1/256 second

**uint8\_t uncertainty**

The estimated uncertainty in 10-millisecond steps

**uint16\_t time\_authority**

0 = No Time Authority, 1 = Time Authority

**uint16\_t tai\_utc\_delta**

Current difference between TAI and UTC in seconds

**uint8\_t time\_zone\_offset**

The local time zone offset in 15-minute increments

struct **esp\_ble\_mesh\_time\_zone\_set\_t**

Parameters of Time Zone Set

**Public Members****uint8\_t time\_zone\_offset\_new**

Upcoming local time zone offset

**uint8\_t tai\_zone\_change[5]**

TAI Seconds time of the upcoming Time Zone Offset change

struct **esp\_ble\_mesh\_tai\_utc\_delta\_set\_t**

Parameters of TAI-UTC Delta Set

**Public Members****uint16\_t tai\_utc\_delta\_new**

Upcoming difference between TAI and UTC in seconds

**uint16\_t padding**

Always 0b0. Other values are Prohibited.

**uint8\_t tai\_delta\_change[5]**

TAI Seconds time of the upcoming TAI-UTC Delta change

struct **esp\_ble\_mesh\_time\_role\_set\_t**

Parameter of Time Role Set



**Public Members****uint8\_t time\_role**

The Time Role for the element

struct **esp\_ble\_mesh\_scene\_store\_t**

Parameter of Scene Store

**Public Members****uint16\_t scene\_number**

The number of scenes to be stored

struct **esp\_ble\_mesh\_scene\_recall\_t**

Parameters of Scene Recall

**Public Members****bool op\_en**

Indicate if optional parameters are included

**uint16\_t scene\_number**

The number of scenes to be recalled

**uint8\_t tid**

Transaction ID

**uint8\_t trans\_time**

Time to complete state transition (optional)

**uint8\_t delay**

Indicate message execution delay (C.1)

struct **esp\_ble\_mesh\_scene\_delete\_t**

Parameter of Scene Delete

**Public Members****uint16\_t scene\_number**

The number of scenes to be deleted

struct **esp\_ble\_mesh\_scheduler\_act\_get\_t**

Parameter of Scheduler Action Get

**Public Members****uint8\_t index**

Index of the Schedule Register entry to get

struct **esp\_ble\_mesh\_scheduler\_act\_set\_t**

Parameters of Scheduler Action Set

**Public Members****uint64\_t index**

Index of the Schedule Register entry to set

**uint64\_t year**

Scheduled year for the action

**uint64\_t month**

Scheduled month for the action

**uint64\_t day**

Scheduled day of the month for the action

**uint64\_t hour**

Scheduled hour for the action

**uint64\_t minute**

Scheduled minute for the action

**uint64\_t second**

Scheduled second for the action

**uint64\_t day\_of\_week**

Schedule days of the week for the action

**uint64\_t action**

Action to be performed at the scheduled time

**uint64\_t trans\_time**

Transition time for this action

**uint16\_t scene\_number**

Transition time for this action

struct **esp\_ble\_mesh\_time\_status\_cb\_t**

Bluetooth Mesh Time Scene Client Model Get and Set callback parameters structure.

Parameters of Time Status

**Public Members****uint8\_t tai\_seconds[5]**

The current TAI time in seconds

**uint8\_t sub\_second**

The sub-second time in units of 1/256 second

**uint8\_t uncertainty**

The estimated uncertainty in 10-millisecond steps

**uint16\_t time\_authority**

0 = No Time Authority, 1 = Time Authority

**uint16\_t tai\_utc\_delta**

Current difference between TAI and UTC in seconds

**uint8\_t time\_zone\_offset**

The local time zone offset in 15-minute increments

struct **esp\_ble\_mesh\_time\_zone\_status\_cb\_t**

Parameters of Time Zone Status

**Public Members****uint8\_t time\_zone\_offset\_curr**

Current local time zone offset

**uint8\_t time\_zone\_offset\_new**

Upcoming local time zone offset

**uint8\_t tai\_zone\_change[5]**

TAI Seconds time of the upcoming Time Zone Offset change

struct **esp\_ble\_mesh\_tai\_utc\_delta\_status\_cb\_t**

Parameters of TAI-UTC Delta Status

**Public Members****uint16\_t tai\_utc\_delta\_curr**

Current difference between TAI and UTC in seconds

**uint16\_t padding\_1**

Always 0b0. Other values are Prohibited.

**uint16\_t tai\_utc\_delta\_new**

Upcoming difference between TAI and UTC in seconds

uint16\_t **padding\_2**

Always 0b0. Other values are Prohibited.

uint8\_t **tai\_delta\_change**[5]

TAI Seconds time of the upcoming TAI-UTC Delta change

struct **esp\_ble\_mesh\_time\_role\_status\_cb\_t**

Parameter of Time Role Status

### Public Members

uint8\_t **time\_role**

The Time Role for the element

struct **esp\_ble\_mesh\_scene\_status\_cb\_t**

Parameters of Scene Status

### Public Members

bool **op\_en**

Indicate if optional parameters are included

uint8\_t **status\_code**

Status code of the last operation

uint16\_t **current\_scene**

Scene Number of the current scene

uint16\_t **target\_scene**

Scene Number of the target scene (optional)

uint8\_t **remain\_time**

Time to complete state transition (C.1)

struct **esp\_ble\_mesh\_scene\_register\_status\_cb\_t**

Parameters of Scene Register Status

### Public Members

uint8\_t **status\_code**

Status code for the previous operation

uint16\_t **current\_scene**

Scene Number of the current scene

struct net\_buf\_simple \***scenes**

A list of scenes stored within an element

struct **esp\_ble\_mesh\_scheduler\_status\_cb\_t**

Parameter of Scheduler Status

### Public Members

uint16\_t **schedules**

Bit field indicating defined Actions in the Schedule Register

struct **esp\_ble\_mesh\_scheduler\_act\_status\_cb\_t**

Parameters of Scheduler Action Status

### Public Members

uint64\_t **index**

Enumerates (selects) a Schedule Register entry

uint64\_t **year**

Scheduled year for the action

uint64\_t **month**

Scheduled month for the action

uint64\_t **day**

Scheduled day of the month for the action

uint64\_t **hour**

Scheduled hour for the action

uint64\_t **minute**

Scheduled minute for the action

uint64\_t **second**

Scheduled second for the action

uint64\_t **day\_of\_week**

Schedule days of the week for the action

uint64\_t **action**

Action to be performed at the scheduled time

uint64\_t **trans\_time**

Transition time for this action

uint16\_t **scene\_number**

Transition time for this action

struct **esp\_ble\_mesh\_time\_scene\_client\_cb\_param\_t**

Time Scene Client Model callback parameters

### Public Members

int **error\_code**

Appropriate error code

*esp\_ble\_mesh\_client\_common\_param\_t* \***params**

The client common parameters.

*esp\_ble\_mesh\_time\_scene\_client\_status\_cb\_t* **status\_cb**

The scene status message callback values

struct **esp\_ble\_mesh\_time\_state\_t**

Parameters of Time state

### Public Members

uint8\_t **tai\_seconds**[5]

The value of the TAI Seconds state

uint8\_t **subsecond**

The value of the Subsecond field

uint8\_t **uncertainty**

The value of the Uncertainty field

uint8\_t **time\_zone\_offset\_curr**

The value of the Time Zone Offset Current field

uint8\_t **time\_zone\_offset\_new**

The value of the Time Zone Offset New state

uint8\_t **tai\_zone\_change**[5]

The value of the TAI of Zone Change field

uint16\_t **time\_authority**

The value of the Time Authority bit

uint16\_t **tai\_utc\_delta\_curr**

The value of the TAI-UTC Delta Current state

uint16\_t **tai\_utc\_delta\_new**

The value of the TAI-UTC Delta New state

uint8\_t **tai\_delta\_change**[5]

The value of the TAI of Delta Change field

struct *esp\_ble\_mesh\_time\_state\_t*::[anonymous] **time**

Parameters of the Time state

uint8\_t **time\_role**

The value of the Time Role state

struct **esp\_ble\_mesh\_time\_srv\_t**

User data of Time Server Model

### Public Members

*esp\_ble\_mesh\_model\_t* \***model**

Pointer to the Time Server Model. Initialized internally.

*esp\_ble\_mesh\_server\_rsp\_ctrl\_t* **rsp\_ctrl**

Response control of the server model received messages

*esp\_ble\_mesh\_time\_state\_t* \***state**

Parameters of the Time state

struct **esp\_ble\_mesh\_time\_setup\_srv\_t**

User data of Time Setup Server Model

### Public Members

*esp\_ble\_mesh\_model\_t* \***model**

Pointer to the Time Setup Server Model. Initialized internally.

*esp\_ble\_mesh\_server\_rsp\_ctrl\_t* **rsp\_ctrl**

Response control of the server model received messages

*esp\_ble\_mesh\_time\_state\_t* \***state**

Parameters of the Time state

struct **esp\_ble\_mesh\_scene\_register\_t**

- a. Scene Store is an operation of storing values of a present state of an element.
- b. The structure and meaning of the stored state is determined by a model. States to be stored are specified by each model.
- c. The Scene Store operation shall persistently store all values of all states marked as Stored with Scene for all models present on all elements of a node.
- d. If a model is extending another model, the extending model shall determine the Stored with Scene behavior of that model. Parameters of Scene Register state

### Public Members

uint16\_t **scene\_number**

The value of the Scene Number

uint8\_t **scene\_type**

The value of the Scene Type

struct net\_buf\_simple \***scene\_value**

Scene value may use a union to represent later, the union contains structures of all the model states which can be stored in a scene. The value of the Scene Value

struct **esp\_ble\_mesh\_scenes\_state\_t**

Parameters of Scenes state.

Scenes serve as memory banks for storage of states (e.g., a power level or a light level/color). Values of states of an element can be stored as a scene and can be recalled later from the scene memory.

A scene is represented by a Scene Number, which is a 16-bit non-zero, mesh-wide value. (There can be a maximum of 65535 scenes in a mesh network.) The meaning of a scene, as well as the state storage container associated with it, are determined by a model.

The Scenes state change may start numerous parallel model transitions. In that case, each individual model handles the transition internally.

The scene transition is defined as a group of individual model transitions started by a Scene Recall operation. The scene transition is in progress when at least one transition from the group of individual model transitions is in progress.

### Public Members

const uint16\_t **scene\_count**

The Scenes state's scene count

*esp\_ble\_mesh\_scene\_register\_t* \***scenes**

Parameters of the Scenes state

uint16\_t **current\_scene**

The Current Scene state is a 16-bit value that contains either the Scene Number of the currently active scene or a value of 0x0000 when no scene is active.

When a Scene Store operation or a Scene Recall operation completes with success, the Current Scene state value shall be to the Scene Number used during that operation.

When the Current Scene Number is deleted from a Scene Register state as a result of Scene Delete operation, the Current Scene state shall be set to 0x0000.

When any of the element's state that is marked as "Stored with Scene" has changed not as a result of a Scene Recall operation, the value of the Current Scene state shall be set to 0x0000.

When a scene transition is in progress, the value of the Current Scene state shall be set to 0x0000. The value of the Current Scene state

uint16\_t **target\_scene**

The Target Scene state is a 16-bit value that contains the target Scene Number when a scene transition is in progress.



When the scene transition is in progress and the target Scene Number is deleted from a Scene Register state as a result of Scene Delete operation, the Target Scene state shall be set to 0x0000.

When the scene transition is in progress and a new Scene Number is stored in the Scene Register as a result of Scene Store operation, the Target Scene state shall be set to the new Scene Number.

When the scene transition is not in progress, the value of the Target Scene state shall be set to 0x0000. The value of the Target Scene state

`uint8_t status_code`

The status code of the last scene operation

`bool in_progress`

Indicate if the scene transition is in progress

struct `esp_ble_mesh_scene_srv_t`

User data of Scene Server Model

### Public Members

`esp_ble_mesh_model_t *model`

Pointer to the Scene Server Model. Initialized internally.

`esp_ble_mesh_server_rsp_ctrl_t rsp_ctrl`

Response control of the server model received messages

`esp_ble_mesh_scenes_state_t *state`

Parameters of the Scenes state

`esp_ble_mesh_last_msg_info_t last`

Parameters of the last received set message

`esp_ble_mesh_state_transition_t transition`

Parameters of state transition

struct `esp_ble_mesh_scene_setup_srv_t`

User data of Scene Setup Server Model

### Public Members

`esp_ble_mesh_model_t *model`

Pointer to the Scene Setup Server Model. Initialized internally.

`esp_ble_mesh_server_rsp_ctrl_t rsp_ctrl`

Response control of the server model received messages

`esp_ble_mesh_scenes_state_t *state`

Parameters of the Scenes state

struct `esp_ble_mesh_schedule_register_t`

Parameters of Scheduler Register state

**Public Members****bool in\_use**

Indicate if the registered schedule is in use

**uint64\_t year**

The value of Scheduled year for the action

**uint64\_t month**

The value of Scheduled month for the action

**uint64\_t day**

The value of Scheduled day of the month for the action

**uint64\_t hour**

The value of Scheduled hour for the action

**uint64\_t minute**

The value of Scheduled minute for the action

**uint64\_t second**

The value of Scheduled second for the action

**uint64\_t day\_of\_week**

The value of Schedule days of the week for the action

**uint64\_t action**

The value of Action to be performed at the scheduled time

**uint64\_t trans\_time**

The value of Transition time for this action

**uint16\_t scene\_number**

The value of Scene Number to be used for some actions

**struct esp\_ble\_mesh\_scheduler\_state\_t**

Parameters of Scheduler state

**Public Members****const uint8\_t schedule\_count**

Scheduler count

***esp\_ble\_mesh\_schedule\_register\_t* \*schedules**

Up to 16 scheduled entries

**struct esp\_ble\_mesh\_scheduler\_srv\_t**

User data of Scheduler Server Model

**Public Members**

*esp\_ble\_mesh\_model\_t* \***model**

Pointer to the Scheduler Server Model. Initialized internally.

*esp\_ble\_mesh\_server\_rsp\_ctrl\_t* **rsp\_ctrl**

Response control of the server model received messages

*esp\_ble\_mesh\_scheduler\_state\_t* \***state**

Parameters of the Scheduler state

struct **esp\_ble\_mesh\_scheduler\_setup\_srv\_t**

User data of Scheduler Setup Server Model

**Public Members**

*esp\_ble\_mesh\_model\_t* \***model**

Pointer to the Scheduler Setup Server Model. Initialized internally.

*esp\_ble\_mesh\_server\_rsp\_ctrl\_t* **rsp\_ctrl**

Response control of the server model received messages

*esp\_ble\_mesh\_scheduler\_state\_t* \***state**

Parameters of the Scheduler state

struct **esp\_ble\_mesh\_state\_change\_time\_set\_t**

Parameters of Time Set state change event

**Public Members**

uint8\_t **tai\_seconds**[5]

The current TAI time in seconds

uint8\_t **subsecond**

The sub-second time in units of 1/256 second

uint8\_t **uncertainty**

The estimated uncertainty in 10-millisecond steps

uint16\_t **time\_authority**

0 = No Time Authority, 1 = Time Authority

uint16\_t **tai\_utc\_delta\_curr**

Current difference between TAI and UTC in seconds

uint8\_t **time\_zone\_offset\_curr**

The local time zone offset in 15-minute increments

struct **esp\_ble\_mesh\_state\_change\_time\_status\_t**  
Parameters of Time Status state change event

### Public Members

uint8\_t **tai\_seconds**[5]  
The current TAI time in seconds

uint8\_t **subsecond**  
The sub-second time in units of 1/256 second

uint8\_t **uncertainty**  
The estimated uncertainty in 10-millisecond steps

uint16\_t **time\_authority**  
0 = No Time Authority, 1 = Time Authority

uint16\_t **tai\_utc\_delta\_curr**  
Current difference between TAI and UTC in seconds

uint8\_t **time\_zone\_offset\_curr**  
The local time zone offset in 15-minute increments

struct **esp\_ble\_mesh\_state\_change\_time\_zone\_set\_t**  
Parameters of Time Zone Set state change event

### Public Members

uint8\_t **time\_zone\_offset\_new**  
Upcoming local time zone offset

uint8\_t **tai\_zone\_change**[5]  
TAI Seconds time of the upcoming Time Zone Offset change

struct **esp\_ble\_mesh\_state\_change\_tai\_utc\_delta\_set\_t**  
Parameters of TAI UTC Delta Set state change event

### Public Members

uint16\_t **tai\_utc\_delta\_new**  
Upcoming difference between TAI and UTC in seconds

uint8\_t **tai\_delta\_change**[5]  
TAI Seconds time of the upcoming TAI-UTC Delta change

struct **esp\_ble\_mesh\_state\_change\_time\_role\_set\_t**  
Parameter of Time Role Set state change event

**Public Members****uint8\_t time\_role**

The Time Role for the element

struct **esp\_ble\_mesh\_state\_change\_scene\_store\_t**

Parameter of Scene Store state change event

**Public Members****uint16\_t scene\_number**

The number of scenes to be stored

struct **esp\_ble\_mesh\_state\_change\_scene\_recall\_t**

Parameter of Scene Recall state change event

**Public Members****uint16\_t scene\_number**

The number of scenes to be recalled

struct **esp\_ble\_mesh\_state\_change\_scene\_delete\_t**

Parameter of Scene Delete state change event

**Public Members****uint16\_t scene\_number**

The number of scenes to be deleted

struct **esp\_ble\_mesh\_state\_change\_scheduler\_act\_set\_t**

Parameter of Scheduler Action Set state change event

**Public Members****uint64\_t index**

Index of the Schedule Register entry to set

**uint64\_t year**

Scheduled year for the action

**uint64\_t month**

Scheduled month for the action

**uint64\_t day**

Scheduled day of the month for the action

uint64\_t **hour**

Scheduled hour for the action

uint64\_t **minute**

Scheduled minute for the action

uint64\_t **second**

Scheduled second for the action

uint64\_t **day\_of\_week**

Schedule days of the week for the action

uint64\_t **action**

Action to be performed at the scheduled time

uint64\_t **trans\_time**

Transition time for this action

uint16\_t **scene\_number**

Scene number to be used for some actions

struct **esp\_ble\_mesh\_server\_rcv\_scheduler\_act\_get\_t**

Context of the received Scheduler Action Get message

### Public Members

uint8\_t **index**

Index of the Schedule Register entry to get

struct **esp\_ble\_mesh\_server\_rcv\_time\_set\_t**

Context of the received Time Set message

### Public Members

uint8\_t **tai\_seconds**[5]

The current TAI time in seconds

uint8\_t **subsecond**

The sub-second time in units of 1/256 second

uint8\_t **uncertainty**

The estimated uncertainty in 10-millisecond steps

uint16\_t **time\_authority**

0 = No Time Authority, 1 = Time Authority

uint16\_t **tai\_utc\_delta**

Current difference between TAI and UTC in seconds

uint8\_t **time\_zone\_offset**

The local time zone offset in 15-minute increments

struct **esp\_ble\_mesh\_server\_rcv\_time\_zone\_set\_t**

Context of the received Time Zone Set message

### Public Members

uint8\_t **time\_zone\_offset\_new**

Upcoming local time zone offset

uint8\_t **tai\_zone\_change**[5]

TAI Seconds time of the upcoming Time Zone Offset change

struct **esp\_ble\_mesh\_server\_rcv\_tai\_utc\_delta\_set\_t**

Context of the received TAI UTC Delta Set message

### Public Members

uint16\_t **tai\_utc\_delta\_new**

Upcoming difference between TAI and UTC in seconds

uint16\_t **padding**

Always 0b0. Other values are Prohibited.

uint8\_t **tai\_delta\_change**[5]

TAI Seconds time of the upcoming TAI-UTC Delta change

struct **esp\_ble\_mesh\_server\_rcv\_time\_role\_set\_t**

Context of the received Time Role Set message

### Public Members

uint8\_t **time\_role**

The Time Role for the element

struct **esp\_ble\_mesh\_server\_rcv\_scene\_store\_t**

Context of the received Scene Store message

### Public Members

uint16\_t **scene\_number**

The number of scenes to be stored

struct **esp\_ble\_mesh\_server\_rcv\_scene\_recall\_t**

Context of the received Scene Recall message

### Public Members

bool **op\_en**

Indicate if optional parameters are included

uint16\_t **scene\_number**

The number of scenes to be recalled

uint8\_t **tid**

Transaction ID

uint8\_t **trans\_time**

Time to complete state transition (optional)

uint8\_t **delay**

Indicate message execution delay (C.1)

struct **esp\_ble\_mesh\_server\_rcv\_scene\_delete\_t**

Context of the received Scene Delete message

### Public Members

uint16\_t **scene\_number**

The number of scenes to be deleted

struct **esp\_ble\_mesh\_server\_rcv\_scheduler\_act\_set\_t**

Context of the received Scheduler Action Set message

### Public Members

uint64\_t **index**

Index of the Schedule Register entry to set

uint64\_t **year**

Scheduled year for the action

uint64\_t **month**

Scheduled month for the action

uint64\_t **day**

Scheduled day of the month for the action



`uint64_t hour`

Scheduled hour for the action

`uint64_t minute`

Scheduled minute for the action

`uint64_t second`

Scheduled second for the action

`uint64_t day_of_week`

Schedule days of the week for the action

`uint64_t action`

Action to be performed at the scheduled time

`uint64_t trans_time`

Transition time for this action

`uint16_t scene_number`

Scene number to be used for some actions

struct `esp_ble_mesh_server_rcv_time_status_t`

Context of the received Time Status message

### Public Members

`uint8_t tai_seconds[5]`

The current TAI time in seconds

`uint8_t subsecond`

The sub-second time in units of 1/256 second

`uint8_t uncertainty`

The estimated uncertainty in 10-millisecond steps

`uint16_t time_authority`

0 = No Time Authority, 1 = Time Authority

`uint16_t tai_utc_delta`

Current difference between TAI and UTC in seconds

`uint8_t time_zone_offset`

The local time zone offset in 15-minute increments

struct `esp_ble_mesh_time_scene_server_cb_param_t`

Time Scene Server Model callback parameters

## Public Members

*esp\_ble\_mesh\_model\_t* \***model**

Pointer to Time and Scenes Server Models

*esp\_ble\_mesh\_msg\_ctx\_t* **ctx**

Context of the received messages

*esp\_ble\_mesh\_time\_scene\_server\_cb\_value\_t* **value**

Value of the received Time and Scenes Messages

## Macros

**ESP\_BLE\_MESH\_MODEL\_TIME\_CLI** (cli\_pub, cli\_data)

Define a new Time Client Model.

---

**备注:** This API needs to be called for each element on which the application needs to have a Time Client Model.

---

### 参数

- **cli\_pub** -- Pointer to the unique struct *esp\_ble\_mesh\_model\_pub\_t*.
- **cli\_data** -- Pointer to the unique struct *esp\_ble\_mesh\_client\_t*.

**返回** New Time Client Model instance.

**ESP\_BLE\_MESH\_MODEL\_SCENE\_CLI** (cli\_pub, cli\_data)

Define a new Scene Client Model.

---

**备注:** This API needs to be called for each element on which the application needs to have a Scene Client Model.

---

### 参数

- **cli\_pub** -- Pointer to the unique struct *esp\_ble\_mesh\_model\_pub\_t*.
- **cli\_data** -- Pointer to the unique struct *esp\_ble\_mesh\_client\_t*.

**返回** New Scene Client Model instance.

**ESP\_BLE\_MESH\_MODEL\_SCHEDULER\_CLI** (cli\_pub, cli\_data)

Define a new Scheduler Client Model.

---

**备注:** This API needs to be called for each element on which the application needs to have a Scheduler Client Model.

---

### 参数

- **cli\_pub** -- Pointer to the unique struct *esp\_ble\_mesh\_model\_pub\_t*.
- **cli\_data** -- Pointer to the unique struct *esp\_ble\_mesh\_client\_t*.

**返回** New Scheduler Client Model instance.

**ESP\_BLE\_MESH\_MODEL\_TIME\_SRV** (srv\_pub, srv\_data)

Time Scene Server Models related context.

Define a new Time Server Model.

---

**备注:** 1. The Time Server model is a root model. When this model is present on an Element, the corresponding Time Setup Server model shall also be present.

- a. This model shall support model publication and model subscription.
- 

**参数**

- **srv\_pub** -- Pointer to the unique struct *esp\_ble\_mesh\_model\_pub\_t*.
- **srv\_data** -- Pointer to the unique struct *esp\_ble\_mesh\_time\_srv\_t*.

**返回** New Time Server Model instance.

**ESP\_BLE\_MESH\_MODEL\_TIME\_SETUP\_SRV** (srv\_data)

Define a new Time Setup Server Model.

---

**备注:** 1. The Time Setup Server model extends the Time Server model. Time is sensitive information that is propagated across a mesh network.

- a. Only an authorized Time Client should be allowed to change the Time and Time Role states. A dedicated application key Bluetooth SIG Proprietary should be used on the Time Setup Server to restrict access to the server to only authorized Time Clients.
  - b. This model does not support subscribing nor publishing.
- 

**参数**

- **srv\_data** -- Pointer to the unique struct *esp\_ble\_mesh\_time\_setup\_srv\_t*.

**返回** New Time Setup Server Model instance.

**ESP\_BLE\_MESH\_MODEL\_SCENE\_SRV** (srv\_pub, srv\_data)

Define a new Scene Server Model.

---

**备注:** 1. The Scene Server model is a root model. When this model is present on an Element, the corresponding Scene Setup Server model shall also be present.

- a. This model shall support model publication and model subscription.
  - b. The model may be present only on the Primary element of a node.
- 

**参数**

- **srv\_pub** -- Pointer to the unique struct *esp\_ble\_mesh\_model\_pub\_t*.
- **srv\_data** -- Pointer to the unique struct *esp\_ble\_mesh\_scene\_srv\_t*.

**返回** New Scene Server Model instance.

**ESP\_BLE\_MESH\_MODEL\_SCENE\_SETUP\_SRV** (srv\_pub, srv\_data)

Define a new Scene Setup Server Model.

---

**备注:** 1. The Scene Setup Server model extends the Scene Server model and the Generic Default Transition Time Server model.

- a. This model shall support model subscription.
  - b. The model may be present only on the Primary element of a node.
- 

**参数**

- **srv\_pub** -- Pointer to the unique struct *esp\_ble\_mesh\_model\_pub\_t*.
- **srv\_data** -- Pointer to the unique struct *esp\_ble\_mesh\_scene\_setup\_srv\_t*.

**返回** New Scene Setup Server Model instance.

**ESP\_BLE\_MESH\_MODEL\_SCHEDULER\_SRV** (srv\_pub, srv\_data)

Define a new Scheduler Server Model.

---

**备注:** 1. The Scheduler Server model extends the Scene Server model. When this model is present on an Element, the corresponding Scheduler Setup Server model shall also be present.

- a. This model shall support model publication and model subscription.
  - b. The model may be present only on the Primary element of a node.
  - c. The model requires the Time Server model shall be present on the element.
- 

**参数**

- **srv\_pub** -- Pointer to the unique struct *esp\_ble\_mesh\_model\_pub\_t*.
- **srv\_data** -- Pointer to the unique struct *esp\_ble\_mesh\_scheduler\_srv\_t*.

**返回** New Scheduler Server Model instance.

**ESP\_BLE\_MESH\_MODEL\_SCHEDULER\_SETUP\_SRV** (srv\_pub, srv\_data)

Define a new Scheduler Setup Server Model.

---

**备注:** 1. The Scheduler Setup Server model extends the Scheduler Server and the Scene Setup Server models.

- a. This model shall support model subscription.
  - b. The model may be present only on the Primary element of a node.
- 

**参数**

- **srv\_pub** -- Pointer to the unique struct *esp\_ble\_mesh\_model\_pub\_t*.
- **srv\_data** -- Pointer to the unique struct *esp\_ble\_mesh\_scheduler\_setup\_srv\_t*.

**返回** New Scheduler Setup Server Model instance.

**ESP\_BLE\_MESH\_UNKNOWN\_TAI\_SECONDS**

Unknown TAI Seconds

**ESP\_BLE\_MESH\_UNKNOWN\_TAI\_ZONE\_CHANGE**

Unknown TAI of Zone Change

**ESP\_BLE\_MESH\_UNKNOWN\_TAI\_DELTA\_CHANGE**

Unknown TAI of Delta Change

**ESP\_BLE\_MESH\_TAI\_UTC\_DELTA\_MAX\_VALUE**

Maximum TAI-UTC Delta value

**ESP\_BLE\_MESH\_TAI\_SECONDS\_LEN**

Length of TAI Seconds

**ESP\_BLE\_MESH\_TAI\_OF\_ZONE\_CHANGE\_LEN**

Length of TAI of Zone Change

**ESP\_BLE\_MESH\_TAI\_OF\_DELTA\_CHANGE\_LEN**

Length of TAI of Delta Change

**ESP\_BLE\_MESH\_INVALID\_SCENE\_NUMBER**

Invalid Scene Number

**ESP\_BLE\_MESH\_SCENE\_NUMBER\_LEN**

Length of the Scene Number

**ESP\_BLE\_MESH\_SCHEDULE\_YEAR\_ANY\_YEAR**

Any year of the Scheduled year

**ESP\_BLE\_MESH\_SCHEDULE\_DAY\_ANY\_DAY**

Any day of the Scheduled day

**ESP\_BLE\_MESH\_SCHEDULE\_HOUR\_ANY\_HOUR**

Any hour of the Scheduled hour

**ESP\_BLE\_MESH\_SCHEDULE\_HOUR\_ONCE\_A\_DAY**

Any hour of the Scheduled Day

**ESP\_BLE\_MESH\_SCHEDULE\_SEC\_ANY\_OF\_HOUR**

Any minute of the Scheduled hour

**ESP\_BLE\_MESH\_SCHEDULE\_SEC\_EVERY\_15\_MIN**

Every 15 minutes of the Scheduled hour

**ESP\_BLE\_MESH\_SCHEDULE\_SEC\_EVERY\_20\_MIN**

Every 20 minutes of the Scheduled hour

**ESP\_BLE\_MESH\_SCHEDULE\_SEC\_ONCE\_AN\_HOUR**

Once of the Scheduled hour

**ESP\_BLE\_MESH\_SCHEDULE\_SEC\_ANY\_OF\_MIN**

Any second of the Scheduled minute

**ESP\_BLE\_MESH\_SCHEDULE\_SEC\_EVERY\_15\_SEC**

Every 15 seconds of the Scheduled minute

**ESP\_BLE\_MESH\_SCHEDULE\_SEC\_EVERY\_20\_SEC**

Every 20 seconds of the Scheduled minute

**ESP\_BLE\_MESH\_SCHEDULE\_SEC\_ONCE\_AN\_MIN**

Once of the Scheduled minute

**ESP\_BLE\_MESH\_SCHEDULE\_ACT\_TURN\_OFF**

Scheduled Action - Turn Off

**ESP\_BLE\_MESH\_SCHEDULE\_ACT\_TURN\_ON**

Scheduled Action - Turn On

**ESP\_BLE\_MESH\_SCHEDULE\_ACT\_SCENE\_RECALL**

Scheduled Action - Scene Recall

**ESP\_BLE\_MESH\_SCHEDULE\_ACT\_NO\_ACTION**

Scheduled Action - No Action

**ESP\_BLE\_MESH\_SCHEDULE\_SCENE\_NO\_SCENE**

Scheduled Scene - No Scene

**ESP\_BLE\_MESH\_SCHEDULE\_ENTRY\_MAX\_INDEX**

Maximum number of Scheduled entries

**ESP\_BLE\_MESH\_TIME\_NONE**

Time Role - None

**ESP\_BLE\_MESH\_TIME\_AUTHORITY**

Time Role - Mesh Time Authority

**ESP\_BLE\_MESH\_TIME\_RELAY**

Time Role - Mesh Time Relay

**ESP\_BLE\_MESH\_TIME\_CLIENT**

Time Role - Mesh Time Client

**ESP\_BLE\_MESH\_SCENE\_SUCCESS**

Scene operation - Success

**ESP\_BLE\_MESH\_SCENE\_REG\_FULL**

Scene operation - Scene Register Full

**ESP\_BLE\_MESH\_SCENE\_NOT\_FOUND**

Scene operation - Scene Not Found

**Type Definitions**

```
typedef void (*esp_ble_mesh_time_scene_client_cb_t)(esp_ble_mesh_time_scene_client_cb_event_t  
event, esp_ble_mesh_time_scene_client_cb_param_t *param)
```

Bluetooth Mesh Time Scene Client Model function.

Time Scene Client Model callback function type

**Param event** Event type**Param param** Pointer to callback parameter

```
typedef void (*esp_ble_mesh_time_scene_server_cb_t)(esp_ble_mesh_time_scene_server_cb_event_t  
event, esp_ble_mesh_time_scene_server_cb_param_t *param)
```

Bluetooth Mesh Time and Scenes Server Model function.

Time Scene Server Model callback function type

**Param event** Event type**Param param** Pointer to callback parameter**Enumerations**

enum **esp\_ble\_mesh\_time\_scene\_client\_cb\_event\_t**

This enum value is the event of Time Scene Client Model

*Values:*

enumerator **ESP\_BLE\_MESH\_TIME\_SCENE\_CLIENT\_GET\_STATE\_EVT**

enumerator **ESP\_BLE\_MESH\_TIME\_SCENE\_CLIENT\_SET\_STATE\_EVT**

enumerator **ESP\_BLE\_MESH\_TIME\_SCENE\_CLIENT\_PUBLISH\_EVT**

enumerator **ESP\_BLE\_MESH\_TIME\_SCENE\_CLIENT\_TIMEOUT\_EVT**

enumerator **ESP\_BLE\_MESH\_TIME\_SCENE\_CLIENT\_EVT\_MAX**

enum **esp\_ble\_mesh\_time\_scene\_server\_cb\_event\_t**

This enum value is the event of Time Scene Server Model

*Values:*

enumerator **ESP\_BLE\_MESH\_TIME\_SCENE\_SERVER\_STATE\_CHANGE\_EVT**

- i. When `get_auto_rsp` is set to `ESP_BLE_MESH_SERVER_AUTO_RSP`, no event will be callback to the application layer when Time Scene Get messages are received.
- ii. When `set_auto_rsp` is set to `ESP_BLE_MESH_SERVER_AUTO_RSP`, this event will be callback to the application layer when Time Scene Set/Set Unack messages are received.

enumerator **ESP\_BLE\_MESH\_TIME\_SCENE\_SERVER\_RECV\_GET\_MSG\_EVT**

When `get_auto_rsp` is set to `ESP_BLE_MESH_SERVER_RSP_BY_APP`, this event will be callback to the application layer when Time Scene Get messages are received.

enumerator **ESP\_BLE\_MESH\_TIME\_SCENE\_SERVER\_RECV\_SET\_MSG\_EVT**

When `set_auto_rsp` is set to `ESP_BLE_MESH_SERVER_RSP_BY_APP`, this event will be callback to the application layer when Time Scene Set/Set Unack messages are received.

enumerator **ESP\_BLE\_MESH\_TIME\_SCENE\_SERVER\_RECV\_STATUS\_MSG\_EVT**

When `status_auto_rsp` is set to `ESP_BLE_MESH_SERVER_RSP_BY_APP`, this event will be callback to the application layer when Time Status message is received.

enumerator **ESP\_BLE\_MESH\_TIME\_SCENE\_SERVER\_EVT\_MAX**

## Lighting Client/Server Models

### Header File

- `components/bt/esp_ble_mesh/api/models/include/esp_ble_mesh_lighting_model_api.h`
- This header file can be included with:

```
#include "esp_ble_mesh_lighting_model_api.h"
```

- This header file is a part of the API provided by the `bt` component. To declare that your component depends on `bt`, add the following to your `CMakeLists.txt`:

```
REQUIRES bt
```

or

```
PRIV_REQUIRES bt
```

## Functions

*esp\_err\_t* **esp\_ble\_mesh\_register\_light\_client\_callback** (*esp\_ble\_mesh\_light\_client\_cb\_t* callback)

Register BLE Mesh Light Client Model callback.

**参数** **callback** -- **[in]** pointer to the callback function.

**返回** ESP\_OK on success or error code otherwise.

*esp\_err\_t* **esp\_ble\_mesh\_light\_client\_get\_state** (*esp\_ble\_mesh\_client\_common\_param\_t* \*params, *esp\_ble\_mesh\_light\_client\_get\_state\_t* \*get\_state)

Get the value of Light Server Model states using the Light Client Model get messages.

---

**备注:** If you want to know the opcodes and corresponding meanings accepted by this API, please refer to `esp_ble_mesh_light_message_opcode_t` in `esp_ble_mesh_defs.h`

---

### 参数

- **params** -- **[in]** Pointer to BLE Mesh common client parameters.
- **get\_state** -- **[in]** Pointer of light get message value. Shall not be set to NULL.

**返回** ESP\_OK on success or error code otherwise.

*esp\_err\_t* **esp\_ble\_mesh\_light\_client\_set\_state** (*esp\_ble\_mesh\_client\_common\_param\_t* \*params, *esp\_ble\_mesh\_light\_client\_set\_state\_t* \*set\_state)

Set the value of Light Server Model states using the Light Client Model set messages.

---

**备注:** If you want to know the opcodes and corresponding meanings accepted by this API, please refer to `esp_ble_mesh_light_message_opcode_t` in `esp_ble_mesh_defs.h`

---

### 参数

- **params** -- **[in]** Pointer to BLE Mesh common client parameters.
- **set\_state** -- **[in]** Pointer of light set message value. Shall not be set to NULL.

**返回** ESP\_OK on success or error code otherwise.

*esp\_err\_t* **esp\_ble\_mesh\_register\_lighting\_server\_callback** (*esp\_ble\_mesh\_lighting\_server\_cb\_t* callback)

Register BLE Mesh Lighting Server Model callback.

**参数** **callback** -- **[in]** Pointer to the callback function.

**返回** ESP\_OK on success or error code otherwise.

## Unions

union **esp\_ble\_mesh\_light\_client\_get\_state\_t**

`#include <esp_ble_mesh_lighting_model_api.h>` Lighting Client Model get message union.

## Public Members



*esp\_ble\_mesh\_light\_lc\_property\_get\_t* **lc\_property\_get**

For ESP\_BLE\_MESH\_MODEL\_OP\_LIGHT\_LC\_PROPERTY\_GET

union **esp\_ble\_mesh\_light\_client\_set\_state\_t**

#include <esp\_ble\_mesh\_lighting\_model\_api.h> Lighting Client Model set message union.

## Public Members

*esp\_ble\_mesh\_light\_lightness\_set\_t* **lightness\_set**

For ESP\_BLE\_MESH\_MODEL\_OP\_LIGHT\_LIGHTNESS\_SET &  
ESP\_BLE\_MESH\_MODEL\_OP\_LIGHT\_LIGHTNESS\_SET\_UNACK

*esp\_ble\_mesh\_light\_lightness\_linear\_set\_t* **lightness\_linear\_set**

For ESP\_BLE\_MESH\_MODEL\_OP\_LIGHT\_LIGHTNESS\_LINEAR\_SET &  
ESP\_BLE\_MESH\_MODEL\_OP\_LIGHT\_LIGHTNESS\_LINEAR\_SET\_UNACK

*esp\_ble\_mesh\_light\_lightness\_default\_set\_t* **lightness\_default\_set**

For ESP\_BLE\_MESH\_MODEL\_OP\_LIGHT\_LIGHTNESS\_DEFAULT\_SET &  
ESP\_BLE\_MESH\_MODEL\_OP\_LIGHT\_LIGHTNESS\_DEFAULT\_SET\_UNACK

*esp\_ble\_mesh\_light\_lightness\_range\_set\_t* **lightness\_range\_set**

For ESP\_BLE\_MESH\_MODEL\_OP\_LIGHT\_LIGHTNESS\_RANGE\_SET &  
ESP\_BLE\_MESH\_MODEL\_OP\_LIGHT\_LIGHTNESS\_RANGE\_SET\_UNACK

*esp\_ble\_mesh\_light\_ctl\_set\_t* **ctl\_set**

For ESP\_BLE\_MESH\_MODEL\_OP\_LIGHT\_CTL\_SET & ESP\_BLE\_MESH\_MODEL\_OP\_LIGHT\_CTL\_SET\_UNACK

*esp\_ble\_mesh\_light\_ctl\_temperature\_set\_t* **ctl\_temperature\_set**

For ESP\_BLE\_MESH\_MODEL\_OP\_LIGHT\_CTL\_TEMPERATURE\_SET &  
ESP\_BLE\_MESH\_MODEL\_OP\_LIGHT\_CTL\_TEMPERATURE\_SET\_UNACK

*esp\_ble\_mesh\_light\_ctl\_temperature\_range\_set\_t* **ctl\_temperature\_range\_set**

For ESP\_BLE\_MESH\_MODEL\_OP\_LIGHT\_CTL\_TEMPERATURE\_RANGE\_SET &  
ESP\_BLE\_MESH\_MODEL\_OP\_LIGHT\_CTL\_TEMPERATURE\_RANGE\_SET\_UNACK

*esp\_ble\_mesh\_light\_ctl\_default\_set\_t* **ctl\_default\_set**

For ESP\_BLE\_MESH\_MODEL\_OP\_LIGHT\_CTL\_DEFAULT\_SET &  
ESP\_BLE\_MESH\_MODEL\_OP\_LIGHT\_CTL\_DEFAULT\_SET\_UNACK

*esp\_ble\_mesh\_light\_hsl\_set\_t* **hsl\_set**

For ESP\_BLE\_MESH\_MODEL\_OP\_LIGHT\_HSL\_SET & ESP\_BLE\_MESH\_MODEL\_OP\_LIGHT\_HSL\_SET\_UNACK

*esp\_ble\_mesh\_light\_hsl\_hue\_set\_t* **hsl\_hue\_set**

For ESP\_BLE\_MESH\_MODEL\_OP\_LIGHT\_HSL\_HUE\_SET & ESP\_BLE\_MESH\_MODEL\_OP\_LIGHT\_HSL\_HUE\_SET\_UNACK

*esp\_ble\_mesh\_light\_hsl\_saturation\_set\_t* **hsl\_saturation\_set**

For ESP\_BLE\_MESH\_MODEL\_OP\_LIGHT\_HSL\_SATURATION\_SET &  
ESP\_BLE\_MESH\_MODEL\_OP\_LIGHT\_HSL\_SATURATION\_SET\_UNACK

*esp\_ble\_mesh\_light\_hsl\_default\_set\_t* **hsl\_default\_set**

For ESP\_BLE\_MESH\_MODEL\_OP\_LIGHT\_HSL\_DEFAULT\_SET &  
ESP\_BLE\_MESH\_MODEL\_OP\_LIGHT\_HSL\_DEFAULT\_SET\_UNACK

*esp\_ble\_mesh\_light\_hsl\_range\_set\_t* **hsl\_range\_set**

For ESP\_BLE\_MESH\_MODEL\_OP\_LIGHT\_HSL\_RANGE\_SET &  
ESP\_BLE\_MESH\_MODEL\_OP\_LIGHT\_HSL\_RANGE\_SET\_UNACK

*esp\_ble\_mesh\_light\_xyl\_set\_t* **xyl\_set**

For ESP\_BLE\_MESH\_MODEL\_OP\_LIGHT\_XYL\_SET & ESP\_BLE\_MESH\_MODEL\_OP\_LIGHT\_XYL\_SET\_UNACK

*esp\_ble\_mesh\_light\_xyl\_default\_set\_t* **xyl\_default\_set**

For ESP\_BLE\_MESH\_MODEL\_OP\_LIGHT\_XYL\_DEFAULT\_SET &  
ESP\_BLE\_MESH\_MODEL\_OP\_LIGHT\_XYL\_DEFAULT\_SET\_UNACK

*esp\_ble\_mesh\_light\_xyl\_range\_set\_t* **xyl\_range\_set**

For ESP\_BLE\_MESH\_MODEL\_OP\_LIGHT\_XYL\_RANGE\_SET &  
ESP\_BLE\_MESH\_MODEL\_OP\_LIGHT\_XYL\_RANGE\_SET\_UNACK

*esp\_ble\_mesh\_light\_lc\_mode\_set\_t* **lc\_mode\_set**

For ESP\_BLE\_MESH\_MODEL\_OP\_LIGHT\_LC\_MODE\_SET &  
ESP\_BLE\_MESH\_MODEL\_OP\_LIGHT\_LC\_MODE\_SET\_UNACK

*esp\_ble\_mesh\_light\_lc\_om\_set\_t* **lc\_om\_set**

For ESP\_BLE\_MESH\_MODEL\_OP\_LIGHT\_LC\_OM\_SET & ESP\_BLE\_MESH\_MODEL\_OP\_LIGHT\_LC\_OM\_SET\_UNACK

*esp\_ble\_mesh\_light\_lc\_light\_onoff\_set\_t* **lc\_light\_onoff\_set**

For ESP\_BLE\_MESH\_MODEL\_OP\_LIGHT\_LC\_LIGHT\_ONOFF\_SET &  
ESP\_BLE\_MESH\_MODEL\_OP\_LIGHT\_LC\_LIGHT\_ONOFF\_SET\_UNACK

*esp\_ble\_mesh\_light\_lc\_property\_set\_t* **lc\_property\_set**

For ESP\_BLE\_MESH\_MODEL\_OP\_LIGHT\_LC\_PROPERTY\_SET &  
ESP\_BLE\_MESH\_MODEL\_OP\_LIGHT\_LC\_PROPERTY\_SET\_UNACK

union **esp\_ble\_mesh\_light\_client\_status\_cb\_t**

#include <esp\_ble\_mesh\_lighting\_model\_api.h> Lighting Client Model received message union.

**Public Members***esp\_ble\_mesh\_light\_lightness\_status\_cb\_t* **lightness\_status**

For ESP\_BLE\_MESH\_MODEL\_OP\_LIGHT\_LIGHTNESS\_STATUS

*esp\_ble\_mesh\_light\_lightness\_linear\_status\_cb\_t* **lightness\_linear\_status**

For ESP\_BLE\_MESH\_MODEL\_OP\_LIGHT\_LIGHTNESS\_LINEAR\_STATUS

*esp\_ble\_mesh\_light\_lightness\_last\_status\_cb\_t* **lightness\_last\_status**

For ESP\_BLE\_MESH\_MODEL\_OP\_LIGHT\_LIGHTNESS\_LAST\_STATUS

*esp\_ble\_mesh\_light\_lightness\_default\_status\_cb\_t* **lightness\_default\_status**

For ESP\_BLE\_MESH\_MODEL\_OP\_LIGHT\_LIGHTNESS\_DEFAULT\_STATUS

*esp\_ble\_mesh\_light\_lightness\_range\_status\_cb\_t* **lightness\_range\_status**

For ESP\_BLE\_MESH\_MODEL\_OP\_LIGHT\_LIGHTNESS\_RANGE\_STATUS

*esp\_ble\_mesh\_light\_ctl\_status\_cb\_t* **ctl\_status**

For ESP\_BLE\_MESH\_MODEL\_OP\_LIGHT\_CTL\_STATUS

*esp\_ble\_mesh\_light\_ctl\_temperature\_status\_cb\_t* **ctl\_temperature\_status**

For ESP\_BLE\_MESH\_MODEL\_OP\_LIGHT\_CTL\_TEMPERATURE\_STATUS

*esp\_ble\_mesh\_light\_ctl\_temperature\_range\_status\_cb\_t* **ctl\_temperature\_range\_status**

For ESP\_BLE\_MESH\_MODEL\_OP\_LIGHT\_CTL\_TEMPERATURE\_RANGE\_STATUS

*esp\_ble\_mesh\_light\_ctl\_default\_status\_cb\_t* **ctl\_default\_status**

For ESP\_BLE\_MESH\_MODEL\_OP\_LIGHT\_CTL\_DEFAULT\_STATUS

*esp\_ble\_mesh\_light\_hsl\_status\_cb\_t* **hsl\_status**

For ESP\_BLE\_MESH\_MODEL\_OP\_LIGHT\_HSL\_STATUS

*esp\_ble\_mesh\_light\_hsl\_target\_status\_cb\_t* **hsl\_target\_status**

For ESP\_BLE\_MESH\_MODEL\_OP\_LIGHT\_HSL\_TARGET\_STATUS

*esp\_ble\_mesh\_light\_hsl\_hue\_status\_cb\_t* **hsl\_hue\_status**

For ESP\_BLE\_MESH\_MODEL\_OP\_LIGHT\_HSL\_HUE\_STATUS

*esp\_ble\_mesh\_light\_hsl\_saturation\_status\_cb\_t* **hsl\_saturation\_status**

For ESP\_BLE\_MESH\_MODEL\_OP\_LIGHT\_HSL\_SATURATION\_STATUS

*esp\_ble\_mesh\_light\_hsl\_default\_status\_cb\_t* **hsl\_default\_status**

For ESP\_BLE\_MESH\_MODEL\_OP\_LIGHT\_HSL\_DEFAULT\_STATUS

*esp\_ble\_mesh\_light\_hsl\_range\_status\_cb\_t* **hsl\_range\_status**

For ESP\_BLE\_MESH\_MODEL\_OP\_LIGHT\_HSL\_RANGE\_STATUS

*esp\_ble\_mesh\_light\_xyl\_status\_cb\_t* **xyl\_status**

For ESP\_BLE\_MESH\_MODEL\_OP\_LIGHT\_XYL\_STATUS

*esp\_ble\_mesh\_light\_xyl\_target\_status\_cb\_t* **xyl\_target\_status**

For ESP\_BLE\_MESH\_MODEL\_OP\_LIGHT\_XYL\_TARGET\_STATUS

*esp\_ble\_mesh\_light\_xyl\_default\_status\_cb\_t* **xyl\_default\_status**

For ESP\_BLE\_MESH\_MODEL\_OP\_LIGHT\_XYL\_DEFAULT\_STATUS

*esp\_ble\_mesh\_light\_xyl\_range\_status\_cb\_t* **xyl\_range\_status**

For ESP\_BLE\_MESH\_MODEL\_OP\_LIGHT\_XYL\_RANGE\_STATUS

*esp\_ble\_mesh\_light\_lc\_mode\_status\_cb\_t* **lc\_mode\_status**

For ESP\_BLE\_MESH\_MODEL\_OP\_LIGHT\_LC\_MODE\_STATUS

*esp\_ble\_mesh\_light\_lc\_om\_status\_cb\_t* **lc\_om\_status**

For ESP\_BLE\_MESH\_MODEL\_OP\_LIGHT\_LC\_OM\_STATUS

*esp\_ble\_mesh\_light\_lc\_light\_onoff\_status\_cb\_t* **lc\_light\_onoff\_status**

For ESP\_BLE\_MESH\_MODEL\_OP\_LIGHT\_LC\_LIGHT\_ONOFF\_STATUS

*esp\_ble\_mesh\_light\_lc\_property\_status\_cb\_t* **lc\_property\_status**

For ESP\_BLE\_MESH\_MODEL\_OP\_LIGHT\_LC\_PROPERTY\_STATUS

union **esp\_ble\_mesh\_lighting\_server\_state\_change\_t**

#include <esp\_ble\_mesh\_lighting\_model\_api.h> Lighting Server Model state change value union.

### Public Members

*esp\_ble\_mesh\_state\_change\_light\_lightness\_set\_t* **lightness\_set**

The recv\_op in ctx can be used to decide which state is changed. Light Lightness Set

*esp\_ble\_mesh\_state\_change\_light\_lightness\_linear\_set\_t* **lightness\_linear\_set**

Light Lightness Linear Set

*esp\_ble\_mesh\_state\_change\_light\_lightness\_default\_set\_t* **lightness\_default\_set**

Light Lightness Default Set

*esp\_ble\_mesh\_state\_change\_light\_lightness\_range\_set\_t* **lightness\_range\_set**

Light Lightness Range Set

*esp\_ble\_mesh\_state\_change\_light\_ctl\_set\_t* **ctl\_set**

Light CTL Set

*esp\_ble\_mesh\_state\_change\_light\_ctl\_temperature\_set\_t* **ctl\_temp\_set**

Light CTL Temperature Set

*esp\_ble\_mesh\_state\_change\_light\_ctl\_temperature\_range\_set\_t* **ctl\_temp\_range\_set**

Light CTL Temperature Range Set

*esp\_ble\_mesh\_state\_change\_light\_ctl\_default\_set\_t* **ctl\_default\_set**

Light CTL Default Set

*esp\_ble\_mesh\_state\_change\_light\_hsl\_set\_t* **hsl\_set**

Light HSL Set

*esp\_ble\_mesh\_state\_change\_light\_hsl\_hue\_set\_t* **hsl\_hue\_set**

Light HSL Hue Set

*esp\_ble\_mesh\_state\_change\_light\_hsl\_saturation\_set\_t* **hsl\_saturation\_set**

Light HSL Saturation Set

*esp\_ble\_mesh\_state\_change\_light\_hsl\_default\_set\_t* **hsl\_default\_set**

Light HSL Default Set

*esp\_ble\_mesh\_state\_change\_light\_hsl\_range\_set\_t* **hsl\_range\_set**

Light HSL Range Set

*esp\_ble\_mesh\_state\_change\_light\_xyl\_set\_t* **xyl\_set**

Light xyL Set

*esp\_ble\_mesh\_state\_change\_light\_xyl\_default\_set\_t* **xyl\_default\_set**

Light xyL Default Set

*esp\_ble\_mesh\_state\_change\_light\_xyl\_range\_set\_t* **xyl\_range\_set**

Light xyL Range Set

*esp\_ble\_mesh\_state\_change\_light\_lc\_mode\_set\_t* **lc\_mode\_set**

Light LC Mode Set

*esp\_ble\_mesh\_state\_change\_light\_lc\_om\_set\_t* **lc\_om\_set**

Light LC Occupancy Mode Set

*esp\_ble\_mesh\_state\_change\_light\_lc\_light\_onoff\_set\_t* **lc\_light\_onoff\_set**

Light LC Light OnOff Set

*esp\_ble\_mesh\_state\_change\_light\_lc\_property\_set\_t* **lc\_property\_set**

Light LC Property Set

*esp\_ble\_mesh\_state\_change\_sensor\_status\_t* **sensor\_status**

Sensor Status

union **esp\_ble\_mesh\_lighting\_server\_recv\_get\_msg\_t**

*#include <esp\_ble\_mesh\_lighting\_model\_api.h>* Lighting Server Model received get message union.

### Public Members

*esp\_ble\_mesh\_server\_recv\_light\_lc\_property\_get\_t* **lc\_property**

Light LC Property Get

union **esp\_ble\_mesh\_lighting\_server\_recv\_set\_msg\_t**

*#include <esp\_ble\_mesh\_lighting\_model\_api.h>* Lighting Server Model received set message union.

### Public Members

*esp\_ble\_mesh\_server\_rcv\_light\_lightness\_set\_t* **lightness**

Light Lightness Set/Light Lightness Set Unack

*esp\_ble\_mesh\_server\_rcv\_light\_lightness\_linear\_set\_t* **lightness\_linear**

Light Lightness Linear Set/Light Lightness Linear Set Unack

*esp\_ble\_mesh\_server\_rcv\_light\_lightness\_default\_set\_t* **lightness\_default**

Light Lightness Default Set/Light Lightness Default Set Unack

*esp\_ble\_mesh\_server\_rcv\_light\_lightness\_range\_set\_t* **lightness\_range**

Light Lightness Range Set/Light Lightness Range Set Unack

*esp\_ble\_mesh\_server\_rcv\_light\_ctl\_set\_t* **ctl**

Light CTL Set/Light CTL Set Unack

*esp\_ble\_mesh\_server\_rcv\_light\_ctl\_temperature\_set\_t* **ctl\_temp**

Light CTL Temperature Set/Light CTL Temperature Set Unack

*esp\_ble\_mesh\_server\_rcv\_light\_ctl\_temperature\_range\_set\_t* **ctl\_temp\_range**

Light CTL Temperature Range Set/Light CTL Temperature Range Set Unack

*esp\_ble\_mesh\_server\_rcv\_light\_ctl\_default\_set\_t* **ctl\_default**

Light CTL Default Set/Light CTL Default Set Unack

*esp\_ble\_mesh\_server\_rcv\_light\_hsl\_set\_t* **hsl**

Light HSL Set/Light HSL Set Unack

*esp\_ble\_mesh\_server\_rcv\_light\_hsl\_hue\_set\_t* **hsl\_hue**

Light HSL Hue Set/Light HSL Hue Set Unack

*esp\_ble\_mesh\_server\_rcv\_light\_hsl\_saturation\_set\_t* **hsl\_saturation**

Light HSL Saturation Set/Light HSL Saturation Set Unack

*esp\_ble\_mesh\_server\_rcv\_light\_hsl\_default\_set\_t* **hsl\_default**

Light HSL Default Set/Light HSL Default Set Unack

*esp\_ble\_mesh\_server\_rcv\_light\_hsl\_range\_set\_t* **hsl\_range**

Light HSL Range Set/Light HSL Range Set Unack

*esp\_ble\_mesh\_server\_rcv\_light\_xyl\_set\_t* **xyl**

Light xyL Set/Light xyL Set Unack

*esp\_ble\_mesh\_server\_rcv\_light\_xyl\_default\_set\_t* **xyl\_default**

Light xyL Default Set/Light xyL Default Set Unack

*esp\_ble\_mesh\_server\_rcv\_light\_xyl\_range\_set\_t* **xyl\_range**

Light xyL Range Set/Light xyL Range Set Unack

*esp\_ble\_mesh\_server\_rcv\_light\_lc\_mode\_set\_t* **lc\_mode**

Light LC Mode Set/Light LC Mode Set Unack

*esp\_ble\_mesh\_server\_rcv\_light\_lc\_om\_set\_t* **lc\_om**

Light LC OM Set/Light LC OM Set Unack

*esp\_ble\_mesh\_server\_rcv\_light\_lc\_light\_onoff\_set\_t* **lc\_light\_onoff**

Light LC Light OnOff Set/Light LC Light OnOff Set Unack

*esp\_ble\_mesh\_server\_rcv\_light\_lc\_property\_set\_t* **lc\_property**

Light LC Property Set/Light LC Property Set Unack

union **esp\_ble\_mesh\_lighting\_server\_rcv\_status\_msg\_t**

*#include <esp\_ble\_mesh\_lighting\_model\_api.h>* Lighting Server Model received status message union.

### Public Members

*esp\_ble\_mesh\_server\_rcv\_sensor\_status\_t* **sensor\_status**

Sensor Status

union **esp\_ble\_mesh\_lighting\_server\_cb\_value\_t**

*#include <esp\_ble\_mesh\_lighting\_model\_api.h>* Lighting Server Model callback value union.

### Public Members

*esp\_ble\_mesh\_lighting\_server\_state\_change\_t* **state\_change**

ESP\_BLE\_MESH\_LIGHTING\_SERVER\_STATE\_CHANGE\_EVT

*esp\_ble\_mesh\_lighting\_server\_rcv\_get\_msg\_t* **get**

ESP\_BLE\_MESH\_LIGHTING\_SERVER\_RECV\_GET\_MSG\_EVT

*esp\_ble\_mesh\_lighting\_server\_rcv\_set\_msg\_t* **set**

ESP\_BLE\_MESH\_LIGHTING\_SERVER\_RECV\_SET\_MSG\_EVT

*esp\_ble\_mesh\_lighting\_server\_rcv\_status\_msg\_t* **status**

ESP\_BLE\_MESH\_LIGHTING\_SERVER\_RECV\_STATUS\_MSG\_EVT

### Structures

struct **esp\_ble\_mesh\_light\_lightness\_set\_t**

Bluetooth Mesh Light Lightness Client Model Get and Set parameters structure.

Parameters of Light Lightness Set

### Public Members

bool **op\_en**

Indicate if optional parameters are included

uint16\_t **lightness**

Target value of light lightness actual state

uint8\_t **tid**

Transaction ID

uint8\_t **trans\_time**

Time to complete state transition (optional)

uint8\_t **delay**

Indicate message execution delay (C.1)

struct **esp\_ble\_mesh\_light\_lightness\_linear\_set\_t**

Parameters of Light Lightness Linear Set

### Public Members

bool **op\_en**

Indicate if optional parameters are included

uint16\_t **lightness**

Target value of light lightness linear state

uint8\_t **tid**

Transaction ID

uint8\_t **trans\_time**

Time to complete state transition (optional)

uint8\_t **delay**

Indicate message execution delay (C.1)

struct **esp\_ble\_mesh\_light\_lightness\_default\_set\_t**

Parameter of Light Lightness Default Set

### Public Members

uint16\_t **lightness**

The value of the Light Lightness Default state

struct **esp\_ble\_mesh\_light\_lightness\_range\_set\_t**

Parameters of Light Lightness Range Set



**Public Members****uint16\_t range\_min**

Value of range min field of light lightness range state

**uint16\_t range\_max**

Value of range max field of light lightness range state

struct **esp\_ble\_mesh\_light\_ctl\_set\_t**

Parameters of Light CTL Set

**Public Members****bool op\_en**

Indicate if optional parameters are included

**uint16\_t ctl\_lightness**

Target value of light ctl lightness state

**uint16\_t ctl\_temperature**

Target value of light ctl temperature state

**int16\_t ctl\_delta\_uv**

Target value of light ctl delta UV state

**uint8\_t tid**

Transaction ID

**uint8\_t trans\_time**

Time to complete state transition (optional)

**uint8\_t delay**

Indicate message execution delay (C.1)

struct **esp\_ble\_mesh\_light\_ctl\_temperature\_set\_t**

Parameters of Light CTL Temperature Set

**Public Members****bool op\_en**

Indicate if optional parameters are included

**uint16\_t ctl\_temperature**

Target value of light ctl temperature state

**int16\_t ctl\_delta\_uv**

Target value of light ctl delta UV state

`uint8_t tid`

Transaction ID

`uint8_t trans_time`

Time to complete state transition (optional)

`uint8_t delay`

Indicate message execution delay (C.1)

struct `esp_ble_mesh_light_ctl_temperature_range_set_t`

Parameters of Light CTL Temperature Range Set

### Public Members

`uint16_t range_min`

Value of temperature range min field of light ctl temperature range state

`uint16_t range_max`

Value of temperature range max field of light ctl temperature range state

struct `esp_ble_mesh_light_ctl_default_set_t`

Parameters of Light CTL Default Set

### Public Members

`uint16_t lightness`

Value of light lightness default state

`uint16_t temperature`

Value of light temperature default state

`int16_t delta_uv`

Value of light delta UV default state

struct `esp_ble_mesh_light_hsl_set_t`

Parameters of Light HSL Set

### Public Members

bool `op_en`

Indicate if optional parameters are included

`uint16_t hsl_lightness`

Target value of light hsl lightness state

uint16\_t **hsl\_hue**

Target value of light hsl hue state

uint16\_t **hsl\_saturation**

Target value of light hsl saturation state

uint8\_t **tid**

Transaction ID

uint8\_t **trans\_time**

Time to complete state transition (optional)

uint8\_t **delay**

Indicate message execution delay (C.1)

struct **esp\_ble\_mesh\_light\_hsl\_hue\_set\_t**

Parameters of Light HSL Hue Set

### Public Members

bool **op\_en**

Indicate if optional parameters are included

uint16\_t **hue**

Target value of light hsl hue state

uint8\_t **tid**

Transaction ID

uint8\_t **trans\_time**

Time to complete state transition (optional)

uint8\_t **delay**

Indicate message execution delay (C.1)

struct **esp\_ble\_mesh\_light\_hsl\_saturation\_set\_t**

Parameters of Light HSL Saturation Set

### Public Members

bool **op\_en**

Indicate if optional parameters are included

uint16\_t **saturation**

Target value of light hsl hue state

`uint8_t tid`

Transaction ID

`uint8_t trans_time`

Time to complete state transition (optional)

`uint8_t delay`

Indicate message execution delay (C.1)

struct `esp_ble_mesh_light_hsl_default_set_t`

Parameters of Light HSL Default Set

### Public Members

`uint16_t lightness`

Value of light lightness default state

`uint16_t hue`

Value of light hue default state

`uint16_t saturation`

Value of light saturation default state

struct `esp_ble_mesh_light_hsl_range_set_t`

Parameters of Light HSL Range Set

### Public Members

`uint16_t hue_range_min`

Value of hue range min field of light hsl hue range state

`uint16_t hue_range_max`

Value of hue range max field of light hsl hue range state

`uint16_t saturation_range_min`

Value of saturation range min field of light hsl saturation range state

`uint16_t saturation_range_max`

Value of saturation range max field of light hsl saturation range state

struct `esp_ble_mesh_light_xyl_set_t`

Parameters of Light xyL Set

### Public Members

bool **op\_en**

Indicate whether optional parameters included

uint16\_t **xy1\_lightness**

The target value of the Light xyL Lightness state

uint16\_t **xy1\_x**

The target value of the Light xyL x state

uint16\_t **xy1\_y**

The target value of the Light xyL y state

uint8\_t **tid**

Transaction Identifier

uint8\_t **trans\_time**

Time to complete state transition (optional)

uint8\_t **delay**

Indicate message execution delay (C.1)

struct **esp\_ble\_mesh\_light\_xy1\_default\_set\_t**

Parameters of Light xyL Default Set

### **Public Members**

uint16\_t **lightness**

The value of the Light Lightness Default state

uint16\_t **xy1\_x**

The value of the Light xyL x Default state

uint16\_t **xy1\_y**

The value of the Light xyL y Default state

struct **esp\_ble\_mesh\_light\_xy1\_range\_set\_t**

Parameters of Light xyL Range Set

### **Public Members**

uint16\_t **xy1\_x\_range\_min**

The value of the xyL x Range Min field of the Light xyL x Range state

uint16\_t **xy1\_x\_range\_max**

The value of the xyL x Range Max field of the Light xyL x Range state

uint16\_t **xy1\_y\_range\_min**

The value of the xyL y Range Min field of the Light xyL y Range state

uint16\_t **xy1\_y\_range\_max**

The value of the xyL y Range Max field of the Light xyL y Range state

struct **esp\_ble\_mesh\_light\_lc\_mode\_set\_t**

Parameter of Light LC Mode Set

### Public Members

uint8\_t **mode**

The target value of the Light LC Mode state

struct **esp\_ble\_mesh\_light\_lc\_om\_set\_t**

Parameter of Light LC OM Set

### Public Members

uint8\_t **mode**

The target value of the Light LC Occupancy Mode state

struct **esp\_ble\_mesh\_light\_lc\_light\_onoff\_set\_t**

Parameters of Light LC Light OnOff Set

### Public Members

bool **op\_en**

Indicate whether optional parameters included

uint8\_t **light\_onoff**

The target value of the Light LC Light OnOff state

uint8\_t **tid**

Transaction Identifier

uint8\_t **trans\_time**

Time to complete state transition (optional)

uint8\_t **delay**

Indicate message execution delay (C.1)

struct **esp\_ble\_mesh\_light\_lc\_property\_get\_t**

Parameter of Light LC Property Get

**Public Members****uint16\_t property\_id**

Property ID identifying a Light LC Property

struct **esp\_ble\_mesh\_light\_lc\_property\_set\_t**

Parameters of Light LC Property Set

**Public Members****uint16\_t property\_id**

Property ID identifying a Light LC Property

struct net\_buf\_simple \***property\_value**

Raw value for the Light LC Property

struct **esp\_ble\_mesh\_light\_lightness\_status\_cb\_t**

Bluetooth Mesh Light Lightness Client Model Get and Set callback parameters structure.

Parameters of Light Lightness Status

**Public Members**bool **op\_en**

Indicate if optional parameters are included

**uint16\_t present\_lightness**

Current value of light lightness actual state

**uint16\_t target\_lightness**

Target value of light lightness actual state (optional)

**uint8\_t remain\_time**

Time to complete state transition (C.1)

struct **esp\_ble\_mesh\_light\_lightness\_linear\_status\_cb\_t**

Parameters of Light Lightness Linear Status

**Public Members**bool **op\_en**

Indicate if optional parameters are included

**uint16\_t present\_lightness**

Current value of light lightness linear state

uint16\_t **target\_lightness**

Target value of light lightness linear state (optional)

uint8\_t **remain\_time**

Time to complete state transition (C.1)

struct **esp\_ble\_mesh\_light\_lightness\_last\_status\_cb\_t**

Parameter of Light Lightness Last Status

### Public Members

uint16\_t **lightness**

The value of the Light Lightness Last state

struct **esp\_ble\_mesh\_light\_lightness\_default\_status\_cb\_t**

Parameter of Light Lightness Default Status

### Public Members

uint16\_t **lightness**

The value of the Light Lightness default State

struct **esp\_ble\_mesh\_light\_lightness\_range\_status\_cb\_t**

Parameters of Light Lightness Range Status

### Public Members

uint8\_t **status\_code**

Status Code for the request message

uint16\_t **range\_min**

Value of range min field of light lightness range state

uint16\_t **range\_max**

Value of range max field of light lightness range state

struct **esp\_ble\_mesh\_light\_ctl\_status\_cb\_t**

Parameters of Light CTL Status

### Public Members

bool **op\_en**

Indicate if optional parameters are included

uint16\_t **present\_ctl\_lightness**

Current value of light ctl lightness state



uint16\_t **present\_ctl\_temperature**

Current value of light ctl temperature state

uint16\_t **target\_ctl\_lightness**

Target value of light ctl lightness state (optional)

uint16\_t **target\_ctl\_temperature**

Target value of light ctl temperature state (C.1)

uint8\_t **remain\_time**

Time to complete state transition (C.1)

struct **esp\_ble\_mesh\_light\_ctl\_temperature\_status\_cb\_t**

Parameters of Light CTL Temperature Status

### Public Members

bool **op\_en**

Indicate if optional parameters are included

uint16\_t **present\_ctl\_temperature**

Current value of light ctl temperature state

uint16\_t **present\_ctl\_delta\_uv**

Current value of light ctl delta UV state

uint16\_t **target\_ctl\_temperature**

Target value of light ctl temperature state (optional)

uint16\_t **target\_ctl\_delta\_uv**

Target value of light ctl delta UV state (C.1)

uint8\_t **remain\_time**

Time to complete state transition (C.1)

struct **esp\_ble\_mesh\_light\_ctl\_temperature\_range\_status\_cb\_t**

Parameters of Light CTL Temperature Range Status

### Public Members

uint8\_t **status\_code**

Status code for the request message

uint16\_t **range\_min**

Value of temperature range min field of light ctl temperature range state

uint16\_t **range\_max**

Value of temperature range max field of light ctl temperature range state

struct **esp\_ble\_mesh\_light\_ctl\_default\_status\_cb\_t**

Parameters of Light CTL Default Status

### Public Members

uint16\_t **lightness**

Value of light lightness default state

uint16\_t **temperature**

Value of light temperature default state

int16\_t **delta\_uv**

Value of light delta UV default state

struct **esp\_ble\_mesh\_light\_hsl\_status\_cb\_t**

Parameters of Light HSL Status

### Public Members

bool **op\_en**

Indicate if optional parameters are included

uint16\_t **hsl\_lightness**

Current value of light hsl lightness state

uint16\_t **hsl\_hue**

Current value of light hsl hue state

uint16\_t **hsl\_saturation**

Current value of light hsl saturation state

uint8\_t **remain\_time**

Time to complete state transition (optional)

struct **esp\_ble\_mesh\_light\_hsl\_target\_status\_cb\_t**

Parameters of Light HSL Target Status

### Public Members

bool **op\_en**

Indicate if optional parameters are included

`uint16_t hsl_lightness_target`  
Target value of light hsl lightness state

`uint16_t hsl_hue_target`  
Target value of light hsl hue state

`uint16_t hsl_saturation_target`  
Target value of light hsl saturation state

`uint8_t remain_time`  
Time to complete state transition (optional)

struct `esp_ble_mesh_light_hsl_hue_status_cb_t`  
Parameters of Light HSL Hue Status

### Public Members

bool `op_en`  
Indicate if optional parameters are included

`uint16_t present_hue`  
Current value of light hsl hue state

`uint16_t target_hue`  
Target value of light hsl hue state (optional)

`uint8_t remain_time`  
Time to complete state transition (C.1)

struct `esp_ble_mesh_light_hsl_saturation_status_cb_t`  
Parameters of Light HSL Saturation Status

### Public Members

bool `op_en`  
Indicate if optional parameters are included

`uint16_t present_saturation`  
Current value of light hsl saturation state

`uint16_t target_saturation`  
Target value of light hsl saturation state (optional)

`uint8_t remain_time`  
Time to complete state transition (C.1)

struct `esp_ble_mesh_light_hsl_default_status_cb_t`  
Parameters of Light HSL Default Status

**Public Members****uint16\_t lightness**

Value of light lightness default state

**uint16\_t hue**

Value of light hue default state

**uint16\_t saturation**

Value of light saturation default state

struct **esp\_ble\_mesh\_light\_hsl\_range\_status\_cb\_t**

Parameters of Light HSL Range Status

**Public Members****uint8\_t status\_code**

Status code for the request message

**uint16\_t hue\_range\_min**

Value of hue range min field of light hsl hue range state

**uint16\_t hue\_range\_max**

Value of hue range max field of light hsl hue range state

**uint16\_t saturation\_range\_min**

Value of saturation range min field of light hsl saturation range state

**uint16\_t saturation\_range\_max**

Value of saturation range max field of light hsl saturation range state

struct **esp\_ble\_mesh\_light\_xyl\_status\_cb\_t**

Parameters of Light xyL Status

**Public Members****bool op\_en**

Indicate whether optional parameters included

**uint16\_t xyl\_lightness**

The present value of the Light xyL Lightness state

**uint16\_t xyl\_x**

The present value of the Light xyL x state

**uint16\_t xyl\_y**

The present value of the Light xyL y state

uint8\_t **remain\_time**

Time to complete state transition (optional)

struct **esp\_ble\_mesh\_light\_xyl\_target\_status\_cb\_t**

Parameters of Light xyL Target Status

### Public Members

bool **op\_en**

Indicate whether optional parameters included

uint16\_t **target\_xyl\_lightness**

The target value of the Light xyL Lightness state

uint16\_t **target\_xyl\_x**

The target value of the Light xyL x state

uint16\_t **target\_xyl\_y**

The target value of the Light xyL y state

uint8\_t **remain\_time**

Time to complete state transition (optional)

struct **esp\_ble\_mesh\_light\_xyl\_default\_status\_cb\_t**

Parameters of Light xyL Default Status

### Public Members

uint16\_t **lightness**

The value of the Light Lightness Default state

uint16\_t **xyl\_x**

The value of the Light xyL x Default state

uint16\_t **xyl\_y**

The value of the Light xyL y Default state

struct **esp\_ble\_mesh\_light\_xyl\_range\_status\_cb\_t**

Parameters of Light xyL Range Status

### Public Members

uint8\_t **status\_code**

Status Code for the requesting message

uint16\_t **xyL\_x\_range\_min**

The value of the xyL x Range Min field of the Light xyL x Range state

uint16\_t **xyL\_x\_range\_max**

The value of the xyL x Range Max field of the Light xyL x Range state

uint16\_t **xyL\_y\_range\_min**

The value of the xyL y Range Min field of the Light xyL y Range state

uint16\_t **xyL\_y\_range\_max**

The value of the xyL y Range Max field of the Light xyL y Range state

struct **esp\_ble\_mesh\_light\_lc\_mode\_status\_cb\_t**

Parameter of Light LC Mode Status

### Public Members

uint8\_t **mode**

The present value of the Light LC Mode state

struct **esp\_ble\_mesh\_light\_lc\_om\_status\_cb\_t**

Parameter of Light LC OM Status

### Public Members

uint8\_t **mode**

The present value of the Light LC Occupancy Mode state

struct **esp\_ble\_mesh\_light\_lc\_light\_onoff\_status\_cb\_t**

Parameters of Light LC Light OnOff Status

### Public Members

bool **op\_en**

Indicate whether optional parameters included

uint8\_t **present\_light\_onoff**

The present value of the Light LC Light OnOff state

uint8\_t **target\_light\_onoff**

The target value of the Light LC Light OnOff state (Optional)

uint8\_t **remain\_time**

Time to complete state transition (C.1)

struct **esp\_ble\_mesh\_light\_lc\_property\_status\_cb\_t**

Parameters of Light LC Property Status

**Public Members****uint16\_t property\_id**

Property ID identifying a Light LC Property

struct net\_buf\_simple \***property\_value**

Raw value for the Light LC Property

struct **esp\_ble\_mesh\_light\_client\_cb\_param\_t**

Lighting Client Model callback parameters

**Public Members**int **error\_code**

Appropriate error code

*esp\_ble\_mesh\_client\_common\_param\_t* \***params**

The client common parameters.

*esp\_ble\_mesh\_light\_client\_status\_cb\_t* **status\_cb**

The light status message callback values

struct **esp\_ble\_mesh\_light\_lightness\_state\_t**

Parameters of Light Lightness state

**Public Members**uint16\_t **lightness\_linear**

The present value of Light Lightness Linear state

uint16\_t **target\_lightness\_linear**

The target value of Light Lightness Linear state

uint16\_t **lightness\_actual**

The present value of Light Lightness Actual state

uint16\_t **target\_lightness\_actual**

The target value of Light Lightness Actual state

uint16\_t **lightness\_last**

The value of Light Lightness Last state

uint16\_t **lightness\_default**

The value of Light Lightness Default state

uint8\_t **status\_code**

The status code of setting Light Lightness Range state

uint16\_t **lightness\_range\_min**

The minimum value of Light Lightness Range state

uint16\_t **lightness\_range\_max**

The maximum value of Light Lightness Range state

struct **esp\_ble\_mesh\_light\_lightness\_srv\_t**

User data of Light Lightness Server Model

### Public Members

*esp\_ble\_mesh\_model\_t* \***model**

Pointer to the Lighting Lightness Server Model. Initialized internally.

*esp\_ble\_mesh\_server\_rsp\_ctrl\_t* **rsp\_ctrl**

Response control of the server model received messages

*esp\_ble\_mesh\_light\_lightness\_state\_t* \***state**

Parameters of the Light Lightness state

*esp\_ble\_mesh\_last\_msg\_info\_t* **last**

Parameters of the last received set message

*esp\_ble\_mesh\_state\_transition\_t* **actual\_transition**

Parameters of state transition

*esp\_ble\_mesh\_state\_transition\_t* **linear\_transition**

Parameters of state transition

int32\_t **tt\_delta\_lightness\_actual**

Delta change value of lightness actual state transition

int32\_t **tt\_delta\_lightness\_linear**

Delta change value of lightness linear state transition

struct **esp\_ble\_mesh\_light\_lightness\_setup\_srv\_t**

User data of Light Lightness Setup Server Model

### Public Members

*esp\_ble\_mesh\_model\_t* \***model**

Pointer to the Lighting Lightness Setup Server Model. Initialized internally.

*esp\_ble\_mesh\_server\_rsp\_ctrl\_t* **rsp\_ctrl**

Response control of the server model received messages



*esp\_ble\_mesh\_light\_lightness\_state\_t* \*state

Parameters of the Light Lightness state

struct **esp\_ble\_mesh\_light\_ctl\_state\_t**

Parameters of Light CTL state

### Public Members

uint16\_t **lightness**

The present value of Light CTL Lightness state

uint16\_t **target\_lightness**

The target value of Light CTL Lightness state

uint16\_t **temperature**

The present value of Light CTL Temperature state

uint16\_t **target\_temperature**

The target value of Light CTL Temperature state

int16\_t **delta\_uv**

The present value of Light CTL Delta UV state

int16\_t **target\_delta\_uv**

The target value of Light CTL Delta UV state

uint8\_t **status\_code**

The statue code of setting Light CTL Temperature Range state

uint16\_t **temperature\_range\_min**

The minimum value of Light CTL Temperature Range state

uint16\_t **temperature\_range\_max**

The maximum value of Light CTL Temperature Range state

uint16\_t **lightness\_default**

The value of Light Lightness Default state

uint16\_t **temperature\_default**

The value of Light CTL Temperature Default state

int16\_t **delta\_uv\_default**

The value of Light CTL Delta UV Default state

struct **esp\_ble\_mesh\_light\_ctl\_srv\_t**

User data of Light CTL Server Model

**Public Members**

*esp\_ble\_mesh\_model\_t* \***model**

Pointer to the Lighting CTL Server Model. Initialized internally.

*esp\_ble\_mesh\_server\_rsp\_ctrl\_t* **rsp\_ctrl**

Response control of the server model received messages

*esp\_ble\_mesh\_light\_ctl\_state\_t* \***state**

Parameters of the Light CTL state

*esp\_ble\_mesh\_last\_msg\_info\_t* **last**

Parameters of the last received set message

*esp\_ble\_mesh\_state\_transition\_t* **transition**

Parameters of state transition

int32\_t **tt\_delta\_lightness**

Delta change value of lightness state transition

int32\_t **tt\_delta\_temperature**

Delta change value of temperature state transition

int32\_t **tt\_delta\_delta\_uv**

Delta change value of delta uv state transition

struct **esp\_ble\_mesh\_light\_ctl\_setup\_srv\_t**

User data of Light CTL Setup Server Model

**Public Members**

*esp\_ble\_mesh\_model\_t* \***model**

Pointer to the Lighting CTL Setup Server Model. Initialized internally.

*esp\_ble\_mesh\_server\_rsp\_ctrl\_t* **rsp\_ctrl**

Response control of the server model received messages

*esp\_ble\_mesh\_light\_ctl\_state\_t* \***state**

Parameters of the Light CTL state

struct **esp\_ble\_mesh\_light\_ctl\_temp\_srv\_t**

User data of Light CTL Temperature Server Model

**Public Members**

*esp\_ble\_mesh\_model\_t* \***model**

Pointer to the Lighting CTL Temperature Server Model. Initialized internally.

*esp\_ble\_mesh\_server\_rsp\_ctrl\_t* **rsp\_ctrl**

Response control of the server model received messages

*esp\_ble\_mesh\_light\_ctl\_state\_t* \***state**

Parameters of the Light CTL state

*esp\_ble\_mesh\_last\_msg\_info\_t* **last**

Parameters of the last received set message

*esp\_ble\_mesh\_state\_transition\_t* **transition**

Parameters of state transition

int32\_t **tt\_delta\_temperature**

Delta change value of temperature state transition

int32\_t **tt\_delta\_delta\_uv**

Delta change value of delta uv state transition

struct **esp\_ble\_mesh\_light\_hsl\_state\_t**

Parameters of Light HSL state

### Public Members

uint16\_t **lightness**

The present value of Light HSL Lightness state

uint16\_t **target\_lightness**

The target value of Light HSL Lightness state

uint16\_t **hue**

The present value of Light HSL Hue state

uint16\_t **target\_hue**

The target value of Light HSL Hue state

uint16\_t **saturation**

The present value of Light HSL Saturation state

uint16\_t **target\_saturation**

The target value of Light HSL Saturation state

uint16\_t **lightness\_default**

The value of Light Lightness Default state

uint16\_t **hue\_default**

The value of Light HSL Hue Default state

`uint16_t saturation_default`

The value of Light HSL Saturation Default state

`uint8_t status_code`

The status code of setting Light HSL Hue & Saturation Range state

`uint16_t hue_range_min`

The minimum value of Light HSL Hue Range state

`uint16_t hue_range_max`

The maximum value of Light HSL Hue Range state

`uint16_t saturation_range_min`

The minimum value of Light HSL Saturation state

`uint16_t saturation_range_max`

The maximum value of Light HSL Saturation state

struct `esp_ble_mesh_light_hsl_srv_t`

User data of Light HSL Server Model

### Public Members

`esp_ble_mesh_model_t *model`

Pointer to the Lighting HSL Server Model. Initialized internally.

`esp_ble_mesh_server_rsp_ctrl_t rsp_ctrl`

Response control of the server model received messages

`esp_ble_mesh_light_hsl_state_t *state`

Parameters of the Light HSL state

`esp_ble_mesh_last_msg_info_t last`

Parameters of the last received set message

`esp_ble_mesh_state_transition_t transition`

Parameters of state transition

`int32_t tt_delta_lightness`

Delta change value of lightness state transition

`int32_t tt_delta_hue`

Delta change value of hue state transition

`int32_t tt_delta_saturation`

Delta change value of saturation state transition

struct `esp_ble_mesh_light_hsl_setup_srv_t`

User data of Light HSL Setup Server Model

**Public Members**

*esp\_ble\_mesh\_model\_t* \***model**

Pointer to the Lighting HSL Setup Server Model. Initialized internally.

*esp\_ble\_mesh\_server\_rsp\_ctrl\_t* **rsp\_ctrl**

Response control of the server model received messages

*esp\_ble\_mesh\_light\_hsl\_state\_t* \***state**

Parameters of the Light HSL state

struct **esp\_ble\_mesh\_light\_hsl\_hue\_srv\_t**

User data of Light HSL Hue Server Model

**Public Members**

*esp\_ble\_mesh\_model\_t* \***model**

Pointer to the Lighting HSL Hue Server Model. Initialized internally.

*esp\_ble\_mesh\_server\_rsp\_ctrl\_t* **rsp\_ctrl**

Response control of the server model received messages

*esp\_ble\_mesh\_light\_hsl\_state\_t* \***state**

Parameters of the Light HSL state

*esp\_ble\_mesh\_last\_msg\_info\_t* **last**

Parameters of the last received set message

*esp\_ble\_mesh\_state\_transition\_t* **transition**

Parameters of state transition

int32\_t **tt\_delta\_hue**

Delta change value of hue state transition

struct **esp\_ble\_mesh\_light\_hsl\_sat\_srv\_t**

User data of Light HSL Saturation Server Model

**Public Members**

*esp\_ble\_mesh\_model\_t* \***model**

Pointer to the Lighting HSL Saturation Server Model. Initialized internally.

*esp\_ble\_mesh\_server\_rsp\_ctrl\_t* **rsp\_ctrl**

Response control of the server model received messages

*esp\_ble\_mesh\_light\_hsl\_state\_t* \***state**

Parameters of the Light HSL state

*esp\_ble\_mesh\_last\_msg\_info\_t* **last**

Parameters of the last received set message

*esp\_ble\_mesh\_state\_transition\_t* **transition**

Parameters of state transition

int32\_t **tt\_delta\_saturation**

Delta change value of saturation state transition

struct **esp\_ble\_mesh\_light\_xyl\_state\_t**

Parameters of Light xyL state

### **Public Members**

uint16\_t **lightness**

The present value of Light xyL Lightness state

uint16\_t **target\_lightness**

The target value of Light xyL Lightness state

uint16\_t **x**

The present value of Light xyL x state

uint16\_t **target\_x**

The target value of Light xyL x state

uint16\_t **y**

The present value of Light xyL y state

uint16\_t **target\_y**

The target value of Light xyL y state

uint16\_t **lightness\_default**

The value of Light Lightness Default state

uint16\_t **x\_default**

The value of Light xyL x Default state

uint16\_t **y\_default**

The value of Light xyL y Default state

uint8\_t **status\_code**

The status code of setting Light xyL x & y Range state

uint16\_t **x\_range\_min**

The minimum value of Light xyL x Range state

uint16\_t **x\_range\_max**

The maximum value of Light xyL x Range state

uint16\_t **y\_range\_min**

The minimum value of Light xyL y Range state

uint16\_t **y\_range\_max**

The maximum value of Light xyL y Range state

struct **esp\_ble\_mesh\_light\_xyl\_srv\_t**

User data of Light xyL Server Model

### Public Members

*esp\_ble\_mesh\_model\_t* \***model**

Pointer to the Lighting xyL Server Model. Initialized internally.

*esp\_ble\_mesh\_server\_rsp\_ctrl\_t* **rsp\_ctrl**

Response control of the server model received messages

*esp\_ble\_mesh\_light\_xyl\_state\_t* \***state**

Parameters of the Light xyL state

*esp\_ble\_mesh\_last\_msg\_info\_t* **last**

Parameters of the last received set message

*esp\_ble\_mesh\_state\_transition\_t* **transition**

Parameters of state transition

int32\_t **tt\_delta\_lightness**

Delta change value of lightness state transition

int32\_t **tt\_delta\_x**

Delta change value of x state transition

int32\_t **tt\_delta\_y**

Delta change value of y state transition

struct **esp\_ble\_mesh\_light\_xyl\_setup\_srv\_t**

User data of Light xyL Setup Server Model

### Public Members

*esp\_ble\_mesh\_model\_t* \***model**

Pointer to the Lighting xyL Setup Server Model. Initialized internally.

*esp\_ble\_mesh\_server\_rsp\_ctrl\_t* **rsp\_ctrl**

Response control of the server model received messages

*esp\_ble\_mesh\_light\_xyl\_state\_t* \***state**

Parameters of the Light xyL state

struct **esp\_ble\_mesh\_light\_lc\_state\_t**

Parameters of Light LC states

### Public Members

uint32\_t **mode**

0b0 The controller is turned off.

- The binding with the Light Lightness state is disabled. 0b1 The controller is turned on.
- The binding with the Light Lightness state is enabled. The value of Light LC Mode state

uint32\_t **occupancy\_mode**

The value of Light LC Occupancy Mode state

uint32\_t **light\_onoff**

The present value of Light LC Light OnOff state

uint32\_t **target\_light\_onoff**

The target value of Light LC Light OnOff state

uint32\_t **occupancy**

The value of Light LC Occupancy state

uint32\_t **ambient\_luxlevel**

The value of Light LC Ambient LuxLevel state

uint16\_t **linear\_output**

- Light LC Linear Output =  $\max((\text{Lightness Out})^2/65535, \text{Regulator Output})$
- If the Light LC Mode state is set to 0b1, the binding is enabled and upon a change of the Light LC Linear Output state, the following operation shall be performed: Light Lightness Linear = Light LC Linear Output
- If the Light LC Mode state is set to 0b0, the binding is disabled (i.e., upon a change of the Light LC Linear Output state, no operation on the Light Lightness Linear state is performed). The value of Light LC Linear Output state

struct **esp\_ble\_mesh\_light\_lc\_property\_state\_t**

Parameters of Light Property states. The Light LC Property states are read / write states that determine the configuration of a Light Lightness Controller. Each state is represented by a device property and is controlled by Light LC Property messages.

### Public Members



**uint32\_t time\_occupancy\_delay**

A timing state that determines the delay for changing the Light LC Occupancy state upon receiving a Sensor Status message from an occupancy sensor. The value of Light LC Time Occupancy Delay state

**uint32\_t time\_fade\_on**

A timing state that determines the time the controlled lights fade to the level determined by the Light LC Lightness On state. The value of Light LC Time Fade On state

**uint32\_t time\_run\_on**

A timing state that determines the time the controlled lights stay at the level determined by the Light LC Lightness On state. The value of Light LC Time Run On state

**uint32\_t time\_fade**

A timing state that determines the time the controlled lights fade from the level determined by the Light LC Lightness On state to the level determined by the Light Lightness Prolong state. The value of Light LC Time Fade state

**uint32\_t time\_prolong**

A timing state that determines the time the controlled lights stay at the level determined by the Light LC Lightness Prolong state. The value of Light LC Time Prolong state

**uint32\_t time\_fade\_standby\_auto**

A timing state that determines the time the controlled lights fade from the level determined by the Light LC Lightness Prolong state to the level determined by the Light LC Lightness Standby state when the transition is automatic. The value of Light LC Time Fade Standby Auto state

**uint32\_t time\_fade\_standby\_manual**

A timing state that determines the time the controlled lights fade from the level determined by the Light LC Lightness Prolong state to the level determined by the Light LC Lightness Standby state when the transition is triggered by a change in the Light LC Light OnOff state. The value of Light LC Time Fade Standby Manual state

**uint16\_t lightness\_on**

A lightness state that determines the perceptible light lightness at the Occupancy and Run internal controller states. The value of Light LC Lightness On state

**uint16\_t lightness\_prolong**

A lightness state that determines the light lightness at the Prolong internal controller state. The value of Light LC Lightness Prolong state

**uint16\_t lightness\_standby**

A lightness state that determines the light lightness at the Standby internal controller state. The value of Light LC Lightness Standby state

**uint16\_t ambient\_luxlevel\_on**

A uint16 state representing the Ambient LuxLevel level that determines if the controller transitions from the Light Control Standby state. The value of Light LC Ambient LuxLevel On state

**uint16\_t ambient\_luxlevel\_prolong**

A uint16 state representing the required Ambient LuxLevel level in the Prolong state. The value of Light LC Ambient LuxLevel Prolong state

**uint16\_t ambient\_luxlevel\_standby**

A uint16 state representing the required Ambient LuxLevel level in the Standby state. The value of Light LC Ambient LuxLevel Standby state

**float regulator\_kiu**

A float32 state representing the integral coefficient that determines the integral part of the equation defining the output of the Light LC PI Feedback Regulator, when Light LC Ambient LuxLevel is less than LuxLevel Out. Valid range: 0.0 ~ 1000.0. The default value is 250.0. The value of Light LC Regulator Kiu state

**float regulator\_kid**

A float32 state representing the integral coefficient that determines the integral part of the equation defining the output of the Light LC PI Feedback Regulator, when Light LC Ambient LuxLevel is greater than or equal to the value of the LuxLevel Out state. Valid range: 0.0 ~ 1000.0. The default value is 25.0. The value of Light LC Regulator Kid state

**float regulator\_kpu**

A float32 state representing the proportional coefficient that determines the proportional part of the equation defining the output of the Light LC PI Feedback Regulator, when Light LC Ambient LuxLevel is less than the value of the LuxLevel Out state. Valid range: 0.0 ~ 1000.0. The default value is 80.0. The value of Light LC Regulator Kpu state

**float regulator\_kpd**

A float32 state representing the proportional coefficient that determines the proportional part of the equation defining the output of the Light LC PI Feedback Regulator, when Light LC Ambient LuxLevel is greater than or equal to the value of the LuxLevel Out state. Valid range: 0.0 ~ 1000.0. The default value is 80.0. The value of Light LC Regulator Kpd state

**int8\_t regulator\_accuracy**

A int8 state representing the percentage accuracy of the Light LC PI Feedback Regulator. Valid range: 0.0 ~ 100.0. The default value is 2.0. The value of Light LC Regulator Accuracy state

**uint32\_t set\_occupancy\_to\_1\_delay**

If the message Raw field contains a Raw Value for the Time Since Motion Sensed device property, which represents a value less than or equal to the value of the Light LC Occupancy Delay state, it shall delay setting the Light LC Occupancy state to 0b1 by the difference between the value of the Light LC Occupancy Delay state and the received Time Since Motion value. The value of the difference between value of the Light LC Occupancy Delay state and the received Time Since Motion value

**struct esp\_ble\_mesh\_light\_lc\_state\_machine\_t**

Parameters of Light LC state machine

**Public Members****uint8\_t fade\_on**

The value of transition time of Light LC Time Fade On

**uint8\_t fade**

The value of transition time of Light LC Time Fade

uint8\_t **fade\_standby\_auto**

The value of transition time of Light LC Time Fade Standby Auto

uint8\_t **fade\_standby\_manual**

The value of transition time of Light LC Time Fade Standby Manual

struct *esp\_ble\_mesh\_light\_lc\_state\_machine\_t*::[anonymous] **trans\_time**

The Fade On, Fade, Fade Standby Auto, and Fade Standby Manual states are transition states that define the transition of the Lightness Out and LuxLevel Out states. This transition can be started as a result of the Light LC State Machine change or as a result of receiving the Light LC Light OnOff Set or Light LC Light Set Unacknowledged message. The value of transition time

*esp\_ble\_mesh\_lc\_state\_t* **state**

The value of Light LC state machine state

struct k\_delayed\_work **timer**

Timer of Light LC state machine

struct **esp\_ble\_mesh\_light\_control\_t**

Parameters of Light Lightness controller

### Public Members

*esp\_ble\_mesh\_light\_lc\_state\_t* **state**

Parameters of Light LC state

*esp\_ble\_mesh\_light\_lc\_property\_state\_t* **prop\_state**

Parameters of Light LC Property state

*esp\_ble\_mesh\_light\_lc\_state\_machine\_t* **state\_machine**

Parameters of Light LC state machine

struct **esp\_ble\_mesh\_light\_lc\_srv\_t**

User data of Light LC Server Model

### Public Members

*esp\_ble\_mesh\_model\_t* \***model**

Pointer to the Lighting LC Server Model. Initialized internally.

*esp\_ble\_mesh\_server\_rsp\_ctrl\_t* **rsp\_ctrl**

Response control of the server model received messages

*esp\_ble\_mesh\_light\_control\_t* \***lc**

Parameters of the Light controller

*esp\_ble\_mesh\_last\_msg\_info\_t* **last**

Parameters of the last received set message

*esp\_ble\_mesh\_state\_transition\_t* **transition**

Parameters of state transition

struct **esp\_ble\_mesh\_light\_lc\_setup\_srv\_t**

User data of Light LC Setup Server Model

### Public Members

*esp\_ble\_mesh\_model\_t* \***model**

Pointer to the Lighting LC Setup Server Model. Initialized internally.

*esp\_ble\_mesh\_server\_rsp\_ctrl\_t* **rsp\_ctrl**

Response control of the server model received messages

*esp\_ble\_mesh\_light\_control\_t* \***lc**

Parameters of the Light controller

struct **esp\_ble\_mesh\_state\_change\_light\_lightness\_set\_t**

Parameter of Light Lightness Actual state change event

### Public Members

uint16\_t **lightness**

The value of Light Lightness Actual state

struct **esp\_ble\_mesh\_state\_change\_light\_lightness\_linear\_set\_t**

Parameter of Light Lightness Linear state change event

### Public Members

uint16\_t **lightness**

The value of Light Lightness Linear state

struct **esp\_ble\_mesh\_state\_change\_light\_lightness\_default\_set\_t**

Parameter of Light Lightness Default state change event

### Public Members

uint16\_t **lightness**

The value of Light Lightness Default state

struct **esp\_ble\_mesh\_state\_change\_light\_lightness\_range\_set\_t**

Parameters of Light Lightness Range state change event

**Public Members****uint16\_t range\_min**

The minimum value of Light Lightness Range state

**uint16\_t range\_max**

The maximum value of Light Lightness Range state

struct **esp\_ble\_mesh\_state\_change\_light\_ctl\_set\_t**

Parameters of Light CTL state change event

**Public Members****uint16\_t lightness**

The value of Light CTL Lightness state

**uint16\_t temperature**

The value of Light CTL Temperature state

**int16\_t delta\_uv**

The value of Light CTL Delta UV state

struct **esp\_ble\_mesh\_state\_change\_light\_ctl\_temperature\_set\_t**

Parameters of Light CTL Temperature state change event

**Public Members****uint16\_t temperature**

The value of Light CTL Temperature state

**int16\_t delta\_uv**

The value of Light CTL Delta UV state

struct **esp\_ble\_mesh\_state\_change\_light\_ctl\_temperature\_range\_set\_t**

Parameters of Light CTL Temperature Range state change event

**Public Members****uint16\_t range\_min**

The minimum value of Light CTL Temperature Range state

**uint16\_t range\_max**

The maximum value of Light CTL Temperature Range state

struct **esp\_ble\_mesh\_state\_change\_light\_ctl\_default\_set\_t**

Parameters of Light CTL Default state change event

**Public Members****uint16\_t lightness**

The value of Light Lightness Default state

**uint16\_t temperature**

The value of Light CTL Temperature Default state

**int16\_t delta\_uv**

The value of Light CTL Delta UV Default state

struct **esp\_ble\_mesh\_state\_change\_light\_hsl\_set\_t**

Parameters of Light HSL state change event

**Public Members****uint16\_t lightness**

The value of Light HSL Lightness state

**uint16\_t hue**

The value of Light HSL Hue state

**uint16\_t saturation**

The value of Light HSL Saturation state

struct **esp\_ble\_mesh\_state\_change\_light\_hsl\_hue\_set\_t**

Parameter of Light HSL Hue state change event

**Public Members****uint16\_t hue**

The value of Light HSL Hue state

struct **esp\_ble\_mesh\_state\_change\_light\_hsl\_saturation\_set\_t**

Parameter of Light HSL Saturation state change event

**Public Members****uint16\_t saturation**

The value of Light HSL Saturation state

struct **esp\_ble\_mesh\_state\_change\_light\_hsl\_default\_set\_t**

Parameters of Light HSL Default state change event

**Public Members****uint16\_t lightness**

The value of Light HSL Lightness Default state

**uint16\_t hue**

The value of Light HSL Hue Default state

**uint16\_t saturation**

The value of Light HSL Saturation Default state

struct **esp\_ble\_mesh\_state\_change\_light\_hsl\_range\_set\_t**

Parameters of Light HSL Range state change event

**Public Members****uint16\_t hue\_range\_min**

The minimum hue value of Light HSL Range state

**uint16\_t hue\_range\_max**

The maximum hue value of Light HSL Range state

**uint16\_t saturation\_range\_min**

The minimum saturation value of Light HSL Range state

**uint16\_t saturation\_range\_max**

The maximum saturation value of Light HSL Range state

struct **esp\_ble\_mesh\_state\_change\_light\_xyL\_set\_t**

Parameters of Light xyL state change event

**Public Members****uint16\_t lightness**

The value of Light xyL Lightness state

**uint16\_t x**

The value of Light xyL x state

**uint16\_t y**

The value of Light xyL y state

struct **esp\_ble\_mesh\_state\_change\_light\_xyL\_default\_set\_t**

Parameters of Light xyL Default state change event

**Public Members****uint16\_t lightness**

The value of Light Lightness Default state

**uint16\_t x**

The value of Light xyL x Default state

**uint16\_t y**

The value of Light xyL y Default state

struct **esp\_ble\_mesh\_state\_change\_light\_xyl\_range\_set\_t**

Parameters of Light xyL Range state change event

**Public Members****uint16\_t x\_range\_min**

The minimum value of Light xyL x Range state

**uint16\_t x\_range\_max**

The maximum value of Light xyL x Range state

**uint16\_t y\_range\_min**

The minimum value of Light xyL y Range state

**uint16\_t y\_range\_max**

The maximum value of Light xyL y Range state

struct **esp\_ble\_mesh\_state\_change\_light\_lc\_mode\_set\_t**

Parameter of Light LC Mode state change event

**Public Members****uint8\_t mode**

The value of Light LC Mode state

struct **esp\_ble\_mesh\_state\_change\_light\_lc\_om\_set\_t**

Parameter of Light LC Occupancy Mode state change event

**Public Members****uint8\_t mode**

The value of Light LC Occupancy Mode state

struct **esp\_ble\_mesh\_state\_change\_light\_lc\_light\_onoff\_set\_t**

Parameter of Light LC Light OnOff state change event



**Public Members****uint8\_t onoff**

The value of Light LC Light OnOff state

struct **esp\_ble\_mesh\_state\_change\_light\_lc\_property\_set\_t**

Parameters of Light LC Property state change event

**Public Members****uint16\_t property\_id**

The property id of Light LC Property state

struct net\_buf\_simple \***property\_value**

The property value of Light LC Property state

struct **esp\_ble\_mesh\_state\_change\_sensor\_status\_t**

Parameters of Sensor Status state change event

**Public Members****uint16\_t property\_id**

The value of Sensor Property ID

**uint8\_t occupancy**

The value of Light LC Occupancy state

**uint32\_t set\_occupancy\_to\_1\_delay**

The value of Light LC Set Occupancy to 1 Delay state

**uint32\_t ambient\_luxlevel**

The value of Light LC Ambient Luxlevel state

union *esp\_ble\_mesh\_state\_change\_sensor\_status\_t*::[anonymous] **state**

Parameters of Sensor Status related state

struct **esp\_ble\_mesh\_server\_rcv\_light\_lc\_property\_get\_t**

Context of the received Light LC Property Get message

**Public Members****uint16\_t property\_id**

Property ID identifying a Light LC Property

struct **esp\_ble\_mesh\_server\_rcv\_light\_lightness\_set\_t**

Context of the received Light Lightness Set message

**Public Members****bool op\_en**

Indicate if optional parameters are included

**uint16\_t lightness**

Target value of light lightness actual state

**uint8\_t tid**

Transaction ID

**uint8\_t trans\_time**

Time to complete state transition (optional)

**uint8\_t delay**

Indicate message execution delay (C.1)

struct **esp\_ble\_mesh\_server\_rcv\_light\_lightness\_linear\_set\_t**

Context of the received Light Lightness Linear Set message

**Public Members****bool op\_en**

Indicate if optional parameters are included

**uint16\_t lightness**

Target value of light lightness linear state

**uint8\_t tid**

Transaction ID

**uint8\_t trans\_time**

Time to complete state transition (optional)

**uint8\_t delay**

Indicate message execution delay (C.1)

struct **esp\_ble\_mesh\_server\_rcv\_light\_lightness\_default\_set\_t**

Context of the received Light Lightness Default Set message

**Public Members****uint16\_t lightness**

The value of the Light Lightness Default state

struct **esp\_ble\_mesh\_server\_rcv\_light\_lightness\_range\_set\_t**

Context of the received Light Lightness Range Set message

**Public Members****uint16\_t range\_min**

Value of range min field of light lightness range state

**uint16\_t range\_max**

Value of range max field of light lightness range state

struct **esp\_ble\_mesh\_server\_recv\_light\_ctl\_set\_t**

Context of the received Light CTL Set message

**Public Members****bool op\_en**

Indicate if optional parameters are included

**uint16\_t lightness**

Target value of light ctl lightness state

**uint16\_t temperature**

Target value of light ctl temperature state

**int16\_t delta\_uv**

Target value of light ctl delta UV state

**uint8\_t tid**

Transaction ID

**uint8\_t trans\_time**

Time to complete state transition (optional)

**uint8\_t delay**

Indicate message execution delay (C.1)

struct **esp\_ble\_mesh\_server\_recv\_light\_ctl\_temperature\_set\_t**

Context of the received Light CTL Temperature Set message

**Public Members****bool op\_en**

Indicate if optional parameters are included

**uint16\_t temperature**

Target value of light ctl temperature state

**int16\_t delta\_uv**

Target value of light ctl delta UV state

uint8\_t **tid**

Transaction ID

uint8\_t **trans\_time**

Time to complete state transition (optional)

uint8\_t **delay**

Indicate message execution delay (C.1)

struct **esp\_ble\_mesh\_server\_rcv\_light\_ctl\_temperature\_range\_set\_t**

Context of the received Light CTL Temperature Range Set message

### Public Members

uint16\_t **range\_min**

Value of temperature range min field of light ctl temperature range state

uint16\_t **range\_max**

Value of temperature range max field of light ctl temperature range state

struct **esp\_ble\_mesh\_server\_rcv\_light\_ctl\_default\_set\_t**

Context of the received Light CTL Default Set message

### Public Members

uint16\_t **lightness**

Value of light lightness default state

uint16\_t **temperature**

Value of light temperature default state

int16\_t **delta\_uv**

Value of light delta UV default state

struct **esp\_ble\_mesh\_server\_rcv\_light\_hsl\_set\_t**

Context of the received Light HSL Set message

### Public Members

bool **op\_en**

Indicate if optional parameters are included

uint16\_t **lightness**

Target value of light hsl lightness state

`uint16_t hue`

Target value of light hsl hue state

`uint16_t saturation`

Target value of light hsl saturation state

`uint8_t tid`

Transaction ID

`uint8_t trans_time`

Time to complete state transition (optional)

`uint8_t delay`

Indicate message execution delay (C.1)

struct `esp_ble_mesh_server_rcv_light_hsl_hue_set_t`

Context of the received Light HSL Hue Set message

### Public Members

bool `op_en`

Indicate if optional parameters are included

`uint16_t hue`

Target value of light hsl hue state

`uint8_t tid`

Transaction ID

`uint8_t trans_time`

Time to complete state transition (optional)

`uint8_t delay`

Indicate message execution delay (C.1)

struct `esp_ble_mesh_server_rcv_light_hsl_saturation_set_t`

Context of the received Light HSL Saturation Set message

### Public Members

bool `op_en`

Indicate if optional parameters are included

`uint16_t saturation`

Target value of light hsl hue state

`uint8_t tid`

Transaction ID

`uint8_t trans_time`

Time to complete state transition (optional)

`uint8_t delay`

Indicate message execution delay (C.1)

struct `esp_ble_mesh_server_rcv_light_hsl_default_set_t`

Context of the received Light HSL Default Set message

### Public Members

`uint16_t lightness`

Value of light lightness default state

`uint16_t hue`

Value of light hue default state

`uint16_t saturation`

Value of light saturation default state

struct `esp_ble_mesh_server_rcv_light_hsl_range_set_t`

Context of the received Light HSL Range Set message

### Public Members

`uint16_t hue_range_min`

Value of hue range min field of light hsl hue range state

`uint16_t hue_range_max`

Value of hue range max field of light hsl hue range state

`uint16_t saturation_range_min`

Value of saturation range min field of light hsl saturation range state

`uint16_t saturation_range_max`

Value of saturation range max field of light hsl saturation range state

struct `esp_ble_mesh_server_rcv_light_xyl_set_t`

Context of the received Light xyL Set message

### Public Members

bool **op\_en**

Indicate whether optional parameters included

uint16\_t **lightness**

The target value of the Light xyL Lightness state

uint16\_t **x**

The target value of the Light xyL x state

uint16\_t **y**

The target value of the Light xyL y state

uint8\_t **tid**

Transaction Identifier

uint8\_t **trans\_time**

Time to complete state transition (optional)

uint8\_t **delay**

Indicate message execution delay (C.1)

struct **esp\_ble\_mesh\_server\_rcv\_light\_xyl\_default\_set\_t**

Context of the received Light xyL Default Set message

### Public Members

uint16\_t **lightness**

The value of the Light Lightness Default state

uint16\_t **x**

The value of the Light xyL x Default state

uint16\_t **y**

The value of the Light xyL y Default state

struct **esp\_ble\_mesh\_server\_rcv\_light\_xyl\_range\_set\_t**

Context of the received Light xyl Range Set message

### Public Members

uint16\_t **x\_range\_min**

The value of the xyL x Range Min field of the Light xyL x Range state

uint16\_t **x\_range\_max**

The value of the xyL x Range Max field of the Light xyL x Range state

`uint16_t y_range_min`

The value of the xyL y Range Min field of the Light xyL y Range state

`uint16_t y_range_max`

The value of the xyL y Range Max field of the Light xyL y Range state

struct `esp_ble_mesh_server_rcv_light_lc_mode_set_t`

Context of the received Light LC Mode Set message

### Public Members

`uint8_t mode`

The target value of the Light LC Mode state

struct `esp_ble_mesh_server_rcv_light_lc_om_set_t`

Context of the received Light OM Set message

### Public Members

`uint8_t mode`

The target value of the Light LC Occupancy Mode state

struct `esp_ble_mesh_server_rcv_light_lc_light_onoff_set_t`

Context of the received Light LC Light OnOff Set message

### Public Members

bool `op_en`

Indicate whether optional parameters included

`uint8_t light_onoff`

The target value of the Light LC Light OnOff state

`uint8_t tid`

Transaction Identifier

`uint8_t trans_time`

Time to complete state transition (optional)

`uint8_t delay`

Indicate message execution delay (C.1)

struct `esp_ble_mesh_server_rcv_light_lc_property_set_t`

Context of the received Light LC Property Set message



### Public Members

uint16\_t **property\_id**

Property ID identifying a Light LC Property

struct net\_buf\_simple \***property\_value**

Raw value for the Light LC Property

struct **esp\_ble\_mesh\_server\_recv\_sensor\_status\_t**

Context of the received Sensor Status message

### Public Members

struct net\_buf\_simple \***data**

Value of sensor data state (optional)

struct **esp\_ble\_mesh\_lighting\_server\_cb\_param\_t**

Lighting Server Model callback parameters

### Public Members

*esp\_ble\_mesh\_model\_t* \***model**

Pointer to Lighting Server Models

*esp\_ble\_mesh\_msg\_ctx\_t* **ctx**

Context of the received messages

*esp\_ble\_mesh\_lighting\_server\_cb\_value\_t* **value**

Value of the received Lighting Messages

### Macros

**ESP\_BLE\_MESH\_MODEL\_LIGHT\_LIGHTNESS\_CLI** (cli\_pub, cli\_data)

Define a new Light Lightness Client Model.

---

**备注:** This API needs to be called for each element on which the application needs to have a Light Lightness Client Model.

---

#### 参数

- **cli\_pub** -- Pointer to the unique struct *esp\_ble\_mesh\_model\_pub\_t*.
- **cli\_data** -- Pointer to the unique struct *esp\_ble\_mesh\_client\_t*.

**返回** New Light Lightness Client Model instance.

**ESP\_BLE\_MESH\_MODEL\_LIGHT\_CTL\_CLI** (cli\_pub, cli\_data)

Define a new Light CTL Client Model.

---

**备注:** This API needs to be called for each element on which the application needs to have a Light CTL Client Model.

---

**参数**

- **cli\_pub** -- Pointer to the unique struct *esp\_ble\_mesh\_model\_pub\_t*.
- **cli\_data** -- Pointer to the unique struct *esp\_ble\_mesh\_client\_t*.

**返回** New Light CTL Client Model instance.

**ESP\_BLE\_MESH\_MODEL\_LIGHT\_HSL\_CLI** (cli\_pub, cli\_data)

Define a new Light HSL Client Model.

---

**备注:** This API needs to be called for each element on which the application needs to have a Light HSL Client Model.

---

**参数**

- **cli\_pub** -- Pointer to the unique struct *esp\_ble\_mesh\_model\_pub\_t*.
- **cli\_data** -- Pointer to the unique struct *esp\_ble\_mesh\_client\_t*.

**返回** New Light HSL Client Model instance.

**ESP\_BLE\_MESH\_MODEL\_LIGHT\_XYL\_CLI** (cli\_pub, cli\_data)

Define a new Light xyL Client Model.

---

**备注:** This API needs to be called for each element on which the application needs to have a Light xyL Client Model.

---

**参数**

- **cli\_pub** -- Pointer to the unique struct *esp\_ble\_mesh\_model\_pub\_t*.
- **cli\_data** -- Pointer to the unique struct *esp\_ble\_mesh\_client\_t*.

**返回** New Light xyL Client Model instance.

**ESP\_BLE\_MESH\_MODEL\_LIGHT\_LC\_CLI** (cli\_pub, cli\_data)

Define a new Light LC Client Model.

---

**备注:** This API needs to be called for each element on which the application needs to have a Light LC Client Model.

---

**参数**

- **cli\_pub** -- Pointer to the unique struct *esp\_ble\_mesh\_model\_pub\_t*.
- **cli\_data** -- Pointer to the unique struct *esp\_ble\_mesh\_client\_t*.

**返回** New Light LC Client Model instance.

**ESP\_BLE\_MESH\_MODEL\_LIGHT\_LIGHTNESS\_SRV** (srv\_pub, srv\_data)

Lighting Server Models related context.

Define a new Light Lightness Server Model.

---

**备注:** 1. The Light Lightness Server model extends the Generic Power OnOff Server model and the Generic Level Server model. When this model is present on an Element, the corresponding Light Lightness Setup Server model shall also be present.

- a. This model shall support model publication and model subscription.
- 

**参数**

- **srv\_pub** -- Pointer to the unique struct *esp\_ble\_mesh\_model\_pub\_t*.
- **srv\_data** -- Pointer to the unique struct *esp\_ble\_mesh\_light\_lightness\_srv\_t*.

返回 New Light Lightness Server Model instance.

**ESP\_BLE\_MESH\_MODEL\_LIGHT\_LIGHTNESS\_SETUP\_SRV** (srv\_pub, srv\_data)

Define a new Light Lightness Setup Server Model.

---

**备注:** 1. The Light Lightness Setup Server model extends the Light Lightness Server model and the Generic Power OnOff Setup Server model.

- a. This model shall support model subscription.
- 

**参数**

- **srv\_pub** -- Pointer to the unique struct *esp\_ble\_mesh\_model\_pub\_t*.
- **srv\_data** -- Pointer to the unique struct *esp\_ble\_mesh\_light\_lightness\_setup\_srv\_t*.

返回 New Light Lightness Setup Server Model instance.

**ESP\_BLE\_MESH\_MODEL\_LIGHT\_CTL\_SRV** (srv\_pub, srv\_data)

Define a new Light CTL Server Model.

---

**备注:** 1. The Light CTL Server model extends the Light Lightness Server model. When this model is present on an Element, the corresponding Light CTL Temperature Server model and the corresponding Light CTL Setup Server model shall also be present.

- a. This model shall support model publication and model subscription.
  - b. The model requires two elements: the main element and the Temperature element. The Temperature element contains the corresponding Light CTL Temperature Server model and an instance of a Generic Level state bound to the Light CTL Temperature state on the Temperature element. The Light CTL Temperature state on the Temperature element is bound to the Light CTL state on the main element.
- 

**参数**

- **srv\_pub** -- Pointer to the unique struct *esp\_ble\_mesh\_model\_pub\_t*.
- **srv\_data** -- Pointer to the unique struct *esp\_ble\_mesh\_light\_ctl\_srv\_t*.

返回 New Light CTL Server Model instance.

**ESP\_BLE\_MESH\_MODEL\_LIGHT\_CTL\_SETUP\_SRV** (srv\_pub, srv\_data)

Define a new Light CTL Setup Server Model.

---

**备注:** 1. The Light CTL Setup Server model extends the Light CTL Server and the Light Lightness Setup Server.

- a. This model shall support model subscription.
- 

**参数**

- **srv\_pub** -- Pointer to the unique struct *esp\_ble\_mesh\_model\_pub\_t*.
- **srv\_data** -- Pointer to the unique struct *esp\_ble\_mesh\_light\_ctl\_setup\_srv\_t*.

返回 New Light CTL Setup Server Model instance.

**ESP\_BLE\_MESH\_MODEL\_LIGHT\_CTL\_TEMP\_SRV** (srv\_pub, srv\_data)

Define a new Light CTL Temperature Server Model.

---

**备注:** 1. The Light CTL Temperature Server model extends the Generic Level Server model.

- a. This model shall support model publication and model subscription.
-

**参数**

- **srv\_pub** -- Pointer to the unique struct *esp\_ble\_mesh\_model\_pub\_t*.
- **srv\_data** -- Pointer to the unique struct *esp\_ble\_mesh\_light\_ctl\_temp\_srv\_t*.

**返回** New Light CTL Temperature Server Model instance.

**ESP\_BLE\_MESH\_MODEL\_LIGHT\_HSL\_SRV** (srv\_pub, srv\_data)

Define a new Light HSL Server Model.

---

**备注:** 1. The Light HSL Server model extends the Light Lightness Server model. When this model is present on an Element, the corresponding Light HSL Hue Server model and the corresponding Light HSL Saturation Server model and the corresponding Light HSL Setup Server model shall also be present.

- This model shall support model publication and model subscription.
  - The model requires three elements: the main element and the Hue element and the Saturation element. The Hue element contains the corresponding Light HSL Hue Server model and an instance of a Generic Level state bound to the Light HSL Hue state on the Hue element. The Saturation element contains the corresponding Light HSL Saturation Server model and an instance of a Generic Level state bound to the Light HSL Saturation state on the Saturation element. The Light HSL Hue state on the Hue element is bound to the Light HSL state on the main element and the Light HSL Saturation state on the Saturation element is bound to the Light HSL state on the main element.
- 

**参数**

- **srv\_pub** -- Pointer to the unique struct *esp\_ble\_mesh\_model\_pub\_t*.
- **srv\_data** -- Pointer to the unique struct *esp\_ble\_mesh\_light\_hsl\_srv\_t*.

**返回** New Light HSL Server Model instance.

**ESP\_BLE\_MESH\_MODEL\_LIGHT\_HSL\_SETUP\_SRV** (srv\_pub, srv\_data)

Define a new Light HSL Setup Server Model.

---

**备注:** 1. The Light HSL Setup Server model extends the Light HSL Server and the Light Lightness Setup Server.

- This model shall support model subscription.
- 

**参数**

- **srv\_pub** -- Pointer to the unique struct *esp\_ble\_mesh\_model\_pub\_t*.
- **srv\_data** -- Pointer to the unique struct *esp\_ble\_mesh\_light\_hsl\_setup\_srv\_t*.

**返回** New Light HSL Setup Server Model instance.

**ESP\_BLE\_MESH\_MODEL\_LIGHT\_HSL\_HUE\_SRV** (srv\_pub, srv\_data)

Define a new Light HSL Hue Server Model.

---

**备注:** 1. The Light HSL Hue Server model extends the Generic Level Server model. This model is associated with the Light HSL Server model.

- This model shall support model publication and model subscription.
- 

**参数**

- **srv\_pub** -- Pointer to the unique struct *esp\_ble\_mesh\_model\_pub\_t*.
- **srv\_data** -- Pointer to the unique struct *esp\_ble\_mesh\_light\_hsl\_hue\_srv\_t*.

**返回** New Light HSL Hue Server Model instance.

**ESP\_BLE\_MESH\_MODEL\_LIGHT\_HSL\_SAT\_SRV** (srv\_pub, srv\_data)

Define a new Light HSL Saturation Server Model.

---

**备注:** 1. The Light HSL Saturation Server model extends the Generic Level Server model. This model is associated with the Light HSL Server model.

- a. This model shall support model publication and model subscription.
- 

**参数**

- **srv\_pub** -- Pointer to the unique struct *esp\_ble\_mesh\_model\_pub\_t*.
- **srv\_data** -- Pointer to the unique struct *esp\_ble\_mesh\_light\_hsl\_sat\_srv\_t*.

**返回** New Light HSL Saturation Server Model instance.

**ESP\_BLE\_MESH\_MODEL\_LIGHT\_XYL\_SRV** (srv\_pub, srv\_data)

Define a new Light xyL Server Model.

---

**备注:** 1. The Light xyL Server model extends the Light Lightness Server model. When this model is present on an Element, the corresponding Light xyL Setup Server model shall also be present.

- a. This model shall support model publication and model subscription.
- 

**参数**

- **srv\_pub** -- Pointer to the unique struct *esp\_ble\_mesh\_model\_pub\_t*.
- **srv\_data** -- Pointer to the unique struct *esp\_ble\_mesh\_light\_xyl\_srv\_t*.

**返回** New Light xyL Server Model instance.

**ESP\_BLE\_MESH\_MODEL\_LIGHT\_XYL\_SETUP\_SRV** (srv\_pub, srv\_data)

Define a new Light xyL Setup Server Model.

---

**备注:** 1. The Light xyL Setup Server model extends the Light xyL Server and the Light Lightness Setup Server.

- a. This model shall support model subscription.
- 

**参数**

- **srv\_pub** -- Pointer to the unique struct *esp\_ble\_mesh\_model\_pub\_t*.
- **srv\_data** -- Pointer to the unique struct *esp\_ble\_mesh\_light\_xyl\_setup\_srv\_t*.

**返回** New Light xyL Setup Server Model instance.

**ESP\_BLE\_MESH\_MODEL\_LIGHT\_LC\_SRV** (srv\_pub, srv\_data)

Define a new Light LC Server Model.

---

**备注:** 1. The Light LC (Lightness Control) Server model extends the Light Lightness Server model and the Generic OnOff Server model. When this model is present on an Element, the corresponding Light LC Setup Server model shall also be present.

- a. This model shall support model publication and model subscription.
  - b. This model may be used to represent an element that is a client to a Sensor Server model and controls the Light Lightness Actual state via defined state bindings.
- 

**参数**

- **srv\_pub** -- Pointer to the unique struct *esp\_ble\_mesh\_model\_pub\_t*.
- **srv\_data** -- Pointer to the unique struct *esp\_ble\_mesh\_light\_lc\_srv\_t*.

返回 New Light LC Server Model instance.

**ESP\_BLE\_MESH\_MODEL\_LIGHT\_LC\_SETUP\_SRV** (srv\_pub, srv\_data)

Define a new Light LC Setup Server Model.

---

**备注:** 1. The Light LC (Lightness Control) Setup model extends the Light LC Server model.

- a. This model shall support model publication and model subscription.
  - b. This model may be used to configure setup parameters for the Light LC Server model.
- 

#### 参数

- **srv\_pub** -- Pointer to the unique struct *esp\_ble\_mesh\_model\_pub\_t*.
- **srv\_data** -- Pointer to the unique struct *esp\_ble\_mesh\_light\_lc\_setup\_srv\_t*.

返回 New Light LC Setup Server Model instance.

### Type Definitions

```
typedef void (*esp_ble_mesh_light_client_cb_t)(esp_ble_mesh_light_client_cb_event_t event,
esp_ble_mesh_light_client_cb_param_t *param)
```

Bluetooth Mesh Light Client Model function.

Lighting Client Model callback function type

**Param event** Event type

**Param param** Pointer to callback parameter

```
typedef void (*esp_ble_mesh_lighting_server_cb_t)(esp_ble_mesh_lighting_server_cb_event_t event,
esp_ble_mesh_lighting_server_cb_param_t *param)
```

Bluetooth Mesh Lighting Server Model function.

Lighting Server Model callback function type

**Param event** Event type

**Param param** Pointer to callback parameter

### Enumerations

```
enum esp_ble_mesh_light_client_cb_event_t
```

This enum value is the event of Lighting Client Model

*Values:*

enumerator **ESP\_BLE\_MESH\_LIGHT\_CLIENT\_GET\_STATE\_EVT**

enumerator **ESP\_BLE\_MESH\_LIGHT\_CLIENT\_SET\_STATE\_EVT**

enumerator **ESP\_BLE\_MESH\_LIGHT\_CLIENT\_PUBLISH\_EVT**

enumerator **ESP\_BLE\_MESH\_LIGHT\_CLIENT\_TIMEOUT\_EVT**

enumerator **ESP\_BLE\_MESH\_LIGHT\_CLIENT\_EVT\_MAX**

```
enum esp_ble_mesh_lc_state_t
```

This enum value is the Light LC State Machine states

*Values:*

enumerator **ESP\_BLE\_MESH\_LC\_OFF**

enumerator **ESP\_BLE\_MESH\_LC\_STANDBY**

enumerator **ESP\_BLE\_MESH\_LC\_FADE\_ON**

enumerator **ESP\_BLE\_MESH\_LC\_RUN**

enumerator **ESP\_BLE\_MESH\_LC\_FADE**

enumerator **ESP\_BLE\_MESH\_LC\_PROLONG**

enumerator **ESP\_BLE\_MESH\_LC\_FADE\_STANDBY\_AUTO**

enumerator **ESP\_BLE\_MESH\_LC\_FADE\_STANDBY\_MANUAL**

enum **esp\_ble\_mesh\_lighting\_server\_cb\_event\_t**

This enum value is the event of Lighting Server Model

*Values:*

enumerator **ESP\_BLE\_MESH\_LIGHTING\_SERVER\_STATE\_CHANGE\_EVT**

- i. When `get_auto_rsp` is set to `ESP_BLE_MESH_SERVER_AUTO_RSP`, no event will be callback to the application layer when Lighting Get messages are received.
- ii. When `set_auto_rsp` is set to `ESP_BLE_MESH_SERVER_AUTO_RSP`, this event will be callback to the application layer when Lighting Set/Set Unack messages are received.

enumerator **ESP\_BLE\_MESH\_LIGHTING\_SERVER\_RECV\_GET\_MSG\_EVT**

When `get_auto_rsp` is set to `ESP_BLE_MESH_SERVER_RSP_BY_APP`, this event will be callback to the application layer when Lighting Get messages are received.

enumerator **ESP\_BLE\_MESH\_LIGHTING\_SERVER\_RECV\_SET\_MSG\_EVT**

When `set_auto_rsp` is set to `ESP_BLE_MESH_SERVER_RSP_BY_APP`, this event will be callback to the application layer when Lighting Set/Set Unack messages are received.

enumerator **ESP\_BLE\_MESH\_LIGHTING\_SERVER\_RECV\_STATUS\_MSG\_EVT**

When `status_auto_rsp` is set to `ESP_BLE_MESH_SERVER_RSP_BY_APP`, this event will be callback to the application layer when Sensor Status message is received.

enumerator **ESP\_BLE\_MESH\_LIGHTING\_SERVER\_EVT\_MAX**

## ESP-BLE-MESH (v1.1) Core API Reference

---

**备注:** This section is a preview version, so the related structures, macros, and APIs may be changed.

---

This section contains ESP-BLE-MESH v1.1 Core related APIs, event types, event parameters, etc.

This API reference covers 10 components:

- *Remote Provisioning*
- *Directed Forwarding*
- *Subnet Bridge Configuration*
- *Mesh Private Beacon*
- *On-Demand Private Proxy*
- *SAR Configuration*
- *Solicitation PDU RPL Configuration*
- *Opcodes Aggregator*
- *Large Composition Data*
- *Composition and Metadata*

## Remote Provisioning

### Header File

- `components/bt/esp_ble_mesh/v1.1/api/core/include/esp_ble_mesh_rpr_model_api.h`
- This header file can be included with:

```
#include "esp_ble_mesh_rpr_model_api.h"
```

- This header file is a part of the API provided by the `bt` component. To declare that your component depends on `bt`, add the following to your `CMakeLists.txt`:

```
REQUIRES bt
```

or

```
PRIV_REQUIRES bt
```

### Functions

`esp_err_t esp_ble_mesh_register_rpr_client_callback` (`esp_ble_mesh_rpr_client_cb_t` callback)

Register BLE Mesh Remote Provisioning Client model callback.

**参数** `callback` -- **[in]** Pointer to the callback function.

**返回** `ESP_OK` on success or error code otherwise.

`esp_err_t esp_ble_mesh_rpr_client_send` (`esp_ble_mesh_client_common_param_t` \*params, `esp_ble_mesh_rpr_client_msg_t` \*msg)

Get the value of Remote Provisioning Server model state with the corresponding get message.

**参数**

- `params` -- **[in]** Pointer to BLE Mesh common client parameters.
- `msg` -- **[in]** Pointer to Remote Provisioning Client message.

**返回** `ESP_OK` on success or error code otherwise.

`esp_err_t esp_ble_mesh_rpr_client_action` (`esp_ble_mesh_rpr_client_act_type_t` type, `esp_ble_mesh_rpr_client_act_param_t` \*param)

Remote Provisioning Client model perform related actions, e.g. start remote provisioning.

**参数**

- `type` -- **[in]** Type of the action to be performed.
- `param` -- **[in]** Parameters of the action to be performed.

**返回** `ESP_OK` on success or error code otherwise.

`esp_err_t esp_ble_mesh_register_rpr_server_callback` (`esp_ble_mesh_rpr_server_cb_t` callback)

Register BLE Mesh Remote Provisioning Server model callback.

**参数** `callback` -- **[in]** Pointer to the callback function.

**返回** `ESP_OK` on success or error code otherwise.



## Unions

union **esp\_ble\_mesh\_rpr\_client\_msg\_t**

*#include <esp\_ble\_mesh\_rpr\_model\_api.h>* Remote Provisioning Client model message union.

### Public Members

*esp\_ble\_mesh\_rpr\_scan\_start\_t* **scan\_start**

For ESP\_BLE\_MESH\_MODEL\_OP\_RPR\_SCAN\_START

*esp\_ble\_mesh\_rpr\_ext\_scan\_start\_t* **ext\_scan\_start**

For ESP\_BLE\_MESH\_MODEL\_OP\_RPR\_EXT\_SCAN\_START

*esp\_ble\_mesh\_rpr\_link\_open\_t* **link\_open**

For ESP\_BLE\_MESH\_MODEL\_OP\_RPR\_LINK\_OPEN

*esp\_ble\_mesh\_rpr\_link\_close\_t* **link\_close**

For ESP\_BLE\_MESH\_MODEL\_OP\_RPR\_LINK\_CLOSE

union **esp\_ble\_mesh\_rpr\_client\_act\_param\_t**

*#include <esp\_ble\_mesh\_rpr\_model\_api.h>* Remote Provisioning Client model action union.

### Public Members

*esp\_ble\_mesh\_rpr\_client\_start\_rpr\_t* **start\_rpr**

Start remote provisioning

union **esp\_ble\_mesh\_rpr\_client\_recv\_cb\_t**

*#include <esp\_ble\_mesh\_rpr\_model\_api.h>* Remote Provisioning Client model received message union.

### Public Members

*esp\_ble\_mesh\_rpr\_scan\_caps\_status\_t* **scan\_caps\_status**

For ESP\_BLE\_MESH\_MODEL\_OP\_RPR\_SCAN\_CAPS\_STATUS

*esp\_ble\_mesh\_rpr\_scan\_status\_t* **scan\_status**

For ESP\_BLE\_MESH\_MODEL\_OP\_RPR\_SCAN\_STATUS

*esp\_ble\_mesh\_rpr\_scan\_report\_t* **scan\_report**

For ESP\_BLE\_MESH\_MODEL\_OP\_RPR\_SCAN\_REPORT

*esp\_ble\_mesh\_rpr\_ext\_scan\_report\_t* **ext\_scan\_report**

For ESP\_BLE\_MESH\_MODEL\_OP\_RPR\_EXT\_SCAN\_REPORT

*esp\_ble\_mesh\_rpr\_link\_status\_t* **link\_status**

For ESP\_BLE\_MESH\_MODEL\_OP\_RPR\_LINK\_STATUS

*esp\_ble\_mesh\_rpr\_link\_report\_t* **link\_report**

For ESP\_BLE\_MESH\_MODEL\_OP\_RPR\_LINK\_REPORT

union **esp\_ble\_mesh\_rpr\_client\_cb\_param\_t**

#include <esp\_ble\_mesh\_rpr\_model\_api.h> Remote Provisioning Client model callback parameters

### Public Members

int **err\_code**

Result of sending a message

Result of starting remote provisioning

*esp\_ble\_mesh\_client\_common\_param\_t* \***params**

Client common parameters

struct *esp\_ble\_mesh\_rpr\_client\_cb\_param\_t*::[anonymous] **send**

Event parameters of sending messages Event parameters of sending messages

*esp\_ble\_mesh\_rpr\_client\_rcv\_cb\_t* **val**

Parameters of received status message

struct *esp\_ble\_mesh\_rpr\_client\_cb\_param\_t*::[anonymous] **rcv**

Event parameters of receiving messages Event parameters of receiving messages

*esp\_ble\_mesh\_rpr\_client\_act\_evt\_t* **sub\_evt**

Event type of the performed action

*esp\_ble\_mesh\_model\_t* \***model**

Pointer of Remote Provisioning Client

uint16\_t **rpr\_srv\_addr**

Unicast address of Remote Provisioning Server

struct *esp\_ble\_mesh\_rpr\_client\_cb\_param\_t*::[anonymous]::[anonymous] **start\_rpr\_comp**

ESP\_BLE\_MESH\_START\_RPR\_COMP\_SUB\_EVT.

Event parameter of ESP\_BLE\_MESH\_START\_RPR\_COMP\_SUB\_EVT

struct *esp\_ble\_mesh\_rpr\_client\_cb\_param\_t*::[anonymous] **act**

Event parameters of performed actions Event parameters of performed actions

struct *esp\_ble\_mesh\_rpr\_client\_cb\_param\_t*::[anonymous] **link\_open**

ESP\_BLE\_MESH\_RPR\_CLIENT\_LINK\_OPEN\_EVT.

Event parameters of ESP\_BLE\_MESH\_RPR\_CLIENT\_LINK\_OPEN\_EVT

uint8\_t **reason**

Reason of closing provisioning link

struct *esp\_ble\_mesh\_rpr\_client\_cb\_param\_t*::[anonymous] **link\_close**  
ESP\_BLE\_MESH\_RPR\_CLIENT\_LINK\_CLOSE\_EVT.  
Event parameters of ESP\_BLE\_MESH\_RPR\_CLIENT\_LINK\_CLOSE\_EVT

uint8\_t **npqi**  
NPPI Procedure

uint16\_t **index**  
Index of the provisioned node

uint8\_t **uuid**[16]  
Device UUID

uint16\_t **unicast\_addr**  
Primary element address

uint8\_t **element\_num**  
Element number

uint16\_t **net\_idx**  
NetKey Index

struct *esp\_ble\_mesh\_rpr\_client\_cb\_param\_t*::[anonymous] **prov**  
ESP\_BLE\_MESH\_RPR\_CLIENT\_PROV\_COMP\_EVT.  
Event parameters of ESP\_BLE\_MESH\_RPR\_CLIENT\_PROV\_COMP\_EVT

union **esp\_ble\_mesh\_rpr\_server\_cb\_param\_t**  
*#include <esp\_ble\_mesh\_rpr\_model\_api.h>* Remote Provisioning Server model related context.  
Remote Provisioning Server model callback value union

### Public Members

*esp\_ble\_mesh\_model\_t* \***model**  
Pointer to the server model structure

uint8\_t **scan\_items\_limit**  
Maximum number of scanned items to be reported

uint8\_t **timeout**  
Time limit for a scan (in seconds)  
Time limit for extended scan (in seconds)  
Time limit for opening a link (in seconds)

uint8\_t **uuid**[16]  
Device UUID (All ZERO if not present)  
Device UUID (ZERO if not present)

uint16\_t **net\_idx**

NetKey Index used by Remote Provisioning Client

uint16\_t **rpr\_cli\_addr**

Unicast address of Remote Provisioning Client

struct *esp\_ble\_mesh\_rpr\_server\_cb\_param\_t*::[anonymous] **scan\_start**  
ESP\_BLE\_MESH\_RPR\_SERVER\_SCAN\_START\_EVT.

struct *esp\_ble\_mesh\_rpr\_server\_cb\_param\_t*::[anonymous] **scan\_stop**  
ESP\_BLE\_MESH\_RPR\_SERVER\_SCAN\_STOP\_EVT.

uint8\_t **ad\_type\_filter\_count**

Number of AD Types in the ADTypeFilter field

uint8\_t \***ad\_type\_filter**

List of AD Types to be reported

uint8\_t **index**

Index of the extended scan instance

struct *esp\_ble\_mesh\_rpr\_server\_cb\_param\_t*::[anonymous] **ext\_scan\_start**  
ESP\_BLE\_MESH\_RPR\_SERVER\_EXT\_SCAN\_START\_EVT.

struct *esp\_ble\_mesh\_rpr\_server\_cb\_param\_t*::[anonymous] **ext\_scan\_stop**  
ESP\_BLE\_MESH\_RPR\_SERVER\_EXT\_SCAN\_STOP\_EVT.

uint8\_t **status**

Status of Link Open procedure

uint8\_t **nppi**

Node Provisioning Protocol Interface

Provisioning bearer link close reason code

struct *esp\_ble\_mesh\_rpr\_server\_cb\_param\_t*::[anonymous] **link\_open**  
ESP\_BLE\_MESH\_RPR\_SERVER\_LINK\_OPEN\_EVT.

bool **close\_by\_device**

Indicate if the link is closed by the Unprovisioned Device

uint8\_t **reason**

Provisioning bearer link close reason code

struct *esp\_ble\_mesh\_rpr\_server\_cb\_param\_t*::[anonymous] **link\_close**  
ESP\_BLE\_MESH\_RPR\_SERVER\_LINK\_CLOSE\_EVT.

struct *esp\_ble\_mesh\_rpr\_server\_cb\_param\_t*::[anonymous] **prov\_comp**  
ESP\_BLE\_MESH\_RPR\_SERVER\_PROV\_COMP\_EVT. TODO: Duplicate with Link Close event?

## Structures

struct **esp\_ble\_mesh\_rpr\_scan\_start\_t**

Remote Provisioning Server model context Parameters of Remote Provisioning Scan Start

### Public Members

uint8\_t **scan\_items\_limit**

Maximum number of scanned items to be reported

uint8\_t **timeout**

Time limit for a scan (in seconds)

bool **uuid\_en**

Indicate if Device UUID is present

uint8\_t **uuid**[16]

Device UUID (Optional)

struct **esp\_ble\_mesh\_rpr\_ext\_scan\_start\_t**

Parameters of Remote Provisioning Extended Scan Start

### Public Members

uint8\_t **ad\_type\_filter\_count**

Number of AD Types in the ADTypeFilter field

uint8\_t **ad\_type\_filter**[16]

List of AD Types to be reported. Minimum is 1, maximum is 16

bool **uuid\_en**

Indicate if Device UUID is present

uint8\_t **uuid**[16]

Device UUID (Optional)

uint8\_t **timeout**

Time limit for a scan (in seconds) (C.1)

struct **esp\_ble\_mesh\_rpr\_link\_open\_t**

Parameters of Remote Provisioning Link Open

### Public Members

bool **uuid\_en**

Indicate if Device UUID is present

uint8\_t **uuid**[16]  
Device UUID (Optional)

bool **timeout\_en**  
Indicate if Link open timeout is present

uint8\_t **timeout**  
Link open timeout in seconds (C.1)

uint8\_t **nppi**  
Node Provisioning Protocol Interface (C.2)

struct **esp\_ble\_mesh\_rpr\_link\_close\_t**  
Parameters of Remote Provisioning Link Close

### Public Members

uint8\_t **reason**  
Provisioning bearer link close reason code

struct **esp\_ble\_mesh\_rpr\_client\_start\_rpr\_t**  
Parameters of starting remote provisioning

### Public Members

*esp\_ble\_mesh\_model\_t* \***model**  
Pointer of Remote Provisioning Client

uint16\_t **rpr\_srv\_addr**  
Unicast address of Remote Provisioning Server

struct **esp\_ble\_mesh\_rpr\_scan\_caps\_status\_t**  
Parameters of Remote Provisioning Scan Capabilities Status

### Public Members

uint8\_t **max\_scan\_items**  
The maximum number of UUIDs that can be reported during scanning

uint8\_t **active\_scan**  
Indication if active scan is supported

struct **esp\_ble\_mesh\_rpr\_scan\_status\_t**  
Parameters of Remote Provisioning Scan Status

**Public Members****uint8\_t status**

Status for the requesting message

**uint8\_t rpr\_scanning**

The Remote Provisioning Scan state value

**uint8\_t scan\_items\_limit**

Maximum number of scanned items to be reported

**uint8\_t timeout**

Time limit for a scan (in seconds)

struct **esp\_ble\_mesh\_rpr\_scan\_report\_t**

Parameters of Remote Provisioning Scan Report

**Public Members****int8\_t rssi**

An indication of received signal strength measured in dBm

**uint8\_t uuid[16]**

Device UUID

**uint16\_t oob\_info**

OOB information

**uint32\_t uri\_hash**

URI Hash (Optional)

struct **esp\_ble\_mesh\_rpr\_ext\_scan\_report\_t**

Parameters of Remote Provisioning Extended Scan Report

**Public Members****uint8\_t status**

Status for the requesting message

**uint8\_t uuid[16]**

Device UUID

**bool oob\_info\_en**

Indicate if OOB Information is present

**uint16\_t oob\_info**

OOB Information (Optional)

struct net\_buf\_simple \***adv\_structures**

Concatenated list of AD Structures (C.1)

struct **esp\_ble\_mesh\_rpr\_link\_status\_t**

Parameters of Remote Provisioning Link Status

### Public Members

uint8\_t **status**

Status for the requesting message

uint8\_t **rpr\_state**

Remote Provisioning Link state

struct **esp\_ble\_mesh\_rpr\_link\_report\_t**

Parameters of Remote Provisioning Link Report

### Public Members

uint8\_t **status**

Status of the provisioning bearer or the NPPI

uint8\_t **rpr\_state**

Remote Provisioning Link state

bool **reason\_en**

Indicate if Link close Reason code is present

uint8\_t **reason**

Link close Reason code (Optional)

### Macros

**ESP\_BLE\_MESH\_MODEL\_OP\_RPR\_SCAN\_CAPS\_GET**

**ESP\_BLE\_MESH\_MODEL\_OP\_RPR\_SCAN\_CAPS\_STATUS**

**ESP\_BLE\_MESH\_MODEL\_OP\_RPR\_SCAN\_GET**

**ESP\_BLE\_MESH\_MODEL\_OP\_RPR\_SCAN\_START**

**ESP\_BLE\_MESH\_MODEL\_OP\_RPR\_SCAN\_STOP**

**ESP\_BLE\_MESH\_MODEL\_OP\_RPR\_SCAN\_STATUS**

**ESP\_BLE\_MESH\_MODEL\_OP\_RPR\_SCAN\_REPORT**



ESP\_BLE\_MESH\_MODEL\_OP\_RPR\_EXT\_SCAN\_START

ESP\_BLE\_MESH\_MODEL\_OP\_RPR\_EXT\_SCAN\_REPORT

ESP\_BLE\_MESH\_MODEL\_OP\_RPR\_LINK\_GET

ESP\_BLE\_MESH\_MODEL\_OP\_RPR\_LINK\_OPEN

ESP\_BLE\_MESH\_MODEL\_OP\_RPR\_LINK\_CLOSE

ESP\_BLE\_MESH\_MODEL\_OP\_RPR\_LINK\_STATUS

ESP\_BLE\_MESH\_MODEL\_OP\_RPR\_LINK\_REPORT

ESP\_BLE\_MESH\_MODEL\_OP\_RPR\_PDU\_SEND

ESP\_BLE\_MESH\_MODEL\_OP\_RPR\_PDU\_OUTBOUND\_REPORT

ESP\_BLE\_MESH\_MODEL\_OP\_RPR\_PDU\_REPORT

ESP\_BLE\_MESH\_RPR\_SRV\_MAX\_SCANNED\_ITEMS\_MIN

ESP\_BLE\_MESH\_RPR\_NOT\_SUPPORT\_ACTIVE\_SCAN

ESP\_BLE\_MESH\_RPR\_SUPPORT\_ACTIVE\_SCAN

ESP\_BLE\_MESH\_RPR\_SCAN\_IDLE

ESP\_BLE\_MESH\_RPR\_SCAN\_MULTIPLE\_DEVICE

ESP\_BLE\_MESH\_RPR\_SCAN\_SINGLE\_DEVICE

ESP\_BLE\_MESH\_RPR\_SCAN\_NOT\_IN\_PROGRESS

ESP\_BLE\_MESH\_RPR\_PROHIBIT\_SCAN\_TIMEOUT

ESP\_BLE\_MESH\_RPR\_EXT\_SCAN\_TIMEOUT\_MIN

ESP\_BLE\_MESH\_RPR\_EXT\_SCAN\_TIMEOUT\_MAX

ESP\_BLE\_MESH\_RPR\_AD\_TYPE\_FILTER\_CNT\_MIN

ESP\_BLE\_MESH\_RPR\_AD\_TYPE\_FILTER\_CNT\_MAX

ESP\_BLE\_MESH\_RPR\_LINK\_OPEN\_TIMEOUT\_MIN

ESP\_BLE\_MESH\_RPR\_LINK\_OPEN\_TIMEOUT\_MAX

ESP\_BLE\_MESH\_RPR\_LINK\_TIMEOUT\_DEFAULT

ESP\_BLE\_MESH\_RPR\_REASON\_SUCCESS

ESP\_BLE\_MESH\_RPR\_REASON\_FAIL

ESP\_BLE\_MESH\_RPR\_LINK\_IDLE

ESP\_BLE\_MESH\_RPR\_LINK\_OPENING

ESP\_BLE\_MESH\_RPR\_LINK\_ACTIVE

ESP\_BLE\_MESH\_RPR\_OUTBOUND\_PACKET\_TRANSFER

ESP\_BLE\_MESH\_RPR\_LINK\_CLOSING

ESP\_BLE\_MESH\_RPR\_STATUS\_SUCCESS

ESP\_BLE\_MESH\_RPR\_STATUS\_SCANNING\_CANNOT\_START

ESP\_BLE\_MESH\_RPR\_STATUS\_INVALID\_STATE

ESP\_BLE\_MESH\_RPR\_STATUS\_LIMITED\_RESOURCES

ESP\_BLE\_MESH\_RPR\_STATUS\_LINK\_CANNOT\_OPEN

ESP\_BLE\_MESH\_RPR\_STATUS\_LINK\_OPEN\_FAILED

ESP\_BLE\_MESH\_RPR\_STATUS\_LINK\_CLOSED\_BY\_DEVICE

ESP\_BLE\_MESH\_RPR\_STATUS\_LINK\_CLOSED\_BY\_SERVER

ESP\_BLE\_MESH\_RPR\_STATUS\_LINK\_CLOSED\_BY\_CLIENT

ESP\_BLE\_MESH\_RPR\_STATUS\_LINK\_CLOSED\_AS\_CANNOT\_RECEIVE\_PDU

ESP\_BLE\_MESH\_RPR\_STATUS\_LINK\_CLOSED\_AS\_CANNOT\_SEND\_PDU

ESP\_BLE\_MESH\_RPR\_STATUS\_LINK\_CLOSED\_AS\_CANNOT\_DELIVER\_PDU\_REPORT

**ESP\_BLE\_MESH\_MODEL\_RPR\_SRV** (srv\_data)

Define a new Remote Provisioning Server model.

---

**备注:** If supported, the model shall be supported by a primary element and may be supported by any secondary element.

---

**参数**

- **srv\_data** -- Pointer to a unique Remote Provisioning Server model user\_data.

**返回** New Remote Provisioning Server model instance.

**ESP\_BLE\_MESH\_MODEL\_RPR\_CLI** (cli\_data)

Define a new Remote Provisioning Client model.

---

**备注:** If supported, the model shall be supported by a primary element and may be supported by any secondary element.

---

**参数**

- **cli\_data** -- Pointer to a unique Remote Provisioning Client model user\_data.

**返回** New Remote Provisioning Client model instance.

**Type Definitions**

```
typedef void (*esp_ble_mesh_rpr_client_cb_t)(esp_ble_mesh_rpr_client_cb_event_t event,  
esp_ble_mesh_rpr_client_cb_param_t *param)
```

Remote Provisioning client and server model functions.

Remote Provisioning Client model callback function type

**Param event** Event type

**Param param** Pointer to callback parameter

```
typedef void (*esp_ble_mesh_rpr_server_cb_t)(esp_ble_mesh_rpr_server_cb_event_t event,  
esp_ble_mesh_rpr_server_cb_param_t *param)
```

Remote Provisioning Server model callback function type.

**Param event** Event type

**Param param** Pointer to callback parameter

**Enumerations**

```
enum esp_ble_mesh_rpr_client_act_type_t
```

This enum value is the action of Remote Provisioning Client model

*Values:*

enumerator **ESP\_BLE\_MESH\_RPR\_CLIENT\_ACT\_START\_RPR**

enumerator **ESP\_BLE\_MESH\_RPR\_CLIENT\_ACT\_MAX**

```
enum esp_ble_mesh_rpr_client_act_evt_t
```

This enum value is the event type of the performed action

*Values:*

enumerator **ESP\_BLE\_MESH\_START\_RPR\_COMP\_SUB\_EVT**

enum **esp\_ble\_mesh\_rpr\_client\_cb\_event\_t**

This enum value is the event of Remote Provisioning Client model

*Values:*

enumerator **ESP\_BLE\_MESH\_RPR\_CLIENT\_SEND\_COMP\_EVT**

enumerator **ESP\_BLE\_MESH\_RPR\_CLIENT\_SEND\_TIMEOUT\_EVT**

enumerator **ESP\_BLE\_MESH\_RPR\_CLIENT\_RECV\_RSP\_EVT**

enumerator **ESP\_BLE\_MESH\_RPR\_CLIENT\_RECV\_PUB\_EVT**

enumerator **ESP\_BLE\_MESH\_RPR\_CLIENT\_ACT\_COMP\_EVT**

enumerator **ESP\_BLE\_MESH\_RPR\_CLIENT\_LINK\_OPEN\_EVT**

enumerator **ESP\_BLE\_MESH\_RPR\_CLIENT\_LINK\_CLOSE\_EVT**

enumerator **ESP\_BLE\_MESH\_RPR\_CLIENT\_PROV\_COMP\_EVT**

enumerator **ESP\_BLE\_MESH\_RPR\_CLIENT\_EVT\_MAX**

enum **esp\_ble\_mesh\_rpr\_server\_cb\_event\_t**

This enum value is the event of Remote Provisioning Server model

*Values:*

enumerator **ESP\_BLE\_MESH\_RPR\_SERVER\_SCAN\_START\_EVT**

enumerator **ESP\_BLE\_MESH\_RPR\_SERVER\_SCAN\_STOP\_EVT**

enumerator **ESP\_BLE\_MESH\_RPR\_SERVER\_EXT\_SCAN\_START\_EVT**

enumerator **ESP\_BLE\_MESH\_RPR\_SERVER\_EXT\_SCAN\_STOP\_EVT**

enumerator **ESP\_BLE\_MESH\_RPR\_SERVER\_LINK\_OPEN\_EVT**

enumerator **ESP\_BLE\_MESH\_RPR\_SERVER\_LINK\_CLOSE\_EVT**

enumerator **ESP\_BLE\_MESH\_RPR\_SERVER\_PROV\_COMP\_EVT**

enumerator **ESP\_BLE\_MESH\_RPR\_SERVER\_EVT\_MAX**

## Directed Forwarding

## Header File

- `components/bt/esp_ble_mesh/v1.1/api/core/include/esp_ble_mesh_df_model_api.h`
- This header file can be included with:

```
#include "esp_ble_mesh_df_model_api.h"
```

- This header file is a part of the API provided by the `bt` component. To declare that your component depends on `bt`, add the following to your `CMakeLists.txt`:

```
REQUIRES bt
```

or

```
PRIV_REQUIRES bt
```

## Functions

`esp_err_t esp_ble_mesh_register_df_client_callback` (`esp_ble_mesh_df_client_cb_t` callback)

Register BLE Mesh Directed Forwarding Configuration Client model callback.

参数 **callback** -- [in] Pointer to the callback function.

返回 ESP\_OK on success or error code otherwise.

`esp_err_t esp_ble_mesh_register_df_server_callback` (`esp_ble_mesh_df_server_cb_t` callback)

Register BLE Mesh Directed Forwarding Configuration Server model callback.

参数 **callback** -- [in] Pointer to the callback function.

返回 ESP\_OK on success or error code otherwise.

`esp_err_t esp_ble_mesh_df_client_get_state` (`esp_ble_mesh_client_common_param_t` \*params, `esp_ble_mesh_df_client_get_t` \*get)

Get the value of Directed Forwarding Configuration Server model state with the corresponding get message.

参数

- **params** -- [in] Pointer to BLE Mesh common client parameters.
- **get** -- [in] Pointer to a union, each kind of opcode corresponds to one structure inside.

返回 ESP\_OK on success or error code otherwise.

`esp_err_t esp_ble_mesh_df_client_set_state` (`esp_ble_mesh_client_common_param_t` \*params, `esp_ble_mesh_df_client_set_t` \*set)

Set the value of Directed Forwarding Configuration Server model state with the corresponding set message.

参数

- **params** -- [in] Pointer to BLE Mesh common client parameters.
- **set** -- [in] Pointer to a union, each kind of opcode corresponds to one structure inside.

返回 ESP\_OK on success or error code otherwise.

## Unions

union `esp_ble_mesh_df_client_get_t`

`#include <esp_ble_mesh_df_model_api.h>` Directed Forwarding Configuration Client model get message union.

## Public Members

`esp_ble_mesh_directed_control_get_t directed_control_get`

For `ESP_BLE_MESH_MODEL_OP_DIRECTED_CONTROL_GET`

*esp\_ble\_mesh\_path\_metric\_get\_t* **path\_metric\_get**

For ESP\_BLE\_MESH\_MODEL\_OP\_PATH\_METRIC\_GET

*esp\_ble\_mesh\_discovery\_table\_caps\_get\_t* **disc\_table\_caps\_get**

For ESP\_BLE\_MESH\_MODEL\_OP\_DISCOVERY\_TABLE\_CAPS\_GET

*esp\_ble\_mesh\_forwarding\_table\_entries\_cnt\_get\_t* **forwarding\_table\_entries\_cnt\_get**

For ESP\_BLE\_MESH\_MODEL\_OP\_FORWARDING\_TABLE\_ENTRIES\_CNT\_GET

*esp\_ble\_mesh\_forwarding\_table\_entries\_get\_t* **forwarding\_table\_entries\_get**

For ESP\_BLE\_MESH\_MODEL\_OP\_FORWARDING\_TABLE\_ENTRIES\_GET

*esp\_ble\_mesh\_forwarding\_table\_deps\_get\_t* **forwarding\_table\_deps\_get**

For ESP\_BLE\_MESH\_MODEL\_OP\_FORWARDING\_TABLE\_DEPS\_GET

*esp\_ble\_mesh\_wanted\_lanes\_get\_t* **wanted\_lanes\_get**

For ESP\_BLE\_MESH\_MODEL\_OP\_WANTED\_LANES\_GET

*esp\_ble\_mesh\_two\_way\_path\_get\_t* **two\_way\_path\_get**

For ESP\_BLE\_MESH\_MODEL\_OP\_TWO\_WAY\_PATH\_GET

*esp\_ble\_mesh\_path\_echo\_interval\_get\_t* **path\_echo\_interval\_get**

For ESP\_BLE\_MESH\_MODEL\_OP\_PATH\_ECHO\_INTERVAL\_GET

*esp\_ble\_mesh\_directed\_publish\_policy\_get\_t* **directed\_pub\_policy\_get**

For ESP\_BLE\_MESH\_MODEL\_OP\_DIRECTED\_PUB\_POLICY\_GET

union **esp\_ble\_mesh\_df\_client\_set\_t**

*#include <esp\_ble\_mesh\_df\_model\_api.h>* Directed Forwarding Configuration Client model set message union.

### Public Members

*esp\_ble\_mesh\_directed\_control\_set\_t* **directed\_control\_set**

For ESP\_BLE\_MESH\_MODEL\_OP\_DIRECTED\_CONTROL\_SET

*esp\_ble\_mesh\_path\_metric\_set\_t* **path\_metric\_set**

For ESP\_BLE\_MESH\_MODEL\_OP\_PATH\_METRIC\_SET

*esp\_ble\_mesh\_discovery\_table\_caps\_set\_t* **disc\_table\_caps\_set**

For ESP\_BLE\_MESH\_MODEL\_OP\_DISCOVERY\_TABLE\_CAPS\_SET

*esp\_ble\_mesh\_forwarding\_table\_add\_t* **forwarding\_table\_add**

For ESP\_BLE\_MESH\_MODEL\_OP\_FORWARDING\_TABLE\_ADD

*esp\_ble\_mesh\_forwarding\_table\_delete\_t* **forwarding\_table\_del**

For ESP\_BLE\_MESH\_MODEL\_OP\_FORWARDING\_TABLE\_DEL

*esp\_ble\_mesh\_forwarding\_table\_deps\_add\_t* **forwarding\_table\_deps\_add**

For ESP\_BLE\_MESH\_MODEL\_OP\_FORWARDING\_TABLE\_DEPS\_ADD

*esp\_ble\_mesh\_forwarding\_table\_deps\_delete\_t* **forwarding\_table\_deps\_del**

For ESP\_BLE\_MESH\_MODEL\_OP\_FORWARDING\_TABLE\_DEPS\_DEL

*esp\_ble\_mesh\_wanted\_lanes\_set\_t* **wanted\_lanes\_set**

For ESP\_BLE\_MESH\_MODEL\_OP\_WANTED\_LANES\_SET

*esp\_ble\_mesh\_two\_way\_path\_set\_t* **two\_way\_path\_set**

For ESP\_BLE\_MESH\_MODEL\_OP\_TWO\_WAY\_PATH\_SET

*esp\_ble\_mesh\_path\_echo\_interval\_set\_t* **path\_echo\_interval\_set**

For ESP\_BLE\_MESH\_MODEL\_OP\_PATH\_ECHO\_INTERVAL\_SET

*esp\_ble\_mesh\_directed\_net\_transmit\_set\_t* **directed\_net\_transmit\_set**

For ESP\_BLE\_MESH\_MODEL\_OP\_DIRECTED\_NET\_TRANSMIT\_SET

*esp\_ble\_mesh\_directed\_relay\_retransmit\_set\_t* **directed\_relay\_retransmit\_set**

For ESP\_BLE\_MESH\_MODEL\_OP\_DIRECTED\_RELAY\_RETRANSMIT\_SET

*esp\_ble\_mesh\_rssi\_threshold\_set\_t* **rssi\_threshold\_set**

For ESP\_BLE\_MESH\_MODEL\_OP\_RSSI\_THRESHOLD\_SET

*esp\_ble\_mesh\_directed\_publish\_policy\_set\_t* **directed\_pub\_policy\_set**

For ESP\_BLE\_MESH\_MODEL\_OP\_DIRECTED\_PUB\_POLICY\_SET

*esp\_ble\_mesh\_path\_discovery\_timing\_ctl\_set\_t* **path\_disc\_timing\_ctl\_set**

For ESP\_BLE\_MESH\_MODEL\_OP\_PATH\_DISCOVERY\_TIMING\_CTL\_SET

*esp\_ble\_mesh\_directed\_ctl\_net\_transmit\_set\_t* **directed\_ctl\_net\_transmit\_set**

For ESP\_BLE\_MESH\_MODEL\_OP\_DIRECTED\_CTL\_NET\_TRANSMIT\_SET

*esp\_ble\_mesh\_directed\_ctl\_relay\_retransmit\_set\_t* **directed\_ctl\_relay\_retransmit\_set**

For ESP\_BLE\_MESH\_MODEL\_OP\_DIRECTED\_CTL\_RELAY\_RETRANSMIT\_SET

union **esp\_ble\_mesh\_df\_client\_rcv\_cb\_t**

#include <esp\_ble\_mesh\_df\_model\_api.h> Directed Forwarding Configuration Client model received message union.

## Public Members

*esp\_ble\_mesh\_directed\_control\_status\_t* **directed\_control\_status**

ESP\_BLE\_MESH\_MODEL\_OP\_DIRECTED\_CONTROL\_STATUS

*esp\_ble\_mesh\_path\_metric\_status\_t* **path\_metric\_status**

ESP\_BLE\_MESH\_MODEL\_OP\_PATH\_METRIC\_STATUS

*esp\_ble\_mesh\_discovery\_table\_caps\_status\_t* **disc\_table\_caps\_status**  
ESP\_BLE\_MESH\_MODEL\_OP\_DISCOVERY\_TABLE\_CAPS\_STATUS

*esp\_ble\_mesh\_forwarding\_table\_status\_t* **forwarding\_table\_status**  
ESP\_BLE\_MESH\_MODEL\_OP\_FORWARDING\_TABLE\_STATUS

*esp\_ble\_mesh\_forwarding\_table\_deps\_status\_t* **forwarding\_table\_deps\_status**  
ESP\_BLE\_MESH\_MODEL\_OP\_FORWARDING\_TABLE\_DEPS\_STATUS

*esp\_ble\_mesh\_forwarding\_table\_entries\_cnt\_status\_t* **forwarding\_table\_entries\_cnt\_status**  
ESP\_BLE\_MESH\_MODEL\_OP\_FORWARDING\_TABLE\_ENTRIES\_CNT\_STATUS

*esp\_ble\_mesh\_forwarding\_table\_entries\_status\_t* **forwarding\_table\_entries\_status**  
ESP\_BLE\_MESH\_MODEL\_OP\_FORWARDING\_TABLE\_ENTRIES\_STATUS

*esp\_ble\_mesh\_forwarding\_table\_deps\_get\_status\_t* **forwarding\_table\_deps\_get\_status**  
ESP\_BLE\_MESH\_MODEL\_OP\_FORWARDING\_TABLE\_DEPS\_GET\_STATUS

*esp\_ble\_mesh\_wanted\_lanes\_status\_t* **wanted\_lanes\_status**  
ESP\_BLE\_MESH\_MODEL\_OP\_WANTED\_LANES\_STATUS

*esp\_ble\_mesh\_two\_way\_path\_status\_t* **two\_way\_path\_status**  
ESP\_BLE\_MESH\_MODEL\_OP\_TWO\_WAY\_PATH\_STATUS

*esp\_ble\_mesh\_path\_echo\_interval\_status\_t* **path\_echo\_interval\_status**  
ESP\_BLE\_MESH\_MODEL\_OP\_PATH\_ECHO\_INTERVAL\_STATUS

*esp\_ble\_mesh\_directed\_net\_transmit\_status\_t* **directed\_net\_transmit\_status**  
ESP\_BLE\_MESH\_MODEL\_OP\_DIRECTED\_NET\_TRANSMIT\_STATUS

*esp\_ble\_mesh\_directed\_relay\_retransmit\_status\_t* **directed\_relay\_retransmit\_status**  
ESP\_BLE\_MESH\_MODEL\_OP\_DIRECTED\_RELAY\_RETRANSMIT\_STATUS

*esp\_ble\_mesh\_rssi\_threshold\_status\_t* **rssi\_threshold\_status**  
ESP\_BLE\_MESH\_MODEL\_OP\_RSSI\_THRESHOLD\_STATUS

*esp\_ble\_mesh\_directed\_paths\_status\_t* **directed\_paths\_status**  
ESP\_BLE\_MESH\_MODEL\_OP\_DIRECTED\_PATHS\_STATUS

*esp\_ble\_mesh\_directed\_pub\_policy\_status\_t* **directed\_pub\_policy\_status**  
ESP\_BLE\_MESH\_MODEL\_OP\_DIRECTED\_PUB\_POLICY\_STATUS

*esp\_ble\_mesh\_path\_disc\_timing\_ctl\_status\_cb\_t* **path\_disc\_timing\_ctl\_status**  
ESP\_BLE\_MESH\_MODEL\_OP\_PATH\_DISCOVERY\_TIMING\_CTL\_STATUS

*esp\_ble\_mesh\_directed\_ctl\_net\_transmit\_status\_t* **directed\_ctl\_net\_transmit\_status**  
ESP\_BLE\_MESH\_MODEL\_OP\_DIRECTED\_CTL\_NET\_TRANSMIT\_STATUS



*esp\_ble\_mesh\_directed\_ctl\_relay\_retransmit\_status\_t* **directed\_ctl\_relay\_retransmit\_status**  
ESP\_BLE\_MESH\_MODEL\_OP\_DIRECTED\_CTL\_RELAY\_RETRANSMIT\_STATUS

union **esp\_ble\_mesh\_df\_server\_state\_change\_t**  
*#include <esp\_ble\_mesh\_df\_model\_api.h>* Directed Forwarding Configuration Server model related context.  
Directed Forwarding Configuration Server model state change value union

### Public Members

uint8\_t **dummy**  
Event not used currently

union **esp\_ble\_mesh\_df\_server\_cb\_value\_t**  
*#include <esp\_ble\_mesh\_df\_model\_api.h>* Directed Forwarding Configuration Server model callback value union.

### Public Members

*esp\_ble\_mesh\_df\_server\_state\_change\_t* **state\_change**  
For ESP\_BLE\_MESH\_DF\_SERVER\_STATE\_CHANGE\_EVT

*esp\_ble\_mesh\_df\_server\_table\_change\_t* **table\_change**  
For ESP\_BLE\_MESH\_DF\_SERVER\_TABLE\_CHANGE\_EVT

### Structures

struct **esp\_ble\_mesh\_df\_srv\_t**  
Directed Forwarding Configuration Server model context

### Public Members

*esp\_ble\_mesh\_model\_t* \***model**  
Pointer to Directed Forwarding Configuration Server model

uint8\_t **directed\_net\_transmit**  
Directed Network Transmit state

uint8\_t **directed\_relay\_retransmit**  
Directed Relay Retransmit state

int8\_t **default\_rssi\_threshold**  
Default RSSI Threshold state

uint8\_t **rssi\_margin**  
RSSI Margin state

`uint16_t directed_node_paths`

Directed Node Paths state

`uint16_t directed_relay_paths`

Directed Relay Paths state

`uint16_t directed_proxy_paths`

Directed Proxy Paths state

`uint16_t directed_friend_paths`

Directed Friend Paths state

`uint16_t path_monitor_interval`

Path Monitoring Interval state

`uint16_t path_disc_retry_interval`

Path Discovery Retry Interval state

`uint8_t path_disc_interval`

Path Discovery Interval state

`uint8_t lane_disc_guard_interval`

Lane Discovery Guard Interval state

`uint8_t directed_ctl_net_transmit`

Directed Control Network Transmit state

`uint8_t directed_ctl_relay_retransmit`

Directed Control Relay Retransmit state

struct `esp_ble_mesh_directed_control_get_t`

Parameters of Directed Control Get.

### Public Members

`uint16_t net_idx`

NetKey Index

struct `esp_ble_mesh_directed_control_set_t`

Parameters of Directed Control Set.

### Public Members

`uint16_t net_idx`

NetKey Index

`uint8_t directed_forwarding`

New Directed Forwarding state

uint8\_t **directed\_relay**  
New Directed Relay state

uint8\_t **directed\_proxy**  
New Directed Proxy state

uint8\_t **directed\_proxy\_use\_default**  
New Directed Proxy Use Directed Default state or value to ignore

uint8\_t **directed\_friend**  
New Directed Friend state or value to ignore

struct **esp\_ble\_mesh\_path\_metric\_get\_t**  
Parameters of Path Metric Get.

### Public Members

uint16\_t **net\_idx**  
NetKey Index

struct **esp\_ble\_mesh\_path\_metric\_set\_t**  
Parameters of Path Metric Set.

### Public Members

uint16\_t **net\_idx**  
NetKey Index

uint8\_t **path\_metric\_type**  
New Path Metric Type state

uint8\_t **path\_lifetime**  
New Path Lifetime state

struct **esp\_ble\_mesh\_discovery\_table\_caps\_get\_t**  
Parameters of Discovery Table Capabilities Get.

### Public Members

uint16\_t **net\_idx**  
NetKey Index

struct **esp\_ble\_mesh\_discovery\_table\_caps\_set\_t**  
Parameters of Discovery Table Capabilities Set.

**Public Members**`uint16_t net_idx`

NetKey Index

`uint8_t max_concurr_init`

New Max Concurrent Init state

struct `esp_ble_mesh_forwarding_table_add_t`

Parameters of Forwarding Table Add.

**Public Members**`uint16_t net_idx`

NetKey Index

`uint16_t unicast_dst`

Indicates whether or not the destination of the path is a unicast address

`uint16_t bw_path_validated`

Indicates whether or not the backward path has been validated

`esp_ble_mesh_uar_t path_origin`

Unicast address range of the Path Origin

`esp_ble_mesh_uar_t path_target`

Unicast address range of the Path Target

`uint16_t multicast_dst`

Multicast destination address

union `esp_ble_mesh_forwarding_table_add_t::[anonymous]` [**anonymous**]

Path target address

`uint16_t bearer_twd_path_origin`

Index of the bearer toward the Path Origin

`uint16_t bearer_twd_path_target`

Index of the bearer toward the Path Target

struct `esp_ble_mesh_forwarding_table_delete_t`

Parameters of Forwarding Table Delete.

**Public Members**`uint16_t net_idx`

NetKey Index

`uint16_t path_origin`

Primary element address of the Path Origin

`uint16_t dst`

Destination address

struct `esp_ble_mesh_forwarding_table_deps_add_t`

Parameters of Forwarding Table Dependents Add.

### Public Members

`uint16_t net_idx`

NetKey Index

`uint16_t path_origin`

Primary element address of the Path Origin

`uint16_t dst`

Destination address

`uint8_t dep_origin_uar_list_size`

Number of entries in the `Dependent_Origin_Unicast_Addr_Range_List` field

`uint8_t dep_target_uar_list_size`

Number of entries in the `Dependent_Target_Unicast_Addr_Range_List` field

`esp_ble_mesh_uar_t* dep_origin_uar_list`

List of the unicast address ranges of the dependent nodes of the Path Origin

`esp_ble_mesh_uar_t* dep_target_uar_list`

List of the unicast address ranges of the dependent nodes of the Path Target

struct `esp_ble_mesh_forwarding_table_deps_delete_t`

Parameters of Forwarding Table Dependents Delete.

### Public Members

`uint16_t net_idx`

NetKey Index

`uint16_t path_origin`

Primary element address of the Path Origin

`uint16_t dst`

Destination address

**uint8\_t dep\_origin\_list\_size**  
Number of entries in the Dependent\_Origin\_List field

**uint8\_t dep\_target\_list\_size**  
Number of entries in the Dependent\_Target\_List field

**uint16\_t \*dep\_origin\_list**  
List of the primary element addresses of the dependent nodes of the Path Origin

**uint16\_t \*dep\_target\_list**  
List of the primary element addresses of the dependent nodes of the Path Target

struct **esp\_ble\_mesh\_forwarding\_table\_entries\_cnt\_get\_t**  
Parameters of Forwarding Table Entries Count Get.

### Public Members

**uint16\_t net\_idx**  
NetKey Index

struct **esp\_ble\_mesh\_forwarding\_table\_entries\_get\_t**  
Parameters of Forwarding Table Entries Get.

### Public Members

**uint16\_t net\_idx**  
NetKey Index

**uint16\_t filter\_mask**  
Filter to be applied to the Forwarding Table entries

**uint16\_t start\_index**  
Start offset to read in units of Forwarding Table entries

**uint16\_t path\_origin**  
Primary element address of the Path Origin

**uint16\_t dst**  
Destination address

**bool include\_id**  
Indicate whether or not the Forwarding Table Update Identifier is present

**uint16\_t update\_id**  
Last saved Forwarding Table Update Identifier (Optional)

struct **esp\_ble\_mesh\_forwarding\_table\_deps\_get\_t**  
Parameters of Forwarding Table Dependents Get.

**Public Members****uint16\_t net\_idx**

NetKey Index

**uint16\_t dep\_list\_mask**

Filter applied to the lists of unicast address ranges for dependent nodes

**uint16\_t fixed\_path\_flag**

Indicate whether or not to return the unicast address ranges of dependent nodes in a fixed path entry

**uint16\_t start\_index**

Start offset in units of unicast address ranges

**uint16\_t path\_origin**

Primary element address of the Path Origin

**uint16\_t dst**

Destination address

**bool include\_id**

Indicate whether or not the Forwarding Table Update Identifier is present

**uint16\_t update\_id**

Last saved Forwarding Table Update Identifier (Optional)

struct **esp\_ble\_mesh\_wanted\_lanes\_get\_t**

Parameters of Wanted Lanes Get.

**Public Members****uint16\_t net\_idx**

NetKey Index

struct **esp\_ble\_mesh\_wanted\_lanes\_set\_t**

Parameters of Wanted Lanes Set.

**Public Members****uint16\_t net\_idx**

NetKey Index

**uint8\_t wanted\_lanes**

New Wanted Lanes state

struct **esp\_ble\_mesh\_two\_way\_path\_get\_t**

Parameters of Two Way Path Get.

**Public Members**`uint16_t net_idx`

NetKey Index

struct `esp_ble_mesh_two_way_path_set_t`

Parameters of Two Way Path Set.

**Public Members**`uint16_t net_idx`

NetKey Index

`uint8_t two_way_path`

Two way path flag

struct `esp_ble_mesh_path_echo_interval_get_t`

Parameters of Path Echo Interval Get.

**Public Members**`uint16_t net_idx`

NetKey Index

struct `esp_ble_mesh_path_echo_interval_set_t`

Parameters of Path Echo Interval Set.

**Public Members**`uint16_t net_idx`

NetKey Index

`uint8_t unicast_echo_interval`

New Unicast Echo Interval state or indication of no state change

`uint8_t multicast_echo_interval`

New Multicast Echo Interval state or indication of no state change

struct `esp_ble_mesh_directed_net_transmit_set_t`

Parameters of Directed Network Transmit Set.

**Public Members**`uint8_t net_transmit`

New Directed Network Transmit state



struct **esp\_ble\_mesh\_directed\_relay\_retransmit\_set\_t**  
Parameters of Directed Relay Retransmit Set.

### Public Members

uint8\_t **relay\_retransmit**  
New Directed Relay Retransmit state

struct **esp\_ble\_mesh\_rssi\_threshold\_set\_t**  
Parameters of RSSI Threshold Set.

### Public Members

uint8\_t **rssi\_margin**  
New RSSI Margin state

struct **esp\_ble\_mesh\_directed\_publish\_policy\_get\_t**  
Parameters of Directed Publish Policy Get.

### Public Members

uint16\_t **element\_addr**  
Address of the element

uint16\_t **company\_id**  
Company ID

uint16\_t **model\_id**  
Model ID

struct **esp\_ble\_mesh\_directed\_publish\_policy\_set\_t**  
Parameters of Directed Publish Policy Set.

### Public Members

uint8\_t **direct\_pub\_policy**  
New Directed Publish Policy state

uint16\_t **element\_addr**  
Address of the element

uint16\_t **company\_id**  
Company ID

uint16\_t **model\_id**  
Model ID

struct **esp\_ble\_mesh\_path\_discovery\_timing\_ctl\_set\_t**  
Parameters of Path Discovery Timing Control Set.

### Public Members

uint16\_t **path\_monitor\_interval**  
New Path Monitoring Interval state

uint16\_t **path\_disc\_retry\_interval**  
New Path Discovery Retry Interval state

uint8\_t **path\_disc\_interval**  
New Path Discovery Interval state

uint8\_t **lane\_disc\_guard\_interval**  
New Lane Discovery Guard Interval state

struct **esp\_ble\_mesh\_directed\_ctl\_net\_transmit\_set\_t**  
Parameters of Directed Control Network Transmit Set.

### Public Members

uint8\_t **net\_transmit**  
New Directed Control Network Transmit Count state

struct **esp\_ble\_mesh\_directed\_ctl\_relay\_retransmit\_set\_t**  
Parameters of Directed Control Relay Retransmit Set.

### Public Members

uint8\_t **relay\_retransmit**  
New Directed Control Relay Retransmit Count state

struct **esp\_ble\_mesh\_directed\_control\_status\_t**  
Parameters of Directed Control Status.

### Public Members

uint8\_t **status**  
Status code for the requesting message

uint16\_t **net\_idx**  
NetKey Index

uint8\_t **directed\_forwarding**  
Current Directed Forwarding state

uint8\_t **directed\_relay**

Current Directed Relay state

uint8\_t **directed\_proxy**

Current Directed Proxy state

uint8\_t **directed\_proxy\_use\_default**

Current Directed Proxy Use Directed Default state or 0xFF

uint8\_t **directed\_friend**

Current Directed Friend state

struct **esp\_ble\_mesh\_path\_metric\_status\_t**

Parameters of Path Metric Status.

### Public Members

uint8\_t **status**

Status code for the requesting message

uint16\_t **net\_idx**

NetKey Index

uint8\_t **path\_metric\_type**

Current Path Metric Type state

uint8\_t **path\_lifetime**

Current Path Lifetime state

struct **esp\_ble\_mesh\_discovery\_table\_caps\_status\_t**

Parameters of Discovery Table Capabilities Status.

### Public Members

uint8\_t **status**

Status code for the requesting message

uint16\_t **net\_idx**

NetKey Index

uint8\_t **max\_concurr\_init**

Current Max Concurrent Init state

uint8\_t **max\_disc\_entries**

Max Discovery Table Entries Count state

struct **esp\_ble\_mesh\_forwarding\_table\_status\_t**

Parameters of Forwarding Table Status.

**Public Members****uint8\_t status**

Status code for the requesting message

**uint16\_t net\_idx**

NetKey Index

**uint16\_t path\_origin**

Primary element address of the Path Origin

**uint16\_t dst**

Destination address

struct **esp\_ble\_mesh\_forwarding\_table\_deps\_status\_t**

Parameters of Forwarding Table Dependent Status.

**Public Members****uint8\_t status**

Status code for the requesting message

**uint16\_t net\_idx**

NetKey Index

**uint16\_t path\_origin**

Primary element address of the Path Origin

**uint16\_t dst**

Destination address

struct **esp\_ble\_mesh\_forwarding\_table\_entries\_cnt\_status\_t**

Parameters of Forwarding Table Entries Count Status.

**Public Members****uint8\_t status**

Status code for the requesting message

**uint16\_t net\_idx**

NetKey Index

**uint16\_t update\_id**

Current Forwarding Table Update Identifier state

**uint16\_t fixed\_entry\_cnt**

Number of fixed path entries in the Forwarding Table

`uint16_t non_fixed_entry_cnt`

Number of non-fixed path entries in the Forwarding Table

struct `esp_ble_mesh_forwarding_table_entry_t`

Parameters of Forwarding Table Entry.

### Public Members

`uint16_t fixed_path_flag`

Indicates whether the table entry is a fixed path entry or a non-fixed path entry

`uint16_t unicast_dst_flag`

Indicates whether or not the destination of the path is a unicast address

`uint16_t bw_path_validated_flag`

Indicates whether or not the backward path has been validated

`uint16_t bearer_twd_path_origin_ind`

Indicates the presence or absence of the Bearer\_Toward\_Path\_Origin field

`uint16_t bearer_twd_path_target_ind`

Indicates the presence or absence of the Bearer\_Toward\_Path\_Target field

`uint16_t dep_origin_list_size_ind`

Indicates the size of the Dependent\_Origin\_List field

`uint16_t dep_target_list_size_ind`

Indicates the size of the Dependent\_Target\_List field

`uint8_t lane_counter`

Number of lanes in the path

`uint16_t path_remaining_time`

Path lifetime remaining

`uint8_t path_origin_forward_number`

Forwarding number of the Path Origin

*`esp_ble_mesh_uar_t path_origin`*

Path Origin unicast address range

`uint16_t dep_origin_list_size`

Current number of entries in the list of dependent nodes of the Path Origin

`uint16_t bearer_twd_path_origin`

Index of the bearer toward the Path Origin

*esp\_ble\_mesh\_uar\_t* **path\_target**

Path Target unicast address range

uint16\_t **multicast\_dst**

Multicast destination address

uint16\_t **dep\_target\_list\_size**

Current number of entries in the list of dependent nodes of the Path Target

uint16\_t **bearer\_twd\_path\_target**

Index of the bearer toward the Path Target

struct **esp\_ble\_mesh\_forwarding\_table\_entries\_status\_t**

Parameters of Forwarding Table Entries Status.

### Public Members

uint8\_t **status**

Status code for the requesting message

uint16\_t **net\_idx**

NetKey Index

uint16\_t **filter\_mask**

Filter applied to the Forwarding Table entries

uint16\_t **start\_index**

Start offset in units of Forwarding Table entries

uint16\_t **path\_origin**

Primary element address of the Path Origin

uint16\_t **dst**

Destination address

bool **include\_id**

Indicate whether or not the Forwarding Table Update Identifier is present

uint16\_t **update\_id**

Current Forwarding Table Update Identifier state

uint8\_t **entry\_list\_size**

Current number of entries in the list of Forwarding Table entries

*esp\_ble\_mesh\_forwarding\_table\_entry\_t* \***entry\_list**

List of Forwarding Table entries

struct **esp\_ble\_mesh\_forwarding\_table\_deps\_get\_status\_t**

Parameters of Forwarding Table Dependents Get Status.

**Public Members****uint8\_t status**

Status code for the requesting message

**uint16\_t net\_idx**

NetKey Index

**uint16\_t dep\_list\_mask**

Filter applied to the lists of unicast address ranges for dependent nodes

**uint16\_t fixed\_path\_flag**

Flag indicating whether or not to return the unicast address ranges of dependent nodes in a fixed path entry

**uint16\_t start\_index**

Start offset in units of unicast address ranges

**uint16\_t path\_origin**

Primary element address of the Path Origin

**uint16\_t dst**

Destination address

**bool include\_id**

Indicate whether or not the Forwarding Table Update Identifier is present

**uint16\_t update\_id**

Current Forwarding Table Update Identifier state

**uint8\_t dep\_origin\_uar\_list\_size**Number of unicast address ranges in the `Dependent-Origin-Unicast-Addr-Range-List` field**uint8\_t dep\_target\_uar\_list\_size**Number of unicast address ranges in the `Dependent-Target-Unicast-Addr-Range-List` field*esp\_ble\_mesh\_uar\_t* \***dep\_origin\_uar\_list**

List of unicast address ranges of dependent nodes of the Path Origin

*esp\_ble\_mesh\_uar\_t* \***dep\_target\_uar\_list**

List of unicast address ranges of dependent nodes of the Path Target

struct **esp\_ble\_mesh\_wanted\_lanes\_status\_t**

Parameters of Wanted Lanes Status.

**Public Members**

`uint8_t status`

Status code for the requesting message

`uint16_t net_idx`

NetKey Index

`uint8_t wanted_lanes`

Current Wanted Lanes state

struct `esp_ble_mesh_two_way_path_status_t`

Parameters of Two Way Path Status.

### Public Members

`uint8_t status`

Status code for the requesting message

`uint16_t net_idx`

NetKey Index

`uint8_t two_way_path`

Current Two Way Path state

struct `esp_ble_mesh_path_echo_interval_status_t`

Parameters of Path Echo Interval Status.

### Public Members

`uint8_t status`

Status code for the requesting message

`uint16_t net_idx`

NetKey Index

`uint8_t unicast_echo_interval`

Current Unicast Echo Interval state

`uint8_t multicast_echo_interval`

Current Multicast Echo Interval state

struct `esp_ble_mesh_directed_net_transmit_status_t`

Parameters of Directed Network Transmit Status.

### Public Members



uint8\_t **net\_transmit**

Current Directed Network Transmit state

struct **esp\_ble\_mesh\_directed\_relay\_retransmit\_status\_t**

Parameters of Directed Relay Retransmit Status.

### Public Members

uint8\_t **relay\_retransmit**

Current Directed Relay Retransmit state

struct **esp\_ble\_mesh\_rssi\_threshold\_status\_t**

Parameters of RSSI Threshold Status.

### Public Members

uint8\_t **default\_rssi\_threshold**

Default RSSI Threshold state

uint8\_t **rssi\_margin**

Current RSSI Margin state

struct **esp\_ble\_mesh\_directed\_paths\_status\_t**

Parameters of Directed Paths Status.

### Public Members

uint16\_t **directed\_node\_paths**

Directed Node Paths state

uint16\_t **directed\_relay\_paths**

Directed Relay Paths state

uint16\_t **directed\_proxy\_paths**

Directed Proxy Paths state

uint16\_t **directed\_friend\_paths**

Directed Friend Paths state

struct **esp\_ble\_mesh\_directed\_pub\_policy\_status\_t**

Parameters of Directed Publish Policy Status.

### Public Members

uint8\_t **status**

Status code for the requesting message

uint8\_t **directed\_pub\_policy**

Current Directed Publish Policy state

uint16\_t **element\_addr**

Address of the element

uint16\_t **company\_id**

Company ID

uint16\_t **model\_id**

Model ID

struct **esp\_ble\_mesh\_path\_disc\_timing\_ctl\_status\_cb\_t**

Parameters of Path Discovery Timing Control Status.

### Public Members

uint16\_t **path\_monitor\_interval**

Current Path Monitoring Interval state

uint16\_t **path\_disc\_retry\_interval**

Current Path Discovery Retry Interval state

uint8\_t **path\_disc\_interval**

Current Path Discovery Interval state

uint8\_t **lane\_disc\_guard\_interval**

Current Lane Discovery Guard Interval state

struct **esp\_ble\_mesh\_directed\_ctl\_net\_transmit\_status\_t**

Parameters of Directed Control Network Transmit Status.

### Public Members

uint8\_t **net\_transmit**

Current Directed Control Network Transmit state

struct **esp\_ble\_mesh\_directed\_ctl\_relay\_retransmit\_status\_t**

Parameters of Directed Control Relay Retransmit Status.

### Public Members

uint8\_t **relay\_retransmit**

Current Directed Control Relay Retransmit state

struct **esp\_ble\_mesh\_df\_client\_send\_cb\_t**

Result of sending Directed Forwarding Configuration Client messages

**Public Members****int err\_code**

Result of sending a message

**struct esp\_ble\_mesh\_df\_client\_cb\_param\_t**

Directed Forwarding Configuration Client model callback parameters

**Public Members***esp\_ble\_mesh\_client\_common\_param\_t* \*params

Client common parameters, used by all events.

*esp\_ble\_mesh\_df\_client\_send\_cb\_t* send

Result of sending a message

*esp\_ble\_mesh\_df\_client\_rcv\_cb\_t* rcv

Parameters of received status message

union *esp\_ble\_mesh\_df\_client\_cb\_param\_t*::[anonymous] [**anonymous**]

Union of DF Client callback

**struct esp\_ble\_mesh\_df\_server\_table\_change\_t**

Parameters of directed forwarding table entry change

**Public Members***esp\_ble\_mesh\_df\_table\_action\_t* action

Action of directed forwarding table

*esp\_ble\_mesh\_uar\_t* path\_origin

Primary element address of the Path Origin

*esp\_ble\_mesh\_uar\_t* path\_target

Primary element address of the Path Target

*esp\_ble\_mesh\_uar\_t* \*dep\_origin\_data

List of the primary element addresses of the dependent nodes of the Path Origin

uint32\_t dep\_origin\_num

Number of entries in the Dependent\_Origin\_List field of the message

*esp\_ble\_mesh\_uar\_t* \*dep\_target\_data

List of the primary element addresses of the dependent nodes of the Path Target

uint32\_t dep\_target\_num

Number of entries in the Dependent\_Target\_List field of the message

`uint8_t fixed_path`

Indicates whether the table entry is a fixed path entry or a non-fixed path entry

`uint8_t bw_path_validate`

Indicates whether or not the backward path has been validated

`uint8_t path_not_ready`

Flag indicating whether or not the path is ready for use

`uint8_t forward_number`

Forwarding number of the Path Origin; If the entry is associated with a fixed path, the value is 0

`uint8_t lane_counter`

Number of lanes discovered; if the entry is associated with a fixed path, the value is 1.

struct *esp\_ble\_mesh\_df\_server\_table\_change\_t*::[anonymous]::[anonymous]

**df\_table\_entry\_add\_remove**

Structure of directed forwarding table add and remove Structure of directed forwarding table add and remove

`uint8_t dummy`

Event not used currently

struct *esp\_ble\_mesh\_df\_server\_table\_change\_t*::[anonymous]::[anonymous] **df\_table\_entry\_change**

Structure of directed forwarding table entry change Directed forwarding table entry change

union *esp\_ble\_mesh\_df\_server\_table\_change\_t*::[anonymous] **df\_table\_info**

Union of directed forwarding table information Directed forwarding table information

struct **esp\_ble\_mesh\_df\_server\_cb\_param\_t**

Directed Forwarding Configuration Server model callback parameters

### Public Members

*esp\_ble\_mesh\_model\_t* \***model**

Pointer to the server model structure

*esp\_ble\_mesh\_msg\_ctx\_t* **ctx**

Context of the received message

*esp\_ble\_mesh\_df\_server\_cb\_value\_t* **value**

Value of the received configuration messages

### Macros

**ESP\_BLE\_MESH\_MODEL\_OP\_DIRECTED\_CONTROL\_GET**

**ESP\_BLE\_MESH\_MODEL\_OP\_DIRECTED\_CONTROL\_SET**

ESP\_BLE\_MESH\_MODEL\_OP\_DIRECTED\_CONTROL\_STATUS

ESP\_BLE\_MESH\_MODEL\_OP\_PATH\_METRIC\_GET

ESP\_BLE\_MESH\_MODEL\_OP\_PATH\_METRIC\_SET

ESP\_BLE\_MESH\_MODEL\_OP\_PATH\_METRIC\_STATUS

ESP\_BLE\_MESH\_MODEL\_OP\_DISCOVERY\_TABLE\_CAPS\_GET

ESP\_BLE\_MESH\_MODEL\_OP\_DISCOVERY\_TABLE\_CAPS\_SET

ESP\_BLE\_MESH\_MODEL\_OP\_DISCOVERY\_TABLE\_CAPS\_STATUS

ESP\_BLE\_MESH\_MODEL\_OP\_FORWARDING\_TABLE\_ADD

ESP\_BLE\_MESH\_MODEL\_OP\_FORWARDING\_TABLE\_DEL

ESP\_BLE\_MESH\_MODEL\_OP\_FORWARDING\_TABLE\_STATUS

ESP\_BLE\_MESH\_MODEL\_OP\_FORWARDING\_TABLE\_DEPS\_ADD

ESP\_BLE\_MESH\_MODEL\_OP\_FORWARDING\_TABLE\_DEPS\_DEL

ESP\_BLE\_MESH\_MODEL\_OP\_FORWARDING\_TABLE\_DEPS\_STATUS

ESP\_BLE\_MESH\_MODEL\_OP\_FORWARDING\_TABLE\_DEPS\_GET

ESP\_BLE\_MESH\_MODEL\_OP\_FORWARDING\_TABLE\_DEPS\_GET\_STATUS

ESP\_BLE\_MESH\_MODEL\_OP\_FORWARDING\_TABLE\_ENTRIES\_CNT\_GET

ESP\_BLE\_MESH\_MODEL\_OP\_FORWARDING\_TABLE\_ENTRIES\_CNT\_STATUS

ESP\_BLE\_MESH\_MODEL\_OP\_FORWARDING\_TABLE\_ENTRIES\_GET

ESP\_BLE\_MESH\_MODEL\_OP\_FORWARDING\_TABLE\_ENTRIES\_STATUS

ESP\_BLE\_MESH\_MODEL\_OP\_WANTED\_LANES\_GET

ESP\_BLE\_MESH\_MODEL\_OP\_WANTED\_LANES\_SET

ESP\_BLE\_MESH\_MODEL\_OP\_WANTED\_LANES\_STATUS

ESP\_BLE\_MESH\_MODEL\_OP\_TWO\_WAY\_PATH\_GET

ESP\_BLE\_MESH\_MODEL\_OP\_TWO\_WAY\_PATH\_SET

ESP\_BLE\_MESH\_MODEL\_OP\_TWO\_WAY\_PATH\_STATUS

ESP\_BLE\_MESH\_MODEL\_OP\_PATH\_ECHO\_INTERVAL\_GET

ESP\_BLE\_MESH\_MODEL\_OP\_PATH\_ECHO\_INTERVAL\_SET

ESP\_BLE\_MESH\_MODEL\_OP\_PATH\_ECHO\_INTERVAL\_STATUS

ESP\_BLE\_MESH\_MODEL\_OP\_DIRECTED\_NET\_TRANSMIT\_GET

ESP\_BLE\_MESH\_MODEL\_OP\_DIRECTED\_NET\_TRANSMIT\_SET

ESP\_BLE\_MESH\_MODEL\_OP\_DIRECTED\_NET\_TRANSMIT\_STATUS

ESP\_BLE\_MESH\_MODEL\_OP\_DIRECTED\_RELAY\_RETRANSMIT\_GET

ESP\_BLE\_MESH\_MODEL\_OP\_DIRECTED\_RELAY\_RETRANSMIT\_SET

ESP\_BLE\_MESH\_MODEL\_OP\_DIRECTED\_RELAY\_RETRANSMIT\_STATUS

ESP\_BLE\_MESH\_MODEL\_OP\_RSSI\_THRESHOLD\_GET

ESP\_BLE\_MESH\_MODEL\_OP\_RSSI\_THRESHOLD\_SET

ESP\_BLE\_MESH\_MODEL\_OP\_RSSI\_THRESHOLD\_STATUS

ESP\_BLE\_MESH\_MODEL\_OP\_DIRECTED\_PATHS\_GET

ESP\_BLE\_MESH\_MODEL\_OP\_DIRECTED\_PATHS\_STATUS

ESP\_BLE\_MESH\_MODEL\_OP\_DIRECTED\_PUB\_POLICY\_GET

ESP\_BLE\_MESH\_MODEL\_OP\_DIRECTED\_PUB\_POLICY\_SET

ESP\_BLE\_MESH\_MODEL\_OP\_DIRECTED\_PUB\_POLICY\_STATUS

ESP\_BLE\_MESH\_MODEL\_OP\_PATH\_DISCOVERY\_TIMING\_CTL\_GET

ESP\_BLE\_MESH\_MODEL\_OP\_PATH\_DISCOVERY\_TIMING\_CTL\_SET

ESP\_BLE\_MESH\_MODEL\_OP\_PATH\_DISCOVERY\_TIMING\_CTL\_STATUS

ESP\_BLE\_MESH\_MODEL\_OP\_DIRECTED\_CTL\_NET\_TRANSMIT\_GET

**ESP\_BLE\_MESH\_MODEL\_OP\_DIRECTED\_CTL\_NET\_TRANSMIT\_SET**

**ESP\_BLE\_MESH\_MODEL\_OP\_DIRECTED\_CTL\_NET\_TRANSMIT\_STATUS**

**ESP\_BLE\_MESH\_MODEL\_OP\_DIRECTED\_CTL\_RELAY\_RETRANSMIT\_GET**

**ESP\_BLE\_MESH\_MODEL\_OP\_DIRECTED\_CTL\_RELAY\_RETRANSMIT\_SET**

**ESP\_BLE\_MESH\_MODEL\_OP\_DIRECTED\_CTL\_RELAY\_RETRANSMIT\_STATUS**

**ESP\_BLE\_MESH\_PATH\_DISC\_INTERVAL\_5\_SEC**

**ESP\_BLE\_MESH\_PATH\_DISC\_INTERVAL\_30\_SEC**

**ESP\_BLE\_MESH\_LANE\_DISC\_GUARD\_INTERVAL\_2\_SEC**

**ESP\_BLE\_MESH\_LANE\_DISC\_GUARD\_INTERVAL\_10\_SEC**

**ESP\_BLE\_MESH\_DIRECTED\_PUB\_POLICY\_MANAGED\_FLOODING**

**ESP\_BLE\_MESH\_DIRECTED\_PUB\_POLICY\_DIRECTED\_FORWARDING**

**ESP\_BLE\_MESH\_GET\_FILTER\_MASK** (fp, nfp, pom, dm)

**ESP\_BLE\_MESH\_MODEL\_DF\_SRV** (srv\_data)

Define a new Directed Forwarding Configuration Server model.

---

**备注:** If supported, the model shall be supported by a primary element and shall not be supported by any secondary elements.

---

**参数**

- **srv\_data** -- Pointer to a unique Directed Forwarding Configuration Server model user\_data.

**返回** New Directed Forwarding Configuration Server model instance.

**ESP\_BLE\_MESH\_MODEL\_DF\_CLI** (cli\_data)

Define a new Directed Forwarding Configuration Client model.

---

**备注:** If supported, the model shall be supported by a primary element and shall not be supported by any secondary elements.

---

**参数**

- **cli\_data** -- Pointer to a unique Directed Forwarding Configuration Client model user\_data.

**返回** New Directed Forwarding Configuration Client model instance.

## Type Definitions

```
typedef void (*esp_ble_mesh_df_client_cb_t)(esp_ble_mesh_df_client_cb_event_t event,  
esp_ble_mesh_df_client_cb_param_t *param)
```

Bluetooth Mesh Directed Forwarding Configuration client and server model functions.

Directed Forwarding Configuration Client model callback function type

**Param event** Event type

**Param param** Pointer to callback parameter

```
typedef void (*esp_ble_mesh_df_server_cb_t)(esp_ble_mesh_df_server_cb_event_t event,  
esp_ble_mesh_df_server_cb_param_t *param)
```

Directed Forwarding Configuration Server model callback function type.

**Param event** Event type

**Param param** Pointer to callback parameter

## Enumerations

```
enum esp_ble_mesh_df_client_cb_event_t
```

This enum value is the event of Directed Forwarding Configuration Client model

*Values:*

enumerator **ESP\_BLE\_MESH\_DF\_CLIENT\_SEND\_COMP\_EVT**

enumerator **ESP\_BLE\_MESH\_DF\_CLIENT\_SEND\_TIMEOUT\_EVT**

enumerator **ESP\_BLE\_MESH\_DF\_CLIENT\_RECV\_GET\_RSP\_EVT**

enumerator **ESP\_BLE\_MESH\_DF\_CLIENT\_RECV\_SET\_RSP\_EVT**

enumerator **ESP\_BLE\_MESH\_DF\_CLIENT\_RECV\_PUB\_EVT**

enumerator **ESP\_BLE\_MESH\_DF\_CLIENT\_EVT\_MAX**

```
enum esp_ble_mesh_df_table_action_t
```

*Values:*

enumerator **ESP\_BLE\_MESH\_DF\_TABLE\_ACT\_EMPTY**

enumerator **ESP\_BLE\_MESH\_DF\_TABLE\_ADD**

enumerator **ESP\_BLE\_MESH\_DF\_TABLE\_REMOVE**

enumerator **ESP\_BLE\_MESH\_DF\_TABLE\_ENTRY\_CHANGE**

enumerator **ESP\_BLE\_MESH\_DF\_TABLE\_ACT\_MAX\_LIMIT**

```
enum esp_ble_mesh_df_server_cb_event_t
```

This enum value is the event of Directed Forwarding Configuration Server model

*Values:*



enumerator **ESP\_BLE\_MESH\_DF\_SERVER\_STATE\_CHANGE\_EVT**

enumerator **ESP\_BLE\_MESH\_DF\_SERVER\_TABLE\_CHANGE\_EVT**

enumerator **ESP\_BLE\_MESH\_DF\_SERVER\_EVT\_MAX**

## Subnet Bridge Configuration

### Header File

- `components/bt/esp_ble_mesh/v1.1/api/core/include/esp_ble_mesh_brc_model_api.h`
- This header file can be included with:

```
#include "esp_ble_mesh_brc_model_api.h"
```

- This header file is a part of the API provided by the `bt` component. To declare that your component depends on `bt`, add the following to your `CMakeLists.txt`:

```
REQUIRES bt
```

or

```
PRIV_REQUIRES bt
```

### Functions

*esp\_err\_t* **esp\_ble\_mesh\_register\_brc\_client\_callback** (*esp\_ble\_mesh\_brc\_client\_cb\_t* callback)

Register BLE Mesh Bridge Configuration Client model callback.

**参数** **callback** -- **[in]** Pointer to the callback function.

**返回** ESP\_OK on success or error code otherwise.

*esp\_err\_t* **esp\_ble\_mesh\_register\_brc\_server\_callback** (*esp\_ble\_mesh\_brc\_server\_cb\_t* callback)

Register BLE Mesh Bridge Configuration Server model callback.

**参数** **callback** -- **[in]** Pointer to the callback function.

**返回** ESP\_OK on success or error code otherwise.

*esp\_err\_t* **esp\_ble\_mesh\_brc\_client\_send** (*esp\_ble\_mesh\_client\_common\_param\_t* \*params, *esp\_ble\_mesh\_brc\_client\_msg\_t* \*msg)

Get/Set the value of Bridge Configuration Server model state with the corresponding message.

**参数**

- **params** -- **[in]** Pointer to BLE Mesh common client parameters.
- **msg** -- **[in]** Pointer to Bridge Configuration Client message.

**返回** ESP\_OK on success or error code otherwise.

### Unions

union **esp\_ble\_mesh\_brc\_client\_msg\_t**

`#include <esp_ble_mesh_brc_model_api.h>` Bridge Configuration Client model message union.

### Public Members

*esp\_ble\_mesh\_bridged\_subnets\_get\_t* **bridged\_subnets\_get**

For ESP\_BLE\_MESH\_MODEL\_OP\_BRIDGED\_SUBNETS\_GET

*esp\_ble\_mesh\_bridging\_table\_get\_t* **bridging\_table\_get**

For ESP\_BLE\_MESH\_MODEL\_OP\_BRIDGING\_TABLE\_GET

*esp\_ble\_mesh\_subnet\_bridge\_set\_t* **subnet\_bridge\_set**

For ESP\_BLE\_MESH\_MODEL\_OP\_SUBNET\_BRIDGE\_SET

*esp\_ble\_mesh\_bridging\_table\_add\_t* **bridging\_table\_add**

For ESP\_BLE\_MESH\_MODEL\_OP\_BRIDGING\_TABLE\_ADD

*esp\_ble\_mesh\_bridging\_table\_remove\_t* **bridging\_table\_remove**

For ESP\_BLE\_MESH\_MODEL\_OP\_BRIDGING\_TABLE\_REMOVE

union **esp\_ble\_mesh\_brc\_client\_rcv\_cb\_t**

*#include <esp\_ble\_mesh\_brc\_model\_api.h>* Bridge Configuration Client model received message union.

### Public Members

*esp\_ble\_mesh\_subnet\_bridge\_status\_t* **subnet\_bridge\_status**

ESP\_BLE\_MESH\_MODEL\_OP\_SUBNET\_BRIDGE\_STATUS

*esp\_ble\_mesh\_bridging\_table\_status\_t* **bridging\_table\_status**

ESP\_BLE\_MESH\_MODEL\_OP\_BRIDGING\_TABLE\_STATUS

*esp\_ble\_mesh\_bridged\_subnets\_list\_t* **bridged\_subnets\_list**

ESP\_BLE\_MESH\_MODEL\_OP\_BRIDGED\_SUBNETS\_LIST

*esp\_ble\_mesh\_bridging\_table\_list\_t* **bridging\_table\_list**

ESP\_BLE\_MESH\_MODEL\_OP\_BRIDGING\_TABLE\_LIST

*esp\_ble\_mesh\_bridging\_table\_size\_status\_t* **bridging\_table\_size\_status**

ESP\_BLE\_MESH\_MODEL\_OP\_BRIDGING\_TABLE\_SIZE\_STATUS

union **esp\_ble\_mesh\_brc\_server\_state\_change\_t**

*#include <esp\_ble\_mesh\_brc\_model\_api.h>* Bridge Configuration Server model state change value union.

### Public Members

*esp\_ble\_mesh\_state\_change\_bridging\_table\_add\_t* **bridging\_table\_add**

The rcv\_op in ctx can be used to decide which state is changed. Bridging Table Add

*esp\_ble\_mesh\_state\_change\_bridging\_table\_remove\_t* **bridging\_table\_remove**

Bridging Table Remove

union **esp\_ble\_mesh\_brc\_server\_cb\_value\_t**

*#include <esp\_ble\_mesh\_brc\_model\_api.h>* Bridge Configuration Server model callback value union.

### Public Members

*esp\_ble\_mesh\_brc\_server\_state\_change\_t* **state\_change**

For ESP\_BLE\_MESH\_BRC\_SERVER\_STATE\_CHANGE\_EVT

### Structures

struct **esp\_ble\_mesh\_subnet\_bridge\_table\_t**

Parameters of subnet bridge table

### Public Members

uint8\_t **bridge\_direction**

Allowed directions for the bridged traffic

uint8\_t **bridge\_net\_idx**[3]

Two NetKey Indexes are packed into three octets

uint16\_t **bridge\_addr\_1**

Address of the node in the first subnet

uint16\_t **bridge\_addr\_2**

Address of the node in the second subnet

struct **esp\_ble\_mesh\_subnet\_bridge\_set\_t**

Parameters of Subnet Bridge Set

### Public Members

uint8\_t **subnet\_bridge**

New Subnet Bridge state

struct **esp\_ble\_mesh\_bridging\_table\_add\_t**

Parameters of Bridging Table Add

### Public Members

uint8\_t **bridge\_direction**

Allowed directions for the bridged traffic

uint16\_t **bridge\_net\_idx\_1**

NetKey Index of the first subnet

uint16\_t **bridge\_net\_idx\_2**

NetKey Index of the second subnet

uint16\_t **bridge\_addr\_1**

Address of the node in the first subnet

uint16\_t **bridge\_addr\_2**

Address of the node in the second subnet

struct **esp\_ble\_mesh\_bridging\_table\_remove\_t**

Parameters of Bridging Table Remove

### Public Members

uint16\_t **bridge\_net\_idx\_1**

NetKey Index of the first subnet

uint16\_t **bridge\_net\_idx\_2**

NetKey Index of the second subnet

uint16\_t **bridge\_addr\_1**

Address of the node in the first subnet

uint16\_t **bridge\_addr\_2**

Address of the node in the second subnet

struct **esp\_ble\_mesh\_bridged\_subnets\_get\_t**

Parameters of Bridged Subnets Get

### Public Members

uint16\_t **bridge\_filter**

Filter to be applied when reporting the set of pairs of NetKey Indexes

uint16\_t **bridge\_net\_idx**

NetKey Index of any of the subnets

uint8\_t **bridge\_start\_idx**

Start offset in units of Bridging Table state entries

struct **esp\_ble\_mesh\_bridging\_table\_get\_t**

Parameters of Bridging Table Get

### Public Members

uint16\_t **bridge\_net\_idx\_1**

NetKey Index of first subnet

uint16\_t **bridge\_net\_idx\_2**  
NetKey Index of the second subnet

uint16\_t **bridge\_start\_idx**  
Start offset in units of Bridging Table state entries

struct **esp\_ble\_mesh\_subnet\_bridge\_status\_t**  
Parameters of Subnet Bridge Status

### Public Members

uint8\_t **subnet\_bridge**  
Current Subnet Bridge state

struct **esp\_ble\_mesh\_bridging\_table\_status\_t**  
Parameters of Bridging Table Status

### Public Members

uint8\_t **status**  
Status Code for the requesting message

uint8\_t **bridge\_direction**  
Allowed directions for the bridged traffic

uint16\_t **bridge\_net\_idx\_1**  
NetKey Index of the first subnet

uint16\_t **bridge\_net\_idx\_2**  
NetKey Index of the second subnet

uint16\_t **bridge\_addr\_1**  
Address of the node in the first subnet

uint16\_t **bridge\_addr\_2**  
Address of the node in the second subnet

struct **esp\_ble\_mesh\_bridge\_net\_idx\_pair\_entry\_t**  
Bridged\_Subnets\_List entry format

### Public Members

uint16\_t **bridge\_net\_idx\_1**  
NetKey Index of the first subnet

uint16\_t **bridge\_net\_idx\_2**  
NetKey Index of the second subnet

struct **esp\_ble\_mesh\_bridged\_subnets\_list\_t**  
Parameters of Bridged Subnets List

### Public Members

uint16\_t **bridge\_filter**  
Filter applied to the set of pairs of NetKey Indexes

uint16\_t **bridge\_net\_idx**  
NetKey Index used for filtering or ignored

uint8\_t **bridge\_start\_idx**  
Start offset in units of bridges

uint8\_t **bridged\_entry\_list\_size**  
Num of pairs of NetKey Indexes

*esp\_ble\_mesh\_bridge\_net\_idx\_pair\_entry\_t* \***net\_idx\_pair**  
Filtered set of N pairs of NetKey Indexes

struct **esp\_ble\_mesh\_bridged\_addr\_list\_entry\_t**  
Bridged\_Addresses\_List entry format

### Public Members

uint8\_t **bridge\_direction**  
Allowed directions for bridged traffic

uint16\_t **bridge\_addr\_1**  
Address of the node in the first subnet

uint16\_t **bridge\_addr\_2**  
Address of the node in the second subnet

struct **esp\_ble\_mesh\_bridging\_table\_list\_t**  
Parameters of Bridging Table List

### Public Members

uint8\_t **status**  
Status Code for the requesting message

uint16\_t **bridge\_net\_idx\_1**  
NetKey Index of the first subnet

uint16\_t **bridge\_net\_idx\_2**  
NetKey Index of the second subnet

uint16\_t **bridge\_start\_idx**  
Start offset in units of Bridging Table state entries

uint16\_t **bridged\_addr\_list\_size**  
Num of pairs of entry

*esp\_ble\_mesh\_bridged\_addr\_list\_entry\_t* \***bridged\_addr\_list**  
List of bridged addresses and allowed traffic directions

struct **esp\_ble\_mesh\_bridging\_table\_size\_status\_t**  
Parameters of Bridging Table Size Status

### Public Members

uint16\_t **bridging\_table\_size**  
Bridging Table Size state

struct **esp\_ble\_mesh\_brc\_client\_send\_cb\_t**  
Result of sending Bridge Configuration Client messages

### Public Members

int **err\_code**  
Result of sending a message

struct **esp\_ble\_mesh\_brc\_client\_cb\_param\_t**  
Bridge Configuration Client model callback parameters

### Public Members

*esp\_ble\_mesh\_client\_common\_param\_t* \***params**  
Client common parameters, used by all events.

*esp\_ble\_mesh\_brc\_client\_send\_cb\_t* **send**  
Result of sending a message

*esp\_ble\_mesh\_brc\_client\_rcv\_cb\_t* **rcv**  
Parameters of received status message

union *esp\_ble\_mesh\_brc\_client\_cb\_param\_t*::[anonymous] [**anonymous**]

Union of Bridge Configuration Client callback

struct **esp\_ble\_mesh\_state\_change\_bridging\_table\_add\_t**

Bridge Configuration Server model related context.

Parameters of Bridging Table Add

### Public Members

uint8\_t **bridge\_direction**

Allowed directions for the bridged traffic

uint16\_t **bridge\_net\_idx\_1**

NetKey Index of the first subnet

uint16\_t **bridge\_net\_idx\_2**

NetKey Index of the second subnet

uint16\_t **bridge\_addr\_1**

Address of the node in the first subnet

uint16\_t **bridge\_addr\_2**

Address of the node in the second subnet

struct **esp\_ble\_mesh\_state\_change\_bridging\_table\_remove\_t**

Parameters of Bridging Table Remove

### Public Members

uint16\_t **bridge\_net\_idx\_1**

NetKey Index of the first subnet

uint16\_t **bridge\_net\_idx\_2**

NetKey Index of the second subnet

uint16\_t **bridge\_addr\_1**

Address of the node in the first subnet

uint16\_t **bridge\_addr\_2**

Address of the node in the second subnet

struct **esp\_ble\_mesh\_brc\_server\_cb\_param\_t**

Bridge Configuration Server model callback parameters



## Public Members

*esp\_ble\_mesh\_model\_t* \***model**

Pointer to the server model structure

*esp\_ble\_mesh\_msg\_ctx\_t* **ctx**

Context of the received message

*esp\_ble\_mesh\_brc\_server\_cb\_value\_t* **value**

Value of the received configuration messages

## Macros

**ESP\_BLE\_MESH\_MODEL\_OP\_SUBNET\_BRIDGE\_GET**

**ESP\_BLE\_MESH\_MODEL\_OP\_SUBNET\_BRIDGE\_SET**

**ESP\_BLE\_MESH\_MODEL\_OP\_SUBNET\_BRIDGE\_STATUS**

**ESP\_BLE\_MESH\_MODEL\_OP\_BRIDGING\_TABLE\_ADD**

**ESP\_BLE\_MESH\_MODEL\_OP\_BRIDGING\_TABLE\_REMOVE**

**ESP\_BLE\_MESH\_MODEL\_OP\_BRIDGING\_TABLE\_STATUS**

**ESP\_BLE\_MESH\_MODEL\_OP\_BRIDGED\_SUBNETS\_GET**

**ESP\_BLE\_MESH\_MODEL\_OP\_BRIDGED\_SUBNETS\_LIST**

**ESP\_BLE\_MESH\_MODEL\_OP\_BRIDGING\_TABLE\_GET**

**ESP\_BLE\_MESH\_MODEL\_OP\_BRIDGING\_TABLE\_LIST**

**ESP\_BLE\_MESH\_MODEL\_OP\_BRIDGING\_TABLE\_SIZE\_GET**

**ESP\_BLE\_MESH\_MODEL\_OP\_BRIDGING\_TABLE\_SIZE\_STATUS**

**ESP\_BLE\_MESH\_MODEL\_BRC\_SRV** (srv\_data)

Define a new Bridge Configuration Server model.

---

**备注:** If supported, the model shall be supported by a primary element and shall not be supported by any secondary elements.

---

### 参数

- **srv\_data** -- Pointer to a unique Bridge Configuration Server model user\_data.

**返回** New Bridge Configuration Server model instance.

**ESP\_BLE\_MESH\_MODEL\_BRC\_CLI** (cli\_data)

Define a new Bridge Configuration Client model.

---

**备注:** If supported, the model shall be supported by a primary element and shall not be supported by any secondary elements.

---

**参数**

- **cli\_data** -- Pointer to a unique Bridge Configuration Client model user\_data.

**返回** New Bridge Configuration Client model instance.

**Type Definitions**

```
typedef void (*esp_ble_mesh_brc_client_cb_t)(esp_ble_mesh_brc_client_cb_event_t event,  
esp_ble_mesh_brc_client_cb_param_t *param)
```

Bluetooth Mesh Bridge Configuration client and server model functions.

Bridge Configuration Client model callback function type

**Param event** Event type

**Param param** Pointer to callback parameter

```
typedef void (*esp_ble_mesh_brc_server_cb_t)(esp_ble_mesh_brc_server_cb_event_t event,  
esp_ble_mesh_brc_server_cb_param_t *param)
```

Bridge Configuration Server model callback function type.

**Param event** Event type

**Param param** Pointer to callback parameter

**Enumerations**

```
enum esp_ble_mesh_brc_client_cb_event_t
```

This enum value is the event of Bridge Configuration Client model

*Values:*

enumerator **ESP\_BLE\_MESH\_BRC\_CLIENT\_SEND\_COMP\_EVT**

enumerator **ESP\_BLE\_MESH\_BRC\_CLIENT\_SEND\_TIMEOUT\_EVT**

enumerator **ESP\_BLE\_MESH\_BRC\_CLIENT\_RECV\_RSP\_EVT**

enumerator **ESP\_BLE\_MESH\_BRC\_CLIENT\_RECV\_PUB\_EVT**

enumerator **ESP\_BLE\_MESH\_BRC\_CLIENT\_EVT\_MAX**

```
enum esp_ble_mesh_brc_server_cb_event_t
```

This enum value is the event of Bridge Configuration Server model

*Values:*

enumerator **ESP\_BLE\_MESH\_BRC\_SERVER\_STATE\_CHANGE\_EVT**

enumerator **ESP\_BLE\_MESH\_BRC\_SERVER\_EVT\_MAX**

## Mesh Private Beacon

### Header File

- `components/bt/esp_ble_mesh/v1.1/api/core/include/esp_ble_mesh_prb_model_api.h`
- This header file can be included with:

```
#include "esp_ble_mesh_prb_model_api.h"
```

- This header file is a part of the API provided by the `bt` component. To declare that your component depends on `bt`, add the following to your `CMakeLists.txt`:

```
REQUIRES bt
```

or

```
PRIV_REQUIRES bt
```

### Functions

*esp\_err\_t* **esp\_ble\_mesh\_register\_prb\_client\_callback** (*esp\_ble\_mesh\_prb\_client\_cb\_t* callback)

Register BLE Mesh Private Beacon Client Model callback.

**参数** **callback** -- **[in]** Pointer to the callback function.

**返回** ESP\_OK on success or error code otherwise.

*esp\_err\_t* **esp\_ble\_mesh\_register\_prb\_server\_callback** (*esp\_ble\_mesh\_prb\_server\_cb\_t* callback)

Register BLE Mesh Private Beacon Server Model callback.

**参数** **callback** -- **[in]** Pointer to the callback function.

**返回** ESP\_OK on success or error code otherwise.

*esp\_err\_t* **esp\_ble\_mesh\_prb\_client\_send** (*esp\_ble\_mesh\_client\_common\_param\_t* \*params, *esp\_ble\_mesh\_prb\_client\_msg\_t* \*msg)

Get/Set the value of Private Beacon Server Model states using the corresponding messages of Private Beacon Client Model.

**参数**

- **params** -- **[in]** Pointer to BLE Mesh common client parameters.
- **msg** -- **[in]** Pointer to Mesh Private Beacon Client message.

**返回** ESP\_OK on success or error code otherwise.

### Unions

union **esp\_ble\_mesh\_prb\_client\_msg\_t**

`#include <esp_ble_mesh_prb_model_api.h>` Mesh Private Beacon Client model message union.

### Public Members

*esp\_ble\_mesh\_priv\_beacon\_set\_t* **priv\_beacon\_set**

ESP\_BLE\_MESH\_MODEL\_OP\_PRIV\_BEACON\_SET.

*esp\_ble\_mesh\_priv\_gatt\_proxy\_set\_t* **priv\_gatt\_proxy\_set**

ESP\_BLE\_MESH\_MODEL\_OP\_PRIV\_GATT\_PROXY\_SET.

*esp\_ble\_mesh\_priv\_node\_id\_get\_t* **priv\_node\_id\_get**

ESP\_BLE\_MESH\_MODEL\_OP\_PRIV\_NODE\_IDENTITY\_GET.

*esp\_ble\_mesh\_priv\_node\_id\_set\_t* **priv\_node\_id\_set**

ESP\_BLE\_MESH\_MODEL\_OP\_PRIV\_NODE\_IDENTITY\_SET.

union **esp\_ble\_mesh\_prb\_client\_recv\_cb\_t**

*#include <esp\_ble\_mesh\_prb\_model\_api.h>* Private Beacon Client Model received message union.

### Public Members

*esp\_ble\_mesh\_priv\_beacon\_status\_cb\_t* **priv\_beacon\_status**

The private beacon status value

*esp\_ble\_mesh\_priv\_gatt\_proxy\_status\_cb\_t* **priv\_gatt\_proxy\_status**

The private gatt proxy status value

*esp\_ble\_mesh\_priv\_node\_identity\_status\_cb\_t* **priv\_node\_id\_status**

The private node identity status value

union **esp\_ble\_mesh\_prb\_server\_state\_change\_t**

*#include <esp\_ble\_mesh\_prb\_model\_api.h>* Mesh Private Beacon Server model state change value union.

### Public Members

*esp\_ble\_mesh\_state\_change\_priv\_beacon\_set\_t* **priv\_beacon\_set**

The *recv\_op* in *ctx* can be used to decide which state is changed. Private Beacon Set

*esp\_ble\_mesh\_state\_change\_priv\_gatt\_proxy\_set\_t* **priv\_gatt\_proxy\_set**

Private GATT Proxy Set

*esp\_ble\_mesh\_state\_change\_priv\_node\_id\_set\_t* **priv\_node\_id\_set**

Private Node Identity Set

union **esp\_ble\_mesh\_prb\_server\_cb\_value\_t**

*#include <esp\_ble\_mesh\_prb\_model\_api.h>* Private Beacon Server model callback value union.

### Public Members

*esp\_ble\_mesh\_prb\_server\_state\_change\_t* **state\_change**

ESP\_BLE\_MESH\_PRB\_SERVER\_STATE\_CHANGE\_EVT

### Structures

struct **esp\_ble\_mesh\_prb\_srv\_t**

Private Beacon Server Model context

**Public Members**

*esp\_ble\_mesh\_model\_t* \***model**

Pointer to Private Beacon Server Model

uint8\_t **private\_beacon**

Value of Private Beacon state

uint8\_t **random\_update\_interval**

Value of Random Update Interval Steps state

uint8\_t **private\_gatt\_proxy**

Value of Private GATT Proxy state

struct k\_delayed\_work **update\_timer**

Timer for update the random field of private beacon

struct **esp\_ble\_mesh\_priv\_beacon\_set\_t**

Parameter of private Beacon Set

**Public Members**

uint8\_t **private\_beacon**

New Private Beacon state

bool **is\_effect**

Decide if update\_interval exists

uint8\_t **update\_interval**

New Random Update Interval Steps state

struct **esp\_ble\_mesh\_priv\_gatt\_proxy\_set\_t**

Parameter of Private GATT Proxy Set

**Public Members**

uint8\_t **private\_gatt\_proxy**

New Private GATT Proxy state

struct **esp\_ble\_mesh\_priv\_node\_id\_get\_t**

Parameter of Private node identity Get

**Public Members**

uint16\_t **net\_idx**

Index of the NetKey

struct **esp\_ble\_mesh\_priv\_node\_id\_set\_t**

Parameter of Private node identity Set

### Public Members

uint16\_t **net\_idx**

Index of the NetKey

uint8\_t **private\_node\_id**

New Private Node Identity state

struct **esp\_ble\_mesh\_priv\_beacon\_status\_cb\_t**

Parameter of Private Beacon Status

### Public Members

uint8\_t **private\_beacon**

Current value of the Private Beacon state

uint8\_t **update\_interval**

Current value of the Random Update Interval Steps state

struct **esp\_ble\_mesh\_priv\_gatt\_proxy\_status\_cb\_t**

Parameter of Private GATT Proxy Status

### Public Members

uint8\_t **private\_gatt\_proxy**

Private GATT Proxy state

struct **esp\_ble\_mesh\_priv\_node\_identity\_status\_cb\_t**

Parameters of Private Node Identity Status

### Public Members

uint8\_t **status**

Status Code for the requesting message

uint16\_t **net\_idx**

Index of the NetKey

uint8\_t **private\_node\_id**

Private Node Identity state

struct **esp\_ble\_mesh\_prb\_client\_send\_cb\_t**

Result of sending Bridge Configuration Client messages

**Public Members****int err\_code**

Result of sending a message

**struct esp\_ble\_mesh\_prb\_client\_cb\_param\_t**

Mesh Private Beacon Client Model callback parameters

**Public Members***esp\_ble\_mesh\_client\_common\_param\_t* \*params

The client common parameters.

*esp\_ble\_mesh\_prb\_client\_send\_cb\_t* send

Result of sending a message

*esp\_ble\_mesh\_prb\_client\_rcv\_cb\_t* rcv

The private beacon message status callback values

union *esp\_ble\_mesh\_prb\_client\_cb\_param\_t*::[anonymous] [**anonymous**]

Union of Private Beacon Client callback

**struct esp\_ble\_mesh\_state\_change\_priv\_beacon\_set\_t**

Mesh Private Beacon Server model related context.

Parameters of Private Beacon Set.

**Public Members****uint8\_t private\_beacon**

Private Beacon state

**bool is\_effect**

Decide whether update\_interval effect

**uint8\_t update\_interval**

Random Update Interval Steps state

**struct esp\_ble\_mesh\_state\_change\_priv\_gatt\_proxy\_set\_t**

Parameters of Private GATT Proxy Set.

**Public Members****uint8\_t private\_gatt\_proxy**

Private GATT Proxy state

**struct esp\_ble\_mesh\_state\_change\_priv\_node\_id\_set\_t**

Parameters of Private Node Identity Set.

### Public Members

uint16\_t **net\_idx**

Index of the NetKey

uint8\_t **private\_node\_id**

Private Node Identity state

struct **esp\_ble\_mesh\_prb\_server\_cb\_param\_t**

Private Beacon Server model callback parameters

### Public Members

*esp\_ble\_mesh\_model\_t* \***model**

Pointer to the server model structure

*esp\_ble\_mesh\_msg\_ctx\_t* **ctx**

Context of the received message

*esp\_ble\_mesh\_prb\_server\_cb\_value\_t* **value**

Value of the received private beacon messages

### Macros

**ESP\_BLE\_MESH\_MODEL\_OP\_PRIV\_BEACON\_GET**

**ESP\_BLE\_MESH\_MODEL\_OP\_PRIV\_BEACON\_SET**

**ESP\_BLE\_MESH\_MODEL\_OP\_PRIV\_BEACON\_STATUS**

**ESP\_BLE\_MESH\_MODEL\_OP\_PRIV\_GATT\_PROXY\_GET**

**ESP\_BLE\_MESH\_MODEL\_OP\_PRIV\_GATT\_PROXY\_SET**

**ESP\_BLE\_MESH\_MODEL\_OP\_PRIV\_GATT\_PROXY\_STATUS**

**ESP\_BLE\_MESH\_MODEL\_OP\_PRIV\_NODE\_IDENTITY\_GET**

**ESP\_BLE\_MESH\_MODEL\_OP\_PRIV\_NODE\_IDENTITY\_SET**

**ESP\_BLE\_MESH\_MODEL\_OP\_PRIV\_NODE\_IDENTITY\_STATUS**

**ESP\_BLE\_MESH\_MODEL\_PRB\_SRV** (srv\_data)

Define a new Private Beacon Server Model.

---

**备注:** The Private Beacon Server Model can only be included by a Primary Element.

---

### 参数



- **srv\_data** -- Pointer to a unique Private Beacon Server Model user\_data.
- 返回 New Private Beacon Server Model instance.

**ESP\_BLE\_MESH\_MODEL\_PRB\_CLI** (cli\_data)

Define a new Private Beacon Client Model.

---

备注: The Private Beacon Client Model can only be included by a Primary Element.

---

#### 参数

- **cli\_data** -- Pointer to a unique struct *esp\_ble\_mesh\_client\_t*.
- 返回 New Private Beacon Client Model instance.

### Type Definitions

```
typedef void (*esp_ble_mesh_prb_client_cb_t)(esp_ble_mesh_prb_client_cb_event_t event,
esp_ble_mesh_prb_client_cb_param_t *param)
```

Bluetooth Mesh Private Beacon Client and Server Model functions.

Private Beacon Client Model callback function type

**Param event** Event type

**Param param** Pointer to callback parameter

```
typedef void (*esp_ble_mesh_prb_server_cb_t)(esp_ble_mesh_prb_server_cb_event_t event,
esp_ble_mesh_prb_server_cb_param_t *param)
```

Private Beacon Server Model callback function type.

**Param event** Event type

**Param param** Pointer to callback parameter

### Enumerations

```
enum esp_ble_mesh_prb_client_cb_event_t
```

This enum value is the event of Private Beacon Client Model

Values:

enumerator **ESP\_BLE\_MESH\_PRB\_CLIENT\_SEND\_COMP\_EVT**

enumerator **ESP\_BLE\_MESH\_PRB\_CLIENT\_SEND\_TIMEOUT\_EVT**

enumerator **ESP\_BLE\_MESH\_PRB\_CLIENT\_RECV\_RSP\_EVT**

enumerator **ESP\_BLE\_MESH\_PRB\_CLIENT\_RECV\_PUB\_EVT**

enumerator **ESP\_BLE\_MESH\_PRB\_CLIENT\_EVT\_MAX**

```
enum esp_ble_mesh_prb_server_cb_event_t
```

This enum value is the event of Private Beacon Server model

Values:

enumerator **ESP\_BLE\_MESH\_PRB\_SERVER\_STATE\_CHANGE\_EVT**

enumerator **ESP\_BLE\_MESH\_PRB\_SERVER\_EVT\_MAX**

## On-Demand Private Proxy

### Header File

- `components/bt/esp_ble_mesh/v1.1/api/core/include/esp_ble_mesh_odp_model_api.h`
- This header file can be included with:

```
#include "esp_ble_mesh_odp_model_api.h"
```

- This header file is a part of the API provided by the `bt` component. To declare that your component depends on `bt`, add the following to your `CMakeLists.txt`:

```
REQUIRES bt
```

or

```
PRIV_REQUIRES bt
```

### Functions

`esp_err_t esp_ble_mesh_register_odp_client_callback` (`esp_ble_mesh_odp_client_cb_t` callback)

Register BLE Mesh On-Demand Private Proxy Config Client model callback.

**参数** `callback` -- [in] Pointer to the callback function.

**返回** `ESP_OK` on success or error code otherwise.

`esp_err_t esp_ble_mesh_odp_client_send` (`esp_ble_mesh_client_common_param_t` \*params, `esp_ble_mesh_odp_client_msg_t` \*msg)

Get the value of On-Demand Private Proxy Config Server model state with the corresponding get message.

**参数**

- `params` -- [in] Pointer to BLE Mesh common client parameters.
- `msg` -- [in] Pointer to On-Demand Private Proxy Config Client message.

**返回** `ESP_OK` on success or error code otherwise.

`esp_err_t esp_ble_mesh_register_odp_server_callback` (`esp_ble_mesh_odp_server_cb_t` callback)

Register BLE Mesh On-Demand Private Proxy Config Server model callback.

**参数** `callback` -- [in] Pointer to the callback function.

**返回** `ESP_OK` on success or error code otherwise.

### Unions

union `esp_ble_mesh_odp_client_msg_t`

`#include <esp_ble_mesh_odp_model_api.h>` On-Demand Private Proxy Client model message union.

### Public Members

`esp_ble_mesh_od_priv_proxy_set_t od_priv_proxy_set`

For `ESP_BLE_MESH_MODEL_OP_OD_PRIV_PROXY_SET`

union `esp_ble_mesh_odp_client_recv_cb_t`

`#include <esp_ble_mesh_odp_model_api.h>` On-Demand Private Proxy Client model received message union.

### Public Members

*esp\_ble\_mesh\_od\_priv\_proxy\_status\_t* **od\_priv\_proxy\_status**

For ESP\_BLE\_MESH\_MODEL\_OP\_OD\_PRIV\_PROXY\_STATUS

union **esp\_ble\_mesh\_odp\_server\_state\_change\_t**

*#include <esp\_ble\_mesh\_odp\_model\_api.h>* On-Demand Private Proxy Config Server model related context.

On-Demand Private Proxy Config Server model state change value union

### Public Members

uint8\_t **dummy**

Event not used currently

union **esp\_ble\_mesh\_odp\_server\_cb\_value\_t**

*#include <esp\_ble\_mesh\_odp\_model\_api.h>* On-Demand Private Proxy Config Server model callback value union.

### Public Members

*esp\_ble\_mesh\_odp\_server\_state\_change\_t* **state\_change**

For ESP\_BLE\_MESH\_ODP\_SERVER\_STATE\_CHANGE\_EVT

## Structures

struct **esp\_ble\_mesh\_odp\_srv\_t**

On-Demand Private Proxy Config Server model context

### Public Members

*esp\_ble\_mesh\_model\_t* \***model**

Pointer to On-Demand Private Proxy Config Server model

uint8\_t **on\_demand\_private\_gatt\_proxy**

Duration in seconds of the interval during which advertising with Private Network Identity type is enabled after receiving a Solicitation PDU or after a client disconnect. Note: Binding with the Private GATT Proxy state.

struct **esp\_ble\_mesh\_od\_priv\_proxy\_set\_t**

Parameter of On-Demand Private Proxy Set

### Public Members

uint8\_t **gatt\_proxy**

On-Demand Private GATT Proxy

struct **esp\_ble\_mesh\_od\_priv\_proxy\_status\_t**

Parameter of On-Demand Private Proxy Status

**Public Members**`uint8_t gatt_proxy`

On-Demand Private GATT Proxy

struct `esp_ble_mesh_odp_client_send_cb_t`

Result of sending On-Demand Private Proxy Client messages

**Public Members**int `err_code`

Result of sending a message

struct `esp_ble_mesh_odp_client_cb_param_t`

On-Demand Private Proxy Config Client model callback parameters

**Public Members**`esp_ble_mesh_client_common_param_t *params`

Client common parameters, used by all events

`esp_ble_mesh_odp_client_send_cb_t send`

Result of sending a message

`esp_ble_mesh_odp_client_rcv_cb_t rcv`

Parameters of received status message

union `esp_ble_mesh_odp_client_cb_param_t::[anonymous]` [**anonymous**]

Union of ODP Client callback

struct `esp_ble_mesh_odp_server_cb_param_t`

On-Demand Private Proxy Config Server model callback parameters

**Public Members**`esp_ble_mesh_model_t *model`

Pointer to the server model structure

`esp_ble_mesh_msg_ctx_t ctx`

Context of the received message

`esp_ble_mesh_odp_server_cb_value_t value`

Value of the received configuration messages

## Macros

**ESP\_BLE\_MESH\_MODEL\_OP\_OD\_PRIV\_PROXY\_GET**

**ESP\_BLE\_MESH\_MODEL\_OP\_OD\_PRIV\_PROXY\_SET**

**ESP\_BLE\_MESH\_MODEL\_OP\_OD\_PRIV\_PROXY\_STATUS**

**ESP\_BLE\_MESH\_MODEL\_ODP\_SRV** (srv\_data)

Define a new On-Demand Private Proxy Config Server model.

---

**备注:** The On-Demand Private Proxy Server model is used to represent the ability to enable advertising with Private Network Identity type of a node. This model extends the Mesh Private Beacon Server model. When this model is present on an element, the corresponding Solicitation PDU RPL Configuration Server model shall also be present. The model shall be supported by a primary element and shall not be supported by any secondary elements.

---

### 参数

- **srv\_data** -- Pointer to a unique On-Demand Private Proxy Config Server model user\_data.

**返回** New On-Demand Private Proxy Config Server model instance.

**ESP\_BLE\_MESH\_MODEL\_ODP\_CLI** (cli\_data)

Define a new On-Demand Private Proxy Config Client model.

---

**备注:** The model shall be supported by a primary element and shall not be supported by any secondary elements.

---

### 参数

- **cli\_data** -- Pointer to a unique On-Demand Private Proxy Config Client model user\_data.

**返回** New On-Demand Private Proxy Config Client model instance.

## Type Definitions

```
typedef void (*esp_ble_mesh_odp_client_cb_t)(esp_ble_mesh_odp_client_cb_event_t event,
esp_ble_mesh_odp_client_cb_param_t *param)
```

Bluetooth Mesh On-Demand Private Proxy Config client and server model functions.

On-Demand Private Proxy Config Client model callback function type

**Param event** Event type

**Param param** Pointer to callback parameter

```
typedef void (*esp_ble_mesh_odp_server_cb_t)(esp_ble_mesh_odp_server_cb_event_t event,
esp_ble_mesh_odp_server_cb_param_t *param)
```

On-Demand Private Proxy Config Server model callback function type.

**Param event** Event type

**Param param** Pointer to callback parameter

## Enumerations

enum **esp\_ble\_mesh\_odp\_client\_cb\_event\_t**

This enum value is the event of On-Demand Private Proxy Config Client model

*Values:*

enumerator **ESP\_BLE\_MESH\_ODP\_CLIENT\_SEND\_COMP\_EVT**

enumerator **ESP\_BLE\_MESH\_ODP\_CLIENT\_SEND\_TIMEOUT\_EVT**

enumerator **ESP\_BLE\_MESH\_ODP\_CLIENT\_RECV\_RSP\_EVT**

enumerator **ESP\_BLE\_MESH\_ODP\_CLIENT\_RECV\_PUB\_EVT**

enumerator **ESP\_BLE\_MESH\_ODP\_CLIENT\_EVT\_MAX**

enum **esp\_ble\_mesh\_odp\_server\_cb\_event\_t**

This enum value is the event of On-Demand Private Proxy Config Server model

*Values:*

enumerator **ESP\_BLE\_MESH\_ODP\_SERVER\_STATE\_CHANGE\_EVT**

enumerator **ESP\_BLE\_MESH\_ODP\_SERVER\_EVT\_MAX**

## SAR Configuration

### Header File

- `components/bt/esp_ble_mesh/v1.1/api/core/include/esp_ble_mesh_sar_model_api.h`
- This header file can be included with:

```
#include "esp_ble_mesh_sar_model_api.h"
```

- This header file is a part of the API provided by the `bt` component. To declare that your component depends on `bt`, add the following to your `CMakeLists.txt`:

```
REQUIRES bt
```

or

```
PRIV_REQUIRES bt
```

### Functions

*esp\_err\_t* **esp\_ble\_mesh\_register\_sar\_client\_callback** (*esp\_ble\_mesh\_sar\_client\_cb\_t* callback)

Register BLE Mesh SAR Configuration Client model callback.

**参数** **callback** -- **[in]** Pointer to the callback function.

**返回** `ESP_OK` on success or error code otherwise.

*esp\_err\_t* **esp\_ble\_mesh\_sar\_client\_send** (*esp\_ble\_mesh\_client\_common\_param\_t* \*params, *esp\_ble\_mesh\_sar\_client\_msg\_t* \*msg)

Get the value of SAR Configuration Server model state with the corresponding get message.

**参数**

- **params** -- **[in]** Pointer to BLE Mesh common client parameters.
- **msg** -- **[in]** Pointer to SAR Configuration Client message.

返回 ESP\_OK on success or error code otherwise.

*esp\_err\_t* **esp\_ble\_mesh\_register\_sar\_server\_callback** (*esp\_ble\_mesh\_sar\_server\_cb\_t* callback)

Register BLE Mesh SAR Configuration Server model callback.

参数 **callback** -- [in] Pointer to the callback function.

返回 ESP\_OK on success or error code otherwise.

## Unions

union **esp\_ble\_mesh\_sar\_client\_msg\_t**

*#include* <*esp\_ble\_mesh\_sar\_model\_api.h*> SAR Configuration Client model message union.

### Public Members

*esp\_ble\_mesh\_sar\_transmitter\_set\_t* **sar\_transmitter\_set**

For ESP\_BLE\_MESH\_MODEL\_OP\_SAR\_TRANSMITTER\_SET

*esp\_ble\_mesh\_sar\_receiver\_set\_t* **sar\_receiver\_set**

For ESP\_BLE\_MESH\_MODEL\_OP\_SAR\_RECEIVER\_SET

union **esp\_ble\_mesh\_sar\_client\_rcv\_cb\_t**

*#include* <*esp\_ble\_mesh\_sar\_model\_api.h*> SAR Configuration Client model received message union.

### Public Members

*esp\_ble\_mesh\_sar\_transmitter\_status\_t* **sar\_transmitter\_status**

For ESP\_BLE\_MESH\_MODEL\_OP\_SAR\_TRANSMITTER\_STATUS

*esp\_ble\_mesh\_sar\_receiver\_status\_t* **sar\_receiver\_status**

For ESP\_BLE\_MESH\_MODEL\_OP\_SAR\_RECEIVE\_STATUS

union **esp\_ble\_mesh\_sar\_server\_state\_change\_t**

*#include* <*esp\_ble\_mesh\_sar\_model\_api.h*> SAR Configuration Server model related context.

SAR Configuration Server model state change value union

### Public Members

uint8\_t **dummy**

Event not used currently

union **esp\_ble\_mesh\_sar\_server\_cb\_value\_t**

*#include* <*esp\_ble\_mesh\_sar\_model\_api.h*> SAR Configuration Server model callback value union.

### Public Members

*esp\_ble\_mesh\_sar\_server\_state\_change\_t* **state\_change**

For ESP\_BLE\_MESH\_SAR\_SERVER\_STATE\_CHANGE\_EVT

## Structures

struct **esp\_ble\_mesh\_sar\_srv\_t**  
SAR Configuration Server model context

### Public Members

*esp\_ble\_mesh\_model\_t* \***model**  
Pointer to SAR Configuration Server model

struct **esp\_ble\_mesh\_sar\_transmitter\_set\_t**  
Parameters of SAR Transmitter Set

### Public Members

uint8\_t **sar\_segment\_interval\_step**  
SAR Segment Interval Step state value

uint8\_t **sar\_unicast\_retrans\_count**  
SAR Unicast Retransmissions Count state

uint8\_t **sar\_unicast\_retrans\_without\_progress\_count**  
SAR Unicast Retransmissions Without Progress Count state

uint8\_t **sar\_unicast\_retrans\_interval\_step**  
SAR Unicast Retransmissions Interval Step state

uint8\_t **sar\_unicast\_retrans\_interval\_increment**  
SAR Unicast Retransmissions Interval Increment state

uint8\_t **sar\_multicast\_retrans\_count**  
SAR Multicast Retransmissions Count state

uint8\_t **sar\_multicast\_retrans\_interval\_step**  
SAR Multicast Retransmissions Interval state

struct **esp\_ble\_mesh\_sar\_receiver\_set\_t**  
Parameters of SAR Receiver Set

### Public Members

uint8\_t **sar\_segments\_threshold**  
SAR Segments Threshold state

uint8\_t **sar\_ack\_delay\_increment**  
SAR Acknowledgment Delay Increment state



`uint8_t sar_discard_timeout`

SAR Discard Timeout state

`uint8_t sar_receiver_segment_interval_step`

SAR Receiver Segment Interval Step state

`uint8_t sar_ack_retrans_count`

SAR Acknowledgment Retransmissions Count state

struct `esp_ble_mesh_sar_transmitter_status_t`

Parameters of SAR Transmitter Status

### Public Members

`uint8_t sar_segment_interval_step`

SAR Segment Interval Step state value

`uint8_t sar_unicast_retrans_count`

SAR Unicast Retransmissions Count state

`uint8_t sar_unicast_retrans_without_progress_count`

SAR Unicast Retransmissions Without Progress Count state

`uint8_t sar_unicast_retrans_interval_step`

SAR Unicast Retransmissions Interval Step state

`uint8_t sar_unicast_retrans_interval_increment`

SAR Unicast Retransmissions Interval Increment state

`uint8_t sar_multicast_retrans_count`

SAR Multicast Retransmissions Count state

`uint8_t sar_multicast_retrans_interval_step`

SAR Multicast Retransmissions Interval state

struct `esp_ble_mesh_sar_receiver_status_t`

Parameters of SAR Receiver Status

### Public Members

`uint8_t sar_segments_threshold`

SAR Segments Threshold state

`uint8_t sar_ack_delay_increment`

SAR Acknowledgment Delay Increment state

uint8\_t **sar\_discard\_timeout**

SAR Discard Timeout state

uint8\_t **sar\_receiver\_segment\_interval\_step**

SAR Receiver Segment Interval Step state

uint8\_t **sar\_ack\_retrans\_count**

SAR Acknowledgment Retransmissions Count state

struct **esp\_ble\_mesh\_sar\_client\_send\_cb\_t**

Result of sending SAR Configuration Client messages

### Public Members

int **err\_code**

Result of sending a message

struct **esp\_ble\_mesh\_sar\_client\_cb\_param\_t**

SAR Configuration Client model callback parameters

### Public Members

*esp\_ble\_mesh\_client\_common\_param\_t* \***params**

Client common parameters, used by all events.

*esp\_ble\_mesh\_sar\_client\_send\_cb\_t* **send**

Result of sending a message

*esp\_ble\_mesh\_sar\_client\_rcv\_cb\_t* **rcv**

Parameters of received status message

union *esp\_ble\_mesh\_sar\_client\_cb\_param\_t*::[anonymous] [**anonymous**]

Union of SAR Client callback

struct **esp\_ble\_mesh\_sar\_server\_cb\_param\_t**

SAR Configuration Server model callback parameters

### Public Members

*esp\_ble\_mesh\_model\_t* \***model**

Pointer to the server model structure

*esp\_ble\_mesh\_msg\_ctx\_t* **ctx**

Context of the received message

*esp\_ble\_mesh\_sar\_server\_cb\_value\_t* **value**

Value of the received configuration messages

## Macros

**ESP\_BLE\_MESH\_MODEL\_OP\_SAR\_TRANSMITTER\_GET**

**ESP\_BLE\_MESH\_MODEL\_OP\_SAR\_TRANSMITTER\_SET**

**ESP\_BLE\_MESH\_MODEL\_OP\_SAR\_TRANSMITTER\_STATUS**

**ESP\_BLE\_MESH\_MODEL\_OP\_SAR\_RECEIVER\_GET**

**ESP\_BLE\_MESH\_MODEL\_OP\_SAR\_RECEIVER\_SET**

**ESP\_BLE\_MESH\_MODEL\_OP\_SAR\_RECEIVER\_STATUS**

**ESP\_BLE\_MESH\_MODEL\_SAR\_SRV** (srv\_data)

Define a new SAR Configuration Server model.

---

**备注:** If supported, the model shall be supported by a primary element and shall not be supported by any secondary elements.

---

### 参数

- **srv\_data** -- Pointer to a unique SAR Configuration Server model user\_data.

**返回** New SAR Configuration Server model instance.

**ESP\_BLE\_MESH\_MODEL\_SAR\_CLI** (cli\_data)

Define a new SAR Configuration Client model.

---

**备注:** If supported, the model shall be supported by the primary element and shall not be supported by any secondary elements.

---

### 参数

- **cli\_data** -- Pointer to a unique SAR Configuration Client model user\_data.

**返回** New SAR Configuration Client model instance.

## Type Definitions

typedef void (\***esp\_ble\_mesh\_sar\_client\_cb\_t**)(*esp\_ble\_mesh\_sar\_client\_cb\_event\_t* event, *esp\_ble\_mesh\_sar\_client\_cb\_param\_t* \*param)

Bluetooth Mesh SAR Configuration client and server model functions.

SAR Configuration Client model callback function type

**Param event** Event type

**Param param** Pointer to callback parameter

typedef void (\***esp\_ble\_mesh\_sar\_server\_cb\_t**)(*esp\_ble\_mesh\_sar\_server\_cb\_event\_t* event, *esp\_ble\_mesh\_sar\_server\_cb\_param\_t* \*param)

SAR Configuration Server model callback function type.

**Param event** Event type

**Param param** Pointer to callback parameter

## Enumerations

enum **esp\_ble\_mesh\_sar\_client\_cb\_event\_t**

This enum value is the event of SAR Configuration Client model

Values:

enumerator **ESP\_BLE\_MESH\_SAR\_CLIENT\_SEND\_COMP\_EVT**

enumerator **ESP\_BLE\_MESH\_SAR\_CLIENT\_SEND\_TIMEOUT\_EVT**

enumerator **ESP\_BLE\_MESH\_SAR\_CLIENT\_RECV\_RSP\_EVT**

enumerator **ESP\_BLE\_MESH\_SAR\_CLIENT\_RECV\_PUB\_EVT**

enumerator **ESP\_BLE\_MESH\_SAR\_CLIENT\_EVT\_MAX**

enum **esp\_ble\_mesh\_sar\_server\_cb\_event\_t**

This enum value is the event of SAR Configuration Server model

Values:

enumerator **ESP\_BLE\_MESH\_SAR\_SERVER\_STATE\_CHANGE\_EVT**

enumerator **ESP\_BLE\_MESH\_SAR\_SERVER\_EVT\_MAX**

## Solicitation PDU RPL Configuration

### Header File

- `components/bt/esp_ble_mesh/v1.1/api/core/include/esp_ble_mesh_srpl_model_api.h`
- This header file can be included with:

```
#include "esp_ble_mesh_srpl_model_api.h"
```

- This header file is a part of the API provided by the `bt` component. To declare that your component depends on `bt`, add the following to your `CMakeLists.txt`:

```
REQUIRES bt
```

or

```
PRIV_REQUIRES bt
```

### Functions

*esp\_err\_t* **esp\_ble\_mesh\_register\_srpl\_client\_callback** (*esp\_ble\_mesh\_srpl\_client\_cb\_t* callback)

Register BLE Mesh Solicitation PDU RPL Configuration Client model callback.

参数 **callback** -- [in] Pointer to the callback function.

返回 ESP\_OK on success or error code otherwise.

*esp\_err\_t* **esp\_ble\_mesh\_srpl\_client\_send** (*esp\_ble\_mesh\_client\_common\_param\_t* \*params, *esp\_ble\_mesh\_srpl\_client\_msg\_t* \*msg)

Set the value of Solicitation PDU RPL Configuration Server model state with the corresponding set message.

参数

- **params** -- [in] Pointer to BLE Mesh common client parameters.
  - **msg** -- [in] Pointer to Solicitation PDU RPL Configuration Client message.
- 返回 ESP\_OK on success or error code otherwise.

*esp\_err\_t* **esp\_ble\_mesh\_register\_srpl\_server\_callback** (*esp\_ble\_mesh\_srpl\_server\_cb\_t* callback)

Register BLE Mesh Solicitation PDU RPL Configuration Server model callback.

- 参数 **callback** -- [in] Pointer to the callback function.  
 返回 ESP\_OK on success or error code otherwise.

## Unions

union **esp\_ble\_mesh\_srpl\_client\_msg\_t**

#include <esp\_ble\_mesh\_srpl\_model\_api.h> Solicitation PDU RPL Configuration Client model message union.

### Public Members

*esp\_ble\_mesh\_srpl\_items\_clear\_t* **srpl\_items\_clear**

For ESP\_BLE\_MESH\_MODEL\_OP\_SRPL\_ITEMS\_CLEAR

union **esp\_ble\_mesh\_srpl\_client\_recv\_cb\_t**

#include <esp\_ble\_mesh\_srpl\_model\_api.h> Solicitation PDU RPL Configuration Client model received message union.

### Public Members

*esp\_ble\_mesh\_srpl\_items\_status\_t* **srpl\_items\_status**

For ESP\_BLE\_MESH\_MODEL\_OP\_SRPL\_ITEMS\_STATUS

union **esp\_ble\_mesh\_srpl\_server\_state\_change\_t**

#include <esp\_ble\_mesh\_srpl\_model\_api.h> Solicitation PDU RPL Configuration Server model related context.

Solicitation PDU RPL Configuration Server model state change value union

### Public Members

uint8\_t **dummy**

Currently this event is not used.

union **esp\_ble\_mesh\_srpl\_server\_cb\_value\_t**

#include <esp\_ble\_mesh\_srpl\_model\_api.h> Solicitation PDU RPL Configuration Server model callback value union.

### Public Members

*esp\_ble\_mesh\_srpl\_server\_state\_change\_t* **state\_change**

ESP\_BLE\_MESH\_SRPL\_SERVER\_STATE\_CHANGE\_EVT

## Structures

struct **esp\_ble\_mesh\_srpl\_srv\_t**  
Solicitation PDU RPL Configuration Server model context

### Public Members

*esp\_ble\_mesh\_model\_t* \***model**  
Pointer to Solicitation PDU RPL Configuration Server model

struct **esp\_ble\_mesh\_srpl\_items\_clear\_t**  
Parameter of Solicitation PDU RPL Items Clear

### Public Members

*esp\_ble\_mesh\_uar\_t* **addr\_range**  
Unicast address range

struct **esp\_ble\_mesh\_srpl\_items\_status\_t**  
Parameter of Solicitation PDU RPL Items Clear Status

### Public Members

*esp\_ble\_mesh\_uar\_t* **addr\_range**  
Unicast address range

struct **esp\_ble\_mesh\_srpl\_client\_send\_cb\_t**  
Result of sending Solicitation PDU RPL Configuration Client messages

### Public Members

int **err\_code**  
Result of sending a message

struct **esp\_ble\_mesh\_srpl\_client\_cb\_param\_t**  
Solicitation PDU RPL Configuration Client model callback parameters

### Public Members

*esp\_ble\_mesh\_client\_common\_param\_t* \***params**  
Client common parameters, used by all events.

*esp\_ble\_mesh\_srpl\_client\_send\_cb\_t* **send**  
Result of sending a message

*esp\_ble\_mesh\_srpl\_client\_rcv\_cb\_t* **rcv**

Parameters of received status message

union *esp\_ble\_mesh\_srpl\_client\_cb\_param\_t*::[anonymous] [**anonymous**]

Union of SRPL Client callback

struct **esp\_ble\_mesh\_srpl\_server\_cb\_param\_t**

Solicitation PDU RPL Configuration Server model callback parameters

### Public Members

*esp\_ble\_mesh\_model\_t* \***model**

Pointer to the server model structure

*esp\_ble\_mesh\_msg\_ctx\_t* **ctx**

Context of the received message

*esp\_ble\_mesh\_srpl\_server\_cb\_value\_t* **value**

Value of the received configuration messages

### Macros

**ESP\_BLE\_MESH\_MODEL\_OP\_SRPL\_ITEMS\_CLEAR**

**ESP\_BLE\_MESH\_MODEL\_OP\_SRPL\_ITEMS\_CLEAR\_UNACK**

**ESP\_BLE\_MESH\_MODEL\_OP\_SRPL\_ITEMS\_STATUS**

**ESP\_BLE\_MESH\_MODEL\_SRPL\_SRV** (srv\_data)

Define a new Solicitation PDU RPL Configuration Server model.

---

**备注:** The Solicitation PDU RPL Configuration Server model extends the On-Demand Private Proxy Server model. If the model is supported, the model shall be supported by a primary element and shall not be supported by any secondary elements.

---

#### 参数

- **srv\_data** -- Pointer to a unique Solicitation PDU RPL Configuration Server model user\_data.

**返回** New Solicitation PDU RPL Configuration Server model instance.

**ESP\_BLE\_MESH\_MODEL\_SRPL\_CLI** (cli\_data)

Define a new Solicitation PDU RPL Configuration Client model.

---

**备注:** If supported, the model shall be supported by the primary element and shall not be supported by any secondary elements.

---

#### 参数

- **cli\_data** -- Pointer to a unique Solicitation PDU RPL Configuration Client model user\_data.

**返回** New Solicitation PDU RPL Configuration Client model instance.

## Type Definitions

```
typedef void (*esp_ble_mesh_srpl_client_cb_t)(esp_ble_mesh_srpl_client_cb_event_t event,  
esp_ble_mesh_srpl_client_cb_param_t *param)
```

Bluetooth Mesh Solicitation PDU RPL Configuration client and server model functions.

Solicitation PDU RPL Configuration Client model callback function type

**Param event** Event type

**Param param** Pointer to callback parameter

```
typedef void (*esp_ble_mesh_srpl_server_cb_t)(esp_ble_mesh_srpl_server_cb_event_t event,  
esp_ble_mesh_srpl_server_cb_param_t *param)
```

Solicitation PDU RPL Configuration Server model callback function type.

**Param event** Event type

**Param param** Pointer to callback parameter

## Enumerations

```
enum esp_ble_mesh_srpl_client_cb_event_t
```

This enum value is the event of Solicitation PDU RPL Configuration Client model

*Values:*

enumerator **ESP\_BLE\_MESH\_SRPL\_CLIENT\_SEND\_COMP\_EVT**

enumerator **ESP\_BLE\_MESH\_SRPL\_CLIENT\_SEND\_TIMEOUT\_EVT**

enumerator **ESP\_BLE\_MESH\_SRPL\_CLIENT\_RECV\_RSP\_EVT**

enumerator **ESP\_BLE\_MESH\_SRPL\_CLIENT\_RECV\_PUB\_EVT**

enumerator **ESP\_BLE\_MESH\_SRPL\_CLIENT\_EVT\_MAX**

```
enum esp_ble_mesh_srpl_server_cb_event_t
```

This enum value is the event of Solicitation PDU RPL Configuration Server model

*Values:*

enumerator **ESP\_BLE\_MESH\_SRPL\_SERVER\_STATE\_CHANGE\_EVT**

enumerator **ESP\_BLE\_MESH\_SRPL\_SERVER\_EVT\_MAX**

## Opcodes Aggregator

### Header File

- `components/bt/esp_ble_mesh/v1.1/api/core/include/esp_ble_mesh_agg_model_api.h`
- This header file can be included with:

```
#include "esp_ble_mesh_agg_model_api.h"
```

- This header file is a part of the API provided by the `bt` component. To declare that your component depends on `bt`, add the following to your `CMakeLists.txt`:



```
REQUIRES bt
```

or

```
PRIV_REQUIRES bt
```

## Functions

*esp\_err\_t* **esp\_ble\_mesh\_register\_agg\_client\_callback** (*esp\_ble\_mesh\_agg\_client\_cb\_t* callback)

Register BLE Mesh Opcodes Aggregator Client model callback.

参数 **callback** -- [in] Pointer to the callback function.

返回 ESP\_OK on success or error code otherwise.

*esp\_err\_t* **esp\_ble\_mesh\_agg\_client\_send** (*esp\_ble\_mesh\_client\_common\_param\_t* \*params,  
*esp\_ble\_mesh\_agg\_client\_msg\_t* \*msg)

Set the value of Opcodes Aggregator Server model state with the corresponding set message.

参数

- **params** -- [in] Pointer to BLE Mesh common client parameters.
- **msg** -- [in] Pointer to Opcodes Aggregator Client message.

返回 ESP\_OK on success or error code otherwise.

*esp\_err\_t* **esp\_ble\_mesh\_register\_agg\_server\_callback** (*esp\_ble\_mesh\_agg\_server\_cb\_t*  
callback)

Register BLE Mesh Opcodes Aggregator Server model callback.

参数 **callback** -- [in] Pointer to the callback function.

返回 ESP\_OK on success or error code otherwise.

## Unions

union **esp\_ble\_mesh\_agg\_client\_msg\_t**

#include <esp\_ble\_mesh\_agg\_model\_api.h> Opcodes Aggregator Client model message union.

## Public Members

*esp\_ble\_mesh\_agg\_sequence\_t* **agg\_sequence**

For ESP\_BLE\_MESH\_MODEL\_OP\_AGG\_SEQUENCE

union **esp\_ble\_mesh\_agg\_client\_rcv\_cb\_t**

#include <esp\_ble\_mesh\_agg\_model\_api.h> Opcodes Aggregator Client model received message union.

## Public Members

*esp\_ble\_mesh\_agg\_status\_t* **agg\_status**

For ESP\_BLE\_MESH\_MODEL\_OP\_AGG\_STATUS

union **esp\_ble\_mesh\_agg\_server\_rcv\_msg\_t**

#include <esp\_ble\_mesh\_agg\_model\_api.h> Opcodes Aggregator Server model related context.

Opcodes Aggregator Server model received message union

### Public Members

*esp\_ble\_mesh\_agg\_sequence\_t* **agg\_sequence**

For ESP\_BLE\_MESH\_MODEL\_OP\_AGG\_SEQUENCE

### Structures

struct **esp\_ble\_mesh\_agg\_srv\_t**

Opcodes Aggregator Server model context

### Public Members

*esp\_ble\_mesh\_model\_t* \***model**

Pointer to Opcodes Aggregator Server model

struct **esp\_ble\_mesh\_agg\_item\_t**

Parameters of Aggregator Item

### Public Members

uint16\_t **length\_format**

0: Length\_Short; 1: Length\_Long

uint16\_t **length**

Size of Opcode\_And\_Parameters field

const uint8\_t \***data**

Opcode and parameters

struct **esp\_ble\_mesh\_agg\_sequence\_t**

Parameters of Opcodes Aggregator Sequence

### Public Members

uint16\_t **element\_addr**

Element address

struct net\_buf\_simple \***items**

List of items with each item represented as an Aggregator Item

struct **esp\_ble\_mesh\_agg\_status\_t**

Parameters of Opcodes Aggregator Status

### Public Members

`uint8_t status`

Status of the most recent operation

`uint16_t element_addr`

Element Address

`struct net_buf_simple *items`

List of status items with each status item containing an unacknowledged access layer message or empty item (Optional)

`struct esp_ble_mesh_agg_client_send_cb_t`

Result of sending Opcodes Aggregator Client messages

### Public Members

`int err_code`

Result of sending a message

`struct esp_ble_mesh_agg_client_cb_param_t`

Opcodes Aggregator Client model callback parameters

### Public Members

`esp_ble_mesh_client_common_param_t *params`

Client common parameters, used by all events

`esp_ble_mesh_agg_client_send_cb_t send`

Result of sending a message

`esp_ble_mesh_agg_client_rcv_cb_t rcv`

Parameters of received status message

`union esp_ble_mesh_agg_client_cb_param_t::[anonymous] [anonymous]`

Union of AGG Client callback

`struct esp_ble_mesh_agg_server_cb_param_t`

Opcodes Aggregator Server model callback parameters

### Public Members

`esp_ble_mesh_model_t *model`

Pointer to the server model structure

`esp_ble_mesh_msg_ctx_t ctx`

Context of the received message

*esp\_ble\_mesh\_agg\_server\_rcv\_msg\_t* **rcv**

Received message callback values

union *esp\_ble\_mesh\_agg\_server\_cb\_param\_t*::[anonymous] [**anonymous**]

Union of AGG Server callback

## Macros

**ESP\_BLE\_MESH\_MODEL\_OP\_AGG\_SEQUENCE**

Defines the Opcodes Aggregator message opcode.

**ESP\_BLE\_MESH\_MODEL\_OP\_AGG\_STATUS**

**ESP\_BLE\_MESH\_AGG\_STATUS\_SUCCESS**

Defines the status codes for Opcodes Aggregator messages.

**ESP\_BLE\_MESH\_AGG\_STATUS\_INVALID\_ADDRESS**

**ESP\_BLE\_MESH\_AGG\_STATUS\_INVALID\_MODEL**

**ESP\_BLE\_MESH\_AGG\_STATUS\_WRONG\_ACCESS\_KEY**

**ESP\_BLE\_MESH\_AGG\_STATUS\_WRONG\_OPCODE**

**ESP\_BLE\_MESH\_AGG\_STATUS\_MSG\_NOT\_UNDERSTOOD**

**ESP\_BLE\_MESH\_AGG\_ITEM\_LENGTH\_FORMAT\_SHORT**

Values of the Length\_Format

**ESP\_BLE\_MESH\_AGG\_ITEM\_LENGTH\_FORMAT\_LONG**

**ESP\_BLE\_MESH\_MODEL\_AGG\_SRV** (*srv\_data*)

Define a new Opcodes Aggregator Server model.

---

**备注:** If supported, the Opcodes Aggregator Server model shall be supported by a primary element.

---

### 参数

- **srv\_data** -- Pointer to a unique Opcodes Aggregator Server model user\_data.

**返回** New Opcodes Aggregator Server model instance.

**ESP\_BLE\_MESH\_MODEL\_AGG\_CLI** (*cli\_data*)

Define a new Opcodes Aggregator Client model.

---

**备注:** If supported, the model shall be supported by the primary element and shall not be supported by any secondary elements.

---

### 参数

- **cli\_data** -- Pointer to a unique Opcodes Aggregator Client model user\_data.

**返回** New Opcodes Aggregator Client model instance.

## Type Definitions

```
typedef void (*esp_ble_mesh_agg_client_cb_t)(esp_ble_mesh_agg_client_cb_event_t event,  
esp_ble_mesh_agg_client_cb_param_t *param)
```

Bluetooth Mesh Opcodes Aggregator client and server model functions.

Opcodes Aggregator Client model callback function type

**Param event** Event type

**Param param** Pointer to callback parameter

```
typedef void (*esp_ble_mesh_agg_server_cb_t)(esp_ble_mesh_agg_server_cb_event_t event,  
esp_ble_mesh_agg_server_cb_param_t *param)
```

Opcodes Aggregator Server model callback function type.

**Param event** Event type

**Param param** Pointer to callback parameter

## Enumerations

```
enum esp_ble_mesh_agg_client_cb_event_t
```

This enum value is the event of Opcodes Aggregator Client model

*Values:*

enumerator **ESP\_BLE\_MESH\_AGG\_CLIENT\_SEND\_COMP\_EVT**

enumerator **ESP\_BLE\_MESH\_AGG\_CLIENT\_SEND\_TIMEOUT\_EVT**

enumerator **ESP\_BLE\_MESH\_AGG\_CLIENT\_RECV\_RSP\_EVT**

enumerator **ESP\_BLE\_MESH\_AGG\_CLIENT\_RECV\_PUB\_EVT**

enumerator **ESP\_BLE\_MESH\_AGG\_CLIENT\_EVT\_MAX**

```
enum esp_ble_mesh_agg_server_cb_event_t
```

This enum value is the event of Opcodes Aggregator Server model

*Values:*

enumerator **ESP\_BLE\_MESH\_AGG\_SERVER\_RECV\_MSG\_EVT**

enumerator **ESP\_BLE\_MESH\_AGG\_SERVER\_EVT\_MAX**

## Large Composition Data

### Header File

- `components/bt/esp_ble_mesh/v1.1/api/core/include/esp_ble_mesh_lcd_model_api.h`
- This header file can be included with:

```
#include "esp_ble_mesh_lcd_model_api.h"
```

- This header file is a part of the API provided by the `bt` component. To declare that your component depends on `bt`, add the following to your `CMakeLists.txt`:

REQUIRES bt
-------------

or

PRIV_REQUIRES bt
------------------

**Functions**

*esp\_err\_t* **esp\_ble\_mesh\_register\_lcd\_client\_callback** (*esp\_ble\_mesh\_lcd\_client\_cb\_t* callback)

Register BLE Mesh Large Composition Data Client model callback.

参数 **callback** -- [in] Pointer to the callback function.

返回 ESP\_OK on success or error code otherwise.

*esp\_err\_t* **esp\_ble\_mesh\_lcd\_client\_send** (*esp\_ble\_mesh\_client\_common\_param\_t* \*params, *esp\_ble\_mesh\_lcd\_client\_msg\_t* \*msg)

Get the value of Large Composition Data Server model state with the corresponding get message.

参数

- **params** -- [in] Pointer to BLE Mesh common client parameters.
- **msg** -- [in] Pointer to Large Composition Data Client message.

返回 ESP\_OK on success or error code otherwise.

*esp\_err\_t* **esp\_ble\_mesh\_register\_lcd\_server\_callback** (*esp\_ble\_mesh\_lcd\_server\_cb\_t* callback)

Register BLE Mesh Large Composition Data Server model callback.

参数 **callback** -- [in] Pointer to the callback function.

返回 ESP\_OK on success or error code otherwise.

**Unions**

union **esp\_ble\_mesh\_lcd\_client\_msg\_t**

#include <esp\_ble\_mesh\_lcd\_model\_api.h> Large Composition Data Client model message union.

**Public Members**

*esp\_ble\_mesh\_large\_comp\_data\_get\_t* **large\_comp\_data\_get**

For ESP\_BLE\_MESH\_MODEL\_OP\_LARGE\_COMP\_DATA\_GET

*esp\_ble\_mesh\_models\_metadata\_get\_t* **models\_metadata\_get**

For ESP\_BLE\_MESH\_MODEL\_OP\_MODELS\_METADATA\_GET

union **esp\_ble\_mesh\_lcd\_client\_rcv\_cb\_t**

#include <esp\_ble\_mesh\_lcd\_model\_api.h> Large Composition Data Client model received message union.

**Public Members**

*esp\_ble\_mesh\_large\_comp\_data\_status\_t* **large\_comp\_data\_status**

For ESP\_BLE\_MESH\_MODEL\_OP\_LARGE\_COMP\_DATA\_STATUS

*esp\_ble\_mesh\_models\_metadata\_status\_t* **models\_metadata\_status**

For ESP\_BLE\_MESH\_MODEL\_OP\_MODELS\_METADATA\_STATUS

union **esp\_ble\_mesh\_lcd\_server\_state\_change\_t**

*#include <esp\_ble\_mesh\_lcd\_model\_api.h>* Large Composition Data Server model related context.

Large Composition Data Server model state change value union

### Public Members

uint8\_t **dummy**

Event not used currently

union **esp\_ble\_mesh\_lcd\_server\_cb\_value\_t**

*#include <esp\_ble\_mesh\_lcd\_model\_api.h>* Large Composition Data Server model callback value union.

### Public Members

*esp\_ble\_mesh\_lcd\_server\_state\_change\_t* **state\_change**

For ESP\_BLE\_MESH\_LCD\_SERVER\_STATE\_CHANGE\_EVT

### Structures

struct **esp\_ble\_mesh\_lcd\_srv\_t**

Large Composition Data Server model context

### Public Members

*esp\_ble\_mesh\_model\_t* \***model**

Pointer to Large Composition Data Server model

struct **esp\_ble\_mesh\_large\_comp\_data\_get\_t**

Parameters of Large Composition Data Get

### Public Members

uint8\_t **page**

Page number of the Composition Data

uint16\_t **offset**

Offset within the page

struct **esp\_ble\_mesh\_models\_metadata\_get\_t**

Parameters of Models Metadata Get

### Public Members

uint8\_t **metadata\_page**

Page number of the Models Metadata

uint16\_t **offset**

Offset within the page

struct **esp\_ble\_mesh\_large\_comp\_data\_status\_t**  
Parameters of Large Composition Data Status

### Public Members

uint8\_t **page**

Page number of the Composition Data

uint16\_t **offset**

Offset within the page

uint16\_t **total\_size**

Total size of the page

struct net\_buf\_simple \***data**

Composition Data for the identified portion of the page

struct **esp\_ble\_mesh\_models\_metadata\_status\_t**  
Parameters of Models Metadata Data Status

### Public Members

uint8\_t **metadata\_page**

Page number of the Models Metadata

uint16\_t **offset**

Offset within the page

uint16\_t **total\_size**

Total size of the page

struct net\_buf\_simple \***data**

Models Metadata for the identified portion of the page

struct **esp\_ble\_mesh\_lcd\_client\_send\_cb\_t**  
Result of sending Large Composition Data Client messages

### Public Members

int **err\_code**

Result of sending a message

struct **esp\_ble\_mesh\_lcd\_client\_cb\_param\_t**  
Large Composition Data Client model callback parameters



### Public Members

*esp\_ble\_mesh\_client\_common\_param\_t* \***params**

Client common parameters, used by all events.

*esp\_ble\_mesh\_lcd\_client\_send\_cb\_t* **send**

Result of sending a message

*esp\_ble\_mesh\_lcd\_client\_rcv\_cb\_t* **rcv**

Parameters of received status message

union *esp\_ble\_mesh\_lcd\_client\_cb\_param\_t*::[anonymous] [**anonymous**]

Union of LCD Client callback

struct **esp\_ble\_mesh\_lcd\_server\_cb\_param\_t**

Large Composition Data Server model callback parameters

### Public Members

*esp\_ble\_mesh\_model\_t* \***model**

Pointer to the server model structure

*esp\_ble\_mesh\_msg\_ctx\_t* **ctx**

Context of the received message

*esp\_ble\_mesh\_lcd\_server\_cb\_value\_t* **value**

Value of the received configuration messages

### Macros

**ESP\_BLE\_MESH\_MODEL\_OP\_LARGE\_COMP\_DATA\_GET**

**ESP\_BLE\_MESH\_MODEL\_OP\_LARGE\_COMP\_DATA\_STATUS**

**ESP\_BLE\_MESH\_MODEL\_OP\_MODELS\_METADATA\_GET**

**ESP\_BLE\_MESH\_MODEL\_OP\_MODELS\_METADATA\_STATUS**

**ESP\_BLE\_MESH\_MODEL\_LCD\_SRV** (srv\_data)

Define a new Large Composition Data Server model.

---

**备注:** If supported, the model shall be supported by a primary element and shall not be supported by any secondary elements.

---

### 参数

- **srv\_data** -- Pointer to a unique Large Composition Data Server model user\_data.

**返回** New Large Composition Data Server model instance.

**ESP\_BLE\_MESH\_MODEL\_LCD\_CLI** (cli\_data)

Define a new Large Composition Data Client model.

---

**备注:** If supported, the model shall be supported by the primary element and shall not be supported by any secondary elements.

---

**参数**

- **cli\_data** -- Pointer to a unique Large Composition Data Client model user\_data.

**返回** New Large Composition Data Client model instance.

**Type Definitions**

```
typedef void (*esp_ble_mesh_lcd_client_cb_t)(esp_ble_mesh_lcd_client_cb_event_t event,  
esp_ble_mesh_lcd_client_cb_param_t *param)
```

Large Composition Data client and server model functions.

Large Composition Data Client model callback function type

**Param event** Event type

**Param param** Pointer to callback parameter

```
typedef void (*esp_ble_mesh_lcd_server_cb_t)(esp_ble_mesh_lcd_server_cb_event_t event,  
esp_ble_mesh_lcd_server_cb_param_t *param)
```

Large Composition Data Server model callback function type.

**Param event** Event type

**Param param** Pointer to callback parameter

**Enumerations**

```
enum esp_ble_mesh_lcd_client_cb_event_t
```

This enum value is the event of Large Composition Data Client model

*Values:*

enumerator **ESP\_BLE\_MESH\_LCD\_CLIENT\_SEND\_COMP\_EVT**

enumerator **ESP\_BLE\_MESH\_LCD\_CLIENT\_SEND\_TIMEOUT\_EVT**

enumerator **ESP\_BLE\_MESH\_LCD\_CLIENT\_RECV\_RSP\_EVT**

enumerator **ESP\_BLE\_MESH\_LCD\_CLIENT\_RECV\_PUB\_EVT**

enumerator **ESP\_BLE\_MESH\_LCD\_CLIENT\_EVT\_MAX**

```
enum esp_ble_mesh_lcd_server_cb_event_t
```

This enum value is the event of Large Composition Data Server model

*Values:*

enumerator **ESP\_BLE\_MESH\_LCD\_SERVER\_STATE\_CHANGE\_EVT**

enumerator **ESP\_BLE\_MESH\_LCD\_SERVER\_EVT\_MAX**

## Composition and Metadata

### Header File

- `components/bt/esp_ble_mesh/v1.1/api/core/include/esp_ble_mesh_cm_data_api.h`
- This header file can be included with:

```
#include "esp_ble_mesh_cm_data_api.h"
```

- This header file is a part of the API provided by the `bt` component. To declare that your component depends on `bt`, add the following to your `CMakeLists.txt`:

```
REQUIRES bt
```

or

```
PRIV_REQUIRES bt
```

### Functions

`esp_err_t esp_ble_mesh_comp_1_register` (const `esp_ble_mesh_comp_1_t` \*comp)

Register Composition Data Page 1.

参数 `comp` -- [in] Pointer to Composition Data Page 1.

返回 ESP\_OK on success or error code otherwise.

`esp_err_t esp_ble_mesh_models_metadata_register` (const `esp_ble_mesh_models_metadata_t` \*metadata, `uint8_t` metadata\_page)

Register Models Metadata Page 0 or 128.

参数

- `metadata` -- [in] Pointer to Models Metadata Page 0 or 128.
- `metadata_page` -- [in] Models Metadata Page number, i.e. 0 or 128.

返回 ESP\_OK on success or error code otherwise.

### Structures

struct `esp_ble_mesh_extended_model_item_t`

Format of Extended Model Item

#### Public Members

`uint8_t element_offset`

Element address modifier, in the range -4 to 3. See above.

`uint8_t model_item_idx`

Model Index, in the range 0 to 31

Model index, in the range 0 to 255

`int8_t element_offset`

Element address modifier, in the range -128 to 127

struct `esp_ble_mesh_extended_model_item_t`::[anonymous]::[anonymous] `long_fmt`

Extended Model Item long format Extended Model Item long format

union *esp\_ble\_mesh\_extended\_model\_item\_t*::[anonymous] [**anonymous**]

Union of Extended Model Item

struct **esp\_ble\_mesh\_model\_item\_t**

Format of Model Item

### Public Members

uint8\_t **corresponding\_present**

Corresponding\_Group\_ID field indicator

uint8\_t **format**

Format of Extended\_Model\_Items indicator

uint8\_t **extended\_items\_count**

Number of Extended Model Items in the Extended\_Model\_Items field

uint8\_t **corresponding\_group\_id**

Corresponding group identifier

*esp\_ble\_mesh\_extended\_model\_item\_t* \*const **extended\_model\_items**

List of Extended Model Items

struct **esp\_ble\_mesh\_comp\_1\_elem\_t**

Format of element of Composition Data Page 1

### Public Members

const uint8\_t **num\_s**

A count of SIG Models Items in this element

const uint8\_t **num\_v**

A count of Vendor Models Items in this element

*esp\_ble\_mesh\_model\_item\_t* \*const **model\_items\_s**

A sequence of "num\_s" SIG Model Items

*esp\_ble\_mesh\_model\_item\_t* \*const **model\_items\_v**

A sequence of "num\_v" Vendor Model Items

struct **esp\_ble\_mesh\_comp\_1\_t**

Format of Composition Data Page 1

### Public Members

size\_t **element\_count**

Element count

*esp\_ble\_mesh\_comp\_1\_elem\_t* \*elements

A sequence of element descriptions

struct **esp\_ble\_mesh\_metadata\_entry\_t**

Format of Metadata entry

### Public Members

uint16\_t **metadata\_len**

Size of the Metadata field

uint16\_t **metadata\_id**

Bluetooth assigned number for the Metadata Identifier

const uint8\_t \***metadata**

Model' s metadata

struct **esp\_ble\_mesh\_metadata\_item\_t**

Format of Metadata item

### Public Members

uint16\_t **model\_id**

Model ID

uint16\_t **company\_id**

Company ID

struct *esp\_ble\_mesh\_metadata\_item\_t*::[anonymous]::[anonymous] **vnd**

Vendor model identifier Vendor model identifier

union *esp\_ble\_mesh\_metadata\_item\_t*::[anonymous] [**anonymous**]

Union of model ID

uint8\_t **metadata\_entries\_num**

Number of metadata entries

*esp\_ble\_mesh\_metadata\_entry\_t* \*const **metadata\_entries**

List of model' s metadata

struct **esp\_ble\_mesh\_metadata\_elem\_t**

Format of Metadata element of Models Metadata Page 0/128

### Public Members

const uint8\_t **items\_num\_s**

Number of metadata items for SIG models in the element

const uint8\_t **items\_num\_v**

Number of metadata items for Vendor models in the element

*esp\_ble\_mesh\_metadata\_item\_t* \*const **metadata\_items\_s**

List of metadata items for SIG models in the element

*esp\_ble\_mesh\_metadata\_item\_t* \*const **metadata\_items\_v**

List of metadata items for Vendor models in the element

struct **esp\_ble\_mesh\_models\_metadata\_t**

Format of the Models Metadata Page 0/128

### Public Members

size\_t **element\_count**

Element count

*esp\_ble\_mesh\_metadata\_elem\_t* \***elements**

List of metadata for models for each element

### Macros

**ESP\_BLE\_MESH\_MODEL\_ITEM\_SHORT**

< Definitions of the format of Extended\_Model\_Items indicator

**ESP\_BLE\_MESH\_MODEL\_ITEM\_LONG**

## 2.3.5 NimBLE-based Host APIs

### Overview

Apache MyNewt NimBLE is a highly configurable and Bluetooth® SIG qualifiable Bluetooth Low Energy (Bluetooth LE) stack providing both host and controller functionalities. ESP-IDF supports NimBLE host stack which is specifically ported for ESP32 platform and FreeRTOS. The underlying controller is still the same (as in case of Bluedroid) providing VHCI interface. Refer to [NimBLE user guide](#) for a complete list of features and additional information on NimBLE stack. Most features of NimBLE including Bluetooth Low Energy Mesh are supported by ESP-IDF. The porting layer is kept cleaner by maintaining all the existing APIs of NimBLE along with a single ESP-NimBLE API for initialization, making it simpler for the application developers.

### Architecture

Currently, NimBLE host and controller support different transports such as UART and RAM between them. However, RAM transport cannot be used as is in case of ESP as ESP controller supports VHCI interface and buffering schemes used by NimBLE host is incompatible with that used by ESP controller. Therefore, a new transport between NimBLE host and ESP controller has been added. This is depicted in the figure below. This layer is responsible for maintaining pool of transport buffers and formatting buffers exchanges between host and controller as per the requirements.



图 1: ESP NimBLE Stack

### Threading Model

The NimBLE host can run inside the application thread or can have its own independent thread. This flexibility is inherently provided by NimBLE design. By default, a thread is spawned by the porting function `nimble_port_freertos_init`. This behavior can be changed by overriding the same function. For Bluetooth Low Energy Mesh, additional thread (advertising thread) is used which keeps on feeding advertisement events to the main thread.

### Programming Sequence

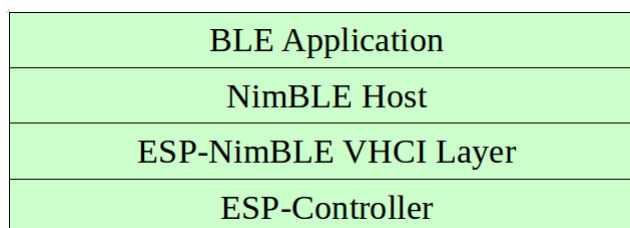
To begin with, make sure that the NimBLE stack is enabled from menuconfig *choose NimBLE for the Bluetooth host*.

**Typical programming sequence with NimBLE stack consists of the following steps:**

- Initialize NVS flash using `nvs_flash_init()` API. This is because ESP controller uses NVS during initialization.
- Initialize the host and controller stack using `nimble_port_init`.
- Initialize the required NimBLE host configuration parameters and callbacks
- Perform application specific tasks/initialization
- Run the thread for host stack using `nimble_port_freertos_init`

This documentation does not cover NimBLE APIs. Refer to [NimBLE tutorial](#) for more details on the programming sequence/NimBLE APIs for different scenarios.

### API Reference

#### Header File

- `components/bt/host/nimble/esp-hci/include/esp_nimble_hci.h`
- This header file can be included with:

```
#include "esp_nimble_hci.h"
```

- This header file is a part of the API provided by the `bt` component. To declare that your component depends on `bt`, add the following to your `CMakeLists.txt`:

```
REQUIRES bt
```

or

```
PRIV_REQUIRES bt
```

#### Functions

`esp_err_t esp_nimble_hci_init` (void)

Initialize VHCI transport layer between NimBLE Host and ESP Bluetooth controller.

This function initializes the transport buffers to be exchanged between NimBLE host and ESP controller. It also registers required host callbacks with the controller.

返回

- ESP\_OK if the initialization is successful
- Appropriate error code from esp\_err\_t in case of an error

`esp_err_t esp_nimble_hci_deinit` (void)

Deinitialize VHCI transport layer between NimBLE Host and ESP Bluetooth controller.

---

**备注:** This function should be called after the NimBLE host is deinitialized.

---

#### 返回

- ESP\_OK if the deinitialization is successful
- Appropriate error codes from esp\_err\_t in case of an error

### Macros

**BLE\_HCI\_UART\_H4\_NONE**

**BLE\_HCI\_UART\_H4\_CMD**

**BLE\_HCI\_UART\_H4\_ACL**

**BLE\_HCI\_UART\_H4\_SCO**

**BLE\_HCI\_UART\_H4\_EVT**

ESP-IDF 目前支持两个主机堆栈。基于 **Bluedroid** 的堆栈（默认）支持传统蓝牙和低功耗蓝牙 (Bluetooth® LE)，而基于 **Apache NimBLE** 的堆栈仅支持低功耗蓝牙。用户可参考如下信息进行选择：

- 对于同时涉及传统蓝牙和低功耗蓝牙的用例，应该选用 **Bluedroid**。
- 对于仅涉及低功耗蓝牙的用例，建议选用 **NimBLE**。在代码占用和运行时，**NimBLE** 对内存的要求较低，因此适用于此类场景。

蓝牙 API 的示例代码存放于 ESP-IDF 示例项目的 **bluetooth/bluedroid** 目录下。

下面的示例给出了详细介绍：

- [GATT 客户端示例](#)
- [GATT 服务端服务表格示例](#)
- [GATT 服务端示例](#)
- [GATT 客户端安全性示例](#)
- [GATT 服务端安全性示例](#)
- [GATT 客户端多连接示例](#)

## 2.4 错误代码参考

本节列出了 ESP-IDF 中定义的各种错误代码常量。

有关 ESP-IDF 中出错处理的通用信息，请参见[错误处理](#)。

`ESP_FAIL` (-1): Generic esp\_err\_t code indicating failure

`ESP_OK` (0): esp\_err\_t value indicating success (no error)

`ESP_ERR_NO_MEM` (0x101): Out of memory

`ESP_ERR_INVALID_ARG` (0x102): Invalid argument

`ESP_ERR_INVALID_STATE` (0x103): Invalid state



*ESP\_ERR\_INVALID\_SIZE* (0x104): Invalid size

*ESP\_ERR\_NOT\_FOUND* (0x105): Requested resource not found

*ESP\_ERR\_NOT\_SUPPORTED* (0x106): Operation or feature not supported

*ESP\_ERR\_TIMEOUT* (0x107): Operation timed out

*ESP\_ERR\_INVALID\_RESPONSE* (0x108): Received response was invalid

*ESP\_ERR\_INVALID\_CRC* (0x109): CRC or checksum was invalid

*ESP\_ERR\_INVALID\_VERSION* (0x10a): Version was invalid

*ESP\_ERR\_INVALID\_MAC* (0x10b): MAC address was invalid

*ESP\_ERR\_NOT\_FINISHED* (0x10c): Operation has not fully completed

*ESP\_ERR\_NOT\_ALLOWED* (0x10d): Operation is not allowed

*ESP\_ERR\_NVS\_BASE* (0x1100): Starting number of error codes

*ESP\_ERR\_NVS\_NOT\_INITIALIZED* (0x1101): The storage driver is not initialized

*ESP\_ERR\_NVS\_NOT\_FOUND* (0x1102): A requested entry couldn't be found or namespace doesn't exist yet and mode is NVS\_READONLY

*ESP\_ERR\_NVS\_TYPE\_MISMATCH* (0x1103): The type of set or get operation doesn't match the type of value stored in NVS

*ESP\_ERR\_NVS\_READ\_ONLY* (0x1104): Storage handle was opened as read only

*ESP\_ERR\_NVS\_NOT\_ENOUGH\_SPACE* (0x1105): There is not enough space in the underlying storage to save the value

*ESP\_ERR\_NVS\_INVALID\_NAME* (0x1106): Namespace name doesn't satisfy constraints

*ESP\_ERR\_NVS\_INVALID\_HANDLE* (0x1107): Handle has been closed or is NULL

*ESP\_ERR\_NVS\_REMOVE\_FAILED* (0x1108): The value wasn't updated because flash write operation has failed. The value was written however, and update will be finished after re-initialization of nvs, provided that flash operation doesn't fail again.

*ESP\_ERR\_NVS\_KEY\_TOO\_LONG* (0x1109): Key name is too long

*ESP\_ERR\_NVS\_PAGE\_FULL* (0x110a): Internal error; never returned by nvs API functions

*ESP\_ERR\_NVS\_INVALID\_STATE* (0x110b): NVS is in an inconsistent state due to a previous error. Call `nvs_flash_init` and `nvs_open` again, then retry.

*ESP\_ERR\_NVS\_INVALID\_LENGTH* (0x110c): String or blob length is not sufficient to store data

*ESP\_ERR\_NVS\_NO\_FREE\_PAGES* (0x110d): NVS partition doesn't contain any empty pages. This may happen if NVS partition was truncated. Erase the whole partition and call `nvs_flash_init` again.

*ESP\_ERR\_NVS\_VALUE\_TOO\_LONG* (0x110e): Value doesn't fit into the entry or string or blob length is longer than supported by the implementation

*ESP\_ERR\_NVS\_PART\_NOT\_FOUND* (0x110f): Partition with specified name is not found in the partition table

*ESP\_ERR\_NVS\_NEW\_VERSION\_FOUND* (0x1110): NVS partition contains data in new format and cannot be recognized by this version of code

*ESP\_ERR\_NVS\_XTS\_ENCR\_FAILED* (0x1111): XTS encryption failed while writing NVS entry

*ESP\_ERR\_NVS\_XTS\_DECR\_FAILED* (0x1112): XTS decryption failed while reading NVS entry

*ESP\_ERR\_NVS\_XTS\_CFG\_FAILED* (0x1113): XTS configuration setting failed

*ESP\_ERR\_NVS\_XTS\_CFG\_NOT\_FOUND* (0x1114): XTS configuration not found

*ESP\_ERR\_NVS\_ENCR\_NOT\_SUPPORTED* (0x1115): NVS encryption is not supported in this version

*ESP\_ERR\_NVS\_KEYS\_NOT\_INITIALIZED* (0x1116): NVS key partition is uninitialized

*ESP\_ERR\_NVS\_CORRUPT\_KEY\_PART (0x1117)*: NVS key partition is corrupt

*ESP\_ERR\_NVS\_CONTENT\_DIFFERS (0x1118)*: Internal error; never returned by nvs API functions. NVS key is different in comparison

*ESP\_ERR\_NVS\_WRONG\_ENCRYPTION (0x1119)*: NVS partition is marked as encrypted with generic flash encryption. This is forbidden since the NVS encryption works differently.

*ESP\_ERR\_ULP\_BASE (0x1200)*: Offset for ULP-related error codes

*ESP\_ERR\_ULP\_SIZE\_TOO\_BIG (0x1201)*: Program doesn't fit into RTC memory reserved for the ULP

*ESP\_ERR\_ULP\_INVALID\_LOAD\_ADDR (0x1202)*: Load address is outside of RTC memory reserved for the ULP

*ESP\_ERR\_ULP\_DUPLICATE\_LABEL (0x1203)*: More than one label with the same number was defined

*ESP\_ERR\_ULP\_UNDEFINED\_LABEL (0x1204)*: Branch instructions references an undefined label

*ESP\_ERR\_ULP\_BRANCH\_OUT\_OF\_RANGE (0x1205)*: Branch target is out of range of B instruction (try replacing with BX)

*ESP\_ERR\_OTA\_BASE (0x1500)*: Base error code for ota\_ops api

*ESP\_ERR\_OTA\_PARTITION\_CONFLICT (0x1501)*: Error if request was to write or erase the current running partition

*ESP\_ERR\_OTA\_SELECT\_INFO\_INVALID (0x1502)*: Error if OTA data partition contains invalid content

*ESP\_ERR\_OTA\_VALIDATE\_FAILED (0x1503)*: Error if OTA app image is invalid

*ESP\_ERR\_OTA\_SMALL\_SEC\_VER (0x1504)*: Error if the firmware has a secure version less than the running firmware.

*ESP\_ERR\_OTA\_ROLLBACK\_FAILED (0x1505)*: Error if flash does not have valid firmware in passive partition and hence rollback is not possible

*ESP\_ERR\_OTA\_ROLLBACK\_INVALID\_STATE (0x1506)*: Error if current active firmware is still marked in pending validation state (*ESP\_OTA\_IMG\_PENDING\_VERIFY*), essentially first boot of firmware image post upgrade and hence firmware upgrade is not possible

*ESP\_ERR\_EFUSE (0x1600)*: Base error code for efuse api.

*ESP\_OK\_EFUSE\_CNT (0x1601)*: OK the required number of bits is set.

*ESP\_ERR\_EFUSE\_CNT\_IS\_FULL (0x1602)*: Error field is full.

*ESP\_ERR\_EFUSE\_REPEATED\_PROG (0x1603)*: Error repeated programming of programmed bits is strictly forbidden.

*ESP\_ERR\_CODING (0x1604)*: Error while a encoding operation.

*ESP\_ERR\_NOT\_ENOUGH\_UNUSED\_KEY\_BLOCKS (0x1605)*: Error not enough unused key blocks available

*ESP\_ERR\_DAMAGED\_READING (0x1606)*: Error. Burn or reset was done during a reading operation leads to damage read data. This error is internal to the efuse component and not returned by any public API.

*ESP\_ERR\_IMAGE\_BASE (0x2000)*

*ESP\_ERR\_IMAGE\_FLASH\_FAIL (0x2001)*

*ESP\_ERR\_IMAGE\_INVALID (0x2002)*

*ESP\_ERR\_WIFI\_BASE (0x3000)*: Starting number of WiFi error codes

*ESP\_ERR\_WIFI\_NOT\_INIT (0x3001)*: WiFi driver was not installed by *esp\_wifi\_init*

*ESP\_ERR\_WIFI\_NOT\_STARTED (0x3002)*: WiFi driver was not started by *esp\_wifi\_start*

*ESP\_ERR\_WIFI\_NOT\_STOPPED (0x3003)*: WiFi driver was not stopped by *esp\_wifi\_stop*

*ESP\_ERR\_WIFI\_IF (0x3004)*: WiFi interface error

*ESP\_ERR\_WIFI\_MODE (0x3005)*: WiFi mode error

ESP\_ERR\_WIFI\_STATE (**0x3006**): WiFi internal state error

ESP\_ERR\_WIFI\_CONN (**0x3007**): WiFi internal control block of station or soft-AP error

ESP\_ERR\_WIFI\_NVS (**0x3008**): WiFi internal NVS module error

ESP\_ERR\_WIFI\_MAC (**0x3009**): MAC address is invalid

ESP\_ERR\_WIFI\_SSID (**0x300a**): SSID is invalid

ESP\_ERR\_WIFI\_PASSWORD (**0x300b**): Password is invalid

ESP\_ERR\_WIFI\_TIMEOUT (**0x300c**): Timeout error

ESP\_ERR\_WIFI\_WAKE\_FAIL (**0x300d**): WiFi is in sleep state(RF closed) and wakeup fail

ESP\_ERR\_WIFI\_WOULD\_BLOCK (**0x300e**): The caller would block

ESP\_ERR\_WIFI\_NOT\_CONNECT (**0x300f**): Station still in disconnect status

ESP\_ERR\_WIFI\_POST (**0x3012**): Failed to post the event to WiFi task

ESP\_ERR\_WIFI\_INIT\_STATE (**0x3013**): Invalid WiFi state when init/deinit is called

ESP\_ERR\_WIFI\_STOP\_STATE (**0x3014**): Returned when WiFi is stopping

ESP\_ERR\_WIFI\_NOT\_ASSOC (**0x3015**): The WiFi connection is not associated

ESP\_ERR\_WIFI\_TX\_DISALLOW (**0x3016**): The WiFi TX is disallowed

ESP\_ERR\_WIFI\_TWT\_FULL (**0x3017**): no available flow id

ESP\_ERR\_WIFI\_TWT\_SETUP\_TIMEOUT (**0x3018**): Timeout of receiving twt setup response frame, timeout times can be set during twt setup

ESP\_ERR\_WIFI\_TWT\_SETUP\_TXFAIL (**0x3019**): TWT setup frame tx failed

ESP\_ERR\_WIFI\_TWT\_SETUP\_REJECT (**0x301a**): The twt setup request was rejected by the AP

ESP\_ERR\_WIFI\_DISCARD (**0x301b**): Discard frame

ESP\_ERR\_WIFI\_ROC\_IN\_PROGRESS (**0x301c**): ROC op is in progress

ESP\_ERR\_WIFI\_REGISTRAR (**0x3033**): WPS registrar is not supported

ESP\_ERR\_WIFI\_WPS\_TYPE (**0x3034**): WPS type error

ESP\_ERR\_WIFI\_WPS\_SM (**0x3035**): WPS state machine is not initialized

ESP\_ERR\_ESPNOW\_BASE (**0x3064**): ESPNOW error number base.

ESP\_ERR\_ESPNOW\_NOT\_INIT (**0x3065**): ESPNOW is not initialized.

ESP\_ERR\_ESPNOW\_ARG (**0x3066**): Invalid argument

ESP\_ERR\_ESPNOW\_NO\_MEM (**0x3067**): Out of memory

ESP\_ERR\_ESPNOW\_FULL (**0x3068**): ESPNOW peer list is full

ESP\_ERR\_ESPNOW\_NOT\_FOUND (**0x3069**): ESPNOW peer is not found

ESP\_ERR\_ESPNOW\_INTERNAL (**0x306a**): Internal error

ESP\_ERR\_ESPNOW\_EXIST (**0x306b**): ESPNOW peer has existed

ESP\_ERR\_ESPNOW\_IF (**0x306c**): Interface error

ESP\_ERR\_ESPNOW\_CHAN (**0x306d**): Channel error

ESP\_ERR\_DPP\_FAILURE (**0x3097**): Generic failure during DPP Operation

ESP\_ERR\_DPP\_TX\_FAILURE (**0x3098**): DPP Frame Tx failed OR not Acked

ESP\_ERR\_DPP\_INVALID\_ATTR (**0x3099**): Encountered invalid DPP Attribute

ESP\_ERR\_DPP\_AUTH\_TIMEOUT (**0x309a**): DPP Auth response was not recieved in time

*ESP\_ERR\_MESH\_BASE* (**0x4000**): Starting number of MESH error codes

*ESP\_ERR\_MESH\_WIFI\_NOT\_START* (**0x4001**)

*ESP\_ERR\_MESH\_NOT\_INIT* (**0x4002**)

*ESP\_ERR\_MESH\_NOT\_CONFIG* (**0x4003**)

*ESP\_ERR\_MESH\_NOT\_START* (**0x4004**)

*ESP\_ERR\_MESH\_NOT\_SUPPORT* (**0x4005**)

*ESP\_ERR\_MESH\_NOT\_ALLOWED* (**0x4006**)

*ESP\_ERR\_MESH\_NO\_MEMORY* (**0x4007**)

*ESP\_ERR\_MESH\_ARGUMENT* (**0x4008**)

*ESP\_ERR\_MESH\_EXCEED\_MTU* (**0x4009**)

*ESP\_ERR\_MESH\_TIMEOUT* (**0x400a**)

*ESP\_ERR\_MESH\_DISCONNECTED* (**0x400b**)

*ESP\_ERR\_MESH\_QUEUE\_FAIL* (**0x400c**)

*ESP\_ERR\_MESH\_QUEUE\_FULL* (**0x400d**)

*ESP\_ERR\_MESH\_NO\_PARENT\_FOUND* (**0x400e**)

*ESP\_ERR\_MESH\_NO\_ROUTE\_FOUND* (**0x400f**)

*ESP\_ERR\_MESH\_OPTION\_NULL* (**0x4010**)

*ESP\_ERR\_MESH\_OPTION\_UNKNOWN* (**0x4011**)

*ESP\_ERR\_MESH\_XON\_NO\_WINDOW* (**0x4012**)

*ESP\_ERR\_MESH\_INTERFACE* (**0x4013**)

*ESP\_ERR\_MESH\_DISCARD\_DUPLICATE* (**0x4014**)

*ESP\_ERR\_MESH\_DISCARD* (**0x4015**)

*ESP\_ERR\_MESH\_VOTING* (**0x4016**)

*ESP\_ERR\_MESH\_XMIT* (**0x4017**)

*ESP\_ERR\_MESH\_QUEUE\_READ* (**0x4018**)

*ESP\_ERR\_MESH\_PS* (**0x4019**)

*ESP\_ERR\_MESH\_RECV\_RELEASE* (**0x401a**)

*ESP\_ERR\_ESP\_NETIF\_BASE* (**0x5000**)

*ESP\_ERR\_ESP\_NETIF\_INVALID\_PARAMS* (**0x5001**)

*ESP\_ERR\_ESP\_NETIF\_IF\_NOT\_READY* (**0x5002**)

*ESP\_ERR\_ESP\_NETIF\_DHCP\_START\_FAILED* (**0x5003**)

*ESP\_ERR\_ESP\_NETIF\_DHCP\_ALREADY\_STARTED* (**0x5004**)

*ESP\_ERR\_ESP\_NETIF\_DHCP\_ALREADY\_STOPPED* (**0x5005**)

*ESP\_ERR\_ESP\_NETIF\_NO\_MEM* (**0x5006**)

*ESP\_ERR\_ESP\_NETIF\_DHCP\_NOT\_STOPPED* (**0x5007**)

*ESP\_ERR\_ESP\_NETIF\_DRIVER\_ATTACH\_FAILED* (**0x5008**)

*ESP\_ERR\_ESP\_NETIF\_INIT\_FAILED* (**0x5009**)

*ESP\_ERR\_ESP\_NETIF\_DNS\_NOT\_CONFIGURED* (**0x500a**)

*ESP\_ERR\_ESP\_NETIF\_MLD6\_FAILED* (**0x500b**)

*ESP\_ERR\_ESP\_NETIF\_IP6\_ADDR\_FAILED (0x500c)*

*ESP\_ERR\_ESP\_NETIF\_DHCP\_START\_FAILED (0x500d)*

*ESP\_ERR\_FLASH\_BASE (0x6000)*: Starting number of flash error codes

*ESP\_ERR\_FLASH\_OP\_FAIL (0x6001)*

*ESP\_ERR\_FLASH\_OP\_TIMEOUT (0x6002)*

*ESP\_ERR\_FLASH\_NOT\_INITIALISED (0x6003)*

*ESP\_ERR\_FLASH\_UNSUPPORTED\_HOST (0x6004)*

*ESP\_ERR\_FLASH\_UNSUPPORTED\_CHIP (0x6005)*

*ESP\_ERR\_FLASH\_PROTECTED (0x6006)*

*ESP\_ERR\_HTTP\_BASE (0x7000)*: Starting number of HTTP error codes

*ESP\_ERR\_HTTP\_MAX\_REDIRECT (0x7001)*: The error exceeds the number of HTTP redirects

*ESP\_ERR\_HTTP\_CONNECT (0x7002)*: Error open the HTTP connection

*ESP\_ERR\_HTTP\_WRITE\_DATA (0x7003)*: Error write HTTP data

*ESP\_ERR\_HTTP\_FETCH\_HEADER (0x7004)*: Error read HTTP header from server

*ESP\_ERR\_HTTP\_INVALID\_TRANSPORT (0x7005)*: There are no transport support for the input scheme

*ESP\_ERR\_HTTP\_CONNECTING (0x7006)*: HTTP connection hasn't been established yet

*ESP\_ERR\_HTTP\_EAGAIN (0x7007)*: Mapping of errno EAGAIN to esp\_err\_t

*ESP\_ERR\_HTTP\_CONNECTION\_CLOSED (0x7008)*: Read FIN from peer and the connection closed

*ESP\_ERR\_ESP\_TLS\_BASE (0x8000)*: Starting number of ESP-TLS error codes

*ESP\_ERR\_ESP\_TLS\_CANNOT\_RESOLVE\_HOSTNAME (0x8001)*: Error if hostname couldn't be resolved upon tls connection

*ESP\_ERR\_ESP\_TLS\_CANNOT\_CREATE\_SOCKET (0x8002)*: Failed to create socket

*ESP\_ERR\_ESP\_TLS\_UNSUPPORTED\_PROTOCOL\_FAMILY (0x8003)*: Unsupported protocol family

*ESP\_ERR\_ESP\_TLS\_FAILED\_CONNECT\_TO\_HOST (0x8004)*: Failed to connect to host

*ESP\_ERR\_ESP\_TLS\_SOCKET\_SETOPT\_FAILED (0x8005)*: failed to set/get socket option

*ESP\_ERR\_ESP\_TLS\_CONNECTION\_TIMEOUT (0x8006)*: new connection in esp\_tls\_low\_level\_conn connection timed out

*ESP\_ERR\_ESP\_TLS\_SE\_FAILED (0x8007)*

*ESP\_ERR\_ESP\_TLS\_TCP\_CLOSED\_FIN (0x8008)*

*ESP\_ERR\_MBEDTLS\_CERT\_PARTLY\_OK (0x8010)*: mbedtls parse certificates was partly successful

*ESP\_ERR\_MBEDTLS\_CTR\_DRBG\_SEED\_FAILED (0x8011)*: mbedtls api returned error

*ESP\_ERR\_MBEDTLS\_SSL\_SET\_HOSTNAME\_FAILED (0x8012)*: mbedtls api returned error

*ESP\_ERR\_MBEDTLS\_SSL\_CONFIG\_DEFAULTS\_FAILED (0x8013)*: mbedtls api returned error

*ESP\_ERR\_MBEDTLS\_SSL\_CONF\_ALPN\_PROTOCOLS\_FAILED (0x8014)*: mbedtls api returned error

*ESP\_ERR\_MBEDTLS\_X509\_CERT\_PARSE\_FAILED (0x8015)*: mbedtls api returned error

*ESP\_ERR\_MBEDTLS\_SSL\_CONF\_OWN\_CERT\_FAILED (0x8016)*: mbedtls api returned error

*ESP\_ERR\_MBEDTLS\_SSL\_SETUP\_FAILED (0x8017)*: mbedtls api returned error

*ESP\_ERR\_MBEDTLS\_SSL\_WRITE\_FAILED (0x8018)*: mbedtls api returned error

*ESP\_ERR\_MBEDTLS\_PK\_PARSE\_KEY\_FAILED (0x8019)*: mbedtls api returned failed

*ESP\_ERR\_MBEDTLS\_SSL\_HANDSHAKE\_FAILED (0x801a)*: mbedtls api returned failed

*ESP\_ERR\_MBEDTLS\_SSL\_CONF\_PSK\_FAILED (0x801b)*: mbedtls api returned failed

*ESP\_ERR\_MBEDTLS\_SSL\_TICKET\_SETUP\_FAILED (0x801c)*: mbedtls api returned failed

*ESP\_ERR\_WOLFSSL\_SSL\_SET\_HOSTNAME\_FAILED (0x8031)*: wolfSSL api returned error

*ESP\_ERR\_WOLFSSL\_SSL\_CONF\_ALPN\_PROTOCOLS\_FAILED (0x8032)*: wolfSSL api returned error

*ESP\_ERR\_WOLFSSL\_CERT\_VERIFY\_SETUP\_FAILED (0x8033)*: wolfSSL api returned error

*ESP\_ERR\_WOLFSSL\_KEY\_VERIFY\_SETUP\_FAILED (0x8034)*: wolfSSL api returned error

*ESP\_ERR\_WOLFSSL\_SSL\_HANDSHAKE\_FAILED (0x8035)*: wolfSSL api returned failed

*ESP\_ERR\_WOLFSSL\_CTX\_SETUP\_FAILED (0x8036)*: wolfSSL api returned failed

*ESP\_ERR\_WOLFSSL\_SSL\_SETUP\_FAILED (0x8037)*: wolfSSL api returned failed

*ESP\_ERR\_WOLFSSL\_SSL\_WRITE\_FAILED (0x8038)*: wolfSSL api returned failed

*ESP\_ERR\_HTTPS\_OTA\_BASE (0x9000)*

*ESP\_ERR\_HTTPS\_OTA\_IN\_PROGRESS (0x9001)*

*ESP\_ERR\_PING\_BASE (0xa000)*

*ESP\_ERR\_PING\_INVALID\_PARAMS (0xa001)*

*ESP\_ERR\_PING\_NO\_MEM (0xa002)*

*ESP\_ERR\_HTTPD\_BASE (0xb000)*: Starting number of HTTPD error codes

*ESP\_ERR\_HTTPD\_HANDLERS\_FULL (0xb001)*: All slots for registering URI handlers have been consumed

*ESP\_ERR\_HTTPD\_HANDLER\_EXISTS (0xb002)*: URI handler with same method and target URI already registered

*ESP\_ERR\_HTTPD\_INVALID\_REQ (0xb003)*: Invalid request pointer

*ESP\_ERR\_HTTPD\_RESULT\_TRUNC (0xb004)*: Result string truncated

*ESP\_ERR\_HTTPD\_RESP\_HDR (0xb005)*: Response header field larger than supported

*ESP\_ERR\_HTTPD\_RESP\_SEND (0xb006)*: Error occurred while sending response packet

*ESP\_ERR\_HTTPD\_ALLOC\_MEM (0xb007)*: Failed to dynamically allocate memory for resource

*ESP\_ERR\_HTTPD\_TASK (0xb008)*: Failed to launch server task/thread

*ESP\_ERR\_HW\_CRYPTO\_BASE (0xc000)*: Starting number of HW cryptography module error codes

*ESP\_ERR\_HW\_CRYPTO\_DS\_HMAC\_FAIL (0xc001)*: HMAC peripheral problem

*ESP\_ERR\_HW\_CRYPTO\_DS\_INVALID\_KEY (0xc002)*

*ESP\_ERR\_HW\_CRYPTO\_DS\_INVALID\_DIGEST (0xc004)*

*ESP\_ERR\_HW\_CRYPTO\_DS\_INVALID\_PADDING (0xc005)*

*ESP\_ERR\_MEMPROT\_BASE (0xd000)*: Starting number of Memory Protection API error codes

*ESP\_ERR\_MEMPROT\_MEMORY\_TYPE\_INVALID (0xd001)*

*ESP\_ERR\_MEMPROT\_SPLIT\_ADDR\_INVALID (0xd002)*

*ESP\_ERR\_MEMPROT\_SPLIT\_ADDR\_OUT\_OF\_RANGE (0xd003)*

*ESP\_ERR\_MEMPROT\_SPLIT\_ADDR\_UNALIGNED (0xd004)*

*ESP\_ERR\_MEMPROT\_UNIMGMT\_BLOCK\_INVALID (0xd005)*

*ESP\_ERR\_MEMPROT\_WORLD\_INVALID (0xd006)*

*ESP\_ERR\_MEMPROT\_AREA\_INVALID (0xd007)*

*ESP\_ERR\_MEMPROT\_CPUID\_INVALID (0xd008)*



ESP\_ERR\_TCP\_TRANSPORT\_BASE (0xe000): Starting number of TCP Transport error codes

ESP\_ERR\_TCP\_TRANSPORT\_CONNECTION\_TIMEOUT (0xe001): Connection has timed out

ESP\_ERR\_TCP\_TRANSPORT\_CONNECTION\_CLOSED\_BY\_FIN (0xe002): Read FIN from peer and the connection has closed (in a clean way)

ESP\_ERR\_TCP\_TRANSPORT\_CONNECTION\_FAILED (0xe003): Failed to connect to the peer

ESP\_ERR\_TCP\_TRANSPORT\_NO\_MEM (0xe004): Memory allocation failed

ESP\_ERR\_NVS\_SEC\_BASE (0xf000): Starting number of error codes

ESP\_ERR\_NVS\_SEC\_HMAC\_KEY\_NOT\_FOUND (0xf001): HMAC Key required to generate the NVS encryption keys not found

ESP\_ERR\_NVS\_SEC\_HMAC\_KEY\_BLK\_ALREADY\_USED (0xf002): Provided eFuse block for HMAC key generation is already in use

ESP\_ERR\_NVS\_SEC\_HMAC\_KEY\_GENERATION\_FAILED (0xf003): Failed to generate/write the HMAC key to eFuse

ESP\_ERR\_NVS\_SEC\_HMAC\_XTS\_KEYS\_DERIV\_FAILED (0xf004): Failed to derive the NVS encryption keys based on the HMAC-based scheme

## 2.5 连网 API

### 2.5.1 以太网

#### 以太网

**概述** ESP-IDF 提供一系列灵活度高且兼具一致性的 API，为外部 SPI-Ethernet 模块提供支持。

本编程指南分为以下几个部分：

1. 以太网基本概念
2. 配置 MAC 和 PHY
3. 连接驱动程序至 TCP/IP 协议栈
4. 以太网驱动程序的杂项控制

**以太网基本概念** 以太网是一种异步的带冲突检测的载波侦听多路访问 (CSMA/CD) 协议/接口。通常来说，以太网不太适用于低功耗应用。然而，得益于其广泛的部署、高效的网络连接、高数据率以及范围不限的可扩展性，几乎所有的有线通信都可以通过以太网进行。

符合 IEEE 802.3 标准的正常以太网帧的长度在 64 至 1518 字节之间，由五个或六个不同的字段组成：目的地 MAC 地址 (DA)、源 MAC 地址 (SA)、类型/长度字段、数据有效载荷字段、可选的填充字段和帧校验序列字段 (CRC)。此外，在以太网上传输时，以太网数据包的开头需附加 7 字节的前导码和 1 字节的帧起始符 (SOF)。

因此，双绞线上的通信如图所示：

**前导码和帧起始符** 前导码包含 7 字节的 55H，作用是使接收器在实际帧到达之前锁定数据流。

帧前界定符 (SFD) 为二进制序列 10101011（物理介质层可见）。有时它也被视作前导码的一部分。

在传输和接收数据时，协议将自动从数据包中生成/移除前导码和帧起始符。



图 2: 以太网数据帧格式

**目的地址 (DA)** 目的地址字段包含一个 6 字节长的设备 MAC 地址，数据包将发送到该地址。如果 MAC 地址第一个字节中的最低有效位是 1，则该地址为组播地址。例如，01-00-00-F0-00 和 33-45-67-89-AB-CD 是组播地址，而 00-00-00-F0-00 和 32-45-67-89-AB-CD 不是。

带有组播地址的数据包将到达选定的一组以太网节点，并发挥重要作用。如果目的地址字段是保留的多播地址，即 FF-FF-FF-FF-FF-FF，则该数据包是一个广播数据包，指向共享网络中的每个对象。如果 MAC 地址的第一个字节中的最低有效位为 0，则该地址为单播地址，仅供寻址节点使用。

通常，EMAC 控制器会集成接收过滤器，用于丢弃或接收带有组播、广播和/或单播目的地址的数据包。传输数据包时，由主机控制器将所需的目标地址写入传输缓冲区。

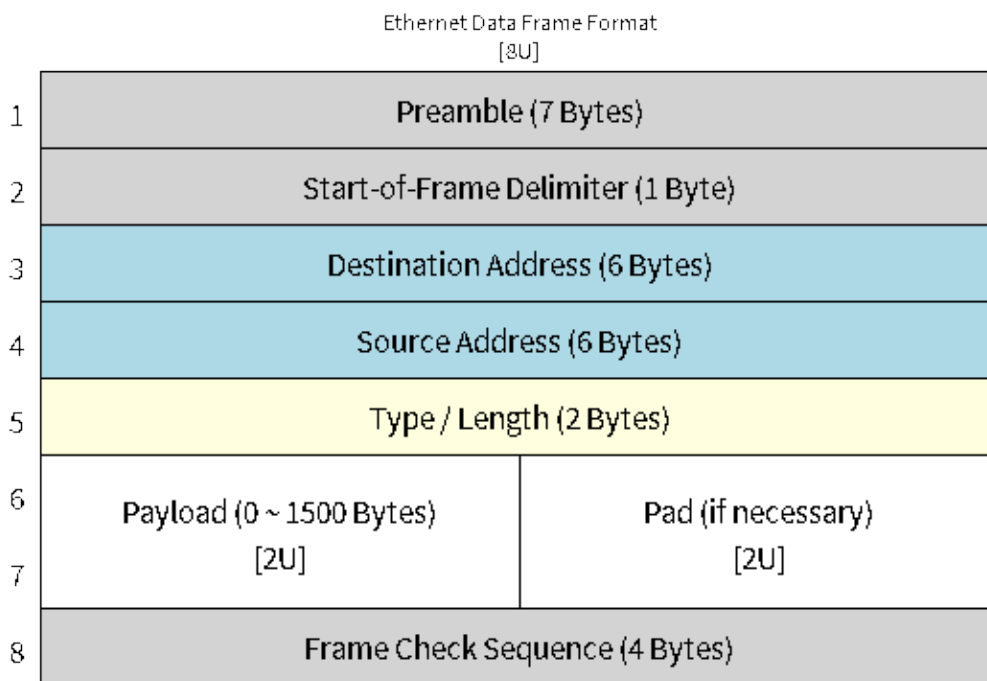
**源地址 (SA)** 源地址字段包含一个 6 字节长的节点 MAC 地址，以太网数据包通过该节点创建。以太网的用户需为所使用的任意控制器生成唯一的 MAC 地址。MAC 地址由两部分组成：前三个字节称为组织唯一标识符 (OUI)，由 IEEE 分配；后三个字节是地址字节，由购买 OUI 的公司配置。有关 ESP-IDF 中使用的 MAC 地址的详细信息，请参见 [MAC 地址分配](#)。

传输数据包时，由主机控制器将分配的源 MAC 地址写入传输缓冲区。

**类型/长度** 类型/长度字段长度为 2 字节。如果其值  $\leq 1500$  (十进制)，则该字段为长度字段，指定在数据字段后的非填充数据量；如果其值  $\geq 1536$ ，则该字段值表示后续数据包所属的协议。以下为该字段的常见值：

- IPv4 = 0800H
- IPv6 = 86DDH
- ARP = 0806H

使用专有网络的用户可以将此字段配置为长度字段。然而，对于使用互联网协议 (IP) 或地址解析协议 (ARP) 等协议的应用程序，在传输数据包时，应将此字段配置为协议规范定义的适当类型。



**数据有效载荷** 数据有效载荷字段是一个可变长度的字段，长度从 0 到 1500 字节不等。更大的数据包会因违反以太网标准而被大多数以太网节点丢弃。

数据有效载荷字段包含客户端数据，如 IP 数据报。

**填充及帧校验序列 (FCS)** 填充字段是一个可变长度的字段。数据有效载荷较小时，将添加填充字段以满足 IEEE 802.3 规范的要求。

以太网数据包的 DA、SA、类型、数据有效载荷和填充字段共计必须不小于 60 字节。加上所需的 4 字节 FCS 字段，数据包的长度必须不小于 64 字节。如果数据有效载荷字段小于 46 字节，则需要加上一个填充字段。

帧校验序列字段 (FCS) 长度为 4 字节，其中包含一个行业标准的 32 位 CRC，该 CRC 是根据 DA、SA、类型、数据有效载荷和填充字段的数据计算的。鉴于计算 CRC 的复杂性，硬件通常会自动生成一个有效的 CRC 进行传输。否则，需由主机控制器生成 CRC 并将其写入传输缓冲区。

通常情况下，主机控制器无需关注填充字段和 CRC 字段，因为这两部分可以在传输或接收时由硬件 EMAC 自动生成或验证。然而，当数据包到达时，填充字段和 CRC 字段将被写入接收缓冲区。因此，如果需要的话，主机控制器也可以对它们进行评估。

**备注：**除了上述的基本数据帧，在 10/100 Mbps 以太网中还有两种常见的帧类型：控制帧和 VLAN 标记帧。ESP-IDF 不支持这两种帧类型。

**配置 MAC 和 PHY** 以太网驱动器由两部分组成：MAC 和 PHY。

根据以太网板设计，需要分别为 MAC 和 PHY 配置必要的参数，通过两者完成驱动程序的安装。

MAC 的相关配置可以在 `eth_mac_config_t` 中找到，具体包括：

- `eth_mac_config_t::sw_reset_timeout_ms`: 软件复位超时值，单位为毫秒。通常，MAC 复位应在 100 ms 内完成。
- `eth_mac_config_t::rx_task_stack_size` 和 `eth_mac_config_t::rx_task_prio`: MAC 驱动会创建一个专门的任务来处理传入的数据包，这两个参数用于设置该任务的堆栈大小和优先级。
- `eth_mac_config_t::flags`: 指定 MAC 驱动应支持的额外功能，尤其适用于某些特殊情况。这个字段的值支持与以 `ETH_MAC_FLAG_` 为前缀的宏进行 OR 运算。例如，如果要求 MAC 驱动程序在 cache 禁用时仍能正常工作，那么则需要用 `ETH_MAC_FLAG_WORK_WITH_CACHE_DISABLE` 配置这个字段。

PHY 的相关配置可以在 `eth_phy_config_t` 中找到，具体包括：

- `eth_phy_config_t::phy_addr`: 同一条 SMI 总线上可以存在多个 PHY 设备，所以有必要为各个 PHY 设备分配唯一地址。通常，这个地址是在硬件设计期间，通过拉高/拉低一些 PHY strapping 管脚来配置的。根据不同的以太网开发板，可配置值为 0 到 15。需注意，如果 SMI 总线上仅有一个 PHY 设备，将该值配置为 -1，即可使驱动程序自动检测 PHY 地址。
- `eth_phy_config_t::reset_timeout_ms`: 复位超时值，单位为毫秒。通常，PHY 复位应在 100 ms 内完成。
- `eth_phy_config_t::autonego_timeout_ms`: 自动协商超时值，单位为毫秒。以太网驱动程序会与链路另一端的设备进行自协商，以确定连接的最佳双工模式和速率。此值通常取决于电路板上 PHY 设备的性能。
- `eth_phy_config_t::reset_gpio_num`: 如果开发板同时将 PHY 复位管脚连接至了任意 GPIO 管脚，请使用该字段进行配置。否则，配置为 -1。

ESP-IDF 在宏 `ETH_MAC_DEFAULT_CONFIG` 和 `ETH_PHY_DEFAULT_CONFIG` 中为 MAC 和 PHY 提供了默认配置。

**创建 MAC 和 PHY 实例** 以太网驱动是以面向对象的方式实现的。对 MAC 和 PHY 的任何操作都应基于实例。

### SPI-Ethernet 模块

```
eth_mac_config_t mac_config = ETH_MAC_DEFAULT_CONFIG(); // 应用默认的通用 MAC
↳配置
eth_phy_config_t phy_config = ETH_PHY_DEFAULT_CONFIG(); // 应用默认的 PHY 配置
phy_config.phy_addr = CONFIG_EXAMPLE_ETH_PHY_ADDR; // 根据开发板设计更改
↳PHY 地址
phy_config.reset_gpio_num = CONFIG_EXAMPLE_ETH_PHY_RST_GPIO; // 更改用于 PHY
↳复位的 GPIO
// 安装 GPIO 中断服务 (因为 SPI-Ethernet 模块为中断驱动)
gpio_install_isr_service(0);
// 配置 SPI 总线
spi_device_handle_t spi_handle = NULL;
spi_bus_config_t buscfg = {
    .miso_io_num = CONFIG_EXAMPLE_ETH_SPI_MISO_GPIO,
    .mosi_io_num = CONFIG_EXAMPLE_ETH_SPI_MOSI_GPIO,
    .sclk_io_num = CONFIG_EXAMPLE_ETH_SPI_SCLK_GPIO,
    .quadwp_io_num = -1,
    .quadhd_io_num = -1,
};
ESP_ERROR_CHECK(spi_bus_initialize(CONFIG_EXAMPLE_ETH_SPI_HOST, &buscfg, 1));
// 配置 SPI 从机设备
spi_device_interface_config_t spi_devcfg = {
    .mode = 0,
    .clock_speed_hz = CONFIG_EXAMPLE_ETH_SPI_CLOCK_MHZ * 1000 * 1000,
    .spics_io_num = CONFIG_EXAMPLE_ETH_SPI_CS_GPIO,
    .queue_size = 20
};
/* dm9051 ethernet driver is based on spi driver */
eth_dm9051_config_t dm9051_config = ETH_DM9051_DEFAULT_CONFIG(CONFIG_EXAMPLE_ETH_
↳SPI_HOST, &spi_devcfg);
dm9051_config.int_gpio_num = CONFIG_EXAMPLE_ETH_SPI_INT_GPIO;
esp_eth_mac_t *mac = esp_eth_mac_new_dm9051(&dm9051_config, &mac_config);
esp_eth_phy_t *phy = esp_eth_phy_new_dm9051(&phy_config);
```

#### 备注:

- 当为 SPI-Ethernet 模块 (例如 DM9051) 创建 MAC 和 PHY 实例时, 由于 PHY 是集成在模块中的, 因此调用的实例创建函数的后缀须保持一致 (例如 `esp_eth_mac_new_dm9051` 和 `esp_eth_phy_new_dm9051` 搭配使用)。
- 针对不同的以太网模块, 或是为了满足特定 PCB 上的 SPI 时序, SPI 从机设备配置 (即 `spi_device_interface_config_t`) 可能略有不同。具体配置请查看模块规格以及 ESP-IDF 中的示例。

**安装驱动程序** 安装以太网驱动程序需要结合 MAC 和 PHY 实例, 并在 `esp_eth_config_t` 中配置一些额外的高级选项 (即不仅限于 MAC 或 PHY 的选项):

- `esp_eth_config_t::mac`: 由 MAC 生成器创建的实例 (例如 `esp_eth_mac_new_esp32()`)。
- `esp_eth_config_t::phy`: 由 PHY 生成器创建的实例 (例如 `esp_eth_phy_new_ip101()`)。
- `esp_eth_config_t::check_link_period_ms`: 以太网驱动程序会启用操作系统定时器来定期检查链接状态。该字段用于设置间隔时间, 单位为毫秒。
- `esp_eth_config_t::stack_input`: 在大多数的以太网物联网应用中, 驱动器接收的以太网帧会被传递到上层 (如 TCP/IP 栈)。经配置, 该字段为负责处理传入帧的函数。可以在安装驱动程序后, 通过函数 `esp_eth_update_input_path()` 更新该字段。该字段支持在运行过程中进行更新。
- `esp_eth_config_t::on_lowlevel_init_done` 和 `esp_eth_config_t::on_lowlevel_deinit_done`: 这两个字段用于指定钩子函数, 当去初始化或初始化低级别硬件时, 会调用钩子函数。

ESP-IDF 在宏 `ETH_DEFAULT_CONFIG` 中为安装驱动程序提供了一个默认配置。

```
esp_eth_config_t config = ETH_DEFAULT_CONFIG(mac, phy); // 应用默认驱动程序配置
esp_eth_handle_t eth_handle = NULL; // 驱动程序安装完毕后，将得到驱动程序的句柄
esp_eth_driver_install(&config, &eth_handle); // 安装驱动程序
```

以太网驱动程序包含事件驱动模型，该模型会向用户空间发送有用及重要的事件。安装以太网驱动程序之前，需要首先初始化事件循环。有关事件驱动编程的更多信息，请参考[事件循环库](#)。

```
/** 以太网事件的事件处理程序 */
static void eth_event_handler(void *arg, esp_event_base_t event_base,
                             int32_t event_id, void *event_data)
{
    uint8_t mac_addr[6] = {0};
    /* 可从事件数据中获得以太网驱动句柄 */
    esp_eth_handle_t eth_handle = *(esp_eth_handle_t *)event_data;

    switch (event_id) {
        case ETHERNET_EVENT_CONNECTED:
            esp_eth_ioctl(eth_handle, ETH_CMD_G_MAC_ADDR, mac_addr);
            ESP_LOGI(TAG, "Ethernet Link Up");
            ESP_LOGI(TAG, "Ethernet HW Addr %02x:%02x:%02x:%02x:%02x:%02x",
                    mac_addr[0], mac_addr[1], mac_addr[2], mac_addr[3], mac_
            ↪addr[4], mac_addr[5]);
            break;
        case ETHERNET_EVENT_DISCONNECTED:
            ESP_LOGI(TAG, "Ethernet Link Down");
            break;
        case ETHERNET_EVENT_START:
            ESP_LOGI(TAG, "Ethernet Started");
            break;
        case ETHERNET_EVENT_STOP:
            ESP_LOGI(TAG, "Ethernet Stopped");
            break;
        default:
            break;
    }
}

esp_event_loop_create_default(); // 创建一个在后台运行的默认事件循环
esp_event_handler_register(ETH_EVENT, ESP_EVENT_ANY_ID, &eth_event_handler, NULL);
↪// 注册以太网事件处理程序（用于在发生 link up/down
↪等事件时，处理特定的用户相关内容）
```

**启动以太网驱动程序** 安装驱动程序后，可以立即启动以太网。

```
esp_eth_start(eth_handle); // 启动以太网驱动程序状态机
```

**连接驱动程序至 TCP/IP 协议栈** 现在，以太网驱动程序已经完成安装。但对应 OSI（开放式系统互连模型）来看，目前阶段仍然属于第二层（即数据链路层）。这意味着可以检测到 link up/down 事件，获得用户空间的 MAC 地址，但无法获得 IP 地址，当然也无法发送 HTTP 请求。ESP-IDF 中使用的 TCP/IP 协议栈是 LwIP，关于 LwIP 的更多信息，请参考[LwIP](#)。

要将以太网驱动程序连接至 TCP/IP 协议栈，需要以下三步：

1. 为以太网驱动程序创建网络接口
2. 将网络接口连接到以太网驱动程序
3. 注册 IP 事件处理程序

有关网络接口的更多信息，请参考[Network Interface](#)。

```

/** IP_EVENT_ETH_GOT_IP 的事件处理程序 */
static void got_ip_event_handler(void *arg, esp_event_base_t event_base,
                                int32_t event_id, void *event_data)
{
    ip_event_got_ip_t *event = (ip_event_got_ip_t *) event_data;
    const esp_netif_ip_info_t *ip_info = &event->ip_info;

    ESP_LOGI(TAG, "Ethernet Got IP Address");
    ESP_LOGI(TAG, "~~~~~");
    ESP_LOGI(TAG, "ETHIP:" IPSTR, IP2STR(&ip_info->ip));
    ESP_LOGI(TAG, "ETHMASK:" IPSTR, IP2STR(&ip_info->netmask));
    ESP_LOGI(TAG, "ETHGW:" IPSTR, IP2STR(&ip_info->gw));
    ESP_LOGI(TAG, "~~~~~");
}

esp_netif_init(); // 初始化 TCP/IP 网络接口 (在应用程序中应仅调用一次)
esp_netif_config_t cfg = ESP_NETIF_DEFAULT_ETH(); // 应用以太网的默认网络接口配置
esp_netif_t *eth_netif = esp_netif_new(&cfg); // 为以太网驱动程序创建网络接口

esp_netif_attach(eth_netif, esp_eth_new_netif_glue(eth_handle)); //
↳ 将以太网驱动程序连接至 TCP/IP 协议栈
esp_event_handler_register(IP_EVENT, IP_EVENT_ETH_GOT_IP, &got_ip_event_handler,
↳ NULL); // 注册用户定义的 IP 事件处理程序
esp_eth_start(eth_handle); // 启动以太网驱动程序状态机

```

**警告：** 推荐在完成整个以太网驱动和网络接口的初始化后，再注册用户定义的以太网/IP 事件处理程序，也就是把注册事件处理程序作为启动以太网驱动程序的最后一步。这样可以确保以太网驱动程序或网络接口将首先执行以太网/IP 事件，从而保证在执行用户定义的处理程序时，系统处于预期状态。

**以太网驱动程序的杂项控制** 以下功能只支持在安装以太网驱动程序后调用。

- 关闭以太网驱动程序: `esp_eth_stop()`
- 更新以太网数据输入路径: `esp_eth_update_input_path()`
- 获取/设置以太网驱动程序杂项内容: `esp_eth_ioctl()`

```

/* 获取 MAC 地址 */
uint8_t mac_addr[6];
memset(mac_addr, 0, sizeof(mac_addr));
esp_eth_ioctl(eth_handle, ETH_CMD_G_MAC_ADDR, mac_addr);
ESP_LOGI(TAG, "Ethernet MAC Address: %02x:%02x:%02x:%02x:%02x:%02x",
          mac_addr[0], mac_addr[1], mac_addr[2], mac_addr[3], mac_addr[4], mac_
↳ addr[5]);

/* 获取 PHY 地址 */
int phy_addr = -1;
esp_eth_ioctl(eth_handle, ETH_CMD_G_PHY_ADDR, &phy_addr);
ESP_LOGI(TAG, "Ethernet PHY Address: %d", phy_addr);

```

**数据流量控制** 受 RAM 大小限制，在网络拥堵时，MCU 上的以太网通常仅能处理有限数量的帧。发送站的数据传输速度可能快于对等端的接收能力。以太网数据流量控制机制允许接收节点向发送方发出信号，要求暂停传输，直到接收方跟上。这项功能是通过暂停帧实现的，该帧定义在 IEEE 802.3x 中。

暂停帧是一种特殊的以太网帧，用于携带暂停命令，其 EtherType 字段为 0x8808，控制操作码为 0x0001。只有配置为全双工操作的节点组可以发送暂停帧。当节点组希望暂停链路的另一端时，它会发送一个暂停帧到 48 位的保留组播地址 01-80-C2-00-00-01。暂停帧中也包括请求暂停的时间段，以两字节的整数形式发送，值的范围从 0 到 65535。

安装以太网驱动程序后，数据流量控制功能默认禁用，可以通过以下方式启用此功能：

```
bool flow_ctrl_enable = true;
esp_eth_ioctl(eth_handle, ETH_CMD_S_FLOW_CTRL, &flow_ctrl_enable);
```

需注意，暂停帧是在自动协商期间由 PHY 向对等端公布的。只有当链路两端都支持暂停帧时，以太网驱动程序才会发送暂停帧。

### 应用示例

- 以太网基本示例：[ethernet/basic](#)
- 以太网 iperf 示例：[ethernet/iperf](#)
- 以太网到 Wi-Fi AP “路由器”：[network/eth2ap](#)
- Wi-Fi station 到以太网 “网桥”：[network/sta2eth](#)
- 大多数协议示例也适用于以太网：[protocols](#)

### 进阶操作

**自定义 PHY 驱动程序** 市面上有多家 PHY 芯片制造商提供各种类型的芯片。ESP-IDF 现已支持数种 PHY 芯片，但是由于价格、功能、库存等原因，有时用户还是无法找到一款能满足其实际需求的芯片。

好在 IEEE 802.3 在其 22.2.4 管理功能部分对 EMAC 和 PHY 之间的管理接口进行了标准化。该部分定义了所谓的”MII 管理接口”规范，用于控制 PHY 和收集 PHY 的状态，还定义了一组管理寄存器来控制芯片行为、链接属性、自动协商配置等。在 ESP-IDF 中，这项基本的管理功能是由 [esp\\_eth/src/phy/esp\\_eth\\_phy\\_802\\_3.c](#) 实现的，这也大大降低了创建新的自定义 PHY 芯片驱动的难度。

**备注：** 由于一些 PHY 芯片可能不符合 IEEE 802.3 第 22.2.4 节的规定，所以请首先查看 PHY 数据手册。不过，就算芯片不符合规定，依旧可以创建自定义 PHY 驱动程序，只是由于需要自行定义所有的 PHY 管理功能，这个过程将变得较为复杂。

ESP-IDF 以太网驱动程序所需的大部分 PHY 管理功能都已涵盖在 [esp\\_eth/src/phy/esp\\_eth\\_phy\\_802\\_3.c](#) 中。不过对于以下几项，可能仍需针对不同芯片开发具体的管理功能：

- 链接状态。此项总是由使用的具体芯片决定
- 芯片初始化。即使不存在严格的限制，也应进行自定义，以确保使用的是符合预期的芯片
- 芯片的具体功能配置

#### 创建自定义 PHY 驱动程序的步骤：

1. 请根据 PHY 数据手册，定义针对供应商的特定注册表布局。示例请参见 [esp\\_eth/src/phy/esp\\_eth\\_phy\\_ip101.c](#)。
2. 准备衍生的 PHY 管理对象信息结构，该结构：
  - 必须至少包含 IEEE 802.3 [phy\\_802\\_3\\_t](#) 父对象
  - 可选择包含额外的变量，以支持非 IEEE 802.3 或定制功能。示例请参见 [esp\\_eth/src/phy/esp\\_eth\\_phy\\_ksz80xx.c](#)。
3. 定义针对芯片的特定管理回调功能。
4. 初始化 IEEE 802.3 父对象并重新分配针对芯片的特定管理回调功能。

实现新的自定义 PHY 驱动程序后，你可以通过 [ESP-IDF 组件管理中心](#) 将驱动分享给其他用户。

### API 参考

#### Header File

- [components/hal/include/hal/eth\\_types.h](#)
- This header file can be included with:

```
#include "hal/eth_types.h"
```

## Enumerations

enum **eth\_data\_interface\_t**

Ethernet interface.

*Values:*

enumerator **EMAC\_DATA\_INTERFACE\_RMII**

Reduced Media Independent Interface

enumerator **EMAC\_DATA\_INTERFACE\_MII**

Media Independent Interface

enum **eth\_link\_t**

Ethernet link status.

*Values:*

enumerator **ETH\_LINK\_UP**

Ethernet link is up

enumerator **ETH\_LINK\_DOWN**

Ethernet link is down

enum **eth\_speed\_t**

Ethernet speed.

*Values:*

enumerator **ETH\_SPEED\_10M**

Ethernet speed is 10Mbps

enumerator **ETH\_SPEED\_100M**

Ethernet speed is 100Mbps

enumerator **ETH\_SPEED\_MAX**

Max speed mode (for checking purpose)

enum **eth\_duplex\_t**

Ethernet duplex mode.

*Values:*

enumerator **ETH\_DUPLEX\_HALF**

Ethernet is in half duplex

enumerator **ETH\_DUPLEX\_FULL**

Ethernet is in full duplex

enum **eth\_checksum\_t**

Ethernet Checksum.

*Values:*



enumerator **ETH\_CHECKSUM\_SW**

Ethernet checksum calculate by software

enumerator **ETH\_CHECKSUM\_HW**

Ethernet checksum calculate by hardware

enum **eth\_mac\_dma\_burst\_len\_t**

Internal ethernet EMAC's DMA available burst sizes.

*Values:*

enumerator **ETH\_DMA\_BURST\_LEN\_32**

enumerator **ETH\_DMA\_BURST\_LEN\_16**

enumerator **ETH\_DMA\_BURST\_LEN\_8**

enumerator **ETH\_DMA\_BURST\_LEN\_4**

enumerator **ETH\_DMA\_BURST\_LEN\_2**

enumerator **ETH\_DMA\_BURST\_LEN\_1**

### Header File

- [components/esp\\_eth/include/esp\\_eth.h](#)
- This header file can be included with:

```
#include "esp_eth.h"
```

- This header file is a part of the API provided by the `esp_eth` component. To declare that your component depends on `esp_eth`, add the following to your `CMakeLists.txt`:

```
REQUIRES esp_eth
```

or

```
PRIV_REQUIRES esp_eth
```

### Header File

- [components/esp\\_eth/include/esp\\_eth\\_driver.h](#)
- This header file can be included with:

```
#include "esp_eth_driver.h"
```

- This header file is a part of the API provided by the `esp_eth` component. To declare that your component depends on `esp_eth`, add the following to your `CMakeLists.txt`:

```
REQUIRES esp_eth
```

or

```
PRIV_REQUIRES esp_eth
```

**Functions**

*esp\_err\_t* **esp\_eth\_driver\_install** (const *esp\_eth\_config\_t* \*config, *esp\_eth\_handle\_t* \*out\_hdl)

Install Ethernet driver.

**参数**

- **config** -- **[in]** configuration of the Ethernet driver
- **out\_hdl** -- **[out]** handle of Ethernet driver

**返回**

- ESP\_OK: install esp\_eth driver successfully
- ESP\_ERR\_INVALID\_ARG: install esp\_eth driver failed because of some invalid argument
- ESP\_ERR\_NO\_MEM: install esp\_eth driver failed because there's no memory for driver
- ESP\_FAIL: install esp\_eth driver failed because some other error occurred

*esp\_err\_t* **esp\_eth\_driver\_uninstall** (*esp\_eth\_handle\_t* hdl)

Uninstall Ethernet driver.

---

**备注:** It's not recommended to uninstall Ethernet driver unless it won't get used any more in application code. To uninstall Ethernet driver, you have to make sure, all references to the driver are released. Ethernet driver can only be uninstalled successfully when reference counter equals to one.

---

**参数** **hdl** -- **[in]** handle of Ethernet driver

**返回**

- ESP\_OK: uninstall esp\_eth driver successfully
- ESP\_ERR\_INVALID\_ARG: uninstall esp\_eth driver failed because of some invalid argument
- ESP\_ERR\_INVALID\_STATE: uninstall esp\_eth driver failed because it has more than one reference
- ESP\_FAIL: uninstall esp\_eth driver failed because some other error occurred

*esp\_err\_t* **esp\_eth\_start** (*esp\_eth\_handle\_t* hdl)

Start Ethernet driver **ONLY** in standalone mode (i.e. without TCP/IP stack)

---

**备注:** This API will start driver state machine and internal software timer (for checking link status).

---

**参数** **hdl** -- **[in]** handle of Ethernet driver

**返回**

- ESP\_OK: start esp\_eth driver successfully
- ESP\_ERR\_INVALID\_ARG: start esp\_eth driver failed because of some invalid argument
- ESP\_ERR\_INVALID\_STATE: start esp\_eth driver failed because driver has started already
- ESP\_FAIL: start esp\_eth driver failed because some other error occurred

*esp\_err\_t* **esp\_eth\_stop** (*esp\_eth\_handle\_t* hdl)

Stop Ethernet driver.

---

**备注:** This function does the oppsite operation of esp\_eth\_start.

---

**参数** **hdl** -- **[in]** handle of Ethernet driver

**返回**

- ESP\_OK: stop esp\_eth driver successfully
- ESP\_ERR\_INVALID\_ARG: stop esp\_eth driver failed because of some invalid argument
- ESP\_ERR\_INVALID\_STATE: stop esp\_eth driver failed because driver has not started yet



- **ESP\_FAIL**: stop esp\_eth driver failed because some other error occurred

*esp\_err\_t* **esp\_eth\_update\_input\_path** (*esp\_eth\_handle\_t* hdl, *esp\_err\_t* (\*stack\_input)(*esp\_eth\_handle\_t* hdl, uint8\_t \*buffer, uint32\_t length, void \*priv), void \*priv)

Update Ethernet data input path (i.e. specify where to pass the input buffer)

---

**备注:** After install driver, Ethernet still don't know where to deliver the input buffer. In fact, this API registers a callback function which get invoked when Ethernet received new packets.

---

#### 参数

- **hdl** -- **[in]** handle of Ethernet driver
- **stack\_input** -- **[in]** function pointer, which does the actual process on incoming packets
- **priv** -- **[in]** private resource, which gets passed to `stack_input` callback without any modification

#### 返回

- **ESP\_OK**: update input path successfully
- **ESP\_ERR\_INVALID\_ARG**: update input path failed because of some invalid argument
- **ESP\_FAIL**: update input path failed because some other error occurred

*esp\_err\_t* **esp\_eth\_transmit** (*esp\_eth\_handle\_t* hdl, void \*buf, size\_t length)

General Transmit.

#### 参数

- **hdl** -- **[in]** handle of Ethernet driver
- **buf** -- **[in]** buffer of the packet to transfer
- **length** -- **[in]** length of the buffer to transfer

#### 返回

- **ESP\_OK**: transmit frame buffer successfully
- **ESP\_ERR\_INVALID\_ARG**: transmit frame buffer failed because of some invalid argument
- **ESP\_ERR\_INVALID\_STATE**: invalid driver state (e.i. driver is not started)
- **ESP\_ERR\_TIMEOUT**: transmit frame buffer failed because HW was not get available in predefined period
- **ESP\_FAIL**: transmit frame buffer failed because some other error occurred

*esp\_err\_t* **esp\_eth\_transmit\_vargs** (*esp\_eth\_handle\_t* hdl, uint32\_t argc, ...)

Special Transmit with variable number of arguments.

#### 参数

- **hdl** -- **[in]** handle of Ethernet driver
- **argc** -- **[in]** number variable arguments
- ... -- variable arguments

#### 返回

- **ESP\_OK**: transmit successful
- **ESP\_ERR\_INVALID\_STATE**: invalid driver state (e.i. driver is not started)
- **ESP\_ERR\_TIMEOUT**: transmit frame buffer failed because HW was not get available in predefined period
- **ESP\_FAIL**: transmit frame buffer failed because some other error occurred

*esp\_err\_t* **esp\_eth\_ioctl** (*esp\_eth\_handle\_t* hdl, *esp\_eth\_io\_cmd\_t* cmd, void \*data)

Misc IO function of Ethernet driver.

The following common IO control commands are supported:

- **ETH\_CMD\_S\_MAC\_ADDR** sets Ethernet interface MAC address. `data` argument is pointer to MAC address buffer with expected size of 6 bytes.

- `ETH_CMD_G_MAC_ADDR` gets Ethernet interface MAC address. `data` argument is pointer to a buffer to which MAC address is to be copied. The buffer size must be at least 6 bytes.
- `ETH_CMD_S_PHY_ADDR` sets PHY address in range of <0-31>. `data` argument is pointer to memory of `uint32_t` datatype from where the configuration option is read.
- `ETH_CMD_G_PHY_ADDR` gets PHY address. `data` argument is pointer to memory of `uint32_t` datatype to which the PHY address is to be stored.
- `ETH_CMD_S_AUTONEGO` enables or disables Ethernet link speed and duplex mode autonegotiation. `data` argument is pointer to memory of `bool` datatype from which the configuration option is read. Preconditions: Ethernet driver needs to be stopped.
- `ETH_CMD_G_AUTONEGO` gets current configuration of the Ethernet link speed and duplex mode autonegotiation. `data` argument is pointer to memory of `bool` datatype to which the current configuration is to be stored.
- `ETH_CMD_S_SPEED` sets the Ethernet link speed. `data` argument is pointer to memory of `eth_speed_t` datatype from which the configuration option is read. Preconditions: Ethernet driver needs to be stopped and auto-negotiation disabled.
- `ETH_CMD_G_SPEED` gets current Ethernet link speed. `data` argument is pointer to memory of `eth_speed_t` datatype to which the speed is to be stored.
- `ETH_CMD_S_PROMISCUOUS` sets/resets Ethernet interface promiscuous mode. `data` argument is pointer to memory of `bool` datatype from which the configuration option is read.
- `ETH_CMD_S_FLOW_CTRL` sets/resets Ethernet interface flow control. `data` argument is pointer to memory of `bool` datatype from which the configuration option is read.
- `ETH_CMD_S_DUPLEX_MODE` sets the Ethernet duplex mode. `data` argument is pointer to memory of `eth_duplex_t` datatype from which the configuration option is read. Preconditions: Ethernet driver needs to be stopped and auto-negotiation disabled.
- `ETH_CMD_G_DUPLEX_MODE` gets current Ethernet link duplex mode. `data` argument is pointer to memory of `eth_duplex_t` datatype to which the duplex mode is to be stored.
- `ETH_CMD_S_PHY_LOOPBACK` sets/resets PHY to/from loopback mode. `data` argument is pointer to memory of `bool` datatype from which the configuration option is read.
- Note that additional control commands may be available for specific MAC or PHY chips. Please consult specific MAC or PHY documentation or driver code.

#### 参数

- **hdl** -- **[in]** handle of Ethernet driver
- **cmd** -- **[in]** IO control command
- **data** -- **[inout]** address of data for `set` command or address where to store the data when used with `get` command

#### 返回

- `ESP_OK`: process io command successfully
- `ESP_ERR_INVALID_ARG`: process io command failed because of some invalid argument
- `ESP_FAIL`: process io command failed because some other error occurred
- `ESP_ERR_NOT_SUPPORTED`: requested feature is not supported

`esp_err_t esp_eth_get_phy_instance(esp_eth_handle_t hdl, esp_eth_phy_t **phy)`

Get PHY instance memory address.

#### 参数

- **hdl** -- **[in]** handle of Ethernet driver
- **phy** -- **[out]** pointer to memory to store the instance

#### 返回

- `ESP_OK`: success
- `ESP_ERR_INVALID_ARG`: failed because of some invalid argument

`esp_err_t esp_eth_get_mac_instance(esp_eth_handle_t hdl, esp_eth_mac_t **mac)`

Get MAC instance memory address.

#### 参数

- **hdl** -- **[in]** handle of Ethernet driver
- **mac** -- **[out]** pointer to memory to store the instance

返回 `esp_err_t`

- `ESP_OK`: success
- `ESP_ERR_INVALID_ARG`: failed because of some invalid argument

`esp_err_t esp_eth_increase_reference(esp_eth_handle_t hdl)`

Increase Ethernet driver reference.

---

**备注:** Ethernet driver handle can be obtained by os timer, netif, etc. It's dangerous when thread A is using Ethernet but thread B uninstall the driver. Using reference counter can prevent such risk, but care should be taken, when you obtain Ethernet driver, this API must be invoked so that the driver won't be uninstalled during your using time.

---

参数 `hdl` -- [in] handle of Ethernet driver

返回

- `ESP_OK`: increase reference successfully
- `ESP_ERR_INVALID_ARG`: increase reference failed because of some invalid argument

`esp_err_t esp_eth_decrease_reference(esp_eth_handle_t hdl)`

Decrease Ethernet driver reference.

参数 `hdl` -- [in] handle of Ethernet driver

返回

- `ESP_OK`: increase reference successfully
- `ESP_ERR_INVALID_ARG`: increase reference failed because of some invalid argument

## Structures

struct `esp_eth_config_t`

Configuration of Ethernet driver.

## Public Members

`esp_eth_mac_t *mac`

Ethernet MAC object.

`esp_eth_phy_t *phy`

Ethernet PHY object.

`uint32_t check_link_period_ms`

Period time of checking Ethernet link status.

`esp_err_t (*stack_input)(esp_eth_handle_t eth_handle, uint8_t *buffer, uint32_t length, void *priv)`

Input frame buffer to user's stack.

**Param eth\_handle** [in] handle of Ethernet driver

**Param buffer** [in] frame buffer that will get input to upper stack

**Param length** [in] length of the frame buffer

**Return**

- `ESP_OK`: input frame buffer to upper stack successfully
- `ESP_FAIL`: error occurred when inputting buffer to upper stack

`esp_err_t (*on_lowlevel_init_done)(esp_eth_handle_t eth_handle)`

Callback function invoked when lowlevel initialization is finished.

**Param eth\_handle [in]** handle of Ethernet driver

**Return**

- ESP\_OK: process extra lowlevel initialization successfully
- ESP\_FAIL: error occurred when processing extra lowlevel initialization

*esp\_err\_t* (\***on\_lowlevel\_deinit\_done**)(*esp\_eth\_handle\_t* eth\_handle)

Callback function invoked when lowlevel deinitialization is finished.

**Param eth\_handle [in]** handle of Ethernet driver

**Return**

- ESP\_OK: process extra lowlevel deinitialization successfully
- ESP\_FAIL: error occurred when processing extra lowlevel deinitialization

*esp\_err\_t* (\***read\_phy\_reg**)(*esp\_eth\_handle\_t* eth\_handle, uint32\_t phy\_addr, uint32\_t phy\_reg, uint32\_t \*reg\_value)

Read PHY register.

---

**备注:** Usually the PHY register read/write function is provided by MAC (SMI interface), but if the PHY device is managed by other interface (e.g. I2C), then user needs to implement the corresponding read/write. Setting this to NULL means your PHY device is managed by MAC's SMI interface.

---

**Param eth\_handle [in]** handle of Ethernet driver

**Param phy\_addr [in]** PHY chip address (0~31)

**Param phy\_reg [in]** PHY register index code

**Param reg\_value [out]** PHY register value

**Return**

- ESP\_OK: read PHY register successfully
- ESP\_ERR\_INVALID\_ARG: read PHY register failed because of invalid argument
- ESP\_ERR\_TIMEOUT: read PHY register failed because of timeout
- ESP\_FAIL: read PHY register failed because some other error occurred

*esp\_err\_t* (\***write\_phy\_reg**)(*esp\_eth\_handle\_t* eth\_handle, uint32\_t phy\_addr, uint32\_t phy\_reg, uint32\_t reg\_value)

Write PHY register.

---

**备注:** Usually the PHY register read/write function is provided by MAC (SMI interface), but if the PHY device is managed by other interface (e.g. I2C), then user needs to implement the corresponding read/write. Setting this to NULL means your PHY device is managed by MAC's SMI interface.

---

**Param eth\_handle [in]** handle of Ethernet driver

**Param phy\_addr [in]** PHY chip address (0~31)

**Param phy\_reg [in]** PHY register index code

**Param reg\_value [in]** PHY register value

**Return**

- ESP\_OK: write PHY register successfully
- ESP\_ERR\_INVALID\_ARG: read PHY register failed because of invalid argument
- ESP\_ERR\_TIMEOUT: write PHY register failed because of timeout
- ESP\_FAIL: write PHY register failed because some other error occurred

struct **esp\_eth\_phy\_reg\_rw\_data\_t**

Data structure to Read/Write PHY register via ioctl API.

### Public Members

uint32\_t **reg\_addr**

PHY register address

uint32\_t \***reg\_value\_p**

Pointer to a memory where the register value is read/written

### Macros

**ETH\_DEFAULT\_CONFIG** (emac, ephy)

Default configuration for Ethernet driver.

### Type Definitions

typedef void \***esp\_eth\_handle\_t**

Handle of Ethernet driver.

### Enumerations

enum **esp\_eth\_io\_cmd\_t**

Command list for ioctl API.

*Values:*

enumerator **ETH\_CMD\_G\_MAC\_ADDR**

Get MAC address

enumerator **ETH\_CMD\_S\_MAC\_ADDR**

Set MAC address

enumerator **ETH\_CMD\_G\_PHY\_ADDR**

Get PHY address

enumerator **ETH\_CMD\_S\_PHY\_ADDR**

Set PHY address

enumerator **ETH\_CMD\_G\_AUTONEGO**

Get PHY Auto Negotiation

enumerator **ETH\_CMD\_S\_AUTONEGO**

Set PHY Auto Negotiation

enumerator **ETH\_CMD\_G\_SPEED**

Get Speed

enumerator **ETH\_CMD\_S\_SPEED**

Set Speed

enumerator **ETH\_CMD\_S\_PROMISCUOUS**

Set promiscuous mode

- enumerator **ETH\_CMD\_S\_FLOW\_CTRL**  
Set flow control
- enumerator **ETH\_CMD\_G\_DUPLEX\_MODE**  
Get Duplex mode
- enumerator **ETH\_CMD\_S\_DUPLEX\_MODE**  
Set Duplex mode
- enumerator **ETH\_CMD\_S\_PHY\_LOOPBACK**  
Set PHY loopback
- enumerator **ETH\_CMD\_READ\_PHY\_REG**  
Read PHY register
- enumerator **ETH\_CMD\_WRITE\_PHY\_REG**  
Write PHY register
- enumerator **ETH\_CMD\_CUSTOM\_MAC\_CMDS**
- enumerator **ETH\_CMD\_CUSTOM\_PHY\_CMDS**

### Header File

- [components/esp\\_eth/include/esp\\_eth\\_com.h](#)
- This header file can be included with:

```
#include "esp_eth_com.h"
```

- This header file is a part of the API provided by the `esp_eth` component. To declare that your component depends on `esp_eth`, add the following to your `CMakeLists.txt`:

```
REQUIRES esp_eth
```

or

```
PRIV_REQUIRES esp_eth
```

### Structures

struct **esp\_eth\_mediator\_s**

Ethernet mediator.

### Public Members

*esp\_err\_t* (**\*phy\_reg\_read**)(*esp\_eth\_mediator\_t* \*eth, uint32\_t phy\_addr, uint32\_t phy\_reg, uint32\_t \*reg\_value)

Read PHY register.

- Param eth [in]** mediator of Ethernet driver
- Param phy\_addr [in]** PHY Chip address (0~31)
- Param phy\_reg [in]** PHY register index code
- Param reg\_value [out]** PHY register value

**Return**

- ESP\_OK: read PHY register successfully
- ESP\_FAIL: read PHY register failed because some error occurred

*esp\_err\_t* (\***phy\_reg\_write**)(*esp\_eth\_mediator\_t* \*eth, uint32\_t phy\_addr, uint32\_t phy\_reg, uint32\_t reg\_value)

Write PHY register.

**Param eth [in]** mediator of Ethernet driver

**Param phy\_addr [in]** PHY Chip address (0~31)

**Param phy\_reg [in]** PHY register index code

**Param reg\_value [in]** PHY register value

**Return**

- ESP\_OK: write PHY register successfully
- ESP\_FAIL: write PHY register failed because some error occurred

*esp\_err\_t* (\***stack\_input**)(*esp\_eth\_mediator\_t* \*eth, uint8\_t \*buffer, uint32\_t length)

Deliver packet to upper stack.

**Param eth [in]** mediator of Ethernet driver

**Param buffer [in]** packet buffer

**Param length [in]** length of the packet

**Return**

- ESP\_OK: deliver packet to upper stack successfully
- ESP\_FAIL: deliver packet failed because some error occurred

*esp\_err\_t* (\***on\_state\_changed**)(*esp\_eth\_mediator\_t* \*eth, *esp\_eth\_state\_t* state, void \*args)

Callback on Ethernet state changed.

**Param eth [in]** mediator of Ethernet driver

**Param state [in]** new state

**Param args [in]** optional argument for the new state

**Return**

- ESP\_OK: process the new state successfully
- ESP\_FAIL: process the new state failed because some error occurred

**Macros**

**ETH\_CMD\_CUSTOM\_MAC\_CMDS\_OFFSET**

Offset for start of MAC custom ioctl commands.

**ETH\_CMD\_CUSTOM\_PHY\_CMDS\_OFFSET**

Offset for start of PHY custom ioctl commands.

**Type Definitions**

typedef struct *esp\_eth\_mediator\_s* **esp\_eth\_mediator\_t**

Ethernet mediator.

**Enumerations**

enum **esp\_eth\_state\_t**

Ethernet driver state.

*Values:*

enumerator **ETH\_STATE\_LLINIT**

Lowlevel init done

enumerator **ETH\_STATE\_DEINIT**

Deinit done

enumerator **ETH\_STATE\_LINK**

Link status changed

enumerator **ETH\_STATE\_SPEED**

Speed updated

enumerator **ETH\_STATE\_DUPLEX**

Duplex updated

enumerator **ETH\_STATE\_PAUSE**

Pause ability updated

enum **eth\_event\_t**

Ethernet event declarations.

*Values:*

enumerator **ETHERNET\_EVENT\_START**

Ethernet driver start

enumerator **ETHERNET\_EVENT\_STOP**

Ethernet driver stop

enumerator **ETHERNET\_EVENT\_CONNECTED**

Ethernet got a valid link

enumerator **ETHERNET\_EVENT\_DISCONNECTED**

Ethernet lost a valid link

### Header File

- [components/esp\\_eth/include/esp\\_eth\\_mac.h](#)
- This header file can be included with:

```
#include "esp_eth_mac.h"
```

- This header file is a part of the API provided by the `esp_eth` component. To declare that your component depends on `esp_eth`, add the following to your `CMakeLists.txt`:

```
REQUIRES esp_eth
```

or

```
PRIV_REQUIRES esp_eth
```



## Structures

struct **esp\_eth\_mac\_s**

Ethernet MAC.

## Public Members

*esp\_err\_t* (**\*set\_mediator**)(*esp\_eth\_mac\_t* \*mac, *esp\_eth\_mediator\_t* \*eth)

Set mediator for Ethernet MAC.

**Param mac [in]** Ethernet MAC instance

**Param eth [in]** Ethernet mediator

**Return**

- ESP\_OK: set mediator for Ethernet MAC successfully
- ESP\_ERR\_INVALID\_ARG: set mediator for Ethernet MAC failed because of invalid argument

*esp\_err\_t* (**\*init**)(*esp\_eth\_mac\_t* \*mac)

Initialize Ethernet MAC.

**Param mac [in]** Ethernet MAC instance

**Return**

- ESP\_OK: initialize Ethernet MAC successfully
- ESP\_ERR\_TIMEOUT: initialize Ethernet MAC failed because of timeout
- ESP\_FAIL: initialize Ethernet MAC failed because some other error occurred

*esp\_err\_t* (**\*deinit**)(*esp\_eth\_mac\_t* \*mac)

Deinitialize Ethernet MAC.

**Param mac [in]** Ethernet MAC instance

**Return**

- ESP\_OK: deinitialize Ethernet MAC successfully
- ESP\_FAIL: deinitialize Ethernet MAC failed because some error occurred

*esp\_err\_t* (**\*start**)(*esp\_eth\_mac\_t* \*mac)

Start Ethernet MAC.

**Param mac [in]** Ethernet MAC instance

**Return**

- ESP\_OK: start Ethernet MAC successfully
- ESP\_FAIL: start Ethernet MAC failed because some other error occurred

*esp\_err\_t* (**\*stop**)(*esp\_eth\_mac\_t* \*mac)

Stop Ethernet MAC.

**Param mac [in]** Ethernet MAC instance

**Return**

- ESP\_OK: stop Ethernet MAC successfully
- ESP\_FAIL: stop Ethernet MAC failed because some error occurred

*esp\_err\_t* (**\*transmit**)(*esp\_eth\_mac\_t* \*mac, uint8\_t \*buf, uint32\_t length)

Transmit packet from Ethernet MAC.

---

**备注:** Returned error codes may differ for each specific MAC chip.

---

**Param mac [in]** Ethernet MAC instance

**Param buf [in]** packet buffer to transmit

**Param length [in]** length of packet

**Return**

- ESP\_OK: transmit packet successfully
- ESP\_ERR\_INVALID\_SIZE: number of actually sent bytes differs to expected
- ESP\_FAIL: transmit packet failed because some other error occurred

*esp\_err\_t* (**\*transmit\_vargs**)(*esp\_eth\_mac\_t* \*mac, uint32\_t argc, va\_list args)

Transmit packet from Ethernet MAC constructed with special parameters at Layer2.

---

**备注:** Typical intended use case is to make possible to construct a frame from multiple higher layer buffers without a need of buffer reallocations. However, other use cases are not limited.

---



---

**备注:** Returned error codes may differ for each specific MAC chip.

---

**Param mac [in]** Ethernet MAC instance

**Param argc [in]** number variable arguments

**Param args [in]** variable arguments

**Return**

- ESP\_OK: transmit packet successfully
- ESP\_ERR\_INVALID\_SIZE: number of actually sent bytes differs to expected
- ESP\_FAIL: transmit packet failed because some other error occurred

*esp\_err\_t* (**\*receive**)(*esp\_eth\_mac\_t* \*mac, uint8\_t \*buf, uint32\_t \*length)

Receive packet from Ethernet MAC.

---

**备注:** Memory of buf is allocated in the Layer2, make sure it get free after process.

---



---

**备注:** Before this function got invoked, the value of "length" should set by user, equals the size of buffer. After the function returned, the value of "length" means the real length of received data.

---

**Param mac [in]** Ethernet MAC instance

**Param buf [out]** packet buffer which will preserve the received frame

**Param length [out]** length of the received packet

**Return**

- ESP\_OK: receive packet successfully
- ESP\_ERR\_INVALID\_ARG: receive packet failed because of invalid argument
- ESP\_ERR\_INVALID\_SIZE: input buffer size is not enough to hold the incoming data. in this case, value of returned "length" indicates the real size of incoming data.
- ESP\_FAIL: receive packet failed because some other error occurred

*esp\_err\_t* (**\*read\_phy\_reg**)(*esp\_eth\_mac\_t* \*mac, uint32\_t phy\_addr, uint32\_t phy\_reg, uint32\_t \*reg\_value)

Read PHY register.

**Param mac [in]** Ethernet MAC instance

**Param phy\_addr [in]** PHY chip address (0~31)

**Param phy\_reg [in]** PHY register index code

**Param reg\_value [out]** PHY register value

**Return**

- ESP\_OK: read PHY register successfully
- ESP\_ERR\_INVALID\_ARG: read PHY register failed because of invalid argument
- ESP\_ERR\_INVALID\_STATE: read PHY register failed because of wrong state of MAC
- ESP\_ERR\_TIMEOUT: read PHY register failed because of timeout
- ESP\_FAIL: read PHY register failed because some other error occurred

*esp\_err\_t* (\***write\_phy\_reg**)(*esp\_eth\_mac\_t* \*mac, uint32\_t phy\_addr, uint32\_t phy\_reg, uint32\_t reg\_value)

Write PHY register.

**Param mac [in]** Ethernet MAC instance

**Param phy\_addr [in]** PHY chip address (0~31)

**Param phy\_reg [in]** PHY register index code

**Param reg\_value [in]** PHY register value

**Return**

- ESP\_OK: write PHY register successfully
- ESP\_ERR\_INVALID\_STATE: write PHY register failed because of wrong state of MAC
- ESP\_ERR\_TIMEOUT: write PHY register failed because of timeout
- ESP\_FAIL: write PHY register failed because some other error occurred

*esp\_err\_t* (\***set\_addr**)(*esp\_eth\_mac\_t* \*mac, uint8\_t \*addr)

Set MAC address.

**Param mac [in]** Ethernet MAC instance

**Param addr [in]** MAC address

**Return**

- ESP\_OK: set MAC address successfully
- ESP\_ERR\_INVALID\_ARG: set MAC address failed because of invalid argument
- ESP\_FAIL: set MAC address failed because some other error occurred

*esp\_err\_t* (\***get\_addr**)(*esp\_eth\_mac\_t* \*mac, uint8\_t \*addr)

Get MAC address.

**Param mac [in]** Ethernet MAC instance

**Param addr [out]** MAC address

**Return**

- ESP\_OK: get MAC address successfully
- ESP\_ERR\_INVALID\_ARG: get MAC address failed because of invalid argument
- ESP\_FAIL: get MAC address failed because some other error occurred

*esp\_err\_t* (\***set\_speed**)(*esp\_eth\_mac\_t* \*mac, *eth\_speed\_t* speed)

Set speed of MAC.

**Param mac [in]** Ethernet MAC instance

**Param speed [in]** MAC speed

**Return**

- ESP\_OK: set MAC speed successfully
- ESP\_ERR\_INVALID\_ARG: set MAC speed failed because of invalid argument
- ESP\_FAIL: set MAC speed failed because some other error occurred

*esp\_err\_t* (\***set\_duplex**)(*esp\_eth\_mac\_t* \*mac, *eth\_duplex\_t* duplex)

Set duplex mode of MAC.

**Param mac [in]** Ethernet MAC instance

**Param duplex [in]** MAC duplex

**Return**

- ESP\_OK: set MAC duplex mode successfully
- ESP\_ERR\_INVALID\_ARG: set MAC duplex failed because of invalid argument
- ESP\_FAIL: set MAC duplex failed because some other error occurred

*esp\_err\_t* (\***set\_link**)(*esp\_eth\_mac\_t* \*mac, *eth\_link\_t* link)

Set link status of MAC.

**Param mac [in]** Ethernet MAC instance

**Param link [in]** Link status

**Return**

- ESP\_OK: set link status successfully
- ESP\_ERR\_INVALID\_ARG: set link status failed because of invalid argument
- ESP\_FAIL: set link status failed because some other error occurred

*esp\_err\_t* (\***set\_promiscuous**)(*esp\_eth\_mac\_t* \*mac, bool enable)

Set promiscuous of MAC.

**Param mac [in]** Ethernet MAC instance

**Param enable [in]** set true to enable promiscuous mode; set false to disable promiscuous mode

**Return**

- ESP\_OK: set promiscuous mode successfully
- ESP\_FAIL: set promiscuous mode failed because some error occurred

*esp\_err\_t* (\***enable\_flow\_ctrl**)(*esp\_eth\_mac\_t* \*mac, bool enable)

Enable flow control on MAC layer or not.

**Param mac [in]** Ethernet MAC instance

**Param enable [in]** set true to enable flow control; set false to disable flow control

**Return**

- ESP\_OK: set flow control successfully
- ESP\_FAIL: set flow control failed because some error occurred

*esp\_err\_t* (\***set\_peer\_pause\_ability**)(*esp\_eth\_mac\_t* \*mac, uint32\_t ability)

Set the PAUSE ability of peer node.

**Param mac [in]** Ethernet MAC instance

**Param ability [in]** zero indicates that pause function is supported by link partner; non-zero indicates that pause function is not supported by link partner

**Return**

- ESP\_OK: set peer pause ability successfully
- ESP\_FAIL: set peer pause ability failed because some error occurred

*esp\_err\_t* (\***custom\_ioctl**)(*esp\_eth\_mac\_t* \*mac, int cmd, void \*data)

Custom IO function of MAC driver. This function is intended to extend common options of *esp\_eth\_ioctl* to cover specifics of MAC chip.

---

**备注:** This function may not be assigned when the MAC chip supports only most common set of configuration options.

---

**Param mac [in]** Ethernet MAC instance

**Param cmd [in]** IO control command

**Param data [inout]** address of data for *set* command or address where to store the data when used with *get* command

**Return**

- ESP\_OK: process io command successfully

- `ESP_ERR_INVALID_ARG`: process io command failed because of some invalid argument
- `ESP_FAIL`: process io command failed because some other error occurred
- `ESP_ERR_NOT_SUPPORTED`: requested feature is not supported

`esp_err_t (*del)(esp_eth_mac_t *mac)`

Free memory of Ethernet MAC.

**Param mac [in]** Ethernet MAC instance

**Return**

- `ESP_OK`: free Ethernet MAC instance successfully
- `ESP_FAIL`: free Ethernet MAC instance failed because some error occurred

struct `eth_mac_config_t`

Configuration of Ethernet MAC object.

### Public Members

`uint32_t sw_reset_timeout_ms`

Software reset timeout value (Unit: ms)

`uint32_t rx_task_stack_size`

Stack size of the receive task

`uint32_t rx_task_prio`

Priority of the receive task

`uint32_t flags`

Flags that specify extra capability for mac driver

### Macros

`ETH_MAC_FLAG_WORK_WITH_CACHE_DISABLE`

MAC driver can work when cache is disabled

`ETH_MAC_FLAG_PIN_TO_CORE`

Pin MAC task to the CPU core where driver installation happened

`ETH_MAC_DEFAULT_CONFIG()`

Default configuration for Ethernet MAC object.

### Type Definitions

typedef struct `esp_eth_mac_s` `esp_eth_mac_t`

Ethernet MAC.

### Header File

- `components/esp_eth/include/esp_eth_mac_esp.h`
- This header file can be included with:

```
#include "esp_eth_mac_esp.h"
```

- This header file is a part of the API provided by the `esp_eth` component. To declare that your component depends on `esp_eth`, add the following to your `CMakeLists.txt`:

```
REQUIRES esp_eth
```

or

```
PRIV_REQUIRES esp_eth
```

### Header File

- `components/esp_eth/include/esp_eth_mac_spi.h`
- This header file can be included with:

```
#include "esp_eth_mac_spi.h"
```

- This header file is a part of the API provided by the `esp_eth` component. To declare that your component depends on `esp_eth`, add the following to your `CMakeLists.txt`:

```
REQUIRES esp_eth
```

or

```
PRIV_REQUIRES esp_eth
```

### Structures

struct **eth\_spi\_custom\_driver\_config\_t**

Custom SPI Driver Configuration. This structure declares configuration and callback functions to access Ethernet SPI module via user's custom SPI driver.

#### Public Members

void \***config**

Custom driver specific configuration data used by `init()` function.

---

**备注:** Type and its content is fully under user's control

---

void \*(\***init**)(const void \*spi\_config)

Custom driver SPI Initialization.

---

**备注:** return type and its content is fully under user's control

---

**Param spi\_config [in]** Custom driver specific configuration

#### Return

- `spi_ctx`: when initialization is successful, a pointer to context structure holding all variables needed for subsequent SPI access operations (e.g. SPI bus identification, mutexes, etc.)
- `NULL`: driver initialization failed

`esp_err_t` (\***deinit**)(void \*spi\_ctx)

Custom driver De-initialization.

**Param spi\_ctx [in]** a pointer to driver specific context structure

**Return**

- ESP\_OK: driver de-initialization was successful
- ESP\_FAIL: driver de-initialization failed
- any other failure codes are allowed to be used to provide failure isolation

*esp\_err\_t* (\***read**)(void \*spi\_ctx, uint32\_t cmd, uint32\_t addr, void \*data, uint32\_t data\_len)

Custom driver SPI read.

---

**备注:** The read function is responsible to construct command, address and data fields of the SPI frame in format expected by particular SPI Ethernet module

---

**Param spi\_ctx [in]** a pointer to driver specific context structure

**Param cmd [in]** command

**Param addr [in]** register address

**Param data [out]** read data

**Param data\_len [in]** read data length in bytes

**Return**

- ESP\_OK: read was successful
- ESP\_FAIL: read failed
- any other failure codes are allowed to be used to provide failure isolation

*esp\_err\_t* (\***write**)(void \*spi\_ctx, uint32\_t cmd, uint32\_t addr, const void \*data, uint32\_t data\_len)

Custom driver SPI write.

---

**备注:** The write function is responsible to construct command, address and data fields of the SPI frame in format expected by particular SPI Ethernet module

---

**Param spi\_ctx [in]** a pointer to driver specific context structure

**Param cmd [in]** command

**Param addr [in]** register address

**Param data [in]** data to write

**Param data\_len [in]** length of data to write in bytes

**Return**

- ESP\_OK: write was successful
- ESP\_FAIL: write failed
- any other failure codes are allowed to be used to provide failure isolation

## Macros

### ETH\_DEFAULT\_SPI

Default configuration of the custom SPI driver. Internal ESP-IDF SPI Master driver is used by default.

## Header File

- [components/esp\\_eth/include/esp\\_eth\\_phy.h](#)
- This header file can be included with:

```
#include "esp_eth_phy.h"
```

- This header file is a part of the API provided by the `esp_eth` component. To declare that your component depends on `esp_eth`, add the following to your `CMakeLists.txt`:

```
REQUIRES esp_eth
```

or

```
PRIV_REQUIRES esp_eth
```

## Functions

*esp\_eth\_phy\_t* \***esp\_eth\_phy\_new\_ip101** (const *eth\_phy\_config\_t* \*config)

Create a PHY instance of IP101.

**参数 config** -- [in] configuration of PHY

**返回**

- instance: create PHY instance successfully
- NULL: create PHY instance failed because some error occurred

*esp\_eth\_phy\_t* \***esp\_eth\_phy\_new\_rt18201** (const *eth\_phy\_config\_t* \*config)

Create a PHY instance of RTL8201.

**参数 config** -- [in] configuration of PHY

**返回**

- instance: create PHY instance successfully
- NULL: create PHY instance failed because some error occurred

*esp\_eth\_phy\_t* \***esp\_eth\_phy\_new\_lan87xx** (const *eth\_phy\_config\_t* \*config)

Create a PHY instance of LAN87xx.

**参数 config** -- [in] configuration of PHY

**返回**

- instance: create PHY instance successfully
- NULL: create PHY instance failed because some error occurred

*esp\_eth\_phy\_t* \***esp\_eth\_phy\_new\_dp83848** (const *eth\_phy\_config\_t* \*config)

Create a PHY instance of DP83848.

**参数 config** -- [in] configuration of PHY

**返回**

- instance: create PHY instance successfully
- NULL: create PHY instance failed because some error occurred

*esp\_eth\_phy\_t* \***esp\_eth\_phy\_new\_ksz80xx** (const *eth\_phy\_config\_t* \*config)

Create a PHY instance of KSZ80xx.

The phy model from the KSZ80xx series is detected automatically. If the driver is unable to detect a supported model, NULL is returned.

Currently, the following models are supported: KSZ8001, KSZ8021, KSZ8031, KSZ8041, KSZ8051, KSZ8061, KSZ8081, KSZ8091

**参数 config** -- [in] configuration of PHY

**返回**

- instance: create PHY instance successfully
- NULL: create PHY instance failed because some error occurred

## Structures

struct **esp\_eth\_phy\_s**

Ethernet PHY.

## Public Members



*esp\_err\_t* (\***set\_mediator**)(*esp\_eth\_phy\_t* \*phy, *esp\_eth\_mediator\_t* \*mediator)

Set mediator for PHY.

**Param phy [in]** Ethernet PHY instance

**Param mediator [in]** mediator of Ethernet driver

**Return**

- ESP\_OK: set mediator for Ethernet PHY instance successfully
- ESP\_ERR\_INVALID\_ARG: set mediator for Ethernet PHY instance failed because of some invalid arguments

*esp\_err\_t* (\***reset**)(*esp\_eth\_phy\_t* \*phy)

Software Reset Ethernet PHY.

**Param phy [in]** Ethernet PHY instance

**Return**

- ESP\_OK: reset Ethernet PHY successfully
- ESP\_FAIL: reset Ethernet PHY failed because some error occurred

*esp\_err\_t* (\***reset\_hw**)(*esp\_eth\_phy\_t* \*phy)

Hardware Reset Ethernet PHY.

---

**备注:** Hardware reset is mostly done by pull down and up PHY's nRST pin

---

**Param phy [in]** Ethernet PHY instance

**Return**

- ESP\_OK: reset Ethernet PHY successfully
- ESP\_FAIL: reset Ethernet PHY failed because some error occurred

*esp\_err\_t* (\***init**)(*esp\_eth\_phy\_t* \*phy)

Initialize Ethernet PHY.

**Param phy [in]** Ethernet PHY instance

**Return**

- ESP\_OK: initialize Ethernet PHY successfully
- ESP\_FAIL: initialize Ethernet PHY failed because some error occurred

*esp\_err\_t* (\***deinit**)(*esp\_eth\_phy\_t* \*phy)

Deinitialize Ethernet PHY.

**Param phy [in]** Ethernet PHY instance

**Return**

- ESP\_OK: deinitialize Ethernet PHY successfully
- ESP\_FAIL: deinitialize Ethernet PHY failed because some error occurred

*esp\_err\_t* (\***autonego\_ctrl**)(*esp\_eth\_phy\_t* \*phy, *eth\_phy\_autonego\_cmd\_t* cmd, bool \*autonego\_en\_stat)

Configure auto negotiation.

**Param phy [in]** Ethernet PHY instance

**Param cmd [in]** Configuration command, it is possible to Enable (restart), Disable or get current status of PHY auto negotiation

**Param autonego\_en\_stat [out]** Address where to store current status of auto negotiation configuration

**Return**

- ESP\_OK: restart auto negotiation successfully
- ESP\_FAIL: restart auto negotiation failed because some error occurred

- ESP\_ERR\_INVALID\_ARG: invalid command

*esp\_err\_t* (\***get\_link**)(*esp\_eth\_phy\_t* \*phy)

Get Ethernet PHY link status.

**Param phy [in]** Ethernet PHY instance

**Return**

- ESP\_OK: get Ethernet PHY link status successfully
- ESP\_FAIL: get Ethernet PHY link status failed because some error occurred

*esp\_err\_t* (\***set\_link**)(*esp\_eth\_phy\_t* \*phy, *eth\_link\_t* link)

Set Ethernet PHY link status.

**Param phy [in]** Ethernet PHY instance

**Param link [in]** new link status

**Return**

- ESP\_OK: set Ethernet PHY link status successfully
- ESP\_FAIL: set Ethernet PHY link status failed because some error occurred

*esp\_err\_t* (\***pwrcctl**)(*esp\_eth\_phy\_t* \*phy, bool enable)

Power control of Ethernet PHY.

**Param phy [in]** Ethernet PHY instance

**Param enable [in]** set true to power on Ethernet PHY; ser false to power off Ethernet PHY

**Return**

- ESP\_OK: control Ethernet PHY power successfully
- ESP\_FAIL: control Ethernet PHY power failed because some error occurred

*esp\_err\_t* (\***set\_addr**)(*esp\_eth\_phy\_t* \*phy, uint32\_t addr)

Set PHY chip address.

**Param phy [in]** Ethernet PHY instance

**Param addr [in]** PHY chip address

**Return**

- ESP\_OK: set Ethernet PHY address successfully
- ESP\_FAIL: set Ethernet PHY address failed because some error occurred

*esp\_err\_t* (\***get\_addr**)(*esp\_eth\_phy\_t* \*phy, uint32\_t \*addr)

Get PHY chip address.

**Param phy [in]** Ethernet PHY instance

**Param addr [out]** PHY chip address

**Return**

- ESP\_OK: get Ethernet PHY address successfully
- ESP\_ERR\_INVALID\_ARG: get Ethernet PHY address failed because of invalid argument

*esp\_err\_t* (\***advertise\_pause\_ability**)(*esp\_eth\_phy\_t* \*phy, uint32\_t ability)

Advertise pause function supported by MAC layer.

**Param phy [in]** Ethernet PHY instance

**Param addr [out]** Pause ability

**Return**

- ESP\_OK: Advertise pause ability successfully
- ESP\_ERR\_INVALID\_ARG: Advertise pause ability failed because of invalid argument

*esp\_err\_t* (\***loopback**)(*esp\_eth\_phy\_t* \*phy, bool enable)

Sets the PHY to loopback mode.

**Param phy [in]** Ethernet PHY instance  
**Param enable [in]** enables or disables PHY loopback

**Return**

- ESP\_OK: PHY instance loopback mode has been configured successfully
- ESP\_FAIL: PHY instance loopback configuration failed because some error occurred

*esp\_err\_t* (\***set\_speed**)(*esp\_eth\_phy\_t* \*phy, *eth\_speed\_t* speed)

Sets PHY speed mode.

---

**备注:** Autonegotiation feature needs to be disabled prior to calling this function for the new setting to be applied

---

**Param phy [in]** Ethernet PHY instance  
**Param speed [in]** Speed mode to be set

**Return**

- ESP\_OK: PHY instance speed mode has been configured successfully
- ESP\_FAIL: PHY instance speed mode configuration failed because some error occurred

*esp\_err\_t* (\***set\_duplex**)(*esp\_eth\_phy\_t* \*phy, *eth\_duplex\_t* duplex)

Sets PHY duplex mode.

---

**备注:** Autonegotiation feature needs to be disabled prior to calling this function for the new setting to be applied

---

**Param phy [in]** Ethernet PHY instance  
**Param duplex [in]** Duplex mode to be set

**Return**

- ESP\_OK: PHY instance duplex mode has been configured successfully
- ESP\_FAIL: PHY instance duplex mode configuration failed because some error occurred

*esp\_err\_t* (\***custom\_ioctl**)(*esp\_eth\_phy\_t* \*phy, int cmd, void \*data)

Custom IO function of PHY driver. This function is intended to extend common options of *esp\_eth\_ioctl* to cover specifics of PHY chip.

---

**备注:** This function may not be assigned when the PHY chip supports only most common set of configuration options.

---

**Param phy [in]** Ethernet PHY instance  
**Param cmd [in]** IO control command  
**Param data [inout]** address of data for *set* command or address where to store the data when used with *get* command

**Return**

- ESP\_OK: process io command successfully
- ESP\_ERR\_INVALID\_ARG: process io command failed because of some invalid argument
- ESP\_FAIL: process io command failed because some other error occurred
- ESP\_ERR\_NOT\_SUPPORTED: requested feature is not supported

`esp_err_t (*del)(esp_eth_phy_t *phy)`

Free memory of Ethernet PHY instance.

**Param phy [in]** Ethernet PHY instance

**Return**

- ESP\_OK: free PHY instance successfully
- ESP\_FAIL: free PHY instance failed because some error occurred

struct **eth\_phy\_config\_t**

Ethernet PHY configuration.

### Public Members

int32\_t **phy\_addr**

PHY address, set -1 to enable PHY address detection at initialization stage

uint32\_t **reset\_timeout\_ms**

Reset timeout value (Unit: ms)

uint32\_t **autonego\_timeout\_ms**

Auto-negotiation timeout value (Unit: ms)

int **reset\_gpio\_num**

Reset GPIO number, -1 means no hardware reset

### Macros

**ESP\_ETH\_PHY\_ADDR\_AUTO**

**ETH\_PHY\_DEFAULT\_CONFIG ()**

Default configuration for Ethernet PHY object.

### Type Definitions

typedef struct *esp\_eth\_phy\_s* **esp\_eth\_phy\_t**

Ethernet PHY.

### Enumerations

enum **eth\_phy\_autoneg\_cmd\_t**

Auto-negotiation control commands.

*Values:*

enumerator **ESP\_ETH\_PHY\_AUTONEGO\_RESTART**

enumerator **ESP\_ETH\_PHY\_AUTONEGO\_EN**

enumerator **ESP\_ETH\_PHY\_AUTONEGO\_DIS**

enumerator **ESP\_ETH\_PHY\_AUTONEGO\_G\_STAT**

## Header File

- `components/esp_eth/include/esp_eth_phy_802_3.h`
- This header file can be included with:

```
#include "esp_eth_phy_802_3.h"
```

- This header file is a part of the API provided by the `esp_eth` component. To declare that your component depends on `esp_eth`, add the following to your `CMakeLists.txt`:

```
REQUIRES esp_eth
```

or

```
PRIV_REQUIRES esp_eth
```

## Functions

`esp_err_t esp_eth_phy_802_3_set_mediator` (`phy_802_3_t *phy_802_3`, `esp_eth_mediator_t *eth`)

Set Ethernet mediator.

### 参数

- `phy_802_3` -- IEEE 802.3 PHY object infostructure
- `eth` -- Ethernet mediator pointer

### 返回

- `ESP_OK`: Ethernet mediator set successfully
- `ESP_ERR_INVALID_ARG`: if `eth` is `NULL`

`esp_err_t esp_eth_phy_802_3_reset` (`phy_802_3_t *phy_802_3`)

Reset PHY.

参数 `phy_802_3` -- IEEE 802.3 PHY object infostructure

### 返回

- `ESP_OK`: Ethernet PHY reset successfully
- `ESP_FAIL`: reset Ethernet PHY failed because some error occurred

`esp_err_t esp_eth_phy_802_3_autonego_ctrl` (`phy_802_3_t *phy_802_3`, `eth_phy_autonego_cmd_t cmd`, `bool *autonego_en_stat`)

Control autonegotiation mode of Ethernet PHY.

### 参数

- `phy_802_3` -- IEEE 802.3 PHY object infostructure
- `cmd` -- autonegotiation command enumeration
- `autonego_en_stat` -- [out] autonegotiation enabled flag

### 返回

- `ESP_OK`: Ethernet PHY autonegotiation configured successfully
- `ESP_FAIL`: Ethernet PHY autonegotiation configuration fail because some error occurred
- `ESP_ERR_INVALID_ARG`: invalid value of `cmd`

`esp_err_t esp_eth_phy_802_3_pwrctl` (`phy_802_3_t *phy_802_3`, `bool enable`)

Power control of Ethernet PHY.

### 参数

- `phy_802_3` -- IEEE 802.3 PHY object infostructure
- `enable` -- set true to power ON Ethernet PHY; set false to power OFF Ethernet PHY

### 返回

- `ESP_OK`: Ethernet PHY power down mode set successfully
- `ESP_FAIL`: Ethernet PHY power up or power down failed because some error occurred

`esp_err_t esp_eth_phy_802_3_set_addr` (`phy_802_3_t *phy_802_3`, `uint32_t addr`)

Set Ethernet PHY address.

### 参数

- `phy_802_3` -- IEEE 802.3 PHY object infostructure

- **addr** -- new PHY address
- 返回
- ESP\_OK: Ethernet PHY address set

*esp\_err\_t* **esp\_eth\_phy\_802\_3\_get\_addr** (*phy\_802\_3\_t* \*phy\_802\_3, uint32\_t \*addr)

Get Ethernet PHY address.

#### 参数

- **phy\_802\_3** -- IEEE 802.3 PHY object infostructure
- **addr** -- [out] Ethernet PHY address

#### 返回

- ESP\_OK: Ethernet PHY address read successfully
- ESP\_ERR\_INVALID\_ARG: addr pointer is NULL

*esp\_err\_t* **esp\_eth\_phy\_802\_3\_advertise\_pause\_ability** (*phy\_802\_3\_t* \*phy\_802\_3, uint32\_t ability)

Advertise pause function ability.

#### 参数

- **phy\_802\_3** -- IEEE 802.3 PHY object infostructure
- **ability** -- enable or disable pause ability

#### 返回

- ESP\_OK: pause ability set successfully
- ESP\_FAIL: Advertise pause function ability failed because some error occurred

*esp\_err\_t* **esp\_eth\_phy\_802\_3\_loopback** (*phy\_802\_3\_t* \*phy\_802\_3, bool enable)

Set Ethernet PHY loopback mode.

#### 参数

- **phy\_802\_3** -- IEEE 802.3 PHY object infostructure
- **enable** -- set true to enable loopback; set false to disable loopback

#### 返回

- ESP\_OK: Ethernet PHY loopback mode set successfully
- ESP\_FAIL: Ethernet PHY loopback configuration failed because some error occurred

*esp\_err\_t* **esp\_eth\_phy\_802\_3\_set\_speed** (*phy\_802\_3\_t* \*phy\_802\_3, *eth\_speed\_t* speed)

Set Ethernet PHY speed.

#### 参数

- **phy\_802\_3** -- IEEE 802.3 PHY object infostructure
- **speed** -- new speed of Ethernet PHY link

#### 返回

- ESP\_OK: Ethernet PHY speed set successfully
- ESP\_FAIL: Set Ethernet PHY speed failed because some error occurred

*esp\_err\_t* **esp\_eth\_phy\_802\_3\_set\_duplex** (*phy\_802\_3\_t* \*phy\_802\_3, *eth\_duplex\_t* duplex)

Set Ethernet PHY duplex mode.

#### 参数

- **phy\_802\_3** -- IEEE 802.3 PHY object infostructure
- **duplex** -- new duplex mode for Ethernet PHY link

#### 返回

- ESP\_OK: Ethernet PHY duplex mode set successfully
- ESP\_ERR\_INVALID\_STATE: unable to set duplex mode to Half if loopback is enabled
- ESP\_FAIL: Set Ethernet PHY duplex mode failed because some error occurred

*esp\_err\_t* **esp\_eth\_phy\_802\_3\_set\_link** (*phy\_802\_3\_t* \*phy\_802\_3, *eth\_link\_t* link)

Set Ethernet PHY link status.

#### 参数

- **phy\_802\_3** -- IEEE 802.3 PHY object infostructure
- **link** -- new link status

#### 返回

- ESP\_OK: Ethernet PHY link set successfully

*esp\_err\_t* **esp\_eth\_phy\_802\_3\_init** (*phy\_802\_3\_t* \*phy\_802\_3)

Initialize Ethernet PHY.

**参数** **phy\_802\_3** -- IEEE 802.3 PHY object infostructure  
**返回**

- ESP\_OK: Ethernet PHY initialized successfully

*esp\_err\_t* **esp\_eth\_phy\_802\_3\_deinit** (*phy\_802\_3\_t* \*phy\_802\_3)

Power off Ethernet PHY.

**参数** **phy\_802\_3** -- IEEE 802.3 PHY object infostructure  
**返回**

- ESP\_OK: Ethernet PHY powered off successfully

*esp\_err\_t* **esp\_eth\_phy\_802\_3\_del** (*phy\_802\_3\_t* \*phy\_802\_3)

Delete Ethernet PHY infostructure.

**参数** **phy\_802\_3** -- IEEE 802.3 PHY object infostructure  
**返回**

- ESP\_OK: Ethernet PHY infostructure deleted

*esp\_err\_t* **esp\_eth\_phy\_802\_3\_reset\_hw** (*phy\_802\_3\_t* \*phy\_802\_3, uint32\_t reset\_assert\_us)

Performs hardware reset with specific reset pin assertion time.

**参数**

- **phy\_802\_3** -- IEEE 802.3 PHY object infostructure
- **reset\_assert\_us** -- Hardware reset pin assertion time

**返回**

- ESP\_OK: reset Ethernet PHY successfully

*esp\_err\_t* **esp\_eth\_phy\_802\_3\_detect\_phy\_addr** (*esp\_eth\_mediator\_t* \*eth, int \*detected\_addr)

Detect PHY address.

**参数**

- **eth** -- Mediator of Ethernet driver
- **detected\_addr** -- [out] a valid address after detection

**返回**

- ESP\_OK: detect phy address successfully
- ESP\_ERR\_INVALID\_ARG: invalid parameter
- ESP\_ERR\_NOT\_FOUND: can't detect any PHY device
- ESP\_FAIL: detect phy address failed because some error occurred

*esp\_err\_t* **esp\_eth\_phy\_802\_3\_basic\_phy\_init** (*phy\_802\_3\_t* \*phy\_802\_3)

Performs basic PHY chip initialization.

---

**备注:** It should be called as the first function in PHY specific driver instance

---

**参数** **phy\_802\_3** -- IEEE 802.3 PHY object infostructure  
**返回**

- ESP\_OK: initialized Ethernet PHY successfully
- ESP\_FAIL: initialization of Ethernet PHY failed because some error occurred
- ESP\_ERR\_INVALID\_ARG: invalid argument
- ESP\_ERR\_NOT\_FOUND: PHY device not detected
- ESP\_ERR\_TIMEOUT: MII Management read/write operation timeout
- ESP\_ERR\_INVALID\_STATE: PHY is in invalid state to perform requested operation

*esp\_err\_t* **esp\_eth\_phy\_802\_3\_basic\_phy\_deinit** (*phy\_802\_3\_t* \*phy\_802\_3)

Performs basic PHY chip de-initialization.

---

**备注:** It should be called as the last function in PHY specific driver instance

---

**参数** **phy\_802\_3** -- IEEE 802.3 PHY object infostructure

**返回**

- **ESP\_OK**: de-initialized Ethernet PHY successfully
- **ESP\_FAIL**: de-initialization of Ethernet PHY failed because some error occurred
- **ESP\_ERR\_TIMEOUT**: MII Management read/write operation timeout
- **ESP\_ERR\_INVALID\_STATE**: PHY is in invalid state to perform requested operation

*esp\_err\_t* **esp\_eth\_phy\_802\_3\_read\_oui** (*phy\_802\_3\_t* \*phy\_802\_3, *uint32\_t* \*oui)

Reads raw content of OUI field.

**参数**

- **phy\_802\_3** -- IEEE 802.3 PHY object infostructure
- **oui** -- **[out]** OUI value

**返回**

- **ESP\_OK**: OUI field read successfully
- **ESP\_FAIL**: OUI field read failed because some error occurred
- **ESP\_ERR\_INVALID\_ARG**: invalid `oui` argument
- **ESP\_ERR\_TIMEOUT**: MII Management read/write operation timeout
- **ESP\_ERR\_INVALID\_STATE**: PHY is in invalid state to perform requested operation

*esp\_err\_t* **esp\_eth\_phy\_802\_3\_read\_manufac\_info** (*phy\_802\_3\_t* \*phy\_802\_3, *uint8\_t* \*model, *uint8\_t* \*rev)

Reads manufacturer's model and revision number.

**参数**

- **phy\_802\_3** -- IEEE 802.3 PHY object infostructure
- **model** -- **[out]** Manufacturer's model number (can be NULL when not required)
- **rev** -- **[out]** Manufacturer's revision number (can be NULL when not required)

**返回**

- **ESP\_OK**: Manufacturer's info read successfully
- **ESP\_FAIL**: Manufacturer's info read failed because some error occurred
- **ESP\_ERR\_TIMEOUT**: MII Management read/write operation timeout
- **ESP\_ERR\_INVALID\_STATE**: PHY is in invalid state to perform requested operation

*esp\_err\_t* **esp\_eth\_phy\_802\_3\_get\_mmd\_addr** (*phy\_802\_3\_t* \*phy\_802\_3, *uint8\_t* devaddr, *uint16\_t* \*mmd\_addr)

Reads MDIO device's internal address register.

**参数**

- **phy\_802\_3** -- IEEE 802.3 PHY object infostructure
- **devaddr** -- Address of MDIO device
- **mmd\_addr** -- **[out]** Current address stored in device's register

**返回**

- **ESP\_OK**: Address register read successfully
- **ESP\_FAIL**: Address register read failed because of some error occurred
- **ESP\_ERR\_INVALID\_ARG**: Device address provided is out of range (hardware limits device address to 5 bits)

*esp\_err\_t* **esp\_eth\_phy\_802\_3\_set\_mmd\_addr** (*phy\_802\_3\_t* \*phy\_802\_3, *uint8\_t* devaddr, *uint16\_t* mmd\_addr)

Write to DIO device's internal address register.

**参数**

- **phy\_802\_3** -- IEEE 802.3 PHY object infostructure



- **devaddr** -- Address of MDIO device
- **mmd\_addr** -- [out] New value of MDIO device's address register value

**返回**

- ESP\_OK: Address register written to successfully
- ESP\_FAIL: Address register write failed because of some error occurred
- ESP\_ERR\_INVALID\_ARG: Device address provided is out of range (hardware limits device address to 5 bits)

*esp\_err\_t* **esp\_eth\_phy\_802\_3\_read\_mmd\_data** (*phy\_802\_3\_t* \*phy\_802\_3, uint8\_t devaddr, *esp\_eth\_phy\_802\_3\_mmd\_func\_t* function, uint32\_t \*data)

Read data of MDIO device's memory at address register.

**参数**

- **phy\_802\_3** -- IEEE 802.3 PHY object infostructure
- **devaddr** -- Address of MDIO device
- **function** -- MMD function
- **data** -- [out] Data read from the device's memory

**返回**

- ESP\_OK: Memory read successfully
- ESP\_FAIL: Memory read failed because of some error occurred
- ESP\_ERR\_INVALID\_ARG: Device address provided is out of range (hardware limits device address to 5 bits) or MMD access function is invalid

*esp\_err\_t* **esp\_eth\_phy\_802\_3\_write\_mmd\_data** (*phy\_802\_3\_t* \*phy\_802\_3, uint8\_t devaddr, *esp\_eth\_phy\_802\_3\_mmd\_func\_t* function, uint32\_t data)

Write data to MDIO device's memory at address register.

**参数**

- **phy\_802\_3** -- IEEE 802.3 PHY object infostructure
- **devaddr** -- Address of MDIO device
- **function** -- MMD function
- **data** -- [out] Data to write to the device's memory

**返回**

- ESP\_OK: Memory written successfully
- ESP\_FAIL: Memory write failed because of some error occurred
- ESP\_ERR\_INVALID\_ARG: Device address provided is out of range (hardware limits device address to 5 bits) or MMD access function is invalid

*esp\_err\_t* **esp\_eth\_phy\_802\_3\_read\_mmd\_register** (*phy\_802\_3\_t* \*phy\_802\_3, uint8\_t devaddr, uint16\_t mmd\_addr, uint32\_t \*data)

Set MMD address to mmd\_addr with function MMD\_FUNC\_NOINCR and read contents to \*data.

**参数**

- **phy\_802\_3** -- IEEE 802.3 PHY object infostructure
- **devaddr** -- Address of MDIO device
- **mmd\_addr** -- Address of MDIO device register
- **data** -- [out] Data read from the device's memory

**返回**

- ESP\_OK: Memory read successfully
- ESP\_FAIL: Memory read failed because of some error occurred
- ESP\_ERR\_INVALID\_ARG: Device address provided is out of range (hardware limits device address to 5 bits)

*esp\_err\_t* **esp\_eth\_phy\_802\_3\_write\_mmd\_register** (*phy\_802\_3\_t* \*phy\_802\_3, uint8\_t devaddr, uint16\_t mmd\_addr, uint32\_t data)

Set MMD address to mmd\_addr with function MMD\_FUNC\_NOINCR and write data.

**参数**

- **phy\_802\_3** -- IEEE 802.3 PHY object infostructure

- **devaddr** -- Address of MDIO device
- **mmd\_addr** -- Address of MDIO device register
- **data** -- [out] Data to write to the device's memory

**返回**

- ESP\_OK: Memory written to successfully
- ESP\_FAIL: Memory write failed because of some error occurred
- ESP\_ERR\_INVALID\_ARG: Device address provided is out of range (hardware limits device address to 5 bits)

inline *phy\_802\_3\_t* \***esp\_eth\_phy\_into\_phy\_802\_3** (*esp\_eth\_phy\_t* \*phy)

Returns address to parent IEEE 802.3 PHY object infostructure.

**参数** *phy* -- Ethernet PHY instance

**返回** *phy\_802\_3\_t*\*

- address to parent IEEE 802.3 PHY object infostructure

*esp\_err\_t* **esp\_eth\_phy\_802\_3\_obj\_config\_init** (*phy\_802\_3\_t* \*phy\_802\_3, const *eth\_phy\_config\_t* \*config)

Initializes configuration of parent IEEE 802.3 PHY object infostructure.

**参数**

- **phy\_802\_3** -- Address to IEEE 802.3 PHY object infostructure
- **config** -- Configuration of the IEEE 802.3 PHY object

**返回**

- ESP\_OK: configuration initialized successfully
- ESP\_ERR\_INVALID\_ARG: invalid `config` argument

**Structures**

struct **phy\_802\_3\_t**

IEEE 802.3 PHY object infostructure.

**Public Members**

*esp\_eth\_phy\_t* **parent**

Parent Ethernet PHY instance

*esp\_eth\_mediator\_t* \***eth**

Mediator of Ethernet driver

int **addr**

PHY address

uint32\_t **reset\_timeout\_ms**

Reset timeout value (Unit: ms)

uint32\_t **autonego\_timeout\_ms**

Auto-negotiation timeout value (Unit: ms)

*eth\_link\_t* **link\_status**

Current Link status

int **reset\_gpio\_num**

Reset GPIO number, -1 means no hardware reset

## Enumerations

enum **esp\_eth\_phy\_802\_3\_mmd\_func\_t**

IEEE 802.3 MMD modes enumeration.

*Values:*

enumerator **MMD\_FUNC\_ADDRESS**

enumerator **MMD\_FUNC\_DATA\_NOINCR**

enumerator **MMD\_FUNC\_DATA\_RWINCR**

enumerator **MMD\_FUNC\_DATA\_WINCR**

## Header File

- [components/esp\\_eth/include/esp\\_eth\\_netif\\_glue.h](#)
- This header file can be included with:

```
#include "esp_eth_netif_glue.h"
```

- This header file is a part of the API provided by the `esp_eth` component. To declare that your component depends on `esp_eth`, add the following to your `CMakeLists.txt`:

```
REQUIRES esp_eth
```

or

```
PRIV_REQUIRES esp_eth
```

## Functions

*esp\_eth\_netif\_glue\_handle\_t* **esp\_eth\_new\_netif\_glue** (*esp\_eth\_handle\_t* eth\_hdl)

Create a netif glue for Ethernet driver.

---

**备注:** netif glue is used to attach io driver to TCP/IP netif

---

**参数** `eth_hdl` -- Ethernet driver handle

**返回** glue object, which inherits `esp_netif_driver_base_t`

*esp\_err\_t* **esp\_eth\_del\_netif\_glue** (*esp\_eth\_netif\_glue\_handle\_t* eth\_netif\_glue)

Delete netif glue of Ethernet driver.

**参数** `eth_netif_glue` -- netif glue

**返回** `-ESP_OK`: delete netif glue successfully

## Type Definitions

typedef struct esp\_eth\_netif\_glue\_t \***esp\_eth\_netif\_glue\_handle\_t**

Handle of netif glue - an intermediate layer between netif and Ethernet driver.  
本部分的以太网 API 示例代码存放在 ESP-IDF 示例项目的 [ethernet](#) 目录下。

## 2.5.2 Thread

### Thread

**概述** Thread 是一个基于 IP 的网状网络协议，它基于 802.15.4 物理层和 MAC 层。

**应用示例** ESP-IDF 示例目录 `openthread` 包含以下应用程序：

- OpenThread 交互 shell: `openthread/ot_cli`
- 边界路由器 (Thread Border Router): `openthread/ot_br`
- Thread 无线电协处理器 (Thread Radio Co-Processor): `openthread/ot_rcp`

**API 参考** 应使用 OpenThread API 操作 Thread 网络。请参考 [OpenThread API 文档](#)。

ESP-IDF 提供额外的 API，用于启动和管理 OpenThread 实现执行网络接口绑定和边界路由功能。

### Header File

- `components/openthread/include/esp_openthread.h`
- This header file can be included with:

```
#include "esp_openthread.h"
```

- This header file is a part of the API provided by the `openthread` component. To declare that your component depends on `openthread`, add the following to your `CMakeLists.txt`:

```
REQUIRES openthread
```

or

```
PRIV_REQUIRES openthread
```

### Functions

`esp_err_t esp_openthread_init` (const `esp_openthread_platform_config_t` \*init\_config)

Initializes the full OpenThread stack.

---

**备注:** The OpenThread instance will also be initialized in this function.

---

**参数** `init_config` -- **[in]** The initialization configuration.

**返回**

- ESP\_OK on success
- ESP\_ERR\_NO\_MEM if allocation has failed
- ESP\_ERR\_INVALID\_ARG if radio or host connection mode not supported
- ESP\_ERR\_INVALID\_STATE if already initialized

`esp_err_t esp_openthread_auto_start` (otOperationalDatasetTlvs \*datasetTlvs)

Starts the Thread protocol operation and attaches to a Thread network.

**参数** `datasetTlvs` -- **[in]** The operational dataset (TLV encoded), if it's NULL, the function will generate the dataset based on the configurations from `kconfig`.

**返回**

- ESP\_OK on success
- ESP\_FAIL on failures

*esp\_err\_t* **esp\_openthread\_launch\_mainloop** (void)

Launches the OpenThread main loop.

---

**备注:** This function will not return unless error happens when running the OpenThread stack.

---

**返回**

- ESP\_OK on success
- ESP\_ERR\_NO\_MEM if allocation has failed
- ESP\_FAIL on other failures

*esp\_err\_t* **esp\_openthread\_deinit** (void)

This function performs OpenThread stack and platform driver deinitialization.

**返回**

- ESP\_OK on success
- ESP\_ERR\_INVALID\_STATE if not initialized

otInstance \***esp\_openthread\_get\_instance** (void)

This function acquires the underlying OpenThread instance.

---

**备注:** This function can be called on other tasks without lock.

---

**返回** The OpenThread instance pointer

## Header File

- [components/openthread/include/esp\\_openthread\\_types.h](#)
- This header file can be included with:

```
#include "esp_openthread_types.h"
```

- This header file is a part of the API provided by the `openthread` component. To declare that your component depends on `openthread`, add the following to your `CMakeLists.txt`:

```
REQUIRES openthread
```

or

```
PRIV_REQUIRES openthread
```

## Structures

struct **esp\_openthread\_role\_changed\_event\_t**

OpenThread role changed event data.

## Public Members

otDeviceRole **previous\_role**

Previous Thread role

otDeviceRole **current\_role**

Current Thread role

struct **esp\_openthread\_mainloop\_context\_t**

This structure represents a context for a select() based mainloop.

### Public Members

fd\_set **read\_fds**

The read file descriptors

fd\_set **write\_fds**

The write file descriptors

fd\_set **error\_fds**

The error file descriptors

int **max\_fd**

The max file descriptor

struct timeval **timeout**

The timeout

struct **esp\_openthread\_uart\_config\_t**

The uart port config for OpenThread.

### Public Members

*uart\_port\_t* **port**

UART port number

*uart\_config\_t* **uart\_config**

UART configuration, see [uart\\_config\\_t](#) docs

gpio\_num\_t **rx\_pin**

UART RX pin

gpio\_num\_t **tx\_pin**

UART TX pin

struct **esp\_openthread\_spi\_host\_config\_t**

The spi port config for OpenThread.

### Public Members

*spi\_host\_device\_t* **host\_device**

SPI host device

*spi\_dma\_chan\_t* **dma\_channel**

DMA channel

*spi\_bus\_config\_t* **spi\_interface**

SPI bus

*spi\_device\_interface\_config\_t* **spi\_device**

SPI peripheral device

gpio\_num\_t **intr\_pin**

SPI interrupt pin

struct **esp\_openthread\_spi\_slave\_config\_t**

The spi slave config for OpenThread.

### Public Members

*spi\_host\_device\_t* **host\_device**

SPI host device

*spi\_bus\_config\_t* **bus\_config**

SPI bus config

*spi\_slave\_interface\_config\_t* **slave\_config**

SPI slave config

gpio\_num\_t **intr\_pin**

SPI interrupt pin

struct **esp\_openthread\_radio\_config\_t**

The OpenThread radio configuration.

### Public Members

*esp\_openthread\_radio\_mode\_t* **radio\_mode**

The radio mode

*esp\_openthread\_uart\_config\_t* **radio\_uart\_config**

The uart configuration to RCP

*esp\_openthread\_spi\_host\_config\_t* **radio\_spi\_config**

The spi configuration to RCP

struct **esp\_openthread\_host\_connection\_config\_t**

The OpenThread host connection configuration.

### Public Members

*esp\_openthread\_host\_connection\_mode\_t* **host\_connection\_mode**

The host connection mode

*esp\_openthread\_uart\_config\_t* **host\_uart\_config**

The uart configuration to host

*usb\_serial\_jtag\_driver\_config\_t* **host\_usb\_config**

The usb configuration to host

*esp\_openthread\_spi\_slave\_config\_t* **spi\_slave\_config**

The spi configuration to host

struct **esp\_openthread\_port\_config\_t**

The OpenThread port specific configuration.

### Public Members

const char \***storage\_partition\_name**

The partition for storing OpenThread dataset

uint8\_t **netif\_queue\_size**

The packet queue size for the network interface

uint8\_t **task\_queue\_size**

The task queue size

struct **esp\_openthread\_platform\_config\_t**

The OpenThread platform configuration.

### Public Members

*esp\_openthread\_radio\_config\_t* **radio\_config**

The radio configuration

*esp\_openthread\_host\_connection\_config\_t* **host\_config**

The host connection configuration

*esp\_openthread\_port\_config\_t* **port\_config**

The port configuration

### Type Definitions

typedef void (\***esp\_openthread\_rcp\_failure\_handler**)(void)



## Enumerations

enum **esp\_openthread\_event\_t**

OpenThread event declarations.

*Values:*

enumerator **OPENTHREAD\_EVENT\_START**

OpenThread stack start

enumerator **OPENTHREAD\_EVENT\_STOP**

OpenThread stack stop

enumerator **OPENTHREAD\_EVENT\_DETACHED**

OpenThread detached

enumerator **OPENTHREAD\_EVENT\_ATTACHED**

OpenThread attached

enumerator **OPENTHREAD\_EVENT\_ROLE\_CHANGED**

OpenThread role changed

enumerator **OPENTHREAD\_EVENT\_IF\_UP**

OpenThread network interface up

enumerator **OPENTHREAD\_EVENT\_IF\_DOWN**

OpenThread network interface down

enumerator **OPENTHREAD\_EVENT\_GOT\_IP6**

OpenThread stack added IPv6 address

enumerator **OPENTHREAD\_EVENT\_LOST\_IP6**

OpenThread stack removed IPv6 address

enumerator **OPENTHREAD\_EVENT\_MULTICAST\_GROUP\_JOIN**

OpenThread stack joined IPv6 multicast group

enumerator **OPENTHREAD\_EVENT\_MULTICAST\_GROUP\_LEAVE**

OpenThread stack left IPv6 multicast group

enumerator **OPENTHREAD\_EVENT\_TREL\_ADD\_IP6**

OpenThread stack added TREL IPv6 address

enumerator **OPENTHREAD\_EVENT\_TREL\_REMOVE\_IP6**

OpenThread stack removed TREL IPv6 address

enumerator **OPENTHREAD\_EVENT\_TREL\_MULTICAST\_GROUP\_JOIN**

OpenThread stack joined TREL IPv6 multicast group

enumerator **OPENTHREAD\_EVENT\_SET\_DNS\_SERVER**

OpenThread stack set DNS server >

enumerator **OPENTHREAD\_EVENT\_PUBLISH\_MESHCOPE**

OpenThread stack start to publish meshcop-e service >

enumerator **OPENTHREAD\_EVENT\_REMOVE\_MESHCOPE**

OpenThread stack start to remove meshcop-e service >

enum **esp\_openthread\_radio\_mode\_t**

The radio mode of OpenThread.

*Values:*

enumerator **RADIO\_MODE\_NATIVE**

Use the native 15.4 radio

enumerator **RADIO\_MODE\_UART\_RCP**

UART connection to a 15.4 capable radio co-processor (RCP)

enumerator **RADIO\_MODE\_SPI\_RCP**

SPI connection to a 15.4 capable radio co-processor (RCP)

enumerator **RADIO\_MODE\_MAX**

Using for parameter check

enum **esp\_openthread\_host\_connection\_mode\_t**

How OpenThread connects to the host.

*Values:*

enumerator **HOST\_CONNECTION\_MODE\_NONE**

Disable host connection

enumerator **HOST\_CONNECTION\_MODE\_CLI\_UART**

CLI UART connection to the host

enumerator **HOST\_CONNECTION\_MODE\_CLI\_USB**

CLI USB connection to the host

enumerator **HOST\_CONNECTION\_MODE\_RCP\_UART**

RCP UART connection to the host

enumerator **HOST\_CONNECTION\_MODE\_RCP\_SPI**

RCP SPI connection to the host

enumerator **HOST\_CONNECTION\_MODE\_MAX**

Using for parameter check

### Header File

- [components/openthread/include/esp\\_openthread\\_lock.h](#)
- This header file can be included with:

```
#include "esp_openthread_lock.h"
```

- This header file is a part of the API provided by the `openthread` component. To declare that your component depends on `openthread`, add the following to your `CMakeLists.txt`:

```
REQUIRES openthread
```

or

```
PRIV_REQUIRES openthread
```

## Functions

*esp\_err\_t* **esp\_openthread\_lock\_init** (void)

This function initializes the OpenThread API lock.

返回

- `ESP_OK` on success
- `ESP_ERR_NO_MEM` if allocation has failed
- `ESP_ERR_INVALID_STATE` if already initialized

void **esp\_openthread\_lock\_deinit** (void)

This function deinitializes the OpenThread API lock.

bool **esp\_openthread\_lock\_acquire** (TickType\_t block\_ticks)

This function acquires the OpenThread API lock.

---

**备注:** Every OpenThread APIs that takes an `otInstance` argument MUST be protected with this API lock except that the call site is in OpenThread callbacks.

---

**参数** `block_ticks` -- [in] The maximum number of RTOS ticks to wait for the lock.

返回

- True on lock acquired
- False on failing to acquire the lock with the timeout.

void **esp\_openthread\_lock\_release** (void)

This function releases the OpenThread API lock.

bool **esp\_openthread\_task\_switching\_lock\_acquire** (TickType\_t block\_ticks)

This function acquires the OpenThread API task switching lock.

---

**备注:** In OpenThread API context, it waits for some actions to be done in other tasks (like lwip), after task switching, it needs to call OpenThread API again. Normally it's not allowed, since the previous OpenThread API lock is not released yet. This task\_switching lock allows the OpenThread API can be called in this case.

---



---

**备注:** Please use `esp_openthread_lock_acquire()` for normal cases.

---

**参数** `block_ticks` -- [in] The maximum number of RTOS ticks to wait for the lock.

返回

- True on lock acquired
- False on failing to acquire the lock with the timeout.

void **esp\_openthread\_task\_switching\_lock\_release** (void)

This function releases the OpenThread API task switching lock.

---

**备注:** This API must be called after `esp_openthread_task_switching_lock_acquire` or `esp_openthread_lock_acquire` and will cause a crash if the current task is not the task switching lock holder. This error could be caused by calling OpenThread APIs without locking OpenThread stack.

---

### Header File

- `components/openthread/include/esp_openthread_netif_glue.h`
- This header file can be included with:

```
#include "esp_openthread_netif_glue.h"
```

- This header file is a part of the API provided by the `openthread` component. To declare that your component depends on `openthread`, add the following to your `CMakeLists.txt`:

```
REQUIRES openthread
```

or

```
PRIV_REQUIRES openthread
```

### Functions

void `*esp_openthread_netif_glue_init` (const `esp_openthread_platform_config_t` \*config)

This function initializes the OpenThread network interface glue.

**参数** `config` -- [in] The platform configuration.

**返回**

- glue pointer on success
- NULL on failure

void `esp_openthread_netif_glue_deinit` (void)

This function deinitializes the OpenThread network interface glue.

`esp_netif_t` \*`esp_openthread_get_netif` (void)

This function acquires the OpenThread netif.

**返回** The OpenThread netif or NULL if not initialized.

void `esp_openthread_register_meshcop_e_handler` (`esp_event_handler_t` handler, bool for\_publish)

This function register a handler for meshcop-e service publish event and remove event.

**参数**

- **handler** -- [in] The handler.
- **for\_publish** -- [in] The usage of handler, true for publish event and false for remove event.

### Macros

`ESP_NETIF_INHERENT_DEFAULT_OPENTHREAD` ()

Default configuration reference of OpenThread esp-netif.

`ESP_NETIF_DEFAULT_OPENTHREAD` ()

### Header File

- `components/openthread/include/esp_openthread_border_router.h`
- This header file can be included with:

```
#include "esp_openthread_border_router.h"
```

- This header file is a part of the API provided by the `openthread` component. To declare that your component depends on `openthread`, add the following to your `CMakeLists.txt`:

```
REQUIRES openthread
```

or

```
PRIV_REQUIRES openthread
```

## Functions

void **esp\_openthread\_set\_backbone\_netif** (*esp\_netif\_t* \*backbone\_netif)

Sets the backbone interface used for border routing.

---

**备注:** This function must be called before `esp_openthread_init`

---

**参数** `backbone_netif` -- [in] The backbone network interface (WiFi or ethernet)

*esp\_err\_t* **esp\_openthread\_border\_router\_init** (void)

Initializes the border router features of OpenThread.

---

**备注:** Calling this function will make the device behave as an OpenThread border router. Kconfig option `CONFIG_OPENTHREAD_BORDER_ROUTER` is required.

---

### 返回

- `ESP_OK` on success
- `ESP_ERR_NOT_SUPPORTED` if feature not supported
- `ESP_ERR_INVALID_STATE` if already initialized
- `ESP_FIAL` on other failures

*esp\_err\_t* **esp\_openthread\_border\_router\_deinit** (void)

Deinitializes the border router features of OpenThread.

### 返回

- `ESP_OK` on success
- `ESP_ERR_INVALID_STATE` if not initialized
- `ESP_FIAL` on other failures

*esp\_netif\_t* \***esp\_openthread\_get\_backbone\_netif** (void)

Gets the backbone interface of OpenThread border router.

**返回** The backbone interface or NULL if border router not initialized.

void **esp\_openthread\_register\_rcp\_failure\_handler** (*esp\_openthread\_rcp\_failure\_handler* handler)

Registers the callback for RCP failure.

*esp\_err\_t* **esp\_openthread\_rcp\_deinit** (void)

Deinitializes the connection to RCP.

### 返回

- `ESP_OK` on success
- `ESP_ERR_INVALID_STATE` if fail to deinitialize RCP

*esp\_err\_t* **esp\_openthread\_rcp\_init** (void)

Initializes the connection to RCP.

### 返回

- `ESP_OK` on success

- ESP\_FAIL if fail to initialize RCP

`esp_err_t esp_openthread_set_meshcop_instance_name` (const char \*instance\_name)

Sets the meshcop(e) instance name.

**备注:** This function can only be called before `esp_openthread_border_router_init`. If `instance_name` is NULL, then the service will use the `hostname` as instance name.

**参数** `instance_name` -- [in] The instance name, can be NULL.  
**返回**

- ESP\_OK on success
- ESP\_FAIL if fail to initialize RCP

Thread 是一种基于 IPv6 的物联网网状网络技术。

本部分的 Thread API 示例代码存放在 ESP-IDF 示例项目的 `openthread` 目录下。

### 2.5.3 ESP-NETIF

#### ESP-NETIF

ESP-NETIF 库的作用主要体现在以下两方面：

- 在 TCP/IP 协议栈之上为应用程序提供抽象层，允许应用程序在 IP 栈间选择。
- 在底层 TCP/IP 协议栈 API 非线程安全的情况下，也能提供线程安全的 API。

ESP-IDF 目前只为 lwIP TCP/IP 协议栈实现了 ESP-NETIF。然而，该适配器本身不依赖特定 TCP/IP 实现，因而支持不同实现方式。

ESP-IDF 支持实现了 BSD API 的自定义 TCP/IP 协议栈。有关不使用 lwIP 时构建 ESP-IDF 的详细信息，请参阅 [components/esp\\_netif\\_stack/README.md](#)。

部分 ESP-NETIF 的 API 函数可以被应用程序直接调用，如：获取或设置接口 IP 地址、配置 DHCP 等。其他 ESP-NETIF 的 API 函数则供网络驱动层在 ESP-IDF 内部调用。

应用程序通常无需直接调用 ESP-NETIF 的 API，它们会由默认网络事件句柄调用。

#### ESP-NETIF 架构

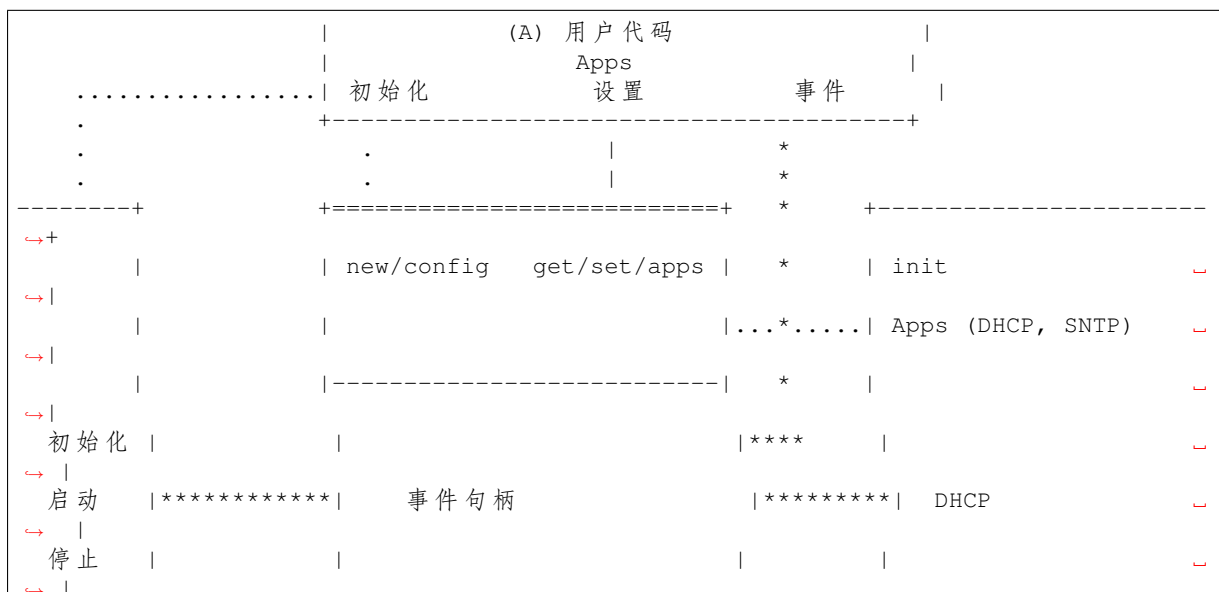

(下页继续)

(续上页)

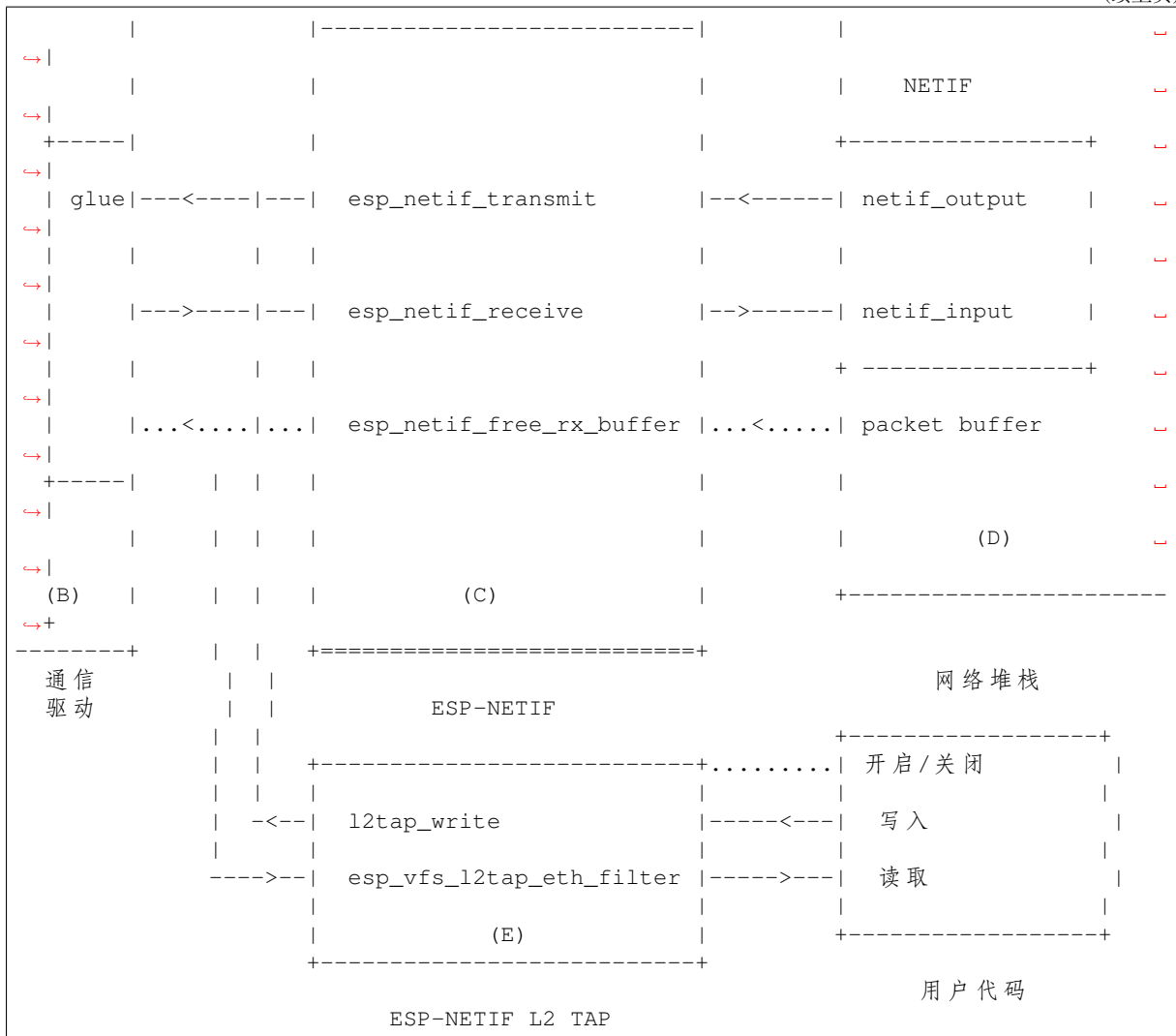

**图中不同线段对应的数据流和事件流**

- ..... 从用户代码到 ESP-NETIF 和通信驱动的初始化线。
- --<---->-- 数据包在通信媒介与 TCP/IP 协议栈之间往返。
- \*\*\*\*\* 聚集在 ESP-NETIF 中的事件传递到驱动程序、用户代码和网络堆栈中。
- | 用户设置及运行时间配置。

**ESP-NETIF 交互**

**A) 用户代码样板** 通过使用 ESP-NETIF API 抽象，应用程序与用于通信介质的特定 IO 驱动程序以及配置的 TCP/IP 网络栈之间的交互可以概括如下：

A) 初始化代码

- 1) 初始化 IO 驱动
- 2) 创建新的 ESP-NETIF 实例，并完成以下配置：
  - ESP-NETIF 的特定选项 (flags、行为、名称)
  - 网络栈堆选项 (netif init 和 input 函数，非公开信息)
  - IO 驱动的特定选项 (发送、释放 rx 缓冲区功能、IO 驱动句柄)
- 3) 将 IO 驱动句柄附加到上述步骤所创建的 ESP-NETIF 实例
- 4) 配置事件句柄

- 对 IO 驱动定义的公共接口使用默认句柄；或为定制的行为或新接口定义特定的句柄
- 为应用程序相关事件（如 IP 丢失或获取）注册句柄

#### B) 通过 ESP-NETIF API 与网络接口交互

- 1) 获取、设置 TCP/IP 相关参数（如 DHCP, IP 等）
- 2) 接收 IP 事件（连接或断连）
- 3) 控制应用程序生命周期（启用或禁用接口）

#### B) 通信驱动、IO 驱动和媒介驱动 对于 ESP-NETIF，通信驱动具有以下两个重要作用：

- 1) 事件句柄：定义与 ESP-NETIF 交互的行为模式（如：连接以太网 -> 开启 netif）
- 2) 胶合 IO 层：调整输入或输出函数以使用 ESP-NETIF 的传输、接收，并清空接收缓冲区
  - 给适当的 ESP-NETIF 对象安装 `driver_transmit`，以便将网络堆栈中传出的数据包传输给 IO 驱动
  - 调用函数 `esp_netif_receive()` 以便将传入的数据传输给网络堆栈

**C) ESP-NETIF** ESP-NETIF 是 IO 驱动和网络堆栈间的媒介，用于连通两者之间的数据包传输路径。它提供了一组接口，用于在运行时将驱动程序附加到 ESP-NETIF 对象并在编译期间配置网络堆栈。此外，ESP-NETIF 还提供了一组 API，用于控制网络接口的生命周期及其 TCP/IP 属性。ESP-NETIF 的公共接口大体上可以分为以下六组：

- 1) 初始化 API（用于创建并配置 ESP-NETIF 实例）
- 2) 输入或输出 API（用于在 IO 驱动和网络堆栈间传输数据）
- 3) 事件或行为 API
  - 管理网络接口生命周期
  - ESP-NETIF 为设计事件句柄提供了构建模块
- 4) 基本网络接口属性设置器和获取器 API
- 5) 网络堆栈抽象 API：实现用户与 TCP/IP 堆栈交互
  - 启用或禁用接口
  - DHCP 服务器和客户端 API
  - DNS API
  - [SNTP API](#)
- 6) 驱动转换工具 API

**D) 网络堆栈** 网络堆栈与应用程序代码在公共接口方面无公开交互，需通过 ESP-NETIF API 实现完全抽象。

**E) ESP-NETIF L2 TAP 接口** ESP-NETIF L2 TAP 接口是 ESP-IDF 访问用户应用程序中的数据链路层 (OSI/ISO 中的 L2) 以进行帧接收和传输的机制。在嵌入式开发中，它通常用于实现非 IP 相关协议，如 PTP 和 Wake on LAN 等。请注意，目前 ESP-NETIF L2 TAP 接口仅支持以太网 (IEEE 802.3)。

使用 VFS 的文件描述符访问 ESP-NETIF L2 TAP 接口，VFS 文件描述符会提供类似文件的接口（调用 `open()`、`read()`、`write()` 等函数访问），详情请参阅[虚拟文件系统组件](#)。

ESP-NETIF 只提供一个 L2 TAP 接口设备（路径名），但由于 ESP-NETIF L2 TAP 接口也可作为第二层基础设施的通用入口点，因此可以同时打开多个不同配置的文件描述符。特定文件描述符的具体配置很关键，它可以配置为仅允许访问由 `if_key`（如 `ETH_DEF`）标识的特定网络接口，并根据帧类型（如 IEEE 802.3 中的以太网类型）过滤特定帧。由于 ESP-NETIF L2 TAP 需要与 IP 堆栈同时存在，因此不应将 IP 相关流量（IP、ARP 等）直接传递给用户应用程序，此时则需要通过配置过滤特定帧实现这一点。在未过滤的情况下，即使该选项仍可配置，也不建议在标准用例中使用。过滤的另一优势在于，过滤后，用户应用程序只能访问它感兴趣的帧类型，其余的流量会传递到其他 L2 TAP 文件描述符或 IP 堆栈。

#### ESP-NETIF L2 TAP 接口使用手册



**初始化** 要使用 ESP-NETIF L2 TAP 接口，需要首先通过 Kconfig 配置 `CONFIG_ESP_NETIF_L2_TAP` 启用接口，随后通过 `esp_vfs_l2tap_intf_register()` 注册。请在完成上述步骤后再使用 VFS 函数。

**open()** ESP-NETIF L2 TAP 注册完成后，可使用路径名 `"/dev/net/tap"` 访问。同一路径名最多可以被打开 `CONFIG_ESP_NETIF_L2_TAP_MAX_FDS` 次，多个具有不同配置的文件描述符可以访问数据链路层的各个帧。

ESP-NETIF L2 TAP 可以使用 `O_NONBLOCK` 文件状态标志打开，确保 `read()` 不会阻塞。请注意，在当前实现中，当访问网络接口时，由于网络接口被多个 ESP-NETIF L2 TAP 文件描述符和 IP 栈共享，且缺乏排队机制，因此 `write()` 可能会受阻塞。使用 `fcntl()` 检索和修改文件状态标志。

成功时，`open()` 返回新的文件描述符（非负整数）。出错时，返回 `-1`，并设置 `errno` 以标识错误。

**ioctl()** 由于新打开的 ESP-NETIF L2 TAP 文件描述符尚未绑定任意网络接口或配置任意帧类型过滤器，使用前，用户需通过以下选项完成配置：

- `L2TAP_S_INTF_DEVICE` - 将文件描述符绑定到特定网络接口的选项，该网络接口由其 `if_key` 标识。ESP-NETIF 网络接口的 `if_key` 作为第三个参数传输给 `ioctl()`。ESP-IDF 中，默认网络接口 `if_key` 的使用存放在 `esp_netif/include/esp_netif_defaults.h` 头文件中。
- `L2TAP_S_DEVICE_DRV_HNDL` - 将文件描述符绑定到特定网络接口的另一选项。此时，网络接口直接由其 IO 驱动句柄（例如以太网中的 `esp_eth_handle_t`）标识。IO 驱动句柄将作为第三个参数传输给 `ioctl()`。
- `L2TAP_S_RCV_FILTER` - 设置过滤器，将特定类型的帧传递到文件描述符。在以太网中，帧是基于长度和以太网类型字段过滤的。如果过滤器值设置为小于或等于 `0x05DC`，则将以太网类型字段视作 IEEE802.3 长度字段，并将该字段中所有值在 `<0, 0x05DC>` 区间内的帧传递到文件描述符中。随后，由用户应用程序执行 IEEE802.2 逻辑链路控制 (LLC) 的解析。如果过滤器值设置为大于 `0x05DC`，则将以太网类型字段视为代表协议标识，仅将与设置值相等的帧传递到文件描述符中。

上述配置选项都支持通过对应获取器选项读取当前配置。

**警告：** 首先调用 `L2TAP_S_INTF_DEVICE` 或 `L2TAP_S_DEVICE_DRV_HNDL` 将文件描述符绑定到特定网络接口，随后方可调用 `L2TAP_S_RCV_FILTER` 选项。

**备注：** 当前不支持识别 VLAN 标记帧。如果用户需要处理 VLAN 标记帧，应将过滤器设置为等于 VLAN 标记（即 `0x8100` 或 `0x88A8`），并在用户应用程序中处理 VLAN 标记帧。

**备注：** 当用户应用程序不需要使用 IP 栈时，`L2TAP_S_DEVICE_DRV_HNDL` 将非常适用，也无需初始化 ESP-NETIF。但在此情况下，网络接口无法通过 `if_key` 来识别，需要通过 IO 驱动程序句柄直接标识网络接口。

成功时，`ioctl()` 返回 `0`。出错时，返回 `-1`，并设置 `errno` 以指示错误类型：

- \* `EBADF` - 文件描述符无效。
- \* `EACCES` - 此状态下无法改变选项（例如文件描述符尚未绑定到网络接口）。
- \* `EINVAL` - 配置参数无效。同一网络接口上的其他文件描述符已经使用了以太网类型过滤器。
- \* `ENODEV` - 此文件描述符尝试分配给的网络接口不存在。
- \* `ENOSYS` - 不支持该操作，传递的配置选项不存在。

**fcntl()** `fcntl()` 配置已开启的 ESP-NETIF L2 TAP 文件描述符属性。

以下命令调控与文件描述符相关的状态标志：

- `F_GETFD` - 函数返回文件描述符标志，忽略第三个参数。

- `F_SETFD` - 将文件描述符标志设置为第三个参数的指定值。返回零。

成功时, `ioctl()` 返回 0。出错时, 返回 -1, 并设置 `errno` 以指示错误类型。

- \* `EBADF` - 文件描述符无效。
- \* `ENOSYS` - 不支持该命令。

**read()** 已开启并完成配置的 ESP-NETIF L2 TAP 文件描述符可通过 `read()` 获取入站帧。读取可以是阻塞或非阻塞的, 具体取决于 `O_NONBLOCK` 文件状态标志的实际状态。当文件状态标志设置为阻塞时, 读取程序将等待, 直到接收到帧, 并将上下文切换到其他任务。当文件状态标志设置为非阻塞时, 立即返回读取程序。在此情况下, 如果已经帧已经入队, 则返回一帧, 否则函数指示队列为空。与文件描述符关联的队列帧数量受 `CONFIG_ESP_NETIF_L2_TAP_RX_QUEUE_SIZE` Kconfig 选项限制。一旦队列里帧的数量达到配置的阈值, 新到达的帧将被丢弃, 直到队列有足够的空间接受传入的流量 (队尾丢弃队列管理)。

成功时, `read()` 函数返回读取的字节数。当目标缓冲区的大小为 0 时, 函数返回 0。出错时, 函数返回 -1, 并设置 `errno` 以指示错误类型。

- \* `EBADF` - 文件描述符无效。
- \* `EAGAIN` - 文件描述符标记为非阻塞 (`O_NONBLOCK`), 但读取受阻塞。

**write()** 通过已开启并完成配置的 ESP-NETIF L2 TAP 文件描述符可以将原始数据链路层帧发送到网络接口, 用户应用程序负责构建除物理接口设备自动添加的字段外的整个帧。在以太网链路中, 用户应用程序需要构建以下字段: 源或目的 MAC 地址、以太网类型、实际协议头和用户数据, 字段长度如下表:

目的 MAC	源 MAC	类型/长度	负载 (协议头/数据)
6 B	6 B	2 B	0-1486 B

换句话说, ESP-NETIF L2 TAP 接口不会对数据帧进行额外处理, 只会检查数据帧的以太网类型是否与文件描述符配置的过滤器相同。如果以太网类型不同, 则会返回错误, 并且不发送数据帧。需要注意的是, 由于网络接口是由多个 ESP-NETIF L2 TAP 文件描述符和 IP 栈共享的资源, 且当前缺乏列队机制, 当前实现中的 `write()` 在进入网络接口时可能会受阻塞,。

成功时, `write()` 返回已写入的字节数。如果输入缓冲区的大小为 0, 则返回 0。出错时, 则返回 -1, 并设置 `errno` 以指示错误类型。

- \* `EBADF` - 文件描述符无效。
- \* `EBADMSG` - 帧的以太网类型与文件描述符配置的过滤器不同。
- \* `EIO` - 网络接口不可用或正忙。

**close()** 已开启的 ESP-NETIF L2 TAP 文件描述符可以通过 `close()` 函数关闭, 释放其分配到的资源。ESP-NETIF L2 TAP 实现的 `close()` 函数可能会受阻塞, 但它是线程安全的, 可以从与实际使用文件描述符的任务不同的任务中调用。如果出现一个任务在 I/O 操作中被阻塞、另一个任务试图关闭文件描述符的情况, 则第一个任务会解除阻塞, 其读取程序以错误结束。

成功时, `close()` 返回 0。出错时, 则返回 -1, 并设置 `errno` 以指示错误类型。

- \* `EBADF` - 文件描述符无效。

**select()** `select()` 函数按标准方法使用, 启用 `CONFIG_VFS_SUPPORT_SELECT` 即可使用该函数。

**SNTP API** SNTP 的简要介绍、初始化代码和基本模式请参阅[系统时间](#)的[SNTP 时间同步](#)小节。

本节介绍了使用 SNTP 服务特定用例的详细信息，包括静态配置的服务器、使用 DHCP 提供的服务器或两者兼备的情况，操作流程如下：

- 1) 调用 `esp_netif_sntp_init()` 初始化服务并完成配置。此操作只能执行一次（除非已调用 `esp_netif_sntp_deinit()` 销毁 SNTP 服务）。
- 2) 调用 `esp_netif_sntp_start()` 启动服务。如果在前一步中已经默认启动了服务，则不需要此步骤。如果需使用通过 DHCP 获取的 NTP 服务器，推荐在完成连接后显式启动该服务。注意，应在连接前启用通过 DHCP 获取的 NTP 服务器选项，并在连接后再启用 SNTP 服务。
- 3) 需要时，可调用 `esp_netif_sntp_sync_wait()` 等待系统时间同步。
- 4) 调用 `esp_netif_sntp_deinit()` 停止并销毁服务。

**使用静态定义服务器的基本模式** 连接到网络后，使用默认配置初始化该模块。注意，在配置结构体中可提供多个 NTP 服务器：

```
esp_sntp_config_t config = ESP_NETIF_SNTP_DEFAULT_CONFIG_MULTIPLE(2,
    ESP_SNTP_SERVER_LIST("time.windows.com", "pool.ntp.org"
↪) );
esp_netif_sntp_init(&config);
```

**备注：**要配置多个 SNTP 服务器，需要更新 lwIP 配置，请参阅[CONFIG\\_LWIP\\_SNTP\\_MAX\\_SERVERS](#)。

**使用 DHCP 获取的 SNTP 服务器** 首先，激活 lwIP 配置选项，相关配置请参阅[CONFIG\\_LWIP\\_DHCP\\_GET\\_NTP\\_SRV](#)。其次，在使用 DHCP 选项、且不使用 NTP 服务器的情况下初始化 SNTP 模块，代码如下：

```
esp_sntp_config_t config = ESP_NETIF_SNTP_DEFAULT_CONFIG_MULTIPLE(0, {});
config.start = false; // 启动 SNTP 服务
config.server_from_dhcp = true; // 接收来自 DHCP 服务器的 NTP
↪服务提供方案
esp_netif_sntp_init(&config);
```

连接成功后，可通过以下代码启动服务器：

```
esp_netif_sntp_start();
```

**备注：**也可选择在初始化期间启动服务（即默认 `config.start=true`）。注意，此时连接尚未完成，可能导致初始 SNTP 请求失败，并增加后续各次请求之间的延迟时间。

**同时使用静态和动态服务器** 同时使用静态和动态服务器的流程与使用 DHCP 获取的 SNTP 服务器基本相同。配置时，用户应确保在通过 DHCP 获取 NTP 服务器时刷新静态服务器配置。底层 lwIP 代码会在接受 DHCP 提供的信息时清理其余的 NTP 服务器列表。因此，ESP-NETIF SNTP 模块会保存静态配置的服务器，并在获取 DHCP 租约后对其重新配置。

典型配置依次如下，提供特定 IP\_EVENT 更新配置，并提供第一个服务器的索引完成重新配置（例如，设置 `config.index_of_first_server=1` 会将 DHCP 提供的服务器保留在索引 0，而将静态配置的服务器保留在索引 1）。

```
esp_sntp_config_t config = ESP_NETIF_SNTP_DEFAULT_CONFIG("pool.ntp.org");
config.start = false; // 启动 SNTP 服务（连接成功后）
config.server_from_dhcp = true; // 接收来自 DHCP 服务器的 NTP
↪服务提供方案
config.renew_servers_after_new_IP = true; // 让 esp-netif 在接收到 DHCP
↪租约后更新配置的 SNTP 服务器
```

(下页继续)

(续上页)

```
config.index_of_first_server = 1; // 服务器 1 开始更新, 保留从 DHCP_
↳ 获取的服务器 0 的设置
config.ip_event_to_renew = IP_EVENT_STA_GOT_IP; // 基于 IP 事件刷新配置
```

随后, 调用 `esp_netif_sntp_start()` 启用服务。

**ESP-NETIF 编程手册** 请参阅示例部分, 了解默认接口的基本初始化:

- 以太网 `ethernet/basic/main/ethernet_example_main.c`
- L2 TAP `protocols/l2tap/main/l2tap_main.c`

更多示例请参阅 *ESP-NETIF 自定义 I/O 驱动程序*。

## API 参考

### Header File

- `components/esp_netif/include/esp_netif.h`
- This header file can be included with:

```
#include "esp_netif.h"
```

- This header file is a part of the API provided by the `esp_netif` component. To declare that your component depends on `esp_netif`, add the following to your `CMakeLists.txt`:

```
REQUIRES esp_netif
```

or

```
PRIV_REQUIRES esp_netif
```

### Functions

`esp_err_t esp_netif_init` (void)

Initialize the underlying TCP/IP stack.

---

**备注:** This function should be called exactly once from application code, when the application starts up.

---

#### 返回

- `ESP_OK` on success
- `ESP_FAIL` if initializing failed

`esp_err_t esp_netif_deinit` (void)

Deinitialize the esp-netif component (and the underlying TCP/IP stack)

```
Note: Deinitialization is not supported yet
```

#### 返回

- `ESP_ERR_INVALID_STATE` if esp\_netif not initialized
- `ESP_ERR_NOT_SUPPORTED` otherwise

`esp_netif_t *esp_netif_new` (const `esp_netif_config_t` \*esp\_netif\_config)

Creates an instance of new esp-netif object based on provided config.

**参数** `esp_netif_config` -- [in] pointer esp-netif configuration

#### 返回

- pointer to esp-netif object on success

- NULL otherwise

void **esp\_netif\_destroy** (*esp\_netif\_t* \*esp\_netif)

Destroys the esp\_netif object.

**参数** **esp\_netif** -- [in] pointer to the object to be deleted

*esp\_err\_t* **esp\_netif\_set\_driver\_config** (*esp\_netif\_t* \*esp\_netif, const *esp\_netif\_driver\_ifconfig\_t* \*driver\_config)

Configures driver related options of esp\_netif object.

**参数**

- **esp\_netif** -- [inout] pointer to the object to be configured
- **driver\_config** -- [in] pointer esp-netif io driver related configuration

**返回**

- ESP\_OK on success
- ESP\_ERR\_ESP\_NETIF\_INVALID\_PARAMS if invalid parameters provided

*esp\_err\_t* **esp\_netif\_attach** (*esp\_netif\_t* \*esp\_netif, *esp\_netif\_io\_driver\_handle\_t* driver\_handle)

Attaches esp\_netif instance to the io driver handle.

Calling this function enables connecting specific esp\_netif object with already initialized io driver to update esp\_netif object with driver specific configuration (i.e. calls post\_attach callback, which typically sets io driver callbacks to esp\_netif instance and starts the driver)

**参数**

- **esp\_netif** -- [inout] pointer to esp\_netif object to be attached
- **driver\_handle** -- [in] pointer to the driver handle

**返回**

- ESP\_OK on success
- ESP\_ERR\_ESP\_NETIF\_DRIVER\_ATTACH\_FAILED if driver's post\_attach callback failed

*esp\_err\_t* **esp\_netif\_receive** (*esp\_netif\_t* \*esp\_netif, void \*buffer, size\_t len, void \*eb)

Passes the raw packets from communication media to the appropriate TCP/IP stack.

This function is called from the configured (peripheral) driver layer. The data are then forwarded as frames to the TCP/IP stack.

**参数**

- **esp\_netif** -- [in] Handle to esp-netif instance
- **buffer** -- [in] Received data
- **len** -- [in] Length of the data frame
- **eb** -- [in] Pointer to internal buffer (used in Wi-Fi driver)

**返回**

- ESP\_OK

void **esp\_netif\_action\_start** (void \*esp\_netif, esp\_event\_base\_t base, int32\_t event\_id, void \*data)

Default building block for network interface action upon IO driver start event Creates network interface, if AUTOUP enabled turns the interface on, if DHCP enabled starts dhcp server.

---

**备注:** This API can be directly used as event handler

---

**参数**

- **esp\_netif** -- [in] Handle to esp-netif instance
- **base** -- The base type of the event
- **event\_id** -- The specific ID of the event
- **data** -- Optional data associated with the event

void **esp\_netif\_action\_stop** (void \*esp\_netif, esp\_event\_base\_t base, int32\_t event\_id, void \*data)

Default building block for network interface action upon IO driver stop event.

---

备注: This API can be directly used as event handler

---

#### 参数

- **esp\_netif** -- [in] Handle to esp-netif instance
- **base** -- The base type of the event
- **event\_id** -- The specific ID of the event
- **data** -- Optional data associated with the event

void **esp\_netif\_action\_connected** (void \*esp\_netif, esp\_event\_base\_t base, int32\_t event\_id, void \*data)

Default building block for network interface action upon IO driver connected event.

---

备注: This API can be directly used as event handler

---

#### 参数

- **esp\_netif** -- [in] Handle to esp-netif instance
- **base** -- The base type of the event
- **event\_id** -- The specific ID of the event
- **data** -- Optional data associated with the event

void **esp\_netif\_action\_disconnected** (void \*esp\_netif, esp\_event\_base\_t base, int32\_t event\_id, void \*data)

Default building block for network interface action upon IO driver disconnected event.

---

备注: This API can be directly used as event handler

---

#### 参数

- **esp\_netif** -- [in] Handle to esp-netif instance
- **base** -- The base type of the event
- **event\_id** -- The specific ID of the event
- **data** -- Optional data associated with the event

void **esp\_netif\_action\_got\_ip** (void \*esp\_netif, esp\_event\_base\_t base, int32\_t event\_id, void \*data)

Default building block for network interface action upon network got IP event.

---

备注: This API can be directly used as event handler

---

#### 参数

- **esp\_netif** -- [in] Handle to esp-netif instance
- **base** -- The base type of the event
- **event\_id** -- The specific ID of the event
- **data** -- Optional data associated with the event

void **esp\_netif\_action\_join\_ip6\_multicast\_group** (void \*esp\_netif, esp\_event\_base\_t base, int32\_t event\_id, void \*data)

Default building block for network interface action upon IPv6 multicast group join.



---

备注: This API can be directly used as event handler

---

#### 参数

- **esp\_netif** -- [in] Handle to esp-netif instance
- **base** -- The base type of the event
- **event\_id** -- The specific ID of the event
- **data** -- Optional data associated with the event

void **esp\_netif\_action\_leave\_ip6\_multicast\_group** (void \*esp\_netif, esp\_event\_base\_t base, int32\_t event\_id, void \*data)

Default building block for network interface action upon IPv6 multicast group leave.

---

备注: This API can be directly used as event handler

---

#### 参数

- **esp\_netif** -- [in] Handle to esp-netif instance
- **base** -- The base type of the event
- **event\_id** -- The specific ID of the event
- **data** -- Optional data associated with the event

void **esp\_netif\_action\_add\_ip6\_address** (void \*esp\_netif, esp\_event\_base\_t base, int32\_t event\_id, void \*data)

Default building block for network interface action upon IPv6 address added by the underlying stack.

---

备注: This API can be directly used as event handler

---

#### 参数

- **esp\_netif** -- [in] Handle to esp-netif instance
- **base** -- The base type of the event
- **event\_id** -- The specific ID of the event
- **data** -- Optional data associated with the event

void **esp\_netif\_action\_remove\_ip6\_address** (void \*esp\_netif, esp\_event\_base\_t base, int32\_t event\_id, void \*data)

Default building block for network interface action upon IPv6 address removed by the underlying stack.

---

备注: This API can be directly used as event handler

---

#### 参数

- **esp\_netif** -- [in] Handle to esp-netif instance
- **base** -- The base type of the event
- **event\_id** -- The specific ID of the event
- **data** -- Optional data associated with the event

*esp\_err\_t* **esp\_netif\_set\_default\_netif** (*esp\_netif\_t* \*esp\_netif)

Manual configuration of the default netif.

This API overrides the automatic configuration of the default interface based on the route\_prio. If the selected netif is set default using this API, no other interface could be set-default disregarding its route\_prio number (unless the selected netif gets destroyed).

**参数** `esp_netif` -- **[in]** Handle to esp-netif instance  
**返回** ESP\_OK on success

`esp_netif_t *esp_netif_get_default_netif` (void)

Getter function of the default netif.

This API returns the selected default netif.

**返回** Handle to esp-netif instance of the default netif.

`esp_err_t esp_netif_join_ip6_multicast_group` (`esp_netif_t *esp_netif`, const `esp_ip6_addr_t *addr`)

Cause the TCP/IP stack to join a IPv6 multicast group.

**参数**

- `esp_netif` -- **[in]** Handle to esp-netif instance
- `addr` -- **[in]** The multicast group to join

**返回**

- ESP\_OK
- ESP\_ERR\_ESP\_NETIF\_INVALID\_PARAMS
- ESP\_ERR\_ESP\_NETIF\_MLD6\_FAILED
- ESP\_ERR\_NO\_MEM

`esp_err_t esp_netif_leave_ip6_multicast_group` (`esp_netif_t *esp_netif`, const `esp_ip6_addr_t *addr`)

Cause the TCP/IP stack to leave a IPv6 multicast group.

**参数**

- `esp_netif` -- **[in]** Handle to esp-netif instance
- `addr` -- **[in]** The multicast group to leave

**返回**

- ESP\_OK
- ESP\_ERR\_ESP\_NETIF\_INVALID\_PARAMS
- ESP\_ERR\_ESP\_NETIF\_MLD6\_FAILED
- ESP\_ERR\_NO\_MEM

`esp_err_t esp_netif_set_mac` (`esp_netif_t *esp_netif`, `uint8_t mac[]`)

Set the mac address for the interface instance.

**参数**

- `esp_netif` -- **[in]** Handle to esp-netif instance
- `mac` -- **[in]** Desired mac address for the related network interface

**返回**

- ESP\_OK - success
- ESP\_ERR\_ESP\_NETIF\_IF\_NOT\_READY - interface status error
- ESP\_ERR\_NOT\_SUPPORTED - mac not supported on this interface

`esp_err_t esp_netif_get_mac` (`esp_netif_t *esp_netif`, `uint8_t mac[]`)

Get the mac address for the interface instance.

**参数**

- `esp_netif` -- **[in]** Handle to esp-netif instance
- `mac` -- **[out]** Resultant mac address for the related network interface

**返回**

- ESP\_OK - success
- ESP\_ERR\_ESP\_NETIF\_IF\_NOT\_READY - interface status error
- ESP\_ERR\_NOT\_SUPPORTED - mac not supported on this interface

`esp_err_t esp_netif_set_hostname` (`esp_netif_t *esp_netif`, const char \*hostname)

Set the hostname of an interface.

The configured hostname overrides the default configuration value CONFIG\_LWIP\_LOCAL\_HOSTNAME. Please note that when the hostname is altered after interface started/connected the changes would only be



reflected once the interface restarts/reconnects

#### 参数

- **esp\_netif** -- [in] Handle to esp-netif instance
- **hostname** -- [in] New hostname for the interface. Maximum length 32 bytes.

#### 返回

- ESP\_OK - success
- ESP\_ERR\_ESP\_NETIF\_IF\_NOT\_READY - interface status error
- ESP\_ERR\_ESP\_NETIF\_INVALID\_PARAMS - parameter error

*esp\_err\_t* **esp\_netif\_get\_hostname** (*esp\_netif\_t* \*esp\_netif, const char \*\*hostname)

Get interface hostname.

#### 参数

- **esp\_netif** -- [in] Handle to esp-netif instance
- **hostname** -- [out] Returns a pointer to the hostname. May be NULL if no hostname is set. If set non-NULL, pointer remains valid (and string may change if the hostname changes).

#### 返回

- ESP\_OK - success
- ESP\_ERR\_ESP\_NETIF\_IF\_NOT\_READY - interface status error
- ESP\_ERR\_ESP\_NETIF\_INVALID\_PARAMS - parameter error

bool **esp\_netif\_is\_netif\_up** (*esp\_netif\_t* \*esp\_netif)

Test if supplied interface is up or down.

参数 **esp\_netif** -- [in] Handle to esp-netif instance

#### 返回

- true - Interface is up
- false - Interface is down

*esp\_err\_t* **esp\_netif\_get\_ip\_info** (*esp\_netif\_t* \*esp\_netif, *esp\_netif\_ip\_info\_t* \*ip\_info)

Get interface's IP address information.

If the interface is up, IP information is read directly from the TCP/IP stack. If the interface is down, IP information is read from a copy kept in the ESP-NETIF instance

#### 参数

- **esp\_netif** -- [in] Handle to esp-netif instance
- **ip\_info** -- [out] If successful, IP information will be returned in this argument.

#### 返回

- ESP\_OK
- ESP\_ERR\_ESP\_NETIF\_INVALID\_PARAMS

*esp\_err\_t* **esp\_netif\_get\_old\_ip\_info** (*esp\_netif\_t* \*esp\_netif, *esp\_netif\_ip\_info\_t* \*ip\_info)

Get interface's old IP information.

Returns an "old" IP address previously stored for the interface when the valid IP changed.

If the IP lost timer has expired (meaning the interface was down for longer than the configured interval) then the old IP information will be zero.

#### 参数

- **esp\_netif** -- [in] Handle to esp-netif instance
- **ip\_info** -- [out] If successful, IP information will be returned in this argument.

#### 返回

- ESP\_OK
- ESP\_ERR\_ESP\_NETIF\_INVALID\_PARAMS

*esp\_err\_t* **esp\_netif\_set\_ip\_info** (*esp\_netif\_t* \*esp\_netif, const *esp\_netif\_ip\_info\_t* \*ip\_info)

Set interface's IP address information.

This function is mainly used to set a static IP on an interface.

If the interface is up, the new IP information is set directly in the TCP/IP stack.

The copy of IP information kept in the ESP-NETIF instance is also updated (this copy is returned if the IP is queried while the interface is still down.)

---

**备注:** DHCP client/server must be stopped (if enabled for this interface) before setting new IP information.

---



---

**备注:** Calling this interface for may generate a SYSTEM\_EVENT\_STA\_GOT\_IP or SYSTEM\_EVENT\_ETH\_GOT\_IP event.

---

#### 参数

- **esp\_netif** -- [in] Handle to esp-netif instance
- **ip\_info** -- [in] IP information to set on the specified interface

#### 返回

- ESP\_OK
- ESP\_ERR\_ESP\_NETIF\_INVALID\_PARAMS
- ESP\_ERR\_ESP\_NETIF\_DHCP\_NOT\_STOPPED If DHCP server or client is still running

*esp\_err\_t* **esp\_netif\_set\_old\_ip\_info** (*esp\_netif\_t* \*esp\_netif, const *esp\_netif\_ip\_info\_t* \*ip\_info)

Set interface old IP information.

This function is called from the DHCP client (if enabled), before a new IP is set. It is also called from the default handlers for the SYSTEM\_EVENT\_STA\_CONNECTED and SYSTEM\_EVENT\_ETH\_CONNECTED events.

Calling this function stores the previously configured IP, which can be used to determine if the IP changes in the future.

If the interface is disconnected or down for too long, the "IP lost timer" will expire (after the configured interval) and set the old IP information to zero.

#### 参数

- **esp\_netif** -- [in] Handle to esp-netif instance
- **ip\_info** -- [in] Store the old IP information for the specified interface

#### 返回

- ESP\_OK
- ESP\_ERR\_ESP\_NETIF\_INVALID\_PARAMS

int **esp\_netif\_get\_netif\_impl\_index** (*esp\_netif\_t* \*esp\_netif)

Get net interface index from network stack implementation.

---

**备注:** This index could be used in `setsockopt()` to bind socket with multicast interface

---

**参数** **esp\_netif** -- [in] Handle to esp-netif instance

**返回** implementation specific index of interface represented with supplied esp\_netif

*esp\_err\_t* **esp\_netif\_get\_netif\_impl\_name** (*esp\_netif\_t* \*esp\_netif, char \*name)

Get net interface name from network stack implementation.

---

**备注:** This name could be used in `setsockopt()` to bind socket with appropriate interface

---

#### 参数

- **esp\_netif** -- [in] Handle to esp-netif instance

- **name** -- **[out]** Interface name as specified in underlying TCP/IP stack. Note that the actual name will be copied to the specified buffer, which must be allocated to hold maximum interface name size (6 characters for lwIP)

返回

- ESP\_OK
- ESP\_ERR\_ESP\_NETIF\_INVALID\_PARAMS

*esp\_err\_t* **esp\_netif\_napt\_enable** (*esp\_netif\_t* \*esp\_netif)

Enable NAPT on an interface.

---

**备注:** Enable operation can be performed only on one interface at a time. NAPT cannot be enabled on multiple interfaces according to this implementation.

---

**参数** **esp\_netif** -- **[in]** Handle to esp-netif instance

返回

- ESP\_OK
- ESP\_FAIL
- ESP\_ERR\_NOT\_SUPPORTED

*esp\_err\_t* **esp\_netif\_napt\_disable** (*esp\_netif\_t* \*esp\_netif)

Disable NAPT on an interface.

**参数** **esp\_netif** -- **[in]** Handle to esp-netif instance

返回

- ESP\_OK
- ESP\_FAIL
- ESP\_ERR\_NOT\_SUPPORTED

*esp\_err\_t* **esp\_netif\_dhcps\_option** (*esp\_netif\_t* \*esp\_netif, *esp\_netif\_dhcp\_option\_mode\_t* opt\_op, *esp\_netif\_dhcp\_option\_id\_t* opt\_id, void \*opt\_val, uint32\_t opt\_len)

Set or Get DHCP server option.

**参数**

- **esp\_netif** -- **[in]** Handle to esp-netif instance
- **opt\_op** -- **[in]** ESP\_NETIF\_OP\_SET to set an option, ESP\_NETIF\_OP\_GET to get an option.
- **opt\_id** -- **[in]** Option index to get or set, must be one of the supported enum values.
- **opt\_val** -- **[inout]** Pointer to the option parameter.
- **opt\_len** -- **[in]** Length of the option parameter.

返回

- ESP\_OK
- ESP\_ERR\_ESP\_NETIF\_INVALID\_PARAMS
- ESP\_ERR\_ESP\_NETIF\_DHCP\_ALREADY\_STOPPED
- ESP\_ERR\_ESP\_NETIF\_DHCP\_ALREADY\_STARTED

*esp\_err\_t* **esp\_netif\_dhcpc\_option** (*esp\_netif\_t* \*esp\_netif, *esp\_netif\_dhcp\_option\_mode\_t* opt\_op, *esp\_netif\_dhcp\_option\_id\_t* opt\_id, void \*opt\_val, uint32\_t opt\_len)

Set or Get DHCP client option.

**参数**

- **esp\_netif** -- **[in]** Handle to esp-netif instance
- **opt\_op** -- **[in]** ESP\_NETIF\_OP\_SET to set an option, ESP\_NETIF\_OP\_GET to get an option.
- **opt\_id** -- **[in]** Option index to get or set, must be one of the supported enum values.
- **opt\_val** -- **[inout]** Pointer to the option parameter.
- **opt\_len** -- **[in]** Length of the option parameter.

返回

- ESP\_OK

- ESP\_ERR\_ESP\_NETIF\_INVALID\_PARAMS
- ESP\_ERR\_ESP\_NETIF\_DHCP\_ALREADY\_STOPPED
- ESP\_ERR\_ESP\_NETIF\_DHCP\_ALREADY\_STARTED

*esp\_err\_t* **esp\_netif\_dhcpc\_start** (*esp\_netif\_t* \*esp\_netif)

Start DHCP client (only if enabled in interface object)

---

**备注:** The default event handlers for the SYSTEM\_EVENT\_STA\_CONNECTED and SYSTEM\_EVENT\_ETH\_CONNECTED events call this function.

---

**参数** *esp\_netif* -- [in] Handle to esp-netif instance  
**返回**

- ESP\_OK
- ESP\_ERR\_ESP\_NETIF\_INVALID\_PARAMS
- ESP\_ERR\_ESP\_NETIF\_DHCP\_ALREADY\_STARTED
- ESP\_ERR\_ESP\_NETIF\_DHCPC\_START\_FAILED

*esp\_err\_t* **esp\_netif\_dhcpc\_stop** (*esp\_netif\_t* \*esp\_netif)

Stop DHCP client (only if enabled in interface object)

---

**备注:** Calling action\_netif\_stop() will also stop the DHCP Client if it is running.

---

**参数** *esp\_netif* -- [in] Handle to esp-netif instance  
**返回**

- ESP\_OK
- ESP\_ERR\_ESP\_NETIF\_INVALID\_PARAMS
- ESP\_ERR\_ESP\_NETIF\_DHCP\_ALREADY\_STOPPED
- ESP\_ERR\_ESP\_NETIF\_IF\_NOT\_READY

*esp\_err\_t* **esp\_netif\_dhcpc\_get\_status** (*esp\_netif\_t* \*esp\_netif, *esp\_netif\_dhcp\_status\_t* \*status)

Get DHCP client status.

**参数**

- *esp\_netif* -- [in] Handle to esp-netif instance
- *status* -- [out] If successful, the status of DHCP client will be returned in this argument.

**返回**

- ESP\_OK

*esp\_err\_t* **esp\_netif\_dhcps\_get\_status** (*esp\_netif\_t* \*esp\_netif, *esp\_netif\_dhcp\_status\_t* \*status)

Get DHCP Server status.

**参数**

- *esp\_netif* -- [in] Handle to esp-netif instance
- *status* -- [out] If successful, the status of the DHCP server will be returned in this argument.

**返回**

- ESP\_OK

*esp\_err\_t* **esp\_netif\_dhcps\_start** (*esp\_netif\_t* \*esp\_netif)

Start DHCP server (only if enabled in interface object)

**参数** *esp\_netif* -- [in] Handle to esp-netif instance  
**返回**

- ESP\_OK
- ESP\_ERR\_ESP\_NETIF\_INVALID\_PARAMS
- ESP\_ERR\_ESP\_NETIF\_DHCP\_ALREADY\_STARTED

*esp\_err\_t* **esp\_netif\_dhcps\_stop** (*esp\_netif\_t* \*esp\_netif)

Stop DHCP server (only if enabled in interface object)

**参数** **esp\_netif** -- **[in]** Handle to esp-netif instance

**返回**

- ESP\_OK
- ESP\_ERR\_ESP\_NETIF\_INVALID\_PARAMS
- ESP\_ERR\_ESP\_NETIF\_DHCP\_ALREADY\_STOPPED
- ESP\_ERR\_ESP\_NETIF\_IF\_NOT\_READY

*esp\_err\_t* **esp\_netif\_dhcps\_get\_clients\_by\_mac** (*esp\_netif\_t* \*esp\_netif, int num, *esp\_netif\_pair\_mac\_ip\_t* \*mac\_ip\_pair)

Populate IP addresses of clients connected to DHCP server listed by their MAC addresses.

**参数**

- **esp\_netif** -- **[in]** Handle to esp-netif instance
- **num** -- **[in]** Number of clients with specified MAC addresses in the array of pairs
- **mac\_ip\_pair** -- **[inout]** Array of pairs of MAC and IP addresses (MAC are inputs, IP outputs)

**返回**

- ESP\_OK on success
- ESP\_ERR\_ESP\_NETIF\_INVALID\_PARAMS on invalid params
- ESP\_ERR\_NOT\_SUPPORTED if DHCP server not enabled

*esp\_err\_t* **esp\_netif\_set\_dns\_info** (*esp\_netif\_t* \*esp\_netif, *esp\_netif\_dns\_type\_t* type, *esp\_netif\_dns\_info\_t* \*dns)

Set DNS Server information.

This function behaves differently if DHCP server or client is enabled

If DHCP client is enabled, main and backup DNS servers will be updated automatically from the DHCP lease if the relevant DHCP options are set. Fallback DNS Server is never updated from the DHCP lease and is designed to be set via this API. If DHCP client is disabled, all DNS server types can be set via this API only.

If DHCP server is enabled, the Main DNS Server setting is used by the DHCP server to provide a DNS Server option to DHCP clients (Wi-Fi stations).

- The default Main DNS server is typically the IP of the DHCP server itself.
- This function can override it by setting server type ESP\_NETIF\_DNS\_MAIN.
- Other DNS Server types are not supported for the DHCP server.
- To propagate the DNS info to client, please stop the DHCP server before using this API.

**参数**

- **esp\_netif** -- **[in]** Handle to esp-netif instance
- **type** -- **[in]** Type of DNS Server to set: ESP\_NETIF\_DNS\_MAIN, ESP\_NETIF\_DNS\_BACKUP, ESP\_NETIF\_DNS\_FALLBACK
- **dns** -- **[in]** DNS Server address to set

**返回**

- ESP\_OK on success
- ESP\_ERR\_ESP\_NETIF\_INVALID\_PARAMS invalid params

*esp\_err\_t* **esp\_netif\_get\_dns\_info** (*esp\_netif\_t* \*esp\_netif, *esp\_netif\_dns\_type\_t* type, *esp\_netif\_dns\_info\_t* \*dns)

Get DNS Server information.

Return the currently configured DNS Server address for the specified interface and Server type.

This may be result of a previous call to *esp\_netif\_set\_dns\_info()*. If the interface's DHCP client is enabled, the Main or Backup DNS Server may be set by the current DHCP lease.

**参数**

- **esp\_netif** -- **[in]** Handle to esp-netif instance

- **type** -- **[in]** Type of DNS Server to get: ESP\_NETIF\_DNS\_MAIN, ESP\_NETIF\_DNS\_BACKUP, ESP\_NETIF\_DNS\_FALLBACK
- **dns** -- **[out]** DNS Server result is written here on success

**返回**

- ESP\_OK on success
- ESP\_ERR\_ESP\_NETIF\_INVALID\_PARAMS invalid params

*esp\_err\_t* **esp\_netif\_create\_ip6\_linklocal** (*esp\_netif\_t* \*esp\_netif)

Create interface link-local IPv6 address.

Cause the TCP/IP stack to create a link-local IPv6 address for the specified interface.

This function also registers a callback for the specified interface, so that if the link-local address becomes verified as the preferred address then a SYSTEM\_EVENT\_GOT\_IP6 event will be sent.

**参数** **esp\_netif** -- **[in]** Handle to esp-netif instance

**返回**

- ESP\_OK
- ESP\_ERR\_ESP\_NETIF\_INVALID\_PARAMS

*esp\_err\_t* **esp\_netif\_get\_ip6\_linklocal** (*esp\_netif\_t* \*esp\_netif, *esp\_ip6\_addr\_t* \*if\_ip6)

Get interface link-local IPv6 address.

If the specified interface is up and a preferred link-local IPv6 address has been created for the interface, return a copy of it.

**参数**

- **esp\_netif** -- **[in]** Handle to esp-netif instance
- **if\_ip6** -- **[out]** IPv6 information will be returned in this argument if successful.

**返回**

- ESP\_OK
- ESP\_FAIL If interface is down, does not have a link-local IPv6 address, or the link-local IPv6 address is not a preferred address.

*esp\_err\_t* **esp\_netif\_get\_ip6\_global** (*esp\_netif\_t* \*esp\_netif, *esp\_ip6\_addr\_t* \*if\_ip6)

Get interface global IPv6 address.

If the specified interface is up and a preferred global IPv6 address has been created for the interface, return a copy of it.

**参数**

- **esp\_netif** -- **[in]** Handle to esp-netif instance
- **if\_ip6** -- **[out]** IPv6 information will be returned in this argument if successful.

**返回**

- ESP\_OK
- ESP\_FAIL If interface is down, does not have a global IPv6 address, or the global IPv6 address is not a preferred address.

**int** **esp\_netif\_get\_all\_ip6** (*esp\_netif\_t* \*esp\_netif, *esp\_ip6\_addr\_t* if\_ip6[])

Get all IPv6 addresses of the specified interface.

**参数**

- **esp\_netif** -- **[in]** Handle to esp-netif instance
- **if\_ip6** -- **[out]** Array of IPv6 addresses will be copied to the argument

**返回** number of returned IPv6 addresses

*esp\_err\_t* **esp\_netif\_add\_ip6\_address** (*esp\_netif\_t* \*esp\_netif, const *esp\_ip6\_addr\_t* addr, bool preferred)

Cause the TCP/IP stack to add an IPv6 address to the interface.

**参数**

- **esp\_netif** -- **[in]** Handle to esp-netif instance
- **addr** -- **[in]** The address to be added
- **preferred** -- **[in]** The preferred status of the address

## 返回

- ESP\_OK
- ESP\_ERR\_ESP\_NETIF\_INVALID\_PARAMS
- ESP\_ERR\_ESP\_NETIF\_IP6\_ADDR\_FAILED
- ESP\_ERR\_NO\_MEM

*esp\_err\_t* **esp\_netif\_remove\_ip6\_address** (*esp\_netif\_t* \*esp\_netif, const *esp\_ip6\_addr\_t* \*addr)

Cause the TCP/IP stack to remove an IPv6 address from the interface.

## 参数

- **esp\_netif** -- [in] Handle to esp-netif instance
- **addr** -- [in] The address to be removed

## 返回

- ESP\_OK
- ESP\_ERR\_ESP\_NETIF\_INVALID\_PARAMS
- ESP\_ERR\_ESP\_NETIF\_IP6\_ADDR\_FAILED
- ESP\_ERR\_NO\_MEM

void **esp\_netif\_set\_ip4\_addr** (*esp\_ip4\_addr\_t* \*addr, uint8\_t a, uint8\_t b, uint8\_t c, uint8\_t d)

Sets IPv4 address to the specified octets.

## 参数

- **addr** -- [out] IP address to be set
- **a** -- the first octet (127 for IP 127.0.0.1)
- **b** --
- **c** --
- **d** --

char \***esp\_ip4addr\_ntoa** (const *esp\_ip4\_addr\_t* \*addr, char \*buf, int buflen)

Converts numeric IP address into decimal dotted ASCII representation.

## 参数

- **addr** -- ip address in network order to convert
- **buf** -- target buffer where the string is stored
- **buflen** -- length of buf

**返回** either pointer to buf which now holds the ASCII representation of addr or NULL if buf was too small

uint32\_t **esp\_ip4addr\_aton** (const char \*addr)

Ascii internet address interpretation routine The value returned is in network order.

**参数** **addr** -- IP address in ascii representation (e.g. "127.0.0.1")

**返回** ip address in network order

*esp\_err\_t* **esp\_netif\_str\_to\_ip4** (const char \*src, *esp\_ip4\_addr\_t* \*dst)

Converts Ascii internet IPv4 address into esp\_ip4\_addr\_t.

## 参数

- **src** -- [in] IPv4 address in ascii representation (e.g. "127.0.0.1")
- **dst** -- [out] Address of the target esp\_ip4\_addr\_t structure to receive converted address

## 返回

- ESP\_OK on success
- ESP\_FAIL if conversion failed
- ESP\_ERR\_INVALID\_ARG if invalid parameter is passed into

*esp\_err\_t* **esp\_netif\_str\_to\_ip6** (const char \*src, *esp\_ip6\_addr\_t* \*dst)

Converts Ascii internet IPv6 address into esp\_ip4\_addr\_t Zeros in the IP address can be stripped or completely omitted: "2001:db8:85a3:0:0:0:2:1" or "2001:db8::2:1")

## 参数

- **src** -- [in] IPv6 address in ascii representation (e.g. "2001:0db8:85a3:0000:0000:0000:0002:0001")
- **dst** -- [out] Address of the target esp\_ip6\_addr\_t structure to receive converted address

## 返回

- ESP\_OK on success
- ESP\_FAIL if conversion failed
- ESP\_ERR\_INVALID\_ARG if invalid parameter is passed into

*esp\_netif\_iodriver\_handle* **esp\_netif\_get\_io\_driver** (*esp\_netif\_t* \*esp\_netif)

Gets media driver handle for this esp-netif instance.

参数 **esp\_netif** -- [in] Handle to esp-netif instance

返回 opaque pointer of related IO driver

*esp\_netif\_t* \***esp\_netif\_get\_handle\_from\_ifkey** (const char \*if\_key)

Searches over a list of created objects to find an instance with supplied if key.

参数 **if\_key** -- Textual description of network interface

返回 Handle to esp-netif instance

*esp\_netif\_flags\_t* **esp\_netif\_get\_flags** (*esp\_netif\_t* \*esp\_netif)

Returns configured flags for this interface.

参数 **esp\_netif** -- [in] Handle to esp-netif instance

返回 Configuration flags

const char \***esp\_netif\_get\_ifkey** (*esp\_netif\_t* \*esp\_netif)

Returns configured interface key for this esp-netif instance.

参数 **esp\_netif** -- [in] Handle to esp-netif instance

返回 Textual description of related interface

const char \***esp\_netif\_get\_desc** (*esp\_netif\_t* \*esp\_netif)

Returns configured interface type for this esp-netif instance.

参数 **esp\_netif** -- [in] Handle to esp-netif instance

返回 Enumerated type of this interface, such as station, AP, ethernet

int **esp\_netif\_get\_route\_prio** (*esp\_netif\_t* \*esp\_netif)

Returns configured routing priority number.

参数 **esp\_netif** -- [in] Handle to esp-netif instance

返回 Integer representing the instance's route-prio, or -1 if invalid paramters

int32\_t **esp\_netif\_get\_event\_id** (*esp\_netif\_t* \*esp\_netif, *esp\_netif\_ip\_event\_type\_t* event\_type)

Returns configured event for this esp-netif instance and supplied event type.

## 参数

- **esp\_netif** -- [in] Handle to esp-netif instance
- **event\_type** -- (either get or lost IP)

返回 specific event id which is configured to be raised if the interface lost or acquired IP address  
-1 if supplied event\_type is not known

*esp\_netif\_t* \***esp\_netif\_next** (*esp\_netif\_t* \*esp\_netif)

Iterates over list of interfaces. Returns first netif if NULL given as parameter.

---

备注: This API doesn't lock the list, nor the TCPIP context, as this it's usually required to get atomic access between iteration steps rather than within a single iteration. Therefore it is recommended to iterate over the interfaces inside *esp\_netif\_tcpip\_exec()*

---



---

备注: This API is deprecated. Please use *esp\_netif\_next\_unsafe()* directly if all the system interfaces are under your control and you can safely iterate over them. Otherwise, iterate over interfaces using *esp\_netif\_tcpip\_exec()*, or use *esp\_netif\_find\_if()* to search in the list of netifs with defined predicate.

---



**参数** `esp_netif` -- [in] Handle to esp-netif instance

**返回** First netif from the list if supplied parameter is NULL, next one otherwise

`esp_netif_t *esp_netif_next_unsafe(esp_netif_t *esp_netif)`

Iterates over list of interfaces without list locking. Returns first netif if NULL given as parameter.

Used for bulk search loops within TCPIP context, e.g. using `esp_netif_tcpip_exec()`, or if we're sure that the iteration is safe from our application perspective (e.g. no interface is removed between iterations)

**参数** `esp_netif` -- [in] Handle to esp-netif instance

**返回** First netif from the list if supplied parameter is NULL, next one otherwise

`esp_netif_t *esp_netif_find_if(esp_netif_find_predicate_t fn, void *ctx)`

Return a netif pointer for the first interface that meets criteria defined by the callback.

**参数**

- **fn** -- Predicate function returning true for the desired interface
- **ctx** -- Context pointer passed to the predicate, typically a descriptor to compare with

**返回** valid netif pointer if found, NULL if not

`size_t esp_netif_get_nr_of_ifs(void)`

Returns number of registered esp\_netif objects.

**返回** Number of esp\_netifs

`void esp_netif_netstack_buf_ref(void *netstack_buf)`

increase the reference counter of net stack buffer

**参数** `netstack_buf` -- [in] the net stack buffer

`void esp_netif_netstack_buf_free(void *netstack_buf)`

free the netstack buffer

**参数** `netstack_buf` -- [in] the net stack buffer

`esp_err_t esp_netif_tcpip_exec(esp_netif_callback_fn fn, void *ctx)`

Utility to execute the supplied callback in TCP/IP context.

**参数**

- **fn** -- Pointer to the callback
- **ctx** -- Parameter to the callback

**返回** The error code (`esp_err_t`) returned by the callback

## Type Definitions

`typedef bool (*esp_netif_find_predicate_t)(esp_netif_t *netif, void *ctx)`

Predicate callback for `esp_netif_find_if()` used to find interface which meets defined criteria.

`typedef esp_err_t (*esp_netif_callback_fn)(void *ctx)`

TCPIP thread safe callback used with `esp_netif_tcpip_exec()`

## Header File

- [components/esp\\_netif/include/esp\\_netif\\_sntp.h](#)
- This header file can be included with:

```
#include "esp_netif_sntp.h"
```

- This header file is a part of the API provided by the `esp_netif` component. To declare that your component depends on `esp_netif`, add the following to your `CMakeLists.txt`:

```
REQUIRES esp_netif
```

or

PRIV_REQUIRES esp_netif
-------------------------

## Functions

*esp\_err\_t* **esp\_netif\_sntp\_init** (const *esp\_sntp\_config\_t* \*config)

Initialize SNTP with supplied config struct.

参数 **config** -- Config struct

返回 ESP\_OK on success

*esp\_err\_t* **esp\_netif\_sntp\_start** (void)

Start SNTP service if it wasn't started during init (config.start = false) or restart it if already started.

返回 ESP\_OK on success

void **esp\_netif\_sntp\_deinit** (void)

Deinitialize esp\_netif SNTP module.

*esp\_err\_t* **esp\_netif\_sntp\_sync\_wait** (TickType\_t tout)

Wait for time sync event.

参数 **tout** -- Specified timeout in RTOS ticks

返回 ESP\_TIMEOUT if sync event didn't come within the timeout ESP\_ERR\_NOT\_FINISHED if the sync event came, but we're in smooth update mode and still in progress (SNTP\_SYNC\_STATUS\_IN\_PROGRESS) ESP\_OK if time sync'ed

*esp\_err\_t* **esp\_netif\_sntp\_reachability** (unsigned int index, unsigned int \*reachability)

Returns SNTP server's reachability shift register as described in RFC 5905.

参数

- **index** -- Index of the SERVER
- **reachability** -- reachability shift register

返回 ESP\_OK on success, ESP\_ERR\_INVALID\_STATE if SNTP not initialized  
ESP\_ERR\_INVALID\_ARG if invalid arguments

## Structures

struct **esp\_sntp\_config**

SNTP configuration struct.

### Public Members

bool **smooth\_sync**

set to true if smooth sync required

bool **server\_from\_dhcp**

set to true to request NTP server config from DHCP

bool **wait\_for\_sync**

if true, we create a semaphore to signal time sync event

bool **start**

set to true to automatically start the SNTP service

*esp\_sntp\_time\_cb\_t* **sync\_cb**

optionally sets callback function on time sync event

bool **renew\_servers\_after\_new\_IP**

this is used to refresh server list if NTP provided by DHCP (which cleans other pre-configured servers)

*ip\_event\_t* **ip\_event\_to\_renew**

set the IP event id on which we refresh server list (if `renew_servers_after_new_IP=true`)

size\_t **index\_of\_first\_server**

refresh server list after this server (if `renew_servers_after_new_IP=true`)

size\_t **num\_of\_servers**

number of preconfigured NTP servers

const char \***servers**[1]

list of servers

### Macros

**ESP\_SNTP\_SERVER\_LIST** (...)

Utility macro for providing multiple servers in parentheses.

**ESP\_NETIF\_SNTP\_DEFAULT\_CONFIG\_MULTIPLE** (servers\_in\_list, list\_of\_servers)

Default configuration to init SNTP with multiple servers.

#### 参数

- **servers\_in\_list** -- Number of servers in the list
- **list\_of\_servers** -- List of servers (use `ESP_SNTP_SERVER_LIST(...)`)

**ESP\_NETIF\_SNTP\_DEFAULT\_CONFIG** (server)

Default configuration with a single server.

### Type Definitions

typedef void (\***esp\_sntp\_time\_cb\_t**)(struct timeval \*tv)

Time sync notification function.

typedef struct *esp\_sntp\_config* **esp\_sntp\_config\_t**

SNTP configuration struct.

### Header File

- `components/esp_netif/include/esp_netif_types.h`
- This header file can be included with:

```
#include "esp_netif_types.h"
```

- This header file is a part of the API provided by the `esp_netif` component. To declare that your component depends on `esp_netif`, add the following to your `CMakeLists.txt`:

```
REQUIRES esp_netif
```

or

```
PRIV_REQUIRES esp_netif
```

## Structures

struct **esp\_netif\_dns\_info\_t**

DNS server info.

### Public Members

*esp\_ip\_addr\_t* **ip**

IPV4 address of DNS server

struct **esp\_netif\_ip\_info\_t**

Event structure for IP\_EVENT\_STA\_GOT\_IP, IP\_EVENT\_ETH\_GOT\_IP events

### Public Members

*esp\_ip4\_addr\_t* **ip**

Interface IPV4 address

*esp\_ip4\_addr\_t* **netmask**

Interface IPV4 netmask

*esp\_ip4\_addr\_t* **gw**

Interface IPV4 gateway address

struct **esp\_netif\_ip6\_info\_t**

IPV6 IP address information.

### Public Members

*esp\_ip6\_addr\_t* **ip**

Interface IPV6 address

struct **ip\_event\_got\_ip\_t**

Event structure for IP\_EVENT\_GOT\_IP event.

### Public Members

*esp\_netif\_t* \***esp\_netif**

Pointer to corresponding esp-netif object

*esp\_netif\_ip\_info\_t* **ip\_info**

IP address, netmask, gateway IP address

bool **ip\_changed**

Whether the assigned IP has changed or not

struct **ip\_event\_got\_ip6\_t**

Event structure for IP\_EVENT\_GOT\_IP6 event

### Public Members

*esp\_netif\_t* \***esp\_netif**

Pointer to corresponding esp-netif object

*esp\_netif\_ip6\_info\_t* **ip6\_info**

IPv6 address of the interface

int **ip\_index**

IPv6 address index

struct **ip\_event\_add\_ip6\_t**

Event structure for ADD\_IP6 event

### Public Members

*esp\_ip6\_addr\_t* **addr**

The address to be added to the interface

bool **preferred**

The default preference of the address

struct **ip\_event\_ap\_staipassigned\_t**

Event structure for IP\_EVENT\_AP\_STAIPASSIGNED event

### Public Members

*esp\_netif\_t* \***esp\_netif**

Pointer to the associated netif handle

*esp\_ip4\_addr\_t* **ip**

IP address which was assigned to the station

uint8\_t **mac**[6]

MAC address of the connected client

struct **bridgeif\_config**

LwIP bridge configuration

### Public Members

uint16\_t **max\_fdb\_dyn\_entries**

maximum number of entries in dynamic forwarding database

uint16\_t **max\_fdb\_sta\_entries**

maximum number of entries in static forwarding database

uint8\_t **max\_ports**

maximum number of ports the bridge can consist of

struct **esp\_netif\_inherent\_config**

ESP-netif inherent config parameters.

### Public Members

*esp\_netif\_flags\_t* **flags**

flags that define esp-netif behavior

uint8\_t **mac**[6]

initial mac address for this interface

const *esp\_netif\_ip\_info\_t* \***ip\_info**

initial ip address for this interface

uint32\_t **get\_ip\_event**

event id to be raised when interface gets an IP

uint32\_t **lost\_ip\_event**

event id to be raised when interface loses its IP

const char \***if\_key**

string identifier of the interface

const char \***if\_desc**

textual description of the interface

int **route\_prio**

numeric priority of this interface to become a default routing if (if other netifs are up). A higher value of route\_prio indicates a higher priority

*bridgeif\_config\_t* \***bridge\_info**

LwIP bridge configuration

struct **esp\_netif\_driver\_base\_s**

ESP-netif driver base handle.

### Public Members

*esp\_err\_t* (**post\_attach**)(*esp\_netif\_t* \*netif, *esp\_netif\_io\_driver\_handle* h)

post attach function pointer

*esp\_netif\_t* \***netif**

netif handle

struct **esp\_netif\_driver\_ifconfig**

Specific IO driver configuration.

### Public Members

*esp\_netif\_iodriver\_handle* **handle**

io-driver handle

*esp\_err\_t* (\***transmit**)(void \*h, void \*buffer, size\_t len)

transmit function pointer

*esp\_err\_t* (\***transmit\_wrap**)(void \*h, void \*buffer, size\_t len, void \*netstack\_buffer)

transmit wrap function pointer

void (\***driver\_free\_rx\_buffer**)(void \*h, void \*buffer)

free rx buffer function pointer

struct **esp\_netif\_config**

Generic esp\_netif configuration.

### Public Members

const *esp\_netif\_inherent\_config\_t* \***base**

base config

const *esp\_netif\_driver\_ifconfig\_t* \***driver**

driver config

const *esp\_netif\_netstack\_config\_t* \***stack**

stack config

struct **esp\_netif\_pair\_mac\_ip\_t**

DHCP client's addr info (pair of MAC and IP address)

### Public Members

uint8\_t **mac**[6]

Clients MAC address

*esp\_ip4\_addr\_t* **ip**

Clients IP address

### Macros

**ESP\_ERR\_ESP\_NETIF\_BASE**

Definition of ESP-NETIF based errors.

**ESP\_ERR\_ESP\_NETIF\_INVALID\_PARAMS**

**ESP\_ERR\_ESP\_NETIF\_IF\_NOT\_READY**

**ESP\_ERR\_ESP\_NETIF\_DHCP\_START\_FAILED**

**ESP\_ERR\_ESP\_NETIF\_DHCP\_ALREADY\_STARTED**

**ESP\_ERR\_ESP\_NETIF\_DHCP\_ALREADY\_STOPPED**

**ESP\_ERR\_ESP\_NETIF\_NO\_MEM**

**ESP\_ERR\_ESP\_NETIF\_DHCP\_NOT\_STOPPED**

**ESP\_ERR\_ESP\_NETIF\_DRIVER\_ATTACH\_FAILED**

**ESP\_ERR\_ESP\_NETIF\_INIT\_FAILED**

**ESP\_ERR\_ESP\_NETIF\_DNS\_NOT\_CONFIGURED**

**ESP\_ERR\_ESP\_NETIF\_MLD6\_FAILED**

**ESP\_ERR\_ESP\_NETIF\_IP6\_ADDR\_FAILED**

**ESP\_ERR\_ESP\_NETIF\_DHCP\_START\_FAILED**

**ESP\_NETIF\_BR\_FLOOD**

Definition of ESP-NETIF bridge controll.

**ESP\_NETIF\_BR\_DROP**

**ESP\_NETIF\_BR\_FDW\_CPU**

### Type Definitions

typedef struct esp\_netif\_obj **esp\_netif\_t**

typedef enum *esp\_netif\_flags* **esp\_netif\_flags\_t**

typedef enum *esp\_netif\_ip\_event\_type* **esp\_netif\_ip\_event\_type\_t**

typedef struct *bridgeif\_config* **bridgeif\_config\_t**

LwIP bridge configuration

typedef struct *esp\_netif\_inherent\_config* **esp\_netif\_inherent\_config\_t**

ESP-netif inherent config parameters.



typedef struct *esp\_netif\_config* **esp\_netif\_config\_t**

typedef void \***esp\_netif\_ioedriver\_handle**

IO driver handle type.

typedef struct *esp\_netif\_driver\_base\_s* **esp\_netif\_driver\_base\_t**

ESP-netif driver base handle.

typedef struct *esp\_netif\_driver\_ifconfig* **esp\_netif\_driver\_ifconfig\_t**

typedef struct *esp\_netif\_netstack\_config* **esp\_netif\_netstack\_config\_t**

Specific L3 network stack configuration.

typedef *esp\_err\_t* (\***esp\_netif\_receive\_t**)(*esp\_netif\_t* \*esp\_netif, void \*buffer, size\_t len, void \*eb)

ESP-NETIF Receive function type.

### Enumerations

enum **esp\_netif\_dns\_type\_t**

Type of DNS server.

*Values:*

enumerator **ESP\_NETIF\_DNS\_MAIN**

DNS main server address

enumerator **ESP\_NETIF\_DNS\_BACKUP**

DNS backup server address (Wi-Fi STA and Ethernet only)

enumerator **ESP\_NETIF\_DNS\_FALLBACK**

DNS fallback server address (Wi-Fi STA and Ethernet only)

enumerator **ESP\_NETIF\_DNS\_MAX**

enum **esp\_netif\_dhcp\_status\_t**

Status of DHCP client or DHCP server.

*Values:*

enumerator **ESP\_NETIF\_DHCP\_INIT**

DHCP client/server is in initial state (not yet started)

enumerator **ESP\_NETIF\_DHCP\_STARTED**

DHCP client/server has been started

enumerator **ESP\_NETIF\_DHCP\_STOPPED**

DHCP client/server has been stopped

enumerator **ESP\_NETIF\_DHCP\_STATUS\_MAX**

enum **esp\_netif\_dhcp\_option\_mode\_t**

Mode for DHCP client or DHCP server option functions.

*Values:*

enumerator **ESP\_NETIF\_OP\_START**

enumerator **ESP\_NETIF\_OP\_SET**

Set option

enumerator **ESP\_NETIF\_OP\_GET**

Get option

enumerator **ESP\_NETIF\_OP\_MAX**

enum **esp\_netif\_dhcp\_option\_id\_t**

Supported options for DHCP client or DHCP server.

*Values:*

enumerator **ESP\_NETIF\_SUBNET\_MASK**

Network mask

enumerator **ESP\_NETIF\_DOMAIN\_NAME\_SERVER**

Domain name server

enumerator **ESP\_NETIF\_ROUTER\_SOLICITATION\_ADDRESS**

Solicitation router address

enumerator **ESP\_NETIF\_REQUESTED\_IP\_ADDRESS**

Request specific IP address

enumerator **ESP\_NETIF\_IP\_ADDRESS\_LEASE\_TIME**

Request IP address lease time

enumerator **ESP\_NETIF\_IP\_REQUEST\_RETRY\_TIME**

Request IP address retry counter

enumerator **ESP\_NETIF\_VENDOR\_CLASS\_IDENTIFIER**

Vendor Class Identifier of a DHCP client

enumerator **ESP\_NETIF\_VENDOR\_SPECIFIC\_INFO**

Vendor Specific Information of a DHCP server

enum **ip\_event\_t**

IP event declarations

*Values:*

enumerator **IP\_EVENT\_STA\_GOT\_IP**

station got IP from connected AP

enumerator **IP\_EVENT\_STA\_LOST\_IP**

station lost IP and the IP is reset to 0

enumerator **IP\_EVENT\_AP\_STAIPASSIGNED**

soft-AP assign an IP to a connected station

enumerator **IP\_EVENT\_GOT\_IP6**

station or ap or ethernet interface v6IP addr is preferred

enumerator **IP\_EVENT\_ETH\_GOT\_IP**

ethernet got IP from connected AP

enumerator **IP\_EVENT\_ETH\_LOST\_IP**

ethernet lost IP and the IP is reset to 0

enumerator **IP\_EVENT\_PPP\_GOT\_IP**

PPP interface got IP

enumerator **IP\_EVENT\_PPP\_LOST\_IP**

PPP interface lost IP

enum **esp\_netif\_flags**

*Values:*

enumerator **ESP\_NETIF\_DHCP\_CLIENT**

enumerator **ESP\_NETIF\_DHCP\_SERVER**

enumerator **ESP\_NETIF\_FLAG\_AUTOUP**

enumerator **ESP\_NETIF\_FLAG\_GARP**

enumerator **ESP\_NETIF\_FLAG\_EVENT\_IP\_MODIFIED**

enumerator **ESP\_NETIF\_FLAG\_IS\_PPP**

enumerator **ESP\_NETIF\_FLAG\_IS\_BRIDGE**

enumerator **ESP\_NETIF\_FLAG\_MLDV6\_REPORT**

enum **esp\_netif\_ip\_event\_type**

*Values:*

enumerator **ESP\_NETIF\_IP\_EVENT\_GOT\_IP**

enumerator **ESP\_NETIF\_IP\_EVENT\_LOST\_IP**

## Header File

- [components/esp\\_netif/include/esp\\_netif\\_ip\\_addr.h](#)
- This header file can be included with:

```
#include "esp_netif_ip_addr.h"
```

- This header file is a part of the API provided by the `esp_netif` component. To declare that your component depends on `esp_netif`, add the following to your `CMakeLists.txt`:

```
REQUIRES esp_netif
```

or

```
PRIV_REQUIRES esp_netif
```

## Functions

*esp\_ip6\_addr\_type\_t* **esp\_netif\_ip6\_get\_addr\_type** (*esp\_ip6\_addr\_t* \*ip6\_addr)

Get the IPv6 address type.

参数 **ip6\_addr** -- [in] IPv6 type

返回 IPv6 type in form of enum `esp_ip6_addr_type_t`

static inline void **esp\_netif\_ip\_addr\_copy** (*esp\_ip\_addr\_t* \*dest, const *esp\_ip\_addr\_t* \*src)

Copy IP addresses.

参数

- **dest** -- [out] destination IP
- **src** -- [in] source IP

## Structures

struct **esp\_ip6\_addr**

IPv6 address.

### Public Members

uint32\_t **addr**[4]

IPv6 address

uint8\_t **zone**

zone ID

struct **esp\_ip4\_addr**

IPv4 address.

### Public Members

uint32\_t **addr**

IPv4 address

struct **\_ip\_addr**

IP address.

## Public Members

*esp\_ip6\_addr\_t* **ip6**

IPv6 address type

*esp\_ip4\_addr\_t* **ip4**

IPv4 address type

union *\_ip\_addr::*[anonymous] **u\_addr**

IP address union

**uint8\_t type**

ipaddress type

## Macros

**esp\_netif\_htonl** (x)

**esp\_netif\_ip4\_makeu32** (a, b, c, d)

**ESP\_IP6\_ADDR\_BLOCK1** (ip6addr)

**ESP\_IP6\_ADDR\_BLOCK2** (ip6addr)

**ESP\_IP6\_ADDR\_BLOCK3** (ip6addr)

**ESP\_IP6\_ADDR\_BLOCK4** (ip6addr)

**ESP\_IP6\_ADDR\_BLOCK5** (ip6addr)

**ESP\_IP6\_ADDR\_BLOCK6** (ip6addr)

**ESP\_IP6\_ADDR\_BLOCK7** (ip6addr)

**ESP\_IP6\_ADDR\_BLOCK8** (ip6addr)

**IPSTR**

**esp\_ip4\_addr\_get\_byte** (ipaddr, idx)

**esp\_ip4\_addr1** (ipaddr)

**esp\_ip4\_addr2** (ipaddr)

**esp\_ip4\_addr3** (ipaddr)

**esp\_ip4\_addr4** (ipaddr)

**esp\_ip4\_addr1\_16** (ipaddr)

**esp\_ip4\_addr2\_16** (ipaddr)

**esp\_ip4\_addr3\_16** (ipaddr)

**esp\_ip4\_addr4\_16** (ipaddr)

**IP2STR** (ipaddr)

**IPV6STR**

**IPV62STR** (ipaddr)

**ESP\_IPADDR\_TYPE\_V4**

**ESP\_IPADDR\_TYPE\_V6**

**ESP\_IPADDR\_TYPE\_ANY**

**ESP\_IP4TOUINT32** (a, b, c, d)

**ESP\_IP4TOADDR** (a, b, c, d)

**ESP\_IP4ADDR\_INIT** (a, b, c, d)

**ESP\_IP6ADDR\_INIT** (a, b, c, d)

**IP4ADDR\_STRLEN\_MAX**

**ESP\_IP\_IS\_ANY** (addr)

### Type Definitions

typedef struct *esp\_ip4\_addr* **esp\_ip4\_addr\_t**

typedef struct *esp\_ip6\_addr* **esp\_ip6\_addr\_t**

typedef struct *\_ip\_addr* **esp\_ip\_addr\_t**

IP address.

### Enumerations

enum **esp\_ip6\_addr\_type\_t**

*Values:*

enumerator **ESP\_IP6\_ADDR\_IS\_UNKNOWN**

enumerator **ESP\_IP6\_ADDR\_IS\_GLOBAL**

enumerator **ESP\_IP6\_ADDR\_IS\_LINK\_LOCAL**

enumerator **ESP\_IP6\_ADDR\_IS\_SITE\_LOCAL**

enumerator **ESP\_IP6\_ADDR\_IS\_UNIQUE\_LOCAL**

enumerator **ESP\_IP6\_ADDR\_IS\_IPV4\_MAPPED\_IPV6**

### Header File

- [components/esp\\_netif/include/esp\\_vfs\\_l2tap.h](#)
- This header file can be included with:

```
#include "esp_vfs_l2tap.h"
```

- This header file is a part of the API provided by the `esp_netif` component. To declare that your component depends on `esp_netif`, add the following to your `CMakeLists.txt`:

```
REQUIRES esp_netif
```

or

```
PRIV_REQUIRES esp_netif
```

## Functions

`esp_err_t esp_vfs_l2tap_intf_register` (*l2tap\_vfs\_config\_t* \*config)

Add L2 TAP virtual filesystem driver.

This function must be called prior usage of ESP-NETIF L2 TAP Interface

**参数 config** -- L2 TAP virtual filesystem driver configuration. Default base path `/dev/net/tap` is used when this parameter is NULL.

**返回** `esp_err_t`

- ESP\_OK on success

`esp_err_t esp_vfs_l2tap_intf_unregister` (const char \*base\_path)

Removes L2 TAP virtual filesystem driver.

**参数 base\_path** -- Base path to the L2 TAP virtual filesystem driver. Default path `/dev/net/tap` is used when this parameter is NULL.

**返回** `esp_err_t`

- ESP\_OK on success

`esp_err_t esp_vfs_l2tap_eth_filter` (*l2tap\_iodriver\_handle* driver\_handle, void \*buff, size\_t \*size)

Filters received Ethernet L2 frames into L2 TAP infrastructure.

**参数**

- **driver\_handle** -- handle of driver at which the frame was received
- **buff** -- received L2 frame
- **size** -- input length of the L2 frame which is set to 0 when frame is filtered into L2 TAP

**返回** `esp_err_t`

- ESP\_OK is always returned

## Structures

struct `l2tap_vfs_config_t`

L2Tap VFS config parameters.

### Public Members

const char \***base\_path**

vfs base path

## Macros

`L2TAP_VFS_DEFAULT_PATH`

`L2TAP_VFS_CONFIG_DEFAULT` ()

## Type Definitions

```
typedef void *l2tap_iodriver_handle
```

## Enumerations

```
enum l2tap_ioctl_opt_t
```

*Values:*

```
enumerator L2TAP_S_RCV_FILTER
```

```
enumerator L2TAP_G_RCV_FILTER
```

```
enumerator L2TAP_S_INTF_DEVICE
```

```
enumerator L2TAP_G_INTF_DEVICE
```

```
enumerator L2TAP_S_DEVICE_DRV_HNDL
```

```
enumerator L2TAP_G_DEVICE_DRV_HNDL
```

## 2.5.4 IP 网络层协议

### ESP-NETIF 自定义 I/O 驱动程序

本节概述了如何配置具有 ESP-NETIF 连接功能的新 I/O 驱动程序。

通常情况下，I/O 驱动程序须注册为 ESP-NETIF 驱动程序。因此，它依赖于 ESP-NETIF 组件，并负责提供数据路径函数、后附回调函数，并在多数情况下用于设置默认事件处理程序，根据驱动程序的生命周期转换来定义网络接口操作。

**数据包 Input/Output** 根据 *ESP-NETIF 架构* 章节提供的图表可以看出，须定义以下三个数据路径函数 API 以连接 ESP-NETIF：

- `esp_netif_transmit()`
- `esp_netif_free_rx_buffer()`
- `esp_netif_receive()`

前两个函数可以传输和释放 RX 缓冲区，用作回调。它们由 ESP-NETIF（及其底层 TCP/IP 堆栈）调用，并由 I/O 驱动实现。

另一方面，接收函数由 I/O 驱动程序调用，因此驱动的代码只需在接收到新数据时调用 `esp_netif_receive()` 函数。

**后附回调** 网络接口初始化的最后一步是调用以下 API，将 ESP-NETIF 实例附加到 I/O 驱动程序上：

```
esp_err_t esp_netif_attach(esp_netif_t *esp_netif, esp_netif_iodriver_handle_t
↳driver_handle);
```

假设 `esp_netif_iodriver_handle` 是指向驱动程序对象的指针，该对象是从 `struct esp_netif_driver_base_s` 衍生的结构体，那么 I/O 驱动结构体的第一个成员必须是此基础结构，并指向：



- 后附函数回调
- 相关的 ESP-NETIF 实例

因此，I/O 驱动程序须创建以下结构体的实例：

```
typedef struct my_netif_driver_s {
    esp_netif_driver_base_t base;           /*!< 保留基本结构体作为 esp_netif_
↪驱动 */
    driver_impl_t *h;                     /*!< 驱动实现 */
} my_netif_driver_t;
```

此实例中包含 `my_netif_driver_t::base.post_attach` 的真实值和实际的驱动处理程序 `my_netif_driver_t::h`。

从初始化代码调用 `esp_netif_attach()` 时，将执行 I/O 驱动程序代码的后附回调，以在 ESP-NETIF 和 I/O 驱动程序实例之间相互注册回调。通常，后附回调中也会启动驱动程序。以下为一个简单的后附回调示例：

```
static esp_err_t my_post_attach_start(esp_netif_t * esp_netif, void * args)
{
    my_netif_driver_t *driver = args;
    const esp_netif_driver_ifconfig_t driver_ifconfig = {
        .driver_free_rx_buffer = my_free_rx_buf,
        .transmit = my_transmit,
        .handle = driver->driver_impl
    };
    driver->base.netif = esp_netif;
    ESP_ERROR_CHECK(esp_netif_set_driver_config(esp_netif, &driver_ifconfig));
    my_driver_start(driver->driver_impl);
    return ESP_OK;
}
```

**默认处理程序** I/O 驱动程序通常还会根据 I/O 驱动程序的状态转换，为相关网络接口的生命周期行为提供默认定义，例如 `driver start` -> `network start` 等。

以下是此类默认处理程序的一个示例：

```
esp_err_t my_driver_netif_set_default_handlers(my_netif_driver_t *driver, esp_
↪netif_t * esp_netif)
{
    driver_set_event_handler(driver->driver_impl, esp_netif_action_start, MY_DRV_
↪EVENT_START, esp_netif);
    driver_set_event_handler(driver->driver_impl, esp_netif_action_stop, MY_DRV_
↪EVENT_STOP, esp_netif);
    return ESP_OK;
}
```

**网络堆栈连接** 用于传输和释放 RX 缓冲区的数据路径函数（在 I/O 驱动中定义）由 ESP-NETIF 的 TCP/IP 堆栈连接层调用。

注意，ESP-IDF 为最常见的网络接口（如 Wi-Fi station 或以太网）提供了几种网络堆栈配置。这些配置定义在 `esp_netif/include/esp_netif_defaults.h` 中，能够满足大多数网络驱动程序的需求。在少数情况下，一些专家用户可能希望自定义基于 lwIP 的接口层，这需要额外设置 lwIP 依赖。

以下参考 API 概述了这些网络堆栈和 ESP-NETIF 的交互：

### Header File

- `components/esp_netif/include/esp_netif_net_stack.h`
- This header file can be included with:

```
#include "esp_netif_net_stack.h"
```

- This header file is a part of the API provided by the `esp_netif` component. To declare that your component depends on `esp_netif`, add the following to your `CMakeLists.txt`:

```
REQUIRES esp_netif
```

or

```
PRIV_REQUIRES esp_netif
```

## Functions

`esp_netif_t` \***esp\_netif\_get\_handle\_from\_netif\_impl** (void \*dev)

Returns esp-netif handle.

**参数 dev** -- [in] opaque ptr to network interface of specific TCP/IP stack

**返回** handle to related esp-netif instance

void \***esp\_netif\_get\_netif\_impl** (`esp_netif_t` \*esp\_netif)

Returns network stack specific implementation handle.

**参数 esp\_netif** -- [in] Handle to esp-netif instance

**返回** handle to related network stack netif handle

`esp_err_t` **esp\_netif\_set\_link\_speed** (`esp_netif_t` \*esp\_netif, uint32\_t speed)

Set link-speed for the specified network interface.

**参数**

- **esp\_netif** -- [in] Handle to esp-netif instance
- **speed** -- [in] Link speed in bit/s

**返回** ESP\_OK on success

`esp_err_t` **esp\_netif\_transmit** (`esp_netif_t` \*esp\_netif, void \*data, size\_t len)

Outputs packets from the TCP/IP stack to the media to be transmitted.

This function gets called from network stack to output packets to IO driver.

**参数**

- **esp\_netif** -- [in] Handle to esp-netif instance
- **data** -- [in] Data to be transmitted
- **len** -- [in] Length of the data frame

**返回** ESP\_OK on success, an error passed from the I/O driver otherwise

`esp_err_t` **esp\_netif\_transmit\_wrap** (`esp_netif_t` \*esp\_netif, void \*data, size\_t len, void \*netstack\_buf)

Outputs packets from the TCP/IP stack to the media to be transmitted.

This function gets called from network stack to output packets to IO driver.

**参数**

- **esp\_netif** -- [in] Handle to esp-netif instance
- **data** -- [in] Data to be transmitted
- **len** -- [in] Length of the data frame
- **netstack\_buf** -- [in] net stack buffer

**返回** ESP\_OK on success, an error passed from the I/O driver otherwise

void **esp\_netif\_free\_rx\_buffer** (void \*esp\_netif, void \*buffer)

Free the rx buffer allocated by the media driver.

This function gets called from network stack when the rx buffer to be freed in IO driver context, i.e. to deallocate a buffer owned by io driver (when data packets were passed to higher levels to avoid copying)

**参数**

- **esp\_netif** -- [in] Handle to esp-netif instance
- **buffer** -- [in] Rx buffer pointer

TCP/IP 套接字 API 的示例代码存放在 ESP-IDF 示例项目的 `protocols/sockets` 目录下。

## 2.5.5 应用层协议

应用层网络协议（IP 网络层协议之上）的相关文档存放在 `应用层协议` 目录下。

## 2.6 外设 API

### 2.6.1 模数转换器 (ADC) 单次转换模式驱动

#### 简介

模数转换器集成于芯片，支持测量特定模拟 IO 管脚的模拟信号。

ESP32-H2 有一个 ADC 单元，可以在以下场景使用：

- 生成 ADC 单次转换结果
- 生成连续 ADC 转换结果

本指南介绍了 ADC 单次转换模式。

#### 功能概述

下文将分节概述安装和运行 ADC 的基本步骤：

- **资源分配** - 介绍获取 ADC 句柄所需设置的参数，以及如何在 ADC 完成工作后回收资源。
- **配置 ADC 单元实例** - 介绍配置 ADC 单元所需设置的参数，用于获取 ADC 转换的原始结果。
- **读取转换结果** - 介绍如何获取 ADC 转换的原始结果。
- **硬件限制** - 介绍与 ADC 相关的硬件限制。
- **电源管理** - 介绍电源管理的相关内容。
- **IRAM 安全** - 介绍在禁用 cache 时，如何读取 ADC 转换的原始结果。
- **线程安全** - 介绍由驱动程序认证为线程安全的 API。
- **Kconfig 选项** - 介绍支持的 Kconfig 选项，不同选项对驱动程序的操作会产生不同影响。

**资源分配** ADC 单次转换模式驱动基于 ESP32-H2 SAR ADC 模块实现，不同的 ESP 芯片可能拥有不同数量的独立 ADC。对于单次转换模式驱动而言，ADC 实例以 `adc_one_shot_unit_handle_t` 表示。

请设置所需的初始配置结构体 `adc_one_shot_unit_init_cfg_t` 安装 ADC 实例，具体如下：

- `adc_one_shot_unit_init_cfg_t::unit_id` 选择 ADC。请参阅 [技术规格书](#)，了解对应 ADC 的专用模拟 IO 管脚。
- `adc_one_shot_unit_init_cfg_t::clk_src` 选择 ADC 的时钟源。设置为 0 时，驱动程序将使用默认时钟源，详情请参阅 `adc_one_shot_clk_src_t`。
- `adc_one_shot_unit_init_cfg_t::ulp_mode` 设置是否支持 ADC 在 ULP 模式下工作。

完成 ADC 初始配置后，使用已设置的初始配置结构体 `adc_one_shot_unit_init_cfg_t` 调用 `adc_one_shot_new_unit()`。如果分配成功，该函数将返回 ADC 单元实例句柄。

该函数可能因参数无效、内存不足等原因返回错误代码。比如，当要分配的 ADC 实例已经注册时，该函数会返回 `ESP_ERR_NOT_FOUND` 错误。可用 ADC 数量可通过 `SOC_ADC_PERIPH_NUM` 查看。

如果不再需要先前创建的 ADC 单元实例，请调用 `adc_one_shot_del_unit()` 回收该实例，相关的硬件和软件资源也会回收。

**在普通单次转换模式下创建 ADC 单元实例句柄**

```
adc_oneshot_unit_handle_t adc1_handle;
adc_oneshot_unit_init_cfg_t init_config1 = {
    .unit_id = ADC_UNIT_1,
    .ulp_mode = ADC_ULP_MODE_DISABLE,
};
ESP_ERROR_CHECK(adc_oneshot_new_unit(&init_config1, &adc1_handle));
```

**回收 ADC 单元实例**

```
ESP_ERROR_CHECK(adc_oneshot_del_unit(adc1_handle));
```

**配置 ADC 单元实例** 创建 ADC 单元实例后，请设置 `adc_oneshot_chan_cfg_t` 配置 ADC IO 以测量模拟信号，具体如下：

- `adc_oneshot_chan_cfg_t::atten`，ADC 衰减。请参阅 [技术参考手册](#) > 片上传感器与模拟信号处理。
- `adc_oneshot_chan_cfg_t::bitwidth`，原始转换结果的位宽。

**备注：**ADC IO 及其对应的 ADC 通道编号，请参阅 [技术规格书](#)。

此外，可以使用 `adc_continuous_io_to_channel()` 和 `adc_continuous_channel_to_io()` 了解 ADC 通道和 ADC IO。

为使以上设置生效，请使用上述配置结构体调用 `adc_oneshot_config_channel()`，并指定要配置的 ADC 通道。函数 `adc_oneshot_config_channel()` 支持多次调用，以配置不同的 ADC 通道。驱动程序将在内部保存每个通道的配置。

**配置两个 ADC 通道**

```
adc_oneshot_chan_cfg_t config = {
    .bitwidth = ADC_BITWIDTH_DEFAULT,
    .atten = ADC_ATTEN_DB_12,
};
ESP_ERROR_CHECK(adc_oneshot_config_channel(adc1_handle, EXAMPLE_ADC1_CHAN0, &
↪config));
ESP_ERROR_CHECK(adc_oneshot_config_channel(adc1_handle, EXAMPLE_ADC1_CHAN1, &
↪config));
```

**读取转换结果** 完成上述配置后，ADC 即可测量来自配置好的 ADC 通道的模拟信号。调用 `adc_oneshot_read()` 可以获取 ADC 通道的原始转换结果。

- `adc_oneshot_read()` 可安全使用。ADC 由其他驱动程序/外设共享，请参阅 [硬件限制](#)。函数 `adc_oneshot_read()` 使用互斥锁，避免与其他函数同时使用硬件，因此该函数不应在 ISR 上下文中使用。当 ADC 由其他驱动程序/外设占用时，该函数可能出错，并返回 `ESP_ERR_TIMEOUT` 错误。此时，ADC 原始结果无效。

该函数可能因参数无效而调用失败。

通过该函数获取的 ADC 转换结果为原始数据。可以使用以下公式，根据 ADC 原始结果计算电压：

$$V_{out} = D_{out} * V_{max} / D_{max} \quad (1)$$

其中：

Vout	数字输出结果，代表电压。
Dout	ADC 原始数字读取结果。
Vmax	可测量的最大模拟输入电压，与 ADC 衰减相关，请参考 <a href="#">技术参考手册 &gt; 片上传感器与模拟信号处理</a> 。
Dmax	输出 ADC 原始数字读取结果的最大值，即 $2^n$ 位宽，位宽即之前配置的 <code>adc_digi_pattern_config_t::bit_width</code> 。

若需进一步校准，将 ADC 原始结果转换为以 mV 为单位的电压数据，请参考校准文档[模数转换器 \(ADC\) 校准驱动程序](#)。

### 读取原始结果

```
ESP_ERROR_CHECK(adc_one_shot_read(adc1_handle, EXAMPLE_ADC1_CHAN0, &adc_raw[0][0]));
ESP_LOGI(TAG, "ADC%d Channel[%d] Raw Data: %d", ADC_UNIT_1 + 1, EXAMPLE_ADC1_CHAN0,
→ adc_raw[0][0]);

ESP_ERROR_CHECK(adc_one_shot_read(adc1_handle, EXAMPLE_ADC1_CHAN1, &adc_raw[0][1]));
ESP_LOGI(TAG, "ADC%d Channel[%d] Raw Data: %d", ADC_UNIT_1 + 1, EXAMPLE_ADC1_CHAN1,
→ adc_raw[0][1]);
```

### 硬件限制

- 随机数生成器 (RNG) 以 ADC 为输入源。使用 ADC 单次转换模式驱动从 RNG 生成随机数时，随机性会减弱。
- 一个 ADC 单元每次只能在一种操作模式下运行，可以是连续模式或单次模式。`adc_one_shot_start()` 提供了保护措施。

**电源管理** 启用电源管理，即启用 `CONFIG_PM_ENABLE` 时，系统在空闲状态下可能会调整系统时钟频率。然而，ADC 单次转换模式驱动以轮询例程运行，`adc_one_shot_read()` 会不断检查 CPU 是否完成读取，直到函数返回。在此期间，ADC 单次转换模式驱动程序所在的任务不会受阻塞。因此，在读取时时钟频率保持稳定。

**IRAM 安全** flash 写入/擦除、OTA 等原因都可能导致 cache 禁用，此时，默认不应运行任何 ADC 单次转换模式驱动 API。如果在禁用 cache 时执行了 ADC 单次转换模式驱动 API，可能会出现类似 `Illegal Instruction` 或 `Load/Store Prohibited` 的错误。

### 线程安全

- `adc_one_shot_new_unit()`
- `adc_one_shot_config_channel()`
- `adc_one_shot_read()`

上述函数均为线程安全，使用时，可以直接从不同的 RTOS 任务中调用以上函数，无需额外锁保护。

- `adc_one_shot_del_unit()` 非线程安全。此外，与上文中线程安全的函数一起调用该函数时，可能导致线程安全函数的调用出错。

### Kconfig 选项

- `CONFIG_ADC_ONESHOT_CTRL_FUNC_IN_IRAM` 决定了放置 ADC 快速读取函数的位置，即 IRAM 或 flash 中，详情请参阅 [IRAM 安全](#)。

### 应用示例

- ADC 单次转换模式示例：[peripherals/adc/one\\_shot\\_read](#)。

## API 参考

### Header File

- [components/hal/include/hal/adc\\_types.h](#)
- This header file can be included with:

```
#include "hal/adc_types.h"
```

### Structures

struct **adc\_digi\_pattern\_config\_t**  
ADC digital controller pattern configuration.

#### Public Members

uint8\_t **atten**  
Attenuation of this ADC channel.

uint8\_t **channel**  
ADC channel.

uint8\_t **unit**  
ADC unit.

uint8\_t **bit\_width**  
ADC output bit width.

struct **adc\_digi\_output\_data\_t**  
ADC digital controller (DMA mode) output data format. Used to analyze the acquired ADC (DMA) data.

#### Public Members

uint32\_t **data**  
ADC real output data info. Resolution: 12 bit.

uint32\_t **reserved12**  
Reserved12.

uint32\_t **channel**  
ADC channel index info. If (channel < ADC\_CHANNEL\_MAX), The data is valid. If (channel > ADC\_CHANNEL\_MAX), The data is invalid.

uint32\_t **reserved17\_31**  
Reserved 17-31.

struct *adc\_digi\_output\_data\_t*::[anonymous]::[anonymous] **type2**  
When the configured output format is 12bit.

uint32\_t **val**  
Raw data value

## Type Definitions

typedef *soc\_periph\_adc\_digi\_clk\_src\_t* **adc\_oneshot\_clk\_src\_t**

Clock source type of oneshot mode which uses digital controller.

typedef *soc\_periph\_adc\_digi\_clk\_src\_t* **adc\_continuous\_clk\_src\_t**

Clock source type of continuous mode which uses digital controller.

## Enumerations

enum **adc\_unit\_t**

ADC unit.

*Values:*

enumerator **ADC\_UNIT\_1**

SAR ADC 1.

enumerator **ADC\_UNIT\_2**

SAR ADC 2.

enum **adc\_channel\_t**

ADC channels.

*Values:*

enumerator **ADC\_CHANNEL\_0**

ADC channel.

enumerator **ADC\_CHANNEL\_1**

ADC channel.

enumerator **ADC\_CHANNEL\_2**

ADC channel.

enumerator **ADC\_CHANNEL\_3**

ADC channel.

enumerator **ADC\_CHANNEL\_4**

ADC channel.

enumerator **ADC\_CHANNEL\_5**

ADC channel.

enumerator **ADC\_CHANNEL\_6**

ADC channel.

enumerator **ADC\_CHANNEL\_7**

ADC channel.

enumerator **ADC\_CHANNEL\_8**

ADC channel.

enumerator **ADC\_CHANNEL\_9**

ADC channel.

enum **adc\_atten\_t**

ADC attenuation parameter. Different parameters determine the range of the ADC.

*Values:*

enumerator **ADC\_ATTEN\_DB\_0**

No input attenuation, ADC can measure up to approx.

enumerator **ADC\_ATTEN\_DB\_2\_5**

The input voltage of ADC will be attenuated extending the range of measurement by about 2.5 dB.

enumerator **ADC\_ATTEN\_DB\_6**

The input voltage of ADC will be attenuated extending the range of measurement by about 6 dB.

enumerator **ADC\_ATTEN\_DB\_12**

The input voltage of ADC will be attenuated extending the range of measurement by about 12 dB.

enumerator **ADC\_ATTEN\_DB\_11**

This is deprecated, it behaves the same as **ADC\_ATTEN\_DB\_12**

enum **adc\_bitwidth\_t**

*Values:*

enumerator **ADC\_BITWIDTH\_DEFAULT**

Default ADC output bits, max supported width will be selected.

enumerator **ADC\_BITWIDTH\_9**

ADC output width is 9Bit.

enumerator **ADC\_BITWIDTH\_10**

ADC output width is 10Bit.

enumerator **ADC\_BITWIDTH\_11**

ADC output width is 11Bit.

enumerator **ADC\_BITWIDTH\_12**

ADC output width is 12Bit.

enumerator **ADC\_BITWIDTH\_13**

ADC output width is 13Bit.

enum **adc\_ulp\_mode\_t**

*Values:*

enumerator **ADC\_ULP\_MODE\_DISABLE**

ADC ULP mode is disabled.



enumerator **ADC\_ULP\_MODE\_FSM**

ADC is controlled by ULP FSM.

enumerator **ADC\_ULP\_MODE\_RISCV**

ADC is controlled by ULP RISCV.

enum **adc\_digi\_convert\_mode\_t**

ADC digital controller (DMA mode) work mode.

*Values:*

enumerator **ADC\_CONV\_SINGLE\_UNIT\_1**

Only use ADC1 for conversion.

enumerator **ADC\_CONV\_SINGLE\_UNIT\_2**

Only use ADC2 for conversion.

enumerator **ADC\_CONV\_BOTH\_UNIT**

Use Both ADC1 and ADC2 for conversion simultaneously.

enumerator **ADC\_CONV\_ALTER\_UNIT**

Use both ADC1 and ADC2 for conversion by turn. e.g. ADC1 -> ADC2 -> ADC1 -> ADC2 .....

enum **adc\_digi\_output\_format\_t**

ADC digital controller (DMA mode) output data format option.

*Values:*

enumerator **ADC\_DIGI\_OUTPUT\_FORMAT\_TYPE1**

See `adc_digi_output_data_t.type1`

enumerator **ADC\_DIGI\_OUTPUT\_FORMAT\_TYPE2**

See `adc_digi_output_data_t.type2`

enum **adc\_digi\_iir\_filter\_t**

ADC IIR Filter ID.

*Values:*

enumerator **ADC\_DIGI\_IIR\_FILTER\_0**

Filter 0.

enumerator **ADC\_DIGI\_IIR\_FILTER\_1**

Filter 1.

enum **adc\_digi\_iir\_filter\_coeff\_t**

IIR Filter Coefficient.

*Values:*

enumerator **ADC\_DIGI\_IIR\_FILTER\_COEFF\_2**

The filter coefficient is 2.

enumerator **ADC\_DIGI\_IIR\_FILTER\_COEFF\_4**

The filter coefficient is 4.

enumerator **ADC\_DIGI\_IIR\_FILTER\_COEFF\_8**

The filter coefficient is 8.

enumerator **ADC\_DIGI\_IIR\_FILTER\_COEFF\_16**

The filter coefficient is 16.

enumerator **ADC\_DIGI\_IIR\_FILTER\_COEFF\_64**

The filter coefficient is 64.

enum **adc\_monitor\_id\_t**

ADC monitor (continuous mode) ID.

*Values:*

enumerator **ADC\_MONITOR\_0**

The monitor index 0.

enumerator **ADC\_MONITOR\_1**

The monitor index 1.

enum **adc\_monitor\_mode\_t**

Monitor config/event mode type.

*Values:*

enumerator **ADC\_MONITOR\_MODE\_HIGH**

ADC raw\_result > threshold value, monitor interrupt will be generated.

enumerator **ADC\_MONITOR\_MODE\_LOW**

ADC raw\_result < threshold value, monitor interrupt will be generated.

### Header File

- [components/esp\\_adc/include/esp\\_adc/adc\\_oneshot.h](#)
- This header file can be included with:

```
#include "esp_adc/adc_oneshot.h"
```

- This header file is a part of the API provided by the `esp_adc` component. To declare that your component depends on `esp_adc`, add the following to your `CMakeLists.txt`:

```
REQUIRES esp_adc
```

or

```
PRIV_REQUIRES esp_adc
```

### Functions

---

```
esp_err_t adc_oneshot_new_unit (const adc_oneshot_unit_init_cfg_t *init_config,
                                adc_oneshot_unit_handle_t *ret_unit)
```

Create a handle to a specific ADC unit.

---

**备注:** This API is thread-safe. For more details, see ADC programming guide

---

#### 参数

- **init\_config** -- [in] Driver initial configurations
- **ret\_unit** -- [out] ADC unit handle

#### 返回

- ESP\_OK: On success
- ESP\_ERR\_INVALID\_ARG: Invalid arguments
- ESP\_ERR\_NO\_MEM: No memory
- ESP\_ERR\_NOT\_FOUND: The ADC peripheral to be claimed is already in use
- ESP\_FAIL: Clock source isn't initialised correctly

```
esp_err_t adc_oneshot_config_channel (adc_oneshot_unit_handle_t handle, adc_channel_t channel,
                                       const adc_oneshot_chan_cfg_t *config)
```

Set ADC oneshot mode required configurations.

---

**备注:** This API is thread-safe. For more details, see ADC programming guide

---

#### 参数

- **handle** -- [in] ADC handle
- **channel** -- [in] ADC channel to be configured
- **config** -- [in] ADC configurations

#### 返回

- ESP\_OK: On success
- ESP\_ERR\_INVALID\_ARG: Invalid arguments

```
esp_err_t adc_oneshot_read (adc_oneshot_unit_handle_t handle, adc_channel_t chan, int *out_raw)
```

Get one ADC conversion raw result.

---

**备注:** This API is thread-safe. For more details, see ADC programming guide

---



---

**备注:** This API should NOT be called in an ISR context

---

#### 参数

- **handle** -- [in] ADC handle
- **chan** -- [in] ADC channel
- **out\_raw** -- [out] ADC conversion raw result

#### 返回

- ESP\_OK: On success
- ESP\_ERR\_INVALID\_ARG: Invalid arguments
- ESP\_ERR\_TIMEOUT: Timeout, the ADC result is invalid

```
esp_err_t adc_oneshot_del_unit (adc_oneshot_unit_handle_t handle)
```

Delete the ADC unit handle.

---

**备注:** This API is thread-safe. For more details, see ADC programming guide

---

参数 **handle** -- **[in]** ADC handle  
 返回

- ESP\_OK: On success
- ESP\_ERR\_INVALID\_ARG: Invalid arguments
- ESP\_ERR\_NOT\_FOUND: The ADC peripheral to be disclaimed isn't in use

*esp\_err\_t* **adc\_oneshot\_io\_to\_channel** (int io\_num, *adc\_unit\_t* \*const unit\_id, *adc\_channel\_t* \*const channel)

Get ADC channel from the given GPIO number.

参数

- **io\_num** -- **[in]** GPIO number
- **unit\_id** -- **[out]** ADC unit
- **channel** -- **[out]** ADC channel

返回

- ESP\_OK: On success
- ESP\_ERR\_INVALID\_ARG: Invalid argument
- ESP\_ERR\_NOT\_FOUND: The IO is not a valid ADC pad

*esp\_err\_t* **adc\_oneshot\_channel\_to\_io** (*adc\_unit\_t* unit\_id, *adc\_channel\_t* channel, int \*const io\_num)

Get GPIO number from the given ADC channel.

参数

- **unit\_id** -- **[in]** ADC unit
- **channel** -- **[in]** ADC channel
- **io\_num** -- **[out]** GPIO number
- -- ESP\_OK: On success
- -- ESP\_ERR\_INVALID\_ARG: Invalid argument

*esp\_err\_t* **adc\_oneshot\_get\_calibrated\_result** (*adc\_oneshot\_unit\_handle\_t* handle, *adc\_cali\_handle\_t* cali\_handle, *adc\_channel\_t* chan, int \*cali\_result)

Convenience function to get ADC calibrated result.

This is an all-in-one function which does:

- oneshot read ADC raw result
- calibrate the raw result and convert it into calibrated result (in mV)

参数

- **handle** -- **[in]** ADC oneshot handle, you should call `adc_oneshot_new_unit()` to get this handle
- **cali\_handle** -- **[in]** ADC calibration handle, you should call `adc_cali_create_scheme_x()` in `adc_cali_scheme.h` to create a handle
- **chan** -- **[in]** ADC channel
- **cali\_result** -- **[out]** Calibrated ADC result (in mV)

返回

- ESP\_OK Other return errors from `adc_oneshot_read()` and `adc_cali_raw_to_voltage()`

## Structures

struct **adc\_oneshot\_unit\_init\_cfg\_t**  
 ADC oneshot driver initial configurations.

## Public Members

*adc\_unit\_t* **unit\_id**  
 ADC unit.

`adc_oneshot_clk_src_t clk_src`

Clock source.

`adc_ulp_mode_t ulp_mode`

ADC controlled by ULP, see `adc_ulp_mode_t`

struct `adc_oneshot_chan_cfg_t`

ADC channel configurations.

### Public Members

`adc_atten_t atten`

ADC attenuation.

`adc_bitwidth_t bitwidth`

ADC conversion result bits.

### Type Definitions

typedef struct `adc_oneshot_unit_ctx_t` \*`adc_oneshot_unit_handle_t`

Type of ADC unit handle for oneshot mode.

## 2.6.2 模数转换器 (ADC) 连续转换模式驱动

### 简介

ESP32-H2 芯片集成了模数转换器 (ADC)，支持测量特定模拟 IO 管脚的模拟信号。此外，ADC 还支持直接内存访问 (DMA) 功能，高效获取 ADC 转换结果。

ESP32-H2 具有一个 ADC 单元，可应用于以下场景：

- 生成单次 ADC 转换结果
- 生成连续 ADC 转换结果

本指南介绍了 ADC 连续转换模式。

**ADC 连续转换模式驱动概念** ADC 连续转换模式驱动由多个转换帧组成。

- 转换帧：一个转换帧包含多个转换结果。转换帧大小以字节为单位，在 `adc_continuous_new_handle()` 中配置。
- 转换结果：一个转换结果包含多个字节，即 `SOC_ADC_DIGI_RESULT_BYTES`。转换结果的数据结构由 `adc_digi_output_data_t` 定义，包括 ADC 单元、ADC 通道以及原始数据。

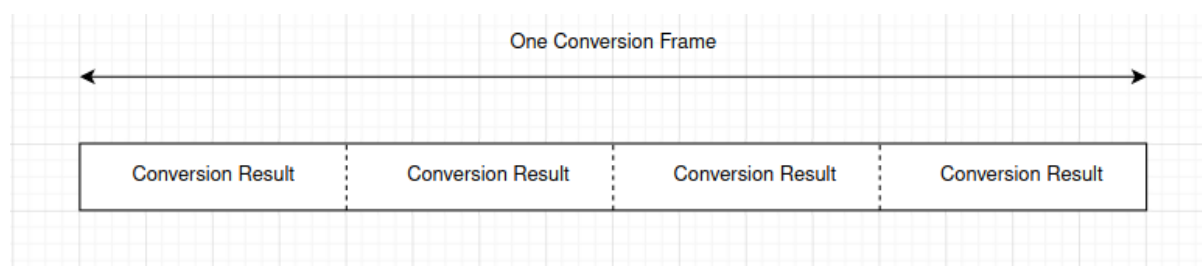

## 功能概述

下文将分节概述安装 ADC 连续转换模式驱动、并从一组 ADC 通道连续读取 ADC 转换结果的基本步骤：

- **资源分配**：介绍初始化 ADC 连续转换模式驱动所需设置的参数，以及如何将驱动去初始化。
- **配置 ADC**：介绍如何将 ADC 配置为在连续转换模式下工作。
- **ADC 控制**：介绍 ADC 控制函数。
- **注册事件回调**：介绍如何将特定用户代码链接到 ADC 连续转换模式事件回调函数。
- **读取转换结果**：介绍如何获取 ADC 转换结果。
- **硬件限制**：介绍与 ADC 相关的硬件限制。
- **电源管理**：介绍电源管理的相关内容。
- **IRAM 安全**：介绍与 IRAM 安全相关的函数。
- **线程安全**：介绍由驱动程序认证为线程安全的 API。

**资源分配** ADC 连续转换模式驱动基于 ESP32-H2 SAR ADC 模块实现，不同的 ESP 目标芯片可能拥有不同数量的独立 ADC。

请按照以下步骤设置配置结构体 `adc_continuous_handle_cfg_t`，创建 ADC 连续转换模式驱动的句柄：

- `adc_continuous_handle_cfg_t::max_store_buf_size`：以字节为单位设置最大缓冲池的大小，驱动程序将 ADC 转换结果保存到该缓冲池中。缓冲池已满时，新的转换将丢失。
- `adc_continuous_handle_cfg_t::conv_frame_size`：以字节为单位设置 ADC 转换帧大小。
- `adc_continuous_handle_cfg_t::flags`：设置可以改变驱动程序行为的标志。
  - `flush_pool`：缓冲池满时自动清空缓冲池。

完成以上 ADC 配置后，使用已设置的配置结构体 `adc_continuous_handle_cfg_t` 调用 `adc_continuous_new_handle()`。该函数可能将在特定情况下返回错误值，如无效参数、内存不足等。

函数返回 `ESP_ERR_NOT_FOUND` 时，表明 GDMA 空闲通道不足。

如果不再使用 ADC 连续转换模式驱动，请调用 `adc_continuous_deinit()` 将驱动去初始化。

**IIR 滤波器** ADC 连续转换模式下支持使用两个 IIR 滤波器。请设置 `adc_continuous_iir_filter_config_t` 结构体并调用 `adc_new_continuous_iir_filter()`，以创建 ADC IIR 滤波器。

- `adc_digi_filter_config_t::unit`：ADC 单元。
- `adc_digi_filter_config_t::channel`：将进行滤波的 ADC 通道。
- `adc_digi_filter_config_t::coeff`：滤波器系数。

调用 `adc_del_continuous_iir_filter()` 可以回收滤波器。

---

**备注：** 在一个 ADC 通道上同时使用两个滤波器时，只有第一个滤波器会生效。

---

**监视器** 当 ADC 在连续转换模式下运行时，支持使用 2 个监视器。你可以在运行中的 ADC 通道上设置一到两个监视器阈值，一旦转换结果超出阈值，监视器将在每个采样循环中触发中断。请设置 `adc_monitor_config_t`，并调用 `adc_new_continuous_monitor()` 以创建 ADC 监视器。

- `adc_monitor_config_t::adc_unit`：配置要监视的 ADC 通道所属的 ADC 单元。
- `adc_monitor_config_t::channel`：要监视的 ADC 通道。
- `adc_monitor_config_t::h_threshold`：高阈值，转换结果大于此值将触发中断，如果不使用此阈值，则将其设置为 -1。
- `adc_monitor_config_t::l_threshold`：低阈值，转换结果小于此值将触发中断，如果不使用此阈值，则将其设置为 -1。

创建监视器后，可以使用以下 API 操作监视器，构建你的应用程序。

- `adc_continuous_monitor_enable()`: 启用监视器。
- `adc_continuous_monitor_disable()`: 禁用监视器。
- `adc_monitor_register_callbacks()`: 注册用户回调函数, 在 ADC 转换结果超出阈值时, 执行相应操作。
- `adc_del_continuous_monitor()`: 删除监视器, 释放资源。

### 初始化 ADC 连续转换模式驱动

```
adc_continuous_handle_cfg_t adc_config = {
    .max_store_buf_size = 1024,
    .conv_frame_size = 100,
};
ESP_ERROR_CHECK(adc_continuous_new_handle(&adc_config));
```

### 回收 ADC 单元

```
ESP_ERROR_CHECK(adc_continuous_deinit());
```

**配置 ADC** 初始化 ADC 连续转换模式驱动后, 设置 `adc_continuous_config_t` 配置 ADC IO, 测量模拟信号:

- `adc_continuous_config_t::pattern_num`: 要使用的 ADC 通道数量。
- `adc_continuous_config_t::adc_pattern`: 每个要使用的 ADC 通道的配置列表, 请参阅下文描述。
- `adc_continuous_config_t::sample_freq_hz`: 期望的 ADC 采样频率, 单位为 Hz。
- `adc_continuous_config_t::conv_mode`: 连续转换模式。
- `adc_continuous_config_t::format`: 转换模式结果的输出格式。

按照以下步骤设置 `adc_digi_pattern_config_t`:

- `adc_digi_pattern_config_t::atten`: ADC 衰减。请参阅 [技术参考手册](#) 中的片上传感器与模拟信号处理章节。
- `adc_digi_pattern_config_t::channel`: IO 对应的 ADC 通道号, 请参阅下文注意事项。
- `adc_digi_pattern_config_t::unit`: IO 所属的 ADC 单元。
- `adc_digi_pattern_config_t::bit_width`: 原始转换结果的位宽。

**备注:** 对于 IO 对应的 ADC 通道号, 请参阅 [技术参考手册](#) 获取 ADC IO 管脚的详细信息。另外, 可以使用 `adc_continuous_io_to_channel()` 和 `adc_continuous_channel_to_io()` 获取 ADC 通道和 ADC IO 的对应关系。

为使这些设置生效, 请使用上述配置结构体, 调用 `adc_continuous_config()`。此 API 可能由于 `ESP_ERR_INVALID_ARG` 等原因返回错误。当它返回 `ESP_ERR_INVALID_STATE` 时, 意味着 ADC 连续转换模式驱动已经启动, 此时不应调用此 API。

请参考 ADC 连续转换模式示例 [peripherals/adc/continuous\\_read](#), 查看相应配置代码。

请调用 `adc_continuous_iir_filter_enable()` 或 `adc_continuous_iir_filter_disable()`, 以启用或禁用 ADC IIR 滤波器。

请调用 `adc_continuous_monitor_enable()` 或 `adc_continuous_monitor_disable()`, 以启用或禁用 ADC 监视器。

### ADC 控制

**启动和停止** 调用 `adc_continuous_start()`, 将使 ADC 开始从配置好的 ADC 通道测量模拟信号, 并生成转换结果。

相反, 调用 `adc_continuous_stop()` 则会停止 ADC 转换。



```
ESP_ERROR_CHECK(adc_continuous_stop());
```

**注册事件回调** 调用 `adc_continuous_register_event_callbacks()`，可以将自己的函数链接到驱动程序的 ISR 中。通过 `adc_continuous_evt_cbs_t` 可查看所有支持的事件回调。

- `adc_continuous_evt_cbs_t::on_conv_done`: 当一个转换帧完成时，触发此事件。
- `adc_continuous_evt_cbs_t::on_pool_ovf`: 当内部缓冲池已满时，触发此事件，新的转换结果将丢失。

由于上述回调函数在 ISR 中调用，请确保回调函数适合在 ISR 上下文中运行，且这些回调不应涉及阻塞逻辑。回调函数的原型在 `adc_continuous_callback_t` 中声明。

在调用 `adc_continuous_register_event_callbacks()` 时，还可以通过参数 `user_data` 注册自己的上下文，该用户数据将直接传递给回调函数。

此回调函数可能由于 `ESP_ERR_INVALID_ARG` 等原因返回错误。启用 `CONFIG_ADC_CONTINUOUS_ISR_IRAM_SAFE` 时，如果回调函数失败并报错，可能是因为回调函数不在内部 RAM 中，请查看错误日志了解详情。此外，如果回调函数出现 `ESP_ERR_INVALID_STATE` 错误，表明 ADC 连续转换模式驱动已经启动，此时不应添加回调。

**转换完成事件** 当驱动程序完成一次转换后，会触发 `adc_continuous_evt_cbs_t::on_conv_done` 事件，并填充事件数据。事件数据包含一个指向转换帧缓冲区的指针，以及转换帧缓冲区大小。要了解事件数据结构，请参阅 `adc_continuous_evt_data_t`。

**备注:** 注意，数据缓冲区 `adc_continuous_evt_data_t::conv_frame_buffer` 由驱动程序本身维护，请勿释放此内存。

**备注:** 启用 Kconfig 选项 `CONFIG_ADC_CONTINUOUS_ISR_IRAM_SAFE` 时，注册的回调函数以及回调函数中调用的函数应放置在 IRAM 中，涉及的变量也应放置在内部 RAM 中。

**缓冲池溢出事件** ADC 连续转换模式驱动使用内部缓冲池保存转换结果，缓冲池满时将发生缓冲池溢出事件。此时，驱动程序不会继续填充事件数据。缓冲池溢出通常是因为调用 `adc_continuous_read()` 从池中读取数据的速度远低于 ADC 转换的速度。

**读取转换结果** 调用 `adc_continuous_start()` 启动 ADC 连续转换，调用 `adc_continuous_read()` 可以获取 ADC 通道的转换结果。注意提供缓冲区，获取原始结果。

函数 `adc_continuous_read()` 每次都会尝试以期望长度读取转换结果。

- 调用 `adc_continuous_read()` 可以请求读取指定长度的转换结果。但有时实际可用的转换结果可能少于请求长度，此时，函数仍会将数据从内部池移动到你提供的缓冲区中。因此，请查看 `out_length` 的值，了解实际移动到缓冲区中的转换结果数量。
- 如果内部池中生成转换结果，函数将会阻塞一段时间，即 `timeout_ms`，直到转换结果生成。如果始终没有转换结果生成，函数将返回 `ESP_ERR_TIMEOUT`。
- 如果 ADC 连续转换生成的结果填满了内部池，新产生的结果将丢失。下次调用 `adc_continuous_read()` 时，将返回 `ESP_ERR_INVALID_STATE`，提示此情况发生。

此 API 提供了一个读取所有 ADC 连续转换结果的机会。

从上述函数读取的 ADC 转换结果为原始数据。要根据 ADC 原始结果计算电压，可以使用以下公式：

$$V_{out} = D_{out} * V_{max} / D_{max} \quad (1)$$



其中：

Vout	数据输出结果，代表电压。
Dout	ADC 原始数据读取结果。
Vmax	可测量的最大模拟输入电压，与 ADC 衰减相关，请参考 <a href="#">技术参考手册</a> 中的片上传感器与模拟信号处理章节。
Dmax	输出 ADC 原始数据读取结果的最大值，即 $2^N$ 位宽，位宽即之前配置的 <code>adc_digi_pattern_config_t::bit_width</code> 。

若需进一步校准，将 ADC 原始结果转换为以 mV 为单位的电压数据，请参考 [模数转换器 \(ADC\) 校准驱动程序](#)。

### 硬件限制

- 一个 ADC 单元一次只能运行一种操作模式，即连续模式或单次模式。`adc_continuous_start()` 提供了保护措施。
- 随机数生成器 (RNG) 以 ADC 为输入源。使用 ADC 连续转换模式驱动从 RNG 生成随机数时，随机性会减弱。

**电源管理** 启用电源管理，即启用 `CONFIG_PM_ENABLE` 时，系统在空闲状态下，可能会调整 APB 时钟频率，这可能会改变 ADC 连续转换的行为。

然而，通过获取类型为 `ESP_PM_APB_FREQ_MAX` 的电源管理锁，ADC 连续转换模式驱动可以阻止这种改变。调用 `adc_continuous_start()` 启动连续转换后即可获取该锁。同样，调用 `adc_continuous_stop()` 停止转换后将释放该锁。因此，必须确保 `adc_continuous_start()` 和 `adc_continuous_stop()` 成对出现，否则电源管理将失效。

**IRAM 安全** ADC 连续转换模式驱动的所有 API 均非 IRAM 安全。禁用 cache 时，不应运行这类 API。启用 Kconfig 选项 `CONFIG_ADC_CONTINUOUS_ISR_IRAM_SAFE` 可确保驱动的内部 ISR 处理程序为 IRAM 安全，此时即使禁用 cache，驱动仍然会将转换结果保存到其内部缓冲池中。

**线程安全** ADC 连续转换模式驱动的 API 不一定线程安全，但驱动程序提供了共享硬件互斥，详情请参阅 [硬件限制](#)。

### 应用示例

- ADC 连续转换模式示例：[peripherals/adc/continuous\\_read](#)。

### API 参考

#### Header File

- `components/esp_adc/include/esp_adc/adc_continuous.h`
- This header file can be included with:

```
#include "esp_adc/adc_continuous.h"
```

- This header file is a part of the API provided by the `esp_adc` component. To declare that your component depends on `esp_adc`, add the following to your `CMakeLists.txt`:

```
REQUIRES esp_adc
```

or

```
PRIV_REQUIRES esp_adc
```

**Functions**

*esp\_err\_t* **adc\_continuous\_new\_handle** (const *adc\_continuous\_handle\_cfg\_t* \*hdl\_config, *adc\_continuous\_handle\_t* \*ret\_handle)

Initialize ADC continuous driver and get a handle to it.

**参数**

- **hdl\_config** -- [in] Pointer to ADC initialization config. Refer to *adc\_continuous\_handle\_cfg\_t*.
- **ret\_handle** -- [out] ADC continuous mode driver handle

**返回**

- ESP\_ERR\_INVALID\_ARG If the combination of arguments is invalid.
- ESP\_ERR\_NOT\_FOUND No free interrupt found with the specified flags
- ESP\_ERR\_NO\_MEM If out of memory
- ESP\_OK On success

*esp\_err\_t* **adc\_continuous\_config** (*adc\_continuous\_handle\_t* handle, const *adc\_continuous\_config\_t* \*config)

Set ADC continuous mode required configurations.

**参数**

- **handle** -- [in] ADC continuous mode driver handle
- **config** -- [in] Refer to *adc\_digi\_config\_t*.

**返回**

- ESP\_ERR\_INVALID\_STATE: Driver state is invalid, you shouldn't call this API at this moment
- ESP\_ERR\_INVALID\_ARG: If the combination of arguments is invalid.
- ESP\_OK: On success

*esp\_err\_t* **adc\_continuous\_register\_event\_callbacks** (*adc\_continuous\_handle\_t* handle, const *adc\_continuous\_evt\_cbs\_t* \*cbs, void \*user\_data)

Register callbacks.

---

**备注:** User can deregister a previously registered callback by calling this function and setting the to-be-deregistered callback member in the *cbs* structure to NULL.

---



---

**备注:** When CONFIG\_ADC\_CONTINUOUS\_ISR\_IRAM\_SAFE is enabled, the callback itself and functions called by it should be placed in IRAM. Involved variables (including *user\_data*) should be in internal RAM as well.

---



---

**备注:** You should only call this API when the ADC continuous mode driver isn't started. Check return value to know this.

---

**参数**

- **handle** -- [in] ADC continuous mode driver handle
- **cbs** -- [in] Group of callback functions
- **user\_data** -- [in] User data, which will be delivered to the callback functions directly

**返回**

- ESP\_OK: On success
- ESP\_ERR\_INVALID\_ARG: Invalid arguments
- ESP\_ERR\_INVALID\_STATE: Driver state is invalid, you shouldn't call this API at this moment

*esp\_err\_t* **adc\_continuous\_start** (*adc\_continuous\_handle\_t* handle)

Start the ADC under continuous mode. After this, the hardware starts working.

**参数** **handle** -- [in] ADC continuous mode driver handle  
**返回**

- ESP\_ERR\_INVALID\_STATE Driver state is invalid.
- ESP\_OK On success

*esp\_err\_t* **adc\_continuous\_read** (*adc\_continuous\_handle\_t* handle, uint8\_t \*buf, uint32\_t length\_max, uint32\_t \*out\_length, uint32\_t timeout\_ms)

Read bytes from ADC under continuous mode.

**参数**

- **handle** -- [in] ADC continuous mode driver handle
- **buf** -- [out] Conversion result buffer to read from ADC. Suggest convert to *adc\_digi\_output\_data\_t* for ADC Conversion Results. See the subsection *Driver Backgrounds* in this header file to learn about this concept.
- **length\_max** -- [in] Expected length of the Conversion Results read from the ADC, in bytes.
- **out\_length** -- [out] Real length of the Conversion Results read from the ADC via this API, in bytes.
- **timeout\_ms** -- [in] Time to wait for data via this API, in millisecond.

**返回**

- ESP\_ERR\_INVALID\_STATE Driver state is invalid. Usually it means the ADC sampling rate is faster than the task processing rate.
- ESP\_ERR\_TIMEOUT Operation timed out
- ESP\_OK On success

*esp\_err\_t* **adc\_continuous\_stop** (*adc\_continuous\_handle\_t* handle)

Stop the ADC. After this, the hardware stops working.

**参数** **handle** -- [in] ADC continuous mode driver handle  
**返回**

- ESP\_ERR\_INVALID\_STATE Driver state is invalid.
- ESP\_OK On success

*esp\_err\_t* **adc\_continuous\_deinit** (*adc\_continuous\_handle\_t* handle)

Deinitialize the ADC continuous driver.

**参数** **handle** -- [in] ADC continuous mode driver handle  
**返回**

- ESP\_ERR\_INVALID\_STATE Driver state is invalid.
- ESP\_OK On success

*esp\_err\_t* **adc\_continuous\_flush\_pool** (*adc\_continuous\_handle\_t* handle)

Flush the driver internal pool.

---

**备注:** This API is not supposed to be called in an ISR context

---

**参数** **handle** -- [in] ADC continuous mode driver handle  
**返回**

- ESP\_ERR\_INVALID\_STATE Driver state is invalid, you should call this API when it's in init state
- ESP\_ERR\_INVALID\_ARG: Invalid arguments
- ESP\_OK On success

*esp\_err\_t* **adc\_continuous\_io\_to\_channel** (int io\_num, *adc\_unit\_t* \*const unit\_id, *adc\_channel\_t* \*const channel)

Get ADC channel from the given GPIO number.

**参数**

- **io\_num** -- [in] GPIO number

- **unit\_id** -- [out] ADC unit
- **channel** -- [out] ADC channel

**返回**

- ESP\_OK: On success
- ESP\_ERR\_INVALID\_ARG: Invalid argument
- ESP\_ERR\_NOT\_FOUND: The IO is not a valid ADC pad

*esp\_err\_t* **adc\_continuous\_channel\_to\_io** (*adc\_unit\_t* unit\_id, *adc\_channel\_t* channel, int \*const io\_num)

Get GPIO number from the given ADC channel.

**参数**

- **unit\_id** -- [in] ADC unit
- **channel** -- [in] ADC channel
- **io\_num** -- [out] GPIO number
- -- ESP\_OK: On success
- ESP\_ERR\_INVALID\_ARG: Invalid argument

**Structures**

struct **adc\_continuous\_handle\_cfg\_t**

ADC continuous mode driver initial configurations.

**Public Members**

uint32\_t **max\_store\_buf\_size**

Max length of the conversion results that driver can store, in bytes.

uint32\_t **conv\_frame\_size**

Conversion frame size, in bytes. This should be in multiples of SOC\_ADC\_DIGI\_DATA\_BYTES\_PER\_CONV.

uint32\_t **flush\_pool**

Flush the internal pool when the pool is full.

struct *adc\_continuous\_handle\_cfg\_t*::[anonymous] **flags**

Driver flags.

struct **adc\_continuous\_config\_t**

ADC continuous mode driver configurations.

**Public Members**

uint32\_t **pattern\_num**

Number of ADC channels that will be used.

*adc\_digi\_pattern\_config\_t* \***adc\_pattern**

List of configs for each ADC channel that will be used.

uint32\_t **sample\_freq\_hz**

The expected ADC sampling frequency in Hz. Please refer to `soc/soc_caps.h` to know available sampling frequency range

***adc\_digi\_convert\_mode\_t* conv\_mode**

ADC DMA conversion mode, see `adc_digi_convert_mode_t`.

***adc\_digi\_output\_format\_t* format**

ADC DMA conversion output format, see `adc_digi_output_format_t`.

struct **adc\_continuous\_evt\_data\_t**

Event data structure.

---

**备注:** The `conv_frame_buffer` is maintained by the driver itself, so never free this piece of memory.

---

**Public Members**

`uint8_t *conv_frame_buffer`

Pointer to conversion result buffer for one conversion frame.

`uint32_t size`

Conversion frame size.

struct **adc\_continuous\_evt\_cbs\_t**

Group of ADC continuous mode callbacks.

---

**备注:** These callbacks are all running in an ISR environment.

---

---

**备注:** When `CONFIG_ADC_CONTINUOUS_ISR_IRAM_SAFE` is enabled, the callback itself and functions called by it should be placed in IRAM. Involved variables should be in internal RAM as well.

---

**Public Members**

***adc\_continuous\_callback\_t* on\_conv\_done**

Event callback, invoked when one conversion frame is done. See the subsection `Driver Backgrounds` in this header file to learn about the `conversion_frame` concept.

***adc\_continuous\_callback\_t* on\_pool\_ovf**

Event callback, invoked when the internal pool is full.

**Macros**

**ADC\_MAX\_DELAY**

ADC read max timeout value, it may make the `adc_continuous_read` block forever if the OS supports.

**Type Definitions**

typedef struct `adc_continuous_ctx_t` \***adc\_continuous\_handle\_t**

Type of adc continuous mode driver handle.

```
typedef bool (*adc_continuous_callback_t)(adc_continuous_handle_t handle, const
adc_continuous_evt_data_t *edata, void *user_data)
```

Prototype of ADC continuous mode event callback.

**Param handle [in]** ADC continuous mode driver handle

**Param edata [in]** Pointer to ADC continuous mode event data

**Param user\_data [in]** User registered context, registered when in  
`adc_continuous_register_event_callbacks()`

**Return** Whether a high priority task is woken up by this function

### 2.6.3 模数转换器 (ADC) 校准驱动程序

#### 简介

在 ESP32-H2 中，模数转换器 (ADC) 比较输入的模拟电压和参考电压，以确定每一位数字输出结果。ESP32-H2 设计的 ADC 参考电压为 1100 mV。然而，不同芯片的真实参考电压可能会略有变化，范围在 1000 mV 到 1200 mV 之间。本文介绍了 ADC 校准驱动程序，可以降低参考电压不同带来的影响，获取更准确的输出结果。

#### 功能概述

下文将分节概述安装和使用 ADC 校准驱动程序的基本步骤：

- **创建校准方案** - 介绍如何创建和删除校准方案句柄。
- **结果转换** - 介绍如何将原始 ADC 结果转换为校准后的结果。
- **线程安全** - 列出由驱动程序认证为线程安全的 API。
- **减少噪声** - 介绍一种常见的降低噪声的方法。

**创建校准方案** ADC 校准驱动程序会提供 ADC 校准方案。对于驱动程序来说，每个 ADC 校准方案对应一个 ADC 校准句柄 `adc_cali_handle_t`。

使用 `adc_cali_check_scheme()` 可以查看芯片支持的校准方案。若已了解芯片支持的校准方案，可以跳过该步骤，直接调用对应函数创建校准方案句柄。

使用自定义 ADC 校准方案时，可以选择调整函数 `adc_cali_check_scheme()`，或直接跳过该步骤，调用自定义函数创建校准方案句柄。

**ADC 校准曲线拟合方案** ESP32-H2 支持 `ADC_CALI_SCHEME_VER_CURVE_FITTING` 方案。要创建此方案，请先根据以下配置选项，设置 `adc_cali_curve_fitting_config_t`。

- `adc_cali_curve_fitting_config_t::unit_id`，表示 ADC 原始结果来自哪个 ADC 单元。
- `adc_cali_curve_fitting_config_t::chan`，表示获取 ADC 原始结果的 ADC 通道。校准方案不仅因衰减程度而异，还与通道选择有关。
- `adc_cali_curve_fitting_config_t::atten`，表示 ADC 原始结果的衰减程度。
- `adc_cali_curve_fitting_config_t::bitwidth`，表示 ADC 原始结果的位宽。

设置完上述配置结构体后，请调用 `adc_cali_create_scheme_curve_fitting()` 创建曲线拟合方案句柄。由于 `ESP_ERR_INVALID_ARG` 或 `ESP_ERR_NO_MEM` 等原因，该函数调用可能失败。函数返回 `ESP_ERR_NOT_SUPPORTED` 时，说明你的开发板没有烧录校准方案所需的 eFuse 位。

**与 eFuse 相关的 ADC 校准故障** 函数 `adc_cali_create_scheme_curve_fitting()` 返回 `ESP_ERR_NOT_SUPPORTED` 时，代表开发板上校准方案所需的 eFuse 位不正确。

ESP-IDF 提供的 ADC 校准方案基于芯片上某些与 ADC 校准相关的 eFuse 位的值。乐鑫模组已在出厂时完成烧录，无需用户额外烧录。

如果遇到此类错误，请前往 [技术咨询](#) 进行反馈。

### 创建曲线拟合方案句柄

```
ESP_LOGI(TAG, "calibration scheme version is %s", "Curve Fitting");
adc_cali_curve_fitting_config_t cali_config = {
    .unit_id = unit,
    .atten = atten,
    .bitwidth = ADC_BITWIDTH_DEFAULT,
};
ESP_ERROR_CHECK(adc_cali_create_scheme_curve_fitting(&cali_config, &handle));
```

ADC 校准使用完毕后，请调用 `adc_cali_delete_scheme_curve_fitting()`，删除校准方案句柄。

### 删除曲线拟合方案句柄

```
ESP_LOGI(TAG, "delete %s calibration scheme", "Curve Fitting");
ESP_ERROR_CHECK(adc_cali_delete_scheme_curve_fitting(handle));
```

**备注：**要使用自定义校准方案，可以通过提供创建函数，创建自己的校准方案句柄。请参阅 `components/esp_adc/interface/adc_cali_interface.h` 中的函数表 `adc_cali_scheme_t`，了解 ESP ADC 校准接口。

**结果转换** 对驱动程序进行完上述配置和初始化工作后，可以调用 `adc_cali_raw_to_voltage()`，将原始 ADC 结果转换为校准结果，校准结果以 mV 为单位。该函数可能因参数无效而调用失败。如果函数返回 `ESP_ERR_INVALID_STATE`，说明校准方案尚未创建。因此你需要创建一个校准方案句柄，通过 `adc_cali_check_scheme()` 可以了解当前芯片支持的校准方案；你也可以提供自定义校准方案，创建对应的校准方案句柄。

### 获取电压

```
ESP_ERROR_CHECK(adc_cali_raw_to_voltage(adc_cali_handle, adc_raw[0][0], &
    ↪voltage[0][0]));
ESP_LOGI(TAG, "ADC%d Channel[%d] Cali Voltage: %d mV", ADC_UNIT_1 + 1, EXAMPLE_
    ↪ADC1_CHAN0, voltage[0][0]);
```

**线程安全** 驱动程序会确保工厂函数 `esp_adc_cali_new_scheme()` 的线程安全，使用时，可以直接从不同的 RTOS 任务中调用此类函数，无需额外锁保护。

其他以 `adc_cali_handle_t` 作为第一个位置参数的函数均非线程安全，在没有设置互斥锁保护的任務中，应避免从多个任务中调用这类函数。

**减少噪声** ESP32-H2 ADC 对噪声敏感，可能导致 ADC 读数出现较大偏差。根据不同使用场景，要减少噪声影响，你可能需要将旁路电容（如 100 nF 陶瓷电容）连接到 ADC 使用的输入管脚。此外，也可以通过多次采样，进一步减轻噪声的影响。

## API 参考

### Header File

- [components/esp\\_adc/include/esp\\_adc/adc\\_cali.h](#)
- This header file can be included with:

```
#include "esp_adc/adc_cali.h"
```

- This header file is a part of the API provided by the `esp_adc` component. To declare that your component depends on `esp_adc`, add the following to your `CMakeLists.txt`:

```
REQUIRES esp_adc
```

or

```
PRIV_REQUIRES esp_adc
```

## Functions

`esp_err_t adc_cali_check_scheme(adc_cali_scheme_ver_t *scheme_mask)`

Check the supported ADC calibration scheme.

**参数** `scheme_mask` -- [out] Supported ADC calibration scheme(s)

**返回**

- `ESP_OK`: On success
- `ESP_ERR_INVALID_ARG`: Invalid argument
- `ESP_ERR_NOT_SUPPORTED`: No supported calibration scheme

`esp_err_t adc_cali_raw_to_voltage(adc_cali_handle_t handle, int raw, int *voltage)`

Convert ADC raw data to calibrated voltage.

**参数**

- **handle** -- [in] ADC calibration handle
- **raw** -- [in] ADC raw data
- **voltage** -- [out] Calibrated ADC voltage (in mV)

**返回**

- `ESP_OK`: On success
- `ESP_ERR_INVALID_ARG`: Invalid argument
- `ESP_ERR_INVALID_STATE`: Invalid state, scheme didn't registered

## Type Definitions

```
typedef struct adc_cali_scheme_t *adc_cali_handle_t
```

ADC calibration handle.

## Enumerations

```
enum adc_cali_scheme_ver_t
```

ADC calibration scheme.

*Values:*

```
enumerator ADC_CALI_SCHEME_VER_LINE_FITTING
```

Line fitting scheme.

```
enumerator ADC_CALI_SCHEME_VER_CURVE_FITTING
```

Curve fitting scheme.

## Header File

- [components/esp\\_adc/include/esp\\_adc/adc\\_cali\\_scheme.h](#)
- This header file can be included with:



```
#include "esp_adc/adc_cali_scheme.h"
```

- This header file is a part of the API provided by the `esp_adc` component. To declare that your component depends on `esp_adc`, add the following to your `CMakeLists.txt`:

```
REQUIRES esp_adc
```

or

```
PRIV_REQUIRES esp_adc
```

## 2.6.4 Analog Comparator

### Introduction

Analog Comparator is a peripheral that can be used to compare a source signal with the internal reference voltage or an external reference signal.

It is a cost effective way to replace an amplifier comparator in some scenarios. But unlike the continuous comparing of the amplifier comparator, ESP Analog Comparator is driven by a source clock, which decides the sampling frequency.

Analog Comparator on ESP32-H2 has 1 unit(s), the channels in the unit(s) are:

#### UNIT0

- Source Channel: GPIO11
- External Reference Channel: GPIO10
- Internal Reference Channel: Range 0% ~ 70% of the VDD, the step is 10% of the VDD

### Functional Overview

The following sections of this document cover the typical steps to install and operate an Analog Comparator unit:

- *Resource Allocation* - covers which parameters should be set up to get a unit handle and how to recycle the resources when it finishes working.
- *Further Configurations* - covers the other configurations that might need to specific and what they are used for.
- *Enable and Disable Unit* - covers how to enable and disable the unit.
- *Power Management* - describes how different source clock selections can affect power consumption.
- *IRAM Safe* - lists which functions are supposed to work even when the cache is disabled.
- *Thread Safety* - lists which APIs are guaranteed to be thread safe by the driver.
- *Kconfig Options* - lists the supported Kconfig options that can be used to make a different effect on driver behavior.

**Resource Allocation** An Analog Comparator unit channel is represented by `ana_cmpr_handle_t`. Each unit can support either an internal or an external reference.

To allocate the resource of the Analog Comparator unit, `ana_cmpr_new_unit()` need to be called to get the handle of the unit. Configurations `ana_cmpr_config_t` need to be specified while allocating the unit:

- `ana_cmpr_config_t::unit` selects the Analog Comparator unit.
- `ana_cmpr_config_t::clk_src` selects the source clock for Analog Comparator, it can affect the sampling frequency. Note that the clock source of the Analog Comparator comes from the io mux, it is shared with GPIO extension peripherals like SDM (Sigma-Delta Modulation) and Glitch Filter. The configuration will fail if you specific different clock sources for multiple GPIO extension peripherals. The default clock sources of these peripherals are same, typically, we select `soc_periph_ana_cmpr_clk_src_t::ANA_CMPR_CLK_SRC_DEFAULT` as the clock source.
- `ana_cmpr_config_t::ref_src` selects the reference source from internal voltage or external signal.
- `ana_cmpr_config_t::cross_type` selects which kind of cross type can trigger the interrupt.

The function `ana_cmpr_new_unit()` can fail due to various errors such as insufficient memory, invalid arguments, etc. If a previously created Analog Comparator unit is no longer required, you should recycle it by calling `ana_cmpr_del_unit()`. It allows the underlying HW channel to be used for other purposes. Before deleting an Analog Comparator unit handle, you should disable it by `ana_cmpr_unit_disable()` in advance, or make sure it has not enabled yet by `ana_cmpr_unit_enable()`.

```
#include "driver/ana_cmpr.h"

ana_cmpr_handle_t cmpr = NULL;
ana_cmpr_config_t config = {
    .unit = 0,
    .clk_src = ANA_CMPR_CLK_SRC_DEFAULT,
    .ref_src = ANA_CMPR_REF_SRC_INTERNAL,
    .cross_type = ANA_CMPR_CROSS_ANY,
};
ESP_ERROR_CHECK(ana_cmpr_new_unit(&config, &cmpr));
// ...
ESP_ERROR_CHECK(ana_cmpr_del_unit(cmpr));
```

### Further Configurations

- `ana_cmpr_set_intl_reference()` - Specify the internal reference voltage when `ana_cmpr_ref_source_t::ANA_CMPR_REF_SRC_INTERNAL` is selected as reference source.

It requires `ana_cmpr_internal_ref_config_t::ref_volt` to specify the voltage. The voltage related to the VDD power supply, which can only support a certain fixed percentage of VDD. Currently on ESP32-H2, the internal reference voltage can be range to 0 ~ 70% VDD with a step 10%.

```
#include "driver/ana_cmpr.h"

ana_cmpr_internal_ref_config_t ref_cfg = {
    .ref_volt = ANA_CMPR_REF_VOLT_50_PCT_VDD,
};
ESP_ERROR_CHECK(ana_cmpr_set_internal_reference(cmpr, &ref_cfg));
```

- `ana_cmpr_set_debounce()` - Set the debounce configuration.

It requires `ana_cmpr_debounce_config_t::wait_us` to set the interrupt waiting time. The interrupt is disabled temporarily for `ana_cmpr_debounce_config_t::wait_us` micro seconds, so that the frequent triggering can be avoid while the source signal crossing the reference signal. That is, the waiting time is supposed to be inverse ratio to the relative frequency between the source and reference. If the waiting time is set too short, it can not bypass the jitter totally, but if too long, the next crossing interrupt might be missed.

```
#include "driver/ana_cmpr.h"

ana_cmpr_debounce_config_t dbc_cfg = {
    .wait_us = 1,
};
ESP_ERROR_CHECK(ana_cmpr_set_debounce(cmpr, &dbc_cfg));
```

- `ana_cmpr_set_cross_type()` - Set the source signal cross type.

The initial cross type is set int `ana_cmpr_new_unit()`, this function can update the cross type, even in ISR context.

```
#include "driver/ana_cmpr.h"

ESP_ERROR_CHECK(ana_cmpr_set_cross_type(cmpr, ANA_CMPR_CROSS_POS));
```

- `ana_cmpr_register_event_callbacks()` - Register the callbacks.

Currently it supports `ana_cmpr_event_callbacks_t::on_cross`, it will be called when the crossing event (specified by `ana_cmpr_config_t::cross_type`) occurs.

```

#include "driver/ana_cmpr.h"

static bool IRAM_ATTR example_ana_cmpr_on_cross_callback(ana_cmpr_handle_t cmpr,
                                                         const ana_cmpr_cross_event_
↳data_t *edata,
                                                         void *user_ctx)
{
    // ...
    return false;
}

ana_cmpr_event_callbacks_t cbs = {
    .on_cross = example_ana_cmpr_on_cross_callback,
};
ESP_ERROR_CHECK(ana_cmpr_register_event_callbacks(cmpr, &cbs, NULL));

```

**备注:** When `CONFIG_ANA_CMPR_ISR_IRAM_SAFE` is enabled, you should guarantee the callback context and involved data to be in internal RAM by add the attribute `IRAM_ATTR`. (See more in *IRAM Safe*)

### Enable and Disable Unit

- `ana_cmpr_enable()` - Enable the Analog Comparator unit.
- `ana_cmpr_disable()` - Disable the Analog Comparator unit.

After the Analog Comparator unit is enabled and the crossing event interrupt is enabled, a power management lock will be acquired if the power management is enabled (see *Power Management*). Under the **enable** state, only `ana_cmpr_set_int1_reference()` and `ana_cmpr_set_debounce()` can be called, other functions can only be called after the unit is disabled.

Calling `ana_cmpr_disable()` does the opposite.

**Power Management** When power management is enabled (i.e., `CONFIG_PM_ENABLE` is on), the system will adjust the APB frequency before going into light sleep, thus potentially changing the resolution of the Analog Comparator.

However, the driver can prevent the system from changing APB frequency by acquiring a power management lock of type `ESP_PM_NO_LIGHT_SLEEP`. Whenever the driver creates a Analog Comparator unit instance that has selected the clock source like `ANA_CMPR_CLK_SRC_DEFAULT` or `ANA_CMPR_CLK_SRC_XTAL` as its clock source, the driver guarantees that the power management lock is acquired when enable the channel by `ana_cmpr_enable()`. Likewise, the driver releases the lock when `ana_cmpr_disable()` is called for that channel.

**IRAM Safe** By default, the Analog Comparator interrupt will be deferred when the Cache is disabled for reasons like programming/erasing Flash. Thus the alarm interrupt will not get executed in time, which is not expected in a real-time application.

There is a Kconfig option `CONFIG_ANA_CMPR_ISR_IRAM_SAFE` that:

1. Enables the interrupt being serviced even when cache is disabled
2. Places all functions that used by the ISR into IRAM<sup>1</sup>
3. Places driver object into DRAM (in case it is allocated on PSRAM)

This allows the interrupt to run while the cache is disabled but comes at the cost of increased IRAM consumption.

There is a Kconfig option `CONFIG_ANA_CMPR_CTRL_FUNC_IN_IRAM` that can put commonly used IO control functions into IRAM as well. So that these functions can also be executable when the cache is disabled. These IO control functions are listed as follows:

<sup>1</sup> `ana_cmpr_event_callbacks_t::on_cross` callback and the functions invoked by itself should also be placed in IRAM, you need to take care of them by themselves.

- [ana\\_cmpr\\_set\\_internal\\_reference\(\)](#)
- [ana\\_cmpr\\_set\\_debounce\(\)](#)
- [ana\\_cmpr\\_set\\_cross\\_type\(\)](#)

**Thread Safety** The factory function [ana\\_cmpr\\_new\\_unit\(\)](#) is guaranteed to be thread safe by the driver, which means, user can call it from different RTOS tasks without protection by extra locks. The following functions are allowed to run under ISR context, the driver uses a critical section to prevent them being called concurrently in both task and ISR.

- [ana\\_cmpr\\_set\\_internal\\_reference\(\)](#)
- [ana\\_cmpr\\_set\\_debounce\(\)](#)
- [ana\\_cmpr\\_set\\_cross\\_type\(\)](#)

Other functions that take the [ana\\_cmpr\\_handle\\_t](#) as the first positional parameter, are not treated as thread safe. Which means the user should avoid calling them from multiple tasks.

### Kconfig Options

- [CONFIG\\_ANA\\_CMPR\\_ISR\\_IRAM\\_SAFE](#) controls whether the default ISR handler can work when cache is disabled, see [IRAM Safe](#) for more information.
- [CONFIG\\_ANA\\_CMPR\\_CTRL\\_FUNC\\_IN\\_IRAM](#) controls where to place the Analog Comparator control functions (IRAM or Flash), see [IRAM Safe](#) for more information.
- [CONFIG\\_ANA\\_CMPR\\_ENABLE\\_DEBUG\\_LOG](#) is used to enabled the debug log output. Enabling this option increases the firmware binary size.

### Application Example

- [peripherals/analog\\_comparator](#) shows the basic usage of the analog comparator, and other potential usages like hysteresis comparator and SPWM generator.

### API Reference

#### Header File

- [components/esp\\_driver\\_ana\\_cmpr/include/driver/ana\\_cmpr.h](#)
- This header file can be included with:

```
#include "driver/ana_cmpr.h"
```

- This header file is a part of the API provided by the [esp\\_driver\\_ana\\_cmpr](#) component. To declare that your component depends on [esp\\_driver\\_ana\\_cmpr](#), add the following to your CMakeLists.txt:

```
REQUIRES esp_driver_ana_cmpr
```

or

```
PRIV_REQUIRES esp_driver_ana_cmpr
```

#### Functions

[esp\\_err\\_t ana\\_cmpr\\_new\\_unit](#) (const [ana\\_cmpr\\_config\\_t](#) \*config, [ana\\_cmpr\\_handle\\_t](#) \*ret\_cmpr)

Allocating a new analog comparator unit handle.

##### 参数

- **config** -- [in] The config of the analog comparator unit
- **ret\_cmpr** -- [out] The returned analog comparator unit handle

##### 返回

- ESP\_OK Allocate analog comparator unit handle success
- ESP\_ERR\_NO\_MEM No memory for the analog comparator structure

- `ESP_ERR_INVALID_ARG` NULL pointer of the parameters or wrong unit number
- `ESP_ERR_INVALID_STATE` The unit has been allocated or the clock source has been occupied

*esp\_err\_t* `ana_cmpr_del_unit` (*ana\_cmpr\_handle\_t* cmpr)

Delete the analog comparator unit handle.

**参数** `cmpr` -- **[in]** The handle of analog comparator unit

**返回**

- `ESP_OK` Delete analog comparator unit handle success
- `ESP_ERR_INVALID_ARG` NULL pointer of the parameters or wrong unit number
- `ESP_ERR_INVALID_STATE` The analog comparator is not disabled yet

*esp\_err\_t* `ana_cmpr_set_internal_reference` (*ana\_cmpr\_handle\_t* cmpr, const *ana\_cmpr\_internal\_ref\_config\_t* \*ref\_cfg)

Set internal reference configuration.

---

**备注:** This function only need to be called when `ana_cmpr_config_t::ref_src` is `ANA_CMPR_REF_SRC_INTERNAL`.

---



---

**备注:** This function is allowed to run within ISR context including intr callbacks

---



---

**备注:** This function will be placed into IRAM if `CONFIG_ANA_CMPR_CTRL_FUNC_IN_IRAM` is on, so that it's allowed to be executed when Cache is disabled

---

**参数**

- `cmpr` -- **[in]** The handle of analog comparator unit
- `ref_cfg` -- **[in]** Internal reference configuration

**返回**

- `ESP_OK` Set denounce configuration success
- `ESP_ERR_INVALID_ARG` NULL pointer of the parameters
- `ESP_ERR_INVALID_STATE` The reference source is not `ANA_CMPR_REF_SRC_INTERNAL`

*esp\_err\_t* `ana_cmpr_set_debounce` (*ana\_cmpr\_handle\_t* cmpr, const *ana\_cmpr\_debounce\_config\_t* \*dbc\_cfg)

Set debounce configuration to the analog comparator.

---

**备注:** This function is allowed to run within ISR context including intr callbacks

---



---

**备注:** This function will be placed into IRAM if `CONFIG_ANA_CMPR_CTRL_FUNC_IN_IRAM` is on, so that it's allowed to be executed when Cache is disabled

---

**参数**

- `cmpr` -- **[in]** The handle of analog comparator unit
- `dbc_cfg` -- **[in]** Debounce configuration

**返回**

- `ESP_OK` Set denounce configuration success
- `ESP_ERR_INVALID_ARG` NULL pointer of the parameters

*esp\_err\_t* **ana\_cmpr\_set\_cross\_type** (*ana\_cmpr\_handle\_t* cmpr, *ana\_cmpr\_cross\_type\_t* cross\_type)

Set the source signal cross type.

---

**备注:** The initial cross type is configured in `ana_cmpr_new_unit`, this function can update the cross type

---



---

**备注:** This function is allowed to run within ISR context including intr callbacks

---



---

**备注:** This function will be placed into IRAM if `CONFIG_ANA_CMPR_CTRL_FUNC_IN_IRAM` is on, so that it's allowed to be executed when Cache is disabled

---

#### 参数

- **cmpr** -- **[in]** The handle of analog comparator unit
- **cross\_type** -- **[in]** The source signal cross type that can trigger the interrupt

#### 返回

- `ESP_OK` Set denounce configuration success
- `ESP_ERR_INVALID_ARG` NULL pointer of the parameters

*esp\_err\_t* **ana\_cmpr\_register\_event\_callbacks** (*ana\_cmpr\_handle\_t* cmpr, const *ana\_cmpr\_event\_callbacks\_t* \*cbs, void \*user\_data)

Register analog comparator interrupt event callbacks.

---

**备注:** This function can only be called before enabling the unit

---

#### 参数

- **cmpr** -- **[in]** The handle of analog comparator unit
- **cbs** -- **[in]** Group of callback functions
- **user\_data** -- **[in]** The user data that will be passed to callback functions directly

#### 返回

- `ESP_OK` Register callbacks success
- `ESP_ERR_INVALID_ARG` NULL pointer of the parameters
- `ESP_ERR_INVALID_STATE` The analog comparator has been enabled

*esp\_err\_t* **ana\_cmpr\_enable** (*ana\_cmpr\_handle\_t* cmpr)

Enable the analog comparator unit.

**参数** **cmpr** -- **[in]** The handle of analog comparator unit

#### 返回

- `ESP_OK` Enable analog comparator unit success
- `ESP_ERR_INVALID_ARG` NULL pointer of the parameters
- `ESP_ERR_INVALID_STATE` The analog comparator has been enabled

*esp\_err\_t* **ana\_cmpr\_disable** (*ana\_cmpr\_handle\_t* cmpr)

Disable the analog comparator unit.

**参数** **cmpr** -- **[in]** The handle of analog comparator unit

#### 返回

- `ESP_OK` Disable analog comparator unit success
- `ESP_ERR_INVALID_ARG` NULL pointer of the parameters
- `ESP_ERR_INVALID_STATE` The analog comparator has disabled already

*esp\_err\_t* **ana\_cmpr\_get\_gpio** (*ana\_cmpr\_unit\_t* unit, *ana\_cmpr\_channel\_type\_t* chan\_type, int \*gpio\_num)

Get the specific GPIO number of the analog comparator unit.

**参数**

- **unit** -- **[in]** The handle of analog comparator unit
- **chan\_type** -- **[in]** The channel type of analog comparator, like source channel or reference channel
- **gpio\_num** -- **[out]** The output GPIO number of this channel

**返回**

- ESP\_OK Get GPIO success
- ESP\_ERR\_INVALID\_ARG NULL pointer of the parameters or wrong unit number or wrong channel type

**Structures**

struct **ana\_cmpr\_config\_t**

Analog comparator unit configuration.

**Public Members**

*ana\_cmpr\_unit\_t* **unit**

Analog comparator unit

*ana\_cmpr\_clk\_src\_t* **clk\_src**

The clock source of the analog comparator, which decide the resolution of the comparator

*ana\_cmpr\_ref\_source\_t* **ref\_src**

Reference signal source of the comparator, select using ANA\_CMPR\_REF\_SRC\_INTERNAL or ANA\_CMPR\_REF\_SRC\_EXTERNAL. For internal reference, the reference voltage should be set to `internal_ref_volt`, for external reference, the reference signal should be connect to ANA\_CMPRx\_EXT\_REF\_GPIO

*ana\_cmpr\_cross\_type\_t* **cross\_type**

The crossing types that can trigger interrupt

int **intr\_priority**

The interrupt priority, range 0~7, if set to 0, the driver will try to allocate an interrupt with a relative low priority (1,2,3) otherwise the larger the higher, 7 is NMI

uint32\_t **io\_loop\_back**

Enable this field when the other signals that output on the comparison pins are supposed to be fed back. Normally used for debug/test scenario

struct *ana\_cmpr\_config\_t*::[anonymous] **flags**

Analog comparator driver flags

struct **ana\_cmpr\_internal\_ref\_config\_t**

Analog comparator internal reference configuration.

**Public Members**

*ana\_cmpr\_ref\_voltage\_t* **ref\_volt**

The internal reference voltage. It can be specified to a certain fixed percentage of the VDD power supply, currently supports 0%~70% VDD with a step 10%

struct **ana\_cmpr\_debounce\_config\_t**

Analog comparator debounce filter configuration.

### Public Members

uint32\_t **wait\_us**

The wait time of re-enabling the interrupt after the last triggering, it is used to avoid the spurious triggering while the source signal crossing the reference signal. The value should regarding how fast the source signal changes, e.g., a rapid signal requires a small wait time, otherwise the next crosses may be missed. (Unit: micro second)

struct **ana\_cmpr\_event\_callbacks\_t**

Group of Analog Comparator callbacks.

---

**备注:** The callbacks are all running under ISR environment

---

---

**备注:** When CONFIG\_ANA\_CMPR\_ISR\_IRAM\_SAFE is enabled, the callback itself and functions called by it should be placed in IRAM. The variables used in the function should be in the SRAM as well.

---

### Public Members

*ana\_cmpr\_cross\_cb\_t* **on\_cross**

The callback function on cross interrupt

### Header File

- `components/esp_driver_ana_cmpr/include/driver/ana_cmpr_types.h`
- This header file can be included with:

```
#include "driver/ana_cmpr_types.h"
```

- This header file is a part of the API provided by the `esp_driver_ana_cmpr` component. To declare that your component depends on `esp_driver_ana_cmpr`, add the following to your CMakeLists.txt:

```
REQUIRES esp_driver_ana_cmpr
```

or

```
PRIV_REQUIRES esp_driver_ana_cmpr
```

### Structures

struct **ana\_cmpr\_cross\_event\_data\_t**

Analog comparator cross event data.

### Public Members



***ana\_cmpr\_cross\_type\_t* cross\_type**

The cross type of the target signal to the reference signal. Will either be ANA\_CMPR\_CROSS\_POS or ANA\_CMPR\_CROSS\_NEG Always be ANA\_CMPR\_CROSS\_ANY if target does not support independent interrupt (like ESP32H2)

**Macros****ANA\_CMPR\_UNIT\_0**

*Deprecated:*

Analog comparator unit 0

**Type Definitions**

typedef int **ana\_cmpr\_unit\_t**

Analog comparator unit.

typedef struct ana\_cmpr\_t \***ana\_cmpr\_handle\_t**

Analog comparator unit handle.

typedef *soc\_periph\_ana\_cmpr\_clk\_src\_t* **ana\_cmpr\_clk\_src\_t**

Analog comparator clock source.

typedef bool (\***ana\_cmpr\_cross\_cb\_t**)(*ana\_cmpr\_handle\_t* cmpr, const *ana\_cmpr\_cross\_event\_data\_t* \*edata, void \*user\_ctx)

Prototype of Analog comparator event callback.

**Param cmpr [in]** Analog Comparator handle, created from *ana\_cmpr\_new\_unit()*

**Param edata [in]** Point to Analog Comparator event data. The lifecycle of this pointer memory is inside this function, user should copy it into static memory if used outside this function. (Currently not use)

**Param user\_ctx [in]** User registered context, passed from *ana\_cmpr\_register\_event\_callbacks()*

**Return** Whether a high priority task has been waken up by this callback function

**Enumerations**

enum **ana\_cmpr\_ref\_source\_t**

Analog comparator reference source.

*Values:*

enumerator **ANA\_CMPR\_REF\_SRC\_INTERNAL**

Analog Comparator internal reference source, related to VDD

enumerator **ANA\_CMPR\_REF\_SRC\_EXTERNAL**

Analog Comparator external reference source, from ANA\_CMPR0\_EXT\_REF\_GPIO

enum **ana\_cmpr\_channel\_type\_t**

Analog comparator channel type.

*Values:*

enumerator **ANA\_CMPR\_SOURCE\_CHAN**

Analog Comparator source channel, which is used to input the signal that to be compared

enumerator **ANA\_CMPR\_EXT\_REF\_CHAN**

Analog Comparator external reference channel, which is used as the reference signal

enum **ana\_cmpr\_cross\_type\_t**

Analog comparator interrupt type.

*Values:*

enumerator **ANA\_CMPR\_CROSS\_DISABLE**

Disable the cross event interrupt

enumerator **ANA\_CMPR\_CROSS\_POS**

Positive cross can trigger event interrupt

enumerator **ANA\_CMPR\_CROSS\_NEG**

Negative cross can trigger event interrupt

enumerator **ANA\_CMPR\_CROSS\_ANY**

Any cross can trigger event interrupt

enum **ana\_cmpr\_ref\_voltage\_t**

Analog comparator internal reference voltage.

*Values:*

enumerator **ANA\_CMPR\_REF\_VOLT\_0\_PCT\_VDD**

Internal reference voltage equals to 0% VDD

enumerator **ANA\_CMPR\_REF\_VOLT\_10\_PCT\_VDD**

Internal reference voltage equals to 10% VDD

enumerator **ANA\_CMPR\_REF\_VOLT\_20\_PCT\_VDD**

Internal reference voltage equals to 20% VDD

enumerator **ANA\_CMPR\_REF\_VOLT\_30\_PCT\_VDD**

Internal reference voltage equals to 30% VDD

enumerator **ANA\_CMPR\_REF\_VOLT\_40\_PCT\_VDD**

Internal reference voltage equals to 40% VDD

enumerator **ANA\_CMPR\_REF\_VOLT\_50\_PCT\_VDD**

Internal reference voltage equals to 50% VDD

enumerator **ANA\_CMPR\_REF\_VOLT\_60\_PCT\_VDD**

Internal reference voltage equals to 60% VDD

enumerator **ANA\_CMPR\_REF\_VOLT\_70\_PCT\_VDD**

Internal reference voltage equals to 70% VDD

## 2.6.5 时钟树

ESP32-H2 的时钟子系统用于从一系列根时钟中提取并分配系统/模块时钟。时钟树驱动程序负责维护系统时钟的基本功能，并管理模块时钟间的复杂关系。

本文档首先介绍了根时钟和模块时钟，随后介绍了可供用户调用的时钟树 API，调用这些 API，可以监测模块时钟的运行状态。

### 简介

本节列出了 ESP32-H2 支持的根时钟和模块时钟的定义，这些定义通常用于驱动程序配置，有助于为外设选择合适的时钟源。

**根时钟** 根时钟会产生可靠的时钟信号，经各种门、复用器、分频器或倍频器传递，这些时钟信号最终成为 CPU 内核、Wi-Fi、蓝牙、RTC 及外设等功能模块的时钟源。

ESP32-H2 的根时钟列在 `soc_root_clk_t` 中：

- 内部 8 MHz RC 振荡器 (RC\_FAST)
  - 此 RC 振荡器可产生约 8.5 MHz 的时钟信号输出，标识为 RC\_FAST\_CLK。
  - 在运行时，通过校准，可以计算 RC\_FAST\_CLK 的实际频率。
- 外部 32 MHz 晶振 (XTAL)
- 内部 136 kHz RC 振荡器 (RC\_SLOW)
  - 此 RC 振荡器产生约 136 kHz 的时钟信号输出，标识为 RC\_SLOW\_CLK。在运行时，通过校准，可以计算该时钟信号的实际频率。
- 外部 32 kHz 晶振 - 可选 (XTAL32K)
  - XTAL32K\_CLK 的时钟源可以是连接到 XTAL\_32K\_P 和 XTAL\_32K\_N 管脚的 32 kHz 晶振，也可以是外部电路生成的 32 kHz 时钟信号。如果使用外部电路生成的时钟信号，该信号必须连接到 XTAL\_32K\_P 管脚。
  - 通过校准，可以计算 XTAL32K\_CLK 的实际频率。
- 外部慢速时钟 - 可选 (OSC\_SLOW)
  - 将外部电路生成的时钟信号连接到 GPIO13，可作为 RTC\_SLOW\_CLK 的时钟源。
  - 通过校准，可以计算该时钟信号的实际频率。
- 内部 32 kHz RC 振荡器 (RC32K)
  - 在运行时，通过校准，可以计算该时钟信号的实际频率。

与晶振产生的信号相比，从 RC 振荡器电路产生的信号通常精度较低，且容易受环境影响。因此，ESP32-H2 为 RTC\_SLOW\_CLK 提供了几种时钟源选项，可以根据对系统时间精度和对功耗的要求选择。更多详情，请参阅 [RTC 定时器时钟源](#)。

**模块时钟** ESP32-H2 的可用模块时钟在 `soc_module_clk_t` 中列出，每个模块时钟都有其唯一 ID。查阅文档中的枚举值，即可获取各模块时钟的详细信息。

### 使用 API

时钟树驱动程序提供了一个一体化接口，可以获取模块时钟的频率，即 `esp_clk_tree_src_get_freq_hz()`。通过该函数，你可以在任何时刻，通过提供时钟名称 `soc_module_clk_t` 和指定返回频率值的精度级别 `esp_clk_tree_src_freq_precision_t`，获取时钟频率。

## API 参考

### Header File

- `components/soc/esp32h2/include/soc/clk_tree_defs.h`
- This header file can be included with:

```
#include "soc/clk_tree_defs.h"
```

### Macros

#### **SOC\_CLK\_RC\_FAST\_FREQ\_APPROX**

Approximate RC\_FAST\_CLK frequency in Hz

#### **SOC\_CLK\_RC\_SLOW\_FREQ\_APPROX**

Approximate RC\_SLOW\_CLK frequency in Hz

#### **SOC\_CLK\_RC32K\_FREQ\_APPROX**

Approximate RC32K\_CLK frequency in Hz

#### **SOC\_CLK\_XTAL32K\_FREQ\_APPROX**

Approximate XTAL32K\_CLK frequency in Hz

#### **SOC\_CLK\_OSC\_SLOW\_FREQ\_APPROX**

Approximate OSC\_SLOW\_CLK (external slow clock) frequency in Hz

#### **SOC\_GPTIMER\_CLKS**

Array initializer for all supported clock sources of GPTimer.

The following code can be used to iterate all possible clocks:

```
soc_periph_gptimer_clk_src_t gptimer_clks[] = (soc_periph_gptimer_clk_src_t)
SOC_GPTIMER_CLKS;
for (size_t i = 0; i < sizeof(gptimer_clks) / sizeof(gptimer_clks[0]); i++) {
    soc_periph_gptimer_clk_src_t clk = gptimer_clks[i];
    // Test GPTimer with the clock `clk`
}
```

#### **SOC\_RMT\_CLKS**

Array initializer for all supported clock sources of RMT.

#### **SOC\_TEMP\_SENSOR\_CLKS**

Array initializer for all supported clock sources of Temperature Sensor.

#### **SOC\_UART\_CLKS**

Array initializer for all supported clock sources of UART.

#### **SOC\_MCPWM\_TIMER\_CLKS**

Array initializer for all supported clock sources of MCPWM Timer.

#### **SOC\_MCPWM\_CAPTURE\_CLKS**

Array initializer for all supported clock sources of MCPWM Capture Timer.

**SOC\_MCPWM\_CARRIER\_CLKS**

Array initializer for all supported clock sources of MCPWM Carrier.

**SOC\_I2S\_CLKS**

Array initializer for all supported clock sources of I2S.

**SOC\_I2C\_CLKS**

Array initializer for all supported clock sources of I2C.

**SOC\_SPI\_CLKS**

Array initializer for all supported clock sources of SPI.

**SOC\_SDM\_CLKS**

Array initializer for all supported clock sources of SDM.

**SOC\_ANA\_CMPR\_CLKS**

Array initializer for all supported clock sources of Analog Comparator.

**SOC\_GLITCH\_FILTER\_CLKS**

Array initializer for all supported clock sources of Glitch Filter.

**SOC\_TWAI\_CLKS**

Array initializer for all supported clock sources of TWAI.

**SOC\_ADC\_DIGI\_CLKS**

Array initializer for all supported clock sources of ADC digital controller.

**SOC\_MWDT\_CLKS**

Array initializer for all supported clock sources of MWDT.

**SOC\_LEDC\_CLKS**

Array initializer for all supported clock sources of LEDC.

**SOC\_PARLIO\_CLKS**

Array initializer for all supported clock sources of PARLIO.

**SOC\_MSPI\_CLKS**

Array initializer for all supported clock sources of MSPI digital controller.

**Enumerations**

enum **soc\_root\_clk\_t**

Root clock.

*Values:*

enumerator **SOC\_ROOT\_CLK\_INT\_RC\_FAST**

Internal 8.5MHz RC oscillator

enumerator **SOC\_ROOT\_CLK\_INT\_RC\_SLOW**

Internal 136kHz RC oscillator

enumerator **SOC\_ROOT\_CLK\_EXT\_XTAL**

External 32MHz crystal

enumerator **SOC\_ROOT\_CLK\_EXT\_XTAL32K**

External 32kHz crystal/clock signal

enumerator **SOC\_ROOT\_CLK\_INT\_RC32K**

Internal 32kHz RC oscillator

enumerator **SOC\_ROOT\_CLK\_EXT\_OSC\_SLOW**

External slow clock signal at pin13

enum **soc\_cpu\_clk\_src\_t**

CPU\_CLK mux inputs, which are the supported clock sources for the CPU\_CLK.

---

**备注:** Enum values are matched with the register field values on purpose

---

*Values:*

enumerator **SOC\_CPU\_CLK\_SRC\_XTAL**

Select XTAL\_CLK as CPU\_CLK source

enumerator **SOC\_CPU\_CLK\_SRC\_PLL**

Select PLL\_CLK as CPU\_CLK source (PLL\_CLK is one of the outputs of 32MHz crystal oscillator frequency multiplier, 96MHz)

enumerator **SOC\_CPU\_CLK\_SRC\_RC\_FAST**

Select RC\_FAST\_CLK as CPU\_CLK source

enumerator **SOC\_CPU\_CLK\_SRC\_FLASH\_PLL**

Select FLASH\_PLL\_CLK as CPU\_CLK source (FLASH\_PLL\_CLK is the other output of 32MHz crystal oscillator frequency multiplier, 64MHz)

enumerator **SOC\_CPU\_CLK\_SRC\_INVALID**

Invalid CPU\_CLK source

enum **soc\_rtc\_slow\_clk\_src\_t**

RTC\_SLOW\_CLK mux inputs, which are the supported clock sources for the RTC\_SLOW\_CLK.

---

**备注:** Enum values are matched with the register field values on purpose

---

*Values:*

enumerator **SOC\_RTC\_SLOW\_CLK\_SRC\_RC\_SLOW**

Select RC\_SLOW\_CLK as RTC\_SLOW\_CLK source

enumerator **SOC\_RTC\_SLOW\_CLK\_SRC\_XTAL32K**

Select XTAL32K\_CLK as RTC\_SLOW\_CLK source

enumerator **SOC\_RTC\_SLOW\_CLK\_SRC\_RC32K**

Select RC32K\_CLK as RTC\_SLOW\_CLK source

enumerator **SOC\_RTC\_SLOW\_CLK\_SRC\_OSC\_SLOW**

Select OSC\_SLOW\_CLK (external slow clock) as RTC\_SLOW\_CLK source

enumerator **SOC\_RTC\_SLOW\_CLK\_SRC\_INVALID**

Invalid RTC\_SLOW\_CLK source

enum **soc\_rtc\_fast\_clk\_src\_t**

RTC\_FAST\_CLK mux inputs, which are the supported clock sources for the RTC\_FAST\_CLK.

---

**备注:** Enum values are matched with the register field values on purpose

---

*Values:*

enumerator **SOC\_RTC\_FAST\_CLK\_SRC\_RC\_FAST**

Select RC\_FAST\_CLK as RTC\_FAST\_CLK source

enumerator **SOC\_RTC\_FAST\_CLK\_SRC\_XTAL\_D2**

Select XTAL\_D2\_CLK (may referred as XTAL\_CLK\_DIV\_2) as RTC\_FAST\_CLK source

enumerator **SOC\_RTC\_FAST\_CLK\_SRC\_XTAL\_DIV**

Alias name for SOC\_RTC\_FAST\_CLK\_SRC\_XTAL\_D2

enumerator **SOC\_RTC\_FAST\_CLK\_SRC\_LP\_PLL**

Select LP\_PLL\_CLK as RTC\_FAST\_CLK source (LP\_PLL\_CLK is a 8MHz clock sourced from RC32K or XTAL32K)

enumerator **SOC\_RTC\_FAST\_CLK\_SRC\_INVALID**

Invalid RTC\_FAST\_CLK source

enum **soc\_lp\_pll\_clk\_src\_t**

LP\_PLL\_CLK mux inputs, which are the supported clock sources for the LP\_PLL\_CLK.

---

**备注:** Enum values are matched with the register field values on purpose

---

*Values:*

enumerator **SOC\_LP\_PLL\_CLK\_SRC\_RC32K**

Select RC32K\_CLK as LP\_PLL\_CLK source

enumerator **SOC\_LP\_PLL\_CLK\_SRC\_XTAL32K**

Select XTAL32K\_CLK as LP\_PLL\_CLK source

enumerator **SOC\_LP\_PLL\_CLK\_SRC\_INVALID**

Invalid LP\_PLL\_CLK source

enum **soc\_xtal\_freq\_t**

Possible main XTAL frequency options on the target.

---

**备注:** Enum values equal to the frequency value in MHz

---

---

**备注:** Not all frequency values listed here are supported in IDF. Please check SOC\_XTAL\_SUPPORT\_XXX in soc\_caps.h for the supported ones.

---

*Values:*

enumerator **SOC\_XTAL\_FREQ\_32M**

32MHz XTAL

enum **soc\_module\_clk\_t**

Supported clock sources for modules (CPU, peripherals, RTC, etc.)

---

**备注:** enum starts from 1, to save 0 for special purpose

---

*Values:*

enumerator **SOC\_MOD\_CLK\_CPU**

CPU\_CLK can be sourced from XTAL, PLL, RC\_FAST, or FLASH\_PLL by configuring soc\_cpu\_clk\_src\_t

enumerator **SOC\_MOD\_CLK\_RTC\_FAST**

RTC\_FAST\_CLK can be sourced from XTAL\_D2, RC\_FAST, or LP\_PLL by configuring soc\_rtc\_fast\_clk\_src\_t

enumerator **SOC\_MOD\_CLK\_RTC\_SLOW**

RTC\_SLOW\_CLK can be sourced from RC\_SLOW, XTAL32K, OSC\_SLOW, or RC32K by configuring soc\_rtc\_slow\_clk\_src\_t

enumerator **SOC\_MOD\_CLK\_PLL\_F48M**

PLL\_F48M\_CLK is derived from PLL (clock gating + fixed divider of 2), it has a fixed frequency of 48MHz

enumerator **SOC\_MOD\_CLK\_PLL\_F64M**

PLL\_F64M\_CLK is derived from FLASH\_PLL (clock gating), it has a fixed frequency of 64MHz

enumerator **SOC\_MOD\_CLK\_PLL\_F96M**

PLL\_F96M\_CLK is derived from PLL (clock gating), it has a fixed frequency of 96MHz

enumerator **SOC\_MOD\_CLK\_XTAL32K**

XTAL32K\_CLK comes from the external 32kHz crystal, passing a clock gating to the peripherals



enumerator **SOC\_MOD\_CLK\_RC\_FAST**

RC\_FAST\_CLK comes from the internal 8MHz rc oscillator, passing a clock gating to the peripherals

enumerator **SOC\_MOD\_CLK\_XTAL**

XTAL\_CLK comes from the external 32MHz crystal

enumerator **SOC\_MOD\_CLK\_INVALID**

Indication of the end of the available module clock sources

enum **soc\_periph\_systimer\_clk\_src\_t**

Type of SYSTIMER clock source.

*Values:*

enumerator **SYSTIMER\_CLK\_SRC\_XTAL**

SYSTIMER source clock is XTAL

enumerator **SYSTIMER\_CLK\_SRC\_RC\_FAST**

SYSTIMER source clock is RC\_FAST

enumerator **SYSTIMER\_CLK\_SRC\_DEFAULT**

SYSTIMER source clock default choice is XTAL

enum **soc\_periph\_gptimer\_clk\_src\_t**

Type of GPTimer clock source.

*Values:*

enumerator **GPTIMER\_CLK\_SRC\_PLL\_F48M**

Select PLL\_F48M as the source clock

enumerator **GPTIMER\_CLK\_SRC\_RC\_FAST**

Select RC\_FAST as the source clock

enumerator **GPTIMER\_CLK\_SRC\_XTAL**

Select XTAL as the source clock

enumerator **GPTIMER\_CLK\_SRC\_DEFAULT**

Select PLL\_F48M as the default choice

enum **soc\_periph\_tg\_clk\_src\_legacy\_t**

Type of Timer Group clock source, reserved for the legacy timer group driver.

*Values:*

enumerator **TIMER\_SRC\_CLK\_PLL\_F48M**

Timer group clock source is PLL\_F48M

enumerator **TIMER\_SRC\_CLK\_XTAL**

Timer group clock source is XTAL

enumerator **TIMER\_SRC\_CLK\_DEFAULT**

Timer group clock source default choice is PLL\_F48M

enum **soc\_periph\_rmt\_clk\_src\_t**

Type of RMT clock source.

*Values:*

enumerator **RMT\_CLK\_SRC\_RC\_FAST**

Select RC\_FAST as the source clock

enumerator **RMT\_CLK\_SRC\_XTAL**

Select XTAL as the source clock

enumerator **RMT\_CLK\_SRC\_DEFAULT**

Select XTAL as the default choice

enum **soc\_periph\_rmt\_clk\_src\_legacy\_t**

Type of RMT clock source, reserved for the legacy RMT driver.

*Values:*

enumerator **RMT\_BASECLK\_XTAL**

RMT source clock is XTAL

enumerator **RMT\_BASECLK\_DEFAULT**

RMT source clock default choice is XTAL

enum **soc\_periph\_temperature\_sensor\_clk\_src\_t**

Type of Temp Sensor clock source.

*Values:*

enumerator **TEMPERATURE\_SENSOR\_CLK\_SRC\_XTAL**

Select XTAL as the source clock

enumerator **TEMPERATURE\_SENSOR\_CLK\_SRC\_RC\_FAST**

Select RC\_FAST as the source clock

enumerator **TEMPERATURE\_SENSOR\_CLK\_SRC\_DEFAULT**

Select XTAL as the default choice

enum **soc\_periph\_uart\_clk\_src\_legacy\_t**

Type of UART clock source, reserved for the legacy UART driver.

*Values:*

enumerator **UART\_SCLK\_PLL\_F48M**

UART source clock is PLL\_F48M

enumerator **UART\_SCLK\_RTC**

UART source clock is RC\_FAST

enumerator **UART\_SCLK\_XTAL**

UART source clock is XTAL

enumerator **UART\_SCLK\_DEFAULT**

UART source clock default choice is PLL\_F48M

enum **soc\_periph\_mcpwm\_timer\_clk\_src\_t**

Type of MCPWM timer clock source.

*Values:*

enumerator **MCPWM\_TIMER\_CLK\_SRC\_PLL96M**

Select PLL\_F96M as the source clock

enumerator **MCPWM\_TIMER\_CLK\_SRC\_XTAL**

Select XTAL as the source clock

enumerator **MCPWM\_TIMER\_CLK\_SRC\_DEFAULT**

Select PLL\_F96M as the default clock choice

enum **soc\_periph\_mcpwm\_capture\_clk\_src\_t**

Type of MCPWM capture clock source.

*Values:*

enumerator **MCPWM\_CAPTURE\_CLK\_SRC\_PLL96M**

Select PLL\_F96M as the source clock

enumerator **MCPWM\_CAPTURE\_CLK\_SRC\_XTAL**

Select XTAL as the source clock

enumerator **MCPWM\_CAPTURE\_CLK\_SRC\_DEFAULT**

Select PLL\_F96M as the default clock choice

enum **soc\_periph\_mcpwm\_carrier\_clk\_src\_t**

Type of MCPWM carrier clock source.

*Values:*

enumerator **MCPWM\_CARRIER\_CLK\_SRC\_PLL96M**

Select PLL\_F96M as the source clock

enumerator **MCPWM\_CARRIER\_CLK\_SRC\_XTAL**

Select XTAL as the source clock

enumerator **MCPWM\_CARRIER\_CLK\_SRC\_DEFAULT**

Select PLL\_F96M as the default clock choice

enum **soc\_periph\_i2s\_clk\_src\_t**

I2S clock source enum.

*Values:*

enumerator **I2S\_CLK\_SRC\_DEFAULT**

Select PLL\_F96M as the default source clock

enumerator **I2S\_CLK\_SRC\_PLL\_96M**

Select PLL\_F96M as the source clock

enumerator **I2S\_CLK\_SRC\_PLL\_64M**

Select PLL\_F64M as the source clock

enumerator **I2S\_CLK\_SRC\_XTAL**

Select XTAL as the source clock

enumerator **I2S\_CLK\_SRC\_EXTERNAL**

Select external clock as source clock

enum **soc\_periph\_i2c\_clk\_src\_t**

Type of I2C clock source.

*Values:*

enumerator **I2C\_CLK\_SRC\_XTAL**

Select XTAL as the source clock

enumerator **I2C\_CLK\_SRC\_RC\_FAST**

Select RC\_FAST as the source clock

enumerator **I2C\_CLK\_SRC\_DEFAULT**

Select XTAL as the default source clock

enum **soc\_periph\_spi\_clk\_src\_t**

Type of SPI clock source.

*Values:*

enumerator **SPI\_CLK\_SRC\_DEFAULT**

Select PLL\_48M as SPI source clock

enumerator **SPI\_CLK\_SRC\_PLL\_F48M**

Select PLL\_48M as SPI source clock

enumerator **SPI\_CLK\_SRC\_XTAL**

Select XTAL as SPI source clock

enumerator **SPI\_CLK\_SRC\_RC\_FAST**

Select RC\_FAST as SPI source clock

enum **soc\_periph\_sdm\_clk\_src\_t**

Sigma Delta Modulator clock source.

*Values:*

enumerator **SDM\_CLK\_SRC\_XTAL**

Select XTAL clock as the source clock

enumerator **SDM\_CLK\_SRC\_PLL\_F48M**

Select PLL\_F48M clock as the source clock

enumerator **SDM\_CLK\_SRC\_DEFAULT**

Select PLL\_F48M as the default clock choice

enum **soc\_periph\_ana\_cmpr\_clk\_src\_t**

Sigma Delta Modulator clock source.

*Values:*

enumerator **ANA\_CMPR\_CLK\_SRC\_XTAL**

Select XTAL clock as the source clock

enumerator **ANA\_CMPR\_CLK\_SRC\_PLL\_F48M**

Select PLL\_F48M clock as the source clock

enumerator **ANA\_CMPR\_CLK\_SRC\_DEFAULT**

Select PLL\_F48M as the default clock choice

enum **soc\_periph\_glitch\_filter\_clk\_src\_t**

Glitch filter clock source.

*Values:*

enumerator **GLITCH\_FILTER\_CLK\_SRC\_XTAL**

Select XTAL clock as the source clock

enumerator **GLITCH\_FILTER\_CLK\_SRC\_PLL\_F48M**

Select PLL\_F48M clock as the source clock

enumerator **GLITCH\_FILTER\_CLK\_SRC\_DEFAULT**

Select PLL\_F48M clock as the default clock choice

enum **soc\_periph\_twai\_clk\_src\_t**

TWAI clock source.

*Values:*

enumerator **TWAI\_CLK\_SRC\_XTAL**

Select XTAL as the source clock

enumerator **TWAI\_CLK\_SRC\_DEFAULT**

Select XTAL as the default clock choice

enum **soc\_periph\_adc\_digi\_clk\_src\_t**

ADC digital controller clock source.

*Values:*

enumerator **ADC\_DIGI\_CLK\_SRC\_XTAL**

Select XTAL as the source clock

enumerator **ADC\_DIGI\_CLK\_SRC\_PLL\_F96M**

Select PLL\_F96M as the source clock

enumerator **ADC\_DIGI\_CLK\_SRC\_RC\_FAST**

Select RC\_FAST as the source clock

enumerator **ADC\_DIGI\_CLK\_SRC\_DEFAULT**

Select PLL\_F96M as the default clock choice

enum **soc\_periph\_mwdt\_clk\_src\_t**

MWDT clock source.

*Values:*

enumerator **MWDT\_CLK\_SRC\_XTAL**

Select XTAL as the source clock

enumerator **MWDT\_CLK\_SRC\_PLL\_F48M**

Select PLL fixed 48 MHz as the source clock

enumerator **MWDT\_CLK\_SRC\_RC\_FAST**

Select RTC fast as the source clock

enumerator **MWDT\_CLK\_SRC\_DEFAULT**

Select PLL as the default clock choice

enum **soc\_periph\_ledc\_clk\_src\_legacy\_t**

Type of LEDC clock source, reserved for the legacy LEDC driver.

*Values:*

enumerator **LEDC\_AUTO\_CLK**

LEDC source clock will be automatically selected based on the giving resolution and duty parameter when init the timer

enumerator **LEDC\_USE\_PLL\_DIV\_CLK**

Select PLL\_F96M clock as the source clock

enumerator **LEDC\_USE\_RC\_FAST\_CLK**

Select RC\_FAST as the source clock

enumerator **LEDC\_USE\_XTAL\_CLK**

Select XTAL as the source clock

enumerator **LEDC\_USE\_RTC8M\_CLK**

Alias of 'LEDC\_USE\_RC\_FAST\_CLK'

enum **soc\_periph\_parlio\_clk\_src\_t**

PARLIO clock source.

*Values:*

enumerator **PARLIO\_CLK\_SRC\_XTAL**

Select XTAL as the source clock

enumerator **PARLIO\_CLK\_SRC\_PLL\_F96M**

Select PLL\_F96M as the source clock

enumerator **PARLIO\_CLK\_SRC\_RC\_FAST**

Select RC\_FAST as the source clock

enumerator **PARLIO\_CLK\_SRC\_EXTERNAL**

Select EXTERNAL clock as the source clock

enumerator **PARLIO\_CLK\_SRC\_DEFAULT**

Select PLL\_F96M as the default clock choice

enum **soc\_periph\_mspi\_clk\_src\_t**

MSPI digital controller clock source.

*Values:*

enumerator **MSPI\_CLK\_SRC\_XTAL**

Select XTAL as the source clock

enumerator **MSPI\_CLK\_SRC\_RC\_FAST**

Select RC\_FAST as the source clock

enumerator **MSPI\_CLK\_SRC\_PLL\_F64M**

Select PLL\_F64M as the source clock

enumerator **MSPI\_CLK\_SRC\_PLL\_F48M**

Select PLL\_F48M as the source clock

enumerator **MSPI\_CLK\_SRC\_DEFAULT**

Select PLL\_F64M as the default clock choice

enumerator **MSPI\_CLK\_SRC\_ROM\_DEFAULT**

Select XTAL as ROM default clock source

enum **soc\_clkout\_sig\_id\_t**

*Values:*

enumerator **CLKOUT\_SIG\_XTAL**

Main crystal oscillator clock

enumerator **CLKOUT\_SIG\_CPU**

CPU clock

enumerator **CLKOUT\_SIG\_AHB**

AHB clock

enumerator **CLKOUT\_SIG\_APB**

APB clock

enumerator **CLKOUT\_SIG\_XTAL32K**

External 32kHz crystal clock

enumerator **CLKOUT\_SIG\_EXT32K**

External slow clock input through XTAL\_32K\_P

enumerator **CLKOUT\_SIG\_RC\_FAST**

RC fast clock, about 17.5MHz

enumerator **CLKOUT\_SIG\_RC\_32K**

Internal slow RC oscillator

enumerator **CLKOUT\_SIG\_RC\_SLOW**

RC slow clock, depends on the RTC\_CLK\_SRC configuration

enumerator **CLKOUT\_SIG\_INVALID**

## Header File

- [components/esp\\_hw\\_support/include/esp\\_clk\\_tree.h](#)
- This header file can be included with:

```
#include "esp_clk_tree.h"
```

## Functions

*esp\_err\_t* **esp\_clk\_tree\_src\_get\_freq\_hz** (*soc\_module\_clk\_t* clk\_src, *esp\_clk\_tree\_src\_freq\_precision\_t* precision, *uint32\_t* \*freq\_value)

Get frequency of module clock source.

### 参数

- **clk\_src** -- **[in]** Clock source available to modules, in *soc\_module\_clk\_t*
- **precision** -- **[in]** Degree of precision, one of *esp\_clk\_tree\_src\_freq\_precision\_t* values. This arg only applies to the clock sources that their frequencies can vary: *SOC\_MOD\_CLK\_RTC\_FAST*, *SOC\_MOD\_CLK\_RTC\_SLOW*, *SOC\_MOD\_CLK\_RC\_FAST*, *SOC\_MOD\_CLK\_RC\_FAST\_D256*, *SOC\_MOD\_CLK\_XTAL32K*. For other clock sources, this field is ignored.
- **freq\_value** -- **[out]** Frequency of the clock source, in Hz

### 返回

- *ESP\_OK* Success
- *ESP\_ERR\_INVALID\_ARG* Parameter error
- *ESP\_FAIL* Calibration failed



## Enumerations

enum `esp_clk_tree_src_freq_precision_t`

Degree of precision of frequency value to be returned by `esp_clk_tree_src_get_freq_hz()`

Values:

enumerator `ESP_CLK_TREE_SRC_FREQ_PRECISION_CACHED`

enumerator `ESP_CLK_TREE_SRC_FREQ_PRECISION_APPROX`

enumerator `ESP_CLK_TREE_SRC_FREQ_PRECISION_EXACT`

enumerator `ESP_CLK_TREE_SRC_FREQ_PRECISION_INVALID`

## 2.6.6 椭圆曲线数字签名算法 (ECDSA)

椭圆曲线数字签名算法 (ECDSA) 是数字签名算法 (DSA) 基于椭圆曲线密码学的变体。

ESP32-H2 的 ECDSA 外设为计算 ECDSA 签名提供了一个安全高效的环境，不仅能确保签名过程的机密性，防止信息泄露，也提供了快速的计算。在签名过程中使用的 ECDSA 私钥只能由硬件外设访问，软件无法读取。

ECDSA 外设可以为 TLS 双向身份验证等用例建立 **安全设备身份认证**。

### 支持的特性

- ECDSA 数字签名生成和验证
- 两种不同的椭圆曲线，P-192 和 P-256 (FIPS 186-3 规范)
- ECDSA 操作中哈希消息的两种哈希算法，SHA-224 和 SHA-256 (FIPS PUB 180-4 规范)

### ESP32-H2 上的 ECDSA

在 ESP32-H2 上，ECDSA 模块使用烧录到 eFuse 块中的密钥。密码模块外的任何资源都不可访问此密钥 (默认模式)，从而避免密钥泄露。

ECDSA 密钥可以通过 `espefuse.py` 脚本在外部编程：

```
espefuse.py burn_key <BLOCK_NUM> </path/to/ecdsa_private_key.pem> ECDSA_KEY
```

**备注：**五个物理 eFuse 块可作为 ECDSA 模块的密钥：块 4 ~ 块 8。例如，对于块 4 (第一个密钥块)，参数为 `BLOCK_KEY0`。

另外，ECDSA 密钥也可以通过在目标上运行的应用程序进行编程。

以下代码片段使用 `esp_efuse_write_key()` 将 eFuse 中的物理密钥块 0 的密钥目的设置为 `esp_efuse_purpose_t::ESP_EFUSE_KEY_PURPOSE_ECDSA_KEY`：

```
#include "esp_efuse.h"

const uint8_t key_data[32] = { ... };

esp_err_t status = esp_efuse_write_key(EFUSE_BLK_KEY0,
```

(下页继续)

```

        ESP_EFUSE_KEY_PURPOSE_ECDSA_KEY,
        key_data, sizeof(key_data));

if (status == ESP_OK) {
    // written key
} else {
    // writing key failed, maybe written already
}

```

## 生成非确定性签名

**对 TRNG 的依赖** ECDSA 外设依靠硬件真随机数生成器 (TRNG) 来满足其内部熵要求，从而生成非确定性签名。在创建 ECDSA 签名时，算法需要生成一个随机整数，在 [RFC 6090](#) 第 5.3.2 节有说明。

在应用程序中启动 ECDSA 计算（主要是签名）之前，请确保硬件 [RNG](#) 已经启用。

## 应用程序概述

有关如何使用 ECDSA 外设建立 TLS 双向身份验证连接的详细信息，请参阅在 [ESP-TLS 中使用 ECDSA 外设](#) 指南。

通过覆盖 ECDSA 签名以及验证 API，可以集成 Mbed TLS 堆栈中的 ECDSA 外设。请注意，ECDSA 外设并不支持所有曲线或哈希算法。因此，在不满足硬件要求时，实现会退回到软件。

对于特定的 TLS 上下文，可用额外的 API 来填充某些字段（例如私钥 `ctx`），以区分路由到硬件的路径。ESP-TLS 层在内部集成了这些 API，因此在应用程序层不需要额外的操作。对于自定义用例，请参阅以下 API 详细信息。

## API 参考

### Header File

- [components/mbedtls/port/include/ecdsa/ecdsa\\_alt.h](#)
- This header file can be included with:

```
#include "ecdsa/ecdsa_alt.h"
```

- This header file is a part of the API provided by the `mbedtls` component. To declare that your component depends on `mbedtls`, add the following to your `CMakeLists.txt`:

```
REQUIRES mbedtls
```

or

```
PRIV_REQUIRES mbedtls
```

### Functions

int `esp_ecdsa_load_pubkey` (`mbedtls_ecp_keypair *keypair`, int `efuse_blk`)

Populate the public key buffer of the `mbedtls_ecp_keypair` context.

#### 参数

- **keypair** -- The `mbedtls` ECP key-pair structure
- **efuse\_blk** -- The efuse key block that should be used as the private key. The key purpose of this block must be `ECDSA_KEY`

返回 - 0 if successful

- `MBEDTLS_ERR_ECP_BAD_INPUT_DATA` if invalid ecp group id specified
- `MBEDTLS_ERR_ECP_INVALID_KEY` if efuse block with purpose `ECDSA_KEY` is not found

- -1 if invalid efuse block is specified

int **esp\_ecdsa\_privkey\_load\_mpi** (mbedtls\_mpi \*key, int efuse\_blk)

Initialize MPI to notify mbedtls\_ecdsa\_sign to use the private key in efuse. We break the MPI struct of the private key in order to differentiate between hardware key and software key.

#### 参数

- **key** -- The MPI in which this functions stores the hardware context. This must be uninitialized
- **efuse\_blk** -- The efuse key block that should be used as the private key. The key purpose of this block must be ECDSA\_KEY

返回 - 0 if successful

- -1 otherwise

int **esp\_ecdsa\_privkey\_load\_pk\_context** (mbedtls\_pk\_context \*key\_ctx, int efuse\_blk)

Initialize PK context to notify mbedtls\_ecdsa\_sign to use the private key in efuse. We break the MPI struct used to represent the private key  $d$  in ECP keypair in order to differentiate between hardware key and software key.

#### 参数

- **key\_ctx** -- The context in which this functions stores the hardware context. This must be uninitialized
- **efuse\_blk** -- The efuse key block that should be used as the private key. The key purpose of this block must be ECDSA\_KEY

返回 - 0 if successful

- -1 otherwise

int **esp\_ecdsa\_set\_pk\_context** (mbedtls\_pk\_context \*key\_ctx, *esp\_ecdsa\_pk\_conf\_t* \*conf)

Initialize PK context and completely populate mbedtls\_ecp\_keypair context. We break the MPI struct used to represent the private key  $d$  in ECP keypair in order to differentiate between hardware key and software key. We also populate the ECP group field present in the mbedtls\_ecp\_keypair context. If the ECDSA peripheral of the chip supports exporting the public key, we can also populate the public key buffer of the mbedtls\_ecp\_keypair context if the load\_pubkey flag is set in the *esp\_ecdsa\_pk\_conf\_t* config argument.

#### 参数

- **key\_ctx** -- The context in which this functions stores the hardware context. This must be uninitialized
- **conf** -- ESP-ECDSA private key context initialization config structure

返回 - 0 if successful

- -1 otherwise

## Structures

struct **esp\_ecdsa\_pk\_conf\_t**

ECDSA private key context initialization config structure.

---

**备注:** Contains configuration information like the efuse key block that should be used as the private key, EC group ID of the private key and if the export public key operation is supported by the peripheral, a flag load\_pubkey that is used specify if the public key has to be populated

---

## Public Members

mbedtls\_ecp\_group\_id **grp\_id**

MbedTLS ECP group identifier

uint8\_t **efuse\_block**

EFuse block id for ECDSA private key

**bool use\_km\_key**

Use key deployed in the key manager for ECDSA operation. Note: The key must be already deployed by the application and it must be activated for the lifetime of this context

**Macros**

**USE\_ECDSA\_KEY\_FROM\_KEY\_MANAGER**

**2.6.7 事件任务矩阵 (ETM)****简介**

如果外设 X 需要向外设 Y 发起事件通知，一般只能通过 CPU 中断实现。在此过程中，CPU 会代表外设 X，给外设 Y 发送通知。然而，在对时间敏感的应用程序中，CPU 中断引发的延迟不容忽视。

通过引入事件任务矩阵 (ETM) 模块，部分外设可以直接通过预先设置的连接关系，将事件通知发送给其他外设，无需 CPU 中断介入。由此，外设实现精确、低延迟同步，并减轻 CPU 负担。



图 3: ETM 通道概述

ETM 模块具有多个通道，这些通道支持用户根据需要进行配置，连接特定 **事件**与 **任务**。激活某一事件时，ETM 将自动触发相应任务。

支持 ETM 功能的外设向 ETM 提供其事件和任务的连接关系。ETM 通道可以连接任意事件和任务，事件和任务甚至可以来自于同一个外设。然而，对于一个 ETM 通道，一次只能将一个事件与一个任务连接（即 1 对 1 关系）。如果要使用不同事件触发同一任务，则需申请多条 ETM 通道。

使用 ETM 通常可实现以下功能：

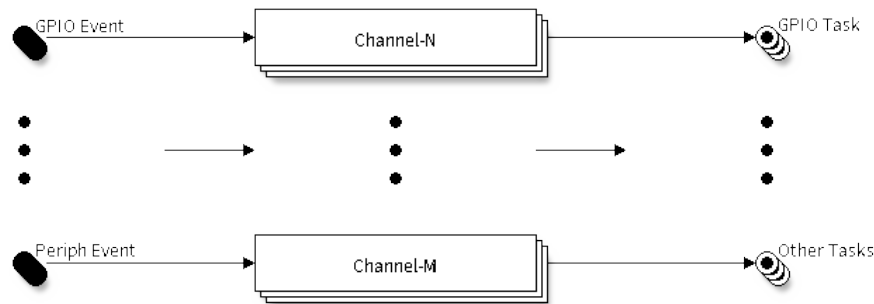
- 当定时器报警事件发生时，翻转 GPIO 电平
- 当在 GPIO 上监测到脉冲边沿时，启动 ADC 转换

**功能概述**

下文将分节概述 ETM 的功能，并介绍配置和使用 ETM 模块的基本步骤：

- **ETM 通道分配** - 介绍如何安装和卸载 ETM 通道。
- **ETM 事件** - 介绍如何分配新的 ETM 事件句柄，以及如何从不同外设获取现有句柄。
- **ETM 任务** - 介绍如何分配新的 ETM 任务句柄，以及如何从不同外设获取现有句柄。
- **ETM 通道控制** - 介绍常见的 ETM 通道控制函数。
- **线程安全** - 列出了驱动程序中始终线程安全的 API。
- **Kconfig 选项** - 列出了 ETM 支持的 Kconfig 选项，这些选项对驱动程序的行为会产生不同影响。

**ETM 通道分配** 在 ESP32-H2 中，存在许多相同的 ETM 通道<sup>1</sup>，各通道在软件中由 `esp_etm_channel_handle_t` 表示。可用硬件资源汇集在资源池内，由 ETM 核心驱动程序管理，无需手动管理通道的分配和释放。ETM 核心驱动程序会在调用 `esp_etm_new_channel()` 时自动分配通道，在调用 `esp_etm_del_channel()` 时删除通道。分配通道的要求通过 `esp_etm_channel_config_t` 配置。

在删除 ETM 通道前，请调用 `esp_etm_channel_disable()` 禁用要删除的通道，或确保该通道尚未由 `esp_etm_channel_enable()` 启用，再继续删除操作。

**ETM 事件** ETM 事件对其事件源进行了抽象，屏蔽了具体事件源的细节，并在软件中表示为 `esp_etm_event_handle_t`，使应用程序可以更便捷地处理不同类型的事件。ETM 事件可以由各种外设产生，因此获取事件句柄的方法因外设而异。当不再需要某个事件时，请调用 `esp_etm_channel_connect()`，并传递一个 NULL 事件句柄，断开与事件的连接，随后调用 `esp_etm_del_event()`，释放事件资源。

**GPIO 事件** GPIO 边沿事件是最常见的事件类型，任何 GPIO 管脚均可触发这类事件。要创建 GPIO 事件句柄，请调用 `gpio_new_etm_event()`，并使用 `gpio_etm_event_config_t` 提供的配置信息：

- `gpio_etm_event_config_t::edge` 或 `gpio_etm_event_config_t::edges` 决定触发事件的边沿类型，支持的边沿类型已在 `gpio_etm_event_edge_t` 中列出。

接下来，请调用 `gpio_etm_event_bind_gpio()` 函数，连接 GPIO ETM 事件句柄与 GPIO 管脚。注意，要设置 GPIO 管脚，只能使用由 `gpio_new_etm_event()` 函数创建的 ETM 事件句柄。对于其他类型的 ETM 事件，调用此函数，将返回 `ESP_ERR_INVALID_ARG` 错误。该函数也无法完成 GPIO 的初始化，在使用 GPIO ETM 事件之前，仍需调用 `gpio_config()` 函数，设置 GPIO 管脚的属性，如方向、高/低电平模式等。

### 其他外设事件

- 调用 `esp_systick_new_etm_alarm_event()` 可以从 RTOS SysTick 获取 ETM 事件句柄，每个 CPU 核心可以获取一个事件句柄。
- 要了解如何从 `esp_timer` 获取 ETM 事件句柄，请参阅 [ESP 定时器](#)。
- 要了解如何从 GPTimer 获取 ETM 事件句柄，请参阅 [通用定时器](#)。
- 要了解如何从 `async memcopy` 获取 ETM 事件句柄，请参阅 [异步内存复制](#)。
- 要了解如何从 MCPWM 中获取 ETM 事件句柄，请参阅 [电机控制脉宽调制器 \(MCPWM\)](#)。

**ETM 任务** ETM 任务对其操作进行了抽象，在软件中表示为 `esp_etm_task_handle_t`，使任务得以用同一方式管理和表示。ETM 任务可以分配给不同外设，因此获取任务句柄的方式因外设而异。当不再需要某个任务时，请调用 `esp_etm_channel_connect()`，并传递一个 NULL 事件句柄，断开与任务的连接，随后调用 `esp_etm_del_event()`，释放任务资源。

**GPIO 任务** GPIO 任务是最常见的任务类型。一个 GPIO 可以采取一个或多个 GPIO 操作，而一个 GPIO 任务也可以同时管理多个 GPIO 管脚。当 ETM 通道激活任务时，任务可以同时设置管理的所有 GPIO 引脚，使其设置/清除/切换状态。要创建 GPIO 任务句柄，请调用 `gpio_new_etm_task()`，并使用 `gpio_etm_task_config_t` 提供的配置信息：

- `gpio_etm_task_config_t::action` 或 `gpio_etm_task_config_t::actions` 决定 ETM 任务将采取的 GPIO 操作，支持的操作类型在 `gpio_etm_task_action_t` 中列出。如果一个 GPIO 需要采取多个 GPIO 操作，这些操作任务的创建必须通过配置 `gpio_etm_task_config_t::actions` 的数组并在一次 `gpio_new_etm_task()` 调用中一并完成。

接下来，需要连接 GPIO ETM 任务句柄与 GPIO 管脚。为此，请调用 `gpio_etm_task_add_gpio()` 函数。如果需要任务句柄管理更多的 GPIO 管脚，可以重复调用以上函数，注意，要设置 GPIO 管脚，只能

<sup>1</sup> 不同 ESP 芯片系列的 ETM 通道数量可能不同。要了解更多详情，请参阅 [ESP32-H2 技术参考手册 > 事件任务矩阵 \(ETM\) \[PDF\]](#)。驱动程序对通道申请数量不做限制，但当硬件资源用尽时，驱动程序将返回错误。因此，每次进行通道分配（即调用 `esp_etm_new_channel()`）时，请注意检查返回值。

使用由 `gpio_new_etm_task()` 函数创建的 ETM 任务句柄。对于其他类型的 ETM 任务，调用此函数，将返回 `ESP_ERR_INVALID_ARG` 错误。该函数也无法完成 GPIO 的初始化，在使用 GPIO ETM 任务之前，仍需调用 `gpio_config()` 函数，设置 GPIO 管脚的属性，如方向、高/低电平模式等。

要删除 GPIO ETM 任务，请调用 `esp_etm_del_task()`。在此之前，请确保已经调用过 `gpio_etm_task_rm_gpio()`，删除了所有先前添加的 GPIO 管脚。

### 其他外设任务

- 要了解如何从 GPTimer 获取 ETM 任务句柄，请参阅[通用定时器](#)。

### ETM 通道控制

**映射事件与任务** 在调用 `esp_etm_channel_connect()` 将它们连接到同一个 ETM 通道之前，ETM 事件与 ETM 任务之间没有任何映射关系。注意，使用 NULL 任务/事件句柄调用该函数时，会将通道与任何任务或事件解除映射。此函数可以在通道启用之前或之后调用，但在运行时调用此函数更改映射关系存在一定风险，因为此时通道可能正处于周期的中间阶段，新的映射可能无法立即生效。

**启用及禁用通道** 调用 `esp_etm_channel_enable()` 启用 ETM 通道，调用 `esp_etm_channel_disable()` 禁用 ETM 通道。

**ETM 通道分析** 要检查是否为 ETM 通道设置了正确的事件和任务，可以调用 `esp_etm_dump()`，输出所有工作中的 ETM 通道及其关联的事件和任务。输出格式如下：

```
=====ETM Dump Start=====
channel 0: event 48 ==> task 17
channel 1: event 48 ==> task 90
channel 2: event 48 ==> task 94
=====ETM Dump End=====
```

以上输出信息打印的数字 ID 在 `soc/soc_etm_source.h` 文件中定义。

**线程安全** ETM 驱动程序会确保工厂函数 `esp_etm_new_channel()` 和 `gpio_new_etm_task()` 的线程安全。使用时，可以直接从不同的 RTOS 任务中调用此类函数，无需额外锁保护。

在 ISR 环境中，不支持运行任何函数。

其他以 `esp_etm_channel_handle_t`、`esp_etm_task_handle_t` 和 `esp_etm_event_handle_t` 作为首个位置参数的函数，则非线程安全，应避免从不同任务中调用此类函数。

### Kconfig 选项

- `CONFIG_ETM_ENABLE_DEBUG_LOG` 用于启用调试日志输出，启用此选项将增加固件的二进制文件大小。

### API 参考

#### Header File

- `components/esp_hw_support/include/esp_etm.h`
- This header file can be included with:

```
#include "esp_etm.h"
```



**Functions**

*esp\_err\_t* **esp\_etm\_new\_channel** (const *esp\_etm\_channel\_config\_t* \*config, *esp\_etm\_channel\_handle\_t* \*ret\_chan)

Allocate an ETM channel.

---

**备注:** The channel can later be freed by `esp_etm_del_channel`

---

**参数**

- **config** -- **[in]** ETM channel configuration
- **ret\_chan** -- **[out]** Returned ETM channel handle

**返回**

- ESP\_OK: Allocate ETM channel successfully
- ESP\_ERR\_INVALID\_ARG: Allocate ETM channel failed because of invalid argument
- ESP\_ERR\_NO\_MEM: Allocate ETM channel failed because of out of memory
- ESP\_ERR\_NOT\_FOUND: Allocate ETM channel failed because all channels are used up and no more free one
- ESP\_FAIL: Allocate ETM channel failed because of other reasons

*esp\_err\_t* **esp\_etm\_del\_channel** (*esp\_etm\_channel\_handle\_t* chan)

Delete an ETM channel.

**参数** **chan** -- **[in]** ETM channel handle that created by `esp_etm_new_channel`

**返回**

- ESP\_OK: Delete ETM channel successfully
- ESP\_ERR\_INVALID\_ARG: Delete ETM channel failed because of invalid argument
- ESP\_FAIL: Delete ETM channel failed because of other reasons

*esp\_err\_t* **esp\_etm\_channel\_enable** (*esp\_etm\_channel\_handle\_t* chan)

Enable ETM channel.

---

**备注:** This function will transit the channel state from init to enable.

---

**参数** **chan** -- **[in]** ETM channel handle that created by `esp_etm_new_channel`

**返回**

- ESP\_OK: Enable ETM channel successfully
- ESP\_ERR\_INVALID\_ARG: Enable ETM channel failed because of invalid argument
- ESP\_ERR\_INVALID\_STATE: Enable ETM channel failed because the channel has been enabled already
- ESP\_FAIL: Enable ETM channel failed because of other reasons

*esp\_err\_t* **esp\_etm\_channel\_disable** (*esp\_etm\_channel\_handle\_t* chan)

Disable ETM channel.

---

**备注:** This function will transit the channel state from enable to init.

---

**参数** **chan** -- **[in]** ETM channel handle that created by `esp_etm_new_channel`

**返回**

- ESP\_OK: Disable ETM channel successfully
- ESP\_ERR\_INVALID\_ARG: Disable ETM channel failed because of invalid argument
- ESP\_ERR\_INVALID\_STATE: Disable ETM channel failed because the channel is not enabled yet
- ESP\_FAIL: Disable ETM channel failed because of other reasons

*esp\_err\_t* **esp\_etm\_channel\_connect** (*esp\_etm\_channel\_handle\_t* chan, *esp\_etm\_event\_handle\_t* event, *esp\_etm\_task\_handle\_t* task)

Connect an ETM event to an ETM task via a previously allocated ETM channel.

---

**备注:** Setting the ETM event/task handle to NULL means to disconnect the channel from any event/task

---

#### 参数

- **chan** -- **[in]** ETM channel handle that created by `esp_etm_new_channel`
- **event** -- **[in]** ETM event handle obtained from a driver/peripheral, e.g. `xxx_new_etm_event`
- **task** -- **[in]** ETM task handle obtained from a driver/peripheral, e.g. `xxx_new_etm_task`

#### 返回

- **ESP\_OK**: Connect ETM event and task to the channel successfully
- **ESP\_ERR\_INVALID\_ARG**: Connect ETM event and task to the channel failed because of invalid argument
- **ESP\_FAIL**: Connect ETM event and task to the channel failed because of other reasons

*esp\_err\_t* **esp\_etm\_del\_event** (*esp\_etm\_event\_handle\_t* event)

Delete ETM event.

---

**备注:** Although the ETM event comes from various peripherals, we provide the same user API to delete the event handle seamlessly.

---

**参数** **event** -- **[in]** ETM event handle obtained from a driver/peripheral, e.g. `xxx_new_etm_event`

#### 返回

- **ESP\_OK**: Delete ETM event successfully
- **ESP\_ERR\_INVALID\_ARG**: Delete ETM event failed because of invalid argument
- **ESP\_FAIL**: Delete ETM event failed because of other reasons

*esp\_err\_t* **esp\_etm\_del\_task** (*esp\_etm\_task\_handle\_t* task)

Delete ETM task.

---

**备注:** Although the ETM task comes from various peripherals, we provide the same user API to delete the task handle seamlessly.

---

**参数** **task** -- **[in]** ETM task handle obtained from a driver/peripheral, e.g. `xxx_new_etm_task`

#### 返回

- **ESP\_OK**: Delete ETM task successfully
- **ESP\_ERR\_INVALID\_ARG**: Delete ETM task failed because of invalid argument
- **ESP\_FAIL**: Delete ETM task failed because of other reasons

*esp\_err\_t* **esp\_etm\_dump** (FILE \*out\_stream)

Dump ETM channel usages to the given IO stream.

**参数** **out\_stream** -- **[in]** IO stream (e.g. stdout)

#### 返回

- **ESP\_OK**: Dump ETM channel usages successfully
- **ESP\_ERR\_INVALID\_ARG**: Dump ETM channel usages failed because of invalid argument
- **ESP\_FAIL**: Dump ETM channel usages failed because of other reasons



## Structures

struct **esp\_etm\_channel\_config\_t**

ETM channel configuration.

## Type Definitions

typedef struct esp\_etm\_channel\_t \***esp\_etm\_channel\_handle\_t**

ETM channel handle.

typedef struct esp\_etm\_event\_t \***esp\_etm\_event\_handle\_t**

ETM event handle.

typedef struct esp\_etm\_task\_t \***esp\_etm\_task\_handle\_t**

ETM task handle.

## Header File

- [components/esp\\_driver\\_gpio/include/driver/gpio\\_etm.h](#)
- This header file can be included with:

```
#include "driver/gpio_etm.h"
```

- This header file is a part of the API provided by the `esp_driver_gpio` component. To declare that your component depends on `esp_driver_gpio`, add the following to your `CMakeLists.txt`:

```
REQUIRES esp_driver_gpio
```

or

```
PRIV_REQUIRES esp_driver_gpio
```

## Functions

`esp_err_t` **gpio\_new\_etm\_event** (const `gpio_etm_event_config_t` \*config, `esp_etm_event_handle_t` \*ret\_event, ...)

Create an ETM event object for the GPIO peripheral.

---

**备注:** The created ETM event object can be deleted later by calling `esp_etm_del_event`

---

---

**备注:** The newly created ETM event object is not bind to any GPIO, you need to call `gpio_etm_event_bind_gpio` to bind the wanted GPIO

---

---

**备注:** Every success call to this function will acquire a free GPIO ETM event channel

---

### 参数

- **config** -- **[in]** GPIO ETM event configuration
- **ret\_event** -- **[out]** Returned ETM event handle
- ... -- **[out]** Other returned ETM event handles if any (the order of the returned event handles is aligned with the array order in field `edges` in `gpio_etm_event_config_t`)

### 返回

- `ESP_OK`: Create ETM event successfully
- `ESP_ERR_INVALID_ARG`: Create ETM event failed because of invalid argument

- `ESP_ERR_NO_MEM`: Create ETM event failed because of out of memory
- `ESP_ERR_NOT_FOUND`: Create ETM event failed because all events are used up and no more free one
- `ESP_FAIL`: Create ETM event failed because of other reasons

*esp\_err\_t* `gpio_etm_event_bind_gpio` (*esp\_etm\_event\_handle\_t* event, int gpio\_num)

Bind the GPIO with the ETM event.

---

**备注:** Calling this function multiple times with different GPIO number can override the previous setting immediately.

---



---

**备注:** Only GPIO ETM object can call this function

---

#### 参数

- **event** -- **[in]** ETM event handle that created by `gpio_new_etm_event`
- **gpio\_num** -- **[in]** GPIO number that can trigger the ETM event

#### 返回

- `ESP_OK`: Set the GPIO for ETM event successfully
- `ESP_ERR_INVALID_ARG`: Set the GPIO for ETM event failed because of invalid argument, e.g. GPIO is not input capable, ETM event is not of GPIO type
- `ESP_FAIL`: Set the GPIO for ETM event failed because of other reasons

*esp\_err\_t* `gpio_new_etm_task` (const *gpio\_etm\_task\_config\_t* \*config, *esp\_etm\_task\_handle\_t* \*ret\_task, ...)

Create an ETM task object for the GPIO peripheral.

---

**备注:** The created ETM task object can be deleted later by calling `esp_etm_del_task`

---



---

**备注:** The GPIO ETM task works like a container, a newly created ETM task object doesn't have GPIO members to be managed. You need to call `gpio_etm_task_add_gpio` to put one or more GPIOs to the container.

---



---

**备注:** Every success call to this function will acquire a free GPIO ETM task channel

---

#### 参数

- **config** -- **[in]** GPIO ETM task configuration
- **ret\_task** -- **[out]** Returned ETM task handle
- ... -- **[out]** Other returned ETM task handles if any (the order of the returned task handles is aligned with the array order in field `actions` in `gpio_etm_task_config_t`)

#### 返回

- `ESP_OK`: Create ETM task successfully
- `ESP_ERR_INVALID_ARG`: Create ETM task failed because of invalid argument
- `ESP_ERR_NO_MEM`: Create ETM task failed because of out of memory
- `ESP_ERR_NOT_FOUND`: Create ETM task failed because all tasks are used up and no more free one
- `ESP_FAIL`: Create ETM task failed because of other reasons

*esp\_err\_t* `gpio_etm_task_add_gpio` (*esp\_etm\_task\_handle\_t* task, int gpio\_num)

Add GPIO to the ETM task.

---

**备注:** You can call this function multiple times to add more GPIOs

---



---

**备注:** Only GPIO ETM object can call this function

---

#### 参数

- **task** -- **[in]** ETM task handle that created by `gpio_new_etm_task`
- **gpio\_num** -- **[in]** GPIO number that can be controlled by the ETM task

#### 返回

- ESP\_OK: Add GPIO to the ETM task successfully
- ESP\_ERR\_INVALID\_ARG: Add GPIO to the ETM task failed because of invalid argument, e.g. GPIO is not output capable, ETM task is not of GPIO type
- ESP\_ERR\_INVALID\_STATE: Add GPIO to the ETM task failed because the GPIO is used by other ETM task already
- ESP\_FAIL: Add GPIO to the ETM task failed because of other reasons

*esp\_err\_t* `gpio_etm_task_rm_gpio` (*esp\_etm\_task\_handle\_t* task, int gpio\_num)

Remove the GPIO from the ETM task.

---

**备注:** Before deleting the ETM task, you need to remove all the GPIOs from the ETM task by this function

---



---

**备注:** Only GPIO ETM object can call this function

---

#### 参数

- **task** -- **[in]** ETM task handle that created by `gpio_new_etm_task`
- **gpio\_num** -- **[in]** GPIO number that to be remove from the ETM task

#### 返回

- ESP\_OK: Remove the GPIO from the ETM task successfully
- ESP\_ERR\_INVALID\_ARG: Remove the GPIO from the ETM task failed because of invalid argument
- ESP\_ERR\_INVALID\_STATE: Remove the GPIO from the ETM task failed because the GPIO is not controlled by this ETM task
- ESP\_FAIL: Remove the GPIO from the ETM task failed because of other reasons

## Structures

struct `gpio_etm_event_config_t`

GPIO ETM event configuration.

If more than one kind of ETM edge event want to be triggered on the same GPIO pin, you can configure them together. It helps to save GPIO ETM event channel resources for other GPIOs.

## Public Members

*gpio\_etm\_event\_edge\_t* `edge`

Which kind of edge can trigger the ETM event module

*gpio\_etm\_event\_edge\_t* `edges`[GPIO\_ETM\_EVENT\_EDGE\_TYPES]

Array of kinds of edges to trigger the ETM event module on the same GPIO

struct **gpio\_etm\_task\_config\_t**

GPIO ETM task configuration.

If multiple actions wants to be added to the same GPIO pin, you have to configure all the GPIO ETM tasks together.

### Public Members

*gpio\_etm\_task\_action\_t* **action**

Action to take by the ETM task module

*gpio\_etm\_task\_action\_t* **actions**[GPIO\_ETM\_TASK\_ACTION\_TYPES]

Array of actions to take by the ETM task module on the same GPIO

### Macros

**GPIO\_ETM\_EVENT\_EDGE\_TYPES**

GPIO ETM edge events are POS/NEG/ANY

**GPIO\_ETM\_TASK\_ACTION\_TYPES**

GPIO ETM action tasks are SET/CLEAR/TOGGLE

### Enumerations

enum **gpio\_etm\_event\_edge\_t**

GPIO edges that can be used as ETM event.

*Values:*

enumerator **GPIO\_ETM\_EVENT\_EDGE\_POS**

A rising edge on the GPIO will generate an ETM event signal

enumerator **GPIO\_ETM\_EVENT\_EDGE\_NEG**

A falling edge on the GPIO will generate an ETM event signal

enumerator **GPIO\_ETM\_EVENT\_EDGE\_ANY**

Any edge on the GPIO can generate an ETM event signal

enum **gpio\_etm\_task\_action\_t**

GPIO actions that can be taken by the ETM task.

*Values:*

enumerator **GPIO\_ETM\_TASK\_ACTION\_SET**

Set the GPIO level to high

enumerator **GPIO\_ETM\_TASK\_ACTION\_CLR**

Clear the GPIO level to low

enumerator **GPIO\_ETM\_TASK\_ACTION\_TOG**

Toggle the GPIO level

### Header File

- `components/esp_system/include/esp_systick_etm.h`
- This header file can be included with:

```
#include "esp_systick_etm.h"
```

### Functions

`esp_err_t esp_systick_new_etm_alarm_event` (int core\_id, `esp_etm_event_handle_t` \*out\_event)

Get the ETM event handle of systick hardware's alarm/heartbeat event.

---

备注: The created ETM event object can be deleted later by calling `esp_etm_del_event`

---

#### 参数

- **core\_id** -- [in] CPU core ID
- **out\_event** -- [out] Returned ETM event handle

#### 返回

- ESP\_OK Success
- ESP\_ERR\_INVALID\_ARG Parameter error

## 2.6.8 GPIO & RTC GPIO

### GPIO 汇总

ESP32-H2 芯片具有 28 个物理 GPIO 管脚 (GPIO0 ~ GPIO27)。

每个管脚都可用作一个通用 IO，或连接一个内部的外设信号。通过 GPIO 交换矩阵和 IO MUX，可配置外设模块的输入信号来源于任何的 IO 管脚，并且外设模块的输出信号也可连接到任意 IO 管脚。这些模块共同组成了芯片的 IO 控制。更多详细信息，请参阅 *ESP32-H2 技术参考手册 > IO MUX 和 GPIO 矩阵 (GPIO、IO\_MUX)* [PDF]。

下表提供了各管脚的详细信息，部分 GPIO 具有特殊的使用限制，具体可参考表中的注释列。

GPIO	模拟功能	注释
GPIO0		
GPIO1	ADC1_CH0	
GPIO2	ADC1_CH1	Strapping 管脚
GPIO3	ADC1_CH2	Strapping 管脚
GPIO4	ADC1_CH3	
GPIO5	ADC1_CH4	
GPIO6		
GPIO7		RTC
GPIO8		Strapping 管脚, RTC
GPIO9		Strapping 管脚, RTC
GPIO10	ANA_CMPR_CH0 外部参考电压	RTC
GPIO11	ANA_CMPR_CH0 同相输入	RTC
GPIO12		RTC
GPIO13		RTC
GPIO14		RTC
GPIO15		SPI0/1
GPIO16		SPI0/1
GPIO17		SPI0/1
GPIO18		SPI0/1
GPIO19		SPI0/1
GPIO20		SPI0/1
GPIO21		SPI0/1
GPIO22		
GPIO23		
GPIO24		
GPIO25		Strapping 管脚
GPIO26		USB-JTAG
GPIO27		USB-JTAG

**备注:**

- Strapping 管脚: GPIO2、GPIO3、GPIO8、GPIO9 和 GPIO25 是 Strapping 管脚。更多信息请参考 [ESP32-H2 技术规格书](#)。
- SPI0/1: GPIO15-21 通常用于 SPI flash, 不推荐用于其他用途。
- USB-Serial-JTAG: GPIO26 和 GPIO27 默认用于 USB-Serial-JTAG。用做 GPIO 时驱动程序将禁用 USB-Serial-JTAG。
- 对于合封了 flash 的芯片型号, GPIO15 ~ GPIO21 专门用于连接该 flash, 并未引出至芯片管脚。且 GPIO6 ~ GPIO7 也未引出至芯片管脚, 用户不可用。用户可配置使用其他剩余的 19 个 GPIO 管脚, 编号为: GPIO0 ~ GPIO5、GPIO8 ~ GPIO14、GPIO22 ~ GPIO27。
- RTC: GPIO7-14 可用于将芯片从 Deep-sleep 模式中唤醒, 其他 GPIO 仅能将芯片从 Light-sleep 模式中唤醒。更多信息请参考 [唤醒源](#) 章节。

**获取 IO 管脚实时配置状态**

GPIO 驱动提供了一个函数 `gpio_dump_io_configuration()` 用来输出指定管脚的实时配置状态, 包括上下拉、输入输出使能、管脚映射等。例如, 以下命令可用于输出 GPIO4, GPIO8 与 GPIO26 的配置状态:

```
gpio_dump_io_configuration(stdout, (1ULL << 4) | (1ULL << 18) | (1ULL << 26));
```

其输出信息如下:

```

=====IO DUMP Start=====
IO[4] -
  Pullup: 1, Pulldown: 0, DriveCap: 2
  InputEn: 1, OutputEn: 0, OpenDrain: 0
  FuncSel: 1 (GPIO)
  GPIO Matrix SigIn ID: (simple GPIO input)
  SleepSelEn: 1

IO[18] -
  Pullup: 0, Pulldown: 0, DriveCap: 2
  InputEn: 0, OutputEn: 1, OpenDrain: 0
  FuncSel: 1 (GPIO)
  GPIO Matrix SigOut ID: 256 (simple GPIO output)
  SleepSelEn: 1

IO[26] **RESERVED** -
  Pullup: 1, Pulldown: 0, DriveCap: 2
  InputEn: 1, OutputEn: 0, OpenDrain: 0
  FuncSel: 0 (IOMUX)
  SleepSelEn: 1

=====IO DUMP End=====

```

如果你想要查看所有管脚的配置状态，可以使用命令

```
gpio_dump_all_io_configuration(stdout, SOC_GPIO_VALID_GPIO_MASK);
```

如果 IO 管脚通过 GPIO 交换矩阵连接到内部外设信号，输出信息打印中的外设信号 ID 定义可以在 [soc/esp32h2/include/soc/gpio\\_sig\\_map.h](#) 头文件中查看。**\*\*RESERVED\*\*** 字样则表示此 IO 用于连接 SPI flash 或 PSRAM，强烈建议不要重新配置这些管脚用于其他功能。

请不要依赖技术参考手册中记录的 GPIO 默认配置状态，因为特殊用途的 GPIO 可能会在 `app_main` 之前被引导程序或应用程序启动阶段的代码更改。

### 配置 USB PHY 管脚为普通 GPIO 管脚

要将 USB PHY 管脚配置为普通 GPIO 管脚，可使用函数 `gpio_config()`，请参考以下代码片段来进行配置。

```

gpio_config_t usb_phy_conf = {
    .pin_bit_mask = (1ULL << USB_PHY_DP_PIN) | (1ULL << USB_PHY_DM_PIN),
    .mode = GPIO_MODE_INPUT_OUTPUT,
    .pull_up_en = 0,
    .pull_down_en = 0,
    .intr_type = GPIO_INTR_DISABLE,
};
gpio_config(&usb_phy_conf);

```

### GPIO 毛刺过滤器

ESP32-H2 内置硬件的过滤器可以过滤掉 GPIO 输入端口上的毛刺信号，在一定程度上避免错误触发中断或者是错把噪声当成有效的外设信号。

每个 GPIO 都可以使用独立的毛刺过滤器，该过滤器可以将那些脉冲宽度窄于 2 个采样时钟的信号剔除掉，该宽度无法配置。GPIO 对输入信号的采样时钟通常是 IO\_MUX 的时钟源。在驱动中，此类过滤器称为 管脚毛刺过滤器。可以调用 `gpio_new_pin_glitch_filter()` 函数创建一个过滤器句柄。过滤器的相关配置保存在 `gpio_pin_glitch_filter_config_t` 结构体中。

- `gpio_pin_glitch_filter_config_t::gpio_num` 设置启用毛刺过滤器的 GPIO 编号。

ESP32-H2 提供了 8 个灵活的毛刺过滤器，被过滤信号的脉冲宽度可以由软件进行配置。此类过滤器则称为灵活毛刺过滤器。每个过滤器都可以应用于任意 GPIO 输入，然而，将多个过滤器应用于同一 GPIO 上效果并不会叠加。可以调用 `gpio_new_flex_glitch_filter()` 函数来创建一个过滤器句柄。过滤器的相关配置保存在 `gpio_flex_glitch_filter_config_t` 结构体中。

- `gpio_flex_glitch_filter_config_t::gpio_num` 设置启用毛刺过滤器的 GPIO 编号。
- `gpio_flex_glitch_filter_config_t::window_width_ns` 和 `gpio_flex_glitch_filter_config_t::window_thres_ns` 是毛刺过滤器的关键参数。在 `gpio_flex_glitch_filter_config_t::window_width_ns` 时间内，任何脉冲信号，如果它的宽度小于 `gpio_flex_glitch_filter_config_t::window_thres_ns`，那么该脉冲信号就会被滤除掉。`gpio_flex_glitch_filter_config_t::window_thres_ns` 的值不能大于 `gpio_flex_glitch_filter_config_t::window_width_ns`。

请注意，管脚毛刺过滤器和灵活毛刺过滤器是各自独立的，支持为同一 GPIO 同时启用这两种过滤器。

毛刺过滤器默认关闭，可调用 `gpio_glitch_filter_enable()` 使能过滤器。如需回收这个过滤器，可以调用 `gpio_del_glitch_filter()` 函数。在回收句柄前，请确保过滤器处于关闭状态，否则需调用 `gpio_glitch_filter_disable()`。

## GPIO 迟滞过滤器

ESP32-H2 支持输入引脚的硬件迟滞，这可以减少由于输入电压在逻辑 0、1 临界值附近时采样不稳定造成的 GPIO 中断误触，尤其是当输入逻辑电平转换较慢，电平建立时间较长时。

每个引脚可以独立启用迟滞功能。默认情况下，它由 eFuse 控制，且处于关闭状态，但也可以由软件控制启用或禁用。你可以通过配置 `gpio_config_t::hys_ctrl_mode` 来选择迟滞控制模式。迟滞控制模式会和其余 GPIO 配置一起在 `gpio_config()` 中生效。

---

**备注：**当迟滞功能由 eFuse 控制时，仍然可以独立的控制每个引脚的该功能，你需要 **烧断 eFuse**，以在特定 GPIO 上启用迟滞功能。

---

## 应用示例

- GPIO 输出和输入中断示例：[peripherals/gpio/generic\\_gpio](#)。

## API 参考 - 普通 GPIO

### Header File

- `components/esp_driver_gpio/include/driver/gpio.h`
- This header file can be included with:

```
#include "driver/gpio.h"
```

- This header file is a part of the API provided by the `esp_driver_gpio` component. To declare that your component depends on `esp_driver_gpio`, add the following to your `CMakeLists.txt`:

```
REQUIRES esp_driver_gpio
```

or

```
PRIV_REQUIRES esp_driver_gpio
```

### Functions

`esp_err_t gpio_config` (const `gpio_config_t` \*pGPIOConfig)

GPIO common configuration.



Configure GPIO's `Mode`, `pull-up`, `PullDown`, `IntrType`

**参数** `pGPIOConfig` -- Pointer to GPIO configure struct

**返回**

- ESP\_OK success
- ESP\_ERR\_INVALID\_ARG Parameter error

*esp\_err\_t* `gpio_reset_pin` (`gpio_num_t` gpio\_num)

Reset an gpio to default state (select gpio function, enable pullup and disable input and output).

---

**备注:** This function also configures the IOMUX for this pin to the GPIO function, and disconnects any other peripheral output configured via GPIO Matrix.

---

**参数** `gpio_num` -- GPIO number.

**返回** Always return ESP\_OK.

*esp\_err\_t* `gpio_set_intr_type` (`gpio_num_t` gpio\_num, *gpio\_int\_type\_t* intr\_type)

GPIO set interrupt trigger type.

**参数**

- `gpio_num` -- GPIO number. If you want to set the trigger type of e.g. of GPIO16, `gpio_num` should be `GPIO_NUM_16` (16);
- `intr_type` -- Interrupt type, select from `gpio_int_type_t`

**返回**

- ESP\_OK Success
- ESP\_ERR\_INVALID\_ARG Parameter error

*esp\_err\_t* `gpio_intr_enable` (`gpio_num_t` gpio\_num)

Enable GPIO module interrupt signal.

---

**备注:** ESP32: Please do not use the interrupt of GPIO36 and GPIO39 when using ADC or Wi-Fi and Bluetooth with sleep mode enabled. Please refer to the comments of `adc1_get_raw`. Please refer to Section 3.11 of [ESP32 ECO and Workarounds for Bugs](#) for the description of this issue.

---

**参数** `gpio_num` -- GPIO number. If you want to enable an interrupt on e.g. GPIO16, `gpio_num` should be `GPIO_NUM_16` (16);

**返回**

- ESP\_OK Success
- ESP\_ERR\_INVALID\_ARG Parameter error

*esp\_err\_t* `gpio_intr_disable` (`gpio_num_t` gpio\_num)

Disable GPIO module interrupt signal.

---

**备注:** This function is allowed to be executed when Cache is disabled within ISR context, by enabling `CONFIG_GPIO_CTRL_FUNC_IN_IRAM`

---

**参数** `gpio_num` -- GPIO number. If you want to disable the interrupt of e.g. GPIO16, `gpio_num` should be `GPIO_NUM_16` (16);

**返回**

- ESP\_OK success
- ESP\_ERR\_INVALID\_ARG Parameter error

*esp\_err\_t* **gpio\_set\_level** (gpio\_num\_t gpio\_num, uint32\_t level)

GPIO set output level.

---

**备注:** This function is allowed to be executed when Cache is disabled within ISR context, by enabling CONFIG\_GPIO\_CTRL\_FUNC\_IN\_IRAM

---

**参数**

- **gpio\_num** -- GPIO number. If you want to set the output level of e.g. GPIO16, gpio\_num should be GPIO\_NUM\_16 (16);
- **level** -- Output level. 0: low ; 1: high

**返回**

- ESP\_OK Success
- ESP\_ERR\_INVALID\_ARG GPIO number error

int **gpio\_get\_level** (gpio\_num\_t gpio\_num)

GPIO get input level.

**警告:** If the pad is not configured for input (or input and output) the returned value is always 0.

**参数** **gpio\_num** -- GPIO number. If you want to get the logic level of e.g. pin GPIO16, gpio\_num should be GPIO\_NUM\_16 (16);

**返回**

- 0 the GPIO input level is 0
- 1 the GPIO input level is 1

*esp\_err\_t* **gpio\_set\_direction** (gpio\_num\_t gpio\_num, *gpio\_mode\_t* mode)

GPIO set direction.

Configure GPIO direction,such as output\_only,input\_only,output\_and\_input

**参数**

- **gpio\_num** -- Configure GPIO pins number, it should be GPIO number. If you want to set direction of e.g. GPIO16, gpio\_num should be GPIO\_NUM\_16 (16);
- **mode** -- GPIO direction

**返回**

- ESP\_OK Success
- ESP\_ERR\_INVALID\_ARG GPIO error

*esp\_err\_t* **gpio\_set\_pull\_mode** (gpio\_num\_t gpio\_num, *gpio\_pull\_mode\_t* pull)

Configure GPIO pull-up/pull-down resistors.

---

**备注:** ESP32: Only pins that support both input & output have integrated pull-up and pull-down resistors. Input-only GPIOs 34-39 do not.

---

**参数**

- **gpio\_num** -- GPIO number. If you want to set pull up or down mode for e.g. GPIO16, gpio\_num should be GPIO\_NUM\_16 (16);
- **pull** -- GPIO pull up/down mode.

**返回**

- ESP\_OK Success
- ESP\_ERR\_INVALID\_ARG : Parameter error

*esp\_err\_t* **gpio\_wakeup\_enable** (gpio\_num\_t gpio\_num, *gpio\_int\_type\_t* intr\_type)

Enable GPIO wake-up function.

**参数**

- **gpio\_num** -- GPIO number.
- **intr\_type** -- GPIO wake-up type. Only GPIO\_INTR\_LOW\_LEVEL or GPIO\_INTR\_HIGH\_LEVEL can be used.

**返回**

- ESP\_OK Success
- ESP\_ERR\_INVALID\_ARG Parameter error

*esp\_err\_t* **gpio\_wakeup\_disable** (gpio\_num\_t gpio\_num)

Disable GPIO wake-up function.

**参数** **gpio\_num** -- GPIO number

**返回**

- ESP\_OK Success
- ESP\_ERR\_INVALID\_ARG Parameter error

*esp\_err\_t* **gpio\_isr\_register** (void (\*fn)(void\*), void \*arg, int intr\_alloc\_flags, *gpio\_isr\_handle\_t* \*handle)

Register GPIO interrupt handler, the handler is an ISR. The handler will be attached to the same CPU core that this function is running on.

This ISR function is called whenever any GPIO interrupt occurs. See the alternative `gpio_install_isr_service()` and `gpio_isr_handler_add()` API in order to have the driver support per-GPIO ISRs.

To disable or remove the ISR, pass the returned handle to the *interrupt allocation functions*.

**参数**

- **fn** -- Interrupt handler function.
- **arg** -- Parameter for handler function
- **intr\_alloc\_flags** -- Flags used to allocate the interrupt. One or multiple (ORred) ESP\_INTR\_FLAG\_\* values. See `esp_intr_alloc.h` for more info.
- **handle** -- Pointer to return handle. If non-NULL, a handle for the interrupt will be returned here.

**返回**

- ESP\_OK Success ;
- ESP\_ERR\_INVALID\_ARG GPIO error
- ESP\_ERR\_NOT\_FOUND No free interrupt found with the specified flags

*esp\_err\_t* **gpio\_pullup\_en** (gpio\_num\_t gpio\_num)

Enable pull-up on GPIO.

**参数** **gpio\_num** -- GPIO number

**返回**

- ESP\_OK Success
- ESP\_ERR\_INVALID\_ARG Parameter error

*esp\_err\_t* **gpio\_pullup\_dis** (gpio\_num\_t gpio\_num)

Disable pull-up on GPIO.

**参数** **gpio\_num** -- GPIO number

**返回**

- ESP\_OK Success
- ESP\_ERR\_INVALID\_ARG Parameter error

*esp\_err\_t* **gpio\_pulldown\_en** (gpio\_num\_t gpio\_num)

Enable pull-down on GPIO.

**参数** **gpio\_num** -- GPIO number

**返回**

- ESP\_OK Success
- ESP\_ERR\_INVALID\_ARG Parameter error

*esp\_err\_t* **gpio\_pulldown\_dis** (gpio\_num\_t gpio\_num)

Disable pull-down on GPIO.

**参数** **gpio\_num** -- GPIO number

**返回**

- ESP\_OK Success
- ESP\_ERR\_INVALID\_ARG Parameter error

*esp\_err\_t* **gpio\_install\_isr\_service** (int intr\_alloc\_flags)

Install the GPIO driver's ETS\_GPIO\_INTR\_SOURCE ISR handler service, which allows per-pin GPIO interrupt handlers.

This function is incompatible with `gpio_isr_register()` - if that function is used, a single global ISR is registered for all GPIO interrupts. If this function is used, the ISR service provides a global GPIO ISR and individual pin handlers are registered via the `gpio_isr_handler_add()` function.

**参数** **intr\_alloc\_flags** -- Flags used to allocate the interrupt. One or multiple (ORred) ESP\_INTR\_FLAG\_\* values. See `esp_intr_alloc.h` for more info.

**返回**

- ESP\_OK Success
- ESP\_ERR\_NO\_MEM No memory to install this service
- ESP\_ERR\_INVALID\_STATE ISR service already installed.
- ESP\_ERR\_NOT\_FOUND No free interrupt found with the specified flags
- ESP\_ERR\_INVALID\_ARG GPIO error

void **gpio\_uninstall\_isr\_service** (void)

Uninstall the driver's GPIO ISR service, freeing related resources.

*esp\_err\_t* **gpio\_isr\_handler\_add** (gpio\_num\_t gpio\_num, *gpio\_isr\_t* isr\_handler, void \*args)

Add ISR handler for the corresponding GPIO pin.

Call this function after using `gpio_install_isr_service()` to install the driver's GPIO ISR handler service.

The pin ISR handlers no longer need to be declared with `IRAM_ATTR`, unless you pass the `ESP_INTR_FLAG_IRAM` flag when allocating the ISR in `gpio_install_isr_service()`.

This ISR handler will be called from an ISR. So there is a stack size limit (configurable as "ISR stack size" in `menuconfig`). This limit is smaller compared to a global GPIO interrupt handler due to the additional level of indirection.

**参数**

- **gpio\_num** -- GPIO number
- **isr\_handler** -- ISR handler function for the corresponding GPIO number.
- **args** -- parameter for ISR handler.

**返回**

- ESP\_OK Success
- ESP\_ERR\_INVALID\_STATE Wrong state, the ISR service has not been initialized.
- ESP\_ERR\_INVALID\_ARG Parameter error

*esp\_err\_t* **gpio\_isr\_handler\_remove** (gpio\_num\_t gpio\_num)

Remove ISR handler for the corresponding GPIO pin.

**参数** **gpio\_num** -- GPIO number

**返回**

- ESP\_OK Success
- ESP\_ERR\_INVALID\_STATE Wrong state, the ISR service has not been initialized.
- ESP\_ERR\_INVALID\_ARG Parameter error

*esp\_err\_t* **gpio\_set\_drive\_capability** (gpio\_num\_t gpio\_num, *gpio\_drive\_cap\_t* strength)

Set GPIO pad drive capability.

**参数**

- **gpio\_num** -- GPIO number, only support output GPIOs
- **strength** -- Drive capability of the pad

## 返回

- ESP\_OK Success
- ESP\_ERR\_INVALID\_ARG Parameter error

*esp\_err\_t* **gpio\_get\_drive\_capability** (gpio\_num\_t gpio\_num, *gpio\_drive\_cap\_t* \*strength)

Get GPIO pad drive capability.

## 参数

- **gpio\_num** -- GPIO number, only support output GPIOs
- **strength** -- Pointer to accept drive capability of the pad

## 返回

- ESP\_OK Success
- ESP\_ERR\_INVALID\_ARG Parameter error

*esp\_err\_t* **gpio\_hold\_en** (gpio\_num\_t gpio\_num)

Enable gpio pad hold function.

When a GPIO is set to hold, its state is latched at that moment and will not change when the internal signal or the IO MUX/GPIO configuration is modified (including input enable, output enable, output value, function, and drive strength values). This function can be used to retain the state of GPIOs when the power domain of where GPIO/IOMUX belongs to becomes off. For example, chip or system is reset (e.g. watchdog time-out, deep-sleep events are triggered), or peripheral power-down in light-sleep.

This function works in both input and output modes, and only applicable to output-capable GPIOs. If this function is enabled: in output mode: the output level of the GPIO will be locked and can not be changed. in input mode: the input read value can still reflect the changes of the input signal.

However, on ESP32/S2/C3/S3/C2, this function cannot be used to hold the state of a digital GPIO during Deep-sleep. Even if this function is enabled, the digital GPIO will be reset to its default state when the chip wakes up from Deep-sleep. If you want to hold the state of a digital GPIO during Deep-sleep, please call `gpio_deep_sleep_hold_en`.

Power down or call `gpio_hold_dis` will disable this function.

参数 **gpio\_num** -- GPIO number, only support output-capable GPIOs

## 返回

- ESP\_OK Success
- ESP\_ERR\_NOT\_SUPPORTED Not support pad hold function

*esp\_err\_t* **gpio\_hold\_dis** (gpio\_num\_t gpio\_num)

Disable gpio pad hold function.

When the chip is woken up from peripheral power-down sleep, the gpio will be set to the default mode, so, the gpio will output the default level if this function is called. If you don't want the level changes, the gpio should be configured to a known state before this function is called. e.g. If you hold gpio18 high during Deep-sleep, after the chip is woken up and `gpio_hold_dis` is called, gpio18 will output low level(because gpio18 is input mode by default). If you don't want this behavior, you should configure gpio18 as output mode and set it to high level before calling `gpio_hold_dis`.

参数 **gpio\_num** -- GPIO number, only support output-capable GPIOs

## 返回

- ESP\_OK Success
- ESP\_ERR\_NOT\_SUPPORTED Not support pad hold function

void **gpio\_iomux\_in** (uint32\_t gpio\_num, uint32\_t signal\_idx)

SOC\_GPIO\_SUPPORT\_HOLD\_SINGLE\_IO\_IN\_DSLP.

Set pad input to a peripheral signal through the IOMUX.

## 参数

- **gpio\_num** -- GPIO number of the pad.
- **signal\_idx** -- Peripheral signal id to input. One of the \*\_IN\_IDX signals in `soc/gpio_sig_map.h`.

void **gpio\_iomux\_out** (uint8\_t gpio\_num, int func, bool out\_en\_inv)

Set peripheral output to an GPIO pad through the IOMUX.

**参数**

- **gpio\_num** -- gpio\_num GPIO number of the pad.
- **func** -- The function number of the peripheral pin to output pin. One of the FUNC\_X\_\* of specified pin (X) in soc/io\_mux\_reg.h.
- **out\_en\_inv** -- True if the output enable needs to be inverted, otherwise False.

*esp\_err\_t* **gpio\_force\_hold\_all** (void)

Force hold all digital and rtc gpio pads.

GPIO force hold, no matter the chip in active mode or sleep modes.

This function will immediately cause all pads to latch the current values of input enable, output enable, output value, function, and drive strength values.

**警告:**

- This function will hold flash and UART pins as well. Therefore, this function, and all code run afterwards (till calling `gpio_force_unhold_all` to disable this feature), **MUST** be placed in internal RAM as holding the flash pins will halt SPI flash operation, and holding the UART pins will halt any UART logging.
- The hold state of all pads will be cancelled during ROM boot, so it is not recommended to use this API to hold the pads state during deepsleep and reset.

*esp\_err\_t* **gpio\_force\_unhold\_all** (void)

Unhold all digital and rtc gpio pads.

---

**备注:** The global hold signal and the hold signal of each IO act on the PAD through 'or' logic, so if a pad has already been configured to hold by `gpio_hold_en`, this API can't release its hold state.

---

*esp\_err\_t* **gpio\_sleep\_sel\_en** (gpio\_num\_t gpio\_num)

Enable SLP\_SEL to change GPIO status automantically in lightsleep.

**参数** **gpio\_num** -- GPIO number of the pad.

**返回**

- ESP\_OK Success

*esp\_err\_t* **gpio\_sleep\_sel\_dis** (gpio\_num\_t gpio\_num)

Disable SLP\_SEL to change GPIO status automantically in lightsleep.

**参数** **gpio\_num** -- GPIO number of the pad.

**返回**

- ESP\_OK Success

*esp\_err\_t* **gpio\_sleep\_set\_direction** (gpio\_num\_t gpio\_num, *gpio\_mode\_t* mode)

GPIO set direction at sleep.

Configure GPIO direction,such as output\_only,input\_only,output\_and\_input

**参数**

- **gpio\_num** -- Configure GPIO pins number, it should be GPIO number. If you want to set direction of e.g. GPIO16, gpio\_num should be GPIO\_NUM\_16 (16);
- **mode** -- GPIO direction

**返回**

- ESP\_OK Success
- ESP\_ERR\_INVALID\_ARG GPIO error

*esp\_err\_t* **gpio\_sleep\_set\_pull\_mode** (gpio\_num\_t gpio\_num, *gpio\_pull\_mode\_t* pull)

Configure GPIO pull-up/pull-down resistors at sleep.

---

**备注:** ESP32: Only pins that support both input & output have integrated pull-up and pull-down resistors. Input-only GPIOs 34-39 do not.

---

#### 参数

- **gpio\_num** -- GPIO number. If you want to set pull up or down mode for e.g. GPIO16, gpio\_num should be GPIO\_NUM\_16 (16);
- **pull** -- GPIO pull up/down mode.

#### 返回

- ESP\_OK Success
- ESP\_ERR\_INVALID\_ARG : Parameter error

*esp\_err\_t* **gpio\_dump\_io\_configuration** (FILE \*out\_stream, uint64\_t io\_bit\_mask)

Dump IO configuration information to console.

#### 参数

- **out\_stream** -- IO stream (e.g. stdout)
- **io\_bit\_mask** -- IO pin bit mask, each bit maps to an IO

#### 返回

- ESP\_OK Success
- ESP\_ERR\_INVALID\_ARG Parameter error

## Structures

struct **gpio\_config\_t**

Configuration parameters of GPIO pad for gpio\_config function.

### Public Members

uint64\_t **pin\_bit\_mask**

GPIO pin: set with bit mask, each bit maps to a GPIO

*gpio\_mode\_t* **mode**

GPIO mode: set input/output mode

*gpio\_pullup\_t* **pull\_up\_en**

GPIO pull-up

*gpiopulldown\_t* **pull\_down\_en**

GPIO pull-down

*gpio\_int\_type\_t* **intr\_type**

GPIO interrupt type

*gpio\_hys\_ctrl\_mode\_t* **hys\_ctrl\_mode**

GPIO hysteresis: hysteresis filter on slope input

## Macros

**GPIO\_PIN\_COUNT**

**GPIO\_IS\_VALID\_GPIO** (gpio\_num)

Check whether it is a valid GPIO number.

**GPIO\_IS\_VALID\_OUTPUT\_GPIO** (gpio\_num)

Check whether it can be a valid GPIO number of output mode.

**GPIO\_IS\_VALID\_DIGITAL\_IO\_PAD** (gpio\_num)

Check whether it can be a valid digital I/O pad.

## Type Definitions

typedef *intr\_handle\_t* **gpio\_isr\_handle\_t**

typedef void (\***gpio\_isr\_t**)(void \*arg)

GPIO interrupt handler.

**Param arg** User registered data

## Header File

- [components/hal/include/hal/gpio\\_types.h](#)
- This header file can be included with:

```
#include "hal/gpio_types.h"
```

## Macros

**GPIO\_PIN\_REG\_0**

**GPIO\_PIN\_REG\_1**

**GPIO\_PIN\_REG\_2**

**GPIO\_PIN\_REG\_3**

**GPIO\_PIN\_REG\_4**

**GPIO\_PIN\_REG\_5**

**GPIO\_PIN\_REG\_6**

**GPIO\_PIN\_REG\_7**

**GPIO\_PIN\_REG\_8**

**GPIO\_PIN\_REG\_9**

**GPIO\_PIN\_REG\_10**



GPIO\_PIN\_REG\_11

GPIO\_PIN\_REG\_12

GPIO\_PIN\_REG\_13

GPIO\_PIN\_REG\_14

GPIO\_PIN\_REG\_15

GPIO\_PIN\_REG\_16

GPIO\_PIN\_REG\_17

GPIO\_PIN\_REG\_18

GPIO\_PIN\_REG\_19

GPIO\_PIN\_REG\_20

GPIO\_PIN\_REG\_21

GPIO\_PIN\_REG\_22

GPIO\_PIN\_REG\_23

GPIO\_PIN\_REG\_24

GPIO\_PIN\_REG\_25

GPIO\_PIN\_REG\_26

GPIO\_PIN\_REG\_27

GPIO\_PIN\_REG\_28

GPIO\_PIN\_REG\_29

GPIO\_PIN\_REG\_30

GPIO\_PIN\_REG\_31

GPIO\_PIN\_REG\_32

GPIO\_PIN\_REG\_33

GPIO\_PIN\_REG\_34

GPIO\_PIN\_REG\_35

GPIO\_PIN\_REG\_36

GPIO\_PIN\_REG\_37

GPIO\_PIN\_REG\_38

GPIO\_PIN\_REG\_39

GPIO\_PIN\_REG\_40

GPIO\_PIN\_REG\_41

GPIO\_PIN\_REG\_42

GPIO\_PIN\_REG\_43

GPIO\_PIN\_REG\_44

GPIO\_PIN\_REG\_45

GPIO\_PIN\_REG\_46

GPIO\_PIN\_REG\_47

GPIO\_PIN\_REG\_48

GPIO\_PIN\_REG\_49

GPIO\_PIN\_REG\_50

GPIO\_PIN\_REG\_51

GPIO\_PIN\_REG\_52

GPIO\_PIN\_REG\_53

GPIO\_PIN\_REG\_54

**Enumerations**enum **gpio\_port\_t***Values:*enumerator **GPIO\_PORT\_0**enumerator **GPIO\_PORT\_MAX**enum **gpio\_int\_type\_t***Values:*enumerator **GPIO\_INTR\_DISABLE**

Disable GPIO interrupt

enumerator **GPIO\_INTR\_POSEDGE**

GPIO interrupt type : rising edge

enumerator **GPIO\_INTR\_NEGEDGE**

GPIO interrupt type : falling edge

enumerator **GPIO\_INTR\_ANYEDGE**

GPIO interrupt type : both rising and falling edge

enumerator **GPIO\_INTR\_LOW\_LEVEL**

GPIO interrupt type : input low level trigger

enumerator **GPIO\_INTR\_HIGH\_LEVEL**

GPIO interrupt type : input high level trigger

enumerator **GPIO\_INTR\_MAX**enum **gpio\_mode\_t***Values:*enumerator **GPIO\_MODE\_DISABLE**

GPIO mode : disable input and output

enumerator **GPIO\_MODE\_INPUT**

GPIO mode : input only

enumerator **GPIO\_MODE\_OUTPUT**

GPIO mode : output only mode

enumerator **GPIO\_MODE\_OUTPUT\_OD**

GPIO mode : output only with open-drain mode

enumerator **GPIO\_MODE\_INPUT\_OUTPUT\_OD**

GPIO mode : output and input with open-drain mode

enumerator **GPIO\_MODE\_INPUT\_OUTPUT**

GPIO mode : output and input mode

enum **gpio\_pullup\_t**

*Values:*

enumerator **GPIO\_PULLUP\_DISABLE**

Disable GPIO pull-up resistor

enumerator **GPIO\_PULLUP\_ENABLE**

Enable GPIO pull-up resistor

enum **gpiopulldown\_t**

*Values:*

enumerator **GPIO\_PULLDOWN\_DISABLE**

Disable GPIO pull-down resistor

enumerator **GPIO\_PULLDOWN\_ENABLE**

Enable GPIO pull-down resistor

enum **gpio\_pull\_mode\_t**

*Values:*

enumerator **GPIO\_PULLUP\_ONLY**

Pad pull up

enumerator **GPIO\_PULLDOWN\_ONLY**

Pad pull down

enumerator **GPIO\_PULLUP\_PULLDOWN**

Pad pull up + pull down

enumerator **GPIO\_FLOATING**

Pad floating

enum **gpio\_drive\_cap\_t**

*Values:*

enumerator **GPIO\_DRIVE\_CAP\_0**

Pad drive capability: weak

enumerator **GPIO\_DRIVE\_CAP\_1**

Pad drive capability: stronger

enumerator **GPIO\_DRIVE\_CAP\_2**

Pad drive capability: medium

enumerator **GPIO\_DRIVE\_CAP\_DEFAULT**

Pad drive capability: medium

enumerator **GPIO\_DRIVE\_CAP\_3**

Pad drive capability: strongest

enumerator **GPIO\_DRIVE\_CAP\_MAX**

enum **gpio\_hys\_ctrl\_mode\_t**

Available option for configuring hysteresis feature of GPIOs.

*Values:*

enumerator **GPIO\_HYS\_CTRL\_EFUSE**

Pad input hysteresis ctrl by efuse

enumerator **GPIO\_HYS\_SOFT\_DISABLE**

Pad input hysteresis disable by software

enumerator **GPIO\_HYS\_SOFT\_ENABLE**

Pad input hysteresis enable by software

## API 参考 - GPIO 毛刺过滤器

### Header File

- [components/esp\\_driver\\_gpio/include/driver/gpio\\_filter.h](#)
- This header file can be included with:

```
#include "driver/gpio_filter.h"
```

- This header file is a part of the API provided by the `esp_driver_gpio` component. To declare that your component depends on `esp_driver_gpio`, add the following to your `CMakeLists.txt`:

```
REQUIRES esp_driver_gpio
```

or

```
PRIV_REQUIRES esp_driver_gpio
```

### Functions

`esp_err_t gpio_new_pin_glitch_filter` (const `gpio_pin_glitch_filter_config_t` \*config, `gpio_glitch_filter_handle_t` \*ret\_filter)

Create a pin glitch filter.

---

**备注:** Pin glitch filter parameters are fixed, pulses shorter than two sample clocks (IO-MUX's source clock) will be filtered out. It's independent with "flex" glitch filter. See also `gpio_new_flex_glitch_filter`.

---

---

**备注:** The created filter handle can later be deleted by `gpio_del_glitch_filter`.

---

### 参数

- **config** -- [in] Glitch filter configuration

- **ret\_filter** -- [out] Returned glitch filter handle

**返回**

- ESP\_OK: Create a pin glitch filter successfully
- ESP\_ERR\_INVALID\_ARG: Create a pin glitch filter failed because of invalid arguments (e.g. wrong GPIO number)
- ESP\_ERR\_NO\_MEM: Create a pin glitch filter failed because of out of memory
- ESP\_FAIL: Create a pin glitch filter failed because of other error

*esp\_err\_t* **gpio\_new\_flex\_glitch\_filter** (const *gpio\_flex\_glitch\_filter\_config\_t* \*config, *gpio\_glitch\_filter\_handle\_t* \*ret\_filter)

Allocate a flex glitch filter.

---

**备注:** "flex" means the filter parameters (window, threshold) are adjustable. It's independent with pin glitch filter. See also `gpio_new_pin_glitch_filter`.

---



---

**备注:** The created filter handle can later be deleted by `gpio_del_glitch_filter`.

---

**参数**

- **config** -- [in] Glitch filter configuration
- **ret\_filter** -- [out] Returned glitch filter handle

**返回**

- ESP\_OK: Allocate a flex glitch filter successfully
- ESP\_ERR\_INVALID\_ARG: Allocate a flex glitch filter failed because of invalid arguments (e.g. wrong GPIO number, filter parameters out of range)
- ESP\_ERR\_NO\_MEM: Allocate a flex glitch filter failed because of out of memory
- ESP\_ERR\_NOT\_FOUND: Allocate a flex glitch filter failed because the underlying hardware resources are used up
- ESP\_FAIL: Allocate a flex glitch filter failed because of other error

*esp\_err\_t* **gpio\_del\_glitch\_filter** (*gpio\_glitch\_filter\_handle\_t* filter)

Delete a glitch filter.

**参数** **filter** -- [in] Glitch filter handle returned from `gpio_new_flex_glitch_filter` or `gpio_new_pin_glitch_filter`

**返回**

- ESP\_OK: Delete glitch filter successfully
- ESP\_ERR\_INVALID\_ARG: Delete glitch filter failed because of invalid arguments
- ESP\_ERR\_INVALID\_STATE: Delete glitch filter failed because the glitch filter is still in working
- ESP\_FAIL: Delete glitch filter failed because of other error

*esp\_err\_t* **gpio\_glitch\_filter\_enable** (*gpio\_glitch\_filter\_handle\_t* filter)

Enable a glitch filter.

**参数** **filter** -- [in] Glitch filter handle returned from `gpio_new_flex_glitch_filter` or `gpio_new_pin_glitch_filter`

**返回**

- ESP\_OK: Enable glitch filter successfully
- ESP\_ERR\_INVALID\_ARG: Enable glitch filter failed because of invalid arguments
- ESP\_ERR\_INVALID\_STATE: Enable glitch filter failed because the glitch filter is already enabled
- ESP\_FAIL: Enable glitch filter failed because of other error

*esp\_err\_t* **gpio\_glitch\_filter\_disable** (*gpio\_glitch\_filter\_handle\_t* filter)

Disable a glitch filter.

**参数** **filter** -- **[in]** Glitch filter handle returned from `gpio_new_flex_glitch_filter` or `gpio_new_pin_glitch_filter`

**返回**

- `ESP_OK`: Disable glitch filter successfully
- `ESP_ERR_INVALID_ARG`: Disable glitch filter failed because of invalid arguments
- `ESP_ERR_INVALID_STATE`: Disable glitch filter failed because the glitch filter is not enabled yet
- `ESP_FAIL`: Disable glitch filter failed because of other error

## Structures

struct **gpio\_pin\_glitch\_filter\_config\_t**

Configuration of GPIO pin glitch filter.

### Public Members

`glitch_filter_clock_source_t` **clk\_src**

Clock source for the glitch filter

`gpio_num_t` **gpio\_num**

GPIO number

struct **gpio\_flex\_glitch\_filter\_config\_t**

Configuration of GPIO flex glitch filter.

### Public Members

`glitch_filter_clock_source_t` **clk\_src**

Clock source for the glitch filter

`gpio_num_t` **gpio\_num**

GPIO number

`uint32_t` **window\_width\_ns**

Sample window width (in ns)

`uint32_t` **window\_thres\_ns**

Sample window threshold (in ns), during the `window_width_ns` sample window, any pulse whose width < `window_thres_ns` will be discarded.

## Type Definitions

typedef struct `gpio_glitch_filter_t` \***gpio\_glitch\_filter\_handle\_t**

Typedef of GPIO glitch filter handle.

## 2.6.9 通用定时器

## 简介

通用定时器是 ESP32-H2 定时器组外设的驱动程序。ESP32-H2 硬件定时器分辨率高，具有灵活的报警功能。定时器内部计数器达到特定目标数值的行为被称为定时器报警。定时器报警时将调用用户注册的不同定时器回调函数。

通用定时器通常在以下场景中使用：

- 如同挂钟一般自由运行，随时随地获取高分辨率时间戳；
- 生成周期性警报，定期触发事件；
- 生成一次性警报，在目标时间内响应。

## 功能概述

下文介绍了配置和操作定时器的常规步骤：

- **资源分配** - 获取定时器句柄应设置的参数，以及如何在通用定时器完成工作时回收资源。
- **设置和获取计数值** - 如何强制定时器从起点开始计数，以及如何随时获取计数值。
- **设置警报动作** - 启动警报事件应设置的参数。
- **注册事件回调函数** - 如何将用户的特定代码挂载到警报事件回调函数。
- **使能和禁用定时器** - 如何使能和禁用定时器。
- **启动和停止定时器** - 通过不同报警行为启动定时器的典型使用场景。
- **ETM 事件与任务** - 定时器提供了哪些事件和任务可以连接到 ETM 通道上。
- **电源管理** - 选择不同的时钟源将会如何影响功耗。
- **IRAM 安全** - 在 cache 禁用的情况下，如何更好地让定时器处理中断事务以及实现 IO 控制功能。
- **线程安全** - 驱动程序保证哪些 API 线程安全。
- **Kconfig 选项** - 支持的 Kconfig 选项，这些选项会对驱动程序行为产生不同影响。

**资源分配** 不同的 ESP 芯片可能有不同数量的独立定时器组，每组内也可能有若干个独立定时器。<sup>1</sup>

通用定时器实例由 `gptimer_handle_t` 表示。可用硬件资源汇集在资源池内，由后台驱动程序管理，无需考虑硬件所属的定时器以及定时器组。

要安装一个定时器实例，需要提前提供配置结构体 `gptimer_config_t`：

- `gptimer_config_t::clk_src` 选择定时器的时钟源。`gptimer_clock_source_t` 中列出多个可用时钟，仅可选择其中一个时钟。了解不同时钟源对功耗的影响，请查看章节 [电源管理](#)。
- `gptimer_config_t::direction` 设置定时器的计数方向，`gptimer_count_direction_t` 中列出多个支持的方向，仅可选择其中一个方向。
- `gptimer_config_t::resolution_hz` 设置内部计数器的分辨率。计数器每滴答一次相当于  $1 / \text{resolution\_hz}$  秒。
- `gptimer_config_t::intr_priority` 设置中断的优先级。如果设置为 0，则会分配一个默认优先级的中断，否则会使用指定的优先级。
- 选用 `gptimer_config_t::intr_shared` 设置是否将定时器中断源标记为共享源。了解共享中断的优缺点，请参考 [Interrupt Handling](#)。

完成上述结构配置之后，可以将结构传递给 `gptimer_new_timer()`，用以实例化定时器实例并返回定时器句柄。

该函数可能由于内存不足、参数无效等错误而失败。具体来说，当没有更多的空闲定时器（即所有硬件资源已用完）时，将返回 `ESP_ERR_NOT_FOUND`。可用定时器总数由 `SOC_TIMER_GROUP_TOTAL_TIMERS` 表示，不同的 ESP 芯片该数值不同。

如已不再需要之前创建的通用定时器实例，应通过调用 `gptimer_del_timer()` 回收定时器，以便底层硬件定时器用于其他目的。在删除通用定时器句柄之前，请通过 `gptimer_disable()` 禁用定时器，或者通过 `gptimer_enable()` 确认定时器尚未使能。

<sup>1</sup> 不同 ESP 芯片系列的通用定时器实例数量可能不同。了解详细信息，请参考《ESP32-H2 技术参考手册》> 章节定时器组 (TIMG) [PDF]。驱动程序对通道申请数量不做限制，但当硬件资源用尽时，驱动程序将返回错误。在分配资源时，请务必检查返回值（例如 `gptimer_new_timer()`）。



**创建分辨率为 1 MHz 的通用定时器句柄**

```

gptimer_handle_t gptimer = NULL;
gptimer_config_t timer_config = {
    .clk_src = GPTIMER_CLK_SRC_DEFAULT,
    .direction = GPTIMER_COUNT_UP,
    .resolution_hz = 1 * 1000 * 1000, // 1MHz, 1 tick = 1us
};
ESP_ERROR_CHECK(gptimer_new_timer(&timer_config, &gptimer));

```

**设置和获取计数值** 创建通用定时器时，内部计数器将默认重置为零。计数值可以通过 `gptimer_set_raw_count()` 异步更新。最大计数值取决于硬件定时器的位宽，这也会在 SOC 宏 `SOC_TIMER_GROUP_COUNTER_BIT_WIDTH` 中有所反映。当更新活动定时器的原始计数值时，定时器将立即从新值开始计数。

计数值可以随时通过 `gptimer_get_raw_count()` 获取。

**设置警报动作** 对于大多数通用定时器使用场景而言，应在启动定时器之前设置警报动作，但不包括简单的挂钟场景，该场景仅需自由运行的定时器。设置警报动作，需要根据如何使用警报事件来配置 `gptimer_alarm_config_t` 的不同参数：

- `gptimer_alarm_config_t::alarm_count` 设置触发警报事件的目标计数值。设置警报值时还需考虑计数方向。尤其是当 `gptimer_alarm_config_t::auto_reload_on_alarm` 为 `true` 时，`gptimer_alarm_config_t::alarm_count` 和 `gptimer_alarm_config_t::reload_count` 不能设置为相同的值，因为警报值和重载值相同时没有意义。
- `gptimer_alarm_config_t::reload_count` 代表警报事件发生时要重载的计数值。此配置仅在 `gptimer_alarm_config_t::auto_reload_on_alarm` 设置为 `true` 时生效。
- `gptimer_alarm_config_t::auto_reload_on_alarm` 标志设置是否使能自动重载功能。如果使能，硬件定时器将在警报事件发生时立即将 `gptimer_alarm_config_t::reload_count` 的值重载到计数器中。

要使警报配置生效，需要调用 `gptimer_set_alarm_action()`。特别是当 `gptimer_alarm_config_t` 设置为 `NULL` 时，报警功能将被禁用。

---

**备注：** 如果警报值已设置且定时器超过该值，则会立即触发警报。

---

**注册事件回调函数** 定时器启动后，可动态产生特定事件（如“警报事件”）。如需在事件发生时调用某些函数，请通过 `gptimer_register_event_callbacks()` 将函数挂载到中断服务例程 (ISR)。 `gptimer_event_callbacks_t` 中列出了所有支持的事件回调函数：

- `gptimer_event_callbacks_t::on_alarm` 设置警报事件的回调函数。由于此函数在 ISR 上下文中调用，必须确保该函数不会试图阻塞（例如，确保仅从函数内调用具有 ISR 后缀的 FreeRTOS API）。函数原型在 `gptimer_alarm_cb_t` 中有所声明。

也可以通过参数 `user_data`，将自己的上下文保存到 `gptimer_register_event_callbacks()` 中。用户数据将直接传递给回调函数。

此功能将为定时器延迟安装中断服务，但不使能中断服务。所以，请在 `gptimer_enable()` 之前调用这一函数，否则将返回 `ESP_ERR_INVALID_STATE` 错误。了解详细信息，请查看章节 [使能和禁用定时器](#)。

**使能和禁用定时器** 在对定时器进行 IO 控制之前，需要先调用 `gptimer_enable()` 使能定时器。此函数功能如下：

- 此函数将把定时器驱动程序的状态从 `init` 切换为 `enable`。
- 如果 `gptimer_register_event_callbacks()` 已经延迟安装中断服务，此函数将使能中断服务。
- 如果选择了特定的时钟源（例如 APB 时钟），此函数将获取适当的电源管理锁。了解更多信息，请查看章节 [电源管理](#)。

调用 `gptimer_disable()` 会进行相反的操作，即将定时器驱动程序恢复到 **init** 状态，禁用中断服务并释放电源管理锁。

**启动和停止定时器** 启动和停止是定时器的基本 IO 操作。调用 `gptimer_start()` 可以使内部计数器开始工作，而 `gptimer_stop()` 可以使计数器停止工作。下文说明了如何在存在或不存在警报事件的情况下启动定时器。

调用 `gptimer_start()` 将使驱动程序状态从 **enable** 转换为 **run**，反之亦然。注意确保 **start** 和 **stop** 函数成对使用，否则，函数可能返回 `ESP_ERR_INVALID_STATE`。

### 将定时器作为挂钟启动

```
ESP_ERROR_CHECK(gptimer_enable(gptimer));
ESP_ERROR_CHECK(gptimer_start(gptimer));
// Retrieve the timestamp at anytime
uint64_t count;
ESP_ERROR_CHECK(gptimer_get_raw_count(gptimer, &count));
```

### 触发周期性事件

```
typedef struct {
    uint64_t event_count;
} example_queue_element_t;

static bool example_timer_on_alarm_cb(gptimer_handle_t timer, const gptimer_alarm_
↳event_data_t *edata, void *user_ctx)
{
    BaseType_t high_task_awoken = pdFALSE;
    QueueHandle_t queue = (QueueHandle_t)user_ctx;
    // Retrieve the count value from event data
    example_queue_element_t ele = {
        .event_count = edata->count_value
    };
    // Optional: send the event data to other task by OS queue
    // Don't introduce complex logics in callbacks
    // Suggest dealing with event data in the main loop, instead of in this_
↳callback
    xQueueSendFromISR(queue, &ele, &high_task_awoken);
    // return whether we need to yield at the end of ISR
    return high_task_awoken == pdTRUE;
}

gptimer_alarm_config_t alarm_config = {
    .reload_count = 0, // counter will reload with 0 on alarm event
    .alarm_count = 1000000, // period = 1s @resolution 1MHz
    .flags.auto_reload_on_alarm = true, // enable auto-reload
};
ESP_ERROR_CHECK(gptimer_set_alarm_action(gptimer, &alarm_config));

gptimer_event_callbacks_t cbs = {
    .on_alarm = example_timer_on_alarm_cb, // register user callback
};
ESP_ERROR_CHECK(gptimer_register_event_callbacks(gptimer, &cbs, queue));
ESP_ERROR_CHECK(gptimer_enable(gptimer));
ESP_ERROR_CHECK(gptimer_start(gptimer));
```

### 触发一次性事件

```

typedef struct {
    uint64_t event_count;
} example_queue_element_t;

static bool example_timer_on_alarm_cb(gptimer_handle_t timer, const gptimer_alarm_
↪event_data_t *edata, void *user_ctx)
{
    BaseType_t high_task_awoken = pdFALSE;
    QueueHandle_t queue = (QueueHandle_t)user_ctx;
    // Stop timer the sooner the better
    gptimer_stop(timer);
    // Retrieve the count value from event data
    example_queue_element_t ele = {
        .event_count = edata->count_value
    };
    // Optional: send the event data to other task by OS queue
    xQueueSendFromISR(queue, &ele, &high_task_awoken);
    // return whether we need to yield at the end of ISR
    return high_task_awoken == pdTRUE;
}

gptimer_alarm_config_t alarm_config = {
    .alarm_count = 1 * 1000 * 1000, // alarm target = 1s @resolution 1MHz
};
ESP_ERROR_CHECK(gptimer_set_alarm_action(gptimer, &alarm_config));

gptimer_event_callbacks_t cbs = {
    .on_alarm = example_timer_on_alarm_cb, // register user callback
};
ESP_ERROR_CHECK(gptimer_register_event_callbacks(gptimer, &cbs, queue));
ESP_ERROR_CHECK(gptimer_enable(gptimer));
ESP_ERROR_CHECK(gptimer_start(gptimer));

```

**警报值动态更新** 通过更改 `gptimer_alarm_event_data_t::alarm_value`, 可以在 ISR 程序回调中动态更新警报值。警报值将在回调函数返回后更新。

```

typedef struct {
    uint64_t event_count;
} example_queue_element_t;

static bool example_timer_on_alarm_cb(gptimer_handle_t timer, const gptimer_alarm_
↪event_data_t *edata, void *user_ctx)
{
    BaseType_t high_task_awoken = pdFALSE;
    QueueHandle_t queue = (QueueHandle_t)user_data;
    // Retrieve the count value from event data
    example_queue_element_t ele = {
        .event_count = edata->count_value
    };
    // Optional: send the event data to other task by OS queue
    xQueueSendFromISR(queue, &ele, &high_task_awoken);
    // reconfigure alarm value
    gptimer_alarm_config_t alarm_config = {
        .alarm_count = edata->alarm_value + 1000000, // alarm in next 1s
    };
    gptimer_set_alarm_action(timer, &alarm_config);
    // return whether we need to yield at the end of ISR
    return high_task_awoken == pdTRUE;
}

```

(下页继续)

```

gptimer_alarm_config_t alarm_config = {
    .alarm_count = 1000000, // initial alarm target = 1s @resolution 1MHz
};
ESP_ERROR_CHECK(gptimer_set_alarm_action(gptimer, &alarm_config));

gptimer_event_callbacks_t cbs = {
    .on_alarm = example_timer_on_alarm_cb, // register user callback
};
ESP_ERROR_CHECK(gptimer_register_event_callbacks(gptimer, &cbs, queue));
ESP_ERROR_CHECK(gptimer_enable(gptimer));
ESP_ERROR_CHECK(gptimer_start(gptimer, &alarm_config));

```

**ETM 事件与任务** 定时器可以产生多种事件，这些事件可以连接到 *ETM* 模块。*gptimer\_etm\_event\_type\_t* 中列出了定时器能够产生的事件类型。用户可以通过调用 *gptimer\_new\_etm\_event()* 来获得相应事件的 ETM event 句柄。同样地，定时器还公开了一些可被其他事件触发然后自动执行的任务。*gptimer\_etm\_task\_type\_t* 中列出了定时器能够支持的任务类型。用户可以通过调用 *gptimer\_new\_etm\_task()* 来获得相应任务的 ETM task 句柄。

关于如何将定时器事件和任务连接到 ETM 通道中，请参阅 *ETM* 文档。

**电源管理** 有些电源管理的策略会在某些时刻关闭时钟源，或者改变时钟源的频率，以求降低功耗。比如在启用 DFS 后，APB 时钟源会降低频率。如果浅睡眠 (Light-sleep) 模式也被开启，PLL 和 XTAL 时钟都会被默认关闭，从而导致 GPTimer 的计时不准确。

驱动程序会根据具体的时钟源选择，通过创建不同的电源锁来避免上述情况的发生。驱动会在 *gptimer\_enable()* 函数中增加电源锁的引用计数，并在 *gptimer\_disable()* 函数中减少电源锁的引用计数，从而保证了在 *gptimer\_enable()* 和 *gptimer\_disable()* 之间，GPTimer 的时钟源始终处于稳定工作的状态。

**IRAM 安全** 默认情况下，当 cache 因写入或擦除 flash 等原因而被禁用时，通用定时器的中断服务将会延迟，造成警报中断无法及时执行。在实时应用程序中通常需要避免这一情况发生。

调用 Kconfig 选项 *CONFIG\_GPTIMER\_ISR\_IRAM\_SAFE* 可实现如下功能：

- 即使禁用 cache 也可使能正在运行的中断
- 将 ISR 使用的所有函数放入 IRAM<sup>2</sup>
- 将驱动程序对象放入 DRAM（以防意外映射到 PSRAM）

这将允许中断在 cache 禁用时运行，但会增加 IRAM 使用量。

调用另一 Kconfig 选项 *CONFIG\_GPTIMER\_CTRL\_FUNC\_IN\_IRAM* 也可将常用的 IO 控制功能放入 IRAM，以便这些函数在 cache 禁用时也能执行。常用的 IO 控制功能如下：

- *gptimer\_start()*
- *gptimer\_stop()*
- *gptimer\_get\_raw\_count()*
- *gptimer\_set\_raw\_count()*
- *gptimer\_set\_alarm\_action()*

**线程安全** 驱动提供的所有 API 都是线程安全的。使用时，可以直接从不同的 RTOS 任务中调用此类函数，无需额外锁保护。以下这些函数还支持在中断上下文中运行。

- *gptimer\_start()*
- *gptimer\_stop()*
- *gptimer\_get\_raw\_count()*
- *gptimer\_set\_raw\_count()*
- *gptimer\_get\_captured\_count()*

<sup>2</sup> *gptimer\_event\_callbacks\_t::on\_alarm* 回调函数和这一函数调用的函数也需放在 IRAM 中，请自行处理。

- `gptimer_set_alarm_action()`

### Kconfig 选项

- `CONFIG_GPTIMER_CTRL_FUNC_IN_IRAM` 控制着定时器控制函数的存放位置 (IRAM 或 flash)。
- `CONFIG_GPTIMER_ISR_HANDLER_IN_IRAM` 控制着定时器中断处理函数的存放位置 (IRAM 或 flash)。
- `CONFIG_GPTIMER_ISR_IRAM_SAFE` 控制着中断处理函数是否需要在 cache 关闭的时候被屏蔽掉。更多信息, 请参阅 *IRAM 安全*。
- `CONFIG_GPTIMER_ENABLE_DEBUG_LOG` 用于启用调试日志输出。启用这一选项将增加固件二进制文件大小。

### 应用示例

- 示例 `peripherals/timer_group/gptimer` 中列出了通用定时器的典型用例。
- 示例 `peripherals/timer_group/gptimer_capture_hc_sr04` 展示了如何在 ETM 模块的帮助下, 用定时器捕获外部事件的时间戳。

### API 参考

#### Header File

- `components/esp_driver_gptimer/include/driver/gptimer.h`
- This header file can be included with:

```
#include "driver/gptimer.h"
```

- This header file is a part of the API provided by the `esp_driver_gptimer` component. To declare that your component depends on `esp_driver_gptimer`, add the following to your `CMakeLists.txt`:

```
REQUIRES esp_driver_gptimer
```

or

```
PRIV_REQUIRES esp_driver_gptimer
```

#### Functions

`esp_err_t gptimer_new_timer` (const `gptimer_config_t` \*config, `gptimer_handle_t` \*ret\_timer)

Create a new General Purpose Timer, and return the handle.

---

**备注:** The newly created timer is put in the "init" state.

---

#### 参数

- **config** -- [in] GPTimer configuration
- **ret\_timer** -- [out] Returned timer handle

#### 返回

- `ESP_OK`: Create GPTimer successfully
- `ESP_ERR_INVALID_ARG`: Create GPTimer failed because of invalid argument
- `ESP_ERR_NO_MEM`: Create GPTimer failed because out of memory
- `ESP_ERR_NOT_FOUND`: Create GPTimer failed because all hardware timers are used up and no more free one
- `ESP_FAIL`: Create GPTimer failed because of other error

*esp\_err\_t* **gptimer\_del\_timer** (*gptimer\_handle\_t* timer)

Delete the GPTimer handle.

---

**备注:** A timer must be in the "init" state before it can be deleted.

---

**参数** **timer** -- [in] Timer handle created by `gptimer_new_timer`

**返回**

- `ESP_OK`: Delete GPTimer successfully
- `ESP_ERR_INVALID_ARG`: Delete GPTimer failed because of invalid argument
- `ESP_ERR_INVALID_STATE`: Delete GPTimer failed because the timer is not in init state
- `ESP_FAIL`: Delete GPTimer failed because of other error

*esp\_err\_t* **gptimer\_set\_raw\_count** (*gptimer\_handle\_t* timer, `uint64_t` value)

Set GPTimer raw count value.

---

**备注:** When updating the raw count of an active timer, the timer will immediately start counting from the new value.

---

---

**备注:** This function is allowed to run within ISR context

---

---

**备注:** If `CONFIG_GPTIMER_CTRL_FUNC_IN_IRAM` is enabled, this function will be placed in the IRAM by linker, makes it possible to execute even when the Flash Cache is disabled.

---

**参数**

- **timer** -- [in] Timer handle created by `gptimer_new_timer`
- **value** -- [in] Count value to be set

**返回**

- `ESP_OK`: Set GPTimer raw count value successfully
- `ESP_ERR_INVALID_ARG`: Set GPTimer raw count value failed because of invalid argument
- `ESP_FAIL`: Set GPTimer raw count value failed because of other error

*esp\_err\_t* **gptimer\_get\_raw\_count** (*gptimer\_handle\_t* timer, `uint64_t *value`)

Get GPTimer raw count value.

---

**备注:** This function will trigger a software capture event and then return the captured count value.

---

---

**备注:** With the raw count value and the resolution returned from `gptimer_get_resolution`, you can convert the count value into seconds.

---

---

**备注:** This function is allowed to run within ISR context

---

---

**备注:** If `CONFIG_GPTIMER_CTRL_FUNC_IN_IRAM` is enabled, this function will be placed in the IRAM by linker, makes it possible to execute even when the Flash Cache is disabled.

---

**参数**

- **timer** -- [in] Timer handle created by `gptimer_new_timer`
- **value** -- [out] Returned GPTimer count value

**返回**

- ESP\_OK: Get GPTimer raw count value successfully
- ESP\_ERR\_INVALID\_ARG: Get GPTimer raw count value failed because of invalid argument
- ESP\_FAIL: Get GPTimer raw count value failed because of other error

*esp\_err\_t* `gptimer_get_resolution` (*gptimer\_handle\_t* timer, uint32\_t \*out\_resolution)

Return the real resolution of the timer.

---

**备注:** usually the timer resolution is same as what you configured in the `gptimer_config_t::resolution_hz`, but some unstable clock source (e.g. RC\_FAST) will do a calibration, the real resolution can be different from the configured one.

---

**参数**

- **timer** -- [in] Timer handle created by `gptimer_new_timer`
- **out\_resolution** -- [out] Returned timer resolution, in Hz

**返回**

- ESP\_OK: Get GPTimer resolution successfully
- ESP\_ERR\_INVALID\_ARG: Get GPTimer resolution failed because of invalid argument
- ESP\_FAIL: Get GPTimer resolution failed because of other error

*esp\_err\_t* `gptimer_get_captured_count` (*gptimer\_handle\_t* timer, uint64\_t \*value)

Get GPTimer captured count value.

---

**备注:** The capture action can be issued either by ETM event or by software (see also `gptimer_get_raw_count`).

---



---

**备注:** This function is allowed to run within ISR context

---



---

**备注:** If `CONFIG_GPTIMER_CTRL_FUNC_IN_IRAM` is enabled, this function will be placed in the IRAM by linker, makes it possible to execute even when the Flash Cache is disabled.

---

**参数**

- **timer** -- [in] Timer handle created by `gptimer_new_timer`
- **value** -- [out] Returned captured count value

**返回**

- ESP\_OK: Get GPTimer captured count value successfully
- ESP\_ERR\_INVALID\_ARG: Get GPTimer captured count value failed because of invalid argument
- ESP\_FAIL: Get GPTimer captured count value failed because of other error

*esp\_err\_t* `gptimer_register_event_callbacks` (*gptimer\_handle\_t* timer, const *gptimer\_event\_callbacks\_t* \*cbs, void \*user\_data)

Set callbacks for GPTimer.

---

**备注:** User registered callbacks are expected to be runnable within ISR context

---



---

**备注:** The first call to this function needs to be before the call to `gptimer_enable`

---

**备注:** User can deregister a previously registered callback by calling this function and setting the callback member in the `cbs` structure to NULL.

---

#### 参数

- **timer** -- **[in]** Timer handle created by `gptimer_new_timer`
- **cbs** -- **[in]** Group of callback functions
- **user\_data** -- **[in]** User data, which will be passed to callback functions directly

#### 返回

- ESP\_OK: Set event callbacks successfully
- ESP\_ERR\_INVALID\_ARG: Set event callbacks failed because of invalid argument
- ESP\_ERR\_INVALID\_STATE: Set event callbacks failed because the timer is not in init state
- ESP\_FAIL: Set event callbacks failed because of other error

*esp\_err\_t* `gptimer_set_alarm_action` (*gptimer\_handle\_t* timer, const *gptimer\_alarm\_config\_t* \*config)

Set alarm event actions for GPTimer.

---

**备注:** This function is allowed to run within ISR context, so you can update new alarm action immediately in any ISR callback.

---



---

**备注:** If `CONFIG_GPTIMER_CTRL_FUNC_IN_IRAM` is enabled, this function will be placed in the IRAM by linker, makes it possible to execute even when the Flash Cache is disabled. In this case, please also ensure the `gptimer_alarm_config_t` instance is placed in the static data section instead of in the read-only data section. e.g.: `static gptimer_alarm_config_t alarm_config = { ... };`

---

#### 参数

- **timer** -- **[in]** Timer handle created by `gptimer_new_timer`
- **config** -- **[in]** Alarm configuration, especially, set config to NULL means disabling the alarm function

#### 返回

- ESP\_OK: Set alarm action for GPTimer successfully
- ESP\_ERR\_INVALID\_ARG: Set alarm action for GPTimer failed because of invalid argument
- ESP\_FAIL: Set alarm action for GPTimer failed because of other error

*esp\_err\_t* `gptimer_enable` (*gptimer\_handle\_t* timer)

Enable GPTimer.

---

**备注:** This function will transit the timer state from "init" to "enable".

---



---

**备注:** This function will enable the interrupt service, if it's lazy installed in `gptimer_register_event_callbacks`.

---



---

**备注:** This function will acquire a PM lock, if a specific source clock (e.g. APB) is selected in the `gptimer_config_t`, while `CONFIG_PM_ENABLE` is enabled.

---



---

**备注:** Enable a timer doesn't mean to start it. See also `gptimer_start` for how to make the timer start counting.

---

**参数** `timer` -- [in] Timer handle created by `gptimer_new_timer`  
**返回**

- `ESP_OK`: Enable GPTimer successfully
- `ESP_ERR_INVALID_ARG`: Enable GPTimer failed because of invalid argument
- `ESP_ERR_INVALID_STATE`: Enable GPTimer failed because the timer is already enabled
- `ESP_FAIL`: Enable GPTimer failed because of other error

*esp\_err\_t* `gptimer_disable` (*gptimer\_handle\_t* timer)

Disable GPTimer.

---

**备注:** This function will transit the timer state from "enable" to "init".

---



---

**备注:** This function will disable the interrupt service if it's installed.

---



---

**备注:** This function will release the PM lock if it's acquired in the `gptimer_enable`.

---



---

**备注:** Disable a timer doesn't mean to stop it. See also `gptimer_stop` for how to make the timer stop counting.

---

**参数** `timer` -- [in] Timer handle created by `gptimer_new_timer`  
**返回**

- `ESP_OK`: Disable GPTimer successfully
- `ESP_ERR_INVALID_ARG`: Disable GPTimer failed because of invalid argument
- `ESP_ERR_INVALID_STATE`: Disable GPTimer failed because the timer is not enabled yet
- `ESP_FAIL`: Disable GPTimer failed because of other error

*esp\_err\_t* `gptimer_start` (*gptimer\_handle\_t* timer)

Start GPTimer (internal counter starts counting)

---

**备注:** This function will transit the timer state from "enable" to "run".

---



---

**备注:** This function is allowed to run within ISR context

---



---

**备注:** If `CONFIG_GPTIMER_CTRL_FUNC_IN_IRAM` is enabled, this function will be placed in the IRAM by linker, makes it possible to execute even when the Flash Cache is disabled.

---

**参数** `timer` -- [in] Timer handle created by `gptimer_new_timer`  
**返回**

- `ESP_OK`: Start GPTimer successfully
- `ESP_ERR_INVALID_ARG`: Start GPTimer failed because of invalid argument

- ESP\_ERR\_INVALID\_STATE: Start GPTimer failed because the timer is not enabled or is already in running
- ESP\_FAIL: Start GPTimer failed because of other error

*esp\_err\_t* **gptimer\_stop** (*gptimer\_handle\_t* timer)

Stop GPTimer (internal counter stops counting)

---

备注: This function will transit the timer state from "run" to "enable".

---



---

备注: This function is allowed to run within ISR context

---



---

备注: If CONFIG\_GPTIMER\_CTRL\_FUNC\_IN\_IRAM is enabled, this function will be placed in the IRAM by linker, makes it possible to execute even when the Flash Cache is disabled.

---

参数 **timer** -- [in] Timer handle created by `gptimer_new_timer`

返回

- ESP\_OK: Stop GPTimer successfully
- ESP\_ERR\_INVALID\_ARG: Stop GPTimer failed because of invalid argument
- ESP\_ERR\_INVALID\_STATE: Stop GPTimer failed because the timer is not in running.
- ESP\_FAIL: Stop GPTimer failed because of other error

## Structures

struct **gptimer\_config\_t**

General Purpose Timer configuration.

## Public Members

*gptimer\_clock\_source\_t* **clk\_src**

GPTimer clock source

*gptimer\_count\_direction\_t* **direction**

Count direction

uint32\_t **resolution\_hz**

Counter resolution (working frequency) in Hz, hence, the step size of each count tick equals to (1 / resolution\_hz) seconds

int **intr\_priority**

GPTimer interrupt priority, if set to 0, the driver will try to allocate an interrupt with a relative low priority (1,2,3)

uint32\_t **intr\_shared**

Set true, the timer interrupt number can be shared with other peripherals

uint32\_t **backup\_before\_sleep**

If set, the driver will backup/restore the GPTimer registers before/after entering/exist sleep mode. By this approach, the system can power off GPTimer's power domain. This can save power, but at the expense of more RAM being consumed

struct *gptimer\_config\_t*::[anonymous] **flags**  
GPTimer config flags

struct **gptimer\_event\_callbacks\_t**  
Group of supported GPTimer callbacks.

---

**备注:** The callbacks are all running under ISR environment

---

---

**备注:** When CONFIG\_GPTIMER\_ISR\_IRAM\_SAFE is enabled, the callback itself and functions called by it should be placed in IRAM.

---

### Public Members

*gptimer\_alarm\_cb\_t* **on\_alarm**  
Timer alarm callback

struct **gptimer\_alarm\_config\_t**  
General Purpose Timer alarm configuration.

### Public Members

uint64\_t **alarm\_count**  
Alarm target count value

uint64\_t **reload\_count**  
Alarm reload count value, effect only when `auto_reload_on_alarm` is set to true

uint32\_t **auto\_reload\_on\_alarm**  
Reload the count value by hardware, immediately at the alarm event

struct *gptimer\_alarm\_config\_t*::[anonymous] **flags**  
Alarm config flags

### Header File

- [components/esp\\_driver\\_gptimer/include/driver/gptimer\\_etm.h](#)
- This header file can be included with:

```
#include "driver/gptimer_etm.h"
```

- This header file is a part of the API provided by the `esp_driver_gptimer` component. To declare that your component depends on `esp_driver_gptimer`, add the following to your `CMakeLists.txt`:

```
REQUIRES esp_driver_gptimer
```

or

```
PRIV_REQUIRES esp_driver_gptimer
```

**Functions**

`esp_err_t gptimer_new_etm_event` (*gptimer\_handle\_t* timer, const *gptimer\_etm\_event\_config\_t* \*config, *esp\_etm\_event\_handle\_t* \*out\_event)

Get the ETM event for GPTimer.

---

**备注:** The created ETM event object can be deleted later by calling `esp_etm_del_event`

---

**参数**

- **timer** -- **[in]** Timer handle created by `gptimer_new_timer`
- **config** -- **[in]** GPTimer ETM event configuration
- **out\_event** -- **[out]** Returned ETM event handle

**返回**

- **ESP\_OK**: Get ETM event successfully
- **ESP\_ERR\_INVALID\_ARG**: Get ETM event failed because of invalid argument
- **ESP\_FAIL**: Get ETM event failed because of other error

`esp_err_t gptimer_new_etm_task` (*gptimer\_handle\_t* timer, const *gptimer\_etm\_task\_config\_t* \*config, *esp\_etm\_task\_handle\_t* \*out\_task)

Get the ETM task for GPTimer.

---

**备注:** The created ETM task object can be deleted later by calling `esp_etm_del_task`

---

**参数**

- **timer** -- **[in]** Timer handle created by `gptimer_new_timer`
- **config** -- **[in]** GPTimer ETM task configuration
- **out\_task** -- **[out]** Returned ETM task handle

**返回**

- **ESP\_OK**: Get ETM task successfully
- **ESP\_ERR\_INVALID\_ARG**: Get ETM task failed because of invalid argument
- **ESP\_FAIL**: Get ETM task failed because of other error

**Structures**

struct `gptimer_etm_event_config_t`

GPTimer ETM event configuration.

**Public Members**

*gptimer\_etm\_event\_type\_t* **event\_type**

GPTimer ETM event type

struct `gptimer_etm_task_config_t`

GPTimer ETM task configuration.

**Public Members**

*gptimer\_etm\_task\_type\_t* **task\_type**

GPTimer ETM task type

## Header File

- [components/esp\\_driver\\_gptimer/include/driver/gptimer\\_types.h](#)
- This header file can be included with:

```
#include "driver/gptimer_types.h"
```

- This header file is a part of the API provided by the `esp_driver_gptimer` component. To declare that your component depends on `esp_driver_gptimer`, add the following to your `CMakeLists.txt`:

```
REQUIRES esp_driver_gptimer
```

or

```
PRIV_REQUIRES esp_driver_gptimer
```

## Structures

struct **gptimer\_alarm\_event\_data\_t**

GPTimer alarm event data.

### Public Members

uint64\_t **count\_value**

Current count value

uint64\_t **alarm\_value**

Current alarm value

## Type Definitions

typedef struct gptimer\_t \***gptimer\_handle\_t**

Type of General Purpose Timer handle.

typedef bool (\***gptimer\_alarm\_cb\_t**)(*gptimer\_handle\_t* timer, const *gptimer\_alarm\_event\_data\_t* \*edata, void \*user\_ctx)

Timer alarm callback prototype.

**Param timer [in]** Timer handle created by `gptimer_new_timer`

**Param edata [in]** Alarm event data, fed by driver

**Param user\_ctx [in]** User data, passed from `gptimer_register_event_callbacks`

**Return** Whether a high priority task has been waken up by this function

## Header File

- [components/hal/include/hal/timer\\_types.h](#)
- This header file can be included with:

```
#include "hal/timer_types.h"
```

## Type Definitions

typedef *soc\_periph\_gptimer\_clk\_src\_t* **gptimer\_clock\_source\_t**

GPTimer clock source.

---

备注: User should select the clock source based on the power and resolution requirement

---

### Enumerations

enum **gptimer\_count\_direction\_t**

GPTimer count direction.

*Values:*

enumerator **GPTIMER\_COUNT\_DOWN**

Decrease count value

enumerator **GPTIMER\_COUNT\_UP**

Increase count value

enum **gptimer\_etm\_task\_type\_t**

GPTimer specific tasks that supported by the ETM module.

*Values:*

enumerator **GPTIMER\_ETM\_TASK\_START\_COUNT**

Start the counter

enumerator **GPTIMER\_ETM\_TASK\_STOP\_COUNT**

Stop the counter

enumerator **GPTIMER\_ETM\_TASK\_EN\_ALARM**

Enable the alarm

enumerator **GPTIMER\_ETM\_TASK\_RELOAD**

Reload preset value into counter

enumerator **GPTIMER\_ETM\_TASK\_CAPTURE**

Capture current count value into specific register

enumerator **GPTIMER\_ETM\_TASK\_MAX**

Maximum number of tasks

enum **gptimer\_etm\_event\_type\_t**

GPTimer specific events that supported by the ETM module.

*Values:*

enumerator **GPTIMER\_ETM\_EVENT\_ALARM\_MATCH**

Count value matches the alarm target value

enumerator **GPTIMER\_ETM\_EVENT\_MAX**

Maximum number of events

## 2.6.10 专用 GPIO

### 概述

专用 GPIO 专为 CPU 与 GPIO 矩阵和 IO MUX 交互而设计。任何配置为“专用”的 GPIO 都可以通过 CPU 指令直接访问，从而轻松提高 GPIO 翻转速度，方便用户以 bit-banging 的方式模拟串行/并行接口。通过 CPU 指令的方式控制 GPIO 的软件开销非常小，因此能够胜任一些特殊场合，比如通过示波器观测“GPIO 翻转信号”来间接测量某些性能指标。

### 创建/销毁 GPIO 捆绑包

GPIO 捆绑包是一组 GPIO，该组 GPIO 可以在一个 CPU 周期内同时操作。一个包能够包含 GPIO 的最大数量受每个 CPU 的限制。另外，GPIO 捆绑包与派生它的 CPU 有很强的相关性。**注意，任何对 GPIO 捆绑包操作的任务都必须运行在 GPIO 捆绑包所属的 CPU 内核。**同理，只有那些安装在同一个 CPU 内核上的 ISR 才允许对该 GPIO 捆绑包进行操作。

**备注：**专用 GPIO 更像是 CPU 外设，因此与 CPU 内核关系密切。强烈建议在 pin-to-core 任务中安装和操作 GPIO 捆绑包。例如，如果 GPIOA 连接到了 CPU0，而专用的 GPIO 指令却是从 CPU1 发出的，那么就无法控制 GPIOA。

安装 GPIO 捆绑包需要调用 `dedic_gpio_new_bundle()` 来分配软件资源并将专用通道连接到用户选择的 GPIO。GPIO 捆绑包的配置在 `dedic_gpio_bundle_config_t` 结构体中：

- `gpio_array`: 包含 GPIO 编号的数组。
- `array_size`: `gpio_array` 的元素个数。
- `flags`: 用于控制 GPIO 捆绑包行为的标志。
  - `in_en` 和 `out_en` 用于选择是否开启输入输出功能（这两个功能可以同时开启）。
  - `in_invert` 和 `out_invert` 用于选择是否反转 GPIO 信号。

以下代码展示了如何安装只有输出功能的 GPIO 捆绑包：

```
// 配置 GPIO
const int bundleA_gpios[] = {0, 1};
gpio_config_t io_conf = {
    .mode = GPIO_MODE_OUTPUT,
};
for (int i = 0; i < sizeof(bundleA_gpios) / sizeof(bundleA_gpios[0]); i++) {
    io_conf.pin_bit_mask = 1ULL << bundleA_gpios[i];
    gpio_config(&io_conf);
}
// 创建 bundleA, 仅输出
dedic_gpio_bundle_handle_t bundleA = NULL;
dedic_gpio_bundle_config_t bundleA_config = {
    .gpio_array = bundleA_gpios,
    .array_size = sizeof(bundleA_gpios) / sizeof(bundleA_gpios[0]),
    .flags = {
        .out_en = 1,
    },
};
ESP_ERROR_CHECK(dedic_gpio_new_bundle(&bundleA_config, &bundleA));
```

如需卸载 GPIO 捆绑包，可调用 `dedic_gpio_del_bundle()`。

**备注：**`dedic_gpio_new_bundle()` 不包含任何 GPIO pad 配置（例如上拉/下拉、驱动能力、输出/输入使能）。因此，在安装专用 GPIO 捆绑包之前，必须使用 GPIO 驱动程序 API（如 `gpio_config()`）单

独配置 GPIO。更多关于 GPIO 驱动的信息，请参考[GPIO API 参考](#)。

## GPIO 捆绑包操作

操作	函数
以掩码的方式指定 GPIO 捆绑包的输出	<code>dedic_gpio_bundle_write()</code>
读取 GPIO 捆绑包实际输出的电平值	<code>dedic_gpio_bundle_read_out()</code>
读取 GPIO 捆绑包中输入的电平值	<code>dedic_gpio_bundle_read_in()</code>

**备注：** 由于函数调用的开销和内部涉及的位操作，使用上述函数可能无法获得较高的 GPIO 翻转速度。用户可以尝试[通过编写汇编代码操作 GPIO](#)来减少开销，但应自行注意线程安全。

## 通过编写汇编代码操作 GPIO

高阶用户可以通过编写汇编代码或调用 CPU 低层 API 来操作 GPIO。常见步骤为：

1. 分配一个 GPIO 捆绑包：`dedic_gpio_new_bundle()`
2. 查询该包占用的掩码：`dedic_gpio_get_out_mask()` 和/或 `dedic_gpio_get_in_mask()`
3. 调用 CPU LL apis（如 `cpu_ll_write_dedic_gpio_mask`）或使用该掩码编写汇编代码
4. 切换 IO 的最快捷方式是使用专用的“设置/清除”指令：
  - 设置 GPIO 位：`csrrsi rd, csr, imm[4:0]`
  - 清除 GPIO 位：`csrrci rd, csr, imm[4:0]`
  - 注意：只能控制最低位的 4 个 GPIO 通道

有关支持的专用 GPIO 指令的详细信息，请参考 [ESP32-H2 技术参考手册 > ESP-RISC-V CPU \[PDF\]](#)。

一些专用的 CPU 指令也包含在 `hal/dedic_gpio_cpu_ll.h` 中，作为辅助内联函数。

**备注：** 由于自定义指令在不同目标上可能会有不同的格式，在应用程序中编写汇编代码可能会让代码难以在不同的芯片架构之间移植。

## 应用示例

- 通过汇编代码使用专用的 CPU 指令来操作 GPIO 以模拟 UART/I2C/SPI 协议（Bit Banging）[peripherals/dedicated\\_gpio](#).

## API 参考

### Header File

- `components/esp_driver_gpio/include/driver/dedic_gpio.h`
- This header file can be included with:

```
#include "driver/dedic_gpio.h"
```

- This header file is a part of the API provided by the `esp_driver_gpio` component. To declare that your component depends on `esp_driver_gpio`, add the following to your `CMakeLists.txt`:

```
REQUIRES esp_driver_gpio
```

or



```
PRIV_REQUIRES esp_driver_gpio
```

## Functions

*esp\_err\_t* **dedic\_gpio\_get\_out\_mask** (*dedic\_gpio\_bundle\_handle\_t* bundle, uint32\_t \*mask)

Get allocated channel mask.

---

**备注:** Each bundle should have at least one mask (in or/and out), based on bundle configuration.

---



---

**备注:** With the returned mask, user can directly invoke LL function like "dedic\_gpio\_cpu\_ll\_write\_mask" or write assembly code with dedicated GPIO instructions, to get better performance on GPIO manipulation.

---

### 参数

- **bundle** -- **[in]** Handle of GPIO bundle that returned from "dedic\_gpio\_new\_bundle"
- **mask** -- **[out]** Returned mask value for on specific direction (in or out)

### 返回

- ESP\_OK: Get channel mask successfully
- ESP\_ERR\_INVALID\_ARG: Get channel mask failed because of invalid argument
- ESP\_FAIL: Get channel mask failed because of other error

*esp\_err\_t* **dedic\_gpio\_get\_in\_mask** (*dedic\_gpio\_bundle\_handle\_t* bundle, uint32\_t \*mask)

*esp\_err\_t* **dedic\_gpio\_get\_out\_offset** (*dedic\_gpio\_bundle\_handle\_t* bundle, uint32\_t \*offset)

Get the channel offset of the GPIO bundle.

A GPIO bundle maps the GPIOs of a particular direction to a consecutive set of channels within a particular GPIO bank of a particular CPU. This function returns the offset to the bundle's first channel of a particular direction within the bank.

### 参数

- **bundle** -- **[in]** Handle of GPIO bundle that returned from "dedic\_gpio\_new\_bundle"
- **offset** -- **[out]** Offset value to the first channel of a specific direction (in or out)

### 返回

- ESP\_OK: Get channel offset successfully
- ESP\_ERR\_INVALID\_ARG: Get channel offset failed because of invalid argument
- ESP\_FAIL: Get channel offset failed because of other error

*esp\_err\_t* **dedic\_gpio\_get\_in\_offset** (*dedic\_gpio\_bundle\_handle\_t* bundle, uint32\_t \*offset)

*esp\_err\_t* **dedic\_gpio\_new\_bundle** (const *dedic\_gpio\_bundle\_config\_t* \*config, *dedic\_gpio\_bundle\_handle\_t* \*ret\_bundle)

Create GPIO bundle and return the handle.

---

**备注:** One has to enable at least input or output mode in "config" parameter.

---

### 参数

- **config** -- **[in]** Configuration of GPIO bundle
- **ret\_bundle** -- **[out]** Returned handle of the new created GPIO bundle

### 返回

- ESP\_OK: Create GPIO bundle successfully
- ESP\_ERR\_INVALID\_ARG: Create GPIO bundle failed because of invalid argument
- ESP\_ERR\_NO\_MEM: Create GPIO bundle failed because of no capable memory
- ESP\_ERR\_NOT\_FOUND: Create GPIO bundle failed because of no enough continuous dedicated channels
- ESP\_FAIL: Create GPIO bundle failed because of other error

`esp_err_t dedic_gpio_del_bundle` (*dedic\_gpio\_bundle\_handle\_t* bundle)

Destroy GPIO bundle.

**参数** **bundle** -- **[in]** Handle of GPIO bundle that returned from "dedic\_gpio\_new\_bundle"

**返回**

- ESP\_OK: Destroy GPIO bundle successfully
- ESP\_ERR\_INVALID\_ARG: Destroy GPIO bundle failed because of invalid argument
- ESP\_FAIL: Destroy GPIO bundle failed because of other error

void `dedic_gpio_bundle_write` (*dedic\_gpio\_bundle\_handle\_t* bundle, uint32\_t mask, uint32\_t value)

Write value to GPIO bundle.

---

**备注:** The mask is seen from the view of GPIO bundle. For example, bundleA contains [GPIO10, GPIO12, GPIO17], to set GPIO17 individually, the mask should be 0x04.

---



---

**备注:** For performance reasons, this function doesn't check the validity of any parameters, and is placed in IRAM.

---

**参数**

- **bundle** -- **[in]** Handle of GPIO bundle that returned from "dedic\_gpio\_new\_bundle"
- **mask** -- **[in]** Mask of the GPIOs to be written in the given bundle
- **value** -- **[in]** Value to write to given GPIO bundle, low bit represents low member in the bundle

uint32\_t `dedic_gpio_bundle_read_out` (*dedic\_gpio\_bundle\_handle\_t* bundle)

Read the value that output from the given GPIO bundle.

---

**备注:** For performance reasons, this function doesn't check the validity of any parameters, and is placed in IRAM.

---

**参数** **bundle** -- **[in]** Handle of GPIO bundle that returned from "dedic\_gpio\_new\_bundle"

**返回** Value that output from the GPIO bundle, low bit represents low member in the bundle

uint32\_t `dedic_gpio_bundle_read_in` (*dedic\_gpio\_bundle\_handle\_t* bundle)

Read the value that input to the given GPIO bundle.

---

**备注:** For performance reasons, this function doesn't check the validity of any parameters, and is placed in IRAM.

---

**参数** **bundle** -- **[in]** Handle of GPIO bundle that returned from "dedic\_gpio\_new\_bundle"

**返回** Value that input to the GPIO bundle, low bit represents low member in the bundle

## Structures

struct `dedic_gpio_bundle_config_t`

Type of Dedicated GPIO bundle configuration.

## Public Members

```

const int *gpio_array
    Array of GPIO numbers, gpio_array[0] ~ gpio_array[size-1] <=> low_dedic_channel_num ~
    high_dedic_channel_num

size_t array_size
    Number of GPIOs in gpio_array

unsigned int in_en
    Enable input

unsigned int in_invert
    Invert input signal

unsigned int out_en
    Enable output

unsigned int out_invert
    Invert output signal

struct dedic_gpio_bundle_config_t::[anonymous] flags
    Flags to control specific behaviour of GPIO bundle

```

### Type Definitions

```

typedef struct dedic_gpio_bundle_t *dedic_gpio_bundle_handle_t
    Type of Dedicated GPIO bundle.

```

## 2.6.11 哈希消息认证码 (HMAC)

哈希消息认证码 (HMAC) 是一种安全的身份认证技术，支持使用预共享的密钥验证消息的真实性和完整性。利用烧录在 eFuse 块中的密钥，HMAC 可以为生成 SHA256-HMAC 提供硬件加速。

更多有关应用操作流程，及 HMAC 计算过程的详细信息，请参阅 [ESP32-H2 技术参考手册 > HMAC 加速器 \(HMAC\) \[PDF\]](#)。

### 通用应用方案

现有 A、B 双方，他们都需要验证对方发送消息的真实性和完整性。那么在开始发送消息前，双方应通过安全通道交换密钥。

要验证来自 A 的信息，B 可遵循以下步骤：

- A 计算要发送的消息的 HMAC。
- A 将消息及消息的 HMAC 一并发送给 B。
- B 自行计算所接收消息的 HMAC。
- B 检查接收到的 HMAC 是否与计算得出的 HMAC 匹配。

若两个 HMAC 匹配，消息为真。

但 HMAC 本身还可以应用于更多场景，如支持 HMAC 的挑战-应答协议，或作为更多安全模块（详见下文）的密钥输入等。

## ESP32-H2 上的 HMAC

在 ESP32-H2 HMAC 模块的 eFuse 中会烧录一个密钥，可将该 eFuse 密钥设置为禁止所有外部资源访问，避免密钥泄露。

此外，在 ESP32-H2 上的 HMAC 有以下三种应用场景：

1. HMAC 支持软件使用
2. HMAC 用作数字签名 (DS) 的密钥
3. HMAC 用于启用软禁用的 JTAG 接口

第一种应用场景称为 **上行模式**，后两种应用场景称为 **下行模式**。

**HMAC 的 eFuse 密钥** 在 ESP32-H2 中，有六个物理 eFuse 块可用作 HMAC 的密钥，分别是块 4 到块 9。在 API 中，枚举类型 `hmac_key_id_t` 将这些块映射为 HMAC\_KEY0 ~ HMAC\_KEY5。

每个密钥都有相应的 eFuse 参数 **密钥功能 (key purpose)**，决定密钥应用于 HMAC 的哪种应用场景。

密钥功能	应用场景
8	HMAC 支持软件使用
7	HMAC 用作数字签名 (DS) 的密钥
6	HMAC 启用软禁用的 JTAG 接口
5	HMAC 既用作数字签名 (DS) 的密钥，又用于启用 JTAG 接口

这样一来，可以确保密钥用于原定场景。

要计算 HMAC，软件必须同时提供包含密钥的密钥块 ID，以及 **密钥功能**（详情请参阅 **ESP32-H2 技术参考手册 > eFuse 控制器 (eFuse) [PDF]**）。

在进行 HMAC 密钥计算前，HMAC 会验证软件所提供密钥块的功能。在软件所提供 ID 的对应密钥块中，eFuse 存储了密钥块的功能。只有当软件所提供密钥块的功能与 eFuse 中存储的密钥块功能匹配，才会继续进行计算。

### HMAC 支持软件使用 密钥功能值：8

在此情况下，HMAC 支持软件使用，如验证消息真实性等。

API `esp_hmac_calculate()` 用于计算 HMAC。输入参数包括消息、消息长度以及包含密钥的 eFuse 密钥块 ID，且该密钥块的 eFuse 密钥功能设置为上行模式。

### HMAC 用作数字签名 (DS) 的密钥 密钥功能值：7、5

HMAC 可用作密钥派生函数，解码数字签名模块使用的私钥参数。在此情况下，硬件使用标准信息计算。在 HMAC 部分只需提供 eFuse 密钥块和功能；而在数字签名模块则还需要一些额外参数。

无论是密钥还是实际的 HMAC，都不会暴露在 HMAC 和数字签名模块之外。对 HMAC 的计算，以及将其传递给数字签名模块的过程，均在内部进行。

详情请参阅 **ESP32-H2 技术参考手册 > 数字签名 (DS) [PDF]**。

### HMAC 启用 JTAG 接口 密钥功能值：6、5

HMAC 的第三种应用场景是将其作为密钥，启用软禁用的 JTAG 接口。

重新启用 JTAG 接口的步骤如下：

#### 第一步：设置

1. 生成一个 256 位的 HMAC 密钥，用于重新启用 JTAG。
2. 将步骤 1 获得的密钥写入 eFuse 块，且 eFuse 块的密钥功能参数应为 HMAC\_DOWN\_ALL (5) 或 HMAC\_DOWN\_JTAG (6)。为此，可以使用固件中的 `esp_efuse_write_key()` 函数，或使用主机上的 `espefuse.py` 完成操作。

3. 使用 `esp_efuse_set_read_protect()` 将 eFuse 密钥块配置为读保护，防止软件读取写入到 eFuse 密钥块中的 HMAC 密钥值。
4. 在烧录到 ESP32-H2 上时，将特定的位或位组设置为 `soft JTAG disable`。这样可以永久禁用 JTAG 接口，除非软件提供正确的密钥值进行验证。

**备注:** API `esp_efuse_write_field_cnt(ESP_EFUSE_SOFT_DIS_JTAG, ESP_EFUSE_SOFT_DIS_JTAG[0]->bit_count)` 支持在 ESP32-H2 上烧录 `soft JTAG disable` 位。

**备注:** 置位 `DIS_PAD_JTAG` eFuse 时，JTAG 处于永久禁用状态，`SOFT_DIS_JTAG` 功能将失效。

## 启用 JTAG

1. 以 eFuse 中的密钥和 32 个 `0x00` 字节为输入，经过 HMAC-SHA256 函数处理，得到的函数输出结果即重新启用 JTAG 的密钥。
2. 从固件调用 `esp_hmac_jtag_enable()` 函数时，传递上一步获取的密钥值。
3. 要在固件中重新禁用 JTAG，可以重置系统，或调用 `esp_hmac_jtag_disable()`。

关于如何暂时禁用以及重新启用 JTAG 的完整示例，请参考 [security/hmac\\_soft\\_jtag](#)。

更多有关详情，请参阅 [ESP32-H2 技术参考手册 > HMAC 加速器 \(HMAC\) \[PDF\]](#)。

## 应用示例

以下为针对特定应用场景的实例代码，可用于设置 eFuse 密钥，并将其用于计算支持软件使用的 HMAC。

`esp_efuse_write_key` 可以设置 eFuse 中的物理密钥块 4，并设置其功能。ESP\_EFUSE\_KEY\_PURPOSE\_HMAC\_UP (8) 表明，该密钥仅适用于生成支持软件使用的 HMAC。

```
#include "esp_efuse.h"

const uint8_t key_data[32] = { ... };

esp_err_t status = esp_efuse_write_key(EFUSE_BLK_KEY4,
    ESP_EFUSE_KEY_PURPOSE_HMAC_UP,
    key_data, sizeof(key_data));

if (status == ESP_OK) {
    // 密钥写入成功
} else {
    // 密钥写入失败，可能已写入过
}
```

接下来可以使用已存储的密钥来计算 HMAC，供软件使用。

```
#include "esp_hmac.h"

uint8_t hmac[32];

const char *message = "Hello, HMAC!";
const size_t msg_len = 12;

esp_err_t result = esp_hmac_calculate(HMAC_KEY4, message, msg_len, hmac);

if (result == ESP_OK) {
    // HMAC 已写入 hmac 数组
} else {
    // 计算 HMAC 失败
}
```

## API 参考

### Header File

- `components/esp_hw_support/include/esp_hmac.h`
- This header file can be included with:

```
#include "esp_hmac.h"
```

### Functions

`esp_err_t esp_hmac_calculate` (`hmac_key_id_t` key\_id, const void \*message, size\_t message\_len, uint8\_t \*hmac)

Calculate the HMAC of a given message.

Calculate the HMAC hmac of a given message message with length message\_len. SHA256 is used for the calculation.

---

**备注:** Uses the HMAC peripheral in "upstream" mode.

---

#### 参数

- **key\_id** -- Determines which of the 6 key blocks in the efuses should be used for the HMAC calculation. The corresponding purpose field of the key block in the efuse must be set to the HMAC upstream purpose value.
- **message** -- the message for which to calculate the HMAC
- **message\_len** -- message length return ESP\_ERR\_INVALID\_STATE if unsuccessful
- **hmac** -- [out] the hmac result; the buffer behind the provided pointer must be a writeable buffer of 32 bytes

#### 返回

- ESP\_OK, if the calculation was successful,
- ESP\_ERR\_INVALID\_ARG if message or hmac is a nullptr or if key\_id out of range
- ESP\_FAIL, if the hmac calculation failed

`esp_err_t esp_hmac_jtag_enable` (`hmac_key_id_t` key\_id, const uint8\_t \*token)

Use HMAC peripheral in Downstream mode to re-enable the JTAG, if it is not permanently disabled by HW. In downstream mode, HMAC calculations performed by peripheral are used internally and not provided back to user.

---

**备注:** Return value of the API does not indicate the JTAG status.

---

#### 参数

- **key\_id** -- Determines which of the 6 key blocks in the efuses should be used for the HMAC calculation. The corresponding purpose field of the key block in the efuse must be set to HMAC downstream purpose.
- **token** -- Pre calculated HMAC value of the 32-byte 0x00 using SHA-256 and the known private HMAC key. The key is already programmed to a eFuse key block. The key block number is provided as the first parameter to this function.

#### 返回

- ESP\_OK, if the key\_purpose of the key\_id matches to HMAC downstream mode, The API returns success even if calculated HMAC does not match with the provided token. However, The JTAG will be re-enabled only if the calculated HMAC value matches with provided token, otherwise JTAG will remain disabled.
- ESP\_FAIL, if the key\_purpose of the key\_id is not set to HMAC downstream purpose or JTAG is permanently disabled by EFUSE\_HARD\_DIS\_JTAG eFuse parameter.
- ESP\_ERR\_INVALID\_ARG, invalid input arguments

`esp_err_t esp_hmac_jtag_disable` (void)

Disable the JTAG which might be enabled using the HMAC downstream mode. This function just clears the result generated by calling `esp_hmac_jtag_enable`() API.

返回

- ESP\_OK return ESP\_OK after writing the HMAC\_SET\_INVALIDATE\_JTAG\_REG with value 1.

## Enumerations

enum `hmac_key_id_t`

The possible efuse keys for the HMAC peripheral

Values:

enumerator `HMAC_KEY0`

enumerator `HMAC_KEY1`

enumerator `HMAC_KEY2`

enumerator `HMAC_KEY3`

enumerator `HMAC_KEY4`

enumerator `HMAC_KEY5`

enumerator `HMAC_KEY_MAX`

### 2.6.12 数字签名 (DS)

数字签名 (DS) 模块利用 RSA 硬件加速器为信息签名。HMAC 作为密钥派生函数，使用 eFuse 作为输入密钥，输出一组加密参数。随后，数字签名模块利用这组预加密的参数，计算出签名。以上过程均在硬件中完成，因此在计算签名时，软件无法获取 RSA 参数的解密密钥，也无法获取 HMAC 密钥派生函数的输入密钥。

签名计算所涉及的硬件信息以及所用寄存器的有关信息，请参阅 [ESP32-H2 技术参考手册 > 数字签名 \(DS\) \[PDF\]](#)。

#### 私钥参数

RSA 签名的私钥参数存储在 flash 中。为防止发生未经授权的访问，这些参数都进行了 AES 加密。此时，HMAC 模块被作为密钥派生函数，用于计算 AES 加密了的私钥参数。同时，HMAC 模块本身使用的来自 eFuse 密钥块的密钥也具有读取保护，可以防止发生未经授权的访问。

调用签名计算时，软件只需指定使用的 eFuse 密钥、相应的 eFuse 密钥用途、加密的 RSA 参数位置以及待签名的数据或信息。



## 密钥生成

在使用 DS 外设前，需首先创建并存储 HMAC 密钥和 RSA 私钥，此步骤可在 ESP32-H2 上通过软件完成，也可在主机上进行。在 ESP-IDF 中，可以使用 `esp_efuse_write_block()` 设置 HMAC 密钥，并使用 `esp_hmac_calculate()` 对 RSA 私钥参数进行加密。

计算并组装私钥参数的详细信息，请参阅 [ESP32-H2 技术参考手册 > 数字签名 \(DS\) \[PDF\]](#)。

## 在 ESP-IDF 中进行数字签名计算

在 ESP-IDF 中进行数字签名计算的工作流程，以及所用寄存器的有关信息，请参阅 [ESP32-H2 技术参考手册 > 数字签名 \(DS\) \[PDF\]](#)。

要进行数字签名计算，需要准备以下三个参数：

1. 用作 HMAC 密钥的 eFuse 密钥块 ID
2. 加密私钥参数的位置
3. 待签名的数据或信息

由于签名计算需要一些时间，ESP-IDF 提供了两种可用的 API。第一种是 `esp_ds_sign()`，调用此 API 后，程序会在计算完成前保持阻塞状态。如果在计算过程中，软件需要执行其他操作，则可以调用 `esp_ds_start_sign()`，用另一种方式启动签名计算，然后周期性地调用 `esp_ds_is_busy()`，检查计算是否已完成。一旦计算完成，即可调用 `esp_ds_finish_sign()` 来获取签名结果。

API `esp_ds_sign()` 和 `esp_ds_start_sign()` 会借助 DS 外设计算明文 RSA 签名。RSA 签名需要转换成合适的格式，以供进一步使用。例如，MbedTLS SSL 栈支持 PKCS#1 格式，使用 API `esp_ds_rsa_sign()` 可以直接获得 PKCS#1 v1.5 格式的签名，该 API 内部调用了 `esp_ds_start_sign()` 函数，并将签名转换成 PKCS#1 v1.5 格式。

---

**备注：**此处只是最基本的 DS 构造块，其消息必须是固定长度。为在任意消息上创建签名，通常会将实际消息的哈希值作为输入，并将其填充到所需长度。乐鑫计划在未来提供一个 API 来实现这个功能。

---

## TLS 连接所需的 DS 外设配置

在 ESP32-H2 芯片上使用 TLS 连接之前，必须先配置 DS 外设，具体步骤如下：

- 1) 随机生成一个 256 位的值，作为初始化向量 (IV)。
- 2) 随机生成一个 256 位的值，作为 HMAC\_KEY。
- 3) 使用客户端私钥 (RAS) 和上述步骤生成的参数，计算加密的私钥参数。
- 4) 将 256 位的 HMAC\_KEY 烧录到 eFuse 中，只支持 DS 外设读取。

更多细节，请参阅 [ESP32-H2 技术参考手册 > 数字签名 \(DS\) \[PDF\]](#)。

如果要以开发为目的配置 DS 外设，可以使用 `esp-secure-cert-tool`。

配置完 DS 外设后获取的加密私钥参数需要保存在 flash 中并传递给 DS 外设，DS 外设将使用这些参数完成数字签名。随后，应用程序需要从 flash 中读取 DS 数据，这可以通过 `esp_secure_cert_mgr` 组件提供的 API 完成。更多细节，请参阅 [component/README](#)。

在 `esp_tls` 仓库内部，*ESP-TLS* 负责完成初始化 DS 外设、执行数字签名的过程。更多细节，请参阅 [ESP-TLS 的数字签名](#)。

如 *ESP-TLS* 文档所述，应用程序只需将加密私钥参数作为 `ds_data` 传递给 `esp_tls` 上下文，`esp_tls` 仓库内部就会执行所有必要操作，以初始化 DS 外设，并执行数字签名。

## 使用 DS 外设进行 SSL 双向认证

示例 [protocols/mqtt/ssl\\_ds](#) 展示了如何使用 DS 外设进行 SSL 双向认证。在示例中，使用了 `mqtt_client`（通过 *ESP-MQTT* 实现），通过 SSL 传输连接到代理服务器 `test.mosquitto.org`，并进行 SSL 双向认证。SSL 部分在内部使用 *ESP-TLS* 完成。更多细节，请参阅 [protocols/mqtt/ssl\\_ds/README.md](#)。



## API 参考

## Header File

- `components/esp_hw_support/include/esp_ds.h`
- This header file can be included with:

```
#include "esp_ds.h"
```

## Functions

`esp_err_t esp_ds_sign` (const void \*message, const `esp_ds_data_t` \*data, `hmac_key_id_t` key\_id, void \*signature)

Sign the message with a hardware key from specific key slot. The function calculates a plain RSA signature with help of the DS peripheral. The RSA encryption operation is as follows:  $Z = XY \bmod M$  where, Z is the signature, X is the input message, Y and M are the RSA private key parameters.

This function is a wrapper around `esp_ds_finish_sign()` and `esp_ds_start_sign()`, so do not use them in parallel. It blocks until the signing is finished and then returns the signature.

---

**备注:** Please see note section of `esp_ds_start_sign()` for more details about the input parameters.

---

## 参数

- **message** -- the message to be signed; its length should be  $(data->rsa\_length + 1) * 4$  bytes, and those bytes must be in little endian format. It is your responsibility to apply your hash function and padding before calling this function, if required. (e.g. `message = padding(hash(inputMsg))`)
- **data** -- the encrypted signing key data (AES encrypted RSA key + IV)
- **key\_id** -- the HMAC key ID determining the HMAC key of the HMAC which will be used to decrypt the signing key data
- **signature** -- the destination of the signature, should be  $(data->rsa\_length + 1) * 4$  bytes long

## 返回

- `ESP_OK` if successful, the signature was written to the parameter `signature`.
- `ESP_ERR_INVALID_ARG` if one of the parameters is NULL or `data->rsa_length` is too long or 0
- `ESP_ERR_HW_CRYPTODS_HMAC_FAIL` if there was an HMAC failure during retrieval of the decryption key
- `ESP_ERR_NO_MEM` if there hasn't been enough memory to allocate the context object
- `ESP_ERR_HW_CRYPTODS_INVALID_KEY` if there's a problem with passing the HMAC key to the DS component
- `ESP_ERR_HW_CRYPTODS_INVALID_DIGEST` if the message digest didn't match; the signature is invalid.
- `ESP_ERR_HW_CRYPTODS_INVALID_PADDING` if the message padding is incorrect, the signature can be read though since the message digest matches.

`esp_err_t esp_ds_start_sign` (const void \*message, const `esp_ds_data_t` \*data, `hmac_key_id_t` key\_id, `esp_ds_context_t` \*\*esp\_ds\_ctx)

Start the signing process.

This function yields a context object which needs to be passed to `esp_ds_finish_sign()` to finish the signing process. The function calculates a plain RSA signature with help of the DS peripheral. The RSA encryption operation is as follows:  $Z = XY \bmod M$  where, Z is the signature, X is the input message, Y and M are the RSA private key parameters.

---

**备注:** This function locks the HMAC, SHA, AES and RSA components, so the user has to ensure to call `esp_ds_finish_sign()` in a timely manner. The numbers Y, M, Rb which are a part of `esp_ds_data_t`

should be provided in little endian format and should be of length equal to the RSA private key bit length. The message length in bits should also be equal to the RSA private key bit length. No padding is applied to the message automatically, Please ensure the message is appropriately padded before calling the API.

#### 参数

- **message** -- the message to be signed; its length should be  $(data->rsa\_length + 1)*4$  bytes, and those bytes must be in little endian format. It is your responsibility to apply your hash function and padding before calling this function, if required. (e.g. `message = padding(hash(inputMsg))`)
- **data** -- the encrypted signing key data (AES encrypted RSA key + IV)
- **key\_id** -- the HMAC key ID determining the HMAC key of the HMAC which will be used to decrypt the signing key data
- **esp\_ds\_ctx** -- the context object which is needed for finishing the signing process later

#### 返回

- ESP\_OK if successful, the ds operation was started now and has to be finished with `esp_ds_finish_sign()`
- ESP\_ERR\_INVALID\_ARG if one of the parameters is NULL or `data->rsa_length` is too long or 0
- ESP\_ERR\_HW\_CRYPTODS\_HMAC\_FAIL if there was an HMAC failure during retrieval of the decryption key
- ESP\_ERR\_NO\_MEM if there hasn't been enough memory to allocate the context object
- ESP\_ERR\_HW\_CRYPTODS\_INVALID\_KEY if there's a problem with passing the HMAC key to the DS component

bool **esp\_ds\_is\_busy** (void)

Return true if the DS peripheral is busy, otherwise false.

---

**备注:** Only valid if `esp_ds_start_sign()` was called before.

---

*esp\_err\_t* **esp\_ds\_finish\_sign** (void \*signature, *esp\_ds\_context\_t* \*esp\_ds\_ctx)

Finish the signing process.

#### 参数

- **signature** -- the destination of the signature, should be  $(data->rsa\_length + 1)*4$  bytes long, the resultant signature bytes shall be written in little endian format.
- **esp\_ds\_ctx** -- the context object retrieved by `esp_ds_start_sign()`

#### 返回

- ESP\_OK if successful, the ds operation has been finished and the result is written to signature.
- ESP\_ERR\_INVALID\_ARG if one of the parameters is NULL
- ESP\_ERR\_HW\_CRYPTODS\_INVALID\_DIGEST if the message digest didn't match; the signature is invalid. This means that the encrypted RSA key parameters are invalid, indicating that they may have been tampered with or indicating a flash error, etc.
- ESP\_ERR\_HW\_CRYPTODS\_INVALID\_PADDING if the message padding is incorrect, the signature can be read though since the message digest matches (see TRM for more details).

*esp\_err\_t* **esp\_ds\_encrypt\_params** (*esp\_ds\_data\_t* \*data, const void \*iv, const *esp\_ds\_p\_data\_t* \*p\_data, const void \*key)

Encrypt the private key parameters.

The encryption is a prerequisite step before any signature operation can be done. It is not strictly necessary to use this encryption function, the encryption could also happen on an external device.

---

**备注:** The numbers Y, M, Rb which are a part of `esp_ds_data_t` should be provided in little endian format and should be of length equal to the RSA private key bit length. The message length in bits should also be equal to

the RSA private key bit length. No padding is applied to the message automatically, Please ensure the message is appropriate padded before calling the API.

### 参数

- **data** -- Output buffer to store encrypted data, suitable for later use generating signatures.
- **iv** -- Pointer to 16 byte IV buffer, will be copied into 'data'. Should be randomly generated bytes each time.
- **p\_data** -- Pointer to input plaintext key data. The expectation is this data will be deleted after this process is done and 'data' is stored.
- **key** -- Pointer to 32 bytes of key data. Type determined by key\_type parameter. The expectation is the corresponding HMAC key will be stored to efuse and then permanently erased.

### 返回

- ESP\_OK if successful, the ds operation has been finished and the result is written to signature.
- ESP\_ERR\_INVALID\_ARG if one of the parameters is NULL or p\_data->rsa\_length is too long

## Structures

struct **esp\_digital\_signature\_data**

Encrypted private key data. Recommended to store in flash in this format.

---

**备注:** This struct has to match to one from the ROM code! This documentation is mostly taken from there.

---

## Public Members

*esp\_digital\_signature\_length\_t* **rsa\_length**

RSA LENGTH register parameters (number of words in RSA key & operands, minus one).

This value must match the length field encrypted and stored in 'c', or invalid results will be returned. (The DS peripheral will always use the value in 'c', not this value, so an attacker can't alter the DS peripheral results this way, it will just truncate or extend the message and the resulting signature in software.)

---

**备注:** In IDF, the enum type length is the same as of type unsigned, so they can be used interchangeably. See the ROM code for the original declaration of struct *ets\_ds\_data\_t*.

---

uint32\_t **iv**[ESP\_DS\_IV\_BIT\_LEN / 32]

IV value used to encrypt 'c'

uint8\_t **c**[ESP\_DS\_C\_LEN]

Encrypted Digital Signature parameters. Result of AES-CBC encryption of plaintext values. Includes an encrypted message digest.

struct **esp\_ds\_p\_data\_t**

Plaintext parameters used by Digital Signature.

This is only used for encrypting the RSA parameters by calling `esp_ds_encrypt_params()`. Afterwards, the result can be stored in flash or in other persistent memory. The encryption is a prerequisite step before any signature operation can be done.

---

备注: Y, M, Rb, & M\_Prime must all be in little endian format.

---

### Public Members

uint32\_t **Y**[ESP\_DS\_SIGNATURE\_MAX\_BIT\_LEN / 32]

RSA exponent.

uint32\_t **M**[ESP\_DS\_SIGNATURE\_MAX\_BIT\_LEN / 32]

RSA modulus.

uint32\_t **Rb**[ESP\_DS\_SIGNATURE\_MAX\_BIT\_LEN / 32]

RSA r inverse operand.

uint32\_t **M\_prime**

RSA M prime operand.

uint32\_t **length**

RSA length in words (32 bit)

### Macros

**ESP\_DS\_IV\_BIT\_LEN**

**ESP\_DS\_IV\_LEN**

**ESP\_DS\_SIGNATURE\_MAX\_BIT\_LEN**

**ESP\_DS\_SIGNATURE\_MD\_BIT\_LEN**

**ESP\_DS\_SIGNATURE\_M\_PRIME\_BIT\_LEN**

**ESP\_DS\_SIGNATURE\_L\_BIT\_LEN**

**ESP\_DS\_SIGNATURE\_PADDING\_BIT\_LEN**

**ESP\_DS\_C\_LEN**

### Type Definitions

typedef struct esp\_ds\_context **esp\_ds\_context\_t**

typedef struct *esp\_digital\_signature\_data* **esp\_ds\_data\_t**

Encrypted private key data. Recommended to store in flash in this format.

---

备注: This struct has to match to one from the ROM code! This documentation is mostly taken from there.

---

## Enumerations

enum `esp_digital_signature_length_t`

Values:

enumerator `ESP_DS_RSA_1024`

enumerator `ESP_DS_RSA_2048`

enumerator `ESP_DS_RSA_3072`

enumerator `ESP_DS_RSA_4096`

### 2.6.13 Inter-Integrated Circuit (I2C)

#### Introduction

I2C is a serial, synchronous, multi-device, half-duplex communication protocol that allows co-existence of multiple masters and slaves on the same bus. I2C uses two bidirectional open-drain lines: serial data line (SDA) and serial clock line (SCL), pulled up by resistors.

ESP32-H2 has 2 I2C controller (also called port), responsible for handling communication on the I2C bus. A single I2C controller can be a master or a slave.

Typically, an I2C slave device has a 7-bit address or 10-bit address. ESP32-H2 supports both I2C Standard-mode (Sm) and Fast-mode (Fm) which can go up to 100KHz and 400KHz respectively.

**警告:** The clock frequency of SCL in master mode should not be larger than 400 KHz

---

**备注:** The frequency of SCL is influenced by both the pull-up resistor and the wire capacitance. Therefore, users are strongly recommended to choose appropriate pull-up resistors to make the frequency accurate. The recommended value for pull-up resistors usually ranges from 1K Ohms to 10K Ohms.

Keep in mind that the higher the frequency, the smaller the pull-up resistor should be (but not less than 1 KOhms). Indeed, large resistors will decline the current, which will increase the clock switching time and reduce the frequency. We usually recommend a range of 2 KOhms to 5 KOhms, but users may also need to make some adjustments depending on their current draw requirements.

---

#### I2C Clock Configuration

- `i2c_clock_source_t::I2C_CLK_SRC_DEFAULT`: Default I2C source clock.
- `i2c_clock_source_t::I2C_CLK_SRC_XTAL`: External crystal for I2C clock source.
- `i2c_clock_source_t::I2C_CLK_RC_FAST`: Internal 20MHz rc oscillator for I2C clock source.

#### I2C File Structure

##### Public headers that need to be included in the I2C application

- `i2c.h`: The header file of legacy I2C APIs (for apps using legacy driver).
- `i2c_master.h`: The header file that provides standard communication mode specific APIs (for apps using new driver with master mode).



图 4: I2C file structure

- `i2c_slave.h`: The header file that provides standard communication mode specific APIs (for apps using new driver with slave mode).

**备注:** The legacy driver can't coexist with the new driver. Include `i2c.h` to use the legacy driver or the other two headers to use the new driver. Please keep in mind that the legacy driver is now deprecated and will be removed in future.

#### Public headers that have been included in the headers above

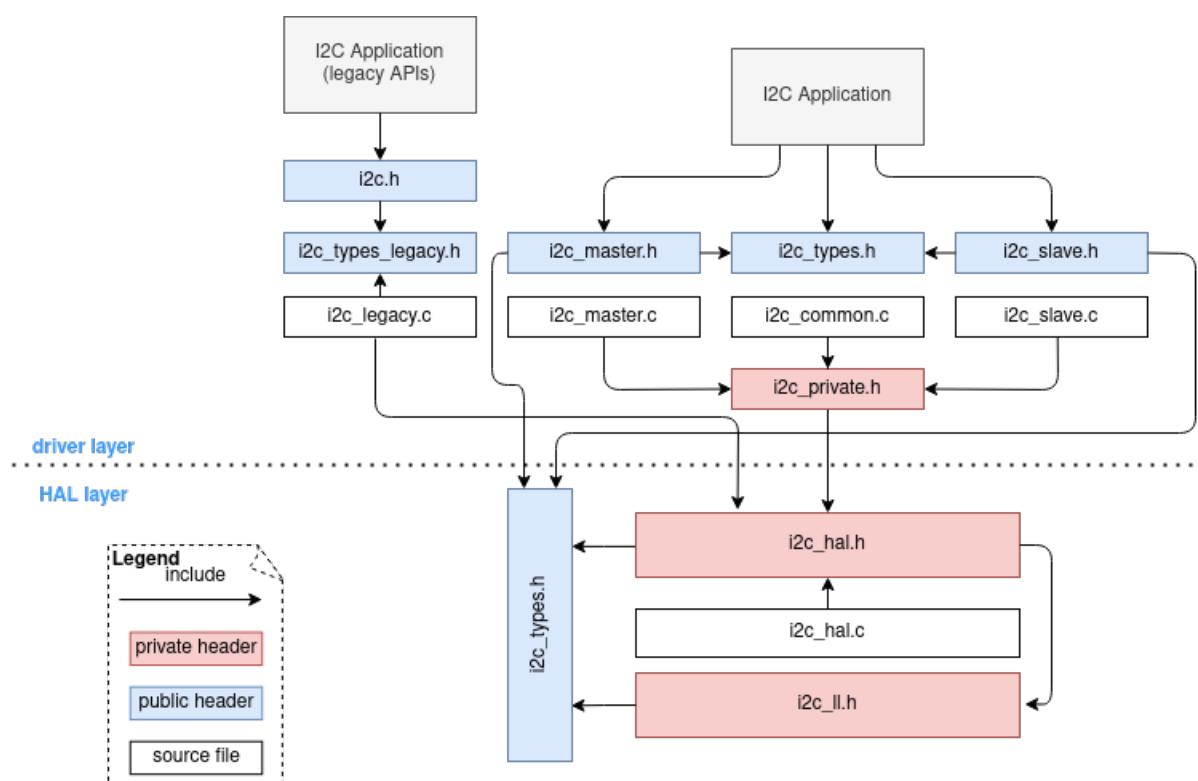
- `i2c_types_legacy.h`: The legacy public types that only used in the legacy driver.
- `i2c_types.h`: The header file that provides public types.

#### Functional Overview

The I2C driver offers following services:

- **Resource Allocation** - covers how to allocate I2C bus with properly set of configurations. It also covers how to recycle the resources when they finished working.
- **I2C Master Controller** - covers behavior of I2C master controller. Introduce data transmit, data receive, and data transmit and receive.
- **I2C Slave Controller** - covers behavior of I2C slave controller. Involve data transmit and data receive.
- **Power Management** - describes how different source clock will affect power consumption.
- **IRAM Safe** - describes tips on how to make the I2C interrupt work better along with a disabled cache.
- **Thread Safety** - lists which APIs are guaranteed to be thread safe by the driver.
- **Kconfig Options** - lists the supported Kconfig options that can bring different effects to the driver.

**Resource Allocation** Both I2C master bus and I2C slave bus, when supported, are represented by `i2c_bus_handle_t` in the driver. The available ports are managed in a resource pool that allocates a free port on request.

**Install I2C master bus and device** The I2C master is designed based on bus-device model. So `i2c_master_bus_config_t` and `i2c_device_config_t` are required separately to allocate the I2C master bus instance and I2C device instance.



图 5: I2C master bus-device module

I2C master bus requires the configuration that specified by `i2c_master_bus_config_t`:

- `i2c_master_bus_config_t::i2c_port` sets the I2C port used by the controller.
- `i2c_master_bus_config_t::sda_io_num` sets the GPIO number for the serial data bus (SDA).
- `i2c_master_bus_config_t::scl_io_num` sets the GPIO number for the serial clock bus (SCL).
- `i2c_master_bus_config_t::clk_source` selects the source clock for I2C bus. The available clocks are listed in `i2c_clock_source_t`. For the effect on power consumption of different clock source, please refer to [Power Management](#) section.
- `i2c_master_bus_config_t::glitch_ignore_cnt` sets the glitch period of master bus, if the glitch period on the line is less than this value, it can be filtered out, typically value is 7.
- `i2c_master_bus_config_t::intr_priority` Set the priority of the interrupt. If set to 0, then the driver will use a interrupt with low or medium priority (priority level may be one of 1,2 or 3), otherwise use the priority indicated by `i2c_master_bus_config_t::intr_priority`. Please use the number form (1,2,3), not the bitmask form ((1<<1),(1<<2),(1<<3)).
- `i2c_master_bus_config_t::trans_queue_depth` Depth of internal transfer queue. Only valid in asynchronous transaction.
- `i2c_master_bus_config_t::enable_internal_pullup` Enable internal pullups. Note: This is not strong enough to pullup buses under high-speed frequency. A suitable external pullup is recommended.

If the configurations in `i2c_master_bus_config_t` is specified, users can call `i2c_new_master_bus()` to allocate and initialize an I2C master bus. This function will return an I2C bus handle if it runs correctly. Specifically, when there are no more I2C port available, this function will return `ESP_ERR_NOT_FOUND` error.

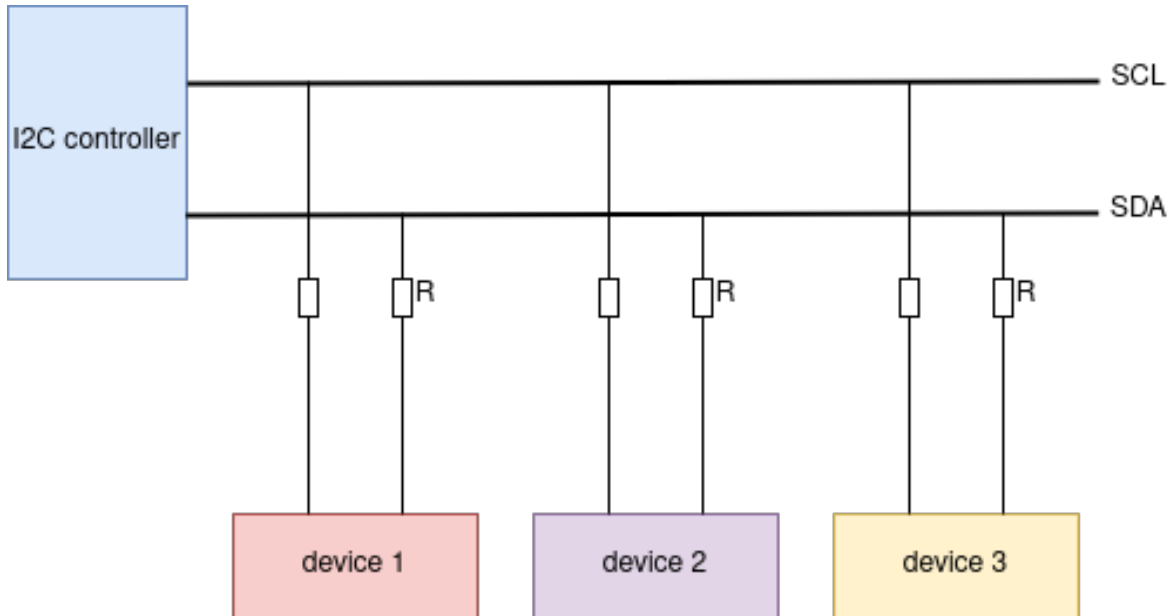
I2C master device requires the configuration that specified by `i2c_device_config_t`:

- `i2c_device_config_t::dev_addr_length` configure the address bit length of the slave device. User can choose from enumerator `I2C_ADDR_BIT_LEN_7` or `I2C_ADDR_BIT_LEN_10` (if supported).
- `i2c_device_config_t::device_address` I2C device raw address. Please parse the device address to this member directly. For example, the device address is 0x28, then parse 0x28 to `i2c_device_config_t::device_address`, don't carry a write/read bit.
- `i2c_device_config_t::scl_speed_hz` set the scl line frequency of this device.
- `i2c_device_config_t::scl_wait_us`. SCL await time (in us). Usually this value should not be very small because slave stretch will happen in pretty long time. (It's possible even stretch for 12ms). Set 0 means use default reg value.

Once the `i2c_device_config_t` structure is populated with mandatory parameters, users can call `i2c_master_bus_add_device()` to allocate an I2C device instance and mounted to the master bus then. This function will return an I2C device handle if it runs correctly. Specifically, when the I2C bus is not initialized properly, calling this function will result in a `ESP_ERR_INVALID_ARG` error.

```
#include "driver/i2c_master.h"

i2c_master_bus_config_t i2c_mst_config = {
    .clk_source = I2C_CLK_SRC_DEFAULT,
    .i2c_port = TEST_I2C_PORT,
    .scl_io_num = I2C_MASTER_SCL_IO,
    .sda_io_num = I2C_MASTER_SDA_IO,
    .glitch_ignore_cnt = 7,
    .flags.enable_internal_pullup = true,
};

i2c_master_bus_handle_t bus_handle;
ESP_ERROR_CHECK(i2c_new_master_bus(&i2c_mst_config, &bus_handle));

i2c_device_config_t dev_cfg = {
    .dev_addr_length = I2C_ADDR_BIT_LEN_7,
    .device_address = 0x58,
    .scl_speed_hz = 100000,
};

i2c_master_dev_handle_t dev_handle;
ESP_ERROR_CHECK(i2c_master_bus_add_device(bus_handle, &dev_cfg, &dev_handle));
```

**Uninstall I2C master bus and device** If a previously installed I2C bus or device is no longer needed, it's recommended to recycle the resource by calling `i2c_master_bus_rm_device()` or `i2c_del_master_bus()`, so that to release the underlying hardware.

**Install I2C slave device** I2C slave requires the configuration that specified by `i2c_slave_config_t`:

- `i2c_slave_config_t::i2c_port` sets the I2C port used by the controller.
- `i2c_slave_config_t::sda_io_num` sets the GPIO number for serial data bus (SDA).
- `i2c_slave_config_t::scl_io_num` sets the GPIO number for serial clock bus (SCL).
- `i2c_slave_config_t::clk_source` selects the source clock for I2C bus. The available clocks are listed in `i2c_clock_source_t`. For the effect on power consumption of different clock source, please refer to [Power Management](#) section.
- `i2c_slave_config_t::send_buf_depth` sets the sending buffer length.
- `i2c_slave_config_t::slave_addr` sets the slave address
- `i2c_master_bus_config_t::intr_priority` Set the priority of the interrupt. If set to 0, then the driver will use a interrupt with low or medium priority (priority level may be one of 1,2 or 3), otherwise use the priority indicated by `i2c_master_bus_config_t::intr_priority`. Please use the number form (1,2,3), not the bitmask form ((1<1),(1<2),(1<3)). Please pay attention that once the interrupt priority is set, it cannot be changed until `i2c_del_master_bus()` is called.
- `i2c_slave_config_t::addr_bit_len` sets true if you need the slave to have a 10-bit address.
- `i2c_slave_config_t::stretch_en` Set true if you want the slave controller stretch works, please refer to [TRM] to learn how I2C stretch works.
- `i2c_slave_config_t::broadcast_en` Set true to enable the slave broadcast. When the slave receives the general call address 0x00 from the master and the R/W bit followed is 0, it responds to the master regardless of its own address.
- `i2c_slave_config_t::access_ram_en` Set true to enable the non-fifo mode. Thus the I2C data fifo can be used as RAM, and double addressing will be synchronised opened.
- `i2c_slave_config_t::slave_unmatch_en` Set true to enable the slave unmatch interrupt. If master send command address cannot match the slave address, and unmatch interrupt will be triggered.



Once the `i2c_slave_config_t` structure is populated with mandatory parameters, users can call `i2c_new_slave_device()` to allocate and initialize an I2C master bus. This function will return an I2C bus handle if it runs correctly. Specifically, when there are no more I2C port available, this function will return `ESP_ERR_NOT_FOUND` error.

```
i2c_slave_config_t i2c_slv_config = {
    .addr_bit_len = I2C_ADDR_BIT_LEN_7,
    .clk_source = I2C_CLK_SRC_DEFAULT,
    .i2c_port = TEST_I2C_PORT,
    .send_buf_depth = 256,
    .scl_io_num = I2C_SLAVE_SCL_IO,
    .sda_io_num = I2C_SLAVE_SDA_IO,
    .slave_addr = 0x58,
};

i2c_slave_dev_handle_t slave_handle;
ESP_ERROR_CHECK(i2c_new_slave_device(&i2c_slv_config, &slave_handle));
```

**Uninstall I2C slave device** If a previously installed I2C bus is no longer needed, it's recommended to recycle the resource by calling `i2c_del_slave_device()`, so that to release the underlying hardware.

**I2C Master Controller** After installing the i2c master driver by `i2c_new_master_bus()`, ESP32-H2 is ready to communicate with other I2C devices. I2C APIs allow the standard transactions. Like the wave as follows:

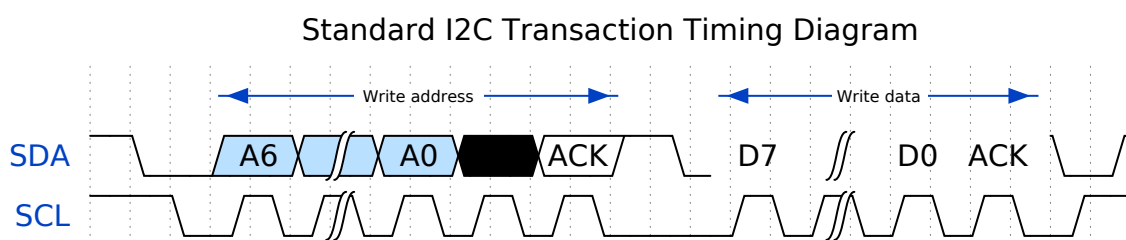

**I2C Master Write** After installing I2C master bus successfully, you can simply call `i2c_master_transmit()` to write data to the slave device. The principle of this function can be explained by following chart.

In order to organize the process, the driver uses a command link, that should be populated with a sequence of commands and then passed to I2C controller for execution.



图 6: I2C master write to slave

Simple example for writing data to slave:

```
#define DATA_LENGTH 100
i2c_master_bus_config_t i2c_mst_config = {
    .clk_source = I2C_CLK_SRC_DEFAULT,
    .i2c_port = I2C_PORT_NUM_0,
    .scl_io_num = I2C_MASTER_SCL_IO,
    .sda_io_num = I2C_MASTER_SDA_IO,
    .glitch_ignore_cnt = 7,
};
```

(下页继续)

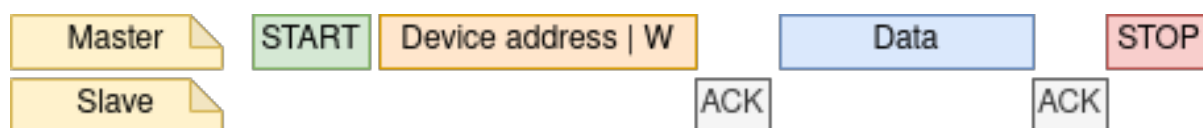
```

i2c_master_bus_handle_t bus_handle;

ESP_ERROR_CHECK(i2c_new_master_bus(&i2c_mst_config, &bus_handle));

i2c_device_config_t dev_cfg = {
    .dev_addr_length = I2C_ADDR_BIT_LEN_7,
    .device_address = 0x58,
    .scl_speed_hz = 100000,
};

i2c_master_dev_handle_t dev_handle;
ESP_ERROR_CHECK(i2c_master_bus_add_device(bus_handle, &dev_cfg, &dev_handle));

ESP_ERROR_CHECK(i2c_master_transmit(dev_handle, data_wr, DATA_LENGTH, -1));

```

**I2C Master Read** After installing I2C master bus successfully, you can simply call `i2c_master_receive()` to read data from the slave device. The principle of this function can be explained by following chart.



图 7: I2C master read from slave

Simple example for reading data from slave:

```

#define DATA_LENGTH 100
i2c_master_bus_config_t i2c_mst_config = {
    .clk_source = I2C_CLK_SRC_DEFAULT,
    .i2c_port = I2C_PORT_NUM_0,
    .scl_io_num = I2C_MASTER_SCL_IO,
    .sda_io_num = I2C_MASTER_SDA_IO,
    .glitch_ignore_cnt = 7,
};

i2c_master_bus_handle_t bus_handle;

ESP_ERROR_CHECK(i2c_new_master_bus(&i2c_mst_config, &bus_handle));

i2c_device_config_t dev_cfg = {
    .dev_addr_length = I2C_ADDR_BIT_LEN_7,
    .device_address = 0x58,
    .scl_speed_hz = 100000,
};

i2c_master_dev_handle_t dev_handle;
ESP_ERROR_CHECK(i2c_master_bus_add_device(bus_handle, &dev_cfg, &dev_handle));

i2c_master_receive(dev_handle, data_rd, DATA_LENGTH, -1);

```

**I2C Master Write and Read** Some I2C device needs write configurations before reading data from it, therefore, an interface called `i2c_master_transmit_receive()` can help. The principle of this function can be explained by following chart.



图 8: I2C master write to slave and read from slave

Simple example for writing and reading from slave:

```
i2c_device_config_t dev_cfg = {
    .dev_addr_length = I2C_ADDR_BIT_LEN_7,
    .device_address = 0x58,
    .scl_speed_hz = 100000,
};

i2c_master_dev_handle_t dev_handle;
ESP_ERROR_CHECK(i2c_master_bus_add_device(I2C_PORT_NUM_0, &dev_cfg, &dev_handle));
uint8_t buf[20] = {0x20};
uint8_t buffer[2];
ESP_ERROR_CHECK(i2c_master_transmit_receive(dev_handle, buf, sizeof(buf), buffer,
↳2, -1));
```

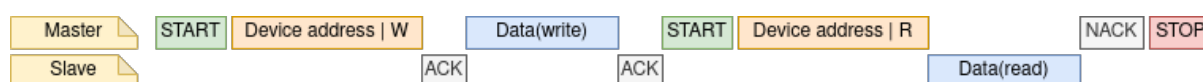
**I2C Master Probe** I2C driver can use `i2c_master_probe()` to detect whether the specific device has been connected on I2C bus. If this function return `ESP_OK`, that means the device has been detected.

**重要:** Pull-ups must be connected to the SCL and SDA pins when this function is called. If you get `ESP_ERR_TIMEOUT` while `xfer_timeout_ms` was parsed correctly, you should check the pull-up resistors. If you do not have proper resistors nearby, setting `flags.enable_internal_pullup` as true is also acceptable.



图 9: I2C master probe

Simple example for probing an I2C device:

```
i2c_master_bus_config_t i2c_mst_config_1 = {
    .clk_source = I2C_CLK_SRC_DEFAULT,
    .i2c_port = TEST_I2C_PORT,
    .scl_io_num = I2C_MASTER_SCL_IO,
    .sda_io_num = I2C_MASTER_SDA_IO,
    .glitch_ignore_cnt = 7,
    .flags.enable_internal_pullup = true,
};
i2c_master_bus_handle_t bus_handle;

ESP_ERROR_CHECK(i2c_new_master_bus(&i2c_mst_config_1, &bus_handle));
ESP_ERROR_CHECK(i2c_master_probe(bus_handle, 0x22, -1));
ESP_ERROR_CHECK(i2c_del_master_bus(bus_handle));
```

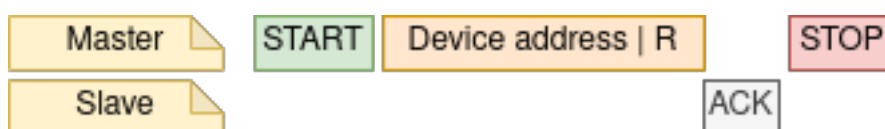
**I2C Slave Controller** After installing the i2c slave driver by `i2c_new_slave_device()`, ESP32-H2 is ready to communicate with other I2C master as a slave.

**I2C Slave Write** The send buffer of the I2C slave is used as a FIFO to store the data to be sent. The data will queue up until the master requests them. You can call `i2c_slave_transmit()` to transfer data.

Simple example for writing data to FIFO:

```
uint8_t *data_wr = (uint8_t *) malloc(DATA_LENGTH);

i2c_slave_config_t i2c_slv_config = {
```

(下页继续)

```

        .addr_bit_len = I2C_ADDR_BIT_LEN_7,    // 7-bit address
        .clk_source = I2C_CLK_SRC_DEFAULT,    // set the clock source
        .i2c_port = 0,                        // set I2C port number
        .send_buf_depth = 256,                // set tx buffer length
        .scl_io_num = 2,                      // SCL gpio number
        .sda_io_num = 1,                      // SDA gpio number
        .slave_addr = 0x58,                   // slave address
};

i2c_bus_handle_t i2c_bus_handle;
ESP_ERROR_CHECK(i2c_new_slave_device(&i2c_slv_config, &i2c_bus_handle));
for (int i = 0; i < DATA_LENGTH; i++) {
    data_wr[i] = i;
}

ESP_ERROR_CHECK(i2c_slave_transmit(i2c_bus_handle, data_wr, DATA_LENGTH, 10000));

```

**I2C Slave Read** Whenever the master writes data to the slave, the slave will automatically store data in the receive buffer. This allows the slave application to call the function `i2c_slave_receive()` as its own discretion. As `i2c_slave_receive()` is designed as a non-blocking interface. So the user needs to register callback `i2c_slave_register_event_callbacks()` to know when the receive has finished.

```

static IRAM_ATTR bool i2c_slave_rx_done_callback(i2c_slave_dev_handle_t channel,
↪const i2c_slave_rx_done_event_data_t *edata, void *user_data)
{
    BaseType_t high_task_wakeup = pdFALSE;
    QueueHandle_t receive_queue = (QueueHandle_t)user_data;
    xQueueSendFromISR(receive_queue, edata, &high_task_wakeup);
    return high_task_wakeup == pdTRUE;
}

uint8_t *data_rd = (uint8_t *) malloc(DATA_LENGTH);
uint32_t size_rd = 0;

i2c_slave_config_t i2c_slv_config = {
    .addr_bit_len = I2C_ADDR_BIT_LEN_7,
    .clk_source = I2C_CLK_SRC_DEFAULT,
    .i2c_port = TEST_I2C_PORT,
    .send_buf_depth = 256,
    .scl_io_num = I2C_SLAVE_SCL_IO,
    .sda_io_num = I2C_SLAVE_SDA_IO,
    .slave_addr = 0x58,
};

i2c_slave_dev_handle_t slave_handle;
ESP_ERROR_CHECK(i2c_new_slave_device(&i2c_slv_config, &slave_handle));

s_receive_queue = xQueueCreate(1, sizeof(i2c_slave_rx_done_event_data_t));
i2c_slave_event_callbacks_t cbs = {
    .on_recv_done = i2c_slave_rx_done_callback,
};
ESP_ERROR_CHECK(i2c_slave_register_event_callbacks(slave_handle, &cbs, s_receive_
↪queue));

i2c_slave_rx_done_event_data_t rx_data;
ESP_ERROR_CHECK(i2c_slave_receive(slave_handle, data_rd, DATA_LENGTH));
xQueueReceive(s_receive_queue, &rx_data, pdMS_TO_TICKS(10000));
// Receive done.

```

**Put Data In I2C Slave RAM** I2C slave fifo mentioned above can be used as RAM, which means user can access the RAM directly via address fields. For example, writing data to the 3rd ram block with following graph. Before using this, please note that `i2c_slave_config_t::access_ram_en` needs to be set to true.



图 10: Put data in I2C slave RAM

```
uint8_t data_rd[DATA_LENGTH_RAM] = {0};

i2c_slave_config_t i2c_slv_config = {
    .addr_bit_len = I2C_ADDR_BIT_LEN_7,
    .clk_source = I2C_CLK_SRC_DEFAULT,
    .i2c_port = TEST_I2C_PORT,
    .send_buf_depth = 256,
    .scl_io_num = I2C_SLAVE_SCL_IO,
    .sda_io_num = I2C_SLAVE_SDA_IO,
    .slave_addr = 0x58,
    .flags.access_ram_en = true,
};

// Master write to slave.

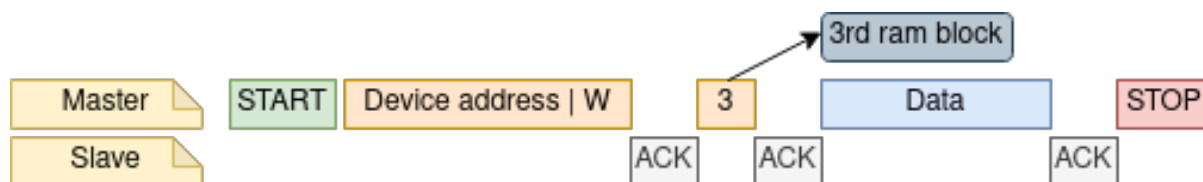
i2c_slave_dev_handle_t slave_handle;
ESP_ERROR_CHECK(i2c_new_slave_device(&i2c_slv_config, &slave_handle));
ESP_ERROR_CHECK(i2c_slave_read_ram(slave_handle, 0x5, data_rd, DATA_LENGTH_RAM));
ESP_ERROR_CHECK(i2c_del_slave_device(slave_handle));
```

**Get Data From I2C Slave RAM** Data can be stored in the RAM with a specific offset by the slave controller, and the master can read this data directly via the RAM address. For example, if the data is stored in 3rd ram block, master can read this data by following graph. Before using this, please note that `i2c_slave_config_t::access_ram_en` needs to be set to true.



图 11: Get data from I2C slave RAM

```
uint8_t data_wr[DATA_LENGTH_RAM] = {0};

i2c_slave_config_t i2c_slv_config = {
    .addr_bit_len = I2C_ADDR_BIT_LEN_7,
    .clk_source = I2C_CLK_SRC_DEFAULT,
    .i2c_port = TEST_I2C_PORT,
    .send_buf_depth = 256,
    .scl_io_num = I2C_SLAVE_SCL_IO,
    .sda_io_num = I2C_SLAVE_SDA_IO,
    .slave_addr = 0x58,
    .flags.access_ram_en = true,
};

i2c_slave_dev_handle_t slave_handle;
```

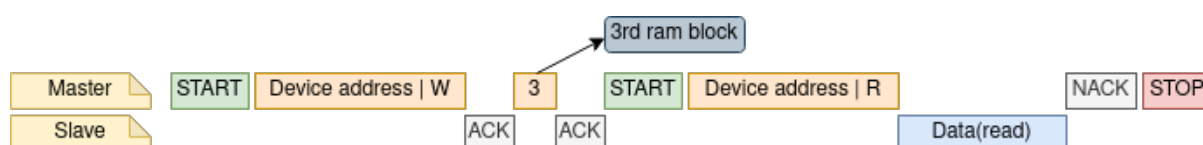
(下页继续)

```
ESP_ERROR_CHECK(i2c_new_slave_device(&i2c_slv_config, &slave_handle));
ESP_ERROR_CHECK(i2c_slave_write_ram(slave_handle, 0x2, data_wr, DATA_LENGTH_RAM));
ESP_ERROR_CHECK(i2c_del_slave_device(slave_handle));
```

## Register Event Callbacks

**I2C master callbacks** When an I2C master bus triggers an interrupt, a specific event will be generated and notify the CPU. If you have some functions that need to be called when those events occurred, you can hook your functions to the ISR (Interrupt Service Routine) by calling `i2c_master_register_event_callbacks()`. Since the registered callback functions are called in the interrupt context, user should ensure the callback function doesn't attempt to block (e.g. by making sure that only FreeRTOS APIs with `ISR` suffix are called from within the function). The callback functions are required to return a boolean value, to tell the ISR whether a high priority task is woke up by it.

I2C master event callbacks are listed in the `i2c_master_event_callbacks_t`.

Although I2C is a synchronous communication protocol, we also support asynchronous behavior by registering above callback. In this way, I2C APIs will be non-blocking interface. But note that on the same bus, only one device can adopt asynchronous operation.

---

**重要:** I2C master asynchronous transaction is still an experimental feature. (The issue is when asynchronous transaction is very large, it will cause memory problem.)

---

- `i2c_master_event_callbacks_t::on_recv_done` sets a callback function for master "transaction-done" event. The function prototype is declared in `i2c_master_callback_t`.

**I2C slave callbacks** When an I2C slave bus triggers an interrupt, a specific event will be generated and notify the CPU. If you have some function that needs to be called when those events occurred, you can hook your function to the ISR (Interrupt Service Routine) by calling `i2c_slave_register_event_callbacks()`. Since the registered callback functions are called in the interrupt context, user should ensure the callback function doesn't attempt to block (e.g. by making sure that only FreeRTOS APIs with `ISR` suffix are called from within the function). The callback function has a boolean return value, to tell the caller whether a high priority task is woke up by it.

I2C slave event callbacks are listed in the `i2c_slave_event_callbacks_t`.

- `i2c_slave_event_callbacks_t::on_recv_done` sets a callback function for "receive-done" event. The function prototype is declared in `i2c_slave_received_callback_t`.
- `i2c_slave_event_callbacks_t::on_stretch_occur` sets a callback function for "stretch" cause. The function prototype is declared in `i2c_slave_stretch_callback_t`.

**Power Management** If the controller clock source is selected to `I2C_CLK_SRC_XTAL`, then the driver won't install power management lock for it, which is more suitable for a low power application as long as the source clock can still provide sufficient resolution.

**IRAM Safe** By default, the I2C interrupt will be deferred when the Cache is disabled for reasons like writing/erasing Flash. Thus the event callback functions will not get executed in time, which is not expected in a real-time application.

There's a Kconfig option `CONFIG_I2C_ISR_IRAM_SAFE` that will:

1. Enable the interrupt being serviced even when cache is disabled
2. Place all functions that used by the ISR into IRAM
3. Place driver object into DRAM (in case it's mapped to PSRAM by accident)

This will allow the interrupt to run while the cache is disabled but will come at the cost of increased IRAM consumption.

**Thread Safety** The factory function `i2c_new_master_bus()` and `i2c_new_slave_device()` are guaranteed to be thread safe by the driver, which means, user can call them from different RTOS tasks without protection by extra locks. Other public I2C APIs are not thread safe. which means the user should avoid calling them from multiple tasks, if user strongly needs to call them in multiple tasks, please add extra lock.

### Kconfig Options

- `CONFIG_I2C_ISR_IRAM_SAFE` controls whether the default ISR handler can work when cache is disabled, see also `IRAM Safe` for more information.
- `CONFIG_I2C_ENABLE_DEBUG_LOG` is used to enable the debug log at the cost of increased firmware binary size.

### API Reference

#### Header File

- `components/esp_driver_i2c/include/driver/i2c_master.h`
- This header file can be included with:

```
#include "driver/i2c_master.h"
```

- This header file is a part of the API provided by the `esp_driver_i2c` component. To declare that your component depends on `esp_driver_i2c`, add the following to your CMakeLists.txt:

```
REQUIRES esp_driver_i2c
```

or

```
PRIV_REQUIRES esp_driver_i2c
```

#### Functions

`esp_err_t i2c_new_master_bus` (const `i2c_master_bus_config_t` \*bus\_config, `i2c_master_bus_handle_t` \*ret\_bus\_handle)

Allocate an I2C master bus.

##### 参数

- **bus\_config** -- [in] I2C master bus configuration.
- **ret\_bus\_handle** -- [out] I2C bus handle

##### 返回

- `ESP_OK`: I2C master bus initialized successfully.
- `ESP_ERR_INVALID_ARG`: I2C bus initialization failed because of invalid argument.
- `ESP_ERR_NO_MEM`: Create I2C bus failed because of out of memory.
- `ESP_ERR_NOT_FOUND`: No more free bus.

`esp_err_t i2c_master_bus_add_device` (`i2c_master_bus_handle_t` bus\_handle, const `i2c_device_config_t` \*dev\_config, `i2c_master_dev_handle_t` \*ret\_handle)

Add I2C master BUS device.

##### 参数

- **bus\_handle** -- [in] I2C bus handle.
- **dev\_config** -- [in] device config.
- **ret\_handle** -- [out] device handle.

##### 返回

- `ESP_OK`: Create I2C master device successfully.
- `ESP_ERR_INVALID_ARG`: I2C bus initialization failed because of invalid argument.
- `ESP_ERR_NO_MEM`: Create I2C bus failed because of out of memory.

*esp\_err\_t* **i2c\_del\_master\_bus** (*i2c\_master\_bus\_handle\_t* bus\_handle)

Deinitialize the I2C master bus and delete the handle.

**参数** **bus\_handle** -- [in] I2C bus handle.

**返回**

- ESP\_OK: Delete I2C bus success, otherwise, failed.
- Otherwise: Some module delete failed.

*esp\_err\_t* **i2c\_master\_bus\_rm\_device** (*i2c\_master\_dev\_handle\_t* handle)

I2C master bus delete device.

**参数** **handle** -- i2c device handle

**返回**

- ESP\_OK: If device is successfully deleted.

*esp\_err\_t* **i2c\_master\_transmit** (*i2c\_master\_dev\_handle\_t* i2c\_dev, const uint8\_t \*write\_buffer, size\_t write\_size, int xfer\_timeout\_ms)

Perform a write transaction on the I2C bus. The transaction will be undergoing until it finishes or it reaches the timeout provided.

---

**备注:** If a callback was registered with `i2c_master_register_event_callbacks`, the transaction will be asynchronous, and thus, this function will return directly, without blocking. You will get finish information from callback. Besides, data buffer should always be completely prepared when callback is registered, otherwise, the data will get corrupt.

---

**参数**

- **i2c\_dev** -- [in] I2C master device handle that created by `i2c_master_bus_add_device`.
- **write\_buffer** -- [in] Data bytes to send on the I2C bus.
- **write\_size** -- [in] Size, in bytes, of the write buffer.
- **xfer\_timeout\_ms** -- [in] Wait timeout, in ms. Note: -1 means wait forever.

**返回**

- ESP\_OK: I2C master transmit success
- ESP\_ERR\_INVALID\_ARG: I2C master transmit parameter invalid.
- ESP\_ERR\_TIMEOUT: Operation timeout (larger than `xfer_timeout_ms`) because the bus is busy or hardware crash.

*esp\_err\_t* **i2c\_master\_transmit\_receive** (*i2c\_master\_dev\_handle\_t* i2c\_dev, const uint8\_t \*write\_buffer, size\_t write\_size, uint8\_t \*read\_buffer, size\_t read\_size, int xfer\_timeout\_ms)

Perform a write-read transaction on the I2C bus. The transaction will be undergoing until it finishes or it reaches the timeout provided.

---

**备注:** If a callback was registered with `i2c_master_register_event_callbacks`, the transaction will be asynchronous, and thus, this function will return directly, without blocking. You will get finish information from callback. Besides, data buffer should always be completely prepared when callback is registered, otherwise, the data will get corrupt.

---

**参数**

- **i2c\_dev** -- [in] I2C master device handle that created by `i2c_master_bus_add_device`.
- **write\_buffer** -- [in] Data bytes to send on the I2C bus.
- **write\_size** -- [in] Size, in bytes, of the write buffer.
- **read\_buffer** -- [out] Data bytes received from i2c bus.
- **read\_size** -- [in] Size, in bytes, of the read buffer.
- **xfer\_timeout\_ms** -- [in] Wait timeout, in ms. Note: -1 means wait forever.



**返回**

- **ESP\_OK**: I2C master transmit-receive success
- **ESP\_ERR\_INVALID\_ARG**: I2C master transmit parameter invalid.
- **ESP\_ERR\_TIMEOUT**: Operation timeout(larger than `xfer_timeout_ms`) because the bus is busy or hardware crash.

`esp_err_t i2c_master_receive(i2c_master_dev_handle_t i2c_dev, uint8_t *read_buffer, size_t read_size, int xfer_timeout_ms)`

Perform a read transaction on the I2C bus. The transaction will be undergoing until it finishes or it reaches the timeout provided.

---

**备注:** If a callback was registered with `i2c_master_register_event_callbacks`, the transaction will be asynchronous, and thus, this function will return directly, without blocking. You will get finish information from callback. Besides, data buffer should always be completely prepared when callback is registered, otherwise, the data will get corrupt.

---

**参数**

- **i2c\_dev** -- **[in]** I2C master device handle that created by `i2c_master_bus_add_device`.
- **read\_buffer** -- **[out]** Data bytes received from i2c bus.
- **read\_size** -- **[in]** Size, in bytes, of the read buffer.
- **xfer\_timeout\_ms** -- **[in]** Wait timeout, in ms. Note: -1 means wait forever.

**返回**

- **ESP\_OK**: I2C master receive success
- **ESP\_ERR\_INVALID\_ARG**: I2C master receive parameter invalid.
- **ESP\_ERR\_TIMEOUT**: Operation timeout(larger than `xfer_timeout_ms`) because the bus is busy or hardware crash.

`esp_err_t i2c_master_probe(i2c_master_bus_handle_t bus_handle, uint16_t address, int xfer_timeout_ms)`

Probe I2C address, if address is correct and ACK is received, this function will return **ESP\_OK**.

**Attention** Pull-ups must be connected to the SCL and SDA pins when this function is called. If you get `ESP_ERR_TIMEOUT` while `xfer_timeout_ms` was parsed correctly, you should check the pull-up resistors. If you do not have proper resistors nearby. `flags.enable_internal_pullup` is also acceptable.

---

**备注:** The principle of this function is to sent device address with a write command. If the device on your I2C bus, there would be an ACK signal and function returns **ESP\_OK**. If the device is not on your I2C bus, there would be a NACK signal and function returns **ESP\_ERR\_NOT\_FOUND**. **ESP\_ERR\_TIMEOUT** is not an expected failure, which indicated that the i2c probe not works properly, usually caused by pull-up resistors not be connected properly. Suggestion check data on SDA/SCL line to see whether there is ACK/NACK signal is on line when i2c probe function fails.

---



---

**备注:** There are lots of I2C devices all over the world, we assume that not all I2C device support the behavior like `device_address+nack/ack`. So, if the on line data is strange and no ack/nack got respond. Please check the device datasheet.

---

**参数**

- **bus\_handle** -- **[in]** I2C master device handle that created by `i2c_master_bus_add_device`.
- **address** -- **[in]** I2C device address that you want to probe.

- **xfer\_timeout\_ms** -- [in] Wait timeout, in ms. Note: -1 means wait forever (Not recommended in this function).

**返回**

- ESP\_OK: I2C device probe successfully
- ESP\_ERR\_NOT\_FOUND: I2C probe failed, doesn't find the device with specific address you gave.
- ESP\_ERR\_TIMEOUT: Operation timeout (larger than xfer\_timeout\_ms) because the bus is busy or hardware crash.

*esp\_err\_t* **i2c\_master\_register\_event\_callbacks** (*i2c\_master\_dev\_handle\_t* i2c\_dev, const *i2c\_master\_event\_callbacks\_t* \*cbs, void \*user\_data)

Register I2C transaction callbacks for a master device.

---

**备注:** User can deregister a previously registered callback by calling this function and setting the callback member in the `cbs` structure to NULL.

---



---

**备注:** When CONFIG\_I2C\_ISR\_IRAM\_SAFE is enabled, the callback itself and functions called by it should be placed in IRAM. The variables used in the function should be in the SRAM as well. The `user_data` should also reside in SRAM.

---



---

**备注:** If the callback is used for helping asynchronous transaction. On the same bus, only one device can be used for performing asynchronous operation.

---

**参数**

- **i2c\_dev** -- [in] I2C master device handle that created by `i2c_master_bus_add_device`.
- **cbs** -- [in] Group of callback functions
- **user\_data** -- [in] User data, which will be passed to callback functions directly

**返回**

- ESP\_OK: Set I2C transaction callbacks successfully
- ESP\_ERR\_INVALID\_ARG: Set I2C transaction callbacks failed because of invalid argument
- ESP\_FAIL: Set I2C transaction callbacks failed because of other error

*esp\_err\_t* **i2c\_master\_bus\_reset** (*i2c\_master\_bus\_handle\_t* bus\_handle)

Reset the I2C master bus.

**参数** `bus_handle` -- I2C bus handle.

**返回**

- ESP\_OK: Reset succeed.
- ESP\_ERR\_INVALID\_ARG: I2C master bus handle is not initialized.
- Otherwise: Reset failed.

*esp\_err\_t* **i2c\_master\_bus\_wait\_all\_done** (*i2c\_master\_bus\_handle\_t* bus\_handle, int timeout\_ms)

Wait for all pending I2C transactions done.

**参数**

- **bus\_handle** -- [in] I2C bus handle
- **timeout\_ms** -- [in] Wait timeout, in ms. Specially, -1 means to wait forever.

**返回**

- ESP\_OK: Flush transactions successfully
- ESP\_ERR\_INVALID\_ARG: Flush transactions failed because of invalid argument
- ESP\_ERR\_TIMEOUT: Flush transactions failed because of timeout

- `ESP_FAIL`: Flush transactions failed because of other error

## Structures

struct `i2c_master_bus_config_t`

I2C master bus specific configurations.

### Public Members

`i2c_port_num_t i2c_port`

I2C port number, -1 for auto selecting, (not include LP I2C instance)

`gpio_num_t sda_io_num`

GPIO number of I2C SDA signal, pulled-up internally

`gpio_num_t scl_io_num`

GPIO number of I2C SCL signal, pulled-up internally

`i2c_clock_source_t clk_source`

Clock source of I2C master bus

`uint8_t glitch_ignore_cnt`

If the glitch period on the line is less than this value, it can be filtered out, typically value is 7 (unit: I2C module clock cycle)

`int intr_priority`

I2C interrupt priority, if set to 0, driver will select the default priority (1,2,3).

`size_t trans_queue_depth`

Depth of internal transfer queue, increase this value can support more transfers pending in the background, only valid in asynchronous transaction. (Typically `max_device_num * per_transaction`)

`uint32_t enable_internal_pullup`

Enable internal pullups. Note: This is not strong enough to pullup buses under high-speed frequency. Recommend proper external pull-up if possible

struct `i2c_master_bus_config_t::[anonymous] flags`

I2C master config flags

struct `i2c_device_config_t`

I2C device configuration.

### Public Members

`i2c_addr_bit_len_t dev_addr_length`

Select the address length of the slave device.

`uint16_t device_address`

I2C device raw address. (The 7/10 bit address without read/write bit)

uint32\_t **scl\_speed\_hz**

I2C SCL line frequency.

uint32\_t **scl\_wait\_us**

Timeout value. (unit: us). Please note this value should not be so small that it can handle stretch/disturbance properly. If 0 is set, that means use the default reg value

uint32\_t **disable\_ack\_check**

Disable ACK check. If this is set false, that means ack check is enabled, the transaction will be stopped and API returns error when nack is detected.

struct *i2c\_device\_config\_t*::[anonymous] **flags**

I2C device config flags

struct **i2c\_master\_event\_callbacks\_t**

Group of I2C master callbacks, can be used to get status during transaction or doing other small things. But take care potential concurrency issues.

---

**备注:** The callbacks are all running under ISR context

---



---

**备注:** When CONFIG\_I2C\_ISR\_IRAM\_SAFE is enabled, the callback itself and functions called by it should be placed in IRAM. The variables used in the function should be in the SRAM as well.

---

## Public Members

*i2c\_master\_callback\_t* **on\_trans\_done**

I2C master transaction finish callback

## Header File

- `components/esp_driver_i2c/include/driver/i2c_slave.h`
- This header file can be included with:

```
#include "driver/i2c_slave.h"
```

- This header file is a part of the API provided by the `esp_driver_i2c` component. To declare that your component depends on `esp_driver_i2c`, add the following to your `CMakeLists.txt`:

```
REQUIRES esp_driver_i2c
```

or

```
PRIV_REQUIRES esp_driver_i2c
```

## Functions

*esp\_err\_t* **i2c\_new\_slave\_device** (const *i2c\_slave\_config\_t* \*slave\_config, *i2c\_slave\_dev\_handle\_t* \*ret\_handle)

Initialize an I2C slave device.

**参数**

- **slave\_config** -- [in] I2C slave device configurations

- **ret\_handle** -- [out] Return a generic I2C device handle

**返回**

- ESP\_OK: I2C slave device initialized successfully
- ESP\_ERR\_INVALID\_ARG: I2C device initialization failed because of invalid argument.
- ESP\_ERR\_NO\_MEM: Create I2C device failed because of out of memory.

*esp\_err\_t* **i2c\_del\_slave\_device** (*i2c\_slave\_dev\_handle\_t* i2c\_slave)

Deinitialize the I2C slave device.

**参数** **i2c\_slave** -- [in] I2C slave device handle that created by `i2c_new_slave_device`.

**返回**

- ESP\_OK: Delete I2C device successfully.
- ESP\_ERR\_INVALID\_ARG: I2C device initialization failed because of invalid argument.

*esp\_err\_t* **i2c\_slave\_receive** (*i2c\_slave\_dev\_handle\_t* i2c\_slave, uint8\_t \*data, size\_t buffer\_size)

Read bytes from I2C internal buffer. Start a job to receive I2C data.

---

**备注:** This function is non-blocking, it initiates a new receive job and then returns. User should check the received data from the `on_recv_done` callback that registered by `i2c_slave_register_event_callbacks()`.

---

**参数**

- **i2c\_slave** -- [in] I2C slave device handle that created by `i2c_new_slave_device`.
- **data** -- [out] Buffer to store data from I2C fifo. Should be valid until `on_recv_done` is triggered.
- **buffer\_size** -- [in] Buffer size of data that provided by users.

**返回**

- ESP\_OK: I2C slave receive success.
- ESP\_ERR\_INVALID\_ARG: I2C slave receive parameter invalid.
- ESP\_ERR\_NOT\_SUPPORTED: This function should be work in fifo mode, but I2C\_SLAVE\_NONFIFO mode is configured

*esp\_err\_t* **i2c\_slave\_transmit** (*i2c\_slave\_dev\_handle\_t* i2c\_slave, const uint8\_t \*data, int size, int xfer\_timeout\_ms)

Write bytes to internal ringbuffer of the I2C slave data. When the TX fifo empty, the ISR will fill the hardware FIFO with the internal ringbuffer's data.

---

**备注:** If you connect this slave device to some master device, the data transaction direction is from slave device to master device.

---

**参数**

- **i2c\_slave** -- [in] I2C slave device handle that created by `i2c_new_slave_device`.
- **data** -- [in] Buffer to write to slave fifo, can pickup by master. Can be freed after this function returns. Equal or larger than `size`.
- **size** -- [in] In bytes, of `data` buffer.
- **xfer\_timeout\_ms** -- [in] Wait timeout, in ms. Note: -1 means wait forever.

**返回**

- ESP\_OK: I2C slave transmit success.
- ESP\_ERR\_INVALID\_ARG: I2C slave transmit parameter invalid.
- ESP\_ERR\_TIMEOUT: Operation timeout (larger than `xfer_timeout_ms`) because the device is busy or hardware crash.
- ESP\_ERR\_NOT\_SUPPORTED: This function should be work in fifo mode, but I2C\_SLAVE\_NONFIFO mode is configured

*esp\_err\_t* **i2c\_slave\_register\_event\_callbacks** (*i2c\_slave\_dev\_handle\_t* i2c\_slave, const *i2c\_slave\_event\_callbacks\_t* \*cbs, void \*user\_data)

Set I2C slave event callbacks for I2C slave channel.

---

**备注:** User can deregister a previously registered callback by calling this function and setting the callback member in the `cbs` structure to NULL.

---



---

**备注:** When `CONFIG_I2C_ISR_IRAM_SAFE` is enabled, the callback itself and functions called by it should be placed in IRAM. The variables used in the function should be in the SRAM as well. The `user_data` should also reside in SRAM.

---

#### 参数

- **i2c\_slave** -- **[in]** I2C slave device handle that created by `i2c_new_slave_device`.
- **cbs** -- **[in]** Group of callback functions
- **user\_data** -- **[in]** User data, which will be passed to callback functions directly

#### 返回

- `ESP_OK`: Set I2C transaction callbacks successfully
- `ESP_ERR_INVALID_ARG`: Set I2C transaction callbacks failed because of invalid argument
- `ESP_FAIL`: Set I2C transaction callbacks failed because of other error

*esp\_err\_t* **i2c\_slave\_read\_ram** (*i2c\_slave\_dev\_handle\_t* i2c\_slave, *uint8\_t* ram\_address, *uint8\_t* \*data, *size\_t* receive\_size)

Read bytes from I2C internal ram. This can be only used when `access_ram_en` in configuration structure set to true.

#### 参数

- **i2c\_slave** -- **[in]** I2C slave device handle that created by `i2c_new_slave_device`.
- **ram\_address** -- **[in]** The offset of RAM (Cannot larger than I2C RAM memory)
- **data** -- **[out]** Buffer to store data read from I2C ram.
- **receive\_size** -- **[in]** Received size from RAM.

#### 返回

- `ESP_OK`: I2C slave transmit success.
- `ESP_ERR_INVALID_ARG`: I2C slave transmit parameter invalid.
- `ESP_ERR_NOT_SUPPORTED`: This function should be work in non-fifo mode, but `I2C_SLAVE_FIFO` mode is configured

*esp\_err\_t* **i2c\_slave\_write\_ram** (*i2c\_slave\_dev\_handle\_t* i2c\_slave, *uint8\_t* ram\_address, const *uint8\_t* \*data, *size\_t* size)

Write bytes to I2C internal ram. This can be only used when `access_ram_en` in configuration structure set to true.

#### 参数

- **i2c\_slave** -- **[in]** I2C slave device handle that created by `i2c_new_slave_device`.
- **ram\_address** -- **[in]** The offset of RAM (Cannot larger than I2C RAM memory)
- **data** -- **[in]** Buffer to fill.
- **size** -- **[in]** Received size from RAM.

#### 返回

- `ESP_OK`: I2C slave transmit success.
- `ESP_ERR_INVALID_ARG`: I2C slave transmit parameter invalid.
- `ESP_ERR_INVALID_SIZE`: Write size is larger than
- `ESP_ERR_NOT_SUPPORTED`: This function should be work in non-fifo mode, but `I2C_SLAVE_FIFO` mode is configured

## Structures

struct **i2c\_slave\_config\_t**

I2C slave specific configurations.

### Public Members

*i2c\_port\_num\_t* **i2c\_port**

I2C port number, -1 for auto selecting

gpio\_num\_t **sda\_io\_num**

SDA IO number used by I2C bus

gpio\_num\_t **scl\_io\_num**

SCL IO number used by I2C bus

*i2c\_clock\_source\_t* **clk\_source**

Clock source of I2C bus.

uint32\_t **send\_buf\_depth**

Depth of internal transfer ringbuffer, increase this value can support more transfers pending in the background

uint16\_t **slave\_addr**

I2C slave address

*i2c\_addr\_bit\_len\_t* **addr\_bit\_len**

I2C slave address in bit length

int **intr\_priority**

I2C interrupt priority, if set to 0, driver will select the default priority (1,2,3).

uint32\_t **stretch\_en**

Enable slave stretch

uint32\_t **broadcast\_en**

I2C slave enable broadcast

uint32\_t **access\_ram\_en**

Can get access to I2C RAM directly

uint32\_t **slave\_unmatch\_en**

Can trigger unmatched interrupt when slave address does not match what master sends

struct *i2c\_slave\_config\_t*::[anonymous] **flags**

I2C slave config flags

struct **i2c\_slave\_event\_callbacks\_t**

Group of I2C slave callbacks (e.g. get i2c slave stretch cause). But take care of potential concurrency issues.

---

**备注:** The callbacks are all running under ISR context

---

---

**备注:** When CONFIG\_I2C\_ISR\_IRAM\_SAFE is enabled, the callback itself and functions called by it should be placed in IRAM. The variables used in the function should be in the SRAM as well.

---

## Public Members

*i2c\_slave\_stretch\_callback\_t* **on\_stretch\_occur**

I2C slave stretched callback

*i2c\_slave\_received\_callback\_t* **on\_recv\_done**

I2C slave receive done callback

## Header File

- `components/esp_driver_i2c/include/driver/i2c_types.h`
- This header file can be included with:

```
#include "driver/i2c_types.h"
```

- This header file is a part of the API provided by the `esp_driver_i2c` component. To declare that your component depends on `esp_driver_i2c`, add the following to your `CMakeLists.txt`:

```
REQUIRES esp_driver_i2c
```

or

```
PRIV_REQUIRES esp_driver_i2c
```

## Structures

struct **i2c\_master\_event\_data\_t**

Data type used in I2C event callback.

## Public Members

*i2c\_master\_event\_t* **event**

The I2C hardware event that I2C callback is called.

struct **i2c\_slave\_rx\_done\_event\_data\_t**

Event structure used in I2C slave.

## Public Members

uint8\_t \***buffer**

Pointer for buffer received in callback.

struct **i2c\_slave\_stretch\_event\_data\_t**

Stretch cause event structure used in I2C slave.



## Public Members

*i2c\_slave\_stretch\_cause\_t* **stretch\_cause**

Stretch cause can be got in callback

## Type Definitions

typedef int **i2c\_port\_num\_t**

I2C port number.

typedef struct i2c\_master\_bus\_t \***i2c\_master\_bus\_handle\_t**

Type of I2C master bus handle.

typedef struct i2c\_master\_dev\_t \***i2c\_master\_dev\_handle\_t**

Type of I2C master bus device handle.

typedef struct i2c\_slave\_dev\_t \***i2c\_slave\_dev\_handle\_t**

Type of I2C slave device handle.

typedef bool (\***i2c\_master\_callback\_t**)(*i2c\_master\_dev\_handle\_t* i2c\_dev, const *i2c\_master\_event\_data\_t* \**evt\_data*, void \**arg*)

An callback for I2C transaction.

**Param i2c\_dev [in]** Handle for I2C device.

**Param evt\_data [out]** I2C capture event data, fed by driver

**Param arg [in]** User data, set in *i2c\_master\_register\_event\_callbacks()*

**Return** Whether a high priority task has been waken up by this function

typedef bool (\***i2c\_slave\_received\_callback\_t**)(*i2c\_slave\_dev\_handle\_t* i2c\_slave, const *i2c\_slave\_rx\_done\_event\_data\_t* \**evt\_data*, void \**arg*)

Callback signature for I2C slave.

**Param i2c\_slave [in]** Handle for I2C slave.

**Param evt\_data [out]** I2C capture event data, fed by driver

**Param arg [in]** User data, set in *i2c\_slave\_register\_event\_callbacks()*

**Return** Whether a high priority task has been waken up by this function

typedef bool (\***i2c\_slave\_stretch\_callback\_t**)(*i2c\_slave\_dev\_handle\_t* i2c\_slave, const *i2c\_slave\_stretch\_event\_data\_t* \**evt\_cause*, void \**arg*)

Callback signature for I2C slave stretch.

**Param i2c\_slave [in]** Handle for I2C slave.

**Param evt\_cause [out]** I2C capture event cause, fed by driver

**Param user\_ctx [in]** User data, set in *i2c\_slave\_register\_event\_callbacks()*

**Return** Whether a high priority task has been waken up by this function

## Enumerations

enum **i2c\_master\_status\_t**

Enumeration for I2C fsm status.

*Values:*

enumerator **I2C\_STATUS\_READ**

read status for current master command

enumerator **I2C\_STATUS\_WRITE**

write status for current master command

enumerator **I2C\_STATUS\_START**

Start status for current master command

enumerator **I2C\_STATUS\_STOP**

stop status for current master command

enumerator **I2C\_STATUS\_IDLE**

idle status for current master command

enumerator **I2C\_STATUS\_ACK\_ERROR**

ack error status for current master command

enumerator **I2C\_STATUS\_DONE**

I2C command done

enumerator **I2C\_STATUS\_TIMEOUT**

I2C bus status error, and operation timeout

enum **i2c\_master\_event\_t**

Enumeration for I2C event.

*Values:*

enumerator **I2C\_EVENT\_ALIVE**

i2c bus in alive status.

enumerator **I2C\_EVENT\_DONE**

i2c bus transaction done

enumerator **I2C\_EVENT\_NACK**

i2c bus nack

enumerator **I2C\_EVENT\_TIMEOUT**

i2c bus timeout

### Header File

- [components/hal/include/hal/i2c\\_types.h](#)
- This header file can be included with:

```
#include "hal/i2c_types.h"
```

### Structures

struct **i2c\_hal\_clk\_config\_t**

Data structure for calculating I2C bus timing.

### Public Members

`uint16_t clk_div`  
I2C core clock divider

`uint16_t scl_low`  
I2C scl low period

`uint16_t scl_high`  
I2C scl high period

`uint16_t scl_wait_high`  
I2C scl wait\_high period

`uint16_t sda_hold`  
I2C scl low period

`uint16_t sda_sample`  
I2C sda sample time

`uint16_t setup`  
I2C start and stop condition setup period

`uint16_t hold`  
I2C start and stop condition hold period

`uint16_t tout`  
I2C bus timeout period

### Type Definitions

typedef `soc_periph_i2c_clk_src_t` `i2c_clock_source_t`  
I2C group clock source.

### Enumerations

enum `i2c_port_t`  
I2C port number, can be `I2C_NUM_0` ~ (`I2C_NUM_MAX`-1).  
*Values:*

enumerator `I2C_NUM_0`  
I2C port 0

enumerator `I2C_NUM_1`  
I2C port 1

enumerator `I2C_NUM_MAX`  
I2C port max

enum **i2c\_addr\_bit\_len\_t**

Enumeration for I2C device address bit length.

*Values:*

enumerator **I2C\_ADDR\_BIT\_LEN\_7**

i2c address bit length 7

enumerator **I2C\_ADDR\_BIT\_LEN\_10**

i2c address bit length 10

enum **i2c\_mode\_t**

*Values:*

enumerator **I2C\_MODE\_SLAVE**

I2C slave mode

enumerator **I2C\_MODE\_MASTER**

I2C master mode

enumerator **I2C\_MODE\_MAX**

enum **i2c\_rw\_t**

*Values:*

enumerator **I2C\_MASTER\_WRITE**

I2C write data

enumerator **I2C\_MASTER\_READ**

I2C read data

enum **i2c\_trans\_mode\_t**

*Values:*

enumerator **I2C\_DATA\_MODE\_MSB\_FIRST**

I2C data msb first

enumerator **I2C\_DATA\_MODE\_LSB\_FIRST**

I2C data lsb first

enumerator **I2C\_DATA\_MODE\_MAX**

enum **i2c\_addr\_mode\_t**

*Values:*

enumerator **I2C\_ADDR\_BIT\_7**

I2C 7bit address for slave mode

enumerator **I2C\_ADDR\_BIT\_10**  
I2C 10bit address for slave mode

enumerator **I2C\_ADDR\_BIT\_MAX**

enum **i2c\_ack\_type\_t**

*Values:*

enumerator **I2C\_MASTER\_ACK**  
I2C ack for each byte read

enumerator **I2C\_MASTER\_NACK**  
I2C nack for each byte read

enumerator **I2C\_MASTER\_LAST\_NACK**  
I2C nack for the last byte

enumerator **I2C\_MASTER\_ACK\_MAX**

enum **i2c\_slave\_stretch\_cause\_t**

Enum for I2C slave stretch causes.

*Values:*

enumerator **I2C\_SLAVE\_STRETCH\_CAUSE\_ADDRESS\_MATCH**  
Stretching SCL low when the slave is read by the master and the address just matched

enumerator **I2C\_SLAVE\_STRETCH\_CAUSE\_TX\_EMPTY**  
Stretching SCL low when TX FIFO is empty in slave mode

enumerator **I2C\_SLAVE\_STRETCH\_CAUSE\_RX\_FULL**  
Stretching SCL low when RX FIFO is full in slave mode

enumerator **I2C\_SLAVE\_STRETCH\_CAUSE\_SENDING\_ACK**  
Stretching SCL low when slave sending ACK

## 2.6.14 I2S

### 简介

I2S (Inter-IC Sound, 集成电路内置音频总线) 是一种同步串行通信协议, 通常用于在两个数字音频设备之间传输音频数据。

ESP32-H2 包含 1 个 I2S 外设。通过配置这些外设, 可以借助 I2S 驱动来输入和输出采样数据。

标准或 TDM 通信模式下的 I2S 总线包含以下几条线路:

- **MCLK**: 主时钟线。该信号线可选, 具体取决于从机, 主要用于向 I2S 从机提供参考时钟。
- **BCLK**: 位时钟线。用于数据线的位时钟。
- **WS**: 字 (声道) 选择线。通常用于识别声道 (除 PDM 模式外)。

- **DIN/DOOUT**: 串行数据输入/输出线。如果 DIN 和 DOOUT 被配置到相同的 GPIO，数据将在内部回环。

PDM 通信模式下的 I2S 总线包含以下几条线路：

- **CLK**: PDM 时钟线。
- **DIN/DOOUT**: 串行数据输入/输出线。

每个 I2S 控制器都具备以下功能，可由 I2S 驱动进行配置：

- 可用作系统主机或从机
- 可用作发射器或接收器
- DMA 控制器支持流数据采样，CPU 无需单独复制每个采样数据

每个控制器都有独立的 RX 和 TX 通道，连接到不同 GPIO 管脚，能够在不同的时钟和声道配置下工作。注意，尽管在一个控制器上 TX 通道和 RX 通道的内部 MCLK 相互独立，但输出的 MCLK 信号只能连接到一个通道。如果需要两个互相独立的 MCLK 输出，必须将其分配到不同的 I2S 控制器上。

## I2S 文件结构



图 12: I2S 文件结构

需要包含在 I2S 应用中的公共头文件如下所示：

- `i2s.h`: 提供原有 I2S API（用于使用原有驱动的应用）。
- `i2s_std.h`: 提供标准通信模式的 API（用于使用标准模式的新驱动程序的应用）。
- `i2s_pdm.h`: 提供 PDM 通信模式的 API（用于使用 PDM 模式的新驱动程序的应用）。
- `i2s_tdm.h`: 提供 TDM 通信模式的 API（用于使用 TDM 模式的新驱动的应用）。

**备注：** 原有驱动与新驱动无法共存。包含 `i2s.h` 以使用原有驱动，或包含其他三个头文件以使用新驱动。原有驱动未来可能会被删除。

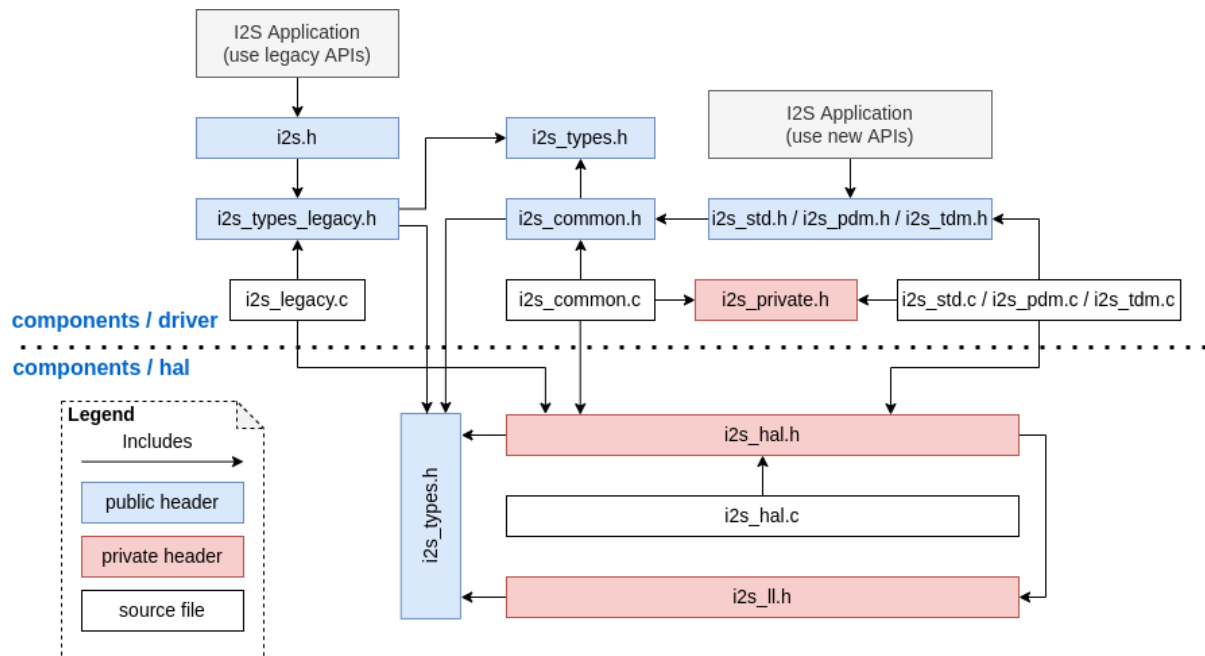
已包含在上述头文件中的公共头文件如下所示：

- `i2s_types_legacy.h`: 提供只在原有驱动中使用的原有公共类型。
- `i2s_types.h`: 提供公共类型。
- `i2s_common.h`: 提供所有通信模式通用的 API。

## I2S 时钟

### 时钟源

- `i2s_clock_src_t::I2S_CLK_SRC_DEFAULT`: 默认 PLL 时钟。
- `i2s_clock_src_t::I2S_CLK_SRC_PLL_96M`: 96 MHz PLL 时钟。

### 时钟术语

- **采样率**: 单声道每秒采样数据数量。
- **SCLK**: 源时钟频率, 即时钟源的频率。
- **MCLK**: 主时钟频率, BCLK 由其产生。MCLK 信号通常作为参考时钟, 用于同步 I2S 主机和从机之间的 BCLK 和 WS。
- **BCLK**: 位时钟频率, 一个 BCLK 时钟周期代表数据管脚上的一个数据位。通过 `i2s_std_slot_config_t::slot_bit_width` 配置的通道位宽即为一个声道中的 BCLK 时钟周期数量, 因此一个声道中可以有 8/16/24/32 个 BCLK 时钟周期。
- **LRCK / WS**: 左/右时钟或字选择时钟。在非 PDM 模式下, 其频率等于采样率。

**备注:** 通常, MCLK 应该同时是采样率和 BCLK 的倍数。字段 `i2s_std_clk_config_t::mclk_multiple` 表示 MCLK 相对于采样率的倍数。在大多数情况下, 将其设置为 `I2S_MCLK_MULTIPLE_256` 即可。但如果 `slot_bit_width` 被设置为 `I2S_SLOT_BIT_WIDTH_24BIT`, 为了保证 MCLK 是 BCLK 的整数倍, 应该将 `i2s_std_clk_config_t::mclk_multiple` 设置为能被 3 整除的倍数, 如 `I2S_MCLK_MULTIPLE_384`, 否则 WS 会不精准。

## I2S 通信模式

### 模式概览

芯片	I2S 标准	PDM TX	PDM RX	TDM	ADC/DAC	LCD/摄像头
ESP32	I2S 0/1	I2S 0	I2S 0	无	I2S 0	I2S 0
ESP32-S2	I2S 0	无	无	无	无	I2S 0
ESP32-C3	I2S 0	I2S 0	无	I2S 0	无	无
ESP32-C6	I2S 0	I2S 0	无	I2S 0	无	无
ESP32-S3	I2S 0/1	I2S 0	I2S 0	I2S 0/1	无	无
ESP32-H2	I2S 0	I2S 0	无	I2S 0	无	无
ESP32-P4	I2S 0~2	I2S 0	I2S 0	I2S 0~2	无	无

**标准模式** 标准模式中有且仅有左右两个声道, 驱动中将声道称为 slot。这些声道可以支持 8/16/24/32 位宽的采样数据, 声道的通信格式主要包括以下几种:

- **Philips 格式**: 数据信号与 WS 信号相比有一个位的位移。WS 信号的占空比为 50%。

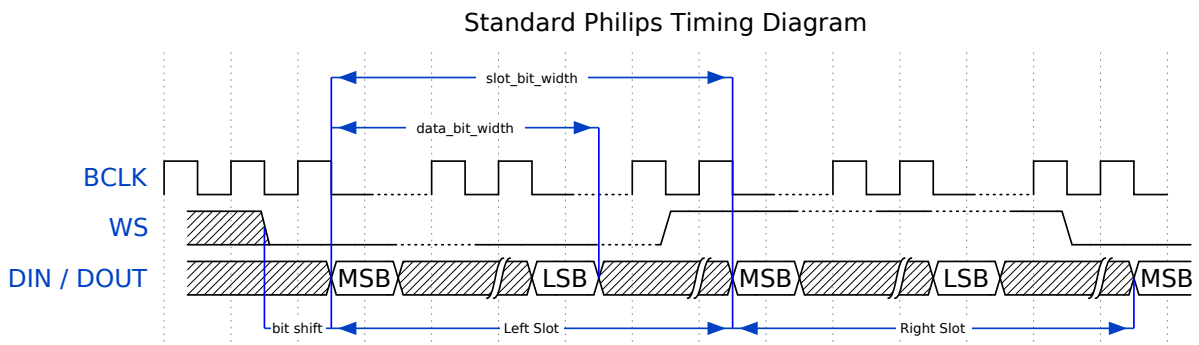

- **MSB 格式**: 与 Philips 格式基本相同, 但其数据没有位移。

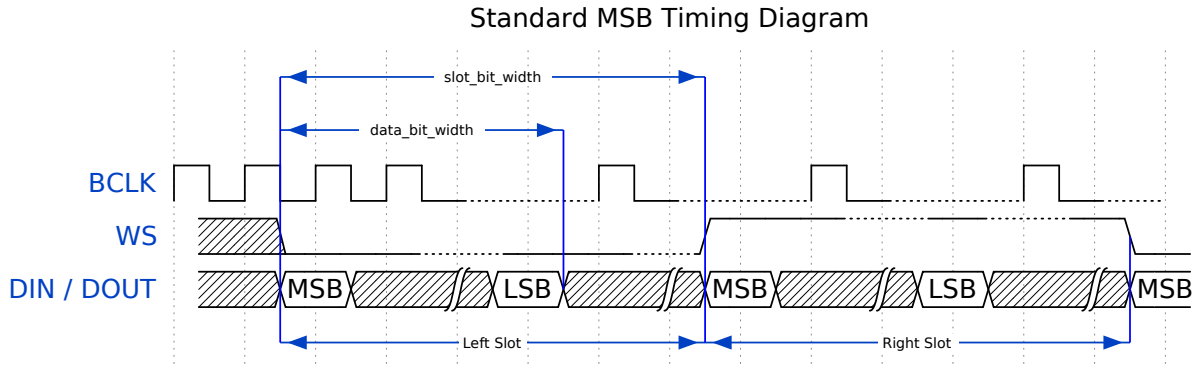

- **PCM 帧同步**：数据有一个位的位移，同时 WS 信号变成脉冲，持续一个 BCLK 周期。

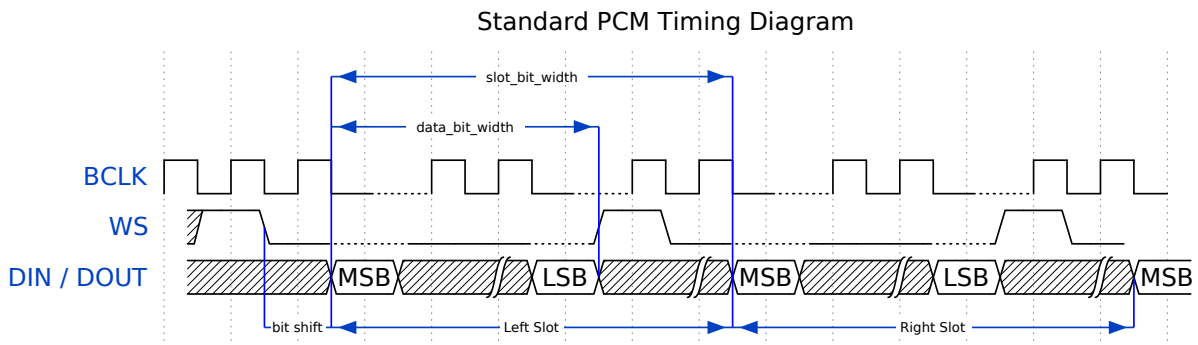

**PDM 模式 (TX)** 在 PDM (Pulse-density Modulation, 脉冲密度调制) 模式下, TX 通道可以将 PCM 数据转换为 PDM 格式, 该格式始终有左右两个声道。PDM TX 只在 I2S0 中受支持, 且只支持 16 位宽的采样数据。PDM TX 至少需要一个 CLK 管脚用于时钟信号, 一个 DOUT 管脚用于数据信号 (即下图中的 WS 和 SD 信号。BCK 信号为内部采样时钟, 在 PDM 设备之间不需要)。PDM 模式允许用户配置上采样参数 `i2s_pdm_tx_clk_config_t::up_sample_fp` 和 `i2s_pdm_tx_clk_config_t::up_sample_fs`, 上采样率可以通过公式 
$$\text{up\_sample\_rate} = \text{i2s\_pdm\_tx\_clk\_config\_t::up\_sample\_fp} / \text{i2s\_pdm\_tx\_clk\_config\_t::up\_sample\_fs}$$
 来计算。在 PDM TX 中有以下两种上采样模式:

- **固定时钟频率模式**：在这种模式下, 上采样率将根据采样率的变化而变化。设置  $f_p = 960$ 、 $f_s = \text{sample\_rate} / 100$ , 则 CLK 管脚上的时钟频率 ( $F_{\text{pdm}}$ ) 将固定为  $128 * 48 \text{ KHz} = 6.144 \text{ MHz}$ 。注意此频率不等于采样率 ( $F_{\text{pcm}}$ )。
- **固定上采样率模式**：在这种模式下, 上采样率固定为 2。设置  $f_p = 960$ 、 $f_s = 480$ , 则 CLK 管脚上的时钟频率 ( $F_{\text{pdm}}$ ) 将为  $128 * \text{sample\_rate}$ 。

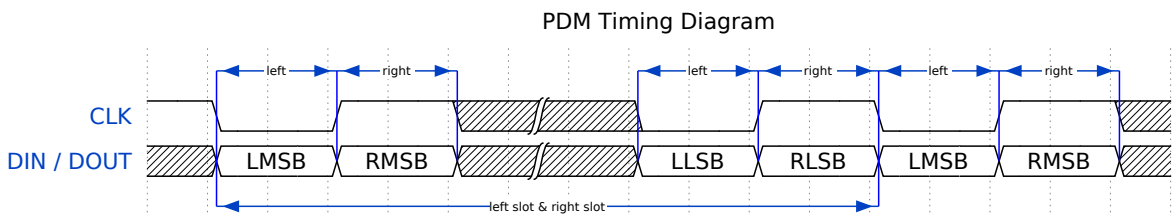

**TDM 模式** TDM (Time Division Multiplexing, 时分多路复用) 模式最多支持 16 个声道, 可通过 `i2s_tdm_slot_config_t::slot_mask` 启用通道。

该模式下无论启用多少声道, 都支持任意数据位宽, 也即一个帧中最多可以有  $32 \text{ 位宽} * 16 \text{ 个声道} = 512 \text{ 位}$  的数据。



- **Philips 格式**: 数据信号与 WS 信号相比有一个位的位移。无论一帧中包含多少个声道，WS 信号的占空比将始终保持为 50%。

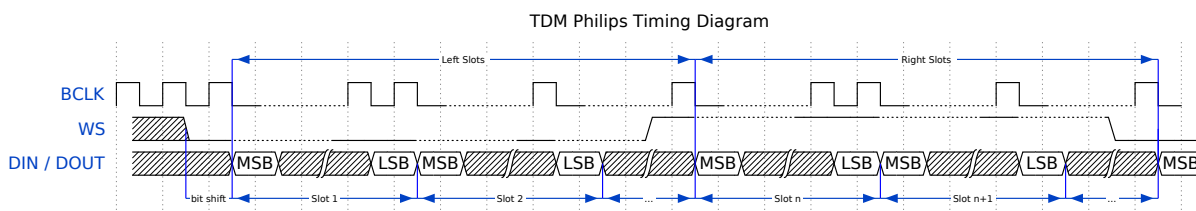

- **MSB 格式**: 与 Philips 格式基本相同，但数据没有位移。

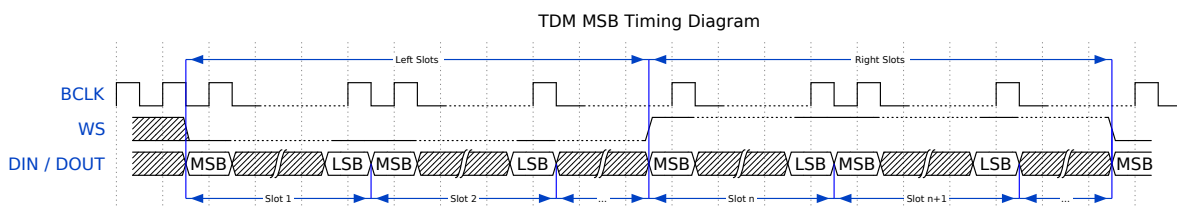

- **PCM 短帧同步**: 数据有一个位的位移，同时 WS 信号变为脉冲，每帧持续一个 BCLK 周期。

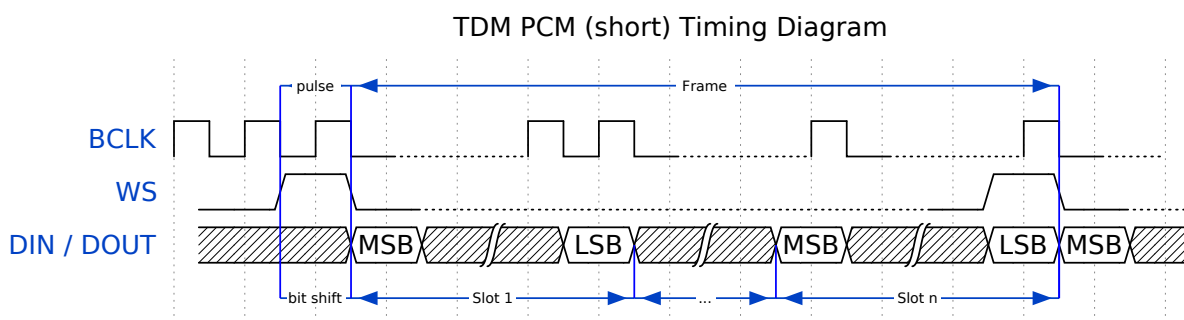

- **PCM 长帧同步**: 数据有一个位的位移，同时 WS 信号将在每一帧持续一个声道的宽度。例如，如果启用了四个声道，那么 WS 的占空比将是 25%，如果启用了五个声道，则为 20%。

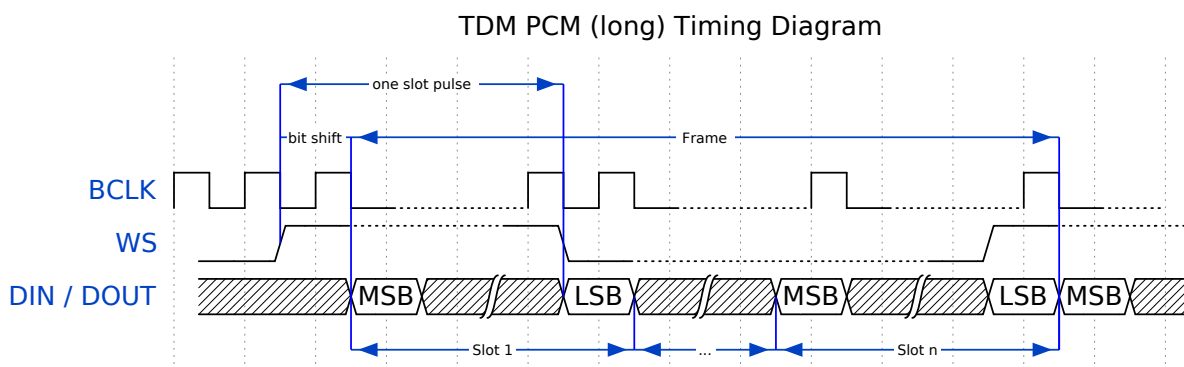

## 功能概览

I2S 驱动提供以下服务：

**资源管理** I2S 驱动中的资源可分为三个级别：

- 平台级资源：当前芯片中所有 I2S 控制器的资源。
- 控制器级资源：一个 I2S 控制器的资源。

- 通道级资源：一个 I2S 控制器 TX 或 RX 通道的资源。

公开的 API 都是通道级别的 API，通道句柄 `i2s_chan_handle_t` 可以帮助用户管理特定通道下的资源，而无需考虑其他两个级别的资源。高级别资源为私有资源，由驱动自动管理。用户可以调用 `i2s_new_channel()` 来分配通道句柄，或调用 `i2s_del_channel()` 来删除该句柄。

**电源管理** 电源管理启用（即开启 `CONFIG_PM_ENABLE`）时，系统将在进入 Light-sleep 前调整或停止 I2S 时钟源，这可能会影响 I2S 信号，从而导致传输或接收的数据无效。

I2S 驱动可以获取电源管理锁，从而防止系统设置更改或时钟源被禁用。时钟源为 APB 时，锁的类型将被设置为 `esp_pm_lock_type_t::ESP_PM_APB_FREQ_MAX`。时钟源为 APLL（若支持）时，锁的类型将被设置为 `esp_pm_lock_type_t::ESP_PM_NO_LIGHT_SLEEP`。用户通过 I2S 读写时（即调用 `i2s_channel_read()` 或 `i2s_channel_write()`），驱动程序将获取电源管理锁，并在读写完成后释放锁。

**有限状态机** I2S 通道有三种状态，分别为 registered（已注册）、ready（准备就绪）和 running（运行中），它们的关系如下图所示：



图 13: I2S 有限状态机

图中的 `<mode>` 可用相应的 I2S 通信模式来代替，如 `std` 代表标准的双声道模式。更多关于通信模式的信息，请参考 [I2S 通信模式](#) 小节。

**数据传输** I2S 的数据传输（包括数据发送和接收）由 DMA 实现。在传输数据之前，请调用 `i2s_channel_enable()` 来启用特定的通道。发送或接收的数据达到 DMA 缓冲区的大小时，将触发 `I2S_OUT_EOF` 或 `I2S_IN_SUC_EOF` 中断。注意，DMA 缓冲区的大小不等于 `i2s_chan_config_t::dma_frame_num`，这里的一帧是指一个 WS 周期内的所有采样数据。因此，`dma_buffer_size = dma_frame_num * slot_num * slot_bit_width / 8`。传输数据时，

可以调用 `i2s_channel_write()` 来输入数据，并把数据从源缓冲区复制到 DMA TX 缓冲区等待传输完成。此过程将重复进行，直到发送的字节数达到配置的大小。接收数据时，用户可以调用函数 `i2s_channel_read()` 来等待接收包含 DMA 缓冲区地址的消息队列，从而将数据从 DMA RX 缓冲区复制到目标缓冲区。

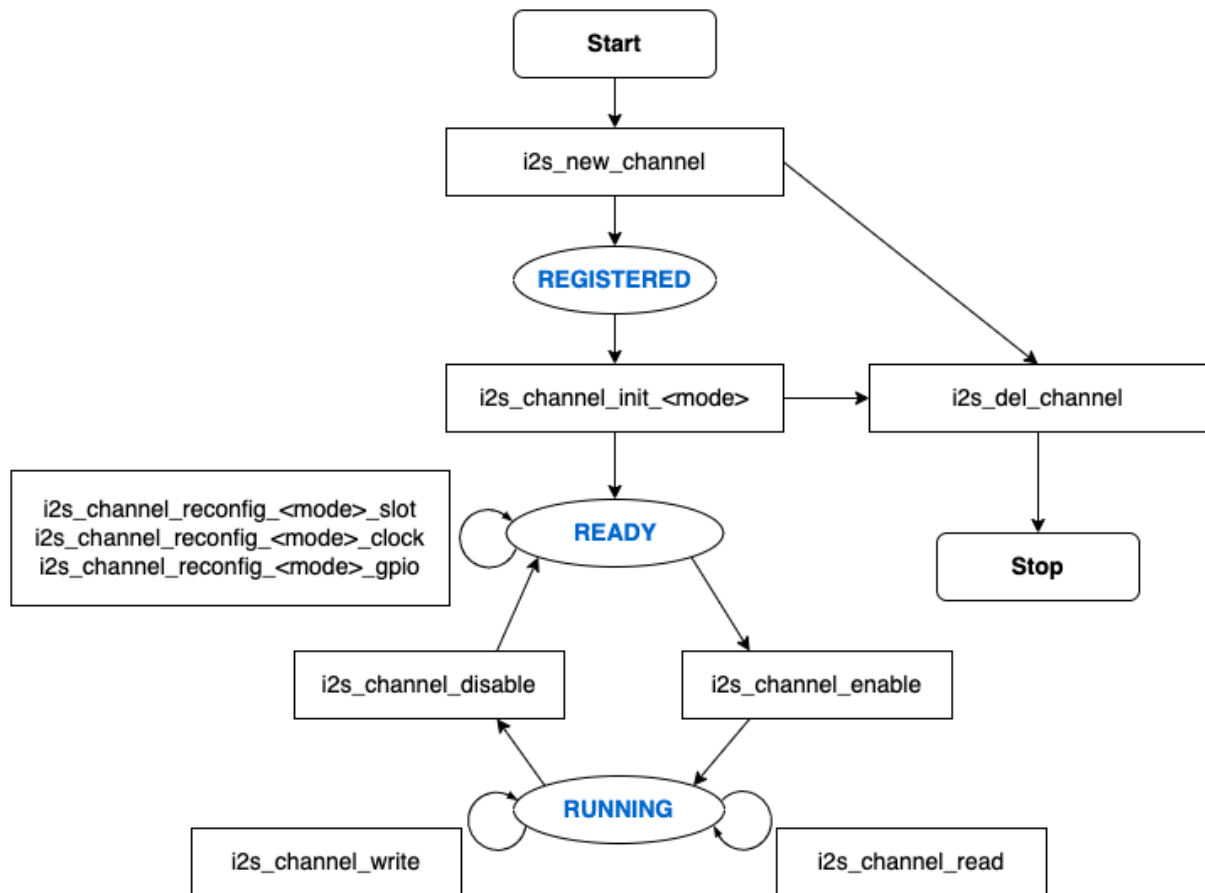
`i2s_channel_write()` 和 `i2s_channel_read()` 都是阻塞函数，在源缓冲区的数据发送完毕前，或是整个目标缓冲区都被加载数据占用时，它们会一直保持等待状态。在等待时间达到最大阻塞时间时，返回 `ESP_ERR_TIMEOUT` 错误。要实现异步发送或接收数据，可以通过 `i2s_channel_register_event_callback()` 注册回调，随即便可在回调函数中直接访问 DMA 缓冲区，无需通过这两个阻塞函数来发送或接收数据。但请注意，该回调是一个中断回调，不要在该回调中添加复杂的逻辑、进行浮点运算或调用不可重入函数。

**配置** 用户可以通过调用相应函数（即 `i2s_channel_init_std_mode()`、`i2s_channel_init_pdm_rx_mode()`、`i2s_channel_init_pdm_tx_mode()` 或 `i2s_channel_init_tdm_mode()`）将通道初始化为特定模式。如果初始化后需要更新配置，必须先调用 `i2s_channel_disable()` 以确保通道已经停止运行，然后再调用相应的 'reconfig' 函数，例如 `i2s_channel_reconfig_std_slot()`、`i2s_channel_reconfig_std_clock()` 和 `i2s_channel_reconfig_std_gpio()`。

**IRAM 安全** 默认情况下，由于写入或擦除 flash 等原因导致 cache 被禁用时，I2S 中断将产生延迟，无法及时执行 EOF 中断。

在实时应用中，可通过启用 Kconfig 选项 `CONFIG_I2S_ISR_IRAM_SAFE` 来避免此种情况发生，启用后：

1. 即使在 cache 被禁用的情况下，中断仍可继续运行。
2. 驱动程序将存放在 DRAM 中（以防其意外映射到 PSRAM 中）。

启用该选项可以保证 cache 禁用时的中断运行，但会相应增加 IRAM 占用。

**线程安全** 驱动程序可保证所有公开的 I2S API 的线程安全，使用时，可以直接从不同的 RTOS 任务中调用此类 API，无需额外锁保护。注意，I2S 驱动使用 mutex 锁来保证线程安全，因此不允许在 ISR 中使用这些 API。

### Kconfig 选项

- `CONFIG_I2S_ISR_IRAM_SAFE` 控制默认 ISR 处理程序能否在禁用 cache 的情况下工作。更多信息可参考 **IRAM 安全**。
- `CONFIG_I2S_SUPPRESS_DEPRECATED_WARN` 控制是否在使用原有 I2S 驱动时关闭警告信息。
- `CONFIG_I2S_ENABLE_DEBUG_LOG` 用于启用调试日志输出。启用该选项将增加固件的二进制文件大小。

### 应用实例

I2S 驱动例程请参考 `peripherals/i2s` 目录。以下为每种模式的简单用法：

**标准 TX/RX 模式的应用** 不同声道的通信格式可通过以下标准模式的辅助宏来生成。如上所述，在标准模式下有三种格式，辅助宏分别为：

- `I2S_STD_PHILIPS_SLOT_DEFAULT_CONFIG`
- `I2S_STD_PCM_SLOT_DEFAULT_CONFIG`
- `I2S_STD_MSB_SLOT_DEFAULT_CONFIG`

时钟配置的辅助宏为：

- `I2S_STD_CLK_DEFAULT_CONFIG`。

请参考 **标准模式** 了解 STD API 的相关信息。更多细节请参考 `esp_driver_i2s/include/driver/i2s_std.h`。

**STD TX 模式** 以 16 位数据位宽为例，如果 `uint16_t` 写缓冲区中的数据如下所示：

数据 0	数据 1	数据 2	数据 3	数据 4	数据 5	数据 6	数据 7	...
0x0001	0x0002	0x0003	0x0004	0x0005	0x0006	0x0007	0x0008	...

下表展示了在不同 `i2s_std_slot_config_t::slot_mode` 和 `i2s_std_slot_config_t::slot_mask` 设置下线路上的真实数据。

数据位宽	声道模式	声道掩码	WS 低电平	WS 高电平	WS 低电平	WS 高电平	WS 低电平	WS 高电平	WS 低电平	WS 高电平
16 位	单声道	左	0x0001	0x0000	0x0002	0x0000	0x0003	0x0000	0x0004	0x0000
		右	0x0000	0x0001	0x0000	0x0002	0x0000	0x0003	0x0000	0x0004
		左右	0x0001	0x0001	0x0002	0x0002	0x0003	0x0003	0x0004	0x0004
	立体声	左	0x0001	0x0000	0x0003	0x0000	0x0005	0x0000	0x0007	0x0000
		右	0x0000	0x0002	0x0000	0x0004	0x0000	0x0006	0x0000	0x0008
		左右	0x0001	0x0002	0x0003	0x0004	0x0005	0x0006	0x0007	0x0008

**备注：** 数据位宽为 8 位和 32 位时，缓冲区的类型最好为 `uint8_t` 和 `uint32_t`。但需注意，数据位宽为 24 位时，数据缓冲区应该以 3 字节对齐，即每 3 个字节代表一个 24 位数据，另外，`i2s_chan_config_t::dma_frame_num`、`i2s_std_clk_config_t::mclk_multiple` 和写缓冲区的大小应该为 3 的倍数，否则线路上的数据或采样率可能会不准确。

```
#include "driver/i2s_std.h"
#include "driver/gpio.h"

i2s_chan_handle_t tx_handle;
/* 通过辅助宏获取默认的通道配置
 * 这个辅助宏在 'i2s_common.h' 中定义，由所有 I2S 通信模式共享
 * 它可以帮助指定 I2S 角色和端口 ID */
i2s_chan_config_t chan_cfg = I2S_CHANNEL_DEFAULT_CONFIG(I2S_NUM_AUTO, I2S_ROLE_
↳MASTER);
/* 分配新的 TX 通道并获取该通道的句柄 */
i2s_new_channel(&chan_cfg, &tx_handle, NULL);

/* 进行配置，可以通过宏生成声道配置和时钟配置
 * 这两个辅助宏在 'i2s_std.h' 中定义，只能用于 STD 模式
 * 它们可以帮助初始化或更新声道和时钟配置 */
i2s_std_config_t std_cfg = {
    .clk_cfg = I2S_STD_CLK_DEFAULT_CONFIG(48000),
    .slot_cfg = I2S_STD_MSB_SLOT_DEFAULT_CONFIG(I2S_DATA_BIT_WIDTH_32BIT, I2S_SLOT_
↳MODE_STEREO),
    .gpio_cfg = {
        .mclk = I2S_GPIO_UNUSED,
        .bclk = GPIO_NUM_4,
        .ws = GPIO_NUM_5,
        .dout = GPIO_NUM_18,
        .din = I2S_GPIO_UNUSED,
        .invert_flags = {
            .mclk_inv = false,
            .bclk_inv = false,
            .ws_inv = false,
        },
    },
};
/* 初始化通道 */
i2s_channel_init_std_mode(tx_handle, &std_cfg);
```

(下页继续)

(续上页)

```

/* 在写入数据之前,先启用 TX 通道 */
i2s_channel_enable(tx_handle);
i2s_channel_write(tx_handle, src_buf, bytes_to_write, bytes_written, ticks_to_
↪wait);

/* 如果需要更新声道或时钟配置
 * 需要在更新前先禁用通道 */
// i2s_channel_disable(tx_handle);
// std_cfg.slot_cfg.slot_mode = I2S_SLOT_MODE_MONO; // 默认为立体声
// i2s_channel_reconfig_std_slot(tx_handle, &std_cfg.slot_cfg);
// std_cfg.clk_cfg.sample_rate_hz = 96000;
// i2s_channel_reconfig_std_clock(tx_handle, &std_cfg.clk_cfg);

/* 删除通道之前必须先禁用通道 */
i2s_channel_disable(tx_handle);
/* 如果不再需要句柄,删除该句柄以释放通道资源 */
i2s_del_channel(tx_handle);

```

**STD RX 模式** 例如,当数据位宽为 16 时,如线路上的数据如下所示:

WS 低电 平	WS 高电 平	WS 低电 平	WS 高电 平	WS 低电 平	WS 高电 平	WS 低电 平	WS 高电 平	...
0x0001	0x0002	0x0003	0x0004	0x0005	0x0006	0x0007	0x0008	...

不同 `i2s_std_slot_config_t::slot_mode` 和 `i2s_std_slot_config_t::slot_mask` 配置下缓冲区中收到的数据如下所示。

数据位 宽	声道模 式	声道掩 码	数据 0	数据 1	数据 2	数据 3	数据 4	数据 5	数据 6	数据 7
16 位	单声道	左	0x0001	0x0003	0x0005	0x0007	0x0009	0x000b	0x000d	0x000f
		右	0x0002	0x0004	0x0006	0x0008	0x000a	0x000c	0x000e	0x0010
	立体声	任意	0x0001	0x0002	0x0003	0x0004	0x0005	0x0006	0x0007	0x0008

**备注:** 8 位、24 位和 32 位与 16 位的情况类似,接收缓冲区的数据位宽与线路上的数据位宽相等。此外需注意,数据位宽为 24 位时, `i2s_chan_config_t::dma_frame_num`、`i2s_std_clk_config_t::mclk_multiple` 和接收缓冲区的大小应该为 3 的倍数,否则线路上的数据或采样率可能会不准确。

```

#include "driver/i2s_std.h"
#include "driver/gpio.h"

i2s_chan_handle_t rx_handle;
/* 通过辅助宏获取默认的配置
 * 这个辅助宏在 'i2s_common.h' 中定义,由所有 I2S 通信模式共享
 * 它可以指定 I2S 角色和端口 ID */
i2s_chan_config_t chan_cfg = I2S_CHANNEL_DEFAULT_CONFIG(I2S_NUM_AUTO, I2S_ROLE_
↪MASTER);
/* 分配新的 TX 通道并获取该通道的句柄 */
i2s_new_channel(&chan_cfg, NULL, &rx_handle);

/* 进行配置,可以通过宏生成声道配置和时钟配置
 * 这两个辅助宏在 'i2s_std.h' 中定义,只能用于 STD 模式
 * 它们可以帮助初始化或更新声道和时钟配置 */
i2s_std_config_t std_cfg = {
    .clk_cfg = I2S_STD_CLK_DEFAULT_CONFIG(48000),

```

(下页继续)

```

        .slot_cfg = I2S_STD_MSB_SLOT_DEFAULT_CONFIG(I2S_DATA_BIT_WIDTH_32BIT, I2S_SLOT_
↪MODE_STEREO),
        .gpio_cfg = {
            .mclk = I2S_GPIO_UNUSED,
            .bclk = GPIO_NUM_4,
            .ws = GPIO_NUM_5,
            .dout = I2S_GPIO_UNUSED,
            .din = GPIO_NUM_19,
            .invert_flags = {
                .mclk_inv = false,
                .bclk_inv = false,
                .ws_inv = false,
            },
        },
    },
};
/* 初始化通道 */
i2s_channel_init_std_mode(rx_handle, &std_cfg);

/* 在读取数据之前, 先启动 RX 通道 */
i2s_channel_enable(rx_handle);
i2s_channel_read(rx_handle, desc_buf, bytes_to_read, bytes_read, ticks_to_wait);

/* 删除通道之前必须先禁用通道 */
i2s_channel_disable(rx_handle);
/* 如果不再需要句柄, 删除该句柄以释放通道资源 */
i2s_del_channel(rx_handle);

```

**PDM TX 模式的应用** 针对 TX 通道的 PDM 模式，声道配置的辅助宏为：

- `I2S_PDM_TX_SLOT_DEFAULT_CONFIG`

时钟配置的辅助宏为：

- `I2S_PDM_TX_CLK_DEFAULT_CONFIG`

PDM TX API 的相关信息，可参考 [PDM 模式](#)。更多细节请参阅 `esp_driver_i2s/include/driver/i2s_pdm.h`。

PDM 数据位宽固定为 16 位。如果 `int16_t` 写缓冲区中的数据如下：

数据 0	数据 1	数据 2	数据 3	数据 4	数据 5	数据 6	数据 7	...
0x0001	0x0002	0x0003	0x0004	0x0005	0x0006	0x0007	0x0008	...

下表展示了不同 `i2s_pdm_tx_slot_config_t::slot_mode` 和 `i2s_pdm_tx_slot_config_t::slot_mask` 设置下线路上的真实数据。为方便理解，已将线路上的数据格式由 PDM 转为 PCM。

线路模式	声道模式	线路	左	右	左	右	左	右	左	右
单线 Codec	单声道	dout	0x0001	0x0000	0x0002	0x0000	0x0003	0x0000	0x0004	0x0000
	立体声	dout	0x0001	0x0002	0x0003	0x0004	0x0005	0x0006	0x0007	0x0008
单线 DAC	单声道	dout	0x0001	0x0001	0x0002	0x0002	0x0003	0x0003	0x0004	0x0004
双线 DAC	单声道	dout	0x0002	0x0002	0x0004	0x0004	0x0006	0x0006	0x0008	0x0008
		dout2	0x0000	0x0000	0x0000	0x0000	0x0000	0x0000	0x0000	0x0000
	立体声	dout	0x0002	0x0002	0x0004	0x0004	0x0006	0x0006	0x0008	0x0008
		dout2	0x0001	0x0001	0x0003	0x0003	0x0005	0x0005	0x0007	0x0007

**备注：** PDM TX 模式有三种线路模式，分别为 `I2S_PDM_TX_ONE_LINE_CODECS`、`I2S_PDM_TX_ONE_LINE_DAC` 和 `I2S_PDM_TX_TWO_LINE_DAC`。单线 Codec 用于需要时钟信



号的 PDM 编解码器，PDM 编解码器可以通过时钟电平来区分左右声道。另外两种模式可通过低通滤波器直接驱动功率放大器，而无需时钟信号，所以有两条线路来区分左右声道。此外，对于单线 Codec 的单声道模式，可以通过在 GPIO 配置中设置时钟反转标志，强制将声道改变为右声道。

```
#include "driver/i2s_pdm.h"
#include "driver/gpio.h"

/* 分配 I2S TX 通道 */
i2s_chan_config_t chan_cfg = I2S_CHANNEL_DEFAULT_CONFIG(I2S_NUM_0, I2S_ROLE_
↪MASTER);
i2s_new_channel(&chan_cfg, &tx_handle, NULL);

/* 初始化通道为 PDM TX 模式 */
i2s_pdm_tx_config_t pdm_tx_cfg = {
    .clk_cfg = I2S_PDM_TX_CLK_DEFAULT_CONFIG(36000),
    .slot_cfg = I2S_PDM_TX_SLOT_DEFAULT_CONFIG(I2S_DATA_BIT_WIDTH_16BIT, I2S_SLOT_
↪MODE_MONO),
    .gpio_cfg = {
        .clk = GPIO_NUM_5,
        .dout = GPIO_NUM_18,
        .invert_flags = {
            .clk_inv = false,
        },
    },
};
i2s_channel_init_pdm_tx_mode(tx_handle, &pdm_tx_cfg);

...
```

**TDM TX/RX 模式的应用** 可以通过以下 TDM 模式的辅助宏生成不同的声道通信格式。如上所述，TDM 模式有四种格式，它们的辅助宏分别为：

- `I2S_TDM_PHILIPS_SLOT_DEFAULT_CONFIG`
- `I2S_TDM_MSB_SLOT_DEFAULT_CONFIG`
- `I2S_TDM_PCM_SHORT_SLOT_DEFAULT_CONFIG`
- `I2S_TDM_PCM_LONG_SLOT_DEFAULT_CONFIG`

时钟配置的辅助宏为：

- `I2S_TDM_CLK_DEFAULT_CONFIG`

有关 TDM API 的信息，请参阅 [TDM 模式](#)。更多细节请参阅 `esp_driver_i2s/include/driver/i2s_tdm.h`。

**备注：**在为从机配置时钟时，由于硬件限制，请注意 `i2s_tdm_clk_config_t::bclk_div` 不应小于 8，增加此字段的值可以减少从机发送数据的延迟。使用高采样率时，数据可能会延迟一个 BCLK 周期以上，这将导致数据错位。可以通过缓慢增加 `i2s_tdm_clk_config_t::bclk_div` 的值来进行校正。

由于 `i2s_tdm_clk_config_t::bclk_div` 是 MCLK 基于 BCLK 的除数，增加该值也可以提高 MCLK 频率。因此，如果 MCLK 频率太高，将会无法从源时钟分频，此时时钟计算可能会失败，也就是说 `i2s_tdm_clk_config_t::bclk_div` 不是越大越好。

## TDM TX 模式

```
#include "driver/i2s_tdm.h"
#include "driver/gpio.h"

/* 分配 I2S TX 通道 */
i2s_chan_config_t chan_cfg = I2S_CHANNEL_DEFAULT_CONFIG(I2S_NUM_AUTO, I2S_ROLE_
↪MASTER);
```

(下页继续)

```

i2s_new_channel(&chan_cfg, &tx_handle, NULL);

/* 初始化通道为 TDM 模式 */
i2s_tdm_config_t tdm_cfg = {
    .clk_cfg = I2S_TDM_CLK_DEFAULT_CONFIG(44100),
    .slot_cfg = I2S_TDM_MSB_SLOT_DEFAULT_CONFIG(I2S_DATA_BIT_WIDTH_16BIT, I2S_SLOT_
↪MODE_STEREO,
        I2S_TDM_SLOT0 | I2S_TDM_SLOT1 | I2S_TDM_SLOT2 | I2S_TDM_SLOT3),
    .gpio_cfg = {
        .mclk = I2S_GPIO_UNUSED,
        .bclk = GPIO_NUM_4,
        .ws = GPIO_NUM_5,
        .dout = GPIO_NUM_18,
        .din = I2S_GPIO_UNUSED,
        .invert_flags = {
            .mclk_inv = false,
            .bclk_inv = false,
            .ws_inv = false,
        },
    },
};
i2s_channel_init_tdm_mode(tx_handle, &tdm_cfg);

...

```

### TDM RX 模式

```

#include "driver/i2s_tdm.h"
#include "driver/gpio.h"

/* 将通道模式设置为 TDM */
i2s_chan_config_t chan_cfg = I2S_CHANNEL_CONFIG(I2S_ROLE_MASTER, I2S_COMM_MODE_TDM,
↪ &i2s_pin);
i2s_new_channel(&chan_cfg, NULL, &rx_handle);

/* 初始化通道为 TDM 模式 */
i2s_tdm_config_t tdm_cfg = {
    .clk_cfg = I2S_TDM_CLK_DEFAULT_CONFIG(44100),
    .slot_cfg = I2S_TDM_MSB_SLOT_DEFAULT_CONFIG(I2S_DATA_BIT_WIDTH_16BIT, I2S_SLOT_
↪MODE_STEREO,
        I2S_TDM_SLOT0 | I2S_TDM_SLOT1 | I2S_TDM_SLOT2 | I2S_TDM_SLOT3),
    .gpio_cfg = {
        .mclk = I2S_GPIO_UNUSED,
        .bclk = GPIO_NUM_4,
        .ws = GPIO_NUM_5,
        .dout = I2S_GPIO_UNUSED,
        .din = GPIO_NUM_18,
        .invert_flags = {
            .mclk_inv = false,
            .bclk_inv = false,
            .ws_inv = false,
        },
    },
};
i2s_channel_init_tdm_mode(rx_handle, &tdm_cfg);

...

```

**全双工** 全双工模式可以在 I2S 端口中同时注册 TX 和 RX 通道，同时通道共享 BCLK 和 WS 信号。目前，STD 和 TDM 通信模式支持以下方式的全双工通信，但不支持 PDM 全双工模式，因为 PDM 模式下 TX 和 RX 通道的时钟不同。



请注意，一个句柄只能代表一个通道，因此仍然需要对 TX 和 RX 通道逐个进行声道和时钟配置。

以下示例展示了如何分配两个全双工通道：

```
#include "driver/i2s_std.h"
#include "driver/gpio.h"

i2s_chan_handle_t tx_handle;
i2s_chan_handle_t rx_handle;

/* 分配两个 I2S 通道 */
i2s_chan_config_t chan_cfg = I2S_CHANNEL_DEFAULT_CONFIG(I2S_NUM_AUTO, I2S_ROLE_
↪MASTER);
/* 同时分配给 TX 和 RX 通道，使其进入全双工模式。 */
i2s_new_channel(&chan_cfg, &tx_handle, &rx_handle);

/* 配置两个通道，因为在全双工模式下，TX 和 RX 通道必须相同。 */
i2s_std_config_t std_cfg = {
    .clk_cfg = I2S_STD_CLK_DEFAULT_CONFIG(32000),
    .slot_cfg = I2S_STD_PHILIPS_SLOT_DEFAULT_CONFIG(I2S_DATA_BIT_WIDTH_16BIT, I2S_
↪SLOT_MODE_STEREO),
    .gpio_cfg = {
        .mclk = I2S_GPIO_UNUSED,
        .bclk = GPIO_NUM_4,
        .ws = GPIO_NUM_5,
        .dout = GPIO_NUM_18,
        .din = GPIO_NUM_19,
        .invert_flags = {
            .mclk_inv = false,
            .bclk_inv = false,
            .ws_inv = false,
        },
    },
};
i2s_channel_init_std_mode(tx_handle, &std_cfg);
i2s_channel_init_std_mode(rx_handle, &std_cfg);

i2s_channel_enable(tx_handle);
i2s_channel_enable(rx_handle);

...
```

**单工模式** 在单工模式下分配通道，应该为每个通道调用 `i2s_new_channel()`。ESP32-H2 上，TX/RX 通道的时钟和 GPIO 管脚相互独立，因此可以配置为不同的模式和时钟，并且能够在单工模式下共存于同一个 I2S 端口中。对于 PDM 模式，用户可以通过在同一个 I2S 端口上注册 PDM TX 单工和 PDM RX 单工来实现 PDM 双工。但在这种情况下，PDM TX/RX 可能会使用不同的时钟，因此在配置 GPIO 管脚和时钟时需多加注意。

以下为单工模式的示例。请注意，如果 TX 和 RX 通道来自同一个控制器，则 TX 和 RX 通道的内部 MCLK 信号虽然是分开的，但输出的 MCLK 信号只能绑定到其中一个通道。如果两个通道都初始化了 MCLK，则该信号会绑定到后初始化的通道。

```
#include "driver/i2s_std.h"
#include "driver/gpio.h"

i2s_chan_handle_t tx_handle;
i2s_chan_handle_t rx_handle;
i2s_chan_config_t chan_cfg = I2S_CHANNEL_DEFAULT_CONFIG(I2S_NUM_0, I2S_ROLE_
↪MASTER);
i2s_new_channel(&chan_cfg, &tx_handle, NULL);
i2s_std_config_t std_tx_cfg = {
```

(下页继续)

```

        .clk_cfg = I2S_STD_CLK_DEFAULT_CONFIG(48000),
        .slot_cfg = I2S_STD_PHILIPS_SLOT_DEFAULT_CONFIG(I2S_DATA_BIT_WIDTH_16BIT, I2S_
↪SLOT_MODE_STEREO),
        .gpio_cfg = {
            .mclk = GPIO_NUM_0,
            .bclk = GPIO_NUM_4,
            .ws = GPIO_NUM_5,
            .dout = GPIO_NUM_18,
            .din = I2S_GPIO_UNUSED,
            .invert_flags = {
                .mclk_inv = false,
                .bclk_inv = false,
                .ws_inv = false,
            },
        },
    },
};
/* 初始化通道 */
i2s_channel_init_std_mode(tx_handle, &std_tx_cfg);
i2s_channel_enable(tx_handle);

/* 如果没有找到其他可用的 I2S 设备, RX 通道将被注册在另一个 I2S 上
 * 并返回 ESP_ERR_NOT_FOUND */
i2s_new_channel(&chan_cfg, NULL, &rx_handle); // RX 和 TX 通道都将注册在 I2S0_
↪上, 但配置可以不同
i2s_std_config_t std_rx_cfg = {
    .clk_cfg = I2S_STD_CLK_DEFAULT_CONFIG(16000),
    .slot_cfg = I2S_STD_MSB_SLOT_DEFAULT_CONFIG(I2S_DATA_BIT_WIDTH_32BIT, I2S_SLOT_
↪MODE_STEREO),
    .gpio_cfg = {
        .mclk = I2S_GPIO_UNUSED,
        .bclk = GPIO_NUM_6,
        .ws = GPIO_NUM_7,
        .dout = I2S_GPIO_UNUSED,
        .din = GPIO_NUM_19,
        .invert_flags = {
            .mclk_inv = false,
            .bclk_inv = false,
            .ws_inv = false,
        },
    },
};
i2s_channel_init_std_mode(rx_handle, &std_rx_cfg);
i2s_channel_enable(rx_handle);

```

### 应用注意事项

**防止数据丢失** 对于需要高频采样率的应用, 数据的巨大吞吐量可能会导致数据丢失。用户可以通过注册 ISR 回调函数来接收事件队列中的数据丢失事件:

```

static IRAM_ATTR bool i2s_rx_queue_overflow_callback(i2s_chan_handle_t_
↪handle, i2s_event_data_t *event, void *user_ctx)
{
    // 处理 RX 队列溢出事件 ...
    return false;
}

i2s_event_callbacks_t cbs = {
    .on_recv = NULL,
    .on_recv_q_ovf = i2s_rx_queue_overflow_callback,

```

(下页继续)

(续上页)

```

        .on_sent = NULL,
        .on_send_q_ovf = NULL,
    };
    TEST_ESP_OK(i2s_channel_register_event_callback(rx_handle, &cbs, NULL));

```

请按照以下步骤操作，以防止数据丢失：

1. 确定中断间隔。通常来说，当发生数据丢失时，为减少中断次数，中断间隔应该越久越好。因此，在保证 DMA 缓冲区大小不超过最大值 4092 的前提下，应使 `dma_frame_num` 尽可能大。具体转换关系如下：

```

interrupt_interval(unit: sec) = dma_frame_num / sample_rate
dma_buffer_size = dma_frame_num * slot_num * data_bit_width / 8 <= 4092

```

2. 确定 `dma_desc_num` 的值。`dma_desc_num` 由 `i2s_channel_read` 轮询周期的最大时间决定，所有接收到的数据都应该存储在两个 `i2s_channel_read` 之间。这个周期可以通过计时器或输出 GPIO 信号来计算。具体转换关系如下：

```

dma_desc_num > polling_cycle / interrupt_interval

```

3. 确定接收缓冲区大小。在 `i2s_channel_read` 中提供的接收缓冲区应当能够容纳所有 DMA 缓冲区中的数据，这意味着它应该大于所有 DMA 缓冲区的总大小：

```

recv_buffer_size > dma_desc_num * dma_buffer_size

```

例如，如果某个 I2S 应用的已知值包括：

```

sample_rate = 144000 Hz
data_bit_width = 32 bits
slot_num = 2
polling_cycle = 10 ms

```

那么可以按照以下公式计算出参数 `dma_frame_num`、`dma_desc_num` 和 `recv_buf_size`：

```

dma_frame_num * slot_num * data_bit_width / 8 = dma_buffer_size <= 4092
dma_frame_num <= 511
interrupt_interval = dma_frame_num / sample_rate = 511 / 144000 = 0.003549 s = 3.549 ms
dma_desc_num > polling_cycle / interrupt_interval = cell(10 / 3.549) = cell(2.818) = 3
recv_buffer_size > dma_desc_num * dma_buffer_size = 3 * 4092 = 12276 bytes

```

## API 参考

### 标准模式

#### Header File

- [components/esp\\_driver\\_i2s/include/driver/i2s\\_std.h](#)
- This header file can be included with:

```
#include "driver/i2s_std.h"
```

- This header file is a part of the API provided by the `esp_driver_i2s` component. To declare that your component depends on `esp_driver_i2s`, add the following to your `CMakeLists.txt`:

```
REQUIRES esp_driver_i2s
```

or

```
PRIV_REQUIRES esp_driver_i2s
```

## Functions

*esp\_err\_t* **i2s\_channel\_init\_std\_mode** (*i2s\_chan\_handle\_t* handle, const *i2s\_std\_config\_t* \*std\_cfg)

Initialize I2S channel to standard mode.

**备注:** Only allowed to be called when the channel state is REGISTERED, (i.e., channel has been allocated, but not initialized) and the state will be updated to READY if initialization success, otherwise the state will return to REGISTERED.

### 参数

- **handle** -- **[in]** I2S channel handler
- **std\_cfg** -- **[in]** Configurations for standard mode, including clock, slot and GPIO. The clock configuration can be generated by the helper macro `I2S_STD_CLK_DEFAULT_CONFIG`. The slot configuration can be generated by the helper macro `I2S_STD_PHILIPS_SLOT_DEFAULT_CONFIG`, `I2S_STD_PCM_SLOT_DEFAULT_CONFIG` or `I2S_STD_MSB_SLOT_DEFAULT_CONFIG`.

### 返回

- `ESP_OK` Initialize successfully
- `ESP_ERR_NO_MEM` No memory for storing the channel information
- `ESP_ERR_INVALID_ARG` NULL pointer or invalid configuration
- `ESP_ERR_INVALID_STATE` This channel is not registered

*esp\_err\_t* **i2s\_channel\_reconfig\_std\_clock** (*i2s\_chan\_handle\_t* handle, const *i2s\_std\_clk\_config\_t* \*clk\_cfg)

Reconfigure the I2S clock for standard mode.

**备注:** Only allowed to be called when the channel state is READY, i.e., channel has been initialized, but not started. This function won't change the state. `i2s_channel_disable` should be called before calling this function if I2S has started.

**备注:** The input channel handle has to be initialized to standard mode, i.e., `i2s_channel_init_std_mode` has been called before reconfiguring.

### 参数

- **handle** -- **[in]** I2S channel handler
- **clk\_cfg** -- **[in]** Standard mode clock configuration, can be generated by `I2S_STD_CLK_DEFAULT_CONFIG`.

### 返回

- `ESP_OK` Set clock successfully
- `ESP_ERR_INVALID_ARG` NULL pointer, invalid configuration or not standard mode
- `ESP_ERR_INVALID_STATE` This channel is not initialized or not stopped

*esp\_err\_t* **i2s\_channel\_reconfig\_std\_slot** (*i2s\_chan\_handle\_t* handle, const *i2s\_std\_slot\_config\_t* \*slot\_cfg)

Reconfigure the I2S slot for standard mode.

**备注:** Only allowed to be called when the channel state is READY, i.e., channel has been initialized, but not started. This function won't change the state. `i2s_channel_disable` should be called before calling this function if I2S has started.

---

**备注:** The input channel handle has to be initialized to standard mode, i.e., `i2s_channel_init_std_mode` has been called before reconfiguring

---

**参数**

- **handle** -- [in] I2S channel handler
- **slot\_cfg** -- [in] Standard mode slot configuration, can be generated by `I2S_STD_PHILIPS_SLOT_DEFAULT_CONFIG`, `I2S_STD_PCM_SLOT_DEFAULT_CONFIG` and `I2S_STD_MSB_SLOT_DEFAULT_CONFIG`.

**返回**

- `ESP_OK` Set clock successfully
- `ESP_ERR_NO_MEM` No memory for DMA buffer
- `ESP_ERR_INVALID_ARG` NULL pointer, invalid configuration or not standard mode
- `ESP_ERR_INVALID_STATE` This channel is not initialized or not stopped

`esp_err_t i2s_channel_reconfig_std_gpio` (`i2s_chan_handle_t` handle, const `i2s_std_gpio_config_t` \*gpio\_cfg)

Reconfigure the I2S GPIO for standard mode.

---

**备注:** Only allowed to be called when the channel state is `READY`, i.e., channel has been initialized, but not started this function won't change the state. `i2s_channel_disable` should be called before calling this function if I2S has started.

---



---

**备注:** The input channel handle has to be initialized to standard mode, i.e., `i2s_channel_init_std_mode` has been called before reconfiguring

---

**参数**

- **handle** -- [in] I2S channel handler
- **gpio\_cfg** -- [in] Standard mode GPIO configuration, specified by user

**返回**

- `ESP_OK` Set clock successfully
- `ESP_ERR_INVALID_ARG` NULL pointer, invalid configuration or not standard mode
- `ESP_ERR_INVALID_STATE` This channel is not initialized or not stopped

**Structures**

struct `i2s_std_slot_config_t`

I2S slot configuration for standard mode.

**Public Members**

`i2s_data_bit_width_t data_bit_width`

I2S sample data bit width (valid data bits per sample)

`i2s_slot_bit_width_t slot_bit_width`

I2S slot bit width (total bits per slot)

`i2s_slot_mode_t slot_mode`

Set mono or stereo mode with `I2S_SLOT_MODE_MONO` or `I2S_SLOT_MODE_STEREO` In TX direction, mono means the written buffer contains only one slot data and stereo means the written buffer contains both left and right data

***i2s\_std\_slot\_mask\_t* slot\_mask**

Select the left, right or both slot

**uint32\_t ws\_width**

WS signal width (i.e. the number of BCLK ticks that WS signal is high)

**bool ws\_pol**

WS signal polarity, set true to enable high lever first

**bool bit\_shift**

Set to enable bit shift in Philips mode

**bool left\_align**

Set to enable left alignment

**bool big\_endian**

Set to enable big endian

**bool bit\_order\_lsb**

Set to enable lsb first

**struct i2s\_std\_clk\_config\_t**

I2S clock configuration for standard mode.

**Public Members****uint32\_t sample\_rate\_hz**

I2S sample rate

***i2s\_clock\_src\_t* clk\_src**

Choose clock source, see `soc_periph_i2s_clk_src_t` for the supported clock sources. selected `I2S_CLK_SRC_EXTERNAL` (if supports) to enable the external source clock input via MCLK pin,

**uint32\_t ext\_clk\_freq\_hz**

External clock source frequency in Hz, only take effect when `clk_src = I2S_CLK_SRC_EXTERNAL`, otherwise this field will be ignored, Please make sure the frequency input is equal or greater than BCLK, i.e. `sample_rate_hz * slot_bits * 2`

***i2s\_mclk\_multiple\_t* mclk\_multiple**

The multiple of MCLK to the sample rate Default is 256 in the helper macro, it can satisfy most of cases, but please set this field a multiple of 3 (like 384) when using 24-bit data width, otherwise the sample rate might be inaccurate

**struct i2s\_std\_gpio\_config\_t**

I2S standard mode GPIO pins configuration.

**Public Members**

`gpio_num_t mclk`

MCK pin, output by default, input if the clock source is selected to `I2S_CLK_SRC_EXTERNAL`

`gpio_num_t bclk`

BCK pin, input in slave role, output in master role

`gpio_num_t ws`

WS pin, input in slave role, output in master role

`gpio_num_t dout`

DATA pin, output

`gpio_num_t din`

DATA pin, input

`uint32_t mclk_inv`

Set 1 to invert the MCLK input/output

`uint32_t bclk_inv`

Set 1 to invert the BCLK input/output

`uint32_t ws_inv`

Set 1 to invert the WS input/output

struct `i2s_std_gpio_config_t`::[anonymous] `invert_flags`

GPIO pin invert flags

struct `i2s_std_config_t`

I2S standard mode major configuration that including clock/slot/GPIO configuration.

### Public Members

`i2s_std_clk_config_t` `clk_cfg`

Standard mode clock configuration, can be generated by macro `I2S_STD_CLK_DEFAULT_CONFIG`

`i2s_std_slot_config_t` `slot_cfg`

Standard mode slot configuration, can be generated by macros `I2S_STD_[mode]_SLOT_DEFAULT_CONFIG`, [mode] can be replaced with PHILIPS/MSB/PCM

`i2s_std_gpio_config_t` `gpio_cfg`

Standard mode GPIO configuration, specified by user

### Macros

`I2S_STD_PHILIPS_SLOT_DEFAULT_CONFIG` (bits\_per\_sample, mono\_or\_stereo)

Philips format in 2 slots.

This file is specified for I2S standard communication mode Features:

- Philips/MSB/PCM are supported in standard mode
- Fixed to 2 slots

**参数**

- **bits\_per\_sample** -- I2S data bit width
- **mono\_or\_stereo** -- I2S\_SLOT\_MODE\_MONO or I2S\_SLOT\_MODE\_STEREO

**I2S\_STD\_PCM\_SLOT\_DEFAULT\_CONFIG** (bits\_per\_sample, mono\_or\_stereo)

PCM(short) format in 2 slots.

---

备注: PCM(long) is same as Philips in 2 slots

---

**参数**

- **bits\_per\_sample** -- I2S data bit width
- **mono\_or\_stereo** -- I2S\_SLOT\_MODE\_MONO or I2S\_SLOT\_MODE\_STEREO

**I2S\_STD\_MSB\_SLOT\_DEFAULT\_CONFIG** (bits\_per\_sample, mono\_or\_stereo)

MSB format in 2 slots.

**参数**

- **bits\_per\_sample** -- I2S data bit width
- **mono\_or\_stereo** -- I2S\_SLOT\_MODE\_MONO or I2S\_SLOT\_MODE\_STEREO

**I2S\_STD\_CLK\_DEFAULT\_CONFIG** (rate)

I2S default standard clock configuration.

---

备注: Please set the mclk\_multiple to I2S\_MCLK\_MULTIPLE\_384 while using 24 bits data width. Otherwise the sample rate might be imprecise since the BCLK division is not a integer

---

**参数**

- **rate** -- sample rate

**PDM 模式****Header File**

- [components/esp\\_driver\\_i2s/include/driver/i2s\\_pdm.h](#)
- This header file can be included with:

```
#include "driver/i2s_pdm.h"
```

- This header file is a part of the API provided by the esp\_driver\_i2s component. To declare that your component depends on esp\_driver\_i2s, add the following to your CMakeLists.txt:

```
REQUIRES esp_driver_i2s
```

or

```
PRIV_REQUIRES esp_driver_i2s
```

**Functions**

**esp\_err\_t i2s\_channel\_init\_pdm\_tx\_mode** (*i2s\_chan\_handle\_t* handle, const *i2s\_pdm\_tx\_config\_t* \*pdm\_tx\_cfg)

Initialize I2S channel to PDM TX mode.



---

**备注:** Only allowed to be called when the channel state is REGISTERED, (i.e., channel has been allocated, but not initialized) and the state will be updated to READY if initialization success, otherwise the state will return to REGISTERED.

---

**参数**

- **handle** -- [in] I2S TX channel handler
- **pdm\_tx\_cfg** -- [in] Configurations for PDM TX mode, including clock, slot and GPIO The clock configuration can be generated by the helper macro `I2S_PDM_TX_CLK_DEFAULT_CONFIG` The slot configuration can be generated by the helper macro `I2S_PDM_TX_SLOT_DEFAULT_CONFIG`

**返回**

- `ESP_OK` Initialize successfully
- `ESP_ERR_NO_MEM` No memory for storing the channel information
- `ESP_ERR_INVALID_ARG` NULL pointer or invalid configuration
- `ESP_ERR_INVALID_STATE` This channel is not registered

`esp_err_t i2s_channel_reconfig_pdm_tx_clock` (`i2s_chan_handle_t` handle, const `i2s_pdm_tx_clk_config_t` \*clk\_cfg)

Reconfigure the I2S clock for PDM TX mode.

---

**备注:** Only allowed to be called when the channel state is READY, i.e., channel has been initialized, but not started this function won't change the state. `i2s_channel_disable` should be called before calling this function if I2S has started.

---



---

**备注:** The input channel handle has to be initialized to PDM TX mode, i.e., `i2s_channel_init_pdm_tx_mode` has been called before reconfiguring

---

**参数**

- **handle** -- [in] I2S TX channel handler
- **clk\_cfg** -- [in] PDM TX mode clock configuration, can be generated by `I2S_PDM_TX_CLK_DEFAULT_CONFIG`

**返回**

- `ESP_OK` Set clock successfully
- `ESP_ERR_INVALID_ARG` NULL pointer, invalid configuration or not PDM mode
- `ESP_ERR_INVALID_STATE` This channel is not initialized or not stopped

`esp_err_t i2s_channel_reconfig_pdm_tx_slot` (`i2s_chan_handle_t` handle, const `i2s_pdm_tx_slot_config_t` \*slot\_cfg)

Reconfigure the I2S slot for PDM TX mode.

---

**备注:** Only allowed to be called when the channel state is READY, i.e., channel has been initialized, but not started this function won't change the state. `i2s_channel_disable` should be called before calling this function if I2S has started.

---



---

**备注:** The input channel handle has to be initialized to PDM TX mode, i.e., `i2s_channel_init_pdm_tx_mode` has been called before reconfiguring

---

**参数**

- **handle** -- [in] I2S TX channel handler

- **slot\_cfg** -- [in] PDM TX mode slot configuration, can be generated by I2S\_PDM\_TX\_SLOT\_DEFAULT\_CONFIG

**返回**

- ESP\_OK Set clock successfully
- ESP\_ERR\_NO\_MEM No memory for DMA buffer
- ESP\_ERR\_INVALID\_ARG NULL pointer, invalid configuration or not PDM mode
- ESP\_ERR\_INVALID\_STATE This channel is not initialized or not stopped

*esp\_err\_t* **i2s\_channel\_reconfig\_pdm\_tx\_gpio** (*i2s\_chan\_handle\_t* handle, const *i2s\_pdm\_tx\_gpio\_config\_t* \*gpio\_cfg)

Reconfigure the I2S GPIO for PDM TX mode.

---

**备注:** Only allowed to be called when the channel state is READY, i.e., channel has been initialized, but not started this function won't change the state. `i2s_channel_disable` should be called before calling this function if I2S has started.

---



---

**备注:** The input channel handle has to be initialized to PDM TX mode, i.e., `i2s_channel_init_pdm_tx_mode` has been called before reconfiguring

---

**参数**

- **handle** -- [in] I2S TX channel handler
- **gpio\_cfg** -- [in] PDM TX mode GPIO configuration, specified by user

**返回**

- ESP\_OK Set clock successfully
- ESP\_ERR\_INVALID\_ARG NULL pointer, invalid configuration or not PDM mode
- ESP\_ERR\_INVALID\_STATE This channel is not initialized or not stopped

**Structures**

struct **i2s\_pdm\_tx\_slot\_config\_t**

I2S slot configuration for PDM TX mode.

**Public Members**

*i2s\_data\_bit\_width\_t* **data\_bit\_width**

I2S sample data bit width (valid data bits per sample), only support 16 bits for PDM mode

*i2s\_slot\_bit\_width\_t* **slot\_bit\_width**

I2S slot bit width (total bits per slot), only support 16 bits for PDM mode

*i2s\_slot\_mode\_t* **slot\_mode**

Set mono or stereo mode with I2S\_SLOT\_MODE\_MONO or I2S\_SLOT\_MODE\_STEREO For PDM TX mode, mono means the data buffer only contains one slot data, Stereo means the data buffer contains two slots data

uint32\_t **sd\_prescale**

Sigma-delta filter prescale

*i2s\_pdm\_sig\_scale\_t* **sd\_scale**

Sigma-delta filter scaling value

*i2s\_pdm\_sig\_scale\_t* **hp\_scale**

High pass filter scaling value

*i2s\_pdm\_sig\_scale\_t* **lp\_scale**

Low pass filter scaling value

*i2s\_pdm\_sig\_scale\_t* **sinc\_scale**

Sinc filter scaling value

*i2s\_pdm\_tx\_line\_mode\_t* **line\_mode**

PDM TX line mode, one-line codec, one-line dac, two-line dac mode can be selected

bool **hp\_en**

High pass filter enable

float **hp\_cut\_off\_freq\_hz**

High pass filter cut-off frequency, range 23.3Hz ~ 185Hz, see cut-off frequency sheet above

uint32\_t **sd\_dither**

Sigma-delta filter dither

uint32\_t **sd\_dither2**

Sigma-delta filter dither2

struct **i2s\_pdm\_tx\_clk\_config\_t**

I2S clock configuration for PDM TX mode.

### Public Members

uint32\_t **sample\_rate\_hz**

I2S sample rate, not suggest to exceed 48000 Hz, otherwise more glitches and noise may appear

*i2s\_clock\_src\_t* **clk\_src**

Choose clock source

*i2s\_mclk\_multiple\_t* **mclk\_multiple**

The multiple of MCLK to the sample rate

uint32\_t **up\_sample\_fp**

Up-sampling param fp

uint32\_t **up\_sample\_fs**

Up-sampling param fs, not allowed to be greater than 480

uint32\_t **bclk\_div**

The division from MCLK to BCLK. The minimum value is I2S\_PDM\_TX\_BCLK\_DIV\_MIN. It will be set to I2S\_PDM\_TX\_BCLK\_DIV\_MIN by default if it is smaller than I2S\_PDM\_TX\_BCLK\_DIV\_MIN

struct **i2s\_pdm\_tx\_gpio\_config\_t**

I2S PDM TX mode GPIO pins configuration.

### Public Members

gpio\_num\_t **clk**

PDM clk pin, output

gpio\_num\_t **dout**

DATA pin, output

gpio\_num\_t **dout2**

The second data pin for the DAC dual-line mode, only take effect when the line mode is I2S\_PDM\_TX\_TWO\_LINE\_DAC

uint32\_t **clk\_inv**

Set 1 to invert the clk output

struct *i2s\_pdm\_tx\_gpio\_config\_t*::[anonymous] **invert\_flags**

GPIO pin invert flags

struct **i2s\_pdm\_tx\_config\_t**

I2S PDM TX mode major configuration that including clock/slot/GPIO configuration.

### Public Members

*i2s\_pdm\_tx\_clk\_config\_t* **clk\_cfg**

PDM TX clock configurations, can be generated by macro I2S\_PDM\_TX\_CLK\_DEFAULT\_CONFIG

*i2s\_pdm\_tx\_slot\_config\_t* **slot\_cfg**

PDM TX slot configurations, can be generated by macro I2S\_PDM\_TX\_SLOT\_DEFAULT\_CONFIG

*i2s\_pdm\_tx\_gpio\_config\_t* **gpio\_cfg**

PDM TX GPIO configurations, specified by user

### Macros

**I2S\_PDM\_TX\_SLOT\_DEFAULT\_CONFIG** (bits\_per\_sample, mono\_or\_stereo)

PDM style in 2 slots(TX) for codec line mode.

This file is specified for I2S PDM communication mode Features:

- Only support PDM TX/RX mode
- Fixed to 2 slots
- Data bit width only support 16 bits

### 参数

- **bits\_per\_sample** -- I2S data bit width, only support 16 bits for PDM mode
- **mono\_or\_stereo** -- I2S\_SLOT\_MODE\_MONO or I2S\_SLOT\_MODE\_STEREO

**I2S\_PDM\_TX\_SLOT\_DAC\_DEFAULT\_CONFIG** (bits\_per\_sample, mono\_or\_stereo)

PDM style in 1 slots(TX) for DAC line mode.

---

**备注:** The noise might be different with different configurations, this macro provides a set of configurations that have relatively high SNR (Signal Noise Ratio), you can also adjust them to fit your case.

---

**参数**

- **bits\_per\_sample** -- I2S data bit width, only support 16 bits for PDM mode
- **mono\_or\_stereo** -- I2S\_SLOT\_MODE\_MONO or I2S\_SLOT\_MODE\_STEREO

**I2S\_PDM\_TX\_CLK\_DEFAULT\_CONFIG** (rate)

I2S default PDM TX clock configuration for codec line mode.

---

**备注:** TX PDM can only be set to the following two up-sampling rate configurations: 1: fp = 960, fs = sample\_rate\_hz / 100, in this case, Fpdm = 128\*48000 2: fp = 960, fs = 480, in this case, Fpdm = 128\*Fpcm = 128\*sample\_rate\_hz If the PDM receiver do not care the PDM serial clock, it's recommended set Fpdm = 128\*48000. Otherwise, the second configuration should be adopted.

---

**参数**

- **rate** -- sample rate (not suggest to exceed 48000 Hz, otherwise more glitches and noise may appear)

**I2S\_PDM\_TX\_CLK\_DAC\_DEFAULT\_CONFIG** (rate)

I2S default PDM TX clock configuration for DAC line mode.

---

**备注:** TX PDM can only be set to the following two up-sampling rate configurations: 1: fp = 960, fs = sample\_rate\_hz / 100, in this case, Fpdm = 128\*48000 2: fp = 960, fs = 480, in this case, Fpdm = 128\*Fpcm = 128\*sample\_rate\_hz If the PDM receiver do not care the PDM serial clock, it's recommended set Fpdm = 128\*48000. Otherwise, the second configuration should be adopted.

---



---

**备注:** The noise might be different with different configurations, this macro provides a set of configurations that have relatively high SNR (Signal Noise Ratio), you can also adjust them to fit your case.

---

**参数**

- **rate** -- sample rate (not suggest to exceed 48000 Hz, otherwise more glitches and noise may appear)

**TDM 模式****Header File**

- [components/esp\\_driver\\_i2s/include/driver/i2s\\_tdm.h](#)
- This header file can be included with:

```
#include "driver/i2s_tdm.h"
```

- This header file is a part of the API provided by the `esp_driver_i2s` component. To declare that your component depends on `esp_driver_i2s`, add the following to your CMakeLists.txt:

```
REQUIRES esp_driver_i2s
```

or

```
PRIV_REQUIRES esp_driver_i2s
```

## Functions

*esp\_err\_t* **i2s\_channel\_init\_tdm\_mode** (*i2s\_chan\_handle\_t* handle, const *i2s\_tdm\_config\_t* \*tdm\_cfg)

Initialize I2S channel to TDM mode.

**备注:** Only allowed to be called when the channel state is REGISTERED, (i.e., channel has been allocated, but not initialized) and the state will be updated to READY if initialization success, otherwise the state will return to REGISTERED.

### 参数

- **handle** -- **[in]** I2S channel handler
- **tdm\_cfg** -- **[in]** Configurations for TDM mode, including clock, slot and GPIO The clock configuration can be generated by the helper macro `I2S_TDM_CLK_DEFAULT_CONFIG` The slot configuration can be generated by the helper macro `I2S_TDM_PHILIPS_SLOT_DEFAULT_CONFIG`, `I2S_TDM_PCM_SHORT_SLOT_DEFAULT_CONFIG`, `I2S_TDM_PCM_LONG_SLOT_DEFAULT_CONFIG` or `I2S_TDM_MSB_SLOT_DEFAULT_CONFIG`

### 返回

- `ESP_OK` Initialize successfully
- `ESP_ERR_NO_MEM` No memory for storing the channel information
- `ESP_ERR_INVALID_ARG` NULL pointer or invalid configuration
- `ESP_ERR_INVALID_STATE` This channel is not registered

*esp\_err\_t* **i2s\_channel\_reconfig\_tdm\_clock** (*i2s\_chan\_handle\_t* handle, const *i2s\_tdm\_clk\_config\_t* \*clk\_cfg)

Reconfigure the I2S clock for TDM mode.

**备注:** Only allowed to be called when the channel state is READY, i.e., channel has been initialized, but not started this function won't change the state. `i2s_channel_disable` should be called before calling this function if I2S has started.

**备注:** The input channel handle has to be initialized to TDM mode, i.e., `i2s_channel_init_tdm_mode` has been called before reconfiguring

### 参数

- **handle** -- **[in]** I2S channel handler
- **clk\_cfg** -- **[in]** Standard mode clock configuration, can be generated by `I2S_TDM_CLK_DEFAULT_CONFIG`

### 返回

- `ESP_OK` Set clock successfully
- `ESP_ERR_INVALID_ARG` NULL pointer, invalid configuration or not TDM mode
- `ESP_ERR_INVALID_STATE` This channel is not initialized or not stopped

*esp\_err\_t* **i2s\_channel\_reconfig\_tdm\_slot** (*i2s\_chan\_handle\_t* handle, const *i2s\_tdm\_slot\_config\_t* \*slot\_cfg)

Reconfigure the I2S slot for TDM mode.

**备注:** Only allowed to be called when the channel state is READY, i.e., channel has been initialized, but not started this function won't change the state. `i2s_channel_disable` should be called before calling this

---

function if I2S has started.

---

**备注:** The input channel handle has to be initialized to TDM mode, i.e., `i2s_channel_init_tdm_mode` has been called before reconfiguring

---

#### 参数

- **handle** -- **[in]** I2S channel handler
- **slot\_cfg** -- **[in]** Standard mode slot configuration, can be generated by `I2S_TDM_PHILIPS_SLOT_DEFAULT_CONFIG`, `I2S_TDM_PCM_SHORT_SLOT_DEFAULT_CONFIG`, `I2S_TDM_PCM_LONG_SLOT_DEFAULT_CONFIG` or `I2S_TDM_MSB_SLOT_DEFAULT_CONFIG`.

#### 返回

- `ESP_OK` Set clock successfully
- `ESP_ERR_NO_MEM` No memory for DMA buffer
- `ESP_ERR_INVALID_ARG` NULL pointer, invalid configuration or not TDM mode
- `ESP_ERR_INVALID_STATE` This channel is not initialized or not stopped

`esp_err_t i2s_channel_reconfig_tdm_gpio` (`i2s_chan_handle_t` handle, `const i2s_tdm_gpio_config_t *gpio_cfg`)

Reconfigure the I2S GPIO for TDM mode.

---

**备注:** Only allowed to be called when the channel state is `READY`, i.e., channel has been initialized, but not started this function won't change the state. `i2s_channel_disable` should be called before calling this function if I2S has started.

---



---

**备注:** The input channel handle has to be initialized to TDM mode, i.e., `i2s_channel_init_tdm_mode` has been called before reconfiguring

---

#### 参数

- **handle** -- **[in]** I2S channel handler
- **gpio\_cfg** -- **[in]** Standard mode GPIO configuration, specified by user

#### 返回

- `ESP_OK` Set clock successfully
- `ESP_ERR_INVALID_ARG` NULL pointer, invalid configuration or not TDM mode
- `ESP_ERR_INVALID_STATE` This channel is not initialized or not stopped

## Structures

struct `i2s_tdm_slot_config_t`

I2S slot configuration for TDM mode.

## Public Members

`i2s_data_bit_width_t data_bit_width`

I2S sample data bit width (valid data bits per sample)

`i2s_slot_bit_width_t slot_bit_width`

I2S slot bit width (total bits per slot)

***i2s\_slot\_mode\_t* slot\_mode**

Set mono or stereo mode with I2S\_SLOT\_MODE\_MONO or I2S\_SLOT\_MODE\_STEREO

***i2s\_tdm\_slot\_mask\_t* slot\_mask**

Slot mask. Activating slots by setting 1 to corresponding bits. When the activated slots is not consecutive, those data in inactivated slots will be ignored

**uint32\_t ws\_width**

WS signal width (i.e. the number of BCLK ticks that WS signal is high)

**bool ws\_pol**

WS signal polarity, set true to enable high level first

**bool bit\_shift**

Set true to enable bit shift in Philips mode

**bool left\_align**

Set true to enable left alignment

**bool big\_endian**

Set true to enable big endian

**bool bit\_order\_lsb**

Set true to enable lsb first

**bool skip\_mask**

Set true to enable skip mask. If it is enabled, only the data of the enabled channels will be sent, otherwise all data stored in DMA TX buffer will be sent

**uint32\_t total\_slot**

I2S total number of slots. If it is smaller than the biggest activated channel number, it will be set to this number automatically.

**struct i2s\_tdm\_clk\_config\_t**

I2S clock configuration for TDM mode.

**Public Members****uint32\_t sample\_rate\_hz**

I2S sample rate

***i2s\_clock\_src\_t* clk\_src**

Choose clock source, see `soc_periph_i2s_clk_src_t` for the supported clock sources. selected `I2S_CLK_SRC_EXTERNAL` (if supports) to enable the external source clock inputted via MCLK pin, please make sure the frequency inputted is equal or greater than `sample_rate_hz * mclk_multiple`

**uint32\_t ext\_clk\_freq\_hz**



External clock source frequency in Hz, only take effect when `clk_src = I2S_CLK_SRC_EXTERNAL`, otherwise this field will be ignored Please make sure the frequency inputted is equal or greater than BCLK, i.e. `sample_rate_hz * slot_bits * slot_num`

#### *i2s\_mclk\_multiple\_t* **mclk\_multiple**

The multiple of MCLK to the sample rate, only take effect for master role

#### `uint32_t` **bclk\_div**

The division from MCLK to BCLK, only take effect for slave role, it shouldn't be smaller than 8. Increase this field when data sent by slave lag behind

#### struct **i2s\_tdm\_gpio\_config\_t**

I2S TDM mode GPIO pins configuration.

### **Public Members**

#### `gpio_num_t` **mclk**

MCK pin, output by default, input if the clock source is selected to `I2S_CLK_SRC_EXTERNAL`

#### `gpio_num_t` **bclk**

BCK pin, input in slave role, output in master role

#### `gpio_num_t` **ws**

WS pin, input in slave role, output in master role

#### `gpio_num_t` **dout**

DATA pin, output

#### `gpio_num_t` **din**

DATA pin, input

#### `uint32_t` **mclk\_inv**

Set 1 to invert the MCLK input/output

#### `uint32_t` **bclk\_inv**

Set 1 to invert the BCLK input/output

#### `uint32_t` **ws\_inv**

Set 1 to invert the WS input/output

#### struct *i2s\_tdm\_gpio\_config\_t*::[anonymous] **invert\_flags**

GPIO pin invert flags

#### struct **i2s\_tdm\_config\_t**

I2S TDM mode major configuration that including clock/slot/GPIO configuration.

## Public Members

### *i2s\_tdm\_clk\_config\_t* **clk\_cfg**

TDM mode clock configuration, can be generated by macro I2S\_TDM\_CLK\_DEFAULT\_CONFIG

### *i2s\_tdm\_slot\_config\_t* **slot\_cfg**

TDM mode slot configuration, can be generated by macros I2S\_TDM\_[mode]\_SLOT\_DEFAULT\_CONFIG, [mode] can be replaced with PHILIPS/MSB/PCM\_SHORT/PCM\_LONG

### *i2s\_tdm\_gpio\_config\_t* **gpio\_cfg**

TDM mode GPIO configuration, specified by user

## Macros

### **I2S\_TDM\_AUTO\_SLOT\_NUM**

This file is specified for I2S TDM communication mode Features:

- More than 2 slots

### **I2S\_TDM\_AUTO\_WS\_WIDTH**

### **I2S\_TDM\_PHILIPS\_SLOT\_DEFAULT\_CONFIG** (bits\_per\_sample, mono\_or\_stereo, mask)

Philips format in active slot that enabled by mask.

#### 参数

- **bits\_per\_sample** -- I2S data bit width
- **mono\_or\_stereo** -- I2S\_SLOT\_MODE\_MONO or I2S\_SLOT\_MODE\_STEREO
- **mask** -- active slot mask

### **I2S\_TDM\_MSB\_SLOT\_DEFAULT\_CONFIG** (bits\_per\_sample, mono\_or\_stereo, mask)

MSB format in active slot enabled that by mask.

#### 参数

- **bits\_per\_sample** -- I2S data bit width
- **mono\_or\_stereo** -- I2S\_SLOT\_MODE\_MONO or I2S\_SLOT\_MODE\_STEREO
- **mask** -- active slot mask

### **I2S\_TDM\_PCM\_SHORT\_SLOT\_DEFAULT\_CONFIG** (bits\_per\_sample, mono\_or\_stereo, mask)

PCM(short) format in active slot that enabled by mask.

#### 参数

- **bits\_per\_sample** -- I2S data bit width
- **mono\_or\_stereo** -- I2S\_SLOT\_MODE\_MONO or I2S\_SLOT\_MODE\_STEREO
- **mask** -- active slot mask

### **I2S\_TDM\_PCM\_LONG\_SLOT\_DEFAULT\_CONFIG** (bits\_per\_sample, mono\_or\_stereo, mask)

PCM(long) format in active slot that enabled by mask.

#### 参数

- **bits\_per\_sample** -- I2S data bit width
- **mono\_or\_stereo** -- I2S\_SLOT\_MODE\_MONO or I2S\_SLOT\_MODE\_STEREO
- **mask** -- active slot mask

### **I2S\_TDM\_CLK\_DEFAULT\_CONFIG** (rate)

I2S default TDM clock configuration.

---

**备注:** Please set the mclk\_multiple to I2S\_MCLK\_MULTIPLE\_384 while the data width in slot configuration is set to 24 bits Otherwise the sample rate might be imprecise since the BCLK division is not a integer

---

**参数**

- **rate** -- sample rate

**I2S 驱动****Header File**

- [components/esp\\_driver\\_i2s/include/driver/i2s\\_common.h](#)
- This header file can be included with:

```
#include "driver/i2s_common.h"
```

- This header file is a part of the API provided by the `esp_driver_i2s` component. To declare that your component depends on `esp_driver_i2s`, add the following to your `CMakeLists.txt`:

```
REQUIRES esp_driver_i2s
```

or

```
PRIV_REQUIRES esp_driver_i2s
```

**Functions**

`esp_err_t i2s_new_channel` (const `i2s_chan_config_t` \*chan\_cfg, `i2s_chan_handle_t` \*ret\_tx\_handle, `i2s_chan_handle_t` \*ret\_rx\_handle)

Allocate new I2S channel(s)

---

**备注:** The new created I2S channel handle will be REGISTERED state after it is allocated successfully.

---



---

**备注:** When the port id in channel configuration is I2S\_NUM\_AUTO, driver will allocate I2S port automatically on one of the I2S controller, otherwise driver will try to allocate the new channel on the selected port.

---



---

**备注:** If both tx\_handle and rx\_handle are not NULL, it means this I2S controller will work at full-duplex mode, the RX and TX channels will be allocated on a same I2S port in this case. Note that some configurations of TX/RX channel are shared on ESP32 and ESP32S2, so please make sure they are working at same condition and under same status(start/stop). Currently, full-duplex mode can't guarantee TX/RX channels write/read synchronously, they can only share the clock signals for now.

---



---

**备注:** If tx\_handle OR rx\_handle is NULL, it means this I2S controller will work at simplex mode. For ESP32 and ESP32S2, the whole I2S controller (i.e. both RX and TX channel) will be occupied, even if only one of RX or TX channel is registered. For the other targets, another channel on this controller will still available.

---

**参数**

- **chan\_cfg** -- [in] I2S controller channel configurations
- **ret\_tx\_handle** -- [out] I2S channel handler used for managing the sending channel(optional)
- **ret\_rx\_handle** -- [out] I2S channel handler used for managing the receiving channel(optional)

**返回**

- ESP\_OK Allocate new channel(s) success
- ESP\_ERR\_NOT\_SUPPORTED The communication mode is not supported on the current chip

- ESP\_ERR\_INVALID\_ARG NULL pointer or illegal parameter in *i2s\_chan\_config\_t*
- ESP\_ERR\_NOT\_FOUND No available I2S channel found

*esp\_err\_t* **i2s\_del\_channel** (*i2s\_chan\_handle\_t* handle)

Delete the I2S channel.

---

**备注:** Only allowed to be called when the I2S channel is at REGISTERED or READY state (i.e., it should stop before deleting it).

---



---

**备注:** Resource will be free automatically if all channels in one port are deleted

---

**参数** **handle** -- [in] I2S channel handler

- ESP\_OK Delete successfully
- ESP\_ERR\_INVALID\_ARG NULL pointer

*esp\_err\_t* **i2s\_channel\_get\_info** (*i2s\_chan\_handle\_t* handle, *i2s\_chan\_info\_t* \*chan\_info)

Get I2S channel information.

**参数**

- **handle** -- [in] I2S channel handler
- **chan\_info** -- [out] I2S channel basic information

**返回**

- ESP\_OK Get I2S channel information success
- ESP\_ERR\_NOT\_FOUND The input handle doesn't match any registered I2S channels, it may not an I2S channel handle or not available any more
- ESP\_ERR\_INVALID\_ARG The input handle or chan\_info pointer is NULL

*esp\_err\_t* **i2s\_channel\_enable** (*i2s\_chan\_handle\_t* handle)

Enable the I2S channel.

---

**备注:** Only allowed to be called when the channel state is READY, (i.e., channel has been initialized, but not started) the channel will enter RUNNING state once it is enabled successfully.

---



---

**备注:** Enable the channel can start the I2S communication on hardware. It will start outputting BCLK and WS signal. For MCLK signal, it will start to output when initialization is finished

---

**参数** **handle** -- [in] I2S channel handler

- ESP\_OK Start successfully
- ESP\_ERR\_INVALID\_ARG NULL pointer
- ESP\_ERR\_INVALID\_STATE This channel has not initialized or already started

*esp\_err\_t* **i2s\_channel\_disable** (*i2s\_chan\_handle\_t* handle)

Disable the I2S channel.

---

**备注:** Only allowed to be called when the channel state is RUNNING, (i.e., channel has been started) the channel will enter READY state once it is disabled successfully.

---



---

**备注:** Disable the channel can stop the I2S communication on hardware. It will stop BCLK and WS signal but not MCLK signal

---

参数 **handle** -- [in] I2S channel handler

返回

- ESP\_OK Stop successfully
- ESP\_ERR\_INVALID\_ARG NULL pointer
- ESP\_ERR\_INVALID\_STATE This channel has not started

*esp\_err\_t* **i2s\_channel\_preload\_data** (*i2s\_chan\_handle\_t* tx\_handle, const void \*src, size\_t size, size\_t \*bytes\_loaded)

Preload the data into TX DMA buffer.

---

**备注:** Only allowed to be called when the channel state is READY, (i.e., channel has been initialized, but not started)

---



---

**备注:** As the initial DMA buffer has no data inside, it will transmit the empty buffer after enabled the channel, this function is used to preload the data into the DMA buffer, so that the valid data can be transmitted immediately after the channel is enabled.

---



---

**备注:** This function can be called multiple times before enabling the channel, the buffer that loaded later will be concatenated behind the former loaded buffer. But when all the DMA buffers have been loaded, no more data can be preload then, please check the `bytes_loaded` parameter to see how many bytes are loaded successfully, when the `bytes_loaded` is smaller than the `size`, it means the DMA buffers are full.

---

参数

- **tx\_handle** -- [in] I2S TX channel handler
- **src** -- [in] The pointer of the source buffer to be loaded
- **size** -- [in] The source buffer size
- **bytes\_loaded** -- [out] The bytes that successfully been loaded into the TX DMA buffer

返回

- ESP\_OK Load data successful
- ESP\_ERR\_INVALID\_ARG NULL pointer or not TX direction
- ESP\_ERR\_INVALID\_STATE This channel has not started

*esp\_err\_t* **i2s\_channel\_write** (*i2s\_chan\_handle\_t* handle, const void \*src, size\_t size, size\_t \*bytes\_written, uint32\_t timeout\_ms)

I2S write data.

---

**备注:** Only allowed to be called when the channel state is RUNNING, (i.e., TX channel has been started and is not writing now) but the RUNNING only stands for the software state, it doesn't mean there is no the signal transporting on line.

---

参数

- **handle** -- [in] I2S channel handler
- **src** -- [in] The pointer of sent data buffer
- **size** -- [in] Max data buffer length
- **bytes\_written** -- [out] Byte number that actually be sent, can be NULL if not needed
- **timeout\_ms** -- [in] Max block time

返回

- ESP\_OK Write successfully
- ESP\_ERR\_INVALID\_ARG NULL pointer or this handle is not TX handle
- ESP\_ERR\_TIMEOUT Writing timeout, no writing event received from ISR within ticks\_to\_wait

- ESP\_ERR\_INVALID\_STATE I2S is not ready to write

`esp_err_t i2s_channel_read` (*i2s\_chan\_handle\_t* handle, void \*dest, size\_t size, size\_t \*bytes\_read, uint32\_t timeout\_ms)

I2S read data.

---

**备注:** Only allowed to be called when the channel state is RUNNING but the RUNNING only stands for the software state, it doesn't mean there is no the signal transporting on line.

---

#### 参数

- **handle** -- [in] I2S channel handler
- **dest** -- [in] The pointer of receiving data buffer
- **size** -- [in] Max data buffer length
- **bytes\_read** -- [out] Byte number that actually be read, can be NULL if not needed
- **timeout\_ms** -- [in] Max block time

#### 返回

- ESP\_OK Read successfully
- ESP\_ERR\_INVALID\_ARG NULL pointer or this handle is not RX handle
- ESP\_ERR\_TIMEOUT Reading timeout, no reading event received from ISR within ticks\_to\_wait
- ESP\_ERR\_INVALID\_STATE I2S is not ready to read

`esp_err_t i2s_channel_register_event_callback` (*i2s\_chan\_handle\_t* handle, const *i2s\_event\_callbacks\_t* \*callbacks, void \*user\_data)

Set event callbacks for I2S channel.

---

**备注:** Only allowed to be called when the channel state is REGISTERED / READY, (i.e., before channel starts)

---



---

**备注:** User can deregister a previously registered callback by calling this function and setting the callback member in the `callbacks` structure to NULL.

---



---

**备注:** When CONFIG\_I2S\_ISR\_IRAM\_SAFE is enabled, the callback itself and functions called by it should be placed in IRAM. The variables used in the function should be in the SRAM as well. The `user_data` should also reside in SRAM or internal RAM as well.

---

#### 参数

- **handle** -- [in] I2S channel handler
- **callbacks** -- [in] Group of callback functions
- **user\_data** -- [in] User data, which will be passed to callback functions directly

#### 返回

- ESP\_OK Set event callbacks successfully
- ESP\_ERR\_INVALID\_ARG Set event callbacks failed because of invalid argument
- ESP\_ERR\_INVALID\_STATE Set event callbacks failed because the current channel state is not REGISTERED or READY

## Structures

struct `i2s_event_callbacks_t`

Group of I2S callbacks.

---

**备注:** The callbacks are all running under ISR environment

---

---

**备注:** When CONFIG\_I2S\_ISR\_IRAM\_SAFE is enabled, the callback itself and functions called by it should be placed in IRAM. The variables used in the function should be in the SRAM as well.

---

### Public Members

#### *i2s\_isr\_callback\_t* **on\_recv**

Callback of data received event, only for RX channel The event data includes DMA buffer address and size that just finished receiving data

#### *i2s\_isr\_callback\_t* **on\_recv\_q\_ovf**

Callback of receiving queue overflowed event, only for RX channel The event data includes buffer size that has been overwritten

#### *i2s\_isr\_callback\_t* **on\_sent**

Callback of data sent event, only for TX channel The event data includes DMA buffer address and size that just finished sending data

#### *i2s\_isr\_callback\_t* **on\_send\_q\_ovf**

Callback of sending queue overflowed event, only for TX channel The event data includes buffer size that has been overwritten

struct **i2s\_chan\_config\_t**

I2S controller channel configuration.

### Public Members

#### *i2s\_port\_t* **id**

I2S port id

#### *i2s\_role\_t* **role**

I2S role, I2S\_ROLE\_MASTER or I2S\_ROLE\_SLAVE

#### uint32\_t **dma\_desc\_num**

I2S DMA buffer number, it is also the number of DMA descriptor

#### uint32\_t **dma\_frame\_num**

I2S frame number in one DMA buffer. One frame means one-time sample data in all slots, it should be the multiple of 3 when the data bit width is 24.

#### bool **auto\_clear**

Alias of auto\_clear\_after\_cb

bool **auto\_clear\_after\_cb**

Set to auto clear DMA TX buffer after `on_sent` callback, I2S will always send zero automatically if no data to send. So that user can assign the data to the DMA buffers directly in the callback, and the data won't be cleared after quit the callback.

bool **auto\_clear\_before\_cb**

Set to auto clear DMA TX buffer before `on_sent` callback, I2S will always send zero automatically if no data to send So that user can access data in the callback that just finished to send.

int **intr\_priority**

I2S interrupt priority, range [0, 7], if set to 0, the driver will try to allocate an interrupt with a relative low priority (1,2,3)

struct **i2s\_chan\_info\_t**

I2S channel information.

### Public Members

*i2s\_port\_t* **id**

I2S port id

*i2s\_role\_t* **role**

I2S role, I2S\_ROLE\_MASTER or I2S\_ROLE\_SLAVE

*i2s\_dir\_t* **dir**

I2S channel direction

*i2s\_comm\_mode\_t* **mode**

I2S channel communication mode

*i2s\_chan\_handle\_t* **pair\_chan**

I2S pair channel handle in duplex mode, always NULL in simplex mode

uint32\_t **total\_dma\_buf\_size**

Total size of all the allocated DMA buffers

- 0 if the channel has not been initialized
- non-zero if the channel has been initialized

### Macros

**I2S\_CHANNEL\_DEFAULT\_CONFIG** (*i2s\_num*, *i2s\_role*)

get default I2S property

**I2S\_GPIO\_UNUSED**

Used in `i2s_gpio_config_t` for signals which are not used

### I2S 类型



## Header File

- `components/esp_driver_i2s/include/driver/i2s_types.h`
- This header file can be included with:

```
#include "driver/i2s_types.h"
```

- This header file is a part of the API provided by the `esp_driver_i2s` component. To declare that your component depends on `esp_driver_i2s`, add the following to your `CMakeLists.txt`:

```
REQUIRES esp_driver_i2s
```

or

```
PRIV_REQUIRES esp_driver_i2s
```

## Structures

struct `i2s_event_data_t`

Event structure used in I2S event queue.

### Public Members

void `*data`

(Deprecated) The secondary pointer of DMA buffer that just finished sending or receiving for `on_recv` and `on_sent` callback NULL for `on_recv_q_ovf` and `on_send_q_ovf` callback

void `*dma_buf`

The first level pointer of DMA buffer that just finished sending or receiving for `on_recv` and `on_sent` callback NULL for `on_recv_q_ovf` and `on_send_q_ovf` callback

size\_t `size`

The buffer size of DMA buffer when success to send or receive, also the buffer size that dropped when queue overflow. It is related to the `dma_frame_num` and `data_bit_width`, typically it is fixed when `data_bit_width` is not changed.

## Type Definitions

typedef struct `i2s_channel_obj_t` `*i2s_chan_handle_t`

I2S channel object handle, the control unit of the I2S driver

typedef bool (`*i2s_isr_callback_t`)(`i2s_chan_handle_t` handle, `i2s_event_data_t` \*event, void \*user\_ctx)

I2S event callback.

**Param handle [in]** I2S channel handle, created from `i2s_new_channel()`

**Param event [in]** I2S event data

**Param user\_ctx [in]** User registered context, passed from `i2s_channel_register_event_callback()`

**Return** Whether a high priority task has been waken up by this callback function

## Enumerations

enum `i2s_port_t`

I2S controller port number, the max port number is `(SOC_I2S_NUM - 1)`.

*Values:*

enumerator **I2S\_NUM\_0**

I2S controller port 0

enumerator **I2S\_NUM\_AUTO**

Select whichever port is available

enum **i2s\_comm\_mode\_t**

I2S controller communication mode.

*Values:*

enumerator **I2S\_COMM\_MODE\_STD**

I2S controller using standard communication mode, support Philips/MSB/PCM format

enumerator **I2S\_COMM\_MODE\_PDM**

I2S controller using PDM communication mode, support PDM output or input

enumerator **I2S\_COMM\_MODE\_TDM**

I2S controller using TDM communication mode, support up to 16 slots per frame

enumerator **I2S\_COMM\_MODE\_NONE**

Unspecified I2S controller mode

enum **i2s\_mclk\_multiple\_t**

The multiple of MCLK to sample rate.

---

**备注:** MCLK is the minimum resolution of the I2S clock. Increasing mclk multiple can reduce the clock jitter of BCLK and WS, which is also useful for the codec that don't require MCLK but have strict requirement to BCLK. For the 24-bit slot width, please choose a multiple that can be divided by 3 (i.e. 24-bit compatible).

---

*Values:*

enumerator **I2S\_MCLK\_MULTIPLE\_128**

$MCLK = sample\_rate * 128$

enumerator **I2S\_MCLK\_MULTIPLE\_192**

$MCLK = sample\_rate * 192$  (24-bit compatible)

enumerator **I2S\_MCLK\_MULTIPLE\_256**

$MCLK = sample\_rate * 256$

enumerator **I2S\_MCLK\_MULTIPLE\_384**

$MCLK = sample\_rate * 384$  (24-bit compatible)

enumerator **I2S\_MCLK\_MULTIPLE\_512**

$MCLK = sample\_rate * 512$

enumerator **I2S\_MCLK\_MULTIPLE\_576**

$MCLK = sample\_rate * 576$  (24-bit compatible)

enumerator **I2S\_MCLK\_MULTIPLE\_768**  
MCLK = sample\_rate \* 768 (24-bit compatible)

enumerator **I2S\_MCLK\_MULTIPLE\_1024**  
MCLK = sample\_rate \* 1024

enumerator **I2S\_MCLK\_MULTIPLE\_1152**  
MCLK = sample\_rate \* 1152 (24-bit compatible)

### Header File

- [components/hal/include/hal/i2s\\_types.h](#)
- This header file can be included with:

```
#include "hal/i2s_types.h"
```

### Type Definitions

typedef *soc\_periph\_i2s\_clk\_src\_t* **i2s\_clock\_src\_t**  
I2S clock source

### Enumerations

enum **i2s\_slot\_mode\_t**  
I2S channel slot mode.

*Values:*

enumerator **I2S\_SLOT\_MODE\_MONO**  
I2S channel slot format mono, transmit same data in all slots for tx mode, only receive the data in the first slots for rx mode.

enumerator **I2S\_SLOT\_MODE\_STEREO**  
I2S channel slot format stereo, transmit different data in different slots for tx mode, receive the data in all slots for rx mode.

enum **i2s\_dir\_t**  
I2S channel direction.

*Values:*

enumerator **I2S\_DIR\_RX**  
I2S channel direction RX

enumerator **I2S\_DIR\_TX**  
I2S channel direction TX

enum **i2s\_role\_t**  
I2S controller role.  
*Values:*

enumerator **I2S\_ROLE\_MASTER**

I2S controller master role, bclk and ws signal will be set to output

enumerator **I2S\_ROLE\_SLAVE**

I2S controller slave role, bclk and ws signal will be set to input

enum **i2s\_data\_bit\_width\_t**

Available data bit width in one slot.

*Values:*

enumerator **I2S\_DATA\_BIT\_WIDTH\_8BIT**

I2S channel data bit-width: 8

enumerator **I2S\_DATA\_BIT\_WIDTH\_16BIT**

I2S channel data bit-width: 16

enumerator **I2S\_DATA\_BIT\_WIDTH\_24BIT**

I2S channel data bit-width: 24

enumerator **I2S\_DATA\_BIT\_WIDTH\_32BIT**

I2S channel data bit-width: 32

enum **i2s\_slot\_bit\_width\_t**

Total slot bit width in one slot.

*Values:*

enumerator **I2S\_SLOT\_BIT\_WIDTH\_AUTO**

I2S channel slot bit-width equals to data bit-width

enumerator **I2S\_SLOT\_BIT\_WIDTH\_8BIT**

I2S channel slot bit-width: 8

enumerator **I2S\_SLOT\_BIT\_WIDTH\_16BIT**

I2S channel slot bit-width: 16

enumerator **I2S\_SLOT\_BIT\_WIDTH\_24BIT**

I2S channel slot bit-width: 24

enumerator **I2S\_SLOT\_BIT\_WIDTH\_32BIT**

I2S channel slot bit-width: 32

enum **i2s\_pcm\_compress\_t**

A/U-law decompress or compress configuration.

*Values:*

enumerator **I2S\_PCM\_DISABLE**

Disable A/U law decompress or compress

enumerator **I2S\_PCM\_A\_DECOMPRESS**

A-law decompress

enumerator **I2S\_PCM\_A\_COMPRESS**

A-law compress

enumerator **I2S\_PCM\_U\_DECOMPRESS**

U-law decompress

enumerator **I2S\_PCM\_U\_COMPRESS**

U-law compress

enum **i2s\_pdm\_sig\_scale\_t**

pdm tx signal scaling mode

*Values:*

enumerator **I2S\_PDM\_SIG\_SCALING\_DIV\_2**

I2S TX PDM signal scaling: /2

enumerator **I2S\_PDM\_SIG\_SCALING\_MUL\_1**

I2S TX PDM signal scaling: x1

enumerator **I2S\_PDM\_SIG\_SCALING\_MUL\_2**

I2S TX PDM signal scaling: x2

enumerator **I2S\_PDM\_SIG\_SCALING\_MUL\_4**

I2S TX PDM signal scaling: x4

enum **i2s\_pdm\_tx\_line\_mode\_t**

PDM TX line mode.

---

**备注:** For the standard codec mode, PDM pins are connect to a codec which requires both clock signal and data signal For the DAC output mode, PDM data signal can be connected to a power amplifier directly with a low-pass filter, normally, DAC output mode doesn't need the clock signal.

---

*Values:*

enumerator **I2S\_PDM\_TX\_ONE\_LINE\_CODEC**

Standard PDM format output, left and right slot data on a single line

enumerator **I2S\_PDM\_TX\_ONE\_LINE\_DAC**

PDM DAC format output, left or right slot data on a single line

enumerator **I2S\_PDM\_TX\_TWO\_LINE\_DAC**

PDM DAC format output, left and right slot data on separated lines

enum **i2s\_std\_slot\_mask\_t**

I2S slot select in standard mode.

---

**备注:** It has different meanings in tx/rx/mono/stereo mode, and it may have different behaviors on different targets. For the details, please refer to the I2S API reference.

---

*Values:*

enumerator **I2S\_STD\_SLOT\_LEFT**

I2S transmits or receives left slot

enumerator **I2S\_STD\_SLOT\_RIGHT**

I2S transmits or receives right slot

enumerator **I2S\_STD\_SLOT\_BOTH**

I2S transmits or receives both left and right slot

enum **i2s\_pdm\_slot\_mask\_t**

I2S slot select in PDM mode.

*Values:*

enumerator **I2S\_PDM\_SLOT\_RIGHT**

I2S PDM only transmits or receives the PDM device whose 'select' pin is pulled up

enumerator **I2S\_PDM\_SLOT\_LEFT**

I2S PDM only transmits or receives the PDM device whose 'select' pin is pulled down

enumerator **I2S\_PDM\_SLOT\_BOTH**

I2S PDM transmits or receives both two slots

enum **i2s\_tdm\_slot\_mask\_t**

tdm slot number

---

**备注:** Multiple slots in TDM mode. For TX module, only the active slot send the audio data, the inactive slot send a constant or will be skipped if 'skip\_msk' is set. For RX module, only receive the audio data in active slots, the data in inactive slots will be ignored. the bit map of active slot can not exceed (0x1«total\_slot\_num). e.g: slot\_mask = (I2S\_TDM\_SLOT0 | I2S\_TDM\_SLOT3), here the active slot number is 2 and total\_slot is not supposed to be smaller than 4.

---

*Values:*

enumerator **I2S\_TDM\_SLOT0**

I2S slot 0 enabled

enumerator **I2S\_TDM\_SLOT1**

I2S slot 1 enabled

enumerator **I2S\_TDM\_SLOT2**

I2S slot 2 enabled

enumerator **I2S\_TDM\_SLOT3**

I2S slot 3 enabled

enumerator **I2S\_TDM\_SLOT4**

I2S slot 4 enabled

enumerator **I2S\_TDM\_SLOT5**

I2S slot 5 enabled

enumerator **I2S\_TDM\_SLOT6**

I2S slot 6 enabled

enumerator **I2S\_TDM\_SLOT7**

I2S slot 7 enabled

enumerator **I2S\_TDM\_SLOT8**

I2S slot 8 enabled

enumerator **I2S\_TDM\_SLOT9**

I2S slot 9 enabled

enumerator **I2S\_TDM\_SLOT10**

I2S slot 10 enabled

enumerator **I2S\_TDM\_SLOT11**

I2S slot 11 enabled

enumerator **I2S\_TDM\_SLOT12**

I2S slot 12 enabled

enumerator **I2S\_TDM\_SLOT13**

I2S slot 13 enabled

enumerator **I2S\_TDM\_SLOT14**

I2S slot 14 enabled

enumerator **I2S\_TDM\_SLOT15**

I2S slot 15 enabled

## 2.6.15 LCD

### Introduction

ESP chips can generate various kinds of timings needed by common LCDs on the market, like SPI LCD, I2C LCD, Parallel LCD (Intel 8080), RGB/SRGB LCD, MIPI DSI LCD and etc. The `esp_lcd` component offers an abstracted driver framework to support them in a unified way.

An LCD typically consists of two main planes:

- **Control Plane:** This plane allows us to read and write to the internal registers of the LCD device controller. Host typically uses this plane for tasks such as initializing the LCD power supply and performing gamma calibration.
- **Data Plane:** The data plane is responsible for transmitting pixel data to the LCD device.

## Functional Overview

In the context of `esp_lcd`, both the data plane and the control plane are represented by the `esp_lcd_panel_handle_t` type.

On some LCDs, these two planes may be combined into a single plane. In this configuration, pixel data is transmitted through the control plane, achieving functionality similar to that of the data plane. This merging is common in SPI LCDs and I2C LCDs. Additionally, there are LCDs that do not require a separate control plane. For instance, certain RGB LCDs automatically execute necessary initialization procedures after power-up. Host devices only need to continuously refresh pixel data through the data plane. However, it's essential to note that not all RGB LCDs eliminate the control plane entirely. Some LCD devices can simultaneously support multiple interfaces, requiring the host to send specific commands via the control plane (such as those based on the SPI interface) to enable the RGB mode.

This document will discuss how to create the control plane and data plane, as mentioned earlier, based on different types of LCDs.

## SPI Interfaced LCD

1. Create an SPI bus. Please refer to *SPI Master API doc* for more details.

```
spi_bus_config_t buscfg = {
    .sclk_io_num = EXAMPLE_PIN_NUM_SCLK,
    .mosi_io_num = EXAMPLE_PIN_NUM_MOSI,
    .miso_io_num = EXAMPLE_PIN_NUM_MISO,
    .quadwp_io_num = -1, // Quad SPI LCD driver is not yet supported
    .quadhd_io_num = -1, // Quad SPI LCD driver is not yet supported
    .max_transfer_sz = EXAMPLE_LCD_H_RES * 80 * sizeof(uint16_t), //
    ↪transfer 80 lines of pixels (assume pixel is RGB565) at most in one
    ↪SPI transaction
};
ESP_ERROR_CHECK(spi_bus_initialize(LCD_HOST, &buscfg, SPI_DMA_CH_
    ↪AUTO)); // Enable the DMA feature
```

2. Allocate an LCD IO device handle from the SPI bus. In this step, you need to provide the following information:

- `esp_lcd_panel_io_spi_config_t::dc_gpio_num`: Sets the gpio number for the DC signal line (some LCD calls this RS line). The LCD driver uses this GPIO to switch between sending command and sending data.
- `esp_lcd_panel_io_spi_config_t::cs_gpio_num`: Sets the gpio number for the CS signal line. The LCD driver uses this GPIO to select the LCD chip. If the SPI bus only has one device attached (i.e., this LCD), you can set the gpio number to `-1` to occupy the bus exclusively.
- `esp_lcd_panel_io_spi_config_t::pclk_hz` sets the frequency of the pixel clock, in Hz. The value should not exceed the range recommended in the LCD spec.
- `esp_lcd_panel_io_spi_config_t::spi_mode` sets the SPI mode. The LCD driver uses this mode to communicate with the LCD. For the meaning of the SPI mode, please refer to the *SPI Master API doc*.
- `esp_lcd_panel_io_spi_config_t::lcd_cmd_bits` and `esp_lcd_panel_io_spi_config_t::lcd_param_bits` set the bit width of the command and parameter that recognized by the LCD controller chip. This is chip specific, you should refer to your LCD spec in advance.
- `esp_lcd_panel_io_spi_config_t::trans_queue_depth` sets the depth of the SPI transaction queue. A bigger value means more transactions can be queued up, but it also consumes more memory.

```
esp_lcd_panel_io_handle_t io_handle = NULL;
esp_lcd_panel_io_spi_config_t io_config = {
    .dc_gpio_num = EXAMPLE_PIN_NUM_LCD_DC,
    .cs_gpio_num = EXAMPLE_PIN_NUM_LCD_CS,
    .pclk_hz = EXAMPLE_LCD_PIXEL_CLOCK_HZ,
```

(下页继续)



(续上页)

```

        .lcd_cmd_bits = EXAMPLE_LCD_CMD_BITS,
        .lcd_param_bits = EXAMPLE_LCD_PARAM_BITS,
        .spi_mode = 0,
        .trans_queue_depth = 10,
    };
    // Attach the LCD to the SPI bus
    ESP_ERROR_CHECK(esp_lcd_new_panel_io_spi((esp_lcd_spi_bus_handle_t)LCD_
    ↪HOST, &io_config, &io_handle));

```

3. Install the LCD controller driver. The LCD controller driver is responsible for sending the commands and parameters to the LCD controller chip. In this step, you need to specify the SPI IO device handle that allocated in the last step, and some panel specific configurations:

- `esp_lcd_panel_dev_config_t::reset_gpio_num` sets the LCD's hardware reset GPIO number. If the LCD does not have a hardware reset pin, set this to `-1`.
- `esp_lcd_panel_dev_config_t::rgb_ele_order` sets the R-G-B element order of each color data.
- `esp_lcd_panel_dev_config_t::bits_per_pixel` sets the bit width of the pixel color data. The LCD driver uses this value to calculate the number of bytes to send to the LCD controller chip.
- `esp_lcd_panel_dev_config_t::data_endian` specifies the data endian to be transmitted to the screen. No need to specify for color data within 1 byte, like RGB232. For drivers that do not support specifying data endian, this field would be ignored.

```

esp_lcd_panel_handle_t panel_handle = NULL;
esp_lcd_panel_dev_config_t panel_config = {
    .reset_gpio_num = EXAMPLE_PIN_NUM_RST,
    .rgb_ele_order = LCD_RGB_ELEMENT_ORDER_BGR,
    .bits_per_pixel = 16,
};
// Create LCD panel handle for ST7789, with the SPI IO device handle
ESP_ERROR_CHECK(esp_lcd_new_panel_st7789(io_handle, &panel_config, &
    ↪panel_handle));

```

## API Reference

### Header File

- [components/esp\\_lcd/include/esp\\_lcd\\_io\\_spi.h](#)
- This header file can be included with:

```
#include "esp_lcd_io_spi.h"
```

- This header file is a part of the API provided by the `esp_lcd` component. To declare that your component depends on `esp_lcd`, add the following to your `CMakeLists.txt`:

```
REQUIRES esp_lcd
```

or

```
PRIV_REQUIRES esp_lcd
```

### Functions

`esp_err_t esp_lcd_new_panel_io_spi(esp_lcd_spi_bus_handle_t bus, const esp_lcd_panel_io_spi_config_t *io_config, esp_lcd_panel_io_handle_t *ret_io)`

Create LCD panel IO handle, for SPI interface.

#### 参数

- **bus** -- [in] SPI bus handle

- **io\_config** -- [in] IO configuration, for SPI interface
- **ret\_io** -- [out] Returned IO handle

**返回**

- ESP\_ERR\_INVALID\_ARG if parameter is invalid
- ESP\_ERR\_NO\_MEM if out of memory
- ESP\_OK on success

**Structures**

struct **esp\_lcd\_panel\_io\_spi\_config\_t**

Panel IO configuration structure, for SPI interface.

**Public Members**

int **cs\_gpio\_num**

GPIO used for CS line

int **dc\_gpio\_num**

GPIO used to select the D/C line, set this to -1 if the D/C line is not used

int **spi\_mode**

Traditional SPI mode (0~3)

unsigned int **pclk\_hz**

Frequency of pixel clock

size\_t **trans\_queue\_depth**

Size of internal transaction queue

*esp\_lcd\_panel\_io\_color\_trans\_done\_cb\_t* **on\_color\_trans\_done**

Callback invoked when color data transfer has finished

void \***user\_ctx**

User private data, passed directly to on\_color\_trans\_done's user\_ctx

int **lcd\_cmd\_bits**

Bit-width of LCD command

int **lcd\_param\_bits**

Bit-width of LCD parameter

unsigned int **dc\_high\_on\_cmd**

If enabled, DC level = 1 indicates command transfer

unsigned int **dc\_low\_on\_data**

If enabled, DC level = 0 indicates color data transfer

unsigned int **dc\_low\_on\_param**

If enabled, DC level = 0 indicates parameter transfer

unsigned int **octal\_mode**

transmit with octal mode (8 data lines), this mode is used to simulate Intel 8080 timing

unsigned int **quad\_mode**

transmit with quad mode (4 data lines), this mode is useful when transmitting LCD parameters (Only use one line for command)

unsigned int **sio\_mode**

Read and write through a single data line (MOSI)

unsigned int **lsb\_first**

transmit LSB bit first

unsigned int **cs\_high\_active**

CS line is high active

struct *esp\_lcd\_panel\_io\_spi\_config\_t*::[anonymous] **flags**

Extra flags to fine-tune the SPI device

## Type Definitions

typedef int **esp\_lcd\_spi\_bus\_handle\_t**

Type of LCD SPI bus handle

## I2C Interfaced LCD

1. Create I2C bus. Please refer to *I2C API doc* for more details.

```
i2c_master_bus_handle_t i2c_bus = NULL;
i2c_master_bus_config_t bus_config = {
    .clk_source = I2C_CLK_SRC_DEFAULT,
    .glitch_ignore_cnt = 7,
    .i2c_port = I2C_BUS_PORT,
    .sda_io_num = EXAMPLE_PIN_NUM_SDA,
    .scl_io_num = EXAMPLE_PIN_NUM_SCL,
    .flags.enable_internal_pullup = true,
};
ESP_ERROR_CHECK(i2c_new_master_bus(&bus_config, &i2c_bus));
```

2. Allocate an LCD IO device handle from the I2C bus. In this step, you need to provide the following information:

- *esp\_lcd\_panel\_io\_i2c\_config\_t::dev\_addr* sets the I2C device address of the LCD controller chip. The LCD driver uses this address to communicate with the LCD controller chip.
- *esp\_lcd\_panel\_io\_i2c\_config\_t::scl\_speed\_hz* sets the I2C clock frequency in Hz. The value should not exceed the range recommended in the LCD spec.
- *esp\_lcd\_panel\_io\_i2c\_config\_t::lcd\_cmd\_bits* and *esp\_lcd\_panel\_io\_i2c\_config\_t::lcd\_param\_bits* set the bit width of the command and parameter that recognized by the LCD controller chip. This is chip specific, you should refer to your LCD spec in advance.

```
esp_lcd_panel_io_handle_t io_handle = NULL;
esp_lcd_panel_io_i2c_config_t io_config = {
    .dev_addr = EXAMPLE_I2C_HW_ADDR,
    .scl_speed_hz = EXAMPLE_LCD_PIXEL_CLOCK_HZ,
    .control_phase_bytes = 1, // refer to LCD spec
```

(下页继续)

(续上页)

```

        .dc_bit_offset = 6,          // refer to LCD spec
        .lcd_cmd_bits = EXAMPLE_LCD_CMD_BITS,
        .lcd_param_bits = EXAMPLE_LCD_CMD_BITS,
    };
    ESP_ERROR_CHECK(esp_lcd_new_panel_io_i2c(i2c_bus, &io_config, &io_
    ↪handle));

```

3. Install the LCD controller driver. The LCD controller driver is responsible for sending the commands and parameters to the LCD controller chip. In this step, you need to specify the I2C IO device handle that allocated in the last step, and some panel specific configurations:

- `esp_lcd_panel_dev_config_t::reset_gpio_num` sets the LCD's hardware reset GPIO number. If the LCD does not have a hardware reset pin, set this to -1.
- `esp_lcd_panel_dev_config_t::bits_per_pixel` sets the bit width of the pixel color data. The LCD driver uses this value to calculate the number of bytes to send to the LCD controller chip.

```

esp_lcd_panel_handle_t panel_handle = NULL;
esp_lcd_panel_dev_config_t panel_config = {
    .bits_per_pixel = 1,
    .reset_gpio_num = EXAMPLE_PIN_NUM_RST,
};
ESP_ERROR_CHECK(esp_lcd_new_panel_ssd1306(io_handle, &panel_config, &
    ↪panel_handle));

```

## API Reference

### Header File

- [components/esp\\_lcd/include/esp\\_lcd\\_io\\_i2c.h](#)
- This header file can be included with:

```
#include "esp_lcd_io_i2c.h"
```

- This header file is a part of the API provided by the `esp_lcd` component. To declare that your component depends on `esp_lcd`, add the following to your `CMakeLists.txt`:

```
REQUIRES esp_lcd
```

or

```
PRIV_REQUIRES esp_lcd
```

### Functions

`esp_err_t esp_lcd_new_panel_io_i2c_v1` (uint32\_t bus, const `esp_lcd_panel_io_i2c_config_t` \*io\_config, `esp_lcd_panel_io_handle_t` \*ret\_io)

Create LCD panel IO handle, for I2C interface in legacy implementation.

**备注:** Please don't call this function in your project directly. Please call `esp_lcd_new_panel_to_i2c` instead.

#### 参数

- **bus** -- [in] I2C bus handle, (in `uint32_t`)
- **io\_config** -- [in] IO configuration, for I2C interface
- **ret\_io** -- [out] Returned IO handle

#### 返回

- `ESP_ERR_INVALID_ARG` if parameter is invalid

- ESP\_ERR\_NO\_MEM if out of memory
- ESP\_OK on success

`esp_err_t esp_lcd_new_panel_io_i2c_v2` (*i2c\_master\_bus\_handle\_t* bus, const *esp\_lcd\_panel\_io\_i2c\_config\_t* \*io\_config, *esp\_lcd\_panel\_io\_handle\_t* \*ret\_io)

Create LCD panel IO handle, for I2C interface in new implementation.

---

**备注:** Please don't call this function in your project directly. Please call `esp_lcd_new_panel_to_i2c` instead.

---

#### 参数

- **bus** -- [in] I2C bus handle, (in *i2c\_master\_dev\_handle\_t*)
- **io\_config** -- [in] IO configuration, for I2C interface
- **ret\_io** -- [out] Returned IO handle

#### 返回

- ESP\_ERR\_INVALID\_ARG if parameter is invalid
- ESP\_ERR\_NO\_MEM if out of memory
- ESP\_OK on success

## Structures

struct **esp\_lcd\_panel\_io\_i2c\_config\_t**

Panel IO configuration structure, for I2C interface.

## Public Members

uint32\_t **dev\_addr**

I2C device address

*esp\_lcd\_panel\_io\_color\_trans\_done\_cb\_t* **on\_color\_trans\_done**

Callback invoked when color data transfer has finished

void \***user\_ctx**

User private data, passed directly to `on_color_trans_done`'s `user_ctx`

size\_t **control\_phase\_bytes**

I2C LCD panel will encode control information (e.g. D/C selection) into control phase, in several bytes

unsigned int **dc\_bit\_offset**

Offset of the D/C selection bit in control phase

int **lcd\_cmd\_bits**

Bit-width of LCD command

int **lcd\_param\_bits**

Bit-width of LCD parameter

unsigned int **dc\_low\_on\_data**

If this flag is enabled, DC line = 0 means transfer data, DC line = 1 means transfer command; vice versa

unsigned int **disable\_control\_phase**

If this flag is enabled, the control phase isn't used

struct *esp\_lcd\_panel\_io\_i2c\_config\_t*::[anonymous] **flags**

Extra flags to fine-tune the I2C device

uint32\_t **scl\_speed\_hz**

I2C LCD SCL frequency (hz)

### Macros

**esp\_lcd\_new\_panel\_io\_i2c** (bus, io\_config, ret\_io)

Create LCD panel IO handle.

#### 参数

- **bus** -- [in] I2C bus handle
- **io\_config** -- [in] IO configuration, for I2C interface
- **ret\_io** -- [out] Returned IO handle

#### 返回

- ESP\_ERR\_INVALID\_ARG if parameter is invalid
- ESP\_ERR\_NO\_MEM if out of memory
- ESP\_OK on success

### Type Definitions

typedef uint32\_t **esp\_lcd\_i2c\_bus\_handle\_t**

Type of LCD I2C bus handle

---

**备注:** ESP-IDF provides only a limited number of LCD device controller drivers out of the box (e.g., ST7789), more drivers are available in the [Espressif Component Registry](#).

---

### LCD Control Panel Operations

- *esp\_lcd\_panel\_reset()* can reset the LCD control panel.
- *esp\_lcd\_panel\_init()* performs a basic initialization of the control panel. To perform more manufacture specific initialization, please refer to *Steps to Add Manufacture Specific Initialization*.
- By combining using *esp\_lcd\_panel\_swap\_xy()* and *esp\_lcd\_panel\_mirror()*, you can achieve the functionality of rotating or mirroring the LCD screen.
- *esp\_lcd\_panel\_disp\_on\_off()* can turn on or off the LCD screen by cutting down the output path from the frame buffer to the LCD screen. Please note, this is not controlling the LCD backlight. Backlight control is not covered by the *esp\_lcd* driver.
- *esp\_lcd\_panel\_disp\_sleep()* can reduce the power consumption of the LCD screen by entering the sleep mode. The internal frame buffer is still retained.

### LCD Data Panel Operations

- *esp\_lcd\_panel\_reset()* can reset the LCD data panel.
- *esp\_lcd\_panel\_init()* performs a basic initialization of the data panel.
- *esp\_lcd\_panel\_draw\_bitmap()* is the function which does the magic to flush the user draw buffer to the LCD screen, where the target draw window is configurable. Please note, this function expects the draw buffer is a 1-D array and there's no stride in between each lines.

## Steps to Add Manufacture Specific Initialization

The LCD controller drivers (e.g., st7789) in ESP-IDF only provide basic initialization in the `esp_lcd_panel_init()`, leaving the vast majority of settings to the default values. Some LCD modules need to set a bunch of manufacture specific configurations before it can display normally. These configurations usually include gamma, power voltage and so on. If you want to add manufacture specific initialization, please follow the steps below:

```
esp_lcd_panel_reset(panel_handle);
esp_lcd_panel_init(panel_handle);
// set extra configurations e.g., gamma control
// with the underlying IO handle
// please consult your manufacture for special commands and corresponding values
esp_lcd_panel_io_tx_param(io_handle, GAMMA_CMD, (uint8_t[]) {
    GAMMA_ARRAY
}, N);
// turn on the display
esp_lcd_panel_disp_on_off(panel_handle, true);
```

## Application Example

- Software JPEG decoding and display - [peripherals/lcd/tjpgd](#)
- Universal SPI LCD example with SPI touch - [peripherals/lcd/spi\\_lcd\\_touch](#)
- I2C interfaced OLED display scrolling text - [peripherals/lcd/i2c\\_oled](#)

## API Reference

### Header File

- [components/hal/include/hal/lcd\\_types.h](#)
- This header file can be included with:

```
#include "hal/lcd_types.h"
```

### Type Definitions

```
typedef int lcd_clock_source_t
```

### Enumerations

```
enum lcd_rgb_data_endian_t
```

RGB data endian.

*Values:*

enumerator **LCD\_RGB\_DATA\_ENDIAN\_BIG**

RGB data endian: MSB first

enumerator **LCD\_RGB\_DATA\_ENDIAN\_LITTLE**

RGB data endian: LSB first

```
enum lcd_color_space_t
```

LCD color space.

*Values:*

enumerator **LCD\_COLOR\_SPACE\_RGB**

Color space: RGB

enumerator **LCD\_COLOR\_SPACE\_YUV**

Color space: YUV

enum **lcd\_color\_rgb\_pixel\_format\_t**

LCD color pixel format in RGB color space.

*Values:*

enumerator **LCD\_COLOR\_PIXEL\_FORMAT\_RGB565**

16 bits, 5 bits per R/B value, 6 bits for G value

enumerator **LCD\_COLOR\_PIXEL\_FORMAT\_RGB666**

18 bits, 6 bits per R/G/B value

enumerator **LCD\_COLOR\_PIXEL\_FORMAT\_RGB888**

24 bits, 8 bits per R/G/B value

enum **lcd\_color\_range\_t**

LCD color range.

*Values:*

enumerator **LCD\_COLOR\_RANGE\_LIMIT**

Limited color range

enumerator **LCD\_COLOR\_RANGE\_FULL**

Full color range

enum **lcd\_yuv\_sample\_t**

YUV sampling method.

*Values:*

enumerator **LCD\_YUV\_SAMPLE\_422**

YUV 4:2:2 sampling

enumerator **LCD\_YUV\_SAMPLE\_420**

YUV 4:2:0 sampling

enumerator **LCD\_YUV\_SAMPLE\_411**

YUV 4:1:1 sampling

enum **lcd\_yuv\_conv\_std\_t**

The standard used for conversion between RGB and YUV.

*Values:*

enumerator **LCD\_YUV\_CONV\_STD\_BT601**

YUV<->RGB conversion standard: BT.601



enumerator **LCD\_YUV\_CONV\_STD\_BT709**

YUV<->RGB conversion standard: BT.709

### Header File

- `components/esp_lcd/include/esp_lcd_types.h`
- This header file can be included with:

```
#include "esp_lcd_types.h"
```

- This header file is a part of the API provided by the `esp_lcd` component. To declare that your component depends on `esp_lcd`, add the following to your `CMakeLists.txt`:

```
REQUIRES esp_lcd
```

or

```
PRIV_REQUIRES esp_lcd
```

### Structures

struct **esp\_lcd\_video\_timing\_t**

Timing parameters for the video data transmission.

#### Public Members

`uint32_t h_size`

Horizontal resolution, i.e. the number of pixels in a line

`uint32_t v_size`

Vertical resolution, i.e. the number of lines in the frame

`uint32_t hsync_pulse_width`

Horizontal sync width, in pixel clock

`uint32_t hsync_back_porch`

Horizontal back porch, number of pixel clock between hsync and start of line active data

`uint32_t hsync_front_porch`

Horizontal front porch, number of pixel clock between the end of active data and the next hsync

`uint32_t vsync_pulse_width`

Vertical sync width, in number of lines

`uint32_t vsync_back_porch`

Vertical back porch, number of invalid lines between vsync and start of frame

`uint32_t vsync_front_porch`

Vertical front porch, number of invalid lines between the end of frame and the next vsync

struct **esp\_lcd\_panel\_io\_event\_data\_t**

Type of LCD panel IO event data.

struct **esp\_lcd\_panel\_io\_callbacks\_t**

Type of LCD panel IO callbacks.

### Public Members

[\*esp\\_lcd\\_panel\\_io\\_color\\_trans\\_done\\_cb\\_t\*](#) **on\_color\_trans\_done**

Callback invoked when color data transfer has finished

### Type Definitions

typedef struct esp\_lcd\_panel\_io\_t \***esp\_lcd\_panel\_io\_handle\_t**

Type of LCD panel IO handle

typedef struct esp\_lcd\_panel\_t \***esp\_lcd\_panel\_handle\_t**

Type of LCD panel handle

typedef bool (\***esp\_lcd\_panel\_io\_color\_trans\_done\_cb\_t**)([\*esp\\_lcd\\_panel\\_io\\_handle\\_t\*](#) panel\_io, [\*esp\\_lcd\\_panel\\_io\\_event\\_data\\_t\*](#) \*edata, void \*user\_ctx)

Declare the prototype of the function that will be invoked when panel IO finishes transferring color data.

**Param panel\_io [in]** LCD panel IO handle, which is created by factory API like `esp_lcd_new_panel_io_spi()`

**Param edata [in]** Panel IO event data, fed by driver

**Param user\_ctx [in]** User data, passed from `esp_lcd_panel_io_XXX_config_t`

**Return** Whether a high priority task has been waken up by this function

### Enumerations

enum **lcd\_rgb\_element\_order\_t**

RGB element order.

*Values:*

enumerator **LCD\_RGB\_ELEMENT\_ORDER\_RGB**

RGB element order: RGB

enumerator **LCD\_RGB\_ELEMENT\_ORDER\_BGR**

RGB element order: BGR

### Header File

- [components/esp\\_lcd/include/esp\\_lcd\\_panel\\_io.h](#)
- This header file can be included with:

```
#include "esp_lcd_panel_io.h"
```

- This header file is a part of the API provided by the `esp_lcd` component. To declare that your component depends on `esp_lcd`, add the following to your `CMakeLists.txt`:

```
REQUIRES esp_lcd
```

or

```
PRIV_REQUIRES esp_lcd
```

**Functions**

*esp\_err\_t* **esp\_lcd\_panel\_io\_rx\_param** (*esp\_lcd\_panel\_io\_handle\_t* io, int lcd\_cmd, void \*param, size\_t param\_size)

Transmit LCD command and receive corresponding parameters.

---

**备注:** Commands sent by this function are short, so they are sent using polling transactions. The function does not return before the command transfer is completed. If any queued transactions sent by `esp_lcd_panel_io_tx_color()` are still pending when this function is called, this function will wait until they are finished and the queue is empty before sending the command(s).

---

**参数**

- **io** -- **[in]** LCD panel IO handle, which is created by other factory API like `esp_lcd_new_panel_io_spi()`
- **lcd\_cmd** -- **[in]** The specific LCD command, set to -1 if no command needed
- **param** -- **[out]** Buffer for the command data
- **param\_size** -- **[in]** Size of param buffer

**返回**

- `ESP_ERR_INVALID_ARG` if parameter is invalid
- `ESP_ERR_NOT_SUPPORTED` if read is not supported by transport
- `ESP_OK` on success

*esp\_err\_t* **esp\_lcd\_panel\_io\_tx\_param** (*esp\_lcd\_panel\_io\_handle\_t* io, int lcd\_cmd, const void \*param, size\_t param\_size)

Transmit LCD command and corresponding parameters.

---

**备注:** Commands sent by this function are short, so they are sent using polling transactions. The function does not return before the command transfer is completed. If any queued transactions sent by `esp_lcd_panel_io_tx_color()` are still pending when this function is called, this function will wait until they are finished and the queue is empty before sending the command(s).

---

**参数**

- **io** -- **[in]** LCD panel IO handle, which is created by other factory API like `esp_lcd_new_panel_io_spi()`
- **lcd\_cmd** -- **[in]** The specific LCD command, set to -1 if no command needed
- **param** -- **[in]** Buffer that holds the command specific parameters, set to NULL if no parameter is needed for the command
- **param\_size** -- **[in]** Size of param in memory, in bytes, set to zero if no parameter is needed for the command

**返回**

- `ESP_ERR_INVALID_ARG` if parameter is invalid
- `ESP_OK` on success

*esp\_err\_t* **esp\_lcd\_panel\_io\_tx\_color** (*esp\_lcd\_panel\_io\_handle\_t* io, int lcd\_cmd, const void \*color, size\_t color\_size)

Transmit LCD RGB data.

---

**备注:** This function will package the command and RGB data into a transaction, and push into a queue. The real transmission is performed in the background (DMA+interrupt). The caller should take care of the lifecycle of the `color` buffer. Recycling of color buffer should be done in the callback `on_color_trans_done()`.

---

**参数**

- **io** -- **[in]** LCD panel IO handle, which is created by factory API like `esp_lcd_new_panel_io_spi()`

- **lcd\_cmd** -- **[in]** The specific LCD command, set to -1 if no command needed
- **color** -- **[in]** Buffer that holds the RGB color data
- **color\_size** -- **[in]** Size of `color` in memory, in bytes

**返回**

- ESP\_ERR\_INVALID\_ARG if parameter is invalid
- ESP\_OK on success

*esp\_err\_t* **esp\_lcd\_panel\_io\_del** (*esp\_lcd\_panel\_io\_handle\_t* io)

Destroy LCD panel IO handle (deinitialize panel and free all corresponding resource)

**参数** **io** -- **[in]** LCD panel IO handle, which is created by factory API like `esp_lcd_new_panel_io_spi()`

**返回**

- ESP\_ERR\_INVALID\_ARG if parameter is invalid
- ESP\_OK on success

*esp\_err\_t* **esp\_lcd\_panel\_io\_register\_event\_callbacks** (*esp\_lcd\_panel\_io\_handle\_t* io, const *esp\_lcd\_panel\_io\_callbacks\_t* \*cbs, void \*user\_ctx)

Register LCD panel IO callbacks.

**参数**

- **io** -- **[in]** LCD panel IO handle, which is created by factory API like `esp_lcd_new_panel_io_spi()`
- **cbs** -- **[in]** structure with all LCD panel IO callbacks
- **user\_ctx** -- **[in]** User private data, passed directly to callback's `user_ctx`

**返回**

- ESP\_ERR\_INVALID\_ARG if parameter is invalid
- ESP\_OK on success

**Header File**

- `components/esp_lcd/include/esp_lcd_panel_ops.h`
- This header file can be included with:

```
#include "esp_lcd_panel_ops.h"
```

- This header file is a part of the API provided by the `esp_lcd` component. To declare that your component depends on `esp_lcd`, add the following to your `CMakeLists.txt`:

```
REQUIRES esp_lcd
```

or

```
PRIV_REQUIRES esp_lcd
```

**Functions**

*esp\_err\_t* **esp\_lcd\_panel\_reset** (*esp\_lcd\_panel\_handle\_t* panel)

Reset LCD panel.

---

**备注:** Panel reset must be called before attempting to initialize the panel using `esp_lcd_panel_init()`.

---

**参数** **panel** -- **[in]** LCD panel handle, which is created by other factory API like `esp_lcd_new_panel_st7789()`

**返回**

- ESP\_OK on success

*esp\_err\_t* **esp\_lcd\_panel\_init** (*esp\_lcd\_panel\_handle\_t* panel)

Initialize LCD panel.

---

**备注:** Before calling this function, make sure the LCD panel has finished the `reset` stage by `esp_lcd_panel_reset()`.

---

**参数** **panel** -- **[in]** LCD panel handle, which is created by other factory API like `esp_lcd_new_panel_st7789()`

**返回**

- ESP\_OK on success

*esp\_err\_t* **esp\_lcd\_panel\_del** (*esp\_lcd\_panel\_handle\_t* panel)

Deinitialize the LCD panel.

**参数** **panel** -- **[in]** LCD panel handle, which is created by other factory API like `esp_lcd_new_panel_st7789()`

**返回**

- ESP\_OK on success

*esp\_err\_t* **esp\_lcd\_panel\_draw\_bitmap** (*esp\_lcd\_panel\_handle\_t* panel, int x\_start, int y\_start, int x\_end, int y\_end, const void \*color\_data)

Draw bitmap on LCD panel.

**参数**

- **panel** -- **[in]** LCD panel handle, which is created by other factory API like `esp_lcd_new_panel_st7789()`
- **x\_start** -- **[in]** Start pixel index in the target frame buffer, on x-axis (x\_start is included)
- **y\_start** -- **[in]** Start pixel index in the target frame buffer, on y-axis (y\_start is included)
- **x\_end** -- **[in]** End pixel index in the target frame buffer, on x-axis (x\_end is not included)
- **y\_end** -- **[in]** End pixel index in the target frame buffer, on y-axis (y\_end is not included)
- **color\_data** -- **[in]** RGB color data that will be dumped to the specific window range

**返回**

- ESP\_OK on success

*esp\_err\_t* **esp\_lcd\_panel\_mirror** (*esp\_lcd\_panel\_handle\_t* panel, bool mirror\_x, bool mirror\_y)

Mirror the LCD panel on specific axis.

---

**备注:** Combined with `esp_lcd_panel_swap_xy()`, one can realize screen rotation

---

**参数**

- **panel** -- **[in]** LCD panel handle, which is created by other factory API like `esp_lcd_new_panel_st7789()`
- **mirror\_x** -- **[in]** Whether the panel will be mirrored about the x axis
- **mirror\_y** -- **[in]** Whether the panel will be mirrored about the y axis

**返回**

- ESP\_OK on success
- ESP\_ERR\_NOT\_SUPPORTED if this function is not supported by the panel

*esp\_err\_t* **esp\_lcd\_panel\_swap\_xy** (*esp\_lcd\_panel\_handle\_t* panel, bool swap\_axes)

Swap/Exchange x and y axis.

---

**备注:** Combined with `esp_lcd_panel_mirror()`, one can realize screen rotation

---

**参数**

- **panel** -- [in] LCD panel handle, which is created by other factory API like `esp_lcd_new_panel_st7789()`
- **swap\_axes** -- [in] Whether to swap the x and y axis

**返回**

- ESP\_OK on success
- ESP\_ERR\_NOT\_SUPPORTED if this function is not supported by the panel

*esp\_err\_t* **esp\_lcd\_panel\_set\_gap** (*esp\_lcd\_panel\_handle\_t* panel, int x\_gap, int y\_gap)

Set extra gap in x and y axis.

The gap is the space (in pixels) between the left/top sides of the LCD panel and the first row/column respectively of the actual contents displayed.

---

**备注:** Setting a gap is useful when positioning or centering a frame that is smaller than the LCD.

---

**参数**

- **panel** -- [in] LCD panel handle, which is created by other factory API like `esp_lcd_new_panel_st7789()`
- **x\_gap** -- [in] Extra gap on x axis, in pixels
- **y\_gap** -- [in] Extra gap on y axis, in pixels

**返回**

- ESP\_OK on success

*esp\_err\_t* **esp\_lcd\_panel\_invert\_color** (*esp\_lcd\_panel\_handle\_t* panel, bool invert\_color\_data)

Invert the color (bit-wise invert the color data line)

**参数**

- **panel** -- [in] LCD panel handle, which is created by other factory API like `esp_lcd_new_panel_st7789()`
- **invert\_color\_data** -- [in] Whether to invert the color data

**返回**

- ESP\_OK on success

*esp\_err\_t* **esp\_lcd\_panel\_disp\_on\_off** (*esp\_lcd\_panel\_handle\_t* panel, bool on\_off)

Turn on or off the display.

**参数**

- **panel** -- [in] LCD panel handle, which is created by other factory API like `esp_lcd_new_panel_st7789()`
- **on\_off** -- [in] True to turns on display, False to turns off display

**返回**

- ESP\_OK on success
- ESP\_ERR\_NOT\_SUPPORTED if this function is not supported by the panel

*esp\_err\_t* **esp\_lcd\_panel\_disp\_off** (*esp\_lcd\_panel\_handle\_t* panel, bool off)

Turn off the display.

**参数**

- **panel** -- [in] LCD panel handle, which is created by other factory API like `esp_lcd_new_panel_st7789()`
- **off** -- [in] Whether to turn off the screen

**返回**

- ESP\_OK on success
- ESP\_ERR\_NOT\_SUPPORTED if this function is not supported by the panel

*esp\_err\_t* **esp\_lcd\_panel\_disp\_sleep** (*esp\_lcd\_panel\_handle\_t* panel, bool sleep)

Enter or exit sleep mode.

**参数**

- **panel** -- [in] LCD panel handle, which is created by other factory API like `esp_lcd_new_panel_st7789()`
- **sleep** -- [in] True to enter sleep mode, False to wake up

**返回**

- ESP\_OK on success
- ESP\_ERR\_NOT\_SUPPORTED if this function is not supported by the panel

**Header File**

- `components/esp_lcd/include/esp_lcd_panel_vendor.h`
- This header file can be included with:

```
#include "esp_lcd_panel_vendor.h"
```

- This header file is a part of the API provided by the `esp_lcd` component. To declare that your component depends on `esp_lcd`, add the following to your `CMakeLists.txt`:

```
REQUIRES esp_lcd
```

or

```
PRIV_REQUIRES esp_lcd
```

**2.6.16 LED PWM 控制器****概述**

LED 控制器 (LEDC) 主要用于控制 LED，也可产生 PWM 信号用于其他设备的控制。该控制器有 6 路通道，可以产生独立的波形，驱动 RGB LED 等设备。

LED PWM 控制器可在无需 CPU 干预的情况下自动改变占空比，实现亮度和颜色渐变。

**功能概览**

设置 LEDC 通道分三步完成。注意，与 ESP32 不同，ESP32-H2 仅支持设置通道为低速模式。

1. **定时器配置** 指定 PWM 信号的频率和占空比分辨率。
2. **通道配置** 绑定定时器和输出 PWM 信号的 GPIO。
3. **改变 PWM 信号** 输出 PWM 信号来驱动 LED。可通过软件控制或使用硬件渐变功能来改变 LED 的亮度。

另一个可选步骤是可以在渐变终端设置一个中断。

---

**备注：**首次 LEDC 配置时，建议先配置定时器（调用函数 `ledc_timer_config()`），再配置通道（调用函数 `ledc_channel_config()`）。这样可以确保 IO 脚上的 PWM 信号自有输出开始其频率就是正确的。

---

**定时器配置** 要设置定时器，可调用函数 `ledc_timer_config()`，并将包括如下配置参数的数据结构 `ledc_timer_config_t` 传递给该函数：

- 速度模式（值必须为 `LEDC_LOW_SPEED_MODE`）
- 定时器索引 `ledc_timer_t`
- PWM 信号频率（Hz）



图 14: LED PWM 控制器 API 的关键配置

- PWM 占空比分辨率
- 时钟源 `ledc_clk_cfg_t`

频率和占空比分辨率相互关联。PWM 频率越高，占空比分辨率越低，反之亦然。如果 API 不是用来改变 LED 亮度，而是用于其它目的，这种相互关系可能会很重要。更多信息详见[频率和占空比分辨率支持范围](#)一节。

时钟源同样可以限制 PWM 频率。选择的时钟源频率越高，可以配置的 PWM 频率上限就越高。

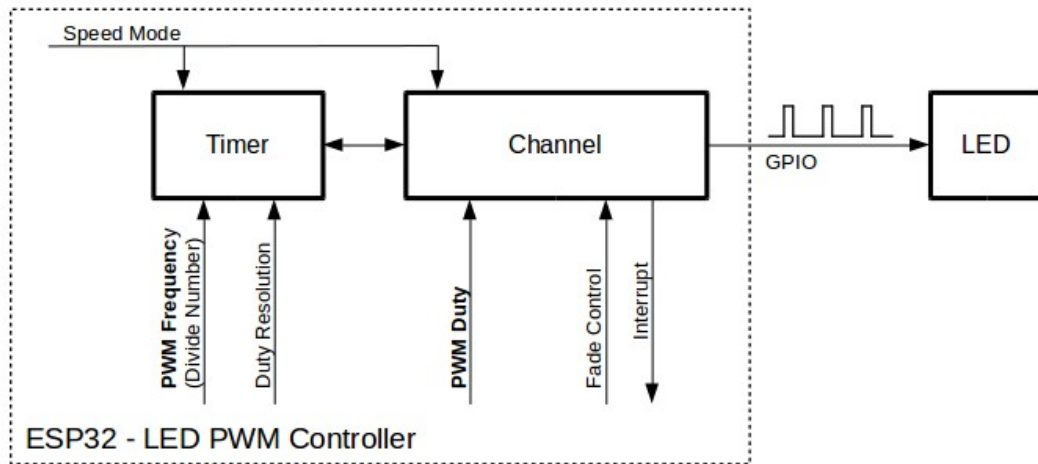
表 2: ESP32-H2 LEDC 时钟源特性

时钟名称	时钟频率	时钟功能
PLL_96M_CLK	96 MHz	/
RC_FAST_CLK	~ 8 MHz	支持动态调频 (DFS) 功能，支持 Light-sleep 模式
XTAL_CLK	32 MHz	支持动态调频 (DFS) 功能

#### 备注:

1. 如果 ESP32-H2 的定时器选用了 RC\_FAST\_CLK 作为其时钟源，驱动会通过内部校准来得知这个时钟源的实际频率。这样确保了输出 PWM 信号频率的精准性。
2. ESP32-H2 的所有定时器共用一个时钟源。因此 ESP32-H2 不支持给不同的定时器配置不同的时钟源。

LEDC 驱动提供了一个辅助函数 `ledc_find_suitable_duty_resolution()`。传入时钟源频率及期望的 PWM 信号频率，这个函数可以直接找到最大可配的占空比分辨率值。

当一个定时器不再被任何通道所需要时，可以通过调用相同的函数 `ledc_timer_config()` 来重置这个定时器。此时，函数入参的配置结构体需要指定：

- `ledc_timer_config_t::speed_mode` 重置定时器的所属速度模式 (`ledc_mode_t`)
- `ledc_timer_config_t::timer_num` 重置定时器的索引 (`ledc_timer_t`)
- `ledc_timer_config_t::deconfigure` 将指定定时器重置必须配置此项为 `true`

**通道配置** 定时器设置好后，请配置所需的通道 (`ledc_channel_t` 之一)。配置通道需调用函数 `ledc_channel_config()`。



通道的配置与定时器设置类似，需向通道配置函数传递包括通道配置参数的结构体 `ledc_channel_config_t`。

此时，通道会按照 `ledc_channel_config_t` 的配置开始运作，并在选定的 GPIO 上生成由定时器设置指定的频率和占空比的 PWM 信号。在通道运作过程中，可以随时通过调用函数 `ledc_stop()` 将其暂停。

**改变 PWM 信号** 通道开始运行、生成具有恒定占空比和频率的 PWM 信号之后，有几种方式可以改变该信号。驱动 LED 时，主要通过改变占空比来变化光线亮度。

以下两节介绍了如何使用软件和硬件改变占空比。如有需要，PWM 信号的频率也可更改，详见 [改变 PWM 频率](#) 一节。

---

**备注：**在 ESP32-H2 的 LED PWM 控制器中，所有的定时器和通道都只支持低速模式。对 PWM 设置的任何改变，都需要由软件显式地触发（见下文）。

---

**使用软件改变 PWM 占空比** 调用函数 `ledc_set_duty()` 可以设置新的占空比。之后，调用函数 `ledc_update_duty()` 使新配置生效。要查看当前设置的占空比，可使用 `_get_` 函数 `ledc_get_duty()`。

另外一种设置占空比和其他通道参数的方式是调用 [通道配置](#) 一节提到的函数 `ledc_channel_config()`。

传递给函数的占空比数值范围取决于选定的 `duty_resolution`，应为 0 至  $(2 ** \text{duty\_resolution})$ 。例如，如选定的占空比分辨率为 10，则占空比的数值范围为 0 至 1024。此时分辨率为 ~0.1%。

**警告：**在 ESP32-H2 上，当通道绑定的定时器配置了其最大 PWM 占空比分辨率 (`MAX_DUTY_RES`)，通道的占空比不能被设置到  $(2 ** \text{MAX\_DUTY\_RES})$ 。否则，硬件内部占空比计数器会溢出，并导致占空比计算错误。

**使用硬件改变 PWM 占空比** LED PWM 控制器硬件可逐渐改变占空比的数值。要使用此功能，需用函数 `ledc_fade_func_install()` 使能渐变，之后用下列可用渐变函数之一配置：

- `ledc_set_fade_with_time()`
- `ledc_set_fade_with_step()`
- `ledc_set_fade()`

ESP32-H2 的硬件额外支持多达 16 次，无需 CPU 介入的连续渐变。此功能可以更加有效便捷地实现一个带伽马校正的渐变。

众所周知，人眼所感知的亮度与 PWM 占空比并非成线性关系。为了能使人感观上认为一盏灯明暗的变化是线性的，我们对其 PWM 信号的占空比控制必须为非线性的，俗称伽马校正。LED PWM 控制器可以通过多段线型拟合来模仿伽马曲线渐变。你需要自己在应用程序中分配一段用以保存渐变参数的内存块，并提供开始和结束的占空比，伽马校正公式，以及期望的线性渐变段数信息，`ledc_fill_multi_fade_param_list()` 就能快速生成所有分段线性渐变的参数。或者你也可以自己直接构造一个 `ledc_fade_param_config_t` 的数组。在获得所有渐变参数后，通过将 `ledc_fade_param_config_t` 数组的指针和渐变区间数传入 `ledc_set_multi_fade()`，一次连续渐变的配置就完成了。

最后需要调用 `ledc_fade_start()` 开启渐变。渐变可以在阻塞或非阻塞模式下运行，具体区别请查看 `ledc_fade_mode_t`。需要特别注意的是，不管在哪种模式下，下一次渐变或是单次占空比配置的指令生效都必须等到前一次渐变完成或被中止。中止一个正在运行中的渐变需要调用函数 `ledc_fade_stop()`。

此外，在使能渐变后，每个通道都可以额外通过调用 `ledc_cb_register()` 注册一个回调函数用以获得渐变完成的事件通知。回调函数的原型被定义在 `ledc_cb_t`。每个回调函数都应当返回一个布尔值给

驱动的中断处理函数，用以表示是否有高优先级任务被其唤醒。此外，值得注意的是，由于驱动的中断处理函数被放在了 IRAM 中，回调函数和其调用的函数也需要被放在 IRAM 中。`ledc_cb_register()` 会检查回调函数及函数上下文的指针地址是否在正确的存储区域。

如不需要渐变和渐变中断，可用函数 `ledc_fade_func_uninstall()` 关闭。

**改变 PWM 频率** LED PWM 控制器 API 有多种方式即时改变 PWM 频率：

- 通过调用函数 `ledc_set_freq()` 设置频率。可用函数 `ledc_get_freq()` 查看当前频率。
- 通过调用函数 `ledc_bind_channel_timer()` 将其他定时器绑定到该通道来改变频率和占空比分辨率。
- 通过调用函数 `ledc_channel_config()` 改变通道的定时器。

**控制 PWM 的更多方式** 有一些较底层的定时器特定函数可用于更改 PWM 设置：

- `ledc_timer_set()`
- `ledc_timer_rst()`
- `ledc_timer_pause()`
- `ledc_timer_resume()`

前两个功能可通过函数 `ledc_channel_config()` 在后台运行，在定时器配置后启动。

**使用中断** 配置 LED PWM 控制器通道时，可在 `ledc_channel_config_t` 中选取参数 `ledc_intr_type_t`，在渐变完成时触发中断。

要注册处理程序来处理中断，可调用函数 `ledc_isr_register()`。

### 频率和占空比分辨率支持范围

LED PWM 控制器主要用于驱动 LED。该控制器 PWM 占空比设置的分辨率范围较广。比如，PWM 频率为 5 kHz 时，占空比分辨率最大可为 13 位。这意味着占空比可为 0 至 100% 之间的任意值，分辨率为 ~0.012% ( $2^{13} = 8192$  LED 亮度的离散电平)。然而，这些参数取决于为 LED PWM 控制器定时器计时的时钟信号，LED PWM 控制器为通道提供时钟（具体可参考[定时器配置](#)和[ESP32-H2 技术参考手册 > LED PWM 计时器 \(LEDC\) \[PDF\]](#)）。

LED PWM 控制器可用于生成频率较高的信号，足以为数码相机模组等其他设备提供时钟。此时，最大频率可为 40 MHz，占空比分辨率为 1 位。也就是说，占空比固定为 50%，无法调整。

LED PWM 控制器 API 会在设定的频率和占空比分辨率超过 LED PWM 控制器硬件范围时报错。例如，试图将频率设置为 20 MHz、占空比分辨率设置为 3 位时，串行端口监视器上会报告如下错误：

```
E (196) ledc: requested frequency and duty resolution cannot be achieved, try_
→reducing freq_hz or duty_resolution. div_param=128
```

此时，占空比分辨率或频率必须降低。比如，将占空比分辨率设置为 2 会解决这一问题，让占空比设置为 25% 的倍数，即 25%、50% 或 75%。

如设置的频率和占空比分辨率低于所支持的最低值，LED PWM 驱动器也会反映并报告，如：

```
E (196) ledc: requested frequency and duty resolution cannot be achieved, try_
→increasing freq_hz or duty_resolution. div_param=128000000
```

占空比分辨率通常用 `ledc_timer_bit_t` 设置，范围是 10 至 15 位。如需较低的占空比分辨率（上至 10，下至 1），可直接输入相应数值。

### 应用实例

使用 LEDC 基本实例请参照 [peripherals/ledc/ledc\\_basic](#)。

使用 LEDC 改变占空比和渐变控制的实例请参照 [peripherals/ledc/ledc\\_fade](#)。

使用 LEDC 对 RGB LED 实现带伽马校正的颜色控制实例请参照 [peripherals/ledc/ledc\\_gamma\\_curve\\_fade](#)。

## API 参考

### Header File

- [components/esp\\_driver\\_ledc/include/driver/ledc.h](#)
- This header file can be included with:

```
#include "driver/ledc.h"
```

- This header file is a part of the API provided by the `esp_driver_ledc` component. To declare that your component depends on `esp_driver_ledc`, add the following to your `CMakeLists.txt`:

```
REQUIRES esp_driver_ledc
```

or

```
PRIV_REQUIRES esp_driver_ledc
```

### Functions

*esp\_err\_t* **ledc\_channel\_config** (const *ledc\_channel\_config\_t* \*ledc\_conf)

LEDC channel configuration Configure LEDC channel with the given channel/output gpio\_num/interrupt/source timer/frequency(Hz)/LEDC duty.

**参数 ledc\_conf** -- Pointer of LEDC channel configure struct

**返回**

- ESP\_OK Success
- ESP\_ERR\_INVALID\_ARG Parameter error

uint32\_t **ledc\_find\_suitable\_duty\_resolution** (uint32\_t src\_clk\_freq, uint32\_t timer\_freq)

Helper function to find the maximum possible duty resolution in bits for `ledc_timer_config()`

**参数**

- **src\_clk\_freq** -- LEDC timer source clock frequency (Hz) (See doxygen comments of `ledc_clk_cfg_t` or get from `esp_clk_tree_src_get_freq_hz`)
- **timer\_freq** -- Desired LEDC timer frequency (Hz)

**返回**

- 0 The timer frequency cannot be achieved
- Others The largest duty resolution value to be set

*esp\_err\_t* **ledc\_timer\_config** (const *ledc\_timer\_config\_t* \*timer\_conf)

LEDC timer configuration Configure LEDC timer with the given source timer/frequency(Hz)/duty\_resolution.

**参数 timer\_conf** -- Pointer of LEDC timer configure struct

**返回**

- ESP\_OK Success
- ESP\_ERR\_INVALID\_ARG Parameter error
- ESP\_FAIL Can not find a proper pre-divider number base on the given frequency and the current duty\_resolution.
- ESP\_ERR\_INVALID\_STATE Timer cannot be de-configured because timer is not configured or is not paused

*esp\_err\_t* **ledc\_update\_duty** (*ledc\_mode\_t* speed\_mode, *ledc\_channel\_t* channel)

LEDC update channel parameters.

---

**备注:** Call this function to activate the LEDC updated parameters. After `ledc_set_duty`, we need to call this function to update the settings. And the new LEDC parameters don't take effect until the next PWM cycle.

---

---

**备注:** `ledc_set_duty`, `ledc_set_duty_with_hpoint` and `ledc_update_duty` are not thread-safe, do not call these functions to control one LEDC channel in different tasks at the same time. A thread-safe version of API is `ledc_set_duty_and_update`

---

**备注:** If `CONFIG_LEDC_CTRL_FUNC_IN_IRAM` is enabled, this function will be placed in the IRAM by linker, makes it possible to execute even when the Cache is disabled.

---

**备注:** This function is allowed to run within ISR context.

---

#### 参数

- **speed\_mode** -- Select the LEDC channel group with specified speed mode. Note that not all targets support high speed mode.
- **channel** -- LEDC channel (0 - LEDC\_CHANNEL\_MAX-1), select from `ledc_channel_t`

#### 返回

- ESP\_OK Success
- ESP\_ERR\_INVALID\_ARG Parameter error

*esp\_err\_t* **ledc\_set\_pin** (int gpio\_num, *ledc\_mode\_t* speed\_mode, *ledc\_channel\_t* ledc\_channel)

Set LEDC output gpio.

---

**备注:** This function only routes the LEDC signal to GPIO through matrix, other LEDC resources initialization are not involved. Please use `ledc_channel_config()` instead to fully configure a LEDC channel.

---

#### 参数

- **gpio\_num** -- The LEDC output gpio
- **speed\_mode** -- Select the LEDC channel group with specified speed mode. Note that not all targets support high speed mode.
- **ledc\_channel** -- LEDC channel (0 - LEDC\_CHANNEL\_MAX-1), select from `ledc_channel_t`

#### 返回

- ESP\_OK Success
- ESP\_ERR\_INVALID\_ARG Parameter error

*esp\_err\_t* **ledc\_stop** (*ledc\_mode\_t* speed\_mode, *ledc\_channel\_t* channel, uint32\_t idle\_level)

LEDC stop. Disable LEDC output, and set idle level.

---

**备注:** If `CONFIG_LEDC_CTRL_FUNC_IN_IRAM` is enabled, this function will be placed in the IRAM by linker, makes it possible to execute even when the Cache is disabled.

---

**备注:** This function is allowed to run within ISR context.

---

#### 参数

- **speed\_mode** -- Select the LEDC channel group with specified speed mode. Note that not all targets support high speed mode.
- **channel** -- LEDC channel (0 - LEDC\_CHANNEL\_MAX-1), select from `ledc_channel_t`
- **idle\_level** -- Set output idle level after LEDC stops.

## 返回

- ESP\_OK Success
- ESP\_ERR\_INVALID\_ARG Parameter error

*esp\_err\_t* **ledc\_set\_freq** (*ledc\_mode\_t* speed\_mode, *ledc\_timer\_t* timer\_num, uint32\_t freq\_hz)

LEDC set channel frequency (Hz)

## 参数

- **speed\_mode** -- Select the LEDC channel group with specified speed mode. Note that not all targets support high speed mode.
- **timer\_num** -- LEDC timer index (0-3), select from *ledc\_timer\_t*
- **freq\_hz** -- Set the LEDC frequency

## 返回

- ESP\_OK Success
- ESP\_ERR\_INVALID\_ARG Parameter error
- ESP\_FAIL Can not find a proper pre-divider number base on the given frequency and the current duty\_resolution.

uint32\_t **ledc\_get\_freq** (*ledc\_mode\_t* speed\_mode, *ledc\_timer\_t* timer\_num)

LEDC get channel frequency (Hz)

## 参数

- **speed\_mode** -- Select the LEDC channel group with specified speed mode. Note that not all targets support high speed mode.
- **timer\_num** -- LEDC timer index (0-3), select from *ledc\_timer\_t*

## 返回

- 0 error
- Others Current LEDC frequency

*esp\_err\_t* **ledc\_set\_duty\_with\_hpoint** (*ledc\_mode\_t* speed\_mode, *ledc\_channel\_t* channel, uint32\_t duty, uint32\_t hpoint)

LEDC set duty and hpoint value Only after calling *ledc\_update\_duty* will the duty update.

---

**备注:** *ledc\_set\_duty*, *ledc\_set\_duty\_with\_hpoint* and *ledc\_update\_duty* are not thread-safe, do not call these functions to control one LEDC channel in different tasks at the same time. A thread-safe version of API is *ledc\_set\_duty\_and\_update*

---



---

**备注:** For ESP32, hardware does not support any duty change while a fade operation is running in progress on that channel. Other duty operations will have to wait until the fade operation has finished.

---

## 参数

- **speed\_mode** -- Select the LEDC channel group with specified speed mode. Note that not all targets support high speed mode.
- **channel** -- LEDC channel (0 - LEDC\_CHANNEL\_MAX-1), select from *ledc\_channel\_t*
- **duty** -- Set the LEDC duty, the range of duty setting is [0, (2\*\*duty\_resolution)]
- **hpoint** -- Set the LEDC hpoint value, the range is [0, (2\*\*duty\_resolution)-1]

## 返回

- ESP\_OK Success
- ESP\_ERR\_INVALID\_ARG Parameter error

int **ledc\_get\_hpoint** (*ledc\_mode\_t* speed\_mode, *ledc\_channel\_t* channel)

LEDC get hpoint value, the counter value when the output is set high level.

## 参数

- **speed\_mode** -- Select the LEDC channel group with specified speed mode. Note that not all targets support high speed mode.

- **channel** -- LEDC channel (0 - LEDC\_CHANNEL\_MAX-1), select from `ledc_channel_t`

**返回**

- LEDC\_ERR\_VAL if parameter error
- Others Current hpoint value of LEDC channel

*esp\_err\_t* **ledc\_set\_duty** (*ledc\_mode\_t* speed\_mode, *ledc\_channel\_t* channel, uint32\_t duty)

LEDC set duty This function do not change the hpoint value of this channel. if needed, please call `ledc_set_duty_with_hpoint`. only after calling `ledc_update_duty` will the duty update.

---

**备注:** `ledc_set_duty`, `ledc_set_duty_with_hpoint` and `ledc_update_duty` are not thread-safe, do not call these functions to control one LEDC channel in different tasks at the same time. A thread-safe version of API is `ledc_set_duty_and_update`.

---



---

**备注:** For ESP32, hardware does not support any duty change while a fade operation is running in progress on that channel. Other duty operations will have to wait until the fade operation has finished.

---

**参数**

- **speed\_mode** -- Select the LEDC channel group with specified speed mode. Note that not all targets support high speed mode.
- **channel** -- LEDC channel (0 - LEDC\_CHANNEL\_MAX-1), select from `ledc_channel_t`
- **duty** -- Set the LEDC duty, the range of duty setting is  $[0, (2^{**}duty\_resolution)]$

**返回**

- ESP\_OK Success
- ESP\_ERR\_INVALID\_ARG Parameter error

uint32\_t **ledc\_get\_duty** (*ledc\_mode\_t* speed\_mode, *ledc\_channel\_t* channel)

LEDC get duty This function returns the duty at the present PWM cycle. You shouldn't expect the function to return the new duty in the same cycle of calling `ledc_update_duty`, because duty update doesn't take effect until the next cycle.

**参数**

- **speed\_mode** -- Select the LEDC channel group with specified speed mode. Note that not all targets support high speed mode.
- **channel** -- LEDC channel (0 - LEDC\_CHANNEL\_MAX-1), select from `ledc_channel_t`

**返回**

- LEDC\_ERR\_DUTY if parameter error
- Others Current LEDC duty

*esp\_err\_t* **ledc\_set\_fade** (*ledc\_mode\_t* speed\_mode, *ledc\_channel\_t* channel, uint32\_t duty, *ledc\_duty\_direction\_t* fade\_direction, uint32\_t step\_num, uint32\_t duty\_cycle\_num, uint32\_t duty\_scale)

LEDC set gradient Set LEDC gradient, After the function calls the `ledc_update_duty` function, the function can take effect.

---

**备注:** For ESP32, hardware does not support any duty change while a fade operation is running in progress on that channel. Other duty operations will have to wait until the fade operation has finished.

---

**参数**

- **speed\_mode** -- Select the LEDC channel group with specified speed mode. Note that not all targets support high speed mode.



- **channel** -- LEDC channel (0 - LEDC\_CHANNEL\_MAX-1), select from `ledc_channel_t`
- **duty** -- Set the start of the gradient duty, the range of duty setting is [0, (2\*\*duty\_resolution)]
- **fade\_direction** -- Set the direction of the gradient
- **step\_num** -- Set the number of the gradient
- **duty\_cycle\_num** -- Set how many LEDC tick each time the gradient lasts
- **duty\_scale** -- Set gradient change amplitude

**返回**

- ESP\_OK Success
- ESP\_ERR\_INVALID\_ARG Parameter error

`esp_err_t ledc_isr_register` (void (\*fn)(void\*), void \*arg, int intr\_alloc\_flags, `ledc_isr_handle_t` \*handle)

Register LEDC interrupt handler, the handler is an ISR. The handler will be attached to the same CPU core that this function is running on.

**参数**

- **fn** -- Interrupt handler function.
- **arg** -- User-supplied argument passed to the handler function.
- **intr\_alloc\_flags** -- Flags used to allocate the interrupt. One or multiple (ORred) `ESP_INTR_FLAG_*` values. See `esp_intr_alloc.h` for more info.
- **handle** -- Pointer to return handle. If non-NULL, a handle for the interrupt will be returned here.

**返回**

- ESP\_OK Success
- ESP\_ERR\_INVALID\_ARG Parameter error
- ESP\_ERR\_NOT\_FOUND Failed to find available interrupt source

`esp_err_t ledc_timer_set` (`ledc_mode_t` speed\_mode, `ledc_timer_t` timer\_sel, uint32\_t clock\_divider, uint32\_t duty\_resolution, `ledc_clk_src_t` clk\_src)

Configure LEDC settings.

**参数**

- **speed\_mode** -- Select the LEDC channel group with specified speed mode. Note that not all targets support high speed mode.
- **timer\_sel** -- Timer index (0-3), there are 4 timers in LEDC module
- **clock\_divider** -- Timer clock divide value, the timer clock is divided from the selected clock source
- **duty\_resolution** -- Resolution of duty setting in number of bits. The range is [1, SOC\_LEDC\_TIMER\_BIT\_WIDTH]
- **clk\_src** -- Select LEDC source clock.

**返回**

- (-1) Parameter error
- Other Current LEDC duty

`esp_err_t ledc_timer_rst` (`ledc_mode_t` speed\_mode, `ledc_timer_t` timer\_sel)

Reset LEDC timer.

**参数**

- **speed\_mode** -- Select the LEDC channel group with specified speed mode. Note that not all targets support high speed mode.
- **timer\_sel** -- LEDC timer index (0-3), select from `ledc_timer_t`

**返回**

- ESP\_ERR\_INVALID\_ARG Parameter error
- ESP\_OK Success

`esp_err_t ledc_timer_pause` (`ledc_mode_t` speed\_mode, `ledc_timer_t` timer\_sel)

Pause LEDC timer counter.

**参数**

- **speed\_mode** -- Select the LEDC channel group with specified speed mode. Note that not all targets support high speed mode.
- **timer\_sel** -- LEDC timer index (0-3), select from `ledc_timer_t`

**返回**

- `ESP_ERR_INVALID_ARG` Parameter error
- `ESP_OK` Success

`esp_err_t ledc_timer_resume` (*ledc\_mode\_t* speed\_mode, *ledc\_timer\_t* timer\_sel)

Resume LEDC timer.

**参数**

- **speed\_mode** -- Select the LEDC channel group with specified speed mode. Note that not all targets support high speed mode.
- **timer\_sel** -- LEDC timer index (0-3), select from `ledc_timer_t`

**返回**

- `ESP_ERR_INVALID_ARG` Parameter error
- `ESP_OK` Success

`esp_err_t ledc_bind_channel_timer` (*ledc\_mode\_t* speed\_mode, *ledc\_channel\_t* channel, *ledc\_timer\_t* timer\_sel)

Bind LEDC channel with the selected timer.

**参数**

- **speed\_mode** -- Select the LEDC channel group with specified speed mode. Note that not all targets support high speed mode.
- **channel** -- LEDC channel index (0 - `LEDC_CHANNEL_MAX-1`), select from `ledc_channel_t`
- **timer\_sel** -- LEDC timer index (0-3), select from `ledc_timer_t`

**返回**

- `ESP_ERR_INVALID_ARG` Parameter error
- `ESP_OK` Success

`esp_err_t ledc_set_fade_with_step` (*ledc\_mode\_t* speed\_mode, *ledc\_channel\_t* channel, `uint32_t` target\_duty, `uint32_t` scale, `uint32_t` cycle\_num)

Set LEDC fade function.

---

**备注:** Call `ledc_fade_func_install()` once before calling this function. Call `ledc_fade_start()` after this to start fading.

---



---

**备注:** `ledc_set_fade_with_step`, `ledc_set_fade_with_time` and `ledc_fade_start` are not thread-safe, do not call these functions to control one LEDC channel in different tasks at the same time. A thread-safe version of API is `ledc_set_fade_step_and_start`

---



---

**备注:** For ESP32, hardware does not support any duty change while a fade operation is running in progress on that channel. Other duty operations will have to wait until the fade operation has finished.

---

**参数**

- **speed\_mode** -- Select the LEDC channel group with specified speed mode. Note that not all targets support high speed mode.
- **channel** -- LEDC channel index (0 - `LEDC_CHANNEL_MAX-1`), select from `ledc_channel_t`
- **target\_duty** -- Target duty of fading [0, (2\*\*duty\_resolution)]
- **scale** -- Controls the increase or decrease step scale.
- **cycle\_num** -- increase or decrease the duty every cycle\_num cycles

**返回**



- ESP\_OK Success
- ESP\_ERR\_INVALID\_ARG Parameter error
- ESP\_ERR\_INVALID\_STATE Channel not initialized
- ESP\_FAIL Fade function init error

*esp\_err\_t* **ledc\_set\_fade\_with\_time** (*ledc\_mode\_t* speed\_mode, *ledc\_channel\_t* channel, uint32\_t target\_duty, int max\_fade\_time\_ms)

Set LEDC fade function, with a limited time.

---

**备注:** Call `ledc_fade_func_install()` once before calling this function. Call `ledc_fade_start()` after this to start fading.

---



---

**备注:** `ledc_set_fade_with_step`, `ledc_set_fade_with_time` and `ledc_fade_start` are not thread-safe, do not call these functions to control one LEDC channel in different tasks at the same time. A thread-safe version of API is `ledc_set_fade_step_and_start`

---



---

**备注:** For ESP32, hardware does not support any duty change while a fade operation is running in progress on that channel. Other duty operations will have to wait until the fade operation has finished.

---

#### 参数

- **speed\_mode** -- Select the LEDC channel group with specified speed mode. Note that not all targets support high speed mode.
- **channel** -- LEDC channel index (0 - LEDC\_CHANNEL\_MAX-1), select from `ledc_channel_t`
- **target\_duty** -- Target duty of fading [0, (2\*\*duty\_resolution)]
- **max\_fade\_time\_ms** -- The maximum time of the fading ( ms ).

#### 返回

- ESP\_OK Success
- ESP\_ERR\_INVALID\_ARG Parameter error
- ESP\_ERR\_INVALID\_STATE Channel not initialized
- ESP\_FAIL Fade function init error

*esp\_err\_t* **ledc\_fade\_func\_install** (int intr\_alloc\_flags)

Install LEDC fade function. This function will occupy interrupt of LEDC module.

**参数** **intr\_alloc\_flags** -- Flags used to allocate the interrupt. One or multiple (ORred) ESP\_INTR\_FLAG\_\* values. See `esp_intr_alloc.h` for more info.

#### 返回

- ESP\_OK Success
- ESP\_ERR\_INVALID\_ARG Intr flag error
- ESP\_ERR\_NOT\_FOUND Failed to find available interrupt source
- ESP\_ERR\_INVALID\_STATE Fade function already installed

void **ledc\_fade\_func\_uninstall** (void)

Uninstall LEDC fade function.

*esp\_err\_t* **ledc\_fade\_start** (*ledc\_mode\_t* speed\_mode, *ledc\_channel\_t* channel, *ledc\_fade\_mode\_t* fade\_mode)

Start LEDC fading.

---

**备注:** Call `ledc_fade_func_install()` once before calling this function. Call this API right after `ledc_set_fade_with_time` or `ledc_set_fade_with_step` before to start fading.

---

---

**备注:** Starting fade operation with this API is not thread-safe, use with care.

---



---

**备注:** For ESP32, hardware does not support any duty change while a fade operation is running in progress on that channel. Other duty operations will have to wait until the fade operation has finished.

---

#### 参数

- **speed\_mode** -- Select the LEDC channel group with specified speed mode. Note that not all targets support high speed mode.
- **channel** -- LEDC channel number
- **fade\_mode** -- Whether to block until fading done. See `ledc_types.h` `ledc_fade_mode_t` for more info. Note that this function will not return until fading to the target duty if `LEDC_FADE_WAIT_DONE` mode is selected.

#### 返回

- `ESP_OK` Success
- `ESP_ERR_INVALID_STATE` Channel not initialized or fade function not installed.
- `ESP_ERR_INVALID_ARG` Parameter error.

*esp\_err\_t* **ledc\_fade\_stop** (*ledc\_mode\_t* speed\_mode, *ledc\_channel\_t* channel)

Stop LEDC fading. The duty of the channel is guaranteed to be fixed at most one PWM cycle after the function returns.

---

**备注:** This API can be called if a new fixed duty or a new fade want to be set while the last fade operation is still running in progress.

---



---

**备注:** Call this API will abort the fading operation only if it was started by calling `ledc_fade_start` with `LEDC_FADE_NO_WAIT` mode.

---



---

**备注:** If a fade was started with `LEDC_FADE_WAIT_DONE` mode, calling this API afterwards has no use in stopping the fade. Fade will continue until it reaches the target duty.

---

#### 参数

- **speed\_mode** -- Select the LEDC channel group with specified speed mode. Note that not all targets support high speed mode.
- **channel** -- LEDC channel number

#### 返回

- `ESP_OK` Success
- `ESP_ERR_INVALID_STATE` Channel not initialized
- `ESP_ERR_INVALID_ARG` Parameter error
- `ESP_FAIL` Fade function init error

*esp\_err\_t* **ledc\_set\_duty\_and\_update** (*ledc\_mode\_t* speed\_mode, *ledc\_channel\_t* channel, `uint32_t` duty, `uint32_t` hpoint)

A thread-safe API to set duty for LEDC channel and return when duty updated.

---

**备注:** For ESP32, hardware does not support any duty change while a fade operation is running in progress on that channel. Other duty operations will have to wait until the fade operation has finished.

---

#### 参数

- **speed\_mode** -- Select the LEDC channel group with specified speed mode. Note that not all targets support high speed mode.
- **channel** -- LEDC channel (0 - LEDC\_CHANNEL\_MAX-1), select from `ledc_channel_t`
- **duty** -- Set the LEDC duty, the range of duty setting is [0, (2\*\*duty\_resolution)]
- **hpoint** -- Set the LEDC hpoint value, the range is [0, (2\*\*duty\_resolution)-1]

**返回**

- ESP\_OK Success
- ESP\_ERR\_INVALID\_STATE Channel not initialized
- ESP\_ERR\_INVALID\_ARG Parameter error
- ESP\_FAIL Fade function init error

*esp\_err\_t* **ledc\_set\_fade\_time\_and\_start** (*ledc\_mode\_t* speed\_mode, *ledc\_channel\_t* channel, uint32\_t target\_duty, uint32\_t max\_fade\_time\_ms, *ledc\_fade\_mode\_t* fade\_mode)

A thread-safe API to set and start LEDC fade function, with a limited time.

---

**备注:** Call `ledc_fade_func_install()` once, before calling this function.

---



---

**备注:** For ESP32, hardware does not support any duty change while a fade operation is running in progress on that channel. Other duty operations will have to wait until the fade operation has finished.

---

**参数**

- **speed\_mode** -- Select the LEDC channel group with specified speed mode. Note that not all targets support high speed mode.
- **channel** -- LEDC channel index (0 - LEDC\_CHANNEL\_MAX-1), select from `ledc_channel_t`
- **target\_duty** -- Target duty of fading [0, (2\*\*duty\_resolution)]
- **max\_fade\_time\_ms** -- The maximum time of the fading ( ms ).
- **fade\_mode** -- choose blocking or non-blocking mode

**返回**

- ESP\_OK Success
- ESP\_ERR\_INVALID\_ARG Parameter error
- ESP\_ERR\_INVALID\_STATE Channel not initialized
- ESP\_FAIL Fade function init error

*esp\_err\_t* **ledc\_set\_fade\_step\_and\_start** (*ledc\_mode\_t* speed\_mode, *ledc\_channel\_t* channel, uint32\_t target\_duty, uint32\_t scale, uint32\_t cycle\_num, *ledc\_fade\_mode\_t* fade\_mode)

A thread-safe API to set and start LEDC fade function.

---

**备注:** Call `ledc_fade_func_install()` once before calling this function.

---



---

**备注:** For ESP32, hardware does not support any duty change while a fade operation is running in progress on that channel. Other duty operations will have to wait until the fade operation has finished.

---

**参数**

- **speed\_mode** -- Select the LEDC channel group with specified speed mode. Note that not all targets support high speed mode.
- **channel** -- LEDC channel index (0 - LEDC\_CHANNEL\_MAX-1), select from `ledc_channel_t`

- **target\_duty** -- Target duty of fading [0, (2\*\*duty\_resolution)]
- **scale** -- Controls the increase or decrease step scale.
- **cycle\_num** -- increase or decrease the duty every cycle\_num cycles
- **fade\_mode** -- choose blocking or non-blocking mode

**返回**

- ESP\_OK Success
- ESP\_ERR\_INVALID\_ARG Parameter error
- ESP\_ERR\_INVALID\_STATE Channel not initialized
- ESP\_FAIL Fade function init error

*esp\_err\_t* **ledc\_cb\_register** (*ledc\_mode\_t* speed\_mode, *ledc\_channel\_t* channel, *ledc\_cbs\_t* \*cbs, void \*user\_arg)

LEDC callback registration function.

---

**备注:** The callback is called from an ISR, it must never attempt to block, and any FreeRTOS API called must be ISR capable.

---

**参数**

- **speed\_mode** -- Select the LEDC channel group with specified speed mode. Note that not all targets support high speed mode.
- **channel** -- LEDC channel index (0 - LEDC\_CHANNEL\_MAX-1), select from *ledc\_channel\_t*
- **cbs** -- Group of LEDC callback functions
- **user\_arg** -- user registered data for the callback function

**返回**

- ESP\_OK Success
- ESP\_ERR\_INVALID\_ARG Parameter error
- ESP\_ERR\_INVALID\_STATE Channel not initialized
- ESP\_FAIL Fade function init error

*esp\_err\_t* **ledc\_set\_multi\_fade** (*ledc\_mode\_t* speed\_mode, *ledc\_channel\_t* channel, uint32\_t start\_duty, const *ledc\_fade\_param\_config\_t* \*fade\_params\_list, uint32\_t list\_len)

Set a LEDC multi-fade.

---

**备注:** Call `ledc_fade_func_install()` once before calling this function. Call `ledc_fade_start()` after this to start fading.

---



---

**备注:** This function is not thread-safe, do not call it to control one LEDC channel in different tasks at the same time. A thread-safe version of API is `ledc_set_multi_fade_and_start`

---



---

**备注:** This function does not prohibit from duty overflow. User should take care of this by themselves. If duty overflow happens, the PWM signal will suddenly change from 100% duty cycle to 0%, or the other way around.

---

**参数**

- **speed\_mode** -- Select the LEDC channel group with specified speed mode. Note that not all targets support high speed mode.
- **channel** -- LEDC channel index (0 - LEDC\_CHANNEL\_MAX-1), select from *ledc\_channel\_t*
- **start\_duty** -- Set the start of the gradient duty, the range of duty setting is [0, (2\*\*duty\_resolution)]

- **fade\_params\_list** -- Pointer to the array of fade parameters for a multi-fade
- **list\_len** -- Length of the fade\_params\_list, i.e. number of fade ranges for a multi-fade (1 - SOC\_LEDC\_GAMMA\_CURVE\_FADE\_RANGE\_MAX)

**返回**

- ESP\_OK Success
- ESP\_ERR\_INVALID\_ARG Parameter error
- ESP\_ERR\_INVALID\_STATE Channel not initialized
- ESP\_FAIL Fade function init error

*esp\_err\_t* **ledc\_set\_multi\_fade\_and\_start** (*ledc\_mode\_t* speed\_mode, *ledc\_channel\_t* channel, uint32\_t start\_duty, const *ledc\_fade\_param\_config\_t* \*fade\_params\_list, uint32\_t list\_len, *ledc\_fade\_mode\_t* fade\_mode)

A thread-safe API to set and start LEDC multi-fade function.

---

**备注:** Call `ledc_fade_func_install()` once before calling this function.

---



---

**备注:** Fade will always begin from the current duty cycle. Make sure it is stable and synchronized to the desired initial value before calling this function. Otherwise, you may see unexpected duty change.

---



---

**备注:** This function does not prohibit from duty overflow. User should take care of this by themselves. If duty overflow happens, the PWM signal will suddenly change from 100% duty cycle to 0%, or the other way around.

---

**参数**

- **speed\_mode** -- Select the LEDC channel group with specified speed mode. Note that not all targets support high speed mode.
- **channel** -- LEDC channel index (0 - LEDC\_CHANNEL\_MAX-1), select from `ledc_channel_t`
- **start\_duty** -- Set the start of the gradient duty, the range of duty setting is [0, (2\*duty\_resolution)]
- **fade\_params\_list** -- Pointer to the array of fade parameters for a multi-fade
- **list\_len** -- Length of the fade\_params\_list, i.e. number of fade ranges for a multi-fade (1 - SOC\_LEDC\_GAMMA\_CURVE\_FADE\_RANGE\_MAX)
- **fade\_mode** -- Choose blocking or non-blocking mode

**返回**

- ESP\_OK Success
- ESP\_ERR\_INVALID\_ARG Parameter error
- ESP\_ERR\_INVALID\_STATE Channel not initialized
- ESP\_FAIL Fade function init error

*esp\_err\_t* **ledc\_fill\_multi\_fade\_param\_list** (*ledc\_mode\_t* speed\_mode, *ledc\_channel\_t* channel, uint32\_t start\_duty, uint32\_t end\_duty, uint32\_t linear\_phase\_num, uint32\_t max\_fade\_time\_ms, uint32\_t (\*gamma\_correction\_operator)(uint32\_t), uint32\_t fade\_params\_list\_size, *ledc\_fade\_param\_config\_t* \*fade\_params\_list, uint32\_t \*hw\_fade\_range\_num)

Helper function to fill the fade params for a multi-fade. Useful if desires a gamma curve fading.

---

**备注:** The fade params are calculated based on the given start\_duty and end\_duty. If the duty is not at the start duty (gamma-corrected) when the fade begins, you may see undesired brightness change. Therefore, please always remember that when passing the fade\_params to either `ledc_set_multi_fade`

or `ledc_set_multi_fade_and_start`, the `start_duty` argument has to be the gamma-corrected `start_duty`.

### 参数

- **speed\_mode** -- [in] Select the LEDC channel group with specified speed mode. Note that not all targets support high speed mode.
- **channel** -- [in] LEDC channel index (0 - LEDC\_CHANNEL\_MAX-1), select from `ledc_channel_t`
- **start\_duty** -- [in] Duty cycle [0, (2\*\*duty\_resolution)] where the multi-fade begins with. This value should be a non-gamma-corrected duty cycle.
- **end\_duty** -- [in] Duty cycle [0, (2\*\*duty\_resolution)] where the multi-fade ends with. This value should be a non-gamma-corrected duty cycle.
- **linear\_phase\_num** -- [in] Number of linear fades to simulate a gamma curved fade (1 - SOC\_LEDC\_GAMMA\_CURVE\_FADE\_RANGE\_MAX)
- **max\_fade\_time\_ms** -- [in] The maximum time of the fading ( ms ).
- **gamma\_correction\_operator** -- [in] User provided gamma correction function. The function argument should be able to take any value within [0, (2\*\*duty\_resolution)]. And returns the gamma-corrected duty cycle.
- **fade\_params\_list\_size** -- [in] The size of the `fade_params_list` user allocated (1 - SOC\_LEDC\_GAMMA\_CURVE\_FADE\_RANGE\_MAX)
- **fade\_params\_list** -- [out] Pointer to the array of `ledc_fade_param_config_t` structure
- **hw\_fade\_range\_num** -- [out] Number of fade ranges for this multi-fade

### 返回

- ESP\_OK Success
- ESP\_ERR\_INVALID\_ARG Parameter error
- ESP\_ERR\_INVALID\_STATE Channel not initialized
- ESP\_FAIL Required number of hardware ranges exceeds the size of the `ledc_fade_param_config_t` array user allocated

`esp_err_t ledc_read_fade_param` (`ledc_mode_t` speed\_mode, `ledc_channel_t` channel, `uint32_t` range, `uint32_t *dir`, `uint32_t *cycle`, `uint32_t *scale`, `uint32_t *step`)

Get the fade parameters that are stored in gamma ram for a certain fade range.

Gamma ram is where saves the fade parameters for each fade range. The fade parameters are written in during fade configuration. When fade begins, the duty will change according to the parameters in gamma ram.

### 参数

- **speed\_mode** -- [in] Select the LEDC channel group with specified speed mode. Note that not all targets support high speed mode.
- **channel** -- [in] LEDC channel index (0 - LEDC\_CHANNEL\_MAX-1), select from `ledc_channel_t`
- **range** -- [in] Range index (0 - (SOC\_LEDC\_GAMMA\_CURVE\_FADE\_RANGE\_MAX-1)), it specifies to which range in gamma ram to read
- **dir** -- [out] Pointer to accept fade direction value
- **cycle** -- [out] Pointer to accept fade cycle value
- **scale** -- [out] Pointer to accept fade scale value
- **step** -- [out] Pointer to accept fade step value

### 返回

- ESP\_OK Success
- ESP\_ERR\_INVALID\_ARG Parameter error
- ESP\_ERR\_INVALID\_STATE Channel not initialized

## Structures

struct `ledc_channel_config_t`

Configuration parameters of LEDC channel for `ledc_channel_config` function.

**Public Members****int gpio\_num**

the LEDC output gpio\_num, if you want to use gpio16, gpio\_num = 16

*ledc\_mode\_t* **speed\_mode**

LEDC speed speed\_mode, high-speed mode (only exists on esp32) or low-speed mode

*ledc\_channel\_t* **channel**

LEDC channel (0 - LEDC\_CHANNEL\_MAX-1)

*ledc\_intr\_type\_t* **intr\_type**

configure interrupt, Fade interrupt enable or Fade interrupt disable

*ledc\_timer\_t* **timer\_sel**

Select the timer source of channel (0 - LEDC\_TIMER\_MAX-1)

**uint32\_t duty**

LEDC channel duty, the range of duty setting is [0, (2\*\*duty\_resolution)]

**int hpoint**

LEDC channel hpoint value, the range is [0, (2\*\*duty\_resolution)-1]

unsigned int **output\_invert**

Enable (1) or disable (0) gpio output invert

struct *ledc\_channel\_config\_t*::[anonymous] **flags**

LEDC flags

struct **ledc\_timer\_config\_t**

Configuration parameters of LEDC timer for ledc\_timer\_config function.

**Public Members***ledc\_mode\_t* **speed\_mode**

LEDC speed speed\_mode, high-speed mode (only exists on esp32) or low-speed mode

*ledc\_timer\_bit\_t* **duty\_resolution**

LEDC channel duty resolution

*ledc\_timer\_t* **timer\_num**

The timer source of channel (0 - LEDC\_TIMER\_MAX-1)

**uint32\_t freq\_hz**

LEDC timer frequency (Hz)

***ledc\_clk\_cfg\_t* clk\_cfg**

Configure LEDC source clock from `ledc_clk_cfg_t`. Note that `LEDC_USE_RC_FAST_CLK` and `LEDC_USE_XTAL_CLK` are non-timer-specific clock sources. You can not have one LEDC timer uses `RC_FAST_CLK` as the clock source and have another LEDC timer uses `XTAL_CLK` as its clock source. All chips except `esp32` and `esp32s2` do not have timer-specific clock sources, which means clock source for all timers must be the same one.

**bool deconfigure**

Set this field to de-configure a LEDC timer which has been configured before. Note that it will not check whether the timer wants to be de-configured is binded to any channel. Also, the timer has to be paused first before it can be de-configured. When this field is set, `duty_resolution`, `freq_hz`, `clk_cfg` fields are ignored.

**struct ledc\_cb\_param\_t**

LEDC callback parameter.

**Public Members*****ledc\_cb\_event\_t* event**

Event name

**uint32\_t speed\_mode**

Speed mode of the LEDC channel group

**uint32\_t channel**

LEDC channel (0 - `LEDC_CHANNEL_MAX-1`)

**uint32\_t duty**

LEDC current duty of the channel, the range of duty is  $[0, (2^{**}duty\_resolution)]$

**struct ledc\_cbs\_t**

Group of supported LEDC callbacks.

---

**备注:** The callbacks are all running under ISR environment

---

**Public Members*****ledc\_cb\_t* fade\_cb**

LEDC `fade_end` callback function

**struct ledc\_fade\_param\_config\_t**

Structure for the fade parameters for one hardware fade to be written to gamma wr register.

*	duty ^	ONE HW LINEAR FADE
*		
*		
*		
*		

(下页继续)



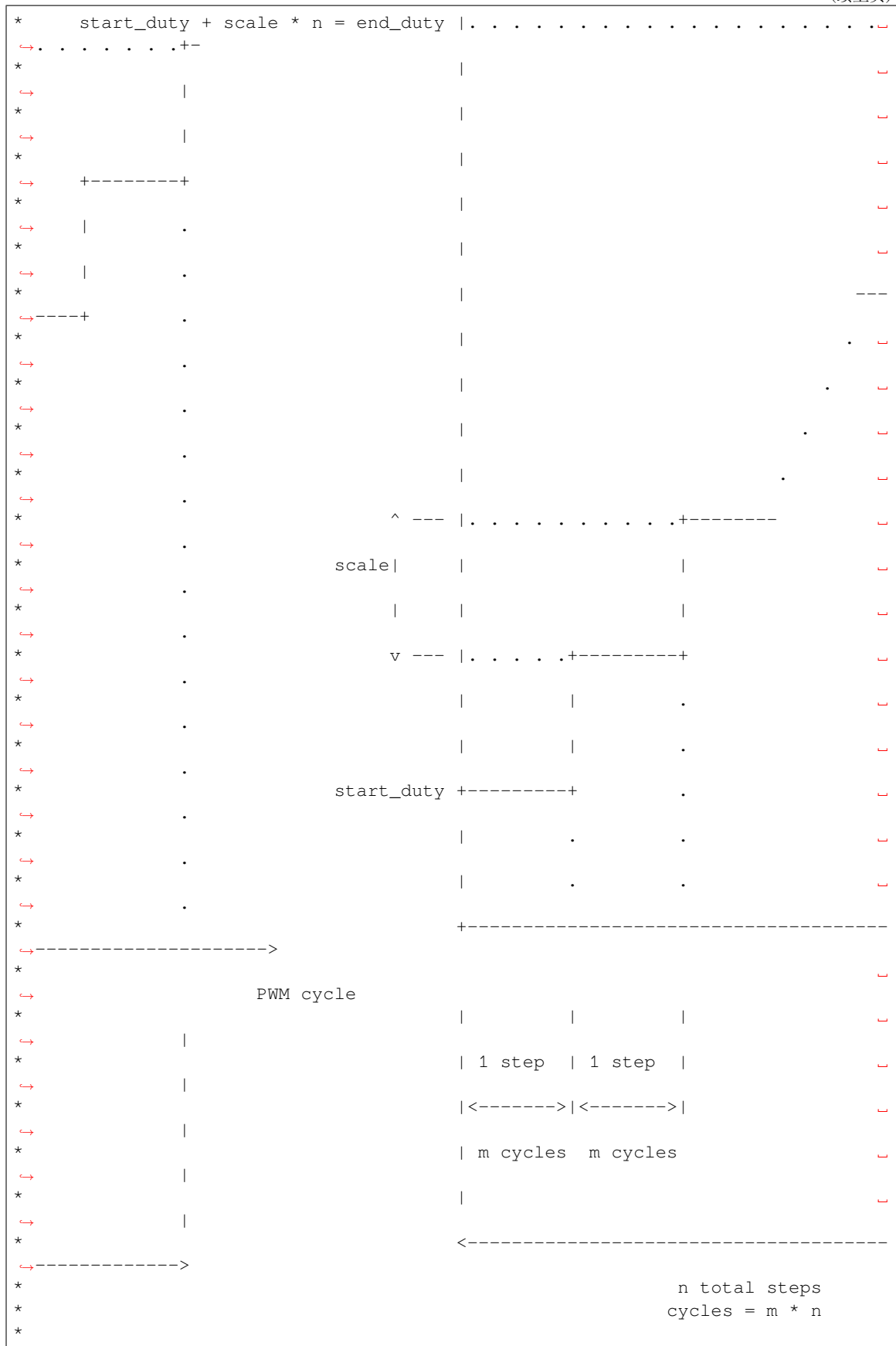

---

**备注:** Be aware of the maximum value available on each element

---

### Public Members

uint32\_t **dir**

Duty change direction. Set 1 as increase, 0 as decrease

uint32\_t **cycle\_num**

Number of PWM cycles of each step [0, 2\*\*SOC\_LEDC\_FADE\_PARAMS\_BIT\_WIDTH-1]

uint32\_t **scale**

Duty change of each step [0, 2\*\*SOC\_LEDC\_FADE\_PARAMS\_BIT\_WIDTH-1]

uint32\_t **step\_num**

Total number of steps in one hardware fade [0, 2\*\*SOC\_LEDC\_FADE\_PARAMS\_BIT\_WIDTH-1]

### Macros

**LEDC\_ERR\_DUTY**

**LEDC\_ERR\_VAL**

### Type Definitions

typedef *intr\_handle\_t* **ledc\_isr\_handle\_t**

typedef bool (\***ledc\_cb\_t**)(const *ledc\_cb\_param\_t* \*param, void \*user\_arg)

Type of LEDC event callback.

**Param param** LEDC callback parameter

**Param user\_arg** User registered data

**Return** Whether a high priority task has been waken up by this function

### Enumerations

enum **ledc\_cb\_event\_t**

LEDC callback event type.

*Values:*

enumerator **LEDC\_FADE\_END\_EVT**

LEDC fade end event

### Header File

- `components/hal/include/hal/ledc_types.h`
- This header file can be included with:

```
#include "hal/ledc_types.h"
```

## Type Definitions

typedef *soc\_periph\_ledc\_clk\_src\_legacy\_t* **ledc\_clk\_cfg\_t**

LEDC clock source configuration struct.

In theory, the following enumeration shall be placed in LEDC driver's header. However, as the next enumeration, *ledc\_clk\_src\_t*, makes the use of some of these values and to avoid mutual inclusion of the headers, we must define it here.

## Enumerations

enum **ledc\_mode\_t**

*Values:*

enumerator **LEDC\_LOW\_SPEED\_MODE**

LEDC low speed speed\_mode

enumerator **LEDC\_SPEED\_MODE\_MAX**

LEDC speed limit

enum **ledc\_intr\_type\_t**

*Values:*

enumerator **LEDC\_INTR\_DISABLE**

Disable LEDC interrupt

enumerator **LEDC\_INTR\_FADE\_END**

Enable LEDC interrupt

enumerator **LEDC\_INTR\_MAX**

enum **ledc\_duty\_direction\_t**

*Values:*

enumerator **LEDC\_DUTY\_DIR\_DECREASE**

LEDC duty decrease direction

enumerator **LEDC\_DUTY\_DIR\_INCREASE**

LEDC duty increase direction

enumerator **LEDC\_DUTY\_DIR\_MAX**

enum **ledc\_slow\_clk\_sel\_t**

LEDC global clock sources.

*Values:*

enumerator **LEDC\_SLOW\_CLK\_RC\_FAST**

LEDC low speed timer clock source is RC\_FAST clock

enumerator **LEDC\_SLOW\_CLK\_PLL\_DIV**

LEDC low speed timer clock source is a PLL\_DIV clock

enumerator **LEDC\_SLOW\_CLK\_XTAL**

LEDC low speed timer clock source XTAL clock

enumerator **LEDC\_SLOW\_CLK\_RTC8M**

Alias of 'LEDC\_SLOW\_CLK\_RC\_FAST'

enum **ledc\_clk\_src\_t**

LEDC timer-specific clock sources.

Note: Setting numeric values to match `ledc_clk_cfg_t` values are a hack to avoid collision with `LEDC_AUTO_CLK` in the driver, as these enums have very similar names and user may pass one of these by mistake.

*Values:*

enumerator **LEDC\_SCLK**

Selecting this value for `LEDC_TICK_SEL_TIMER` let the hardware take its source clock from `LEDC_CLK_SEL`

enum **ledc\_timer\_t**

*Values:*

enumerator **LEDC\_TIMER\_0**

LEDC timer 0

enumerator **LEDC\_TIMER\_1**

LEDC timer 1

enumerator **LEDC\_TIMER\_2**

LEDC timer 2

enumerator **LEDC\_TIMER\_3**

LEDC timer 3

enumerator **LEDC\_TIMER\_MAX**

enum **ledc\_channel\_t**

*Values:*

enumerator **LEDC\_CHANNEL\_0**

LEDC channel 0

enumerator **LEDC\_CHANNEL\_1**

LEDC channel 1

enumerator **LEDC\_CHANNEL\_2**

LEDC channel 2

enumerator **LEDC\_CHANNEL\_3**

LEDC channel 3

enumerator **LEDC\_CHANNEL\_4**

LEDC channel 4

enumerator **LEDC\_CHANNEL\_5**

LEDC channel 5

enumerator **LEDC\_CHANNEL\_MAX**

enum **ledc\_timer\_bit\_t**

*Values:*

enumerator **LEDC\_TIMER\_1\_BIT**

LEDC PWM duty resolution of 1 bits

enumerator **LEDC\_TIMER\_2\_BIT**

LEDC PWM duty resolution of 2 bits

enumerator **LEDC\_TIMER\_3\_BIT**

LEDC PWM duty resolution of 3 bits

enumerator **LEDC\_TIMER\_4\_BIT**

LEDC PWM duty resolution of 4 bits

enumerator **LEDC\_TIMER\_5\_BIT**

LEDC PWM duty resolution of 5 bits

enumerator **LEDC\_TIMER\_6\_BIT**

LEDC PWM duty resolution of 6 bits

enumerator **LEDC\_TIMER\_7\_BIT**

LEDC PWM duty resolution of 7 bits

enumerator **LEDC\_TIMER\_8\_BIT**

LEDC PWM duty resolution of 8 bits

enumerator **LEDC\_TIMER\_9\_BIT**

LEDC PWM duty resolution of 9 bits

enumerator **LEDC\_TIMER\_10\_BIT**

LEDC PWM duty resolution of 10 bits

enumerator **LEDC\_TIMER\_11\_BIT**

LEDC PWM duty resolution of 11 bits

enumerator **LEDC\_TIMER\_12\_BIT**

LEDC PWM duty resolution of 12 bits

enumerator **LEDC\_TIMER\_13\_BIT**

LEDC PWM duty resolution of 13 bits

enumerator **LEDC\_TIMER\_14\_BIT**  
LEDC PWM duty resolution of 14 bits

enumerator **LEDC\_TIMER\_15\_BIT**  
LEDC PWM duty resolution of 15 bits

enumerator **LEDC\_TIMER\_16\_BIT**  
LEDC PWM duty resolution of 16 bits

enumerator **LEDC\_TIMER\_17\_BIT**  
LEDC PWM duty resolution of 17 bits

enumerator **LEDC\_TIMER\_18\_BIT**  
LEDC PWM duty resolution of 18 bits

enumerator **LEDC\_TIMER\_19\_BIT**  
LEDC PWM duty resolution of 19 bits

enumerator **LEDC\_TIMER\_20\_BIT**  
LEDC PWM duty resolution of 20 bits

enumerator **LEDC\_TIMER\_BIT\_MAX**

enum **ledc\_fade\_mode\_t**

*Values:*

enumerator **LEDC\_FADE\_NO\_WAIT**  
LEDC fade function will return immediately

enumerator **LEDC\_FADE\_WAIT\_DONE**  
LEDC fade function will block until fading to the target duty

enumerator **LEDC\_FADE\_MAX**

## 2.6.17 电机控制脉宽调制器 (MCPWM)

MCPWM 外设是一个多功能 PWM 生成器，集成多个子模块，在电力电子应用（如电机控制、数字电源等）中至关重要。MCPWM 外设通常适用于以下场景：

- 数字电机控制，如有刷/无刷直流电机、RC 伺服电机
- 基于开关模式的数字电源转换
- 功率数模转换器 (Power DAC)，其中占空比等于 DAC 的模拟值
- 计算外部脉宽，并将其转换为其他模拟值，如速度、距离
- 为磁场定向控制 (FOC) 生成空间矢量调制 (SVPWM) 信号

外设的主要子模块如下图所示：

- **MCPWM 定时器模块**：最终输出 PWM 信号的时间基准。它也决定了其他子模块的事件时序。
- **MCPWM 操作器模块**：生成 PWM 波形的关键模块。它由其他子模块组成，如比较器、PWM 生成器、死区生成器和载波调制器。



图 15: MCPWM 概述

- **MCPWM 比较器模块**: 输入时间基准值, 并不断与配置的阈值进行比较。当定时器计数值等于任何一个阈值时, 生成一个比较事件, MCPWM 生成器随即相应更新其电平。
- **MCPWM 生成器模块**: 根据 MCPWM 定时器、MCPWM 比较器等子模块触发的各种事件, 生成一对独立或互补的 PWM 波形。
- **MCPWM 故障检测模块**: 通过 GPIO 交换矩阵检测外部的故障情况。检测到故障信号时, MCPWM 操作器将强制所有生成器进入预先定义的状态, 从而保护系统。
- **MCPWM 同步模块**: 同步 MCPWM 定时器, 以确保由不同的 MCPWM 生成器最终生成的 PWM 信号具有固定的相位差。可以通过 GPIO 交换矩阵和 MCPWM 定时器事件生成同步信号。
- **死区生成器模块**: 在此前生成的 PWM 边沿上插入额外的延迟。
- **载波模块**: 可通过 PWM 波形生成器和死区生成器, 将一个高频载波信号调制为 PWM 波形, 这是控制功率开关器件的必需功能。
- **制动控制**: MCPWM 操作器支持配置检测到特定故障时生成器的制动控制方式。根据故障的严重程度, 可以选择立即关闭或是逐周期调节 PWM 输出。
- **MCPWM 捕获模块**: 独立子模块, 不依赖于上述 MCPWM 操作器工作。捕获模块包括一个专用的定时器和几个独立的通道, 每个通道都与 GPIO 相连。GPIO 上的脉冲触发捕获定时器以存储时间基准值, 随后通过中断进行通知。此模块有助于更加精准地测量脉宽。此外, 捕获定时器也可以通过 MCPWM 同步子模块进行同步。

## 功能概述

下文将分节概述 MCPWM 的功能:

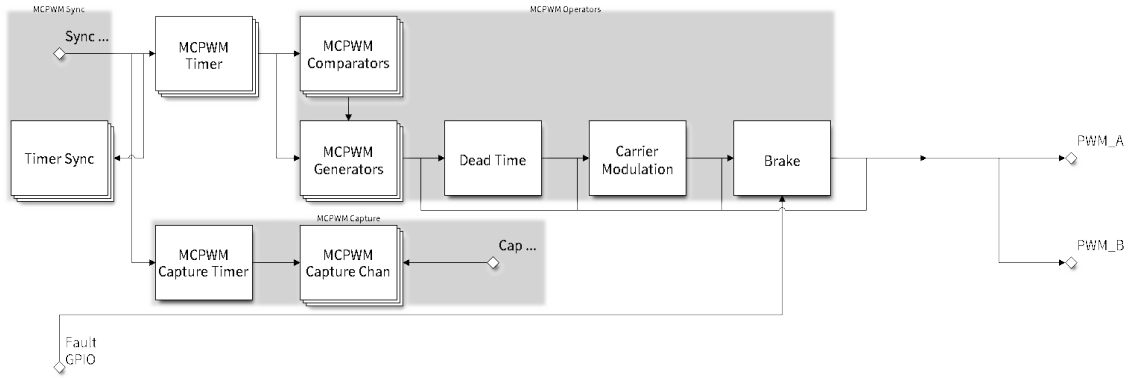
- **资源配置及初始化** - 介绍各类 MCPWM 模块的分配, 如定时器、操作器、比较器、生成器等。随后介绍的 IO 设置和控制功能也将围绕这些模块进行。
- **定时器操作和事件** - 介绍 MCPWM 定时器支持的控制功能和事件回调。
- **比较器操作和事件** - 介绍 MCPWM 比较器支持的控制功能和事件回调。
- **生成器对事件执行的操作** - 介绍如何针对 MCPWM 定时器和比较器生成的特定事件, 设置 MCPWM 生成器的相应执行操作。
- **经典 PWM 波形的生成器配置** - 介绍一些经典 PWM 波形的生成器配置。
- **死区** - 介绍如何设置 MCPWM 生成器的死区时间。
- **经典 PWM 波形的死区配置** - 介绍一些经典 PWM 波形的死区配置。
- **载波调制** - 介绍如何在最终输出的 PWM 波形上调制高频载波。
- **故障检测和制动控制** - 介绍如何为 MCPWM 操作器配置特定故障事件下的制动操作。
- **生成器强制操作** - 介绍如何强制异步控制生成器的输出水平。
- **同步模块** - 介绍如何同步 MCPWM 定时器, 并确保生成的最终输出 PWM 信号具有固定的相位差。
- **捕获模块** - 介绍如何使用 MCPWM 捕获模块测量信号脉宽。
- **ETM 事件与任务** - MCPWM 提供了哪些事件和任务可以连接到 ETM 通道上。
- **电源管理** - 介绍不同的时钟源对功耗的影响。
- **IRAM 安全** - 介绍如何协调 RMT 中断与禁用缓存。

- [线程安全](#) - 列出了由驱动程序认证为线程安全的 API。
- [Kconfig 选项](#) - 列出了针对驱动的数个 Kconfig 支持选项。

**资源配置及初始化** 如上图所示，MCPWM 外设由数个模块组成。本节将介绍各个子模块的资源配置方式。

**MCPWM 定时器** 调用 `mcpwm_new_timer()` 函数，以配置结构体 `mcpwm_timer_config_t` 为参数，分配一个 MCPWM 定时器为对象。结构体定义为：

- `mcpwm_timer_config_t::group_id` 指定 MCPWM 组 ID，范围为 [0, `SOC_MCPWM_GROUPS` - 1]。需注意，位于不同组的定时器彼此独立。
- `mcpwm_timer_config_t::intr_priority` 设置中断的优先级。如果设置为 0，则会分配一个默认优先级的中断，否则会使用指定的优先级。
- `mcpwm_timer_config_t::clk_src` 设置定时器的时钟源。
- `mcpwm_timer_config_t::resolution_hz` 设置定时器的预期分辨率。内部驱动将根据时钟源和分辨率设置合适的分频器。
- `mcpwm_timer_config_t::count_mode` 设置定时器的计数模式。
- `mcpwm_timer_config_t::period_ticks` 设置定时器的周期，以 Tick 为单位（通过 `mcpwm_timer_config_t::resolution_hz` 设置 Tick 分辨率）。
- `mcpwm_timer_config_t::update_period_on_empty` 设置当定时器计数为零时是否更新周期值。
- `mcpwm_timer_config_t::update_period_on_sync` 设置当定时器接收同步信号时是否更新周期值。

分配成功后，`mcpwm_new_timer()` 将返回一个指向已分配定时器的指针。否则，函数将返回错误代码。具体来说，当 MCPWM 组中没有空闲定时器时，将返回 `ESP_ERR_NOT_FOUND` 错误。<sup>1</sup>

反之，调用 `mcpwm_del_timer()` 函数将释放已分配的定时器。

**MCPWM 操作器** 调用 `mcpwm_new_operator()` 函数，以配置结构体 `mcpwm_operator_config_t` 为参数，分配一个 MCPWM 操作器为对象。结构体定义为：

- `mcpwm_operator_config_t::group_id` 指定 MCPWM 组 ID，范围为 [0, `SOC_MCPWM_GROUPS` - 1]。需注意，位于不同组的操作器彼此独立。
- `mcpwm_operator_config_t::intr_priority` 设置中断的优先级。如果设置为 0，则会分配一个默认优先级的中断，否则会使用指定的优先级。
- `mcpwm_operator_config_t::update_gen_action_on_tez` 设置是否在定时器计数为零时更新生成器操作。此处及下文提到的定时器指通过 `mcpwm_operator_connect_timer()` 连接到操作器的定时器。
- `mcpwm_operator_config_t::update_gen_action_on_tep` 设置当定时器计数达到峰值时是否更新生成器操作。
- `mcpwm_operator_config_t::update_gen_action_on_sync` 设置当定时器接收同步信号时是否更新生成器操作。
- `mcpwm_operator_config_t::update_dead_time_on_tez` 设置当定时器计数为零时是否更新死区时间。
- `mcpwm_operator_config_t::update_dead_time_on_tep` 设置当定时器计数达到峰值时是否更新死区时间。
- `mcpwm_operator_config_t::update_dead_time_on_sync` 设置当定时器接收同步信号时是否更新死区时间。

分配成功后，`mcpwm_new_operator()` 将返回一个指向已分配操作器的指针。否则，函数将返回错误代码。具体来说，当 MCPWM 组中没有空闲操作器时，将返回 `ESP_ERR_NOT_FOUND` 错误。<sup>1</sup>

反之，调用 `mcpwm_del_operator()` 函数将释放已分配的操作器。

<sup>1</sup> 不同的 ESP 芯片上的 MCPWM 资源数量可能存在差异（如组、定时器、比较器、操作器、生成器、触发器等）。详情请参见 [TRM]。当分配了超出资源数量的 MCPWM 资源时，在检测到没有可用硬件资源后，驱动程序将返回错误。请在进行资源配置及初始化时务必检查返回值。



**MCPWM 比较器** 调用 `mcpwm_new_comparator()` 函数，以一个 MCPWM 操作器句柄和配置结构体 `mcpwm_comparator_config_t` 为参数，分配一个 MCPWM 比较器为对象。操作器句柄由 `mcpwm_new_operator()` 生成，结构体定义为：

- `mcpwm_comparator_config_t::intr_priority` 设置中断的优先级。如果设置为 0，则会分配一个默认优先级的中断，否则会使用指定的优先级。
- `mcpwm_comparator_config_t::update_cmp_on_tez` 设置当定时器计数为零时是否更新比较阈值。
- `mcpwm_comparator_config_t::update_cmp_on_tep` 设置当定时器计数达到峰值时是否更新比较阈值。
- `mcpwm_comparator_config_t::update_cmp_on_sync` 设置当定时器接收同步信号时是否更新比较阈值。

分配成功后，`mcpwm_new_comparator()` 将返回一个指向已分配比较器的指针。否则，函数将返回错误代码。具体来说，当 MCPWM 操作器中没有空闲比较器时，将返回 `ESP_ERR_NOT_FOUND` 错误。<sup>Page 995, 1</sup>

反之，调用 `mcpwm_del_comparator()` 函数将释放已分配的比较器。

**MCPWM 生成器** 调用 `mcpwm_new_generator()` 函数，以一个 MCPWM 操作器句柄和配置结构体 `mcpwm_generator_config_t` 为参数，分配一个 MCPWM 生成器为对象。操作器句柄由 `mcpwm_new_operator()` 生成，结构体定义为：

- `mcpwm_generator_config_t::gen_gpio_num` 设置生成器使用的 GPIO 编号。
- `mcpwm_generator_config_t::invert_pwm` 设置是否反相 PWM 信号。
- `mcpwm_generator_config_t::io_loop_back` 设置是否启用回环模式。该模式仅用于调试，使用 GPIO 交换矩阵外设同时启用 GPIO 输入和输出。
- `mcpwm_generator_config_t::io_od_mode` 设置是否启用漏极开路输出。
- `mcpwm_generator_config_t::pull_up` 和 `mcpwm_generator_config_t::pull_down` 用来设置是否启用内部上下拉电阻。

分配成功后，`mcpwm_new_generator()` 将返回一个指向已分配生成器的指针。否则，函数将返回错误代码。具体来说，当 MCPWM 操作器中没有空闲生成器时，将返回 `ESP_ERR_NOT_FOUND` 错误。<sup>Page 995, 1</sup>

反之，调用 `mcpwm_del_generator()` 函数将释放已分配的生成器。

**MCPWM 故障** MCPWM 故障分为两种类型：来自 GPIO 的故障信号和软件故障。

调用 `mcpwm_new_gpio_fault()` 函数，以配置结构体 `mcpwm_gpio_fault_config_t` 为参数，分配一个 GPIO 故障为对象。结构体定义为：

- `mcpwm_gpio_fault_config_t::group_id` 设置 MCPWM 组 ID，范围为 [0, `SOC_MCPWM_GROUPS` - 1]。需注意，位于不同组的 GPIO 故障彼此独立，也就是说，1 组的操作器无法检测到 0 组的 GPIO 故障。
- `mcpwm_gpio_fault_config_t::intr_priority` 设置中断的优先级。如果设置为 0，则会分配一个默认优先级的中断，否则会使用指定的优先级。
- `mcpwm_gpio_fault_config_t::gpio_num` 设置故障所使用的 GPIO 编号。
- `mcpwm_gpio_fault_config_t::active_level` 设置故障信号的有效电平。
- `mcpwm_gpio_fault_config_t::pull_up` 和 `mcpwm_gpio_fault_config_t::pull_down` 设置是否在内部拉高和/或拉低 GPIO。
- `mcpwm_gpio_fault_config_t::io_loop_back` 设置是否启用回环模式。该模式仅用于调试，使用 GPIO 交换矩阵外设同时启用 GPIO 输入和输出。

分配成功后，`mcpwm_new_gpio_fault()` 将返回一个指向已分配故障的指针。否则，函数将返回错误代码。具体来说，当指定 MCPWM 组中没有空闲 GPIO 故障时，将返回 `ESP_ERR_NOT_FOUND` 错误。<sup>Page 995, 1</sup>

调用函数 `mcpwm_soft_fault_activate()` 使一个软件故障对象触发故障，无需等待来自 GPIO 的真实故障信号。调用 `mcpwm_new_soft_fault()` 函数，以配置结构体 `mcpwm_soft_fault_config_t` 为参数，分配一个软件故障为对象。该结构体暂时保留，供后续使用。

分配成功后，`mcpwm_new_soft_fault()` 将返回一个指向已分配故障的指针。否则，函数将返回错误代码。具体来说，当内存不足以支持该故障对象时，将返回 `ESP_ERR_NO_MEM` 错误。虽然软件故障和 GPIO 故障是不同类型的故障，但返回的故障句柄为同一类型。

反之，调用 `mcpwm_del_fault()` 函数将释放已分配的故障。此函数同时适用于软件故障和 GPIO 故障。

**MCPWM 同步源** 同步源用于同步 MCPWM 定时器和 MCPWM 捕获定时器，分为三种类型：来自 GPIO 的同步源、软件生成的同步源和 MCPWM 定时器事件生成的同步源。

调用 `mcpwm_new_gpio_sync_src()` 函数，以配置结构体 `mcpwm_gpio_sync_src_config_t` 为参数，分配一个 GPIO 同步源。结构体定义为：

- `mcpwm_gpio_sync_src_config_t::group_id` 指定 MCPWM 组 ID，范围为 [0, `SOC_MCPWM_GROUPS` - 1]。需注意，位于不同组的 GPIO 同步源彼此独立，也就是说，1 组的定时器无法检测到 0 组的 GPIO 同步源。
- `mcpwm_gpio_sync_src_config_t::gpio_num` 设置同步源使用的 GPIO 编号。
- `mcpwm_gpio_sync_src_config_t::active_neg` 设置同步信号在下降沿是否有效。
- `mcpwm_gpio_sync_src_config_t::pull_up` 和 `mcpwm_gpio_sync_src_config_t::pull_down` 设置是否在内部拉高和/或拉低 GPIO。
- `mcpwm_gpio_sync_src_config_t::io_loop_back` 设置是否启用回环模式。该模式仅用于调试，使用 GPIO 交换矩阵外设同时启用 GPIO 输入和输出。

分配成功后，`mcpwm_new_gpio_sync_src()` 将返回一个指向已分配同步源的指针。否则，函数将返回错误代码。具体来说，当 MCPWM 组中没有空闲 GPIO 时钟源时，将返回 `ESP_ERR_NOT_FOUND` 错误。Page 995, 1

调用 `mcpwm_new_timer_sync_src()` 函数，以配置结构体 `mcpwm_timer_sync_src_config_t` 为参数，分配一个定时器事件同步源。结构体定义为：

- `mcpwm_timer_sync_src_config_t::timer_event` 指定产生同步信号的定时器事件。
- `mcpwm_timer_sync_src_config_t::propagate_input_sync` 是否广播输入同步信号（即将输入同步信号传输到其同步输出）。

分配成功后，`mcpwm_new_timer_sync_src()` 将返回一个指向已分配同步源的指针。否则，函数将返回错误代码。具体来说，若是分配的同步源此前已分配给了同一个定时器，将返回 `ESP_ERR_INVALID_STATE` 错误。

也可以调用 `mcpwm_new_soft_sync_src()` 函数，以配置结构体 `mcpwm_soft_sync_config_t` 为参数，分配一个软件同步源。该结构体暂时保留，供后续使用。

分配成功后，`mcpwm_new_soft_sync_src()` 将返回一个指向已分配同步源的指针。否则，函数将返回错误代码。具体来说，当内存不足以支持分配的同步源时，将返回 `ESP_ERR_NO_MEM` 错误。需注意，为确保软件同步源能够正常工作，应预先调用 `mcpwm_soft_sync_activate()`。

相反，调用 `mcpwm_del_sync_src()` 函数将释放分配的同步源对象。此函数适用于所有类型的同步源。

**MCPWM 捕获定时器和通道** MCPWM 组有一个专用定时器，用于捕获特定事件发生时的时间戳。捕获定时器连接了数个独立通道，每个通道都分配了各自的 GPIO。

调用 `mcpwm_new_capture_timer()` 函数，以配置结构体 `mcpwm_capture_timer_config_t` 为参数，分配一个捕获定时器。结构体定义为：

- `mcpwm_capture_timer_config_t::group_id` 设置 MCPWM 组 ID，范围为 [0, `SOC_MCPWM_GROUPS` - 1]。
- `mcpwm_capture_timer_config_t::clk_src` 设置捕获定时器的时钟源。
- `mcpwm_capture_timer_config_t::resolution_hz` 设置捕获定时器的预期分辨率。内部驱动将根据时钟源和分辨率设置合适的分频器。设置为 0 时，驱动会自己选取一个适当的分辨率，后续你可以通过 `mcpwm_capture_timer_get_resolution()` 查看当前定时器的分辨率。

分配成功后，`mcpwm_new_capture_timer()` 将返回一个指向已分配捕获定时器的指针。否则，函数将返回错误代码。具体来说，当 MCPWM 组中没有空闲捕获定时器时，将返回 `ESP_ERR_NOT_FOUND` 错误。Page 995, 1

接下来，可以调用 `mcpwm_new_capture_channel()` 函数，以一个捕获定时器句柄和配置结构体 `mcpwm_capture_channel_config_t` 为参数，分配一个捕获通道。结构体定义为：

- `mcpwm_capture_channel_config_t::intr_priority` 设置中断的优先级。如果设置为 0，则会分配一个默认优先级的中断，否则会使用指定的优先级。
- `mcpwm_capture_channel_config_t::gpio_num` 设置捕获通道使用的 GPIO 编号。
- `mcpwm_capture_channel_config_t::prescale` 设置输入信号的预分频器。
- `mcpwm_capture_channel_config_t::extra_flags::pos_edge` 和 `mcpwm_capture_channel_config_t::extra_flags::neg_edge` 设置是否在输入信号的上升沿和/或下降沿捕获时间戳。
- `mcpwm_capture_channel_config_t::extra_flags::pull_up` 和 `mcpwm_capture_channel_config_t::extra_flags::pull_down` 设置是否在内部拉高和/或拉低 GPIO。
- `mcpwm_capture_channel_config_t::extra_flags::invert_cap_signal` 设置是否取反捕获信号。
- `mcpwm_capture_channel_config_t::extra_flags::io_loop_back` 设置是否启用回环模式。该模式仅用于调试，使用 GPIO 交换矩阵外设同时启用 GPIO 输入和输出。
- `mcpwm_capture_channel_config_t::extra_flags::keep_io_conf_at_exit` 设置是否在删除通道时保留 GPIO 的相关配置。

分配成功后，`mcpwm_new_capture_channel()` 将返回一个指向已分配捕获通道的指针。否则，函数将返回错误代码。具体来说，当捕获定时器中没有空闲捕获通道时，将返回 `ESP_ERR_NOT_FOUND` 错误。

反之，调用 `mcpwm_del_capture_channel()` 和 `mcpwm_del_capture_timer()` 将释放已分配的捕获通道和定时器。

**MCPWM 中断优先级** MCPWM 允许为定时器、操作器、比较器、故障以及捕获事件分别配置中断，中断优先级由各自的 `config_t::intr_priority` 决定。且同一个 MCPWM 组中的事件共享同一个中断源。注册多个中断事件时，中断优先级需要保持一致。

**备注：** MCPWM 组注册多个中断事件时，驱动将以第一个事件的中断优先级作为 MCPWM 组的中断优先级。

## 定时器操作和事件

**更新定时器周期** 定时器周期在创建定时器时就已经通过 `mcpwm_timer_config_t::period_ticks` 被初始化过了。你还可以在运行期间，调用 `mcpwm_timer_set_period()` 函数来更新定时周期。新周期的生效时机由 `mcpwm_timer_config_t::update_period_on_empty` 和 `mcpwm_timer_config_t::update_period_on_sync` 共同决定。如果他们两个参数都是 `false`，那么新的定时周期会立即生效。

**注册定时器事件回调** MCPWM 定时器运行时会生成不同的事件。若有函数需在特定事件发生时调用，则应预先调用 `mcpwm_timer_register_event_callbacks()`，将所需函数挂载至中断服务程序 (ISR) 中。驱动中定时器回调函数原型声明为 `mcpwm_timer_event_cb_t`，其所支持的事件回调类型则列在 `mcpwm_timer_event_callbacks_t` 中：

- `mcpwm_timer_event_callbacks_t::on_full` 设置定时器计数达到峰值时的回调函数。
- `mcpwm_timer_event_callbacks_t::on_empty` 设置定时器计数为零时的回调函数。
- `mcpwm_timer_event_callbacks_t::on_stop` 设置定时器停止时的回调函数。

由于上述回调函数是在 ISR 中调用的，因此，这些函数不应涉及 block 操作。可以检查调用 API 的后缀，确保在函数中只调用了后缀为 ISR 的 FreeRTOS API。

函数 `mcpwm_timer_register_event_callbacks()` 中的 `user_data` 参数用于保存用户上下文，将直接传递至各个回调函数。

此函数会在不启用 MCPWM 定时器的情况下延迟安装其中断服务。因此，需在调用 `mcpwm_timer_enable()` 函数前调用该函数，否则将返回 `ESP_ERR_INVALID_STATE` 错误。更多信息请参见 [启用和禁用定时器](#)。

**启用和禁用定时器** 在对定时器进行 IO 控制前，需要预先调用 `mcpwm_timer_enable()` 函数启用定时器。这个函数将：

- 将定时器的状态从 `init` 切换到 `enable`。
- 若中断服务此前已通过 `mcpwm_timer_register_event_callbacks()` 函数延迟安装，则启用中断服务。
- 若选择了特定时钟源（例如 PLL\_160M 时钟），则获取相应的电源管理锁。更多信息请参见 [电源管理](#)。

反之，调用 `mcpwm_timer_disable()` 会将定时器切换回 `init` 状态、禁用中断服务并释放电源管理锁。

**启动和停止定时器** 通过基本的 IO 控制，即可启动和停止定时器。使用不同的 `mcpwm_timer_start_stop_cmd_t` 命令调用 `mcpwm_timer_start_stop()` 便可立即启动定时器，或在发生特定事件时停止定时器。此外，还可以通过配置，让定时器仅计数一轮。也就是说，在计数达到峰值或零后，定时器自行停止。

**连接定时器和操作器** 调用 `mcpwm_operator_connect_timer()` 函数，连接分配的 MCPWM 定时器和 MCPWM 操作器。连接后，操作器即可将定时器作为时基，生成所需的 PWM 波形。需注意，MCPWM 定时器和操作器必须位于同一个组中。否则，将返回 `ESP_ERR_INVALID_ARG` 错误。

## 比较器操作和事件

**注册比较器事件回调** MCPWM 比较器可以在定时器计数器等于比较值时发送通知。若有函数需在比较事件发生时调用，则应预先调用 `mcpwm_comparator_register_event_callbacks()`，将所需函数挂载至中断服务程序 (ISR) 中。驱动中比较器回调函数原型声明为 `mcpwm_compare_event_cb_t`，其所支持的事件回调类型则列在 `mcpwm_comparator_event_callbacks_t` 中：

- `mcpwm_comparator_event_callbacks_t::on_reach` 设置当定时器计数器等于比较值时的比较器回调函数。

回调函数会提供类型为 `mcpwm_compare_event_data_t` 的事件特定数据。由于上述回调函数是在 ISR 中调用的，因此，这些函数 **不应** 涉及 `block` 操作。可以检查调用 API 的后缀，确保在函数中只调用了后缀为 ISR 的 FreeRTOS API。

函数 `mcpwm_comparator_register_event_callbacks()` 中的 `user_data` 参数用于保存用户上下文，将直接传递至各个回调函数。

此函数会延迟安装 MCPWM 比较器的中断服务。中断服务只能通过 `mcpwm_del_comparator` 移除。

**设置比较值** 运行 MCPWM 比较器时，可以调用 `mcpwm_comparator_set_compare_value()` 设置比较值。需注意以下几点：

- 重新设置的比较值可能不会立即生效。比较值的更新时间通过 `mcpwm_comparator_config_t::update_cmp_on_tez` 或 `mcpwm_comparator_config_t::update_cmp_on_tep` 或 `mcpwm_comparator_config_t::update_cm` 配置。
- 请确保已经预先调用 `mcpwm_operator_connect_timer()` 将操作器连接至 MCPWM 定时器。否则，将返回 `ESP_ERR_INVALID_STATE` 错误。
- 比较值不应超过定时器的计数峰值。否则，将无法触发比较事件。

## 生成器对事件执行的操作



**设置生成器对定时器事件执行的操作** 调用 `mcpwm_generator_set_actions_on_timer_event()` 并辅以若干操作配置，可以针对不同的定时器事件，为生成器设置不同的操作。操作配置定义在 `mcpwm_gen_timer_event_action_t` 中：

- `mcpwm_gen_timer_event_action_t::direction` 指定定时器计数方向，可以调用 `mcpwm_timer_direction_t` 查看支持的方向。
- `mcpwm_gen_timer_event_action_t::event` 指定定时器事件，可以调用 `mcpwm_timer_event_t` 查看支持的定时器事件。
- `mcpwm_gen_timer_event_action_t::action` 指定随即进行的生成器操作，可以调用 `mcpwm_generator_action_t` 查看支持的操作。

可借助辅助宏 `MCPWM_GEN_TIMER_EVENT_ACTION` 构建定时器事件操作条目。

需注意，`mcpwm_generator_set_actions_on_timer_event()` 的参数列表 **必须** 以 `MCPWM_GEN_TIMER_EVENT_ACTION_END` 结束。

也可以调用 `mcpwm_generator_set_action_on_timer_event()` 逐一设置定时器操作，无需涉及变量参数。

**设置生成器对比较器事件执行的操作** 调用 `mcpwm_generator_set_actions_on_compare_event()` 并辅以若干操作配置，可以针对不同的比较器事件，为生成器设置不同的操作。操作配置定义在 `mcpwm_gen_compare_event_action_t` 中：

- `mcpwm_gen_compare_event_action_t::direction` 指定定时器计数方向，可以调用 `mcpwm_timer_direction_t` 查看支持的方向。
- `mcpwm_gen_compare_event_action_t::comparator` 指定比较器句柄。有关分配比较器的方法，请参见 [MCPWM 比较器](#)。
- `mcpwm_gen_compare_event_action_t::action` 指定随即进行的生成器操作，可以调用 `mcpwm_generator_action_t` 查看支持的操作。

可借助辅助宏 `MCPWM_GEN_COMPARE_EVENT_ACTION` 构建比较事件操作条目。

需注意，`mcpwm_generator_set_actions_on_compare_event()` 的参数列表 **必须** 以 `MCPWM_GEN_COMPARE_EVENT_ACTION_END` 结束。

也可以调用 `mcpwm_generator_set_action_on_compare_event()` 逐一设置比较器操作，无需涉及变量参数。

**设置生成器对故障事件执行的操作** 调用 `mcpwm_generator_set_action_on_fault_event()` 并辅以操作配置，可以针对故障事件，为生成器设置操作。操作配置定义在 `mcpwm_gen_fault_event_action_t` 中：

- `mcpwm_gen_fault_event_action_t::direction` 指定定时器计数方向，可以调用 `mcpwm_timer_direction_t` 查看支持的方向。
- `mcpwm_gen_fault_event_action_t::fault` 指定用于触发器的故障。有关分配故障的方法，请参见 [MCPWM 故障](#)。
- `mcpwm_gen_fault_event_action_t::action` 指定随即进行的生成器操作，可以调用 `mcpwm_generator_action_t` 查看支持的操作。

当生成器所属的操作器中没有空闲触发器时，将返回 `ESP_ERR_NOT_FOUND` 错误。<sup>Page 995, 1</sup>

触发器支持的故障仅为 GPIO 故障，当传入故障不为 GPIO 故障时，将返回 `ESP_ERR_NOT_SUPPORTED` 错误。

可借助辅助宏 `MCPWM_GEN_FAULT_EVENT_ACTION` 构建触发事件操作条目。

需注意，故障事件没有类似 `mcpwm_generator_set_actions_on_fault_event()` 这样的可变参数函数。

**设置生成器对同步事件执行的操作** 调用 `mcpwm_generator_set_action_on_sync_event()` 并辅以操作配置，可以针对同步事件，为生成器设置操作。操作配置定义在 `mcpwm_gen_sync_event_action_t` 中：

- `mcpwm_gen_sync_event_action_t::direction` 指定定时器计数方向，可以调用 `mcpwm_timer_direction_t` 查看支持的方向。
- `mcpwm_gen_sync_event_action_t::sync` 指定用于触发器的同步源。有关分配同步源的方法，请参见 [MCPWM 同步源](#)。
- `mcpwm_gen_sync_event_action_t::action` 指定随即进行的生成器操作，可以调用 `mcpwm_generator_action_t` 查看支持的操作。

当生成器所属的操作器中没有空闲触发器时，将返回 `ESP_ERR_NOT_FOUND` 错误。[Page 995, 1](#)

无论同步为何种类型，触发器仅支持一种同步操作，如果多次设置同步操作，将返回 `ESP_ERR_INVALID_STATE` 错误。

可借助辅助宏 `MCPWM_GEN_SYNC_EVENT_ACTION` 构建触发事件操作条目。

需注意，同步事件没有类似 `mcpwm_generator_set_actions_on_sync_event()` 这样的可变参数函数。

**经典 PWM 波形的生成器配置** 本节提供了一些生成器支持生成的经典 PWM 波形，同时提供用于生成这些波形的代码片段。总的来说：

- 生成波形为 **对称波形** 还是 **不对称波形** 取决于 MCPWM 定时器的计数模式。
- 波形对的 **激活电平** 取决于占空比较小的 PWM 波形的电平。
- PWM 波形的周期取决于定时器的周期和计数模式。
- PWM 波形的占空比取决于生成器的各种操作配置组合。

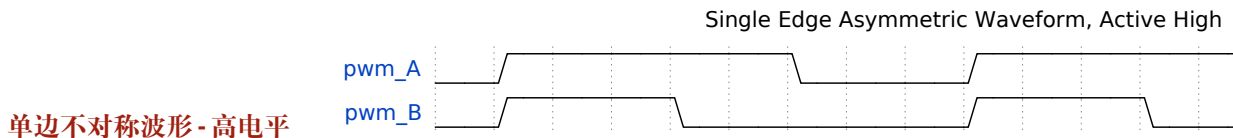

```
static void gen_action_config(mcpwm_gen_handle_t gena, mcpwm_gen_handle_t genb,
↪ mcpwm_cmpr_handle_t cmpa, mcpwm_cmpr_handle_t cmpb)
{
    ESP_ERROR_CHECK(mcpwm_generator_set_action_on_timer_event(gena,
        MCPWM_GEN_TIMER_EVENT_ACTION(MCPWM_TIMER_DIRECTION_UP, MCPWM_
↪ TIMER_EVENT_EMPTY, MCPWM_GEN_ACTION_HIGH)));
    ESP_ERROR_CHECK(mcpwm_generator_set_action_on_compare_event(gena,
        MCPWM_GEN_COMPARE_EVENT_ACTION(MCPWM_TIMER_DIRECTION_UP, cmpa,
↪ MCPWM_GEN_ACTION_LOW)));
    ESP_ERROR_CHECK(mcpwm_generator_set_action_on_timer_event(genb,
        MCPWM_GEN_TIMER_EVENT_ACTION(MCPWM_TIMER_DIRECTION_UP, MCPWM_
↪ TIMER_EVENT_EMPTY, MCPWM_GEN_ACTION_HIGH)));
    ESP_ERROR_CHECK(mcpwm_generator_set_action_on_compare_event(genb,
        MCPWM_GEN_COMPARE_EVENT_ACTION(MCPWM_TIMER_DIRECTION_UP, cmpb,
↪ MCPWM_GEN_ACTION_LOW)));
}
```

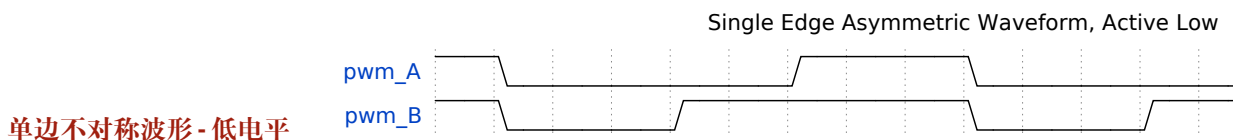

```
static void gen_action_config(mcpwm_gen_handle_t gena, mcpwm_gen_handle_t genb,
↪ mcpwm_cmpr_handle_t cmpa, mcpwm_cmpr_handle_t cmpb)
{
    ESP_ERROR_CHECK(mcpwm_generator_set_action_on_timer_event(gena,
        MCPWM_GEN_TIMER_EVENT_ACTION(MCPWM_TIMER_DIRECTION_UP, MCPWM_
↪ TIMER_EVENT_FULL, MCPWM_GEN_ACTION_LOW)));
}
```

(下页继续)

(续上页)

```

ESP_ERROR_CHECK(mcpwm_generator_set_action_on_compare_event(gena,
    MCPWM_GEN_COMPARE_EVENT_ACTION(MCPWM_TIMER_DIRECTION_UP, cmpa,
↳MCPWM_GEN_ACTION_HIGH));
ESP_ERROR_CHECK(mcpwm_generator_set_action_on_timer_event(genb,
    MCPWM_GEN_TIMER_EVENT_ACTION(MCPWM_TIMER_DIRECTION_UP, MCPWM_
↳TIMER_EVENT_FULL, MCPWM_GEN_ACTION_LOW));
ESP_ERROR_CHECK(mcpwm_generator_set_action_on_compare_event(genb,
    MCPWM_GEN_COMPARE_EVENT_ACTION(MCPWM_TIMER_DIRECTION_UP, cmpb,
↳MCPWM_GEN_ACTION_HIGH));
}

```

## 脉冲位置不对称波形

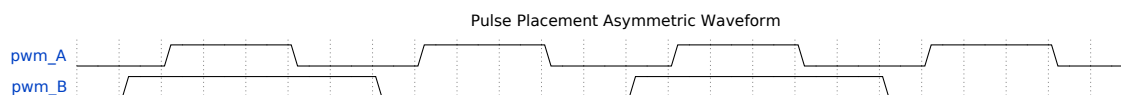

```

static void gen_action_config(mcpwm_gen_handle_t gena, mcpwm_gen_handle_t genb,
↳mcpwm_cmpr_handle_t cmpa, mcpwm_cmpr_handle_t cmpb)
{
    ESP_ERROR_CHECK(mcpwm_generator_set_actions_on_compare_event(gena,
        MCPWM_GEN_COMPARE_EVENT_ACTION(MCPWM_TIMER_DIRECTION_UP, cmpa,
↳MCPWM_GEN_ACTION_HIGH),
        MCPWM_GEN_COMPARE_EVENT_ACTION(MCPWM_TIMER_DIRECTION_UP, cmpb,
↳MCPWM_GEN_ACTION_LOW),
        MCPWM_GEN_COMPARE_EVENT_ACTION_END()));
    ESP_ERROR_CHECK(mcpwm_generator_set_actions_on_timer_event(genb,
        MCPWM_GEN_TIMER_EVENT_ACTION(MCPWM_TIMER_DIRECTION_UP, MCPWM_
↳TIMER_EVENT_EMPTY, MCPWM_GEN_ACTION_TOGGLE),
        MCPWM_GEN_TIMER_EVENT_ACTION_END()));
}

```

## Dual Edge Asymmetric Waveform, Active Low

## 双沿不对称波形 - 低电平有效

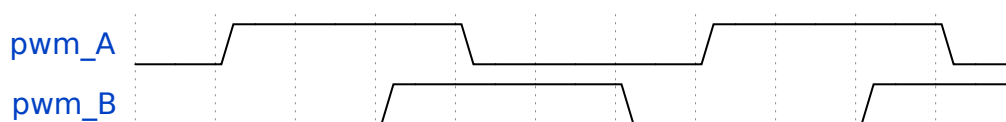

```

static void gen_action_config(mcpwm_gen_handle_t gena, mcpwm_gen_handle_t genb,
↳mcpwm_cmpr_handle_t cmpa, mcpwm_cmpr_handle_t cmpb)
{
    ESP_ERROR_CHECK(mcpwm_generator_set_actions_on_compare_event(gena,
        MCPWM_GEN_COMPARE_EVENT_ACTION(MCPWM_TIMER_DIRECTION_UP, cmpa,
↳MCPWM_GEN_ACTION_HIGH),
        MCPWM_GEN_COMPARE_EVENT_ACTION(MCPWM_TIMER_DIRECTION_DOWN,
↳cmpb, MCPWM_GEN_ACTION_LOW),
        MCPWM_GEN_COMPARE_EVENT_ACTION_END()));
    ESP_ERROR_CHECK(mcpwm_generator_set_actions_on_timer_event(genb,
        MCPWM_GEN_TIMER_EVENT_ACTION(MCPWM_TIMER_DIRECTION_UP, MCPWM_
↳TIMER_EVENT_EMPTY, MCPWM_GEN_ACTION_LOW),
        MCPWM_GEN_TIMER_EVENT_ACTION(MCPWM_TIMER_DIRECTION_DOWN, MCPWM_
↳TIMER_EVENT_FULL, MCPWM_GEN_ACTION_HIGH),
        MCPWM_GEN_TIMER_EVENT_ACTION_END()));
}

```

## Dual Edge Symmetric Waveform, Active Low

## 双沿对称波形 - 低电平有效

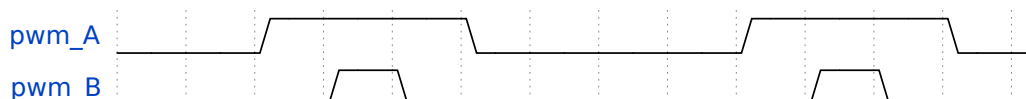

```
static void gen_action_config(mcpwm_gen_handle_t gena, mcpwm_gen_handle_t genb,
↪mcpwm_cmpr_handle_t cmpa, mcpwm_cmpr_handle_t cmpb)
{
    ESP_ERROR_CHECK(mcpwm_generator_set_actions_on_compare_event(gena,
        MCPWM_GEN_COMPARE_EVENT_ACTION(MCPWM_TIMER_DIRECTION_UP, cmpa,
↪MCPWM_GEN_ACTION_HIGH),
        MCPWM_GEN_COMPARE_EVENT_ACTION(MCPWM_TIMER_DIRECTION_DOWN,
↪cmpa, MCPWM_GEN_ACTION_LOW),
        MCPWM_GEN_COMPARE_EVENT_ACTION_END()));
    ESP_ERROR_CHECK(mcpwm_generator_set_actions_on_compare_event(genb,
        MCPWM_GEN_COMPARE_EVENT_ACTION(MCPWM_TIMER_DIRECTION_UP, cmpb,
↪MCPWM_GEN_ACTION_HIGH),
        MCPWM_GEN_COMPARE_EVENT_ACTION(MCPWM_TIMER_DIRECTION_DOWN,
↪cmpb, MCPWM_GEN_ACTION_LOW),
        MCPWM_GEN_COMPARE_EVENT_ACTION_END()));
}
```

## Dual Edge Symmetric Waveform, Complementary

## 双沿对称波形 - 互补

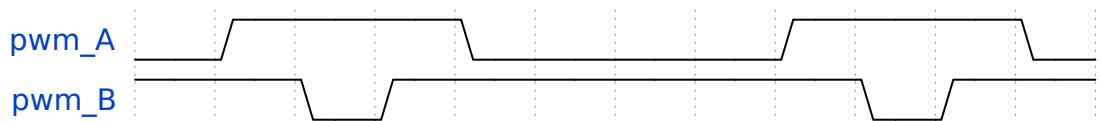

```
static void gen_action_config(mcpwm_gen_handle_t gena, mcpwm_gen_handle_t genb,
↪mcpwm_cmpr_handle_t cmpa, mcpwm_cmpr_handle_t cmpb)
{
    ESP_ERROR_CHECK(mcpwm_generator_set_actions_on_compare_event(gena,
        MCPWM_GEN_COMPARE_EVENT_ACTION(MCPWM_TIMER_DIRECTION_UP, cmpa,
↪MCPWM_GEN_ACTION_HIGH),
        MCPWM_GEN_COMPARE_EVENT_ACTION(MCPWM_TIMER_DIRECTION_DOWN,
↪cmpa, MCPWM_GEN_ACTION_LOW),
        MCPWM_GEN_COMPARE_EVENT_ACTION_END()));
    ESP_ERROR_CHECK(mcpwm_generator_set_actions_on_compare_event(genb,
        MCPWM_GEN_COMPARE_EVENT_ACTION(MCPWM_TIMER_DIRECTION_UP, cmpb,
↪MCPWM_GEN_ACTION_LOW),
        MCPWM_GEN_COMPARE_EVENT_ACTION(MCPWM_TIMER_DIRECTION_DOWN,
↪cmpb, MCPWM_GEN_ACTION_HIGH),
        MCPWM_GEN_COMPARE_EVENT_ACTION_END()));
}
```

**死区** 在电力电子学中，常常会用到整流器和逆变器，这就涉及到了整流桥和逆变桥的应用。每个桥臂配有两个功率电子器件，例如 MOSFET、IGBT 等。同一桥臂上的两个 MOSFET 不能同时导通，否则会造成短路。实际应用中，在 PWM 波形显示 MOSFET 开关已关闭后，仍需要一段时间窗口才能完全关闭 MOSFET。因此，需要设置生成器对事件执行的操作，在已生成的 PWM 波形上添加额外延迟。

死区驱动器的工作方式与装饰器类似。在 `mcpwm_generator_set_dead_time()` 函数的参数中，驱动接收主要生成器句柄 (`in_generator`)，并在应用死区后返回一个新的生成器 (`out_generator`)。需注意，如果 `out_generator` 和 `in_generator` 相同，这表示 PWM 波形中的时间延迟是以“就地”的方式添加的。反之，如果 `out_generator` 和 `in_generator` 不同，则代表在原 `in_generator` 的基础上派生出了一个新的 PWM 波形。



结构体 `mcpwm_dead_time_config_t` 中列出了死区相关的具体配置:

- `mcpwm_dead_time_config_t::posedge_delay_ticks` 和 `mcpwm_dead_time_config_t::negedge_delay_ticks` 设置 PWM 波形上升沿和下降沿上的延迟时间, 以 Tick 为单位。若将这两个参数设置为 0, 则代表绕过死区模块。死区的 Tick 分辨率与通过 `mcpwm_operator_connect_timer()` 连接操作器的定时器相同。
- `mcpwm_dead_time_config_t::invert_output` 设置是否在应用死区后取反信号, 以控制延迟边沿的极性。

**警告:** 由于硬件限制, 同一种 delay 模块 (posedge delay 或者 negedge delay) 不能同时被应用在不同的 MCPWM 生成器中。例如, 以下配置是无效的:

```
mcpwm_dead_time_config_t dt_config = {
    .posedge_delay_ticks = 10,
};
// 给 generator A 叠加上升沿 delay
mcpwm_generator_set_dead_time(mcpwm_gen_a, mcpwm_gen_a, &dt_config);
// NOTE: 下面的操作是无效的, 不能将同一种 delay 应用于不同的 generator 上
mcpwm_generator_set_dead_time(mcpwm_gen_b, mcpwm_gen_b, &dt_config);
```

然而, 你可以为生成器 A 设置 posedge delay, 为生成器 B 设置 negedge delay。另外, 也可以为生成器 A 同时设置 posedge delay 和 negedge delay, 而让生成器 B 绕过死区模块。

**备注:** 也可以通过设置生成器对事件执行的操作来生成所需的死区, 通过不同的比较器来控制边沿位置。但是, 如果需要使用经典的基于边沿延迟并附带极性控制的死区, 则应使用死区子模块。

**经典 PWM 波形的死区配置** 本节提供了一些死区子模块支持生成的经典 PWM 波形, 同时在图片下方提供用于生成这些波形的代码片段。

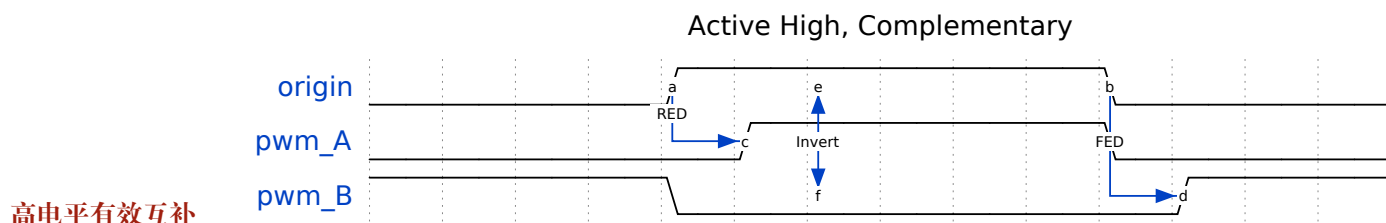

高电平有效互补

```
static void gen_action_config(mcpwm_gen_handle_t gena, mcpwm_gen_handle_t genb,
    ↪ mcpwm_cmpr_handle_t cmpa, mcpwm_cmpr_handle_t cmpb)
{
    ESP_ERROR_CHECK(mcpwm_generator_set_action_on_timer_event(gena,
        MCPWM_GEN_TIMER_EVENT_ACTION(MCPWM_TIMER_DIRECTION_UP, MCPWM_
    ↪ TIMER_EVENT_EMPTY, MCPWM_GEN_ACTION_HIGH)));
    ESP_ERROR_CHECK(mcpwm_generator_set_action_on_compare_event(gena,
        MCPWM_GEN_COMPARE_EVENT_ACTION(MCPWM_TIMER_DIRECTION_UP, cmpa,
    ↪ MCPWM_GEN_ACTION_LOW)));
}

static void dead_time_config(mcpwm_gen_handle_t gena, mcpwm_gen_handle_t genb)
{
    mcpwm_dead_time_config_t dead_time_config = {
        .posedge_delay_ticks = 50,
        .negedge_delay_ticks = 0
    };
    ESP_ERROR_CHECK(mcpwm_generator_set_dead_time(gena, gena, &dead_time_config));
```

(下页继续)

(续上页)

```

dead_time_config.posedge_delay_ticks = 0;
dead_time_config.negedge_delay_ticks = 100;
dead_time_config.flags.invert_output = true;
ESP_ERROR_CHECK(mcpwm_generator_set_dead_time(gena, genb, &dead_time_config));
}

```

## Active Low, Complementary

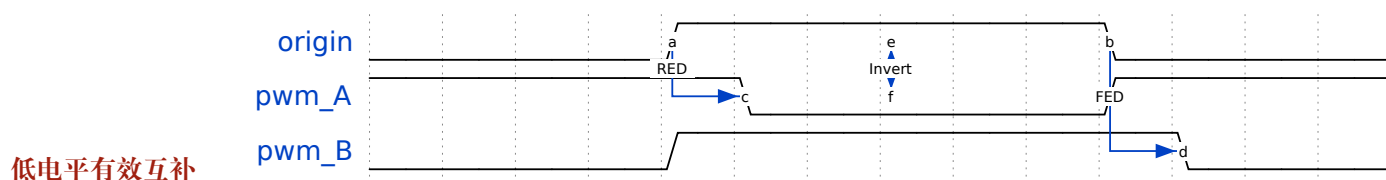

```

static void gen_action_config(mcpwm_gen_handle_t gena, mcpwm_gen_handle_t genb,
↪mcpwm_cmpr_handle_t cmpa, mcpwm_cmpr_handle_t cmpb)
{
    ESP_ERROR_CHECK(mcpwm_generator_set_action_on_timer_event(gena,
        MCPWM_GEN_TIMER_EVENT_ACTION(MCPWM_TIMER_DIRECTION_UP, MCPWM_
↪TIMER_EVENT_EMPTY, MCPWM_GEN_ACTION_HIGH)));
    ESP_ERROR_CHECK(mcpwm_generator_set_action_on_compare_event(gena,
        MCPWM_GEN_COMPARE_EVENT_ACTION(MCPWM_TIMER_DIRECTION_UP, cmpa,
↪MCPWM_GEN_ACTION_LOW)));
}

static void dead_time_config(mcpwm_gen_handle_t gena, mcpwm_gen_handle_t genb)
{
    mcpwm_dead_time_config_t dead_time_config = {
        .posedge_delay_ticks = 50,
        .negedge_delay_ticks = 0,
        .flags.invert_output = true
    };
    ESP_ERROR_CHECK(mcpwm_generator_set_dead_time(gena, gena, &dead_time_config));
    dead_time_config.posedge_delay_ticks = 0;
    dead_time_config.negedge_delay_ticks = 100;
    dead_time_config.flags.invert_output = false;
    ESP_ERROR_CHECK(mcpwm_generator_set_dead_time(gena, genb, &dead_time_config));
}

```

## Active High

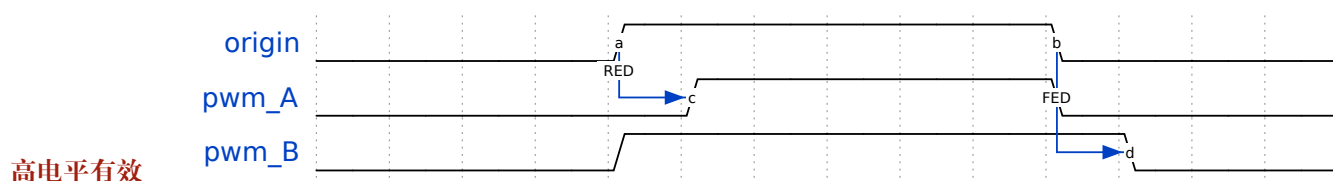

```

static void gen_action_config(mcpwm_gen_handle_t gena, mcpwm_gen_handle_t genb,
↪mcpwm_cmpr_handle_t cmpa, mcpwm_cmpr_handle_t cmpb)
{
    ESP_ERROR_CHECK(mcpwm_generator_set_action_on_timer_event(gena,
        MCPWM_GEN_TIMER_EVENT_ACTION(MCPWM_TIMER_DIRECTION_UP, MCPWM_
↪TIMER_EVENT_EMPTY, MCPWM_GEN_ACTION_HIGH)));
    ESP_ERROR_CHECK(mcpwm_generator_set_action_on_compare_event(gena,
        MCPWM_GEN_COMPARE_EVENT_ACTION(MCPWM_TIMER_DIRECTION_UP, cmpa,
↪MCPWM_GEN_ACTION_LOW)));
}

```

(下页继续)

```

}

static void dead_time_config(mcpwm_gen_handle_t gena, mcpwm_gen_handle_t genb)
{
    mcpwm_dead_time_config_t dead_time_config = {
        .posedge_delay_ticks = 50,
        .negedge_delay_ticks = 0,
    };
    ESP_ERROR_CHECK(mcpwm_generator_set_dead_time(gena, gena, &dead_time_config));
    dead_time_config.posedge_delay_ticks = 0;
    dead_time_config.negedge_delay_ticks = 100;
    ESP_ERROR_CHECK(mcpwm_generator_set_dead_time(gena, genb, &dead_time_config));
}

```

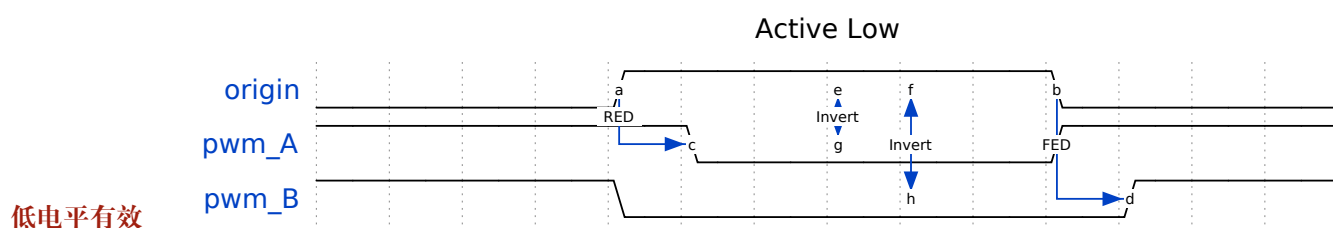

```

static void gen_action_config(mcpwm_gen_handle_t gena, mcpwm_gen_handle_t genb,
    ↪mcpwm_cmpr_handle_t cmpa, mcpwm_cmpr_handle_t cmpb)
{
    ESP_ERROR_CHECK(mcpwm_generator_set_action_on_timer_event(gena,
        MCPWM_GEN_TIMER_EVENT_ACTION(MCPWM_TIMER_DIRECTION_UP, MCPWM_
    ↪TIMER_EVENT_EMPTY, MCPWM_GEN_ACTION_HIGH)));
    ESP_ERROR_CHECK(mcpwm_generator_set_action_on_compare_event(gena,
        MCPWM_GEN_COMPARE_EVENT_ACTION(MCPWM_TIMER_DIRECTION_UP, cmpa,
    ↪MCPWM_GEN_ACTION_LOW)));
}

static void dead_time_config(mcpwm_gen_handle_t gena, mcpwm_gen_handle_t genb)
{
    mcpwm_dead_time_config_t dead_time_config = {
        .posedge_delay_ticks = 50,
        .negedge_delay_ticks = 0,
        .flags.invert_output = true
    };
    ESP_ERROR_CHECK(mcpwm_generator_set_dead_time(gena, gena, &dead_time_config));
    dead_time_config.posedge_delay_ticks = 0;
    dead_time_config.negedge_delay_ticks = 100;
    ESP_ERROR_CHECK(mcpwm_generator_set_dead_time(gena, genb, &dead_time_config));
}

```

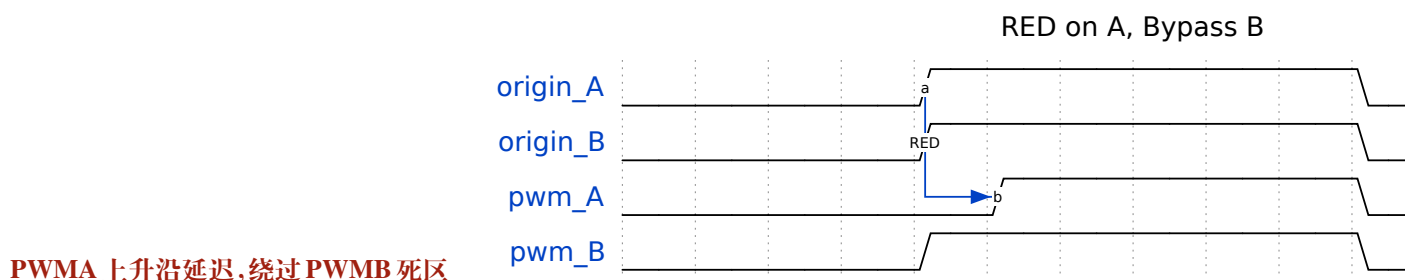

```

static void gen_action_config(mcpwm_gen_handle_t gena, mcpwm_gen_handle_t genb,
↪mcpwm_cmpr_handle_t cmpa, mcpwm_cmpr_handle_t cmpb)
{
    ESP_ERROR_CHECK(mcpwm_generator_set_action_on_timer_event(gena,
        MCPWM_GEN_TIMER_EVENT_ACTION(MCPWM_TIMER_DIRECTION_UP, MCPWM_
↪TIMER_EVENT_EMPTY, MCPWM_GEN_ACTION_HIGH)));
    ESP_ERROR_CHECK(mcpwm_generator_set_action_on_compare_event(gena,
        MCPWM_GEN_COMPARE_EVENT_ACTION(MCPWM_TIMER_DIRECTION_UP, cmpa,
↪MCPWM_GEN_ACTION_LOW)));
    ESP_ERROR_CHECK(mcpwm_generator_set_action_on_timer_event(genb,
        MCPWM_GEN_TIMER_EVENT_ACTION(MCPWM_TIMER_DIRECTION_UP, MCPWM_
↪TIMER_EVENT_EMPTY, MCPWM_GEN_ACTION_HIGH)));
    ESP_ERROR_CHECK(mcpwm_generator_set_action_on_compare_event(genb,
        MCPWM_GEN_COMPARE_EVENT_ACTION(MCPWM_TIMER_DIRECTION_UP, cmpb,
↪MCPWM_GEN_ACTION_LOW)));
}

static void dead_time_config(mcpwm_gen_handle_t gena, mcpwm_gen_handle_t genb)
{
    mcpwm_dead_time_config_t dead_time_config = {
        .posedge_delay_ticks = 50,
        .negedge_delay_ticks = 0,
    };
    // apply deadtime to generator_a
    ESP_ERROR_CHECK(mcpwm_generator_set_dead_time(gena, gena, &dead_time_config));
    // bypass deadtime module for generator_b
    dead_time_config.posedge_delay_ticks = 0;
    ESP_ERROR_CHECK(mcpwm_generator_set_dead_time(genb, genb, &dead_time_config));
}

```

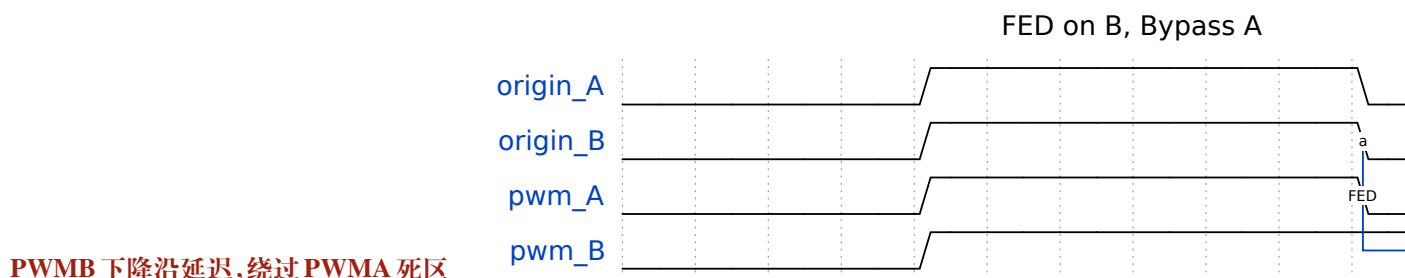

**PWMB 下降沿延迟, 绕过 PWMA 死区**

```

static void gen_action_config(mcpwm_gen_handle_t gena, mcpwm_gen_handle_t genb,
↪mcpwm_cmpr_handle_t cmpa, mcpwm_cmpr_handle_t cmpb)
{
    ESP_ERROR_CHECK(mcpwm_generator_set_action_on_timer_event(gena,
        MCPWM_GEN_TIMER_EVENT_ACTION(MCPWM_TIMER_DIRECTION_UP, MCPWM_
↪TIMER_EVENT_EMPTY, MCPWM_GEN_ACTION_HIGH)));
    ESP_ERROR_CHECK(mcpwm_generator_set_action_on_compare_event(gena,
        MCPWM_GEN_COMPARE_EVENT_ACTION(MCPWM_TIMER_DIRECTION_UP, cmpa,
↪MCPWM_GEN_ACTION_LOW)));
    ESP_ERROR_CHECK(mcpwm_generator_set_action_on_timer_event(genb,
        MCPWM_GEN_TIMER_EVENT_ACTION(MCPWM_TIMER_DIRECTION_UP, MCPWM_
↪TIMER_EVENT_EMPTY, MCPWM_GEN_ACTION_HIGH)));
    ESP_ERROR_CHECK(mcpwm_generator_set_action_on_compare_event(genb,
        MCPWM_GEN_COMPARE_EVENT_ACTION(MCPWM_TIMER_DIRECTION_UP, cmpb,
↪MCPWM_GEN_ACTION_LOW)));
}

static void dead_time_config(mcpwm_gen_handle_t gena, mcpwm_gen_handle_t genb)
{

```

(下页继续)

(续上页)

```

mcpwm_dead_time_config_t dead_time_config = {
    .posedge_delay_ticks = 0,
    .negedge_delay_ticks = 0,
};
// generator_a bypass the deadtime module (no delay)
ESP_ERROR_CHECK(mcpwm_generator_set_dead_time(gena, gena, &dead_time_config));
// apply dead time to generator_b
dead_time_config.negedge_delay_ticks = 50;
ESP_ERROR_CHECK(mcpwm_generator_set_dead_time(genb, genb, &dead_time_config));
}

```

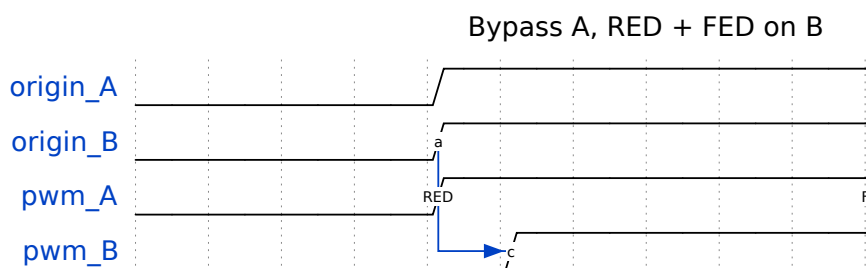

### PWMB 上升下降沿延迟, 绕过 PWMA 死区

```

static void gen_action_config(mcpwm_gen_handle_t gena, mcpwm_gen_handle_t genb,
↪ mcpwm_cmpr_handle_t cmpa, mcpwm_cmpr_handle_t cmpb)
{
    ESP_ERROR_CHECK(mcpwm_generator_set_action_on_timer_event(gena,
        MCPWM_GEN_TIMER_EVENT_ACTION(MCPWM_TIMER_DIRECTION_UP, MCPWM_
↪ TIMER_EVENT_EMPTY, MCPWM_GEN_ACTION_HIGH)));
    ESP_ERROR_CHECK(mcpwm_generator_set_action_on_compare_event(gena,
        MCPWM_GEN_COMPARE_EVENT_ACTION(MCPWM_TIMER_DIRECTION_UP, cmpa,
↪ MCPWM_GEN_ACTION_LOW)));
    ESP_ERROR_CHECK(mcpwm_generator_set_action_on_timer_event(genb,
        MCPWM_GEN_TIMER_EVENT_ACTION(MCPWM_TIMER_DIRECTION_UP, MCPWM_
↪ TIMER_EVENT_EMPTY, MCPWM_GEN_ACTION_HIGH)));
    ESP_ERROR_CHECK(mcpwm_generator_set_action_on_compare_event(genb,
        MCPWM_GEN_COMPARE_EVENT_ACTION(MCPWM_TIMER_DIRECTION_UP, cmpb,
↪ MCPWM_GEN_ACTION_LOW)));
}

static void dead_time_config(mcpwm_gen_handle_t gena, mcpwm_gen_handle_t genb)
{
    mcpwm_dead_time_config_t dead_time_config = {
        .posedge_delay_ticks = 0,
        .negedge_delay_ticks = 0,
    };
    // generator_a bypass the deadtime module (no delay)
    ESP_ERROR_CHECK(mcpwm_generator_set_dead_time(gena, gena, &dead_time_config));
    // apply dead time on both edge for generator_b
    dead_time_config.negedge_delay_ticks = 50;
    dead_time_config.posedge_delay_ticks = 50;
    ESP_ERROR_CHECK(mcpwm_generator_set_dead_time(genb, genb, &dead_time_config));
}

```

**载波调制** MCPWM 操作器具有载波子模块，可以根据需要（例如隔离式数字电源应用中）使用变压器传递 PWM 输出信号，实现电机驱动器的电气隔离。在电机需要在全负荷下稳定运行时，各个 PWM 输出信号都将占空比稳定保持在 100% 左右。由于变压器无法直接耦合非交替信号，需要使用载波子模块调制信号，生成交流电波形，从而实现耦合。

调用 `mcpwm_operator_apply_carrier()`，并提供配置结构体 `mcpwm_carrier_config_t`，配置载波子模块：

- `mcpwm_carrier_config_t::clk_src` 设置载波的时钟源。
- `mcpwm_carrier_config_t::frequency_hz` 表示载波频率，单位为赫兹。内部驱动将根据时钟源和载波频率设置合适的分频器。
- `mcpwm_carrier_config_t::duty_cycle` 表示载波的占空比。需注意，支持的占空比选项并不连续，驱动程序将根据配置查找最接近的占空比。
- `mcpwm_carrier_config_t::first_pulse_duration_us` 表示第一个脉冲的脉宽，单位为微秒。该脉冲的分辨率由 `mcpwm_carrier_config_t::frequency_hz` 中的配置决定。第一个脉冲的脉宽不能为零，且至少为一个载波周期。脉宽越长，电感传导越快。
- `mcpwm_carrier_config_t::invert_before_modulate` 和 `mcpwm_carrier_config_t::invert_after_modulate` 设置是否在调制前和调制后取反载波输出。

具体而言，可调用 `mcpwm_operator_apply_carrier()` 并将其配置为 `NULL`，禁用载波子模块。

**故障检测和制动控制** MCPWM 操作器能够感知外部信号，接收有关电机故障、功率驱动器及其他连接设备的信息。这些故障信号封装在 MCPWM 故障对象中。

电机需配置故障模式以及检测到特定故障时的对应操作，例如拉低有刷电机的所有输出，或是锁定步进电机的电流状态等。此操作应使电机重回安全状态，降低故障导致损坏的可能性。

**设置故障时操作器的制动模式** MCPWM 操作器对故障的响应方式为 **制动**。可以调用 `mcpwm_operator_set_brake_on_fault()`，为每个故障对象配置不同的制动模式。制动的配置包含在结构体 `mcpwm_brake_config_t` 中：

- `mcpwm_brake_config_t::fault` 设置操作器响应的故障类型。
- `mcpwm_brake_config_t::brake_mode` 设置对应故障的制动模式，可以调用 `mcpwm_operator_brake_mode_t` 查看支持的制动模式。在 `MCPWM_OPER_BRAKE_MODE_CBC` 模式下，操作器将在故障消失后自行恢复正常，可以通过 `mcpwm_brake_config_t::cbc_recover_on_tez` 和 `mcpwm_brake_config_t::cbc_recover_on_tep` 配置恢复时间。在 `MCPWM_OPER_BRAKE_MODE_OST` 模式下，即使故障消失，操作器也无法恢复正常。此时，需要调用 `mcpwm_operator_recover_from_fault()`，手动恢复操作器。

**设置发生制动事件时的生成器操作** 调用 `mcpwm_generator_set_actions_on_brake_event()` 并辅以若干操作配置，可以针对不同的制动事件，为生成器设置不同的对应操作。操作配置定义在 `mcpwm_gen_brake_event_action_t` 中：

- `mcpwm_gen_brake_event_action_t::direction` 指定定时器的方向，可以调用 `mcpwm_timer_direction_t` 查看支持的方向。
- `mcpwm_gen_brake_event_action_t::brake_mode` 指定制动模式，可以调用 `mcpwm_operator_brake_mode_t` 查看支持的制动模式。
- `mcpwm_gen_brake_event_action_t::action` 指定生成器操作，可以调用 `mcpwm_generator_action_t` 查看支持的操作。

可借助辅助宏 `MCPWM_GEN_BRAKE_EVENT_ACTION` 构建制动事件操作条目。

需注意，`mcpwm_generator_set_actions_on_brake_event()` 的参数列表 **必须** 以 `MCPWM_GEN_BRAKE_EVENT_ACTION_END` 结束。

也可以调用 `mcpwm_generator_set_action_on_brake_event()` 逐一设置制动操作，无需涉及变量参数。

**注册故障事件回调** MCPWM 故障检测器支持在检测到实际故障或故障信号消失时发送通知。若有函数需在特定事件发生时调用，则应预先调用 `mcpwm_fault_register_event_callbacks()`，将所需函数挂载至中断服务程序 (ISR) 中。驱动中故障事件回调函数原型声明为 `mcpwm_fault_event_cb_t`，其所支持的事件回调类型则列在 `mcpwm_fault_event_callbacks_t` 中：

- `mcpwm_fault_event_callbacks_t::on_fault_enter` 设置检测到故障时调用的回调函数。



- `mcpwm_fault_event_callbacks_t::on_fault_exit` 设置故障消失后调用的回调函数。

由于上述回调函数在 ISR 中调用，因此，这些函数 **不应** 涉及 block 操作。可以检查调用 API 的后缀，确保在函数中只调用了后缀为 ISR 的 FreeRTOS API。

函数 `mcpwm_fault_register_event_callbacks()` 中的 `user_data` 参数用于保存用户上下文，将直接传递至各个回调函数。

此函数会延迟安装 MCPWM 故障的中断服务。中断服务只能通过 `mcpwm_del_fault` 移除。

**寄存器制动事件回调** MCPWM 操作器支持在进行制动操作前发送通知。若有函数需在特定事件发生时调用，则应预先调用 `mcpwm_operator_register_event_callbacks()`，将所需函数挂载至中断服务程序 (ISR) 中。驱动中制动事件回调函数原型声明为 `mcpwm_brake_event_cb_t`，其所支持的事件回调类型则列在 `mcpwm_operator_event_callbacks_t` 中：

- `mcpwm_operator_event_callbacks_t::on_brake_cbc` 设置操作器进行 **逐周期 (CBC)** 操作前调用的回调函数。
- `mcpwm_operator_event_callbacks_t::on_brake_ost` 设置操作器进行 **一次性 (OST)** 操作前调用的回调函数。

由于上述回调函数在 ISR 中调用，因此，这些函数 **不应** 涉及 block 操作。可以检查调用 API 的后缀，确保在函数中只调用了后缀为 ISR 的 FreeRTOS API。

函数 `mcpwm_operator_register_event_callbacks()` 中的 `user_data` 参数用于保存用户上下文，将直接传递至各个回调函数。

此函数会延迟安装 MCPWM 故障的中断服务。中断服务只能通过 `mcpwm_del_operator` 移除。

**生成器强制操作** 调用 `mcpwm_generator_set_force_level()`，使能软件强制决定运行时的生成器输出电平。相较于通过 `mcpwm_generator_set_actions_on_timer_event()` 配置的其他事件操作，软件强制事件优先级最高。

- 设置 `level` 为 -1，代表禁用强制操作，生成器的输出电平重新交由事件操作控制。
- 设置 `hold_on` 为 `true`，代表强制输出电平将保持不变，直到设置 `level` 为 -1 来移除该电平。
- 设置 `hole_on` 为 `false`，代表强制输出电平仅在短时间有效，随后发生的任何事件都可以改变该电平。

**同步模块** MCPWM 定时器接收到同步信号后，定时器将强制进入一个预定义的 **相位**，该相位由计数值和计数方向共同决定。调用 `mcpwm_timer_set_phase_on_sync()`，设置同步相位。同步相位配置定义在 `mcpwm_timer_sync_phase_config_t` 结构体中：

- `mcpwm_timer_sync_phase_config_t::sync_src` 设置同步信号源。创建同步源对象的相关操作，请参见 [MCPWM 同步源](#)。具体来说，当此参数设置为 `NULL` 时，驱动器将禁用 MCPWM 定时器的同步功能。
- `mcpwm_timer_sync_phase_config_t::count_value` 设置接收同步信号后加载至计数器的值。
- `mcpwm_timer_sync_phase_config_t::direction` 设置接收同步信号后的计数方向。

---

**备注：** 当 MCPWM 定时器在 `MCPWM_TIMER_COUNT_MODE_UP_DOWN` 模式下工作时，需要特别注意。在该模式下，计数器范围 `[0 -> peak-1]` 属于 **递增** 阶段，`[peak -> 1]` 属于 **递减** 阶段。因此，如果你将 `mcpwm_timer_sync_phase_config_t::count_value` 设置为零，则可能还需要将 `mcpwm_timer_sync_phase_config_t::direction` 设置为 `MCPWM_TIMER_DIRECTION_UP`。否则，计时器将继续维持递减阶段，计数值会下溢至峰值。

---

同理，[MCPWM 捕获定时器和通道](#) 也支持同步。调用 `mcpwm_capture_timer_set_phase_on_sync()`，设置捕获定时器的同步相位。同步相位配置定义在 `mcpwm_capture_timer_sync_phase_config_t` 结构体中：

- `mcpwm_capture_timer_sync_phase_config_t::sync_src` 设置同步信号源。关于如何创建一个同步源对象，请参见 [MCPWM 同步源](#)。具体来说，当此参数设置为 `NULL` 时，驱动器将禁用 MCPWM 捕获定时器的同步功能。
- `mcpwm_capture_timer_sync_phase_config_t::count_value` 设置接收同步信号后加载至计数器的值。
- `mcpwm_capture_timer_sync_phase_config_t::direction` 设置接收同步信号后的计数方向。需注意，不同于 MCPWM 定时器，捕获定时器只支持 `MCPWM_TIMER_DIRECTION_UP` 这一个计数方向。



图 16: GPIO Sync All MCPWM Timers

### 使用 GPIO 同步定时器

```

static void example_setup_sync_strategy(mcpwm_timer_handle_t timers[])
{
    mcpwm_sync_handle_t gpio_sync_source = NULL;
    mcpwm_gpio_sync_src_config_t gpio_sync_config = {
        .group_id = 0, // GPIO 故障应与以上定时器位于同一组中
        .gpio_num = EXAMPLE_SYNC_GPIO,
        .flags.pull_down = true,
        .flags.active_neg = false, // 默认情况下，一个上升沿脉冲可以触发一个同步事件
    };
    ESP_ERROR_CHECK(mcpwm_new_gpio_sync_src(&gpio_sync_config, &gpio_sync_source));

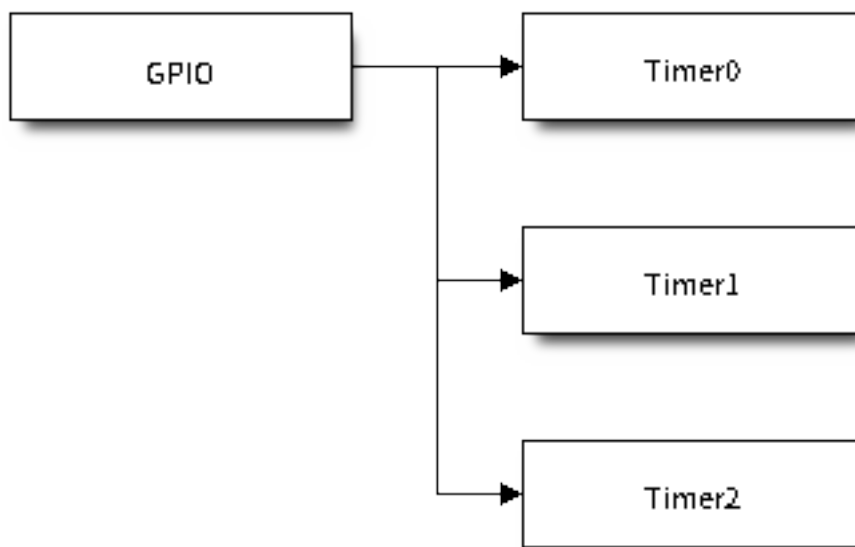
    mcpwm_timer_sync_phase_config_t sync_phase_config = {
        .count_value = 0, // 同步相位：目标计数值
        .direction = MCPWM_TIMER_DIRECTION_UP, // 同步相位：计数方向
        .sync_src = gpio_sync_source, // 同步源
    };
    for (int i = 0; i < 3; i++) {
        ESP_ERROR_CHECK(mcpwm_timer_set_phase_on_sync(timers[i], &sync_phase_
        config));
    }
}
  
```



**捕获模块** MCPWM 捕获的主要功能是记录捕获信号的脉冲边沿的有效时间。可以通过捕获得到脉宽，随后使用捕获回调函数将脉宽转换为其他物理量，如距离或速度。例如，在下图的无刷直流电机 (BLDC) 方案中，可以使用捕获子模块来确认来自霍尔传感器的转子位置。



图 17: 带霍尔传感器的 MCPWM 无刷直流电机

通常，捕获定时器连接了数个捕获通道。有关资源分配的相关信息，请参见 [MCPWM 捕获定时器和通道](#)。

**注册捕获事件回调** MCPWM 捕获通道支持在信号上检测到有效边沿时发送通知。须调用 `mcpwm_capture_channel_register_event_callbacks()`，注册一个回调函数来获得捕获的定时器计数值。回调函数原型声明在 `mcpwm_capture_event_cb_t` 中，可以调用 `mcpwm_capture_event_callbacks_t` 查看支持的捕获回调：

- `mcpwm_capture_event_callbacks_t::on_cap` 设置检测到有效边沿时捕获通道的回调函数。

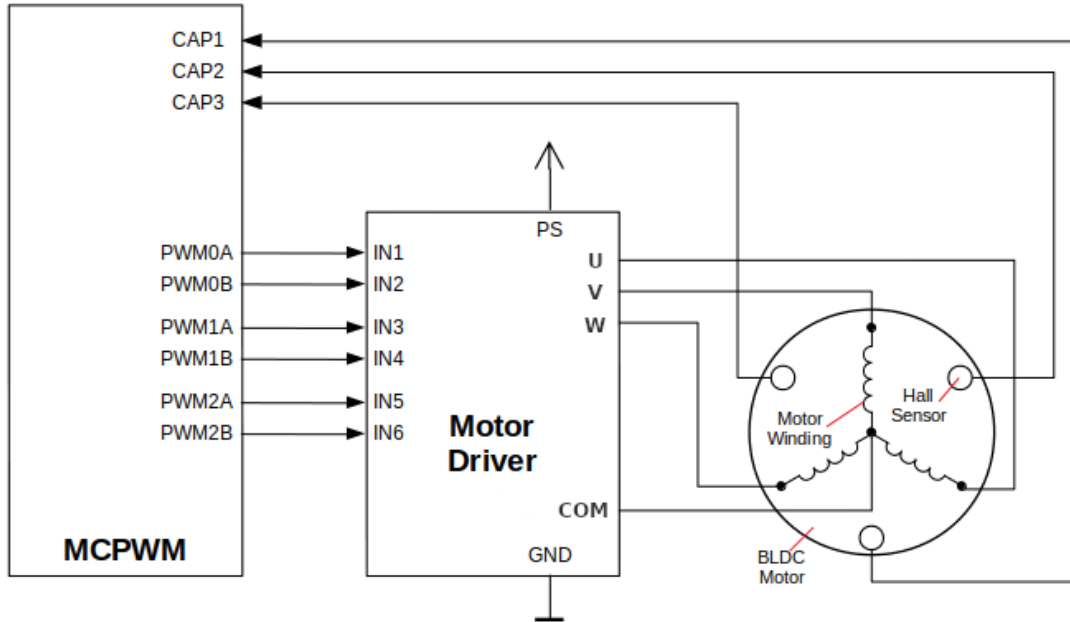
回调函数会针对特定事件，提供 `mcpwm_capture_event_data_t` 类型的数据，由此，可以通过 `mcpwm_capture_event_data_t::cap_edge` 和 `mcpwm_capture_event_data_t::cap_value` 分别得到捕获信号的边沿及该捕获的计数值。随后，调用 `mcpwm_capture_timer_get_resolution()`，获取捕获定时器的分辨率，以将捕获计数转换为时间戳。

由于上述回调函数在 ISR 中调用，因此，这些函数 **不应** 涉及 block 操作。可以检查调用 API 的后缀，确保在函数中只调用了后缀为 ISR 的 FreeRTOS API。

函数 `mcpwm_capture_channel_register_event_callbacks()` 中的 `user_data` 参数用于保存用户上下文，将直接传递至各个回调函数。

此函数会延迟安装 MCPWM 捕获的中断服务。中断服务只能通过 `mcpwm_del_capture_channel` 移除。

**启用或禁用捕获通道** 调用 `mcpwm_new_capture_channel()` 进行分配后，捕获通道不会自动启用。应调用 `mcpwm_capture_channel_enable()` 或 `mcpwm_capture_channel_disable()` 来启用或禁用该通道。如果在为通道注册事件回调时，由于调用了 `mcpwm_capture_channel_register_event_callbacks()`，致使延迟安装中断服务，则调用 `mcpwm_capture_channel_enable()` 启用通道时，也将启用中断服务。

**启用或禁用捕获定时器** 在对捕获定时器进行 IO 控制之前，需要首先调用 `mcpwm_capture_timer_enable()`，启用定时器。此函数将进行如下内部操作：

- 将捕获定时器的状态从 **init** 切换到 **enable**。
- 如果选择了一个特定时钟源（例如 APB 时钟），则获取一个对应的电源管理锁。更多信息请参见 [电源管理](#)。

反之，调用 `mcpwm_capture_timer_disable()` 将使定时器驱动程序切换回 **init** 状态，并释放电源管理锁。

**启动或停止捕获定时器** 通过基本的 IO 控制，即可启动或停止捕获定时器。调用 `mcpwm_capture_timer_start()` 启动捕获定时器，或调用 `mcpwm_capture_timer_stop()` 立即停止捕获定时器。

**触发软件捕获事件** 某些场景下，可能存在需要软件触发“虚假”捕获事件的需求。此时，可以调用 `mcpwm_capture_channel_trigger_soft_catch()` 实现。需注意，此类“虚假”捕获事件仍然会触发中断，并从而调用捕获事件回调函数。

**ETM 事件与任务** MCPWM 比较器可以产生事件，这些事件可以连接到 **ETM** 模块。`mcpwm_comparator_etm_event_type_t` 中列出了 MCPWM 比较器能够产生的事件类型。用户可以通过调用 `mcpwm_comparator_new_etm_event()` 来获得相应事件的 ETM event 句柄。

关于如何将 MCPWM 比较器事件连接到 ETM 通道中，请参阅 [ETM](#) 文档。

**电源管理** 启用电源管理（即开启 `CONFIG_PM_ENABLE`）时，系统会在进入 Light-sleep 前调整 PLL 和 APB 频率。该操作有可能会改变 MCPWM 定时器的计数步长，导致计时偏差。

不过，驱动程序可以获取 `ESP_PM_APB_FREQ_MAX` 类型的电源管理锁，防止系统改变 APB 频率。每当驱动创建以 `MCPWM_TIMER_CLK_SRC_PLL160M` 作为时钟源的 MCPWM 定时器实例时，都会在通过 `mcpwm_timer_enable()` 启用定时器时获取电源管理锁。反之，调用 `mcpwm_timer_disable()` 时，驱动程序释放锁。

同理，每当驱动创建一个以 `MCPWM_CAPTURE_CLK_SRC_APB` 作为时钟源的 MCPWM 捕获定时器实例时，都会在通过 `mcpwm_capture_timer_enable()` 启用定时器时获取电源管理锁，并在调用 `mcpwm_capture_timer_disable()` 时释放锁。

**IRAM 安全** 默认情况下，禁用 cache 时，写入/擦除 flash 等原因将导致 MCPWM 中断延迟，事件回调函数也将延迟执行。在实时应用程序中，应避免此类情况。

因此，可以启用 Kconfig 选项 `CONFIG_MCPWM_ISR_IRAM_SAFE`，该选项：

- 支持在禁用 cache 时启用所需中断
- 支持将 ISR 使用的所有函数存放在 IRAM 中<sup>2</sup>
- 支持将驱动程序存放在 DRAM 中（以防其意外映射到 PSRAM 中）

启用该选项可以保证 cache 禁用时的中断运行，但会相应增加 IRAM 占用。

另一个 Kconfig 选项 `CONFIG_MCPWM_CTRL_FUNC_IN_IRAM` 也支持将常用的 IO 控制函数存放在 IRAM 中，以保证在禁用 cache 时可以正常使用函数。IO 控制函数如下所示：

- `mcpwm_comparator_set_compare_value()`
- `mcpwm_timer_set_period()`

<sup>2</sup> 回调函数及其调用的子函数需手动存放在 IRAM 中。

**线程安全** 驱动程序会确保工厂函数（如 `mcpwm_new_timer()`）的线程安全，使用时，可以直接从不同的 RTOS 任务中调用此类函数，无需额外锁保护。

驱动程序设置了临界区，以防函数同时在任务和 ISR 中调用。因此，以下函数支持在 ISR 上下文运行：

- `mcpwm_comparator_set_compare_value()`
- `mcpwm_timer_set_period()`

资源配置及初始化 中尚未提及的函数并非线程安全。在没有设置互斥锁保护的 tasks 中，应避免调用这些函数。

### Kconfig 选项

- `CONFIG_MCPWM_ISR_IRAM_SAFE` 控制默认 ISR 处理程序能否在禁用 cache 的情况下工作。更多信息请参见 [IRAM 安全](#)。
- `CONFIG_MCPWM_CTRL_FUNC_IN_IRAM` 控制 MCPWM 控制函数的存放位置（IRAM 或 flash）。更多信息请参见 [IRAM 安全](#)。
- `CONFIG_MCPWM_ENABLE_DEBUG_LOG` 用于启用调试日志输出。启用此选项将增加固件的二进制文件大小。

### 应用示例

- 通过 PID 算法控制有刷直流电机速度： [peripherals/mcpwm/mcpwm\\_bdc\\_speed\\_control](#)
- 控制带霍尔传感器反馈的无刷直流电机： [peripherals/mcpwm/mcpwm\\_bldc\\_hall\\_control](#)
- 使用超声波传感器 (HC-SR04) 测量距离： [peripherals/mcpwm/mcpwm\\_capture\\_hc\\_sr04](#)
- 控制伺服电机角度： [peripherals/mcpwm/mcpwm\\_servo\\_control](#)
- 定时器之间的 MCPWM 同步： [peripherals/mcpwm/mcpwm\\_sync](#)

## API Reference

### Header File

- `components/esp_driver_mcpwm/include/driver/mcpwm_timer.h`
- This header file can be included with:

```
#include "driver/mcpwm_timer.h"
```

- This header file is a part of the API provided by the `esp_driver_mcpwm` component. To declare that your component depends on `esp_driver_mcpwm`, add the following to your `CMakeLists.txt`:

```
REQUIRES esp_driver_mcpwm
```

or

```
PRIV_REQUIRES esp_driver_mcpwm
```

### Functions

`esp_err_t mcpwm_new_timer` (const `mcpwm_timer_config_t` \*config, `mcpwm_timer_handle_t` \*ret\_timer)

Create MCPWM timer.

#### 参数

- **config** -- [in] MCPWM timer configuration
- **ret\_timer** -- [out] Returned MCPWM timer handle

#### 返回

- `ESP_OK`: Create MCPWM timer successfully
- `ESP_ERR_INVALID_ARG`: Create MCPWM timer failed because of invalid argument
- `ESP_ERR_NO_MEM`: Create MCPWM timer failed because out of memory
- `ESP_ERR_NOT_FOUND`: Create MCPWM timer failed because all hardware timers are used up and no more free one
- `ESP_FAIL`: Create MCPWM timer failed because of other error

*esp\_err\_t* **mcpwm\_del\_timer** (*mcpwm\_timer\_handle\_t* timer)

Delete MCPWM timer.

**参数** *timer* -- [in] MCPWM timer handle, allocated by `mcpwm_new_timer()`

**返回**

- ESP\_OK: Delete MCPWM timer successfully
- ESP\_ERR\_INVALID\_ARG: Delete MCPWM timer failed because of invalid argument
- ESP\_ERR\_INVALID\_STATE: Delete MCPWM timer failed because timer is not in init state
- ESP\_FAIL: Delete MCPWM timer failed because of other error

*esp\_err\_t* **mcpwm\_timer\_set\_period** (*mcpwm\_timer\_handle\_t* timer, *uint32\_t* period\_ticks)

Set a new period for MCPWM timer.

---

**备注:** If `mcpwm_timer_config_t::update_period_on_empty` and `mcpwm_timer_config_t::update_period_on_sync` are not set, the new period will take effect immediately. Otherwise, the new period will take effect when timer counts to zero or on sync event.

---

**备注:** You may need to use `mcpwm_comparator_set_compare_value` to set a new compare value for MCPWM comparator in order to keep the same PWM duty cycle.

---

**参数**

- **timer** -- [in] MCPWM timer handle, allocated by `mcpwm_new_timer`
- **period\_ticks** -- [in] New period in count ticks

**返回**

- ESP\_OK: Set new period for MCPWM timer successfully
- ESP\_ERR\_INVALID\_ARG: Set new period for MCPWM timer failed because of invalid argument
- ESP\_FAIL: Set new period for MCPWM timer failed because of other error

*esp\_err\_t* **mcpwm\_timer\_enable** (*mcpwm\_timer\_handle\_t* timer)

Enable MCPWM timer.

**参数** *timer* -- [in] MCPWM timer handle, allocated by `mcpwm_new_timer()`

**返回**

- ESP\_OK: Enable MCPWM timer successfully
- ESP\_ERR\_INVALID\_ARG: Enable MCPWM timer failed because of invalid argument
- ESP\_ERR\_INVALID\_STATE: Enable MCPWM timer failed because timer is enabled already
- ESP\_FAIL: Enable MCPWM timer failed because of other error

*esp\_err\_t* **mcpwm\_timer\_disable** (*mcpwm\_timer\_handle\_t* timer)

Disable MCPWM timer.

**参数** *timer* -- [in] MCPWM timer handle, allocated by `mcpwm_new_timer()`

**返回**

- ESP\_OK: Disable MCPWM timer successfully
- ESP\_ERR\_INVALID\_ARG: Disable MCPWM timer failed because of invalid argument
- ESP\_ERR\_INVALID\_STATE: Disable MCPWM timer failed because timer is disabled already
- ESP\_FAIL: Disable MCPWM timer failed because of other error

*esp\_err\_t* **mcpwm\_timer\_start\_stop** (*mcpwm\_timer\_handle\_t* timer, *mcpwm\_timer\_start\_stop\_cmd\_t* command)

Send specific start/stop commands to MCPWM timer.

**参数**

- **timer** -- [in] MCPWM timer handle, allocated by `mcpwm_new_timer()`
- **command** -- [in] Supported command list for MCPWM timer

**返回**

- ESP\_OK: Start or stop MCPWM timer successfully
- ESP\_ERR\_INVALID\_ARG: Start or stop MCPWM timer failed because of invalid argument
- ESP\_ERR\_INVALID\_STATE: Start or stop MCPWM timer failed because timer is not enabled
- ESP\_FAIL: Start or stop MCPWM timer failed because of other error

*esp\_err\_t* `mcpwm_timer_register_event_callbacks` (*mcpwm\_timer\_handle\_t* timer, const *mcpwm\_timer\_event\_callbacks\_t* \*cbs, void \*user\_data)

Set event callbacks for MCPWM timer.

---

**备注:** The first call to this function needs to be before the call to `mcpwm_timer_enable`

---



---

**备注:** User can deregister a previously registered callback by calling this function and setting the callback member in the `cbs` structure to NULL.

---

**参数**

- **timer** -- [in] MCPWM timer handle, allocated by `mcpwm_new_timer()`
- **cbs** -- [in] Group of callback functions
- **user\_data** -- [in] User data, which will be passed to callback functions directly

**返回**

- ESP\_OK: Set event callbacks successfully
- ESP\_ERR\_INVALID\_ARG: Set event callbacks failed because of invalid argument
- ESP\_ERR\_INVALID\_STATE: Set event callbacks failed because timer is not in init state
- ESP\_FAIL: Set event callbacks failed because of other error

*esp\_err\_t* `mcpwm_timer_set_phase_on_sync` (*mcpwm\_timer\_handle\_t* timer, const *mcpwm\_timer\_sync\_phase\_config\_t* \*config)

Set sync phase for MCPWM timer.

**参数**

- **timer** -- [in] MCPWM timer handle, allocated by `mcpwm_new_timer()`
- **config** -- [in] MCPWM timer sync phase configuration

**返回**

- ESP\_OK: Set sync phase for MCPWM timer successfully
- ESP\_ERR\_INVALID\_ARG: Set sync phase for MCPWM timer failed because of invalid argument
- ESP\_FAIL: Set sync phase for MCPWM timer failed because of other error

**Structures**

struct `mcpwm_timer_event_callbacks_t`

Group of supported MCPWM timer event callbacks.

---

**备注:** The callbacks are all running under ISR environment

---

**Public Members**

*mcpwm\_timer\_event\_cb\_t* **on\_full**

callback function when MCPWM timer counts to peak value

*mcpwm\_timer\_event\_cb\_t* **on\_empty**

callback function when MCPWM timer counts to zero

*mcpwm\_timer\_event\_cb\_t* **on\_stop**

callback function when MCPWM timer stops

struct **mcpwm\_timer\_config\_t**

MCPWM timer configuration.

### Public Members

int **group\_id**

Specify from which group to allocate the MCPWM timer

*mcpwm\_timer\_clock\_source\_t* **clk\_src**

MCPWM timer clock source

uint32\_t **resolution\_hz**

Counter resolution in Hz The step size of each count tick equals to (1 / resolution\_hz) seconds

*mcpwm\_timer\_count\_mode\_t* **count\_mode**

Count mode

uint32\_t **period\_ticks**

Number of count ticks within a period

int **intr\_priority**

MCPWM timer interrupt priority, if set to 0, the driver will try to allocate an interrupt with a relative low priority (1,2,3)

uint32\_t **update\_period\_on\_empty**

Whether to update period when timer counts to zero

uint32\_t **update\_period\_on\_sync**

Whether to update period on sync event

struct *mcpwm\_timer\_config\_t*::[anonymous] **flags**

Extra configuration flags for timer

struct **mcpwm\_timer\_sync\_phase\_config\_t**

MCPWM Timer sync phase configuration.

### Public Members

***mcpwm\_sync\_handle\_t* sync\_src**

The sync event source. Set to NULL will disable the timer being synced by others

**uint32\_t count\_value**

The count value that should lock to upon sync event

***mcpwm\_timer\_direction\_t* direction**

The count direction that should lock to upon sync event

**Header File**

- `components/esp_driver_mcpwm/include/driver/mcpwm_oper.h`
- This header file can be included with:

```
#include "driver/mcpwm_oper.h"
```

- This header file is a part of the API provided by the `esp_driver_mcpwm` component. To declare that your component depends on `esp_driver_mcpwm`, add the following to your `CMakeLists.txt`:

```
REQUIRES esp_driver_mcpwm
```

or

```
PRIV_REQUIRES esp_driver_mcpwm
```

**Functions**

***esp\_err\_t* mcpwm\_new\_operator** (const *mcpwm\_operator\_config\_t* \*config, *mcpwm\_oper\_handle\_t* \*ret\_oper)

Create MCPWM operator.

**参数**

- **config** -- [in] MCPWM operator configuration
- **ret\_oper** -- [out] Returned MCPWM operator handle

**返回**

- ESP\_OK: Create MCPWM operator successfully
- ESP\_ERR\_INVALID\_ARG: Create MCPWM operator failed because of invalid argument
- ESP\_ERR\_NO\_MEM: Create MCPWM operator failed because out of memory
- ESP\_ERR\_NOT\_FOUND: Create MCPWM operator failed because can't find free resource
- ESP\_FAIL: Create MCPWM operator failed because of other error

***esp\_err\_t* mcpwm\_del\_operator** (*mcpwm\_oper\_handle\_t* oper)

Delete MCPWM operator.

**参数** **oper** -- [in] MCPWM operator, allocated by `mcpwm_new_operator()`

**返回**

- ESP\_OK: Delete MCPWM operator successfully
- ESP\_ERR\_INVALID\_ARG: Delete MCPWM operator failed because of invalid argument
- ESP\_FAIL: Delete MCPWM operator failed because of other error

***esp\_err\_t* mcpwm\_operator\_connect\_timer** (*mcpwm\_oper\_handle\_t* oper, *mcpwm\_timer\_handle\_t* timer)

Connect MCPWM operator and timer, so that the operator can be driven by the timer.

**参数**

- **oper** -- [in] MCPWM operator handle, allocated by `mcpwm_new_operator()`
- **timer** -- [in] MCPWM timer handle, allocated by `mcpwm_new_timer()`

**返回**

- ESP\_OK: Connect MCPWM operator and timer successfully



- `ESP_ERR_INVALID_ARG`: Connect MCPWM operator and timer failed because of invalid argument
- `ESP_FAIL`: Connect MCPWM operator and timer failed because of other error

`esp_err_t mcpwm_operator_set_brake_on_fault` (*mcpwm\_oper\_handle\_t* oper, const *mcpwm\_brake\_config\_t* \*config)

Set brake method for MCPWM operator.

#### 参数

- **oper** -- [in] MCPWM operator, allocated by `mcpwm_new_operator()`
- **config** -- [in] MCPWM brake configuration

#### 返回

- `ESP_OK`: Set trip for operator successfully
- `ESP_ERR_INVALID_ARG`: Set trip for operator failed because of invalid argument
- `ESP_FAIL`: Set trip for operator failed because of other error

`esp_err_t mcpwm_operator_recover_from_fault` (*mcpwm\_oper\_handle\_t* oper, *mcpwm\_fault\_handle\_t* fault)

Try to make the operator recover from fault.

---

**备注:** To recover from fault or escape from trip, you make sure the fault signal has disappeared already. Otherwise the recovery can't succeed.

---

#### 参数

- **oper** -- [in] MCPWM operator, allocated by `mcpwm_new_operator()`
- **fault** -- [in] MCPWM fault handle

#### 返回

- `ESP_OK`: Recover from fault successfully
- `ESP_ERR_INVALID_ARG`: Recover from fault failed because of invalid argument
- `ESP_ERR_INVALID_STATE`: Recover from fault failed because the fault source is still active
- `ESP_FAIL`: Recover from fault failed because of other error

`esp_err_t mcpwm_operator_register_event_callbacks` (*mcpwm\_oper\_handle\_t* oper, const *mcpwm\_operator\_event\_callbacks\_t* \*cbs, void \*user\_data)

Set event callbacks for MCPWM operator.

---

**备注:** User can deregister a previously registered callback by calling this function and setting the callback member in the `cbs` structure to `NULL`.

---

#### 参数

- **oper** -- [in] MCPWM operator handle, allocated by `mcpwm_new_operator()`
- **cbs** -- [in] Group of callback functions
- **user\_data** -- [in] User data, which will be passed to callback functions directly

#### 返回

- `ESP_OK`: Set event callbacks successfully
- `ESP_ERR_INVALID_ARG`: Set event callbacks failed because of invalid argument
- `ESP_FAIL`: Set event callbacks failed because of other error

`esp_err_t mcpwm_operator_apply_carrier` (*mcpwm\_oper\_handle\_t* oper, const *mcpwm\_carrier\_config\_t* \*config)

Apply carrier feature for MCPWM operator.

#### 参数

- **oper** -- [in] MCPWM operator, allocated by `mcpwm_new_operator()`



- **config** -- [in] MCPWM carrier specific configuration
- 返回
- ESP\_OK: Set carrier for operator successfully
  - ESP\_ERR\_INVALID\_ARG: Set carrier for operator failed because of invalid argument
  - ESP\_FAIL: Set carrier for operator failed because of other error

## Structures

struct **mcpwm\_operator\_config\_t**

MCPWM operator configuration.

### Public Members

int **group\_id**

Specify from which group to allocate the MCPWM operator

int **intr\_priority**

MCPWM operator interrupt priority, if set to 0, the driver will try to allocate an interrupt with a relative low priority (1,2,3)

uint32\_t **update\_gen\_action\_on\_tez**

Whether to update generator action when timer counts to zero

uint32\_t **update\_gen\_action\_on\_tep**

Whether to update generator action when timer counts to peak

uint32\_t **update\_gen\_action\_on\_sync**

Whether to update generator action on sync event

uint32\_t **update\_dead\_time\_on\_tez**

Whether to update dead time when timer counts to zero

uint32\_t **update\_dead\_time\_on\_tep**

Whether to update dead time when timer counts to peak

uint32\_t **update\_dead\_time\_on\_sync**

Whether to update dead time on sync event

struct *mcpwm\_operator\_config\_t*::[anonymous] **flags**

Extra configuration flags for operator

struct **mcpwm\_brake\_config\_t**

MCPWM brake configuration structure.

### Public Members

*mcpwm\_fault\_handle\_t* **fault**

Which fault causes the operator to brake

*mcpwm\_operator\_brake\_mode\_t* **brake\_mode**

Brake mode

uint32\_t **cbc\_recover\_on\_tez**

Recovery CBC brake state on tez event

uint32\_t **cbc\_recover\_on\_tep**

Recovery CBC brake state on tep event

struct *mcpwm\_brake\_config\_t*::[anonymous] **flags**

Extra flags for brake configuration

struct **mcpwm\_operator\_event\_callbacks\_t**

Group of supported MCPWM operator event callbacks.

---

**备注:** The callbacks are all running under ISR environment

---

### Public Members

*mcpwm\_brake\_event\_cb\_t* **on\_brake\_cbc**

callback function when mcpwm operator brakes in CBC

*mcpwm\_brake\_event\_cb\_t* **on\_brake\_ost**

callback function when mcpwm operator brakes in OST

struct **mcpwm\_carrier\_config\_t**

MCPWM carrier configuration structure.

### Public Members

*mcpwm\_carrier\_clock\_source\_t* **clk\_src**

MCPWM carrier clock source

uint32\_t **frequency\_hz**

Carrier frequency in Hz

uint32\_t **first\_pulse\_duration\_us**

The duration of the first PWM pulse, in us

float **duty\_cycle**

Carrier duty cycle

uint32\_t **invert\_before\_modulate**

Invert the raw signal

uint32\_t **invert\_after\_modulate**

Invert the modulated signal

struct *mcpwm\_carrier\_config\_t*::[anonymous] **flags**

Extra flags for carrier configuration

## Header File

- `components/esp_driver_mcpwm/include/driver/mcpwm_cmpr.h`
- This header file can be included with:

```
#include "driver/mcpwm_cmpr.h"
```

- This header file is a part of the API provided by the `esp_driver_mcpwm` component. To declare that your component depends on `esp_driver_mcpwm`, add the following to your `CMakeLists.txt`:

```
REQUIRES esp_driver_mcpwm
```

or

```
PRIV_REQUIRES esp_driver_mcpwm
```

## Functions

*esp\_err\_t* **mcpwm\_new\_comparator** (*mcpwm\_oper\_handle\_t* oper, const *mcpwm\_comparator\_config\_t* \*config, *mcpwm\_cmpr\_handle\_t* \*ret\_cmpr)

Create MCPWM comparator.

### 参数

- **oper** -- [in] MCPWM operator, allocated by `mcpwm_new_operator()`, the new comparator will be allocated from this operator
- **config** -- [in] MCPWM comparator configuration
- **ret\_cmpr** -- [out] Returned MCPWM comparator

### 返回

- `ESP_OK`: Create MCPWM comparator successfully
- `ESP_ERR_INVALID_ARG`: Create MCPWM comparator failed because of invalid argument
- `ESP_ERR_NO_MEM`: Create MCPWM comparator failed because out of memory
- `ESP_ERR_NOT_FOUND`: Create MCPWM comparator failed because can't find free resource
- `ESP_FAIL`: Create MCPWM comparator failed because of other error

*esp\_err\_t* **mcpwm\_del\_comparator** (*mcpwm\_cmpr\_handle\_t* cmpr)

Delete MCPWM comparator.

**参数** **cmpr** -- [in] MCPWM comparator handle, allocated by `mcpwm_new_comparator()`

### 返回

- `ESP_OK`: Delete MCPWM comparator successfully
- `ESP_ERR_INVALID_ARG`: Delete MCPWM comparator failed because of invalid argument
- `ESP_FAIL`: Delete MCPWM comparator failed because of other error

*esp\_err\_t* **mcpwm\_comparator\_register\_event\_callbacks** (*mcpwm\_cmpr\_handle\_t* cmpr, const *mcpwm\_comparator\_event\_callbacks\_t* \*cbs, void \*user\_data)

Set event callbacks for MCPWM comparator.

---

**备注:** User can deregister a previously registered callback by calling this function and setting the callback member in the `cbs` structure to `NULL`.

---

**参数**

- **cmpr** -- **[in]** MCPWM comparator handle, allocated by `mcpwm_new_comparator()`
- **cbs** -- **[in]** Group of callback functions
- **user\_data** -- **[in]** User data, which will be passed to callback functions directly

**返回**

- **ESP\_OK**: Set event callbacks successfully
- **ESP\_ERR\_INVALID\_ARG**: Set event callbacks failed because of invalid argument
- **ESP\_FAIL**: Set event callbacks failed because of other error

`esp_err_t mcpwm_comparator_set_compare_value(mcpwm_cmpr_handle_t cmpr, uint32_t cmp_ticks)`

Set MCPWM comparator's compare value.

**参数**

- **cmpr** -- **[in]** MCPWM comparator handle, allocated by `mcpwm_new_comparator()`
- **cmp\_ticks** -- **[in]** The new compare value

**返回**

- **ESP\_OK**: Set MCPWM compare value successfully
- **ESP\_ERR\_INVALID\_ARG**: Set MCPWM compare value failed because of invalid argument (e.g. the `cmp_ticks` is out of range)
- **ESP\_ERR\_INVALID\_STATE**: Set MCPWM compare value failed because the operator doesn't have a timer connected
- **ESP\_FAIL**: Set MCPWM compare value failed because of other error

**Structures**

struct **mcpwm\_comparator\_config\_t**

MCPWM comparator configuration.

**Public Members**

int **intr\_priority**

MCPWM comparator interrupt priority, if set to 0, the driver will try to allocate an interrupt with a relative low priority (1,2,3)

uint32\_t **update\_cmp\_on\_tez**

Whether to update compare value when timer count equals to zero (tez)

uint32\_t **update\_cmp\_on\_tep**

Whether to update compare value when timer count equals to peak (tep)

uint32\_t **update\_cmp\_on\_sync**

Whether to update compare value on sync event

struct *mcpwm\_comparator\_config\_t*::[anonymous] **flags**

Extra configuration flags for comparator

struct **mcpwm\_comparator\_event\_callbacks\_t**

Group of supported MCPWM compare event callbacks.

---

**备注:** The callbacks are all running under ISR environment

---

## Public Members

### *mcpwm\_compare\_event\_cb\_t* on\_reach

ISR callback function which would be invoked when counter reaches compare value

## Header File

- `components/esp_driver_mcpwm/include/driver/mcpwm_gen.h`
- This header file can be included with:

```
#include "driver/mcpwm_gen.h"
```

- This header file is a part of the API provided by the `esp_driver_mcpwm` component. To declare that your component depends on `esp_driver_mcpwm`, add the following to your `CMakeLists.txt`:

```
REQUIRES esp_driver_mcpwm
```

or

```
PRIV_REQUIRES esp_driver_mcpwm
```

## Functions

*esp\_err\_t* **mcpwm\_new\_generator** (*mcpwm\_oper\_handle\_t* oper, const *mcpwm\_generator\_config\_t* \*config, *mcpwm\_gen\_handle\_t* \*ret\_gen)

Allocate MCPWM generator from given operator.

### 参数

- **oper** -- [in] MCPWM operator, allocated by `mcpwm_new_operator()`
- **config** -- [in] MCPWM generator configuration
- **ret\_gen** -- [out] Returned MCPWM generator

### 返回

- `ESP_OK`: Create MCPWM generator successfully
- `ESP_ERR_INVALID_ARG`: Create MCPWM generator failed because of invalid argument
- `ESP_ERR_NO_MEM`: Create MCPWM generator failed because out of memory
- `ESP_ERR_NOT_FOUND`: Create MCPWM generator failed because can't find free resource
- `ESP_FAIL`: Create MCPWM generator failed because of other error

*esp\_err\_t* **mcpwm\_del\_generator** (*mcpwm\_gen\_handle\_t* gen)

Delete MCPWM generator.

### 参数

**gen** -- [in] MCPWM generator handle, allocated by `mcpwm_new_generator()`

### 返回

- `ESP_OK`: Delete MCPWM generator successfully
- `ESP_ERR_INVALID_ARG`: Delete MCPWM generator failed because of invalid argument
- `ESP_FAIL`: Delete MCPWM generator failed because of other error

*esp\_err\_t* **mcpwm\_generator\_set\_force\_level** (*mcpwm\_gen\_handle\_t* gen, int level, bool hold\_on)

Set force level for MCPWM generator.

---

**备注:** The force level will be applied to the generator immediately, regardless any other events that would change the generator's behaviour.

---



---

**备注:** If the `hold_on` is true, the force level will retain forever, until user removes the force level by setting the force level to `-1`.

---

---

**备注:** If the `hold_on` is false, the force level can be overridden by the next event action.

---

**备注:** The force level set by this function can be inverted by GPIO matrix or dead-time module. So the level set here doesn't equal to the final output level.

---

#### 参数

- **gen** -- **[in]** MCPWM generator handle, allocated by `mcpwm_new_generator()`
- **level** -- **[in]** GPIO level to be applied to MCPWM generator, specially, -1 means to remove the force level
- **hold\_on** -- **[in]** Whether the forced PWM level should retain (i.e. will remain unchanged until manually remove the force level)

#### 返回

- `ESP_OK`: Set force level for MCPWM generator successfully
- `ESP_ERR_INVALID_ARG`: Set force level for MCPWM generator failed because of invalid argument
- `ESP_FAIL`: Set force level for MCPWM generator failed because of other error

*esp\_err\_t* `mcpwm_generator_set_action_on_timer_event` (*mcpwm\_gen\_handle\_t* gen, *mcpwm\_gen\_timer\_event\_action\_t* ev\_act)

Set generator action on MCPWM timer event.

#### 参数

- **gen** -- **[in]** MCPWM generator handle, allocated by `mcpwm_new_generator()`
- **ev\_act** -- **[in]** MCPWM timer event action, can be constructed by `MCPWM_GEN_TIMER_EVENT_ACTION` helper macro

#### 返回

- `ESP_OK`: Set generator action successfully
- `ESP_ERR_INVALID_ARG`: Set generator action failed because of invalid argument
- `ESP_ERR_INVALID_STATE`: Set generator action failed because of timer is not connected to operator
- `ESP_FAIL`: Set generator action failed because of other error

*esp\_err\_t* `mcpwm_generator_set_actions_on_timer_event` (*mcpwm\_gen\_handle\_t* gen, *mcpwm\_gen\_timer\_event\_action\_t* ev\_act, ...)

Set generator actions on multiple MCPWM timer events.

---

**备注:** This is an aggregation version of `mcpwm_generator_set_action_on_timer_event`, which allows user to set multiple actions in one call.

---

#### 参数

- **gen** -- **[in]** MCPWM generator handle, allocated by `mcpwm_new_generator()`
- **ev\_act** -- **[in]** MCPWM timer event action list, must be terminated by `MCPWM_GEN_TIMER_EVENT_ACTION_END()`

#### 返回

- `ESP_OK`: Set generator actions successfully
- `ESP_ERR_INVALID_ARG`: Set generator actions failed because of invalid argument
- `ESP_ERR_INVALID_STATE`: Set generator actions failed because of timer is not connected to operator
- `ESP_FAIL`: Set generator actions failed because of other error

*esp\_err\_t* **mcpwm\_generator\_set\_action\_on\_compare\_event** (*mcpwm\_gen\_handle\_t* generator, *mcpwm\_gen\_compare\_event\_action\_t* ev\_act)

Set generator action on MCPWM compare event.

#### 参数

- **generator** -- **[in]** MCPWM generator handle, allocated by `mcpwm_new_generator()`
- **ev\_act** -- **[in]** MCPWM compare event action, can be constructed by `MCPWM_GEN_COMPARE_EVENT_ACTION` helper macro

#### 返回

- `ESP_OK`: Set generator action successfully
- `ESP_ERR_INVALID_ARG`: Set generator action failed because of invalid argument
- `ESP_FAIL`: Set generator action failed because of other error

*esp\_err\_t* **mcpwm\_generator\_set\_actions\_on\_compare\_event** (*mcpwm\_gen\_handle\_t* generator, *mcpwm\_gen\_compare\_event\_action\_t* ev\_act, ...)

Set generator actions on multiple MCPWM compare events.

---

**备注:** This is an aggregation version of `mcpwm_generator_set_action_on_compare_event`, which allows user to set multiple actions in one call.

---

#### 参数

- **generator** -- **[in]** MCPWM generator handle, allocated by `mcpwm_new_generator()`
- **ev\_act** -- **[in]** MCPWM compare event action list, must be terminated by `MCPWM_GEN_COMPARE_EVENT_ACTION_END()`

#### 返回

- `ESP_OK`: Set generator actions successfully
- `ESP_ERR_INVALID_ARG`: Set generator actions failed because of invalid argument
- `ESP_FAIL`: Set generator actions failed because of other error

*esp\_err\_t* **mcpwm\_generator\_set\_action\_on\_brake\_event** (*mcpwm\_gen\_handle\_t* generator, *mcpwm\_gen\_brake\_event\_action\_t* ev\_act)

Set generator action on MCPWM brake event.

#### 参数

- **generator** -- **[in]** MCPWM generator handle, allocated by `mcpwm_new_generator()`
- **ev\_act** -- **[in]** MCPWM brake event action, can be constructed by `MCPWM_GEN_BRAKE_EVENT_ACTION` helper macro

#### 返回

- `ESP_OK`: Set generator action successfully
- `ESP_ERR_INVALID_ARG`: Set generator action failed because of invalid argument
- `ESP_FAIL`: Set generator action failed because of other error

*esp\_err\_t* **mcpwm\_generator\_set\_actions\_on\_brake\_event** (*mcpwm\_gen\_handle\_t* generator, *mcpwm\_gen\_brake\_event\_action\_t* ev\_act, ...)

Set generator actions on multiple MCPWM brake events.

---

**备注:** This is an aggregation version of `mcpwm_generator_set_action_on_brake_event`, which allows user to set multiple actions in one call.

---

**参数**

- **generator** -- **[in]** MCPWM generator handle, allocated by `mcpwm_new_generator()`
- **ev\_act** -- **[in]** MCPWM brake event action list, must be terminated by `MCPWM_GEN_BRAKE_EVENT_ACTION_END()`

**返回**

- `ESP_OK`: Set generator actions successfully
- `ESP_ERR_INVALID_ARG`: Set generator actions failed because of invalid argument
- `ESP_FAIL`: Set generator actions failed because of other error

*esp\_err\_t* `mcpwm_generator_set_action_on_fault_event` (*mcpwm\_gen\_handle\_t* generator, *mcpwm\_gen\_fault\_event\_action\_t* ev\_act)

Set generator action on MCPWM Fault event.

**参数**

- **generator** -- **[in]** MCPWM generator handle, allocated by `mcpwm_new_generator()`
- **ev\_act** -- **[in]** MCPWM trigger event action, can be constructed by `MCPWM_GEN_FAULT_EVENT_ACTION` helper macro

**返回**

- `ESP_OK`: Set generator action successfully
- `ESP_ERR_INVALID_ARG`: Set generator action failed because of invalid argument
- `ESP_FAIL`: Set generator action failed because of other error

*esp\_err\_t* `mcpwm_generator_set_action_on_sync_event` (*mcpwm\_gen\_handle\_t* generator, *mcpwm\_gen\_sync\_event\_action\_t* ev\_act)

Set generator action on MCPWM Sync event.

---

**备注:** The trigger only support one sync action, regardless of the kinds. Should not call this function more than once.

---

**参数**

- **generator** -- **[in]** MCPWM generator handle, allocated by `mcpwm_new_generator()`
- **ev\_act** -- **[in]** MCPWM trigger event action, can be constructed by `MCPWM_GEN_SYNC_EVENT_ACTION` helper macro

**返回**

- `ESP_OK`: Set generator action successfully
- `ESP_ERR_INVALID_ARG`: Set generator action failed because of invalid argument
- `ESP_FAIL`: Set generator action failed because of other error

*esp\_err\_t* `mcpwm_generator_set_dead_time` (*mcpwm\_gen\_handle\_t* in\_generator, *mcpwm\_gen\_handle\_t* out\_generator, const *mcpwm\_dead\_time\_config\_t* \*config)

Set dead time for MCPWM generator.

---

**备注:** Due to a hardware limitation, you can't set rising edge delay for both MCPWM generator 0 and 1 at the same time, otherwise, there will be a conflict inside the dead time module. The same goes for the falling edge setting. But you can set both the rising edge and falling edge delay for the same MCPWM generator.

---

**参数**

- **in\_generator** -- **[in]** MCPWM generator, before adding the dead time
- **out\_generator** -- **[in]** MCPWM generator, after adding the dead time
- **config** -- **[in]** MCPWM dead time configuration

**返回**



- `ESP_OK`: Set dead time for MCPWM generator successfully
- `ESP_ERR_INVALID_ARG`: Set dead time for MCPWM generator failed because of invalid argument
- `ESP_ERR_INVALID_STATE`: Set dead time for MCPWM generator failed because of invalid state (e.g. delay module is already in use by other generator)
- `ESP_FAIL`: Set dead time for MCPWM generator failed because of other error

## Structures

struct `mcpwm_generator_config_t`

MCPWM generator configuration.

### Public Members

int `gen_gpio_num`

The GPIO number used to output the PWM signal

uint32\_t `invert_pwm`

Whether to invert the PWM signal (done by GPIO matrix)

uint32\_t `io_loop_back`

For debug/test, the signal output from the GPIO will be fed to the input path as well

uint32\_t `io_od_mode`

Configure the GPIO as open-drain mode

uint32\_t `pull_up`

Whether to pull up internally

uint32\_t `pull_down`

Whether to pull down internally

struct `mcpwm_generator_config_t::[anonymous]` `flags`

Extra configuration flags for generator

struct `mcpwm_gen_timer_event_action_t`

Generator action on specific timer event.

### Public Members

`mcpwm_timer_direction_t` `direction`

Timer direction

`mcpwm_timer_event_t` `event`

Timer event

`mcpwm_generator_action_t` `action`

Generator action should perform

struct **mcpwm\_gen\_compare\_event\_action\_t**

Generator action on specific comparator event.

### Public Members

*mcpwm\_timer\_direction\_t* **direction**

Timer direction

*mcpwm\_cmpr\_handle\_t* **comparator**

Comparator handle

*mcpwm\_generator\_action\_t* **action**

Generator action should perform

struct **mcpwm\_gen\_brake\_event\_action\_t**

Generator action on specific brake event.

### Public Members

*mcpwm\_timer\_direction\_t* **direction**

Timer direction

*mcpwm\_operator\_brake\_mode\_t* **brake\_mode**

Brake mode

*mcpwm\_generator\_action\_t* **action**

Generator action should perform

struct **mcpwm\_gen\_fault\_event\_action\_t**

Generator action on specific fault event.

### Public Members

*mcpwm\_timer\_direction\_t* **direction**

Timer direction

*mcpwm\_fault\_handle\_t* **fault**

Which fault as the trigger. Only support GPIO fault

*mcpwm\_generator\_action\_t* **action**

Generator action should perform

struct **mcpwm\_gen\_sync\_event\_action\_t**

Generator action on specific sync event.

### Public Members

*mcpwm\_timer\_direction\_t* **direction**

Timer direction

*mcpwm\_sync\_handle\_t* **sync**

Which sync as the trigger

*mcpwm\_generator\_action\_t* **action**

Generator action should perform

struct **mcpwm\_dead\_time\_config\_t**

MCPWM dead time configuration structure.

### Public Members

uint32\_t **posedge\_delay\_ticks**

delay time applied to rising edge, 0 means no rising delay time

uint32\_t **negedge\_delay\_ticks**

delay time applied to falling edge, 0 means no falling delay time

uint32\_t **invert\_output**

Invert the signal after applied the dead time

struct *mcpwm\_dead\_time\_config\_t*::[anonymous] **flags**

Extra flags for dead time configuration

### Macros

**MCPWM\_GEN\_TIMER\_EVENT\_ACTION** (dir, ev, act)

Help macros to construct a *mcpwm\_gen\_timer\_event\_action\_t* entry.

**MCPWM\_GEN\_TIMER\_EVENT\_ACTION\_END** ()

**MCPWM\_GEN\_COMPARE\_EVENT\_ACTION** (dir, cmp, act)

Help macros to construct a *mcpwm\_gen\_compare\_event\_action\_t* entry.

**MCPWM\_GEN\_COMPARE\_EVENT\_ACTION\_END** ()

**MCPWM\_GEN\_BRAKE\_EVENT\_ACTION** (dir, mode, act)

Help macros to construct a *mcpwm\_gen\_brake\_event\_action\_t* entry.

**MCPWM\_GEN\_BRAKE\_EVENT\_ACTION\_END** ()

**MCPWM\_GEN\_FAULT\_EVENT\_ACTION** (dir, flt, act)

Help macros to construct a *mcpwm\_gen\_fault\_event\_action\_t* entry.

**MCPWM\_GEN\_SYNC\_EVENT\_ACTION** (dir, syn, act)

Help macros to construct a *mcpwm\_gen\_sync\_event\_action\_t* entry.

## Header File

- `components/esp_driver_mcpwm/include/driver/mcpwm_fault.h`
- This header file can be included with:

```
#include "driver/mcpwm_fault.h"
```

- This header file is a part of the API provided by the `esp_driver_mcpwm` component. To declare that your component depends on `esp_driver_mcpwm`, add the following to your `CMakeLists.txt`:

```
REQUIRES esp_driver_mcpwm
```

or

```
PRIV_REQUIRES esp_driver_mcpwm
```

## Functions

`esp_err_t mcpwm_new_gpio_fault` (const `mcpwm_gpio_fault_config_t` \*config, `mcpwm_fault_handle_t` \*ret\_fault)

Create MCPWM GPIO fault.

### 参数

- **config** -- [in] MCPWM GPIO fault configuration
- **ret\_fault** -- [out] Returned GPIO fault handle

### 返回

- `ESP_OK`: Create MCPWM GPIO fault successfully
- `ESP_ERR_INVALID_ARG`: Create MCPWM GPIO fault failed because of invalid argument
- `ESP_ERR_NO_MEM`: Create MCPWM GPIO fault failed because out of memory
- `ESP_ERR_NOT_FOUND`: Create MCPWM GPIO fault failed because can't find free resource
- `ESP_FAIL`: Create MCPWM GPIO fault failed because of other error

`esp_err_t mcpwm_new_soft_fault` (const `mcpwm_soft_fault_config_t` \*config, `mcpwm_fault_handle_t` \*ret\_fault)

Create MCPWM software fault.

### 参数

- **config** -- [in] MCPWM software fault configuration
- **ret\_fault** -- [out] Returned software fault handle

### 返回

- `ESP_OK`: Create MCPWM software fault successfully
- `ESP_ERR_INVALID_ARG`: Create MCPWM software fault failed because of invalid argument
- `ESP_ERR_NO_MEM`: Create MCPWM software fault failed because out of memory
- `ESP_FAIL`: Create MCPWM software fault failed because of other error

`esp_err_t mcpwm_del_fault` (`mcpwm_fault_handle_t` fault)

Delete MCPWM fault.

参数 **fault** -- [in] MCPWM fault handle allocated by `mcpwm_new_gpio_fault()` or `mcpwm_new_soft_fault()`

### 返回

- `ESP_OK`: Delete MCPWM fault successfully
- `ESP_ERR_INVALID_ARG`: Delete MCPWM fault failed because of invalid argument
- `ESP_FAIL`: Delete MCPWM fault failed because of other error

`esp_err_t mcpwm_soft_fault_activate` (`mcpwm_fault_handle_t` fault)

Activate the software fault, trigger the fault event for once.

参数 **fault** -- [in] MCPWM soft fault, allocated by `mcpwm_new_soft_fault()`

### 返回

- ESP\_OK: Trigger MCPWM software fault event successfully
- ESP\_ERR\_INVALID\_ARG: Trigger MCPWM software fault event failed because of invalid argument
- ESP\_FAIL: Trigger MCPWM software fault event failed because of other error

`esp_err_t mcpwm_fault_register_event_callbacks` (`mcpwm_fault_handle_t` fault, const `mcpwm_fault_event_callbacks_t` \*cbs, void \*user\_data)

Set event callbacks for MCPWM fault.

---

**备注:** User can deregister a previously registered callback by calling this function and setting the callback member in the `cbs` structure to NULL.

---

#### 参数

- **fault** -- **[in]** MCPWM GPIO fault handle, allocated by `mcpwm_new_gpio_fault()`
- **cbs** -- **[in]** Group of callback functions
- **user\_data** -- **[in]** User data, which will be passed to callback functions directly

#### 返回

- ESP\_OK: Set event callbacks successfully
- ESP\_ERR\_INVALID\_ARG: Set event callbacks failed because of invalid argument
- ESP\_FAIL: Set event callbacks failed because of other error

## Structures

struct `mcpwm_gpio_fault_config_t`

MCPWM GPIO fault configuration structure.

### Public Members

int `group_id`

In which MCPWM group that the GPIO fault belongs to

int `intr_priority`

MCPWM GPIO fault interrupt priority, if set to 0, the driver will try to allocate an interrupt with a relative low priority (1,2,3)

int `gpio_num`

GPIO used by the fault signal

uint32\_t `active_level`

On which level the fault signal is treated as active

uint32\_t `io_loop_back`

For debug/test, the signal output from the GPIO will be fed to the input path as well

uint32\_t `pull_up`

Whether to pull up internally

uint32\_t `pull_down`

Whether to pull down internally

```
struct mcpwm_gpio_fault_config_t::[anonymous] flags
```

Extra configuration flags for GPIO fault

```
struct mcpwm_soft_fault_config_t
```

MCPWM software fault configuration structure.

```
struct mcpwm_fault_event_callbacks_t
```

Group of supported MCPWM fault event callbacks.

---

备注: The callbacks are all running under ISR environment

---

## Public Members

*mcpwm\_fault\_event\_cb\_t* **on\_fault\_enter**

ISR callback function that would be invoked when fault signal becomes active

*mcpwm\_fault\_event\_cb\_t* **on\_fault\_exit**

ISR callback function that would be invoked when fault signal becomes inactive

## Header File

- [components/esp\\_driver\\_mcpwm/include/driver/mcpwm\\_sync.h](#)
- This header file can be included with:

```
#include "driver/mcpwm_sync.h"
```

- This header file is a part of the API provided by the `esp_driver_mcpwm` component. To declare that your component depends on `esp_driver_mcpwm`, add the following to your CMakeLists.txt:

```
REQUIRES esp_driver_mcpwm
```

or

```
PRIV_REQUIRES esp_driver_mcpwm
```

## Functions

*esp\_err\_t* **mcpwm\_new\_timer\_sync\_src** (*mcpwm\_timer\_handle\_t* timer, const *mcpwm\_timer\_sync\_src\_config\_t* \*config, *mcpwm\_sync\_handle\_t* \*ret\_sync)

Create MCPWM timer sync source.

### 参数

- **timer** -- [in] MCPWM timer handle, allocated by `mcpwm_new_timer()`
- **config** -- [in] MCPWM timer sync source configuration
- **ret\_sync** -- [out] Returned MCPWM sync handle

### 返回

- `ESP_OK`: Create MCPWM timer sync source successfully
- `ESP_ERR_INVALID_ARG`: Create MCPWM timer sync source failed because of invalid argument
- `ESP_ERR_NO_MEM`: Create MCPWM timer sync source failed because out of memory
- `ESP_ERR_INVALID_STATE`: Create MCPWM timer sync source failed because the timer has created a sync source before
- `ESP_FAIL`: Create MCPWM timer sync source failed because of other error

```
esp_err_t mcpwm_new_gpio_sync_src (const mcpwm_gpio_sync_src_config_t *config,
                                   mcpwm_sync_handle_t *ret_sync)
```

Create MCPWM GPIO sync source.

#### 参数

- **config** -- [in] MCPWM GPIO sync source configuration
- **ret\_sync** -- [out] Returned MCPWM GPIO sync handle

#### 返回

- ESP\_OK: Create MCPWM GPIO sync source successfully
- ESP\_ERR\_INVALID\_ARG: Create MCPWM GPIO sync source failed because of invalid argument
- ESP\_ERR\_NO\_MEM: Create MCPWM GPIO sync source failed because out of memory
- ESP\_ERR\_NOT\_FOUND: Create MCPWM GPIO sync source failed because can't find free resource
- ESP\_FAIL: Create MCPWM GPIO sync source failed because of other error

```
esp_err_t mcpwm_new_soft_sync_src (const mcpwm_soft_sync_config_t *config, mcpwm_sync_handle_t
                                   *ret_sync)
```

Create MCPWM software sync source.

#### 参数

- **config** -- [in] MCPWM software sync source configuration
- **ret\_sync** -- [out] Returned software sync handle

#### 返回

- ESP\_OK: Create MCPWM software sync successfully
- ESP\_ERR\_INVALID\_ARG: Create MCPWM software sync failed because of invalid argument
- ESP\_ERR\_NO\_MEM: Create MCPWM software sync failed because out of memory
- ESP\_FAIL: Create MCPWM software sync failed because of other error

```
esp_err_t mcpwm_del_sync_src (mcpwm_sync_handle_t sync)
```

Delete MCPWM sync source.

**参数** **sync** -- [in] MCPWM sync handle, allocated by `mcpwm_new_timer_sync_src()` or `mcpwm_new_gpio_sync_src()` or `mcpwm_new_soft_sync_src()`

#### 返回

- ESP\_OK: Delete MCPWM sync source successfully
- ESP\_ERR\_INVALID\_ARG: Delete MCPWM sync source failed because of invalid argument
- ESP\_FAIL: Delete MCPWM sync source failed because of other error

```
esp_err_t mcpwm_soft_sync_activate (mcpwm_sync_handle_t sync)
```

Activate the software sync, trigger the sync event for once.

**参数** **sync** -- [in] MCPWM soft sync handle, allocated by `mcpwm_new_soft_sync_src()`

#### 返回

- ESP\_OK: Trigger MCPWM software sync event successfully
- ESP\_ERR\_INVALID\_ARG: Trigger MCPWM software sync event failed because of invalid argument
- ESP\_FAIL: Trigger MCPWM software sync event failed because of other error

## Structures

```
struct mcpwm_timer_sync_src_config_t
```

MCPWM timer sync source configuration.

## Public Members

`mcpwm_timer_event_t timer_event`

Timer event, upon which MCPWM timer will generate the sync signal

`uint32_t propagate_input_sync`

The input sync signal would be routed to its sync output

struct `mcpwm_timer_sync_src_config_t`::[anonymous] **flags**

Extra configuration flags for timer sync source

struct `mcpwm_gpio_sync_src_config_t`

MCPWM GPIO sync source configuration.

### Public Members

`int group_id`

MCPWM group ID

`int gpio_num`

GPIO used by sync source

`uint32_t active_neg`

Whether the sync signal is active on negedge, by default, the sync signal's posedge is treated as active

`uint32_t io_loop_back`

For debug/test, the signal output from the GPIO will be fed to the input path as well

`uint32_t pull_up`

Whether to pull up internally

`uint32_t pull_down`

Whether to pull down internally

struct `mcpwm_gpio_sync_src_config_t`::[anonymous] **flags**

Extra configuration flags for GPIO sync source

struct `mcpwm_soft_sync_config_t`

MCPWM software sync configuration structure.

### Header File

- [components/esp\\_driver\\_mcpwm/include/driver/mcpwm\\_cap.h](#)
- This header file can be included with:

```
#include "driver/mcpwm_cap.h"
```

- This header file is a part of the API provided by the `esp_driver_mcpwm` component. To declare that your component depends on `esp_driver_mcpwm`, add the following to your `CMakeLists.txt`:

```
REQUIRES esp_driver_mcpwm
```

or



PRIV_REQUIRES esp_driver_mcpwm
--------------------------------

## Functions

*esp\_err\_t* **mcpwm\_new\_capture\_timer** (const *mcpwm\_capture\_timer\_config\_t* \*config, *mcpwm\_cap\_timer\_handle\_t* \*ret\_cap\_timer)

Create MCPWM capture timer.

### 参数

- **config** -- [in] MCPWM capture timer configuration
- **ret\_cap\_timer** -- [out] Returned MCPWM capture timer handle

### 返回

- ESP\_OK: Create MCPWM capture timer successfully
- ESP\_ERR\_INVALID\_ARG: Create MCPWM capture timer failed because of invalid argument
- ESP\_ERR\_NO\_MEM: Create MCPWM capture timer failed because out of memory
- ESP\_ERR\_NOT\_FOUND: Create MCPWM capture timer failed because can't find free resource
- ESP\_FAIL: Create MCPWM capture timer failed because of other error

*esp\_err\_t* **mcpwm\_del\_capture\_timer** (*mcpwm\_cap\_timer\_handle\_t* cap\_timer)

Delete MCPWM capture timer.

参数 **cap\_timer** -- [in] MCPWM capture timer, allocated by `mcpwm_new_capture_timer()`

### 返回

- ESP\_OK: Delete MCPWM capture timer successfully
- ESP\_ERR\_INVALID\_ARG: Delete MCPWM capture timer failed because of invalid argument
- ESP\_FAIL: Delete MCPWM capture timer failed because of other error

*esp\_err\_t* **mcpwm\_capture\_timer\_enable** (*mcpwm\_cap\_timer\_handle\_t* cap\_timer)

Enable MCPWM capture timer.

参数 **cap\_timer** -- [in] MCPWM capture timer handle, allocated by `mcpwm_new_capture_timer()`

### 返回

- ESP\_OK: Enable MCPWM capture timer successfully
- ESP\_ERR\_INVALID\_ARG: Enable MCPWM capture timer failed because of invalid argument
- ESP\_ERR\_INVALID\_STATE: Enable MCPWM capture timer failed because timer is enabled already
- ESP\_FAIL: Enable MCPWM capture timer failed because of other error

*esp\_err\_t* **mcpwm\_capture\_timer\_disable** (*mcpwm\_cap\_timer\_handle\_t* cap\_timer)

Disable MCPWM capture timer.

参数 **cap\_timer** -- [in] MCPWM capture timer handle, allocated by `mcpwm_new_capture_timer()`

### 返回

- ESP\_OK: Disable MCPWM capture timer successfully
- ESP\_ERR\_INVALID\_ARG: Disable MCPWM capture timer failed because of invalid argument
- ESP\_ERR\_INVALID\_STATE: Disable MCPWM capture timer failed because timer is disabled already
- ESP\_FAIL: Disable MCPWM capture timer failed because of other error

*esp\_err\_t* **mcpwm\_capture\_timer\_start** (*mcpwm\_cap\_timer\_handle\_t* cap\_timer)

Start MCPWM capture timer.

**参数** `cap_timer` -- **[in]** MCPWM capture timer, allocated by `mcpwm_new_capture_timer()`

**返回**

- ESP\_OK: Start MCPWM capture timer successfully
- ESP\_ERR\_INVALID\_ARG: Start MCPWM capture timer failed because of invalid argument
- ESP\_FAIL: Start MCPWM capture timer failed because of other error

*esp\_err\_t* `mcpwm_capture_timer_stop` (*mcpwm\_cap\_timer\_handle\_t* cap\_timer)

Stop MCPWM capture timer.

**参数** `cap_timer` -- **[in]** MCPWM capture timer, allocated by `mcpwm_new_capture_timer()`

**返回**

- ESP\_OK: Stop MCPWM capture timer successfully
- ESP\_ERR\_INVALID\_ARG: Stop MCPWM capture timer failed because of invalid argument
- ESP\_FAIL: Stop MCPWM capture timer failed because of other error

*esp\_err\_t* `mcpwm_capture_timer_get_resolution` (*mcpwm\_cap\_timer\_handle\_t* cap\_timer, `uint32_t` \*out\_resolution)

Get MCPWM capture timer resolution, in Hz.

**参数**

- `cap_timer` -- **[in]** MCPWM capture timer, allocated by `mcpwm_new_capture_timer()`
- `out_resolution` -- **[out]** Returned capture timer resolution, in Hz

**返回**

- ESP\_OK: Get capture timer resolution successfully
- ESP\_ERR\_INVALID\_ARG: Get capture timer resolution failed because of invalid argument
- ESP\_FAIL: Get capture timer resolution failed because of other error

*esp\_err\_t* `mcpwm_capture_timer_set_phase_on_sync` (*mcpwm\_cap\_timer\_handle\_t* cap\_timer, `const mcpwm_capture_timer_sync_phase_config_t` \*config)

Set sync phase for MCPWM capture timer.

**参数**

- `cap_timer` -- **[in]** MCPWM capture timer, allocated by `mcpwm_new_capture_timer()`
- `config` -- **[in]** MCPWM capture timer sync phase configuration

**返回**

- ESP\_OK: Set sync phase for MCPWM capture timer successfully
- ESP\_ERR\_INVALID\_ARG: Set sync phase for MCPWM capture timer failed because of invalid argument
- ESP\_FAIL: Set sync phase for MCPWM capture timer failed because of other error

*esp\_err\_t* `mcpwm_new_capture_channel` (*mcpwm\_cap\_timer\_handle\_t* cap\_timer, `const mcpwm_capture_channel_config_t` \*config, *mcpwm\_cap\_channel\_handle\_t* \*ret\_cap\_channel)

Create MCPWM capture channel.

---

**备注:** The created capture channel won't be enabled until calling `mcpwm_capture_channel_enable`

---

**参数**

- `cap_timer` -- **[in]** MCPWM capture timer, allocated by `mcpwm_new_capture_timer()`, will be connected to the new capture channel

- **config** -- [in] MCPWM capture channel configuration
- **ret\_cap\_channel** -- [out] Returned MCPWM capture channel

**返回**

- ESP\_OK: Create MCPWM capture channel successfully
- ESP\_ERR\_INVALID\_ARG: Create MCPWM capture channel failed because of invalid argument
- ESP\_ERR\_NO\_MEM: Create MCPWM capture channel failed because out of memory
- ESP\_ERR\_NOT\_FOUND: Create MCPWM capture channel failed because can't find free resource
- ESP\_FAIL: Create MCPWM capture channel failed because of other error

*esp\_err\_t* **mcpwm\_del\_capture\_channel** (*mcpwm\_cap\_channel\_handle\_t* cap\_channel)

Delete MCPWM capture channel.

**参数** **cap\_channel** -- [in] MCPWM capture channel handle, allocated by `mcpwm_new_capture_channel()`

**返回**

- ESP\_OK: Delete MCPWM capture channel successfully
- ESP\_ERR\_INVALID\_ARG: Delete MCPWM capture channel failed because of invalid argument
- ESP\_FAIL: Delete MCPWM capture channel failed because of other error

*esp\_err\_t* **mcpwm\_capture\_channel\_enable** (*mcpwm\_cap\_channel\_handle\_t* cap\_channel)

Enable MCPWM capture channel.

---

**备注:** This function will transit the channel state from init to enable.

---



---

**备注:** This function will enable the interrupt service, if it's lazy installed in `mcpwm_capture_channel_register_event_callbacks()`.

---

**参数** **cap\_channel** -- [in] MCPWM capture channel handle, allocated by `mcpwm_new_capture_channel()`

**返回**

- ESP\_OK: Enable MCPWM capture channel successfully
- ESP\_ERR\_INVALID\_ARG: Enable MCPWM capture channel failed because of invalid argument
- ESP\_ERR\_INVALID\_STATE: Enable MCPWM capture channel failed because the channel is already enabled
- ESP\_FAIL: Enable MCPWM capture channel failed because of other error

*esp\_err\_t* **mcpwm\_capture\_channel\_disable** (*mcpwm\_cap\_channel\_handle\_t* cap\_channel)

Disable MCPWM capture channel.

**参数** **cap\_channel** -- [in] MCPWM capture channel handle, allocated by `mcpwm_new_capture_channel()`

**返回**

- ESP\_OK: Disable MCPWM capture channel successfully
- ESP\_ERR\_INVALID\_ARG: Disable MCPWM capture channel failed because of invalid argument
- ESP\_ERR\_INVALID\_STATE: Disable MCPWM capture channel failed because the channel is not enabled yet
- ESP\_FAIL: Disable MCPWM capture channel failed because of other error

*esp\_err\_t* **mcpwm\_capture\_channel\_register\_event\_callbacks** (*mcpwm\_cap\_channel\_handle\_t* cap\_channel, const *mcpwm\_capture\_event\_callbacks\_t* \*cbs, void \*user\_data)

Set event callbacks for MCPWM capture channel.

---

**备注:** The first call to this function needs to be before the call to `mcpwm_capture_channel_enable`

---



---

**备注:** User can deregister a previously registered callback by calling this function and setting the callback member in the `cbs` structure to NULL.

---

#### 参数

- **cap\_channel** -- **[in]** MCPWM capture channel handle, allocated by `mcpwm_new_capture_channel()`
- **cbs** -- **[in]** Group of callback functions
- **user\_data** -- **[in]** User data, which will be passed to callback functions directly

#### 返回

- **ESP\_OK**: Set event callbacks successfully
- **ESP\_ERR\_INVALID\_ARG**: Set event callbacks failed because of invalid argument
- **ESP\_ERR\_INVALID\_STATE**: Set event callbacks failed because the channel is not in init state
- **ESP\_FAIL**: Set event callbacks failed because of other error

*esp\_err\_t* `mcpwm_capture_channel_trigger_soft_catch` (*mcpwm\_cap\_channel\_handle\_t* cap\_channel)

Trigger a catch by software.

**参数** **cap\_channel** -- **[in]** MCPWM capture channel handle, allocated by `mcpwm_new_capture_channel()`

#### 返回

- **ESP\_OK**: Trigger software catch successfully
- **ESP\_ERR\_INVALID\_ARG**: Trigger software catch failed because of invalid argument
- **ESP\_ERR\_INVALID\_STATE**: Trigger software catch failed because the channel is not enabled yet
- **ESP\_FAIL**: Trigger software catch failed because of other error

## Structures

struct **mcpwm\_capture\_timer\_config\_t**

MCPWM capture timer configuration structure.

### Public Members

int **group\_id**

Specify from which group to allocate the capture timer

*mcpwm\_capture\_clock\_source\_t* **clk\_src**

MCPWM capture timer clock source

uint32\_t **resolution\_hz**

Resolution of capture timer

struct **mcpwm\_capture\_timer\_sync\_phase\_config\_t**

MCPWM Capture timer sync phase configuration.

### Public Members

*mcpwm\_sync\_handle\_t* **sync\_src**

The sync event source

uint32\_t **count\_value**

The count value that should lock to upon sync event

*mcpwm\_timer\_direction\_t* **direction**

The count direction that should lock to upon sync event

struct **mcpwm\_capture\_channel\_config\_t**

MCPWM capture channel configuration structure.

### Public Members

int **gpio\_num**

GPIO used capturing input signal

int **intr\_priority**

MCPWM capture interrupt priority, if set to 0, the driver will try to allocate an interrupt with a relative low priority (1,2,3)

uint32\_t **prescale**

Prescale of input signal, effective frequency = cap\_input\_clk/prescale

struct *mcpwm\_capture\_channel\_config\_t::extra\_flags* **flags**

Extra configuration flags for capture channel

struct **extra\_flags**

Extra configuration flags for capture channel.

### Public Members

uint32\_t **pos\_edge**

Whether to capture on positive edge

uint32\_t **neg\_edge**

Whether to capture on negative edge

uint32\_t **pull\_up**

Whether to pull up internally

uint32\_t **pull\_down**

Whether to pull down internally

uint32\_t **invert\_cap\_signal**

Invert the input capture signal

**uint32\_t io\_loop\_back**

For debug/test, the signal output from the GPIO will be fed to the input path as well

**uint32\_t keep\_io\_conf\_at\_exit**

For debug/test, whether to keep the GPIO configuration when capture channel is deleted. By default, driver will reset the GPIO pin at exit.

**struct mcpwm\_capture\_event\_callbacks\_t**

Group of supported MCPWM capture event callbacks.

---

**备注:** The callbacks are all running under ISR environment

---

**Public Members*****mcpwm\_capture\_event\_cb\_t* on\_cap**

Callback function that would be invoked when capture event occurred

**Header File**

- [components/esp\\_driver\\_mcpwm/include/driver/mcpwm\\_etm.h](#)
- This header file can be included with:

```
#include "driver/mcpwm_etm.h"
```

- This header file is a part of the API provided by the `esp_driver_mcpwm` component. To declare that your component depends on `esp_driver_mcpwm`, add the following to your CMakeLists.txt:

```
REQUIRES esp_driver_mcpwm
```

or

```
PRIV_REQUIRES esp_driver_mcpwm
```

**Functions**

***esp\_err\_t* mcpwm\_comparator\_new\_etm\_event** (*mcpwm\_cmpr\_handle\_t* cmpr, const *mcpwm\_cmpr\_etm\_event\_config\_t* \*config, *esp\_etm\_event\_handle\_t* \*out\_event)

Get the ETM event for MCPWM comparator.

---

**备注:** The created ETM event object can be deleted later by calling `esp_etm_del_event`

---

**参数**

- **cmpr** -- [in] MCPWM comparator, allocated by `mcpwm_new_comparator()` or `mcpwm_new_event_comparator()`
- **config** -- [in] MCPWM ETM comparator event configuration
- **out\_event** -- [out] Returned ETM event handle

**返回**

- **ESP\_OK**: Get ETM event successfully
- **ESP\_ERR\_INVALID\_ARG**: Get ETM event failed because of invalid argument
- **ESP\_FAIL**: Get ETM event failed because of other error

## Structures

struct **mcpwm\_cmpr\_etm\_event\_config\_t**  
MCPWM event comparator ETM event configuration.

### Public Members

*mcpwm\_comparator\_etm\_event\_type\_t* **event\_type**  
MCPWM comparator ETM event type

## Header File

- `components/esp_driver_mcpwm/include/driver/mcpwm_types.h`
- This header file can be included with:

```
#include "driver/mcpwm_types.h"
```

- This header file is a part of the API provided by the `esp_driver_mcpwm` component. To declare that your component depends on `esp_driver_mcpwm`, add the following to your `CMakeLists.txt`:

```
REQUIRES esp_driver_mcpwm
```

or

```
PRIV_REQUIRES esp_driver_mcpwm
```

## Structures

struct **mcpwm\_timer\_event\_data\_t**  
MCPWM timer event data.

### Public Members

uint32\_t **count\_value**  
MCPWM timer count value

*mcpwm\_timer\_direction\_t* **direction**  
MCPWM timer count direction

struct **mcpwm\_brake\_event\_data\_t**  
MCPWM brake event data.

struct **mcpwm\_fault\_event\_data\_t**  
MCPWM fault event data.

struct **mcpwm\_compare\_event\_data\_t**  
MCPWM compare event data.

### Public Members

uint32\_t **compare\_ticks**

Compare value

*mcpwm\_timer\_direction\_t* **direction**

Count direction

struct **mcpwm\_capture\_event\_data\_t**

MCPWM capture event data.

### Public Members

uint32\_t **cap\_value**

Captured value

*mcpwm\_capture\_edge\_t* **cap\_edge**

Capture edge

### Type Definitions

typedef struct mcpwm\_timer\_t \***mcpwm\_timer\_handle\_t**

Type of MCPWM timer handle.

typedef struct mcpwm\_oper\_t \***mcpwm\_oper\_handle\_t**

Type of MCPWM operator handle.

typedef struct mcpwm\_cmpr\_t \***mcpwm\_cmpr\_handle\_t**

Type of MCPWM comparator handle.

typedef struct mcpwm\_gen\_t \***mcpwm\_gen\_handle\_t**

Type of MCPWM generator handle.

typedef struct mcpwm\_fault\_t \***mcpwm\_fault\_handle\_t**

Type of MCPWM fault handle.

typedef struct mcpwm\_sync\_t \***mcpwm\_sync\_handle\_t**

Type of MCPWM sync handle.

typedef struct mcpwm\_cap\_timer\_t \***mcpwm\_cap\_timer\_handle\_t**

Type of MCPWM capture timer handle.

typedef struct mcpwm\_cap\_channel\_t \***mcpwm\_cap\_channel\_handle\_t**

Type of MCPWM capture channel handle.

typedef bool (\***mcpwm\_timer\_event\_cb\_t**)(*mcpwm\_timer\_handle\_t* timer, const *mcpwm\_timer\_event\_data\_t* \*edata, void \*user\_ctx)

MCPWM timer event callback function.

**Param timer** [in] MCPWM timer handle

**Param edata** [in] MCPWM timer event data, fed by driver

**Param user\_ctx** [in] User data, set in `mcpwm_timer_register_event_callbacks()`



**Return** Whether a high priority task has been waken up by this function

```
typedef bool (*mcpwm_brake_event_cb_t)(mcpwm_oper_handle_t oper, const mcpwm_brake_event_data_t *edata, void *user_ctx)
```

MCPWM operator brake event callback function.

**Param oper [in]** MCPWM operator handle

**Param edata [in]** MCPWM brake event data, fed by driver

**Param user\_ctx [in]** User data, set in `mcpwm_operator_register_event_callbacks()`

**Return** Whether a high priority task has been waken up by this function

```
typedef bool (*mcpwm_fault_event_cb_t)(mcpwm_fault_handle_t fault, const mcpwm_fault_event_data_t *edata, void *user_ctx)
```

MCPWM fault event callback function.

**Param fault** MCPWM fault handle

**Param edata** MCPWM fault event data, fed by driver

**Param user\_ctx** User data, set in `mcpwm_fault_register_event_callbacks()`

**Return** whether a task switch is needed after the callback returns

```
typedef bool (*mcpwm_compare_event_cb_t)(mcpwm_cmpr_handle_t comparator, const mcpwm_compare_event_data_t *edata, void *user_ctx)
```

MCPWM comparator event callback function.

**Param comparator** MCPWM comparator handle

**Param edata** MCPWM comparator event data, fed by driver

**Param user\_ctx** User data, set in `mcpwm_comparator_register_event_callbacks()`

**Return** Whether a high priority task has been waken up by this function

```
typedef bool (*mcpwm_capture_event_cb_t)(mcpwm_cap_channel_handle_t cap_channel, const mcpwm_capture_event_data_t *edata, void *user_ctx)
```

MCPWM capture event callback function.

**Param cap\_channel** MCPWM capture channel handle

**Param edata** MCPWM capture event data, fed by driver

**Param user\_ctx** User data, set in `mcpwm_capture_channel_register_event_callbacks()`

**Return** Whether a high priority task has been waken up by this function

## Header File

- `components/hal/include/hal/mcpwm_types.h`
- This header file can be included with:

```
#include "hal/mcpwm_types.h"
```

## Type Definitions

```
typedef soc_periph_mcpwm_timer_clk_src_t mcpwm_timer_clock_source_t
```

MCPWM timer clock source.

```
typedef soc_periph_mcpwm_capture_clk_src_t mcpwm_capture_clock_source_t
```

MCPWM capture clock source.

```
typedef soc_periph_mcpwm_carrier_clk_src_t mcpwm_carrier_clock_source_t
```

MCPWM carrier clock source.

## Enumerations

enum **mcpwm\_timer\_direction\_t**

MCPWM timer count direction.

*Values:*

enumerator **MCPWM\_TIMER\_DIRECTION\_UP**

Counting direction: Increase

enumerator **MCPWM\_TIMER\_DIRECTION\_DOWN**

Counting direction: Decrease

enum **mcpwm\_timer\_event\_t**

MCPWM timer events.

*Values:*

enumerator **MCPWM\_TIMER\_EVENT\_EMPTY**

MCPWM timer counts to zero (i.e. counter is empty)

enumerator **MCPWM\_TIMER\_EVENT\_FULL**

MCPWM timer counts to peak (i.e. counter is full)

enumerator **MCPWM\_TIMER\_EVENT\_INVALID**

MCPWM timer invalid event

enum **mcpwm\_timer\_count\_mode\_t**

MCPWM timer count modes.

*Values:*

enumerator **MCPWM\_TIMER\_COUNT\_MODE\_PAUSE**

MCPWM timer paused

enumerator **MCPWM\_TIMER\_COUNT\_MODE\_UP**

MCPWM timer counting up

enumerator **MCPWM\_TIMER\_COUNT\_MODE\_DOWN**

MCPWM timer counting down

enumerator **MCPWM\_TIMER\_COUNT\_MODE\_UP\_DOWN**

MCPWM timer counting up and down

enum **mcpwm\_timer\_start\_stop\_cmd\_t**

MCPWM timer commands, specify the way to start or stop the timer.

*Values:*

enumerator **MCPWM\_TIMER\_STOP\_EMPTY**

MCPWM timer stops when next count reaches zero

enumerator **MCPWM\_TIMER\_STOP\_FULL**

MCPWM timer stops when next count reaches peak

enumerator **MCPWM\_TIMER\_START\_NO\_STOP**

MCPWM timer starts counting, and don't stop until received stop command

enumerator **MCPWM\_TIMER\_START\_STOP\_EMPTY**

MCPWM timer starts counting and stops when next count reaches zero

enumerator **MCPWM\_TIMER\_START\_STOP\_FULL**

MCPWM timer starts counting and stops when next count reaches peak

enum **mcpwm\_generator\_action\_t**

MCPWM generator actions.

*Values:*

enumerator **MCPWM\_GEN\_ACTION\_KEEP**

Generator action: Keep the same level

enumerator **MCPWM\_GEN\_ACTION\_LOW**

Generator action: Force to low level

enumerator **MCPWM\_GEN\_ACTION\_HIGH**

Generator action: Force to high level

enumerator **MCPWM\_GEN\_ACTION\_TOGGLE**

Generator action: Toggle level

enum **mcpwm\_operator\_brake\_mode\_t**

MCPWM operator brake mode.

*Values:*

enumerator **MCPWM\_OPER\_BRAKE\_MODE\_CBC**

Brake mode: CBC (cycle by cycle)

enumerator **MCPWM\_OPER\_BRAKE\_MODE\_OST**

Brake mode: OST (one shot)

enumerator **MCPWM\_OPER\_BRAKE\_MODE\_INVALID**

MCPWM operator invalid brake mode

enum **mcpwm\_capture\_edge\_t**

MCPWM capture edge.

*Values:*

enumerator **MCPWM\_CAP\_EDGE\_POS**

Capture on the positive edge

enumerator **MCPWM\_CAP\_EDGE\_NEG**

Capture on the negative edge

enum **mcpwm\_comparator\_etm\_event\_type\_t**

MCPWM comparator specific events that supported by the ETM module.

*Values:*

enumerator **MCPWM\_CMPR\_ETM\_EVENT\_EQUAL**

The count value equals the value of comparator

enumerator **MCPWM\_CMPR\_ETM\_EVENT\_MAX**

Maximum number of comparator events

## 2.6.18 并行 IO

### 简介

并行 IO 外设是一个通用的并行接口，可用于连接外部设备，如 LED 矩阵、LCD 显示器、打印机和摄像头。该外设具有独立的 TX 和 RX 单元。每个单元最多可以具有 8 或 16 个数据信号以及 1 或 2 个时钟信号。<sup>1</sup>

并行 IO 外设的 TX 和 RX 驱动程序有各自独立的设计，可分别通过包含头文件 `driver/parlio_tx.h` 或 `driver/parlio_rx.h` 来使用。

### 应用示例

- 带有 HUB75 接口的简单 REG LED 矩阵：[peripherals/parlio/parlio\\_tx/simple\\_rgb\\_led\\_matrix](#)。
- 逻辑分析仪：[peripherals/parlio/parlio\\_rx/logic\\_analyzer](#)。

### API 参考

#### Header File

- `components/esp_driver_parlio/include/driver/parlio_tx.h`
- This header file can be included with:

```
#include "driver/parlio_tx.h"
```

- This header file is a part of the API provided by the `esp_driver_parlio` component. To declare that your component depends on `esp_driver_parlio`, add the following to your `CMakeLists.txt`:

```
REQUIRES esp_driver_parlio
```

or

```
PRIV_REQUIRES esp_driver_parlio
```

<sup>1</sup> 不同的 ESP 系列芯片可能具有不同数量的并行 IO TX/RX 实例，数据总线的最大宽度也会有所不同。更多信息，请参阅 [ESP32-H2 技术参考手册 > 并行 IO 控制器 \(PARLIO\) 章节 \[PDF\]](#)。驱动程序允许你创建更多的驱动程序对象，但当所有可用的硬件资源都被用完时，将会显示返回错误。在进行资源分配时，请时刻注意返回值 (e.g., `parlio_new_tx_unit()`)。

**Functions**

*esp\_err\_t* **parlio\_new\_tx\_unit** (const *parlio\_tx\_unit\_config\_t* \*config, *parlio\_tx\_unit\_handle\_t* \*ret\_unit)

Create a Parallel IO TX unit.

**参数**

- **config** -- **[in]** Parallel IO TX unit configuration
- **ret\_unit** -- **[out]** Returned Parallel IO TX unit handle

**返回**

- ESP\_OK: Create Parallel IO TX unit successfully
- ESP\_ERR\_INVALID\_ARG: Create Parallel IO TX unit failed because of invalid argument
- ESP\_ERR\_NO\_MEM: Create Parallel IO TX unit failed because of out of memory
- ESP\_ERR\_NOT\_FOUND: Create Parallel IO TX unit failed because all TX units are used up and no more free one
- ESP\_ERR\_NOT\_SUPPORTED: Create Parallel IO TX unit failed because some feature is not supported by hardware, e.g. clock gating
- ESP\_FAIL: Create Parallel IO TX unit failed because of other error

*esp\_err\_t* **parlio\_del\_tx\_unit** (*parlio\_tx\_unit\_handle\_t* unit)

Delete a Parallel IO TX unit.

**参数** **unit** -- **[in]** Parallel IO TX unit that created by `parlio_new_tx_unit`

**返回**

- ESP\_OK: Delete Parallel IO TX unit successfully
- ESP\_ERR\_INVALID\_ARG: Delete Parallel IO TX unit failed because of invalid argument
- ESP\_ERR\_INVALID\_STATE: Delete Parallel IO TX unit failed because it is still in working
- ESP\_FAIL: Delete Parallel IO TX unit failed because of other error

*esp\_err\_t* **parlio\_tx\_unit\_enable** (*parlio\_tx\_unit\_handle\_t* unit)

Enable the Parallel IO TX unit.

---

**备注:** This function will transit the driver state from init to enable

---



---

**备注:** This function will acquire a PM lock that might be installed during channel allocation

---



---

**备注:** If there're transaction pending in the queue, this function will pick up the first one and start the transfer

---

**参数** **unit** -- **[in]** Parallel IO TX unit that created by `parlio_new_tx_unit`

**返回**

- ESP\_OK: Enable Parallel IO TX unit successfully
- ESP\_ERR\_INVALID\_ARG: Enable Parallel IO TX unit failed because of invalid argument
- ESP\_ERR\_INVALID\_STATE: Enable Parallel IO TX unit failed because it is already enabled
- ESP\_FAIL: Enable Parallel IO TX unit failed because of other error

*esp\_err\_t* **parlio\_tx\_unit\_disable** (*parlio\_tx\_unit\_handle\_t* unit)

Disable the Parallel IO TX unit.

---

**备注:** This function will transit the driver state from enable to init

---

---

**备注:** This function will release the PM lock that might be installed during channel allocation

---



---

**备注:** If one transaction is undergoing, this function will terminate it immediately

---

**参数** **unit** -- **[in]** Parallel IO TX unit that created by `parlio_new_tx_unit`

**返回**

- `ESP_OK`: Disable Parallel IO TX unit successfully
- `ESP_ERR_INVALID_ARG`: Disable Parallel IO TX unit failed because of invalid argument
- `ESP_ERR_INVALID_STATE`: Disable Parallel IO TX unit failed because it's not enabled yet
- `ESP_FAIL`: Disable Parallel IO TX unit failed because of other error

*esp\_err\_t* **parlio\_tx\_unit\_register\_event\_callbacks** (*parlio\_tx\_unit\_handle\_t* tx\_unit, const *parlio\_tx\_event\_callbacks\_t* \*cbs, void \*user\_data)

Set event callbacks for Parallel IO TX unit.

---

**备注:** User can deregister a previously registered callback by calling this function and setting the callback member in the `cbs` structure to NULL.

---



---

**备注:** When `CONFIG_PARLIO_ISR_IRAM_SAFE` is enabled, the callback itself and functions called by it should be placed in IRAM. The variables used in the function should be in the SRAM as well. The `user_data` should also reside in SRAM.

---

**参数**

- **tx\_unit** -- **[in]** Parallel IO TX unit that created by `parlio_new_tx_unit`
- **cbs** -- **[in]** Group of callback functions
- **user\_data** -- **[in]** User data, which will be passed to callback functions directly

**返回**

- `ESP_OK`: Set event callbacks successfully
- `ESP_ERR_INVALID_ARG`: Set event callbacks failed because of invalid argument
- `ESP_FAIL`: Set event callbacks failed because of other error

*esp\_err\_t* **parlio\_tx\_unit\_transmit** (*parlio\_tx\_unit\_handle\_t* tx\_unit, const void \*payload, size\_t payload\_bits, const *parlio\_transmit\_config\_t* \*config)

Transmit data on by Parallel IO TX unit.

---

**备注:** After the function returns, it doesn't mean the transaction is finished. This function only constructs a transaction structure and push into a queue.

---

**参数**

- **tx\_unit** -- **[in]** Parallel IO TX unit that created by `parlio_new_tx_unit`
- **payload** -- **[in]** Pointer to the data to be transmitted
- **payload\_bits** -- **[in]** Length of the data to be transmitted, in bits
- **config** -- **[in]** Transmit configuration

**返回**

- `ESP_OK`: Transmit data successfully
- `ESP_ERR_INVALID_ARG`: Transmit data failed because of invalid argument

- `ESP_ERR_INVALID_STATE`: Transmit data failed because the Parallel IO TX unit is not enabled
- `ESP_FAIL`: Transmit data failed because of other error

`esp_err_t parlio_tx_unit_wait_all_done` (`parlio_tx_unit_handle_t` tx\_unit, int timeout\_ms)

Wait for all pending TX transactions done.

#### 参数

- `tx_unit` -- [in] Parallel IO TX unit that created by `parlio_new_tx_unit`
- `timeout_ms` -- [in] Timeout in milliseconds, -1 means to wait forever

#### 返回

- `ESP_OK`: All pending TX transactions is finished and recycled
- `ESP_ERR_INVALID_ARG`: Wait for all pending TX transactions done failed because of invalid argument
- `ESP_ERR_TIMEOUT`: Wait for all pending TX transactions done timeout
- `ESP_FAIL`: Wait for all pending TX transactions done failed because of other error

## Structures

struct `parlio_tx_unit_config_t`

Parallel IO TX unit configuration.

## Public Members

`parlio_clock_source_t clk_src`

Parallel IO internal clock source

`gpio_num_t clk_in_gpio_num`

If the clock source is input from external, set the corresponding GPIO number. Otherwise, set to -1 and the driver will use the internal `clk_src` as clock source. This option has higher priority than `clk_src`

`uint32_t input_clk_src_freq_hz`

Frequency of the input clock source, valid only if `clk_in_gpio_num` is not -1

`uint32_t output_clk_freq_hz`

Frequency of the output clock. It's divided from either internal `clk_src` or external clock source

`size_t data_width`

Parallel IO data width, can set to 1/2/4/8/..., but can't bigger than `PARLIO_TX_UNIT_MAX_DATA_WIDTH`

`gpio_num_t data_gpio_nums[PARLIO_TX_UNIT_MAX_DATA_WIDTH]`

Parallel IO data GPIO numbers, if any GPIO is not used, you can set it to -1

`gpio_num_t clk_out_gpio_num`

GPIO number of the output clock signal, the clock is synced with TX data

`gpio_num_t valid_gpio_num`

GPIO number of the valid signal, which stays high when transferring data. Note that, the valid signal will always occupy the MSB data bit

size\_t **trans\_queue\_depth**

Depth of internal transaction queue

size\_t **max\_transfer\_size**

Maximum transfer size in one transaction, in bytes. This decides the number of DMA nodes will be used for each transaction

*parlio\_sample\_edge\_t* **sample\_edge**

Parallel IO sample edge

*parlio\_bit\_pack\_order\_t* **bit\_pack\_order**

Set the order of packing the bits into bytes (only works when `data_width < 8`)

uint32\_t **clk\_gate\_en**

Enable TX clock gating, the output clock will be controlled by the MSB bit of the data bus, i.e. by `data_gpio_nums[PARLIO_TX_UNIT_MAX_DATA_WIDTH-1]`. High level to enable the clock output, low to disable

uint32\_t **io\_loop\_back**

For debug/test, the signal output from the GPIO will be fed to the input path as well

struct *parlio\_tx\_unit\_config\_t*::[anonymous] **flags**

Extra configuration flags

struct **parlio\_tx\_done\_event\_data\_t**

Type of Parallel IO TX done event data.

struct **parlio\_tx\_event\_callbacks\_t**

Group of Parallel IO TX callbacks.

---

**备注:** The callbacks are all running under ISR environment

---

---

**备注:** When `CONFIG_PARLIO_ISR_IRAM_SAFE` is enabled, the callback itself and functions called by it should be placed in IRAM. The variables used in the function should be in the SRAM as well.

---

## Public Members

*parlio\_tx\_done\_callback\_t* **on\_trans\_done**

Event callback, invoked when one transmission is finished

struct **parlio\_transmit\_config\_t**

Parallel IO transmit configuration.

## Public Members



uint32\_t **idle\_value**

The value on the data line when the parallel IO is in idle state

uint32\_t **queue\_nonblocking**

If set, when the transaction queue is full, driver will not block the thread but return directly

struct *parlio\_transmit\_config\_t*::[anonymous] **flags**

Transmit specific config flags

## Type Definitions

typedef bool (\***parlio\_tx\_done\_callback\_t**)(*parlio\_tx\_unit\_handle\_t* tx\_unit, const *parlio\_tx\_done\_event\_data\_t* \*edata, void \*user\_ctx)

Prototype of parlio tx event callback.

**Param tx\_unit [in]** Parallel IO TX unit that created by *parlio\_new\_tx\_unit*

**Param edata [in]** Point to Parallel IO TX event data. The lifecycle of this pointer memory is inside this function, user should copy it into static memory if used outside this function.

**Param user\_ctx [in]** User registered context, passed from *parlio\_tx\_unit\_register\_event\_callbacks*

**Return** Whether a high priority task has been waken up by this callback function

## Header File

- [components/esp\\_driver\\_parlio/include/driver/parlio\\_rx.h](#)
- This header file can be included with:

```
#include "driver/parlio_rx.h"
```

- This header file is a part of the API provided by the *esp\_driver\_parlio* component. To declare that your component depends on *esp\_driver\_parlio*, add the following to your CMakeLists.txt:

```
REQUIRES esp_driver_parlio
```

or

```
PRIV_REQUIRES esp_driver_parlio
```

## Functions

*esp\_err\_t* **parlio\_new\_rx\_unit** (const *parlio\_rx\_unit\_config\_t* \*config, *parlio\_rx\_unit\_handle\_t* \*ret\_unit)

Create a Parallel IO RX unit.

**参数**

- **config** -- [in] Parallel IO RX unit configuration
- **ret\_unit** -- [out] Returned Parallel IO RX unit handle

**返回**

- ESP\_ERR\_INVALID\_ARG Invalid arguments in the parameter list or the rx unit configuration
- ESP\_ERR\_NOT\_FOUND No available rx unit found
- ESP\_ERR\_NO\_MEM No enough memory for the rx unit resources
- ESP\_OK Success to allocate the rx unit

*esp\_err\_t* **parlio\_del\_rx\_unit** (*parlio\_rx\_unit\_handle\_t* rx\_unit)

Delete a Parallel IO RX unit.

**参数 rx\_unit** -- [in] Parallel IO RX unit handle that created by *parlio\_new\_rx\_unit*

**返回**

- ESP\_ERR\_INVALID\_ARG rx\_unit is NULL

- `ESP_ERR_INVALID_STATE` The rx unit is enabled, can't delete an enabled rx unit
- `ESP_OK` Success to delete the rx unit

`esp_err_t parlio_new_rx_level_delimiter` (const `parlio_rx_level_delimiter_config_t` \*config, `parlio_rx_delimiter_handle_t` \*ret\_delimiter)

Create a level delimiter.

---

**备注:** This function only allocate the software resources, the hardware configurations will lazy installed while the transaction that using this delimiter start processing

---



---

**备注:** The enable signal must be aligned with the valid data.

---



---

**备注:** There're at most `SOC_PARLIO_RX_UNIT_MAX_DATA_WIDTH - 1` IO pins left for RXD

---

#### 参数

- **config** -- [in] Level delimiter configuration
- **ret\_delimiter** -- [out] Returned delimiter handle

#### 返回

- `ESP_ERR_INVALID_ARG` Invalid arguments in the parameter list or the level delimiter configuration
- `ESP_ERR_NO_MEM` No enough memory for the level delimiter resources
- `ESP_OK` Success to allocate the level delimiter

`esp_err_t parlio_new_rx_pulse_delimiter` (const `parlio_rx_pulse_delimiter_config_t` \*config, `parlio_rx_delimiter_handle_t` \*ret\_delimiter)

Create a pulse delimiter.

---

**备注:** This function only allocate the software resources, the hardware configurations will lazy installed while the transaction that using this delimiter start processing

---



---

**备注:** There're at most `SOC_PARLIO_RX_UNIT_MAX_DATA_WIDTH - 1` IO pins left for RXD

---

#### 参数

- **config** -- [in] Pulse delimiter configuration
- **ret\_delimiter** -- [out] Returned delimiter handle

#### 返回

- `ESP_ERR_INVALID_ARG` Invalid arguments in the parameter list or the pulse delimiter configuration
- `ESP_ERR_NO_MEM` No enough memory for the pulse delimiter resources
- `ESP_OK` Success to allocate the pulse delimiter

`esp_err_t parlio_new_rx_soft_delimiter` (const `parlio_rx_soft_delimiter_config_t` \*config, `parlio_rx_delimiter_handle_t` \*ret\_delimiter)

Create a pulse delimiter.

---

**备注:** This function only allocate the software resources, the hardware configurations will lazy installed while the transaction that using this delimiter start processing

---

#### 参数

- **config** -- **[in]** Soft delimiter configuration
- **ret\_delimiter** -- **[out]** Returned delimiter handle

**返回**

- ESP\_ERR\_INVALID\_ARG Invalid arguments in the parameter list or the soft delimiter configuration
- ESP\_ERR\_NO\_MEM No enough memory for the soft delimiter resources
- ESP\_OK Success to allocate the soft delimiter

*esp\_err\_t* **parlio\_rx\_soft\_delimiter\_start\_stop** (*parlio\_rx\_unit\_handle\_t* rx\_unit, *parlio\_rx\_delimiter\_handle\_t* delimiter, bool start\_stop)

Start/stop the soft delimiter.

---

**备注:** Soft delimiter need to start or stop manually because it has no validating/enabling signal to indicate the data has started or stopped

---

**参数**

- **rx\_unit** -- **[in]** Parallel IO RX unit handle that created by `parlio_new_rx_unit`
- **delimiter** -- **[in]** Delimiter handle
- **start\_stop** -- **[in]** Set true to start, set false to stop

**返回**

- ESP\_ERR\_INVALID\_ARG Invalid arguments in the parameter list or not soft delimiter
- ESP\_ERR\_INVALID\_STATE The rx unit not enabled
- ESP\_OK Success to start or stop the soft delimiter

*esp\_err\_t* **parlio\_del\_rx\_delimiter** (*parlio\_rx\_delimiter\_handle\_t* delimiter)

Delete the delimiter.

---

**备注:** To delete the delimiter safely, please delete it after disable all the RX units

---

**参数** **delimiter** -- **[in]** Delimiter handle

**返回**

- ESP\_ERR\_INVALID\_ARG The input delimiter is NULL
- ESP\_ERR\_INVALID\_STATE The delimiter is on receiving
- ESP\_OK Success to delete the delimiter

*esp\_err\_t* **parlio\_rx\_unit\_enable** (*parlio\_rx\_unit\_handle\_t* rx\_unit, bool reset\_queue)

Enable the Parallel IO RX unit.

**参数**

- **rx\_unit** -- **[in]** Parallel IO RX unit handle that created by `parlio_new_rx_unit`
- **reset\_queue** -- **[in]** Whether to reset the receiving queue. If set to false, the legacy receive transactions in the queue are still available, If set to true, the legacy receive transactions in the queue are dropped.

**返回**

- ESP\_ERR\_INVALID\_ARG The input rx\_unit is NULL
- ESP\_ERR\_INVALID\_STATE The rx unit has been enabled
- ESP\_OK Success to enable the rx unit

*esp\_err\_t* **parlio\_rx\_unit\_disable** (*parlio\_rx\_unit\_handle\_t* rx\_unit)

Disable the Parallel IO RX unit.

**参数** **rx\_unit** -- **[in]** Parallel IO RX unit handle that created by `parlio_new_rx_unit`

**返回**

- ESP\_ERR\_INVALID\_ARG The input rx\_unit is NULL
- ESP\_ERR\_INVALID\_STATE The rx unit has been disabled

- ESP\_OK Success to disable the rx unit

*esp\_err\_t* **parlio\_rx\_unit\_receive** (*parlio\_rx\_unit\_handle\_t* rx\_unit, void \*payload, size\_t payload\_size, const *parlio\_receive\_config\_t* \*recv\_cfg)

Receive data by Parallel IO RX unit.

---

**备注:** This is a non-blocking and asynchronous function. To block or realize synchronous receive, please call `parlio_rx_unit_wait_all_done` after this function

---



---

**备注:** The receive transaction will start immediately when there is not other transaction on receiving. Otherwise it will be sent to the transaction queue to wait for the bus.

---

#### 参数

- **rx\_unit** -- **[in]** Parallel IO RX unit handle that created by `parlio_new_rx_unit`
- **payload** -- **[in]** The payload buffer pointer
- **payload\_size** -- **[in]** The size of the payload buffer, in bytes.
- **recv\_cfg** -- **[in]** The configuration of this receive transaction

#### 返回

- ESP\_ERR\_INVALID\_ARG Invalid arguments in the parameter list or the receive configuration
- ESP\_ERR\_NO\_MEM No memory for the internal DMA buffer (only when `parlio_receive_config_t::indirect_mount` enabled)
- ESP\_ERR\_INVALID\_STATE Transaction queue is full, failed to queue the current transaction. Or the internal buffer is under using by an infinite transaction, can't allocate a new one
- ESP\_OK Success to queue the current receiving transaction

*esp\_err\_t* **parlio\_rx\_unit\_wait\_all\_done** (*parlio\_rx\_unit\_handle\_t* rx\_unit, int timeout\_ms)

Wait for all pending RX transactions done.

---

**备注:** This function will block until all receiving transactions done or timeout. When timeout occurs, either the timeout limitation too short for all transactions done, or the peripheral got stuck and no more interrupts trigger (e.g., external clock stopped).

---

#### 参数

- **rx\_unit** -- **[in]** Parallel IO RX unit handle that created by `parlio_new_rx_unit`
- **timeout\_ms** -- **[in]** Timeout in milliseconds, -1 means to wait forever (software timeout)

#### 返回

- ESP\_ERR\_INVALID\_ARG The input rx\_unit is NULL
- ESP\_ERR\_TIMEOUT Wait for all transactions done timeout
- ESP\_OK All transaction done

*esp\_err\_t* **parlio\_rx\_unit\_register\_event\_callbacks** (*parlio\_rx\_unit\_handle\_t* rx\_unit, const *parlio\_rx\_event\_callbacks\_t* \*cbs, void \*user\_data)

Register event callbacks for Parallel IO RX unit.

#### 参数

- **rx\_unit** -- **[in]** Parallel IO RX unit handle that created by `parlio_new_rx_unit`
- **cbs** -- **[in]** Callback group, set callback to NULL to deregister the corresponding callback (callback group pointer shouldn't be NULL)
- **user\_data** -- **[in]** User specified data that will be transported to the callbacks

#### 返回

- `ESP_ERR_INVALID_ARG` The input `rx_unit` is `NULL`
- `ESP_ERR_INVALID_STATE` The rx unit has been enabled, callback should be registered before enabling the unit
- `ESP_OK` Success to register the callbacks

## Structures

struct **parlio\_rx\_unit\_config\_t**

Parallel IO RX unit configuration.

### Public Members

size\_t **trans\_queue\_depth**

Depth of internal transaction queue

size\_t **max\_recv\_size**

Maximum receive size in one transaction, in bytes. This decides the number of DMA nodes will be used for each transaction

size\_t **data\_width**

Parallel IO data width, can set to 1/2/4/8/..., but can't be greater than `PARLIO_RX_UNIT_MAX_DATA_WIDTH`

*parlio\_clock\_source\_t* **clk\_src**

Parallel IO clock source

uint32\_t **ext\_clk\_freq\_hz**

The external source clock frequency. Only be valid when select `PARLIO_CLK_SRC_EXTERNAL` as clock source

uint32\_t **exp\_clk\_freq\_hz**

The expected sample/bit clock frequency, which is divided from the internal or external clock regarding the clock source

gpio\_num\_t **clk\_in\_gpio\_num**

The the external clock input pin. Only be valid when select `PARLIO_CLK_SRC_EXTERNAL` as clock source. Set to -1 if not needed

gpio\_num\_t **clk\_out\_gpio\_num**

The sample/bit clock output pin. Set to -1 if not needed

gpio\_num\_t **valid\_gpio\_num**

GPIO number of the valid signal. The signal on this pin is used to indicate whether the data on the data lines are valid. Only takes effect when using level or pulse delimiter, set to -1 if only use the soft delimiter

gpio\_num\_t **data\_gpio\_nums**[`PARLIO_RX_UNIT_MAX_DATA_WIDTH`]

Parallel IO data GPIO numbers, set to -1 if it's not used, The driver will take [0 .. (`data_width` - 1)] as the data pins

**uint32\_t free\_clk**

Whether the input external clock is a free-running clock. A free-running clock will always keep running (e.g. I2S bclk), a non-free-running clock will start when there are data transporting and stop when the bus idle (e.g. SPI). This flag only takes effect when select `PARLIO_CLK_SRC_EXTERNAL` as clock source

**uint32\_t clk\_gate\_en**

Enable RX clock gating, only available when the clock direction is output(not supported on ESP32-C6) the output clock will be controlled by the valid gpio, i.e. high level of valid gpio to enable the clock output, low to disable

**uint32\_t io\_loop\_back**

For debug/test, the signal output from the GPIO will be fed to the input path as well

**uint32\_t io\_no\_init**

Set to skip initializing the GPIO, but only attach the pralio rx signals to those GPIOs via IO Matrix. So that the signals that have attached to those GPIO won't be overwritten. Mainly used for self communication or self monitoring

**struct *parlio\_rx\_unit\_config\_t*::[anonymous] flags**

RX driver flags

**struct *parlio\_rx\_level\_delimiter\_config\_t***

Configuration of level delimiter.

**Public Members****uint32\_t valid\_sig\_line\_id**

The data line id of valid/enable signal. The selected data line will be used as the valid/enable signal (i.e. level signal) in this delimiter. As the line of valid/enable signal is shared with the data line, this `line_id` will be conflict with the data line if set the id within 'data\_width', therefore the range is (`data_width`, `PARLIO_RX_UNIT_MAX_DATA_WIDTH`].

***parlio\_sample\_edge\_t* sample\_edge**

Parallel IO sample edge

***parlio\_bit\_pack\_order\_t* bit\_pack\_order**

Set how we pack the bits into one bytes

**uint32\_t eof\_data\_len**

Set the data length to trigger the End Of Frame (EOF, i.e. transaction done) interrupt, if the data length is set to 0, that mean the EOF will only triggers when the enable signal inactivated

**uint32\_t timeout\_ticks**

The number of source clock ticks to trigger timeout interrupt. Set 0 to disable the receive timeout interrupt The timeout counter starts when the valid/enable signal is invalid/disabled.

**uint32\_t active\_low\_en**

Set true to set the valid signal active when the level is low, otherwise, the valid signal becomes active when its level is high

struct *parlio\_rx\_level\_delimiter\_config\_t*::[anonymous] **flags**

Extra flags

struct **parlio\_rx\_pulse\_delimiter\_config\_t**

Configuration of pulse delimiter.

### Public Members

uint32\_t **valid\_sig\_line\_id**

The data line id of valid/enable signal. The selected data line will be used as the valid/enable signal (i.e. pulse signal) in this delimiter. As the line of valid/enable signal is shared with the data line, this line\_id will be conflict with the data line if set the id within 'data\_width', therefore the range is (data\_width, PARLIO\_RX\_UNIT\_MAX\_DATA\_WIDTH].

*parlio\_sample\_edge\_t* **sample\_edge**

Parallel IO sample edge

*parlio\_bit\_pack\_order\_t* **bit\_pack\_order**

Set how we pack the bits into one bytes

uint32\_t **eof\_data\_len**

Set the data length to trigger the End Of Frame (EOF, i.e. transaction done) interrupt, if the data length is set to 0, that mean the EOF will only triggers when the end pulse detected, please ensure there is an end pulse for a frame and `has_end_pulse` flag is set

uint32\_t **timeout\_ticks**

The number of source clock ticks to trigger timeout interrupt. Set 0 to disable the receive timeout interrupt  
The timeout counter starts when the valid/enable signal is invalid/disabled.

uint32\_t **start\_bit\_included**

Whether data bit is included in the start pulse

uint32\_t **end\_bit\_included**

Whether data bit is included in the end pulse, only valid when `has_end_pulse` is true

uint32\_t **has\_end\_pulse**

Whether there's an end pulse to terminate the transaction, if no, the transaction will be terminated by user configured transaction length

uint32\_t **pulse\_invert**

Whether to invert the pulse

struct *parlio\_rx\_pulse\_delimiter\_config\_t*::[anonymous] **flags**

Extra flags

struct **parlio\_rx\_soft\_delimiter\_config\_t**

Configuration of soft delimiter.

## Public Members

*parlio\_sample\_edge\_t* **sample\_edge**

Parallel IO sample edge

*parlio\_bit\_pack\_order\_t* **bit\_pack\_order**

Set how we pack the bits into one bytes, set 1 to pack the bits into a byte from LSB, otherwise from MSB

uint32\_t **eof\_data\_len**

Set the data length to trigger the End Of Frame (EOF, i.e. transaction done) interrupt, if the data length is set to 0, that mean the EOF will only triggers when the end pulse detected, please ensure there is an end pulse for a frame and *parlio\_rx\_pulse\_delimiter\_config\_t::has\_end\_pulse* flag is set

uint32\_t **timeout\_ticks**

The number of APB clock ticks to trigger timeout interrupt. Set 0 to disable the receive timeout interrupt

struct **parlio\_receive\_config\_t**

Configuration of a receive transaction.

## Public Members

*parlio\_rx\_delimiter\_handle\_t* **delimiter**

The delimiter of this receiving transaction

uint32\_t **partial\_rx\_en**

Whether this is an infinite transaction that supposed to receive continuously and partially

uint32\_t **indirect\_mount**

This flag only take effect when *partial\_rx\_en* is enabled. Enable this flag, an INTERNAL DMA buffer will be mounted to the DMA descriptor instead, The data will be copy to the payload in every interrupt. So that to guarantee the payload buffer is valid during the *on\_receive\_done* callback. Either *partial\_rx\_en* or *indirect\_mount* is disabled, the user given finite payload will be mounted to the DMA descriptor directly. By default, the user given receive payload will be mounted to the DMA descriptor directly.

struct *parlio\_receive\_config\_t::*[anonymous] **flags**

Extra flags

struct **parlio\_rx\_event\_data\_t**

Event callback data.

## Public Members

*parlio\_rx\_delimiter\_handle\_t* **delimiter**

The current delimiter of this receiving event

void \***data**

The data buffer address that just finished receiving



size\_t **recv\_bytes**

The number of received bytes in the data buffer

struct **parlio\_rx\_event\_callbacks\_t**

Parallel IO RX event callbacks.

### Public Members

*parlio\_rx\_callback\_t* **on\_partial\_receive**

Callback of received partial data

*parlio\_rx\_callback\_t* **on\_receive\_done**

Callback of receiving transaction done

*parlio\_rx\_callback\_t* **on\_timeout**

Callback of hardware receiving timeout

### Type Definitions

```
typedef bool (*parlio_rx_callback_t)(parlio_rx_unit_handle_t rx_unit, const parlio_rx_event_data_t
*edata, void *user_data)
```

The template of the Parallel IO RX callback function.

**Param rx\_unit [in]** Parallel IO RX unit handle that given from ISR

**Param edata [in]** The event data that given from ISR

**Param user\_data [in]** The user specified data that given while registering the callbacks

**Return**

- True: to awake high priority tasks
- False: not to awake high priority tasks

### Header File

- [components/esp\\_driver\\_parlio/include/driver/parlio\\_types.h](#)
- This header file can be included with:

```
#include "driver/parlio_types.h"
```

- This header file is a part of the API provided by the `esp_driver_parlio` component. To declare that your component depends on `esp_driver_parlio`, add the following to your CMakeLists.txt:

```
REQUIRES esp_driver_parlio
```

or

```
PRIV_REQUIRES esp_driver_parlio
```

### Type Definitions

```
typedef struct parlio_tx_unit_t *parlio_tx_unit_handle_t
```

Type of Parallel IO TX unit handle.

```
typedef struct parlio_rx_unit_t *parlio_rx_unit_handle_t
```

Type of Parallel IO RX unit handle.

typedef struct parlio\_rx\_delimiter\_t \***parlio\_rx\_delimiter\_handle\_t**

Type of Parallel IO RX frame delimiter handle.

### Header File

- [components/hal/include/hal/parlio\\_types.h](#)
- This header file can be included with:

```
#include "hal/parlio_types.h"
```

### Macros

**PARLIO\_TX\_UNIT\_MAX\_DATA\_WIDTH**

Maximum data width of TX unit.

**PARLIO\_RX\_UNIT\_MAX\_DATA\_WIDTH**

Maximum data width of RX unit.

### Type Definitions

typedef *soc\_periph\_parlio\_clk\_src\_t* **parlio\_clock\_source\_t**

Parallel IO clock source.

---

备注: User should select the clock source based on the power and resolution requirement

---

### Enumerations

enum **parlio\_sample\_edge\_t**

Parallel IO sample edge.

*Values:*

enumerator **PARLIO\_SAMPLE\_EDGE\_NEG**

Sample data on falling edge of clock

enumerator **PARLIO\_SAMPLE\_EDGE\_POS**

Sample data on rising edge of clock

enum **parlio\_bit\_pack\_order\_t**

Parallel IO bit packing order.

Data in memory: Byte 0: MSB < B0.7 B0.6 B0.5 B0.4 B0.3 B0.2 B0.1 B0.0 > LSB Byte 1: MSB < B1.7 B1.6 B1.5 B1.4 B1.3 B1.2 B1.1 B1.0 > LSB

Output on line (PARLIO\_BIT\_PACK\_ORDER\_LSB): Cycle 0 Cycle 1 Cycle 2 → time GPIO 0: B0.0 B0.4 B1.0 GPIO 1: B0.1 B0.5 B1.1 GPIO 2: B0.2 B0.6 B1.2 GPIO 3: B0.3 B0.7 B1.3

Output on line (PARLIO\_BIT\_PACK\_ORDER\_MSB): Cycle 0 Cycle 1 Cycle 2 → time GPIO 0: B0.4 B0.0 B1.4 GPIO 1: B0.5 B0.1 B1.5 GPIO 2: B0.6 B0.2 B1.6 GPIO 3: B0.7 B0.3 B1.7

*Values:*

enumerator **PARLIO\_BIT\_PACK\_ORDER\_LSB**

Bit pack order: LSB

enumerator `PARLIO_BIT_PACK_ORDER_MSB`

Bit pack order: MSB

## 2.6.19 脉冲计数器 (PCNT)

### 概述

PCNT 用于统计输入信号的上升沿和/或下降沿的数量。ESP32-H2 集成了多个脉冲计数单元<sup>1</sup>，每个单元都是包含多个通道的独立计数器。通道可独立配置为统计上升沿或下降沿数量的递增计数器或递减计数器。

PCNT 通道可检测 **边沿信号** 及 **电平信号**。对于比较简单的应用，检测边沿信号就足够了。PCNT 通道可检测上升沿信号、下降沿信号，同时也能设置为递增计数，递减计数，或停止计数。电平信号就是所谓的 **控制信号**，可用来控制边沿信号的计数模式。通过设置电平信号与边沿信号的检测模式，PCNT 单元可用作 **正交解码器**。

每个 PCNT 单元还包含一个滤波器，用于滤除线路毛刺。

PCNT 模块通常用于：

- 对一段时间内的脉冲计数，进而计算得到周期信号的频率；
- 对正交信号进行解码，进而获得速度和方向信息。

### 功能描述

PCNT 的功能从以下几个方面进行说明：

- **分配资源** - 说明如何通过配置分配 PCNT 单元和通道，以及在相应操作完成之后，如何回收单元和通道。
- **设置通道操作** - 说明如何设置通道针对不同信号沿和电平进行操作。
- **PCNT 观察点** - 说明如何配置观察点，即当计数达到某个数值时，命令 PCNT 单元触发某个事件。
- **注册事件回调函数** - 说明如何将您的代码挂载到观察点事件的回调函数上。
- **设置毛刺滤波器** - 说明如何使能毛刺滤波器并设置其时序参数。
- **使能和禁用单元** - 说明如何使能和关闭 PCNT 单元。
- **控制单元 IO 操作** - 说明 PCNT 单元的 IO 控制功能，例如使能毛刺滤波器，开启和停用 PCNT 单元，获取和清除计数。
- **电源管理** - 说明哪些功能会阻止芯片进入低功耗模式。
- **支持 IRAM 安全中断** - 说明在缓存禁用的情况下，如何执行 PCNT 中断和 IO 控制功能。
- **支持线程安全** - 列出线程安全的 API。
- **支持的 Kconfig 选项** - 列出了支持的 Kconfig 选项，这些选项可实现不同的驱动效果。

**分配资源** PCNT 单元和通道分别用 `pcnt_unit_handle_t` 与 `pcnt_channel_handle_t` 表示。所有的可用单元和通道都由驱动在资源池中进行维护，无需了解底层实例 ID。

**安装 PCNT 单元** 安装 PCNT 单元时，需要先完成配置 `pcnt_unit_config_t`：

- `pcnt_unit_config_t::low_limit` 与 `pcnt_unit_config_t::high_limit` 用于指定内部计数器的最小值和最大值。当计数器超过任一限值时，计数器将归零。
- `pcnt_unit_config_t::accum_count` 用于设置是否需要软件在硬件计数值溢出的时候进行累加保存，这有助于“拓宽”计数器的实际位宽。默认情况下，计数器的位宽最高只有 16 比特。请参考 [计数溢出补偿](#) 了解如何利用此功能来补偿硬件计数器的溢出损失。
- `pcnt_unit_config_t::intr_priority` 设置中断的优先级。如果设置为 0，则会分配一个默认优先级的中断，否则会使用指定的优先级。

<sup>1</sup> 在不同的 ESP 芯片系列中，PCNT 单元和通道的数量可能会有差异，具体信息请参考 [TRM]。驱动程序对通道申请数量不做限制，但当硬件资源用尽时，驱动程序将返回错误。因此分配资源时，应注意检查返回值，如 `pcnt_new_unit()`。

**备注：** 由于所有 PCNT 单元共享一个中断源，安装多个 PCNT 单元时请确保每个单元的中断优先级 `pcnt_unit_config_t::intr_priority` 一致。

调用函数 `pcnt_new_unit()` 并将 `pcnt_unit_config_t` 作为其输入值，可对 PCNT 单元进行分配和初始化。该函数正常运行时，会返回一个 PCNT 单元句柄。没有可用的 PCNT 单元时（即 PCNT 单元全部被占用），该函数会返回错误 `ESP_ERR_NOT_FOUND`。可用的 PCNT 单元总数记录在 `SOC_PCNT_UNITS_PER_GROUP` 中，以供参考。

如果不再需要之前创建的某个 PCNT 单元，建议通过调用 `pcnt_del_unit()` 来回收该单元，从而该单元可用于其他用途。删除某个 PCNT 单元之前，需要满足以下条件：

- 该单元处于初始状态，即该单元要么已经被 `pcnt_unit_disable()` 禁用，要么尚未使能。
- 附属于该单元的通道已全部被 `pcnt_del_channel()` 删除。

```
#define EXAMPLE_PCNT_HIGH_LIMIT 100
#define EXAMPLE_PCNT_LOW_LIMIT -100

pcnt_unit_config_t unit_config = {
    .high_limit = EXAMPLE_PCNT_HIGH_LIMIT,
    .low_limit = EXAMPLE_PCNT_LOW_LIMIT,
};
pcnt_unit_handle_t pcnt_unit = NULL;
ESP_ERROR_CHECK(pcnt_new_unit(&unit_config, &pcnt_unit));
```

**安装 PCNT 通道** 安装 PCNT 通道时，需要先初始化 `pcnt_chan_config_t`，然后调用 `pcnt_new_channel()`。对 `pcnt_chan_config_t` 配置如下所示：

- `pcnt_chan_config_t::edge_gpio_num` 与 `pcnt_chan_config_t::level_gpio_num` 用于指定 **边沿信号**和 **电平信号**对应的 GPIO 编号。请注意，这两个参数未被使用时，可以设置为 `-1`，即成为 **虚拟 IO**。对于一些简单的脉冲计数应用，电平信号或边沿信号是固定的（即不会发生改变），可将其设置为虚拟 IO，然后该信号会被连接到一个固定的高/低逻辑电平，这样就可以在通道分配时回收一个 GPIO，节省一个 GPIO 管脚资源。
- `pcnt_chan_config_t::virt_edge_io_level` 与 `pcnt_chan_config_t::virt_level_io_level` 用于指定 **边沿信号**和 **电平信号**的虚拟 IO 电平，以保证这些控制信号处于确定状态。请注意，只有在 `pcnt_chan_config_t::edge_gpio_num` 或 `pcnt_chan_config_t::level_gpio_num` 设置为 `-1` 时，这两个参数才有效。
- `pcnt_chan_config_t::invert_edge_input` 与 `pcnt_chan_config_t::invert_level_input` 用于确定信号在输入 PCNT 之前是否需要被翻转，信号翻转由 GPIO 矩阵（不是 PCNT 单元）执行。
- `pcnt_chan_config_t::io_loop_back` 仅用于调试，它可以使能 GPIO 的输入和输出路径。这样，就可以通过调用位于同一 GPIO 上的函数 `gpio_set_level()` 来模拟脉冲信号。

调用函数 `pcnt_new_channel()`，将 `pcnt_chan_config_t` 作为输入值并调用 `pcnt_new_unit()` 返回的 PCNT 单元句柄，可对 PCNT 通道进行分配和初始化。如果该函数正常运行，会返回一个 PCNT 通道句柄。如果没有可用的 PCNT 通道（PCNT 通道资源全部被占用），该函数会返回错误 `ESP_ERR_NOT_FOUND`。可用的 PCNT 通道总数记录在 `SOC_PCNT_CHANNELS_PER_UNIT`，以供参考。注意，为某个单元安装 PCNT 通道时，应确保该单元处于初始状态，否则函数 `pcnt_new_channel()` 会返回错误 `ESP_ERR_INVALID_STATE`。

如果不再需要之前创建的某个 PCNT 通道，建议通过调用 `pcnt_del_channel()` 回收该通道，从而该通道可用于其他用途。

```
#define EXAMPLE_CHAN_GPIO_A 0
#define EXAMPLE_CHAN_GPIO_B 2

pcnt_chan_config_t chan_config = {
    .edge_gpio_num = EXAMPLE_CHAN_GPIO_A,
    .level_gpio_num = EXAMPLE_CHAN_GPIO_B,
};
```

(下页继续)

(续上页)

```
pcnt_channel_handle_t pcnt_chan = NULL;
ESP_ERROR_CHECK(pcnt_new_channel(pcnt_unit, &chan_config, &pcnt_chan));
```

**设置通道操作** 当输入脉冲信号切换时，PCNT 通道会增加，减少或停止计数。边沿信号及电平信号可设置为不同的计数器操作。

- `pcnt_channel_set_edge_action()` 为输入到 `pcnt_chan_config_t::edge_gpio_num` 的信号上升沿和下降沿设置操作，`pcnt_channel_edge_action_t` 中列出了支持的操作。
- `pcnt_channel_set_level_action()` 为输入到 `pcnt_chan_config_t::level_gpio_num` 的信号高电平和低电平设置操作，`pcnt_channel_level_action_t` 中列出了支持的操作。使用 `pcnt_new_channel()` 分配 PCNT 通道时，如果 `pcnt_chan_config_t::level_gpio_num` 被设置为 `-1`，就无需对该函数进行设置了。

```
// decrease the counter on rising edge, increase the counter on falling edge
ESP_ERROR_CHECK(pcnt_channel_set_edge_action(pcnt_chan, PCNT_CHANNEL_EDGE_ACTION_
↳DECREASE, PCNT_CHANNEL_EDGE_ACTION_INCREASE));
// keep the counting mode when the control signal is high level, and reverse the
↳counting mode when the control signal is low level
ESP_ERROR_CHECK(pcnt_channel_set_level_action(pcnt_chan, PCNT_CHANNEL_LEVEL_ACTION_
↳KEEP, PCNT_CHANNEL_LEVEL_ACTION_INVERSE));
```

**PCNT 观察点** PCNT 单元可被设置为观察几个特定的数值，这些被观察的数值被称为 **观察点**。观察点不能超过 `pcnt_unit_config_t` 设置的范围，最小值和最大值分别为 `pcnt_unit_config_t::low_limit` 和 `pcnt_unit_config_t::high_limit`。当计数器到达任一观察点时，会触发一个观察事件，如果在 `pcnt_unit_register_event_callbacks()` 注册过事件回调函数，该事件就会通过中断发送通知。关于如何注册事件回调函数，请参考 [注册事件回调函数](#)。

观察点分别可以通过 `pcnt_unit_add_watch_point()` 和 `pcnt_unit_remove_watch_point()` 进行添加和删除。常用的观察点包括 **过零**、**最大/最小计数** 以及其他的阈值。可用的观察点是有限的，如果 `pcnt_unit_add_watch_point()` 无法获得空闲硬件资源来存储观察点，会返回错误 `ESP_ERR_NOT_FOUND`。不能多次添加同一个观察点，否则将返回错误 `ESP_ERR_INVALID_STATE`。

建议通过 `pcnt_unit_remove_watch_point()` 删除未使用的观察点来回收资源。

```
// add zero across watch point
ESP_ERROR_CHECK(pcnt_unit_add_watch_point(pcnt_unit, 0));
// add high limit watch point
ESP_ERROR_CHECK(pcnt_unit_add_watch_point(pcnt_unit, EXAMPLE_PCNT_HIGH_LIMIT));
```

**注册事件回调函数** 当 PCNT 单元的数值达到任一使能的观察点的数值时，会触发相应的事件并通过中断通知 CPU。如果要在事件触发时执行相关函数，可通过调用 `pcnt_unit_register_event_callbacks()` 将函数挂载到中断服务程序 (ISR) 上。`pcnt_event_callbacks_t` 列出了所有支持的事件回调函数：

- `pcnt_event_callbacks_t::on_reach` 用于为观察点事件设置回调函数。由于该回调函数是在 ISR 的上下文中被调用的，必须确保该函数不会阻塞调用的任务，(例如，可确保只有以 ISR 为后缀的 FreeRTOS API 才能在函数中调用)。`pcnt_watch_cb_t` 中声明了该回调函数的原型。

可通过 `user_ctx` 将函数上下文保存到 `pcnt_unit_register_event_callbacks()` 中，这些数据会直接传递给回调函数。

驱动程序会将特定事件的数据写入回调函数中，例如，观察点事件数据被声明为 `pcnt_watch_event_data_t`：

- `pcnt_watch_event_data_t::watch_point_value` 用于保存触发该事件的观察点数值。
- `pcnt_watch_event_data_t::zero_cross_mode` 用于保存上一次 PCNT 单元的过零模式，`pcnt_unit_zero_cross_mode_t` 中列出了所有可能的过零模式。通常，不同的过零模式意味着不同的 **计数方向** 和 **计数步长**。



注册回调函数会导致中断服务延迟安装，因此回调函数只能在 PCNT 单元被 `pcnt_unit_enable()` 使用之前调用。否则，回调函数会返回错误 `ESP_ERR_INVALID_STATE`。

```
static bool example_pcnt_on_reach(pcnt_unit_handle_t unit, const pcnt_watch_event_
↳data_t *edata, void *user_ctx)
{
    BaseType_t high_task_wakeup;
    QueueHandle_t queue = (QueueHandle_t)user_ctx;
    // send watch point to queue, from this interrupt callback
    xQueueSendFromISR(queue, &(edata->watch_point_value), &high_task_wakeup);
    // return whether a high priority task has been waken up by this function
    return (high_task_wakeup == pdTRUE);
}

pcnt_event_callbacks_t cbs = {
    .on_reach = example_pcnt_on_reach,
};
QueueHandle_t queue = xQueueCreate(10, sizeof(int));
ESP_ERROR_CHECK(pcnt_unit_register_event_callbacks(pcnt_unit, &cbs, queue));
```

**设置毛刺滤波器** PCNT 单元的滤波器可滤除信号中的短时毛刺，`pcnt_glitch_filter_config_t` 中列出了毛刺滤波器的配置参数：

- `pcnt_glitch_filter_config_t::max_glitch_ns` 设置了最大的毛刺宽度，单位为纳秒。如果一个信号脉冲的宽度小于该数值，则该信号会被认定为噪声而不会触发计数器操作。

可通过调用 `pcnt_unit_set_glitch_filter()` 来使能毛刺滤波器，并对上述参数进行配置。之后，还可通过调用 `pcnt_unit_set_glitch_filter()` 来关闭毛刺滤波器，并将上述参数设置为 `NULL`。

调用该函数时，PCNT 单元应处于初始状态。否则，函数将返回错误 `ESP_ERR_INVALID_STATE`。

**备注：**毛刺滤波器的时钟信息来自 APB。为确保 PCNT 单元不会滤除脉冲信号，最大毛刺宽度应大于一个 APB\_CLK 周期（如果 APB 的频率为 80 MHz，则最大毛刺宽度为 12.5 ns）。使能动态频率缩放 (DFS) 后，APB 的频率会发生变化，从而最大毛刺宽度也会发生变化，这会导致计数器无法正常工作。因此，第一次使能毛刺滤波器时，驱动会为 PCNT 单元安装 PM 锁。关于 PCNT 驱动电源管理的更多信息，请参考 [电源管理](#)。

```
pcnt_glitch_filter_config_t filter_config = {
    .max_glitch_ns = 1000,
};
ESP_ERROR_CHECK(pcnt_unit_set_glitch_filter(pcnt_unit, &filter_config));
```

**使能和禁用单元** 在对 PCNT 单元进行 IO 控制之前，需要通过调用函数 `pcnt_unit_enable()` 来使能该 PCNT 单元。该函数将完成以下操作：

- 将 PCNT 单元的驱动状态从 **初始** 切换到 **使能**。
- 如果中断服务已经在 `pcnt_unit_register_event_callbacks()` 延迟安装，使能中断服务。
- 如果电源管理锁已经在 `pcnt_unit_set_glitch_filter()` 延迟安装，获取该电源管理锁。请参考 [电源管理](#) 获取更多信息。

调用函数 `pcnt_unit_disable()` 会进行相反的操作，即将 PCNT 单元的驱动状态切换回 **初始** 状态，禁用中断服务并释放电源管理锁。

## 控制单元 IO 操作

**启用/停用及清零** 通过调用 `pcnt_unit_start()` 可启用 PCNT 单元，根据不同脉冲信号进行递增或递减计数；通过调用 `pcnt_unit_stop()` 可停用 PCNT 单元，当前的计数值会保留；通过调用 `pcnt_unit_clear_count()` 可将计数器清零。

注意 `pcnt_unit_start()` 和 `pcnt_unit_stop()` 应该在 PCNT 单元被 `pcnt_unit_enable()` 使能后调用，否则将返回错误 `ESP_ERR_INVALID_STATE`。

**获取计数器数值** 调用 `pcnt_unit_get_count()` 可随时获取当前计数器的数值。返回的计数值是一个带符号的整型数，其符号反映了计数的方向。

```
int pulse_count = 0;
ESP_ERROR_CHECK(pcnt_unit_get_count(pcnt_unit, &pulse_count));
```

**计数溢出补偿** PCNT 内部的硬件计数器会在计数达到高/低门限的时候自动清零。如果你想补偿该数值的溢出损失，以期进一步拓宽计数器的实际位宽，你可以：

1. 在安装 PCNT 计数单元的时候使能 `pcnt_unit_config_t::accum_count` 选项。
2. 将高/低计数门限设置为 **PCNT 观察点**。
3. 现在，`pcnt_unit_get_count()` 函数返回的计数值就会包含硬件计数器当前的计数值，累加上计数器溢出造成的损失。

**备注：** `pcnt_unit_clear_count()` 会复位该软件累加器。

**电源管理** 使能电源管理（即 `CONFIG_PM_ENABLE` 开启）后，在进入 Light-sleep 模式之前，系统会调整 APB 的频率。这会改变 PCNT 毛刺滤波器的参数，从而可能导致有效信号被滤除。

驱动通过获取 `ESP_PM_APB_FREQ_MAX` 类型的电源管理锁来防止系统修改 APB 频率。每当通过 `pcnt_unit_set_glitch_filter()` 使能毛刺滤波器时，驱动可以保证系统在 `pcnt_unit_enable()` 使能 PCNT 单元后获取电源管理锁。而系统调用 `pcnt_unit_disable()` 之后，驱动会释放电源管理锁。

**支持 IRAM 安全中断** 当缓存由于写入/擦除 flash 等原因被禁用时，PCNT 中断会默认被延迟。这会导致报警中断无法及时执行，从而无法满足实时性应用的要求。

Konfig 选项 `CONFIG_PCNT_ISR_IRAM_SAFE` 可以实现以下功能：

1. 即使缓存被禁用也可以使能中断服务
2. 将 ISR 使用的所有函数都放入 IRAM 中<sup>2</sup>
3. 将驱动对象放入 DRAM（防止驱动对象被意外映射到 PSRAM 中）

这样，在缓存被禁用时，中断也可运行，但是这也会增加 IRAM 的消耗。

另外一个 Konfig 选项 `CONFIG_PCNT_CTRL_FUNC_IN_IRAM` 也可以把常用的 IO 控制函数放在 IRAM 中。这样，当缓存禁用时，这些函数仍然可以执行。这些 IO 控制函数如下所示：

- `pcnt_unit_start()`
- `pcnt_unit_stop()`
- `pcnt_unit_clear_count()`
- `pcnt_unit_get_count()`

**支持线程安全** 驱动保证工厂函数 `pcnt_new_unit()` 与 `pcnt_new_channel()` 是线程安全的，因此可以从 RTOS 任务中调用这些函数，而无需使用额外的电源管理锁。

以下函数可以在 ISR 上下文中运行，驱动可以防止这些函数在任务和 ISR 中同时被调用。

- `pcnt_unit_start()`
- `pcnt_unit_stop()`
- `pcnt_unit_clear_count()`
- `pcnt_unit_get_count()`

<sup>2</sup> `pcnt_event_callbacks_t::on_reach` 回调函数和其调用的函数也应该放在 IRAM 中。

其他以 `pcnt_unit_handle_t` 和 `pcnt_channel_handle_t` 作为第一个参数的函数被视为线程不安全函数，在多任务场景下应避免调用这些函数。

### 支持的 Kconfig 选项

- `CONFIG_PCNT_CTRL_FUNC_IN_IRAM` 用于确定 PCNT 控制函数的位置（放在 IRAM 还是 flash 中），请参考支持 `IRAM` 安全中断 获取更多信息。
- `CONFIG_PCNT_ISR_IRAM_SAFE` 用于控制当缓存禁用时，默认的 ISR 句柄是否可以工作，请参考支持 `IRAM` 安全中断 获取更多信息。
- `CONFIG_PCNT_ENABLE_DEBUG_LOG` 用于使能调试日志输出，而这会增大固件二进制文件。

### 应用实例

- 对旋转编码器的正交信号进行解码的实例请参考：[peripherals/pcnt/rotary\\_encoder](#)。

### API 参考

#### Header File

- `components/esp_driver_pcnt/include/driver/pulse_cnt.h`
- This header file can be included with:

```
#include "driver/pulse_cnt.h"
```

- This header file is a part of the API provided by the `esp_driver_pcnt` component. To declare that your component depends on `esp_driver_pcnt`, add the following to your `CMakeLists.txt`:

```
REQUIRES esp_driver_pcnt
```

or

```
PRIV_REQUIRES esp_driver_pcnt
```

#### Functions

`esp_err_t pcnt_new_unit` (const `pcnt_unit_config_t` \*config, `pcnt_unit_handle_t` \*ret\_unit)

Create a new PCNT unit, and return the handle.

---

**备注:** The newly created PCNT unit is put in the init state.

---

#### 参数

- **config** -- [in] PCNT unit configuration
- **ret\_unit** -- [out] Returned PCNT unit handle

#### 返回

- `ESP_OK`: Create PCNT unit successfully
- `ESP_ERR_INVALID_ARG`: Create PCNT unit failed because of invalid argument (e.g. high/low limit value out of the range)
- `ESP_ERR_NO_MEM`: Create PCNT unit failed because out of memory
- `ESP_ERR_NOT_FOUND`: Create PCNT unit failed because all PCNT units are used up and no more free one
- `ESP_FAIL`: Create PCNT unit failed because of other error

`esp_err_t pcnt_del_unit` (`pcnt_unit_handle_t` unit)

Delete the PCNT unit handle.



---

**备注:** A PCNT unit can't be in the enable state when this function is invoked. See also `pcnt_unit_disable()` for how to disable a unit.

---

**参数** `unit` -- [in] PCNT unit handle created by `pcnt_new_unit()`  
**返回**

- `ESP_OK`: Delete the PCNT unit successfully
- `ESP_ERR_INVALID_ARG`: Delete the PCNT unit failed because of invalid argument
- `ESP_ERR_INVALID_STATE`: Delete the PCNT unit failed because the unit is not in init state or some PCNT channel is still in working
- `ESP_FAIL`: Delete the PCNT unit failed because of other error

*esp\_err\_t* `pcnt_unit_set_glitch_filter` (*pcnt\_unit\_handle\_t* unit, const *pcnt\_glitch\_filter\_config\_t* \*config)

Set glitch filter for PCNT unit.

---

**备注:** The glitch filter module is clocked from APB, and APB frequency can be changed during DFS, which in return make the filter out of action. So this function will lazy-install a PM lock internally when the power management is enabled. With this lock, the APB frequency won't be changed. The PM lock can be uninstalled in `pcnt_del_unit()`.

---



---

**备注:** This function should be called when the PCNT unit is in the init state (i.e. before calling `pcnt_unit_enable()`)

---

**参数**

- `unit` -- [in] PCNT unit handle created by `pcnt_new_unit()`
- `config` -- [in] PCNT filter configuration, set config to NULL means disabling the filter function

**返回**

- `ESP_OK`: Set glitch filter successfully
- `ESP_ERR_INVALID_ARG`: Set glitch filter failed because of invalid argument (e.g. glitch width is too big)
- `ESP_ERR_INVALID_STATE`: Set glitch filter failed because the unit is not in the init state
- `ESP_FAIL`: Set glitch filter failed because of other error

*esp\_err\_t* `pcnt_unit_enable` (*pcnt\_unit\_handle\_t* unit)

Enable the PCNT unit.

---

**备注:** This function will transit the unit state from init to enable.

---



---

**备注:** This function will enable the interrupt service, if it's lazy installed in `pcnt_unit_register_event_callbacks()`.

---



---

**备注:** This function will acquire the PM lock if it's lazy installed in `pcnt_unit_set_glitch_filter()`.

---



---

**备注:** Enable a PCNT unit doesn't mean to start it. See also `pcnt_unit_start()` for how to start the

---

---

PCNT counter.

---

**参数** `unit` -- [in] PCNT unit handle created by `pcnt_new_unit()`

**返回**

- ESP\_OK: Enable PCNT unit successfully
- ESP\_ERR\_INVALID\_ARG: Enable PCNT unit failed because of invalid argument
- ESP\_ERR\_INVALID\_STATE: Enable PCNT unit failed because the unit is already enabled
- ESP\_FAIL: Enable PCNT unit failed because of other error

*esp\_err\_t* `pcnt_unit_disable` (*pcnt\_unit\_handle\_t* unit)

Disable the PCNT unit.

---

**备注:** This function will do the opposite work to the `pcnt_unit_enable()`

---

**备注:** Disable a PCNT unit doesn't mean to stop it. See also `pcnt_unit_stop()` for how to stop the PCNT counter.

---

**参数** `unit` -- [in] PCNT unit handle created by `pcnt_new_unit()`

**返回**

- ESP\_OK: Disable PCNT unit successfully
- ESP\_ERR\_INVALID\_ARG: Disable PCNT unit failed because of invalid argument
- ESP\_ERR\_INVALID\_STATE: Disable PCNT unit failed because the unit is not enabled yet
- ESP\_FAIL: Disable PCNT unit failed because of other error

*esp\_err\_t* `pcnt_unit_start` (*pcnt\_unit\_handle\_t* unit)

Start the PCNT unit, the counter will start to count according to the edge and/or level input signals.

---

**备注:** This function should be called when the unit is in the enable state (i.e. after calling `pcnt_unit_enable()`)

---

**备注:** This function is allowed to run within ISR context

---

**备注:** This function will be placed into IRAM if `CONFIG_PCNT_CTRL_FUNC_IN_IRAM` is on, so that it's allowed to be executed when Cache is disabled

---

**参数** `unit` -- [in] PCNT unit handle created by `pcnt_new_unit()`

**返回**

- ESP\_OK: Start PCNT unit successfully
- ESP\_ERR\_INVALID\_ARG: Start PCNT unit failed because of invalid argument
- ESP\_ERR\_INVALID\_STATE: Start PCNT unit failed because the unit is not enabled yet
- ESP\_FAIL: Start PCNT unit failed because of other error

*esp\_err\_t* `pcnt_unit_stop` (*pcnt\_unit\_handle\_t* unit)

Stop PCNT from counting.

---

---

**备注:** This function should be called when the unit is in the enable state (i.e. after calling `pcnt_unit_enable()`)

---

**备注:** The stop operation won't clear the counter. Also see `pcnt_unit_clear_count()` for how to clear pulse count value.

---

**备注:** This function is allowed to run within ISR context

---

**备注:** This function will be placed into IRAM if `CONFIG_PCNT_CTRL_FUNC_IN_IRAM`, so that it is allowed to be executed when Cache is disabled

---

**参数** `unit` -- [in] PCNT unit handle created by `pcnt_new_unit()`

**返回**

- `ESP_OK`: Stop PCNT unit successfully
- `ESP_ERR_INVALID_ARG`: Stop PCNT unit failed because of invalid argument
- `ESP_ERR_INVALID_STATE`: Stop PCNT unit failed because the unit is not enabled yet
- `ESP_FAIL`: Stop PCNT unit failed because of other error

*esp\_err\_t* `pcnt_unit_clear_count` (*pcnt\_unit\_handle\_t* unit)

Clear PCNT pulse count value to zero.

---

**备注:** It's recommended to call this function after adding a watch point by `pcnt_unit_add_watch_point()`, so that the newly added watch point is effective immediately.

---

**备注:** This function is allowed to run within ISR context

---

**备注:** This function will be placed into IRAM if `CONFIG_PCNT_CTRL_FUNC_IN_IRAM`, so that it's allowed to be executed when Cache is disabled

---

**参数** `unit` -- [in] PCNT unit handle created by `pcnt_new_unit()`

**返回**

- `ESP_OK`: Clear PCNT pulse count successfully
- `ESP_ERR_INVALID_ARG`: Clear PCNT pulse count failed because of invalid argument
- `ESP_FAIL`: Clear PCNT pulse count failed because of other error

*esp\_err\_t* `pcnt_unit_get_count` (*pcnt\_unit\_handle\_t* unit, int \*value)

Get PCNT count value.

---

**备注:** This function is allowed to run within ISR context

---

**备注:** This function will be placed into IRAM if `CONFIG_PCNT_CTRL_FUNC_IN_IRAM`, so that it's allowed to be executed when Cache is disabled

---

**参数**

- **unit** -- [in] PCNT unit handle created by `pcnt_new_unit()`
- **value** -- [out] Returned count value

**返回**

- ESP\_OK: Get PCNT pulse count successfully
- ESP\_ERR\_INVALID\_ARG: Get PCNT pulse count failed because of invalid argument
- ESP\_FAIL: Get PCNT pulse count failed because of other error

*esp\_err\_t* `pcnt_unit_register_event_callbacks` (*pcnt\_unit\_handle\_t* unit, const *pcnt\_event\_callbacks\_t* \*cbs, void \*user\_data)

Set event callbacks for PCNT unit.

---

**备注:** User registered callbacks are expected to be runnable within ISR context

---



---

**备注:** The first call to this function needs to be before the call to `pcnt_unit_enable`

---



---

**备注:** User can deregister a previously registered callback by calling this function and setting the callback member in the `cbs` structure to NULL.

---

**参数**

- **unit** -- [in] PCNT unit handle created by `pcnt_new_unit()`
- **cbs** -- [in] Group of callback functions
- **user\_data** -- [in] User data, which will be passed to callback functions directly

**返回**

- ESP\_OK: Set event callbacks successfully
- ESP\_ERR\_INVALID\_ARG: Set event callbacks failed because of invalid argument
- ESP\_ERR\_INVALID\_STATE: Set event callbacks failed because the unit is not in init state
- ESP\_FAIL: Set event callbacks failed because of other error

*esp\_err\_t* `pcnt_unit_add_watch_point` (*pcnt\_unit\_handle\_t* unit, int watch\_point)

Add a watch point for PCNT unit, PCNT will generate an event when the counter value reaches the watch point value.

**参数**

- **unit** -- [in] PCNT unit handle created by `pcnt_new_unit()`
- **watch\_point** -- [in] Value to be watched

**返回**

- ESP\_OK: Add watch point successfully
- ESP\_ERR\_INVALID\_ARG: Add watch point failed because of invalid argument (e.g. the value to be watched is out of the limitation set in `pcnt_unit_config_t`)
- ESP\_ERR\_INVALID\_STATE: Add watch point failed because the same watch point has already been added
- ESP\_ERR\_NOT\_FOUND: Add watch point failed because no more hardware watch point can be configured
- ESP\_FAIL: Add watch point failed because of other error

*esp\_err\_t* `pcnt_unit_remove_watch_point` (*pcnt\_unit\_handle\_t* unit, int watch\_point)

Remove a watch point for PCNT unit.

**参数**

- **unit** -- [in] PCNT unit handle created by `pcnt_new_unit()`
- **watch\_point** -- [in] Watch point value

**返回**

- ESP\_OK: Remove watch point successfully

- `ESP_ERR_INVALID_ARG`: Remove watch point failed because of invalid argument
- `ESP_ERR_INVALID_STATE`: Remove watch point failed because the watch point was not added by `pcnt_unit_add_watch_point()` yet
- `ESP_FAIL`: Remove watch point failed because of other error

*esp\_err\_t* `pcnt_new_channel` (*pcnt\_unit\_handle\_t* unit, const *pcnt\_chan\_config\_t* \*config, *pcnt\_channel\_handle\_t* \*ret\_chan)

Create PCNT channel for specific unit, each PCNT has several channels associated with it.

---

**备注:** This function should be called when the unit is in init state (i.e. before calling `pcnt_unit_enable()`)

---

#### 参数

- **unit** -- [in] PCNT unit handle created by `pcnt_new_unit()`
- **config** -- [in] PCNT channel configuration
- **ret\_chan** -- [out] Returned channel handle

#### 返回

- `ESP_OK`: Create PCNT channel successfully
- `ESP_ERR_INVALID_ARG`: Create PCNT channel failed because of invalid argument
- `ESP_ERR_NO_MEM`: Create PCNT channel failed because of insufficient memory
- `ESP_ERR_NOT_FOUND`: Create PCNT channel failed because all PCNT channels are used up and no more free one
- `ESP_ERR_INVALID_STATE`: Create PCNT channel failed because the unit is not in the init state
- `ESP_FAIL`: Create PCNT channel failed because of other error

*esp\_err\_t* `pcnt_del_channel` (*pcnt\_channel\_handle\_t* chan)

Delete the PCNT channel.

**参数** **chan** -- [in] PCNT channel handle created by `pcnt_new_channel()`

#### 返回

- `ESP_OK`: Delete the PCNT channel successfully
- `ESP_ERR_INVALID_ARG`: Delete the PCNT channel failed because of invalid argument
- `ESP_FAIL`: Delete the PCNT channel failed because of other error

*esp\_err\_t* `pcnt_channel_set_edge_action` (*pcnt\_channel\_handle\_t* chan, *pcnt\_channel\_edge\_action\_t* pos\_act, *pcnt\_channel\_edge\_action\_t* neg\_act)

Set channel actions when edge signal changes (e.g. falling or rising edge occurred). The edge signal is input from the `edge_gpio_num` configured in `pcnt_chan_config_t`. We use these actions to control when and how to change the counter value.

#### 参数

- **chan** -- [in] PCNT channel handle created by `pcnt_new_channel()`
- **pos\_act** -- [in] Action on posedge signal
- **neg\_act** -- [in] Action on negedge signal

#### 返回

- `ESP_OK`: Set edge action for PCNT channel successfully
- `ESP_ERR_INVALID_ARG`: Set edge action for PCNT channel failed because of invalid argument
- `ESP_FAIL`: Set edge action for PCNT channel failed because of other error

*esp\_err\_t* `pcnt_channel_set_level_action` (*pcnt\_channel\_handle\_t* chan, *pcnt\_channel\_level\_action\_t* high\_act, *pcnt\_channel\_level\_action\_t* low\_act)

Set channel actions when level signal changes (e.g. signal level goes from high to low). The level signal is input from the `level_gpio_num` configured in `pcnt_chan_config_t`. We use these actions to control when and how to change the counting mode.

#### 参数

- **chan** -- [in] PCNT channel handle created by `pcnt_new_channel()`
- **high\_act** -- [in] Action on high level signal
- **low\_act** -- [in] Action on low level signal

#### 返回

- **ESP\_OK**: Set level action for PCNT channel successfully
- **ESP\_ERR\_INVALID\_ARG**: Set level action for PCNT channel failed because of invalid argument
- **ESP\_FAIL**: Set level action for PCNT channel failed because of other error

### Structures

struct **pcnt\_watch\_event\_data\_t**

PCNT watch event data.

#### Public Members

int **watch\_point\_value**

Watch point value that triggered the event

*pcnt\_unit\_zero\_cross\_mode\_t* **zero\_cross\_mode**

Zero cross mode

struct **pcnt\_event\_callbacks\_t**

Group of supported PCNT callbacks.

---

**备注:** The callbacks are all running under ISR environment

---

---

**备注:** When `CONFIG_PCNT_ISR_IRAM_SAFE` is enabled, the callback itself and functions called by it should be placed in IRAM.

---

#### Public Members

*pcnt\_watch\_cb\_t* **on\_reach**

Called when PCNT unit counter reaches any watch point

struct **pcnt\_unit\_config\_t**

PCNT unit configuration.

#### Public Members

int **low\_limit**

Low limitation of the count unit, should be lower than 0

int **high\_limit**

High limitation of the count unit, should be higher than 0

int **intr\_priority**

PCNT interrupt priority, if set to 0, the driver will try to allocate an interrupt with a relative low priority (1,2,3)

uint32\_t **accum\_count**

Whether to accumulate the count value when overflows at the high/low limit

struct *pcnt\_unit\_config\_t*::[anonymous] **flags**

Extra flags

struct **pcnt\_chan\_config\_t**

PCNT channel configuration.

### Public Members

int **edge\_gpio\_num**

GPIO number used by the edge signal, input mode with pull up enabled. Set to -1 if unused

int **level\_gpio\_num**

GPIO number used by the level signal, input mode with pull up enabled. Set to -1 if unused

uint32\_t **invert\_edge\_input**

Invert the input edge signal

uint32\_t **invert\_level\_input**

Invert the input level signal

uint32\_t **virt\_edge\_io\_level**

Virtual edge IO level, 0: low, 1: high. Only valid when edge\_gpio\_num is set to -1

uint32\_t **virt\_level\_io\_level**

Virtual level IO level, 0: low, 1: high. Only valid when level\_gpio\_num is set to -1

uint32\_t **io\_loop\_back**

For debug/test, the signal output from the GPIO will be fed to the input path as well

struct *pcnt\_chan\_config\_t*::[anonymous] **flags**

Channel config flags

struct **pcnt\_glitch\_filter\_config\_t**

PCNT glitch filter configuration.

### Public Members

uint32\_t **max\_glitch\_ns**

Pulse width smaller than this threshold will be treated as glitch and ignored, in the unit of ns

## Type Definitions

typedef struct pcnt\_unit\_t \***pcnt\_unit\_handle\_t**

Type of PCNT unit handle.

typedef struct pcnt\_chan\_t \***pcnt\_channel\_handle\_t**

Type of PCNT channel handle.

typedef bool (\***pcnt\_watch\_cb\_t**)(*pcnt\_unit\_handle\_t* unit, const *pcnt\_watch\_event\_data\_t* \*edata, void \*user\_ctx)

PCNT watch event callback prototype.

---

**备注:** The callback function is invoked from an ISR context, so it should meet the restrictions of not calling any blocking APIs when implementing the callback. e.g. must use ISR version of FreeRTOS APIs.

---

**Param unit [in]** PCNT unit handle

**Param edata [in]** PCNT event data, fed by the driver

**Param user\_ctx [in]** User data, passed from `pcnt_unit_register_event_callbacks()`

**Return** Whether a high priority task has been woken up by this function

## Header File

- [components/hal/include/hal/pcnt\\_types.h](#)
- This header file can be included with:

```
#include "hal/pcnt_types.h"
```

## Enumerations

enum **pcnt\_channel\_level\_action\_t**

PCNT channel action on control level.

*Values:*

enumerator **PCNT\_CHANNEL\_LEVEL\_ACTION\_KEEP**

Keep current count mode

enumerator **PCNT\_CHANNEL\_LEVEL\_ACTION\_INVERSE**

Invert current count mode (increase -> decrease, decrease -> increase)

enumerator **PCNT\_CHANNEL\_LEVEL\_ACTION\_HOLD**

Hold current count value

enum **pcnt\_channel\_edge\_action\_t**

PCNT channel action on signal edge.

*Values:*

enumerator **PCNT\_CHANNEL\_EDGE\_ACTION\_HOLD**

Hold current count value

enumerator **PCNT\_CHANNEL\_EDGE\_ACTION\_INCREASE**

Increase count value



enumerator **PCNT\_CHANNEL\_EDGE\_ACTION\_DECREASE**

Decrease count value

enum **pcnt\_unit\_zero\_cross\_mode\_t**

PCNT unit zero cross mode.

*Values:*

enumerator **PCNT\_UNIT\_ZERO\_CROSS\_POS\_ZERO**

start from positive value, end to zero, i.e. +N->0

enumerator **PCNT\_UNIT\_ZERO\_CROSS\_NEG\_ZERO**

start from negative value, end to zero, i.e. -N->0

enumerator **PCNT\_UNIT\_ZERO\_CROSS\_NEG\_POS**

start from negative value, end to positive value, i.e. -N->+M

enumerator **PCNT\_UNIT\_ZERO\_CROSS\_POS\_NEG**

start from positive value, end to negative value, i.e. +N->-M

## 2.6.20 红外遥控 (RMT)

### 简介

红外遥控 (RMT) 外设是一个红外发射和接收控制器。其数据格式灵活，可进一步扩展为多功能的通用收发器，发送或接收多种类型的信号。就网络分层而言，RMT 硬件包含物理层和数据链路层。物理层定义通信介质和比特信号的表示方式，数据链路层定义 RMT 帧的格式。RMT 帧的最小数据单元称为 **RMT 符号**，在驱动程序中以 `rmt_symbol_word_t` 表示。

ESP32-H2 的 RMT 外设存在多个通道<sup>1</sup>，每个通道都可以独立配置为发射器或接收器。

RMT 外设通常支持以下场景：

- 发送或接收红外信号，支持所有红外线协议，如 NEC 协议
- 生成通用序列
- 有限或无限次地在硬件控制的循环中发送信号
- 多通道同时发送
- 将载波调制到输出信号或从输入信号解调载波

**RMT 符号的内存布局** RMT 硬件定义了自己的数据模式，称为 **RMT 符号**。下图展示了一个 RMT 符号的位字段：每个符号由两对两个值组成，每对中的第一个值是一个 15 位的值，表示信号持续时间，以 RMT 滴答计。每对中的第二个值是一个 1 位的值，表示信号的逻辑电平，即高电平或低电平。

**RMT 发射器概述** RMT 发送通道 (TX Channel) 的数据路径和控制路径如下图所示：

驱动程序将用户数据编码为 RMT 数据格式，随后由 RMT 发射器根据编码生成波形。在将波形发送到 GPIO 管脚前，还可以调制高频载波信号。



图 18: RMT 符号结构 (L - 信号电平)



图 19: RMT 发射器概述

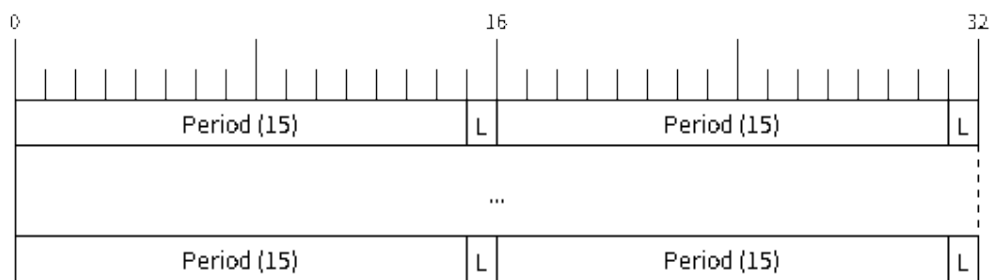

图 20: RMT 接收器概述

**RMT 接收器概述** RMT 接收通道 (RX Channel) 的数据路径和控制路径如下图所示：

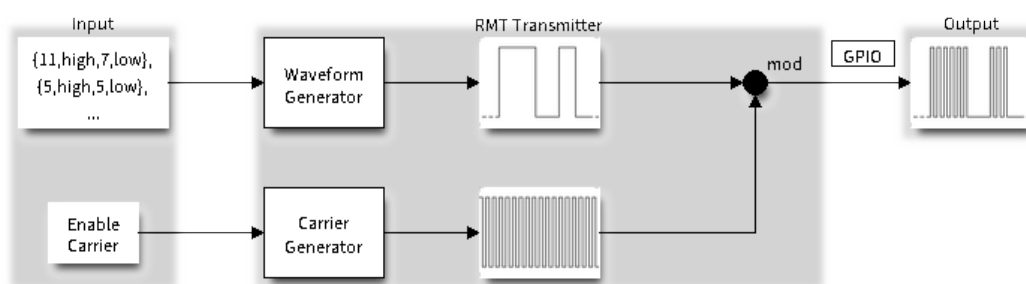
RMT 接收器可以对输入信号采样，将其转换为 RMT 数据格式，并将数据存储在内核中。还可以向接收器提供输入信号的基本特征，使其识别信号停止条件，并过滤掉信号干扰和噪声。RMT 外设还支持从基准信号中解调出高频载波信号。

## 功能概述

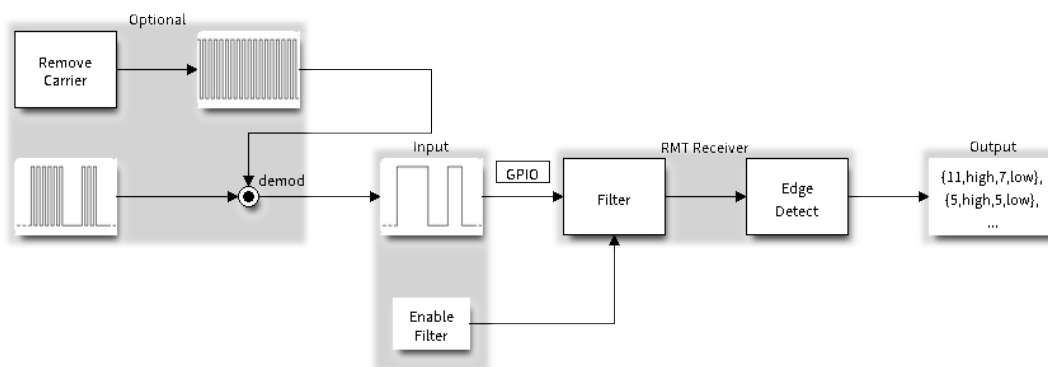
下文将分节概述 RMT 的功能：

- **资源分配** - 介绍如何分配和正确配置 RMT 通道，以及如何回收闲置通道及其他资源。
- **载波调制与解调** - 介绍如何调制和解调用于 TX 和 RX 通道的载波信号。
- **注册事件回调** - 介绍如何注册用户提供的事件回调函数以接收 RMT 通道事件。
- **启用及禁用通道** - 介绍如何启用和禁用 RMT 通道。
- **发起 TX 事务** - 介绍发起 TX 通道事务的步骤。
- **发起 RX 事务** - 介绍发起 RX 通道事务的步骤。
- **多通道同时发送** - 介绍如何将多个通道收集到一个同步组中，以便同时启动发送。
- **RMT 编码器** - 介绍如何通过组合驱动程序提供的多个基本编码器来编写自定义编码器。
- **电源管理** - 介绍不同时钟源对功耗的影响。
- **IRAM 安全** - 介绍禁用 cache 对 RMT 驱动程序的影响，并提供应对方案。
- **线程安全** - 介绍由驱动程序认证为线程安全的 API。
- **Kconfig 选项** - 介绍 RMT 驱动程序支持的各种 Kconfig 选项。

**资源分配** 驱动程序中，`rmt_channel_handle_t` 用于表示 RMT 的 TX 和 RX 通道。驱动程序在内部管理可用的通道，并在收到请求时提供空闲通道。

**安装 RMT TX 通道** 要安装 RMT TX 通道，应预先提供配置结构体 `rmt_tx_channel_config_t`。以下列表介绍了配置结构体中的各个部分。

- `rmt_tx_channel_config_t::gpio_num` 设置发射器使用的 GPIO 编号。
- `rmt_tx_channel_config_t::clk_src` 选择 RMT 通道的时钟源。`rmt_clock_source_t` 中列出了可用的时钟源。注意，其他通道将使用同一所选时钟源，因此，应确保分配的任意 TX 或 RX 通道都享有相同的配置。有关不同时钟源对功耗的影响，请参阅 [电源管理](#)。
- `rmt_tx_channel_config_t::resolution_hz` 设置内部滴答计数器的分辨率。基于此滴答，可以计算 RMT 信号的定时参数。
- 在启用 DMA 后端和未启用 DMA 后端的情况下，`rmt_tx_channel_config_t::mem_block_symbols` 字段含义稍有不同。
  - 若通过 `rmt_tx_channel_config_t::with_dma` 启用 DMA，则该字段可以控制内部 DMA 缓冲区大小。为实现更好的吞吐量、减少 CPU 开销，建议为字段设置一个较大的值，如 1024。
  - 如果未启用 DMA，则该字段控制通道专用内存块大小，至少为 48。
- `rmt_tx_channel_config_t::trans_queue_depth` 设置内部事务队列深度。队列越深，在待处理队列中可以准备的事务越多。
- `rmt_tx_channel_config_t::invert_out` 决定是否在将 RMT 信号发送到 GPIO 管脚前反转 RMT 信号。
- `rmt_tx_channel_config_t::with_dma` 为通道启用 DMA 后端。启用 DMA 后端可以释放 CPU 上的大部分通道工作负载，显著减轻 CPU 负担。但并非所有 ESP 芯片都支持 DMA 后端，在启用此选项前，请参阅 [\[TRM\]](#)。若所选芯片不支持 DMA 后端，可能会报告 `ESP_ERR_NOT_SUPPORTED` 错误。
- `rmt_tx_channel_config_t::io_loop_back` 启用通道所分配的 GPIO 上的输入和输出功能，将发送通道和接收通道绑定到同一个 GPIO 上，从而实现回环功能。
- `rmt_tx_channel_config_t::io_od_mode` 配置通道分配的 GPIO 为开漏模式 (open-drain)。当与 `rmt_tx_channel_config_t::io_loop_back` 结合使用时，可以实现双向总线，如 1-wire。
- `rmt_tx_channel_config_t::intr_priority` 设置中断的优先级。如果设置为 0，驱动将会使用一个中低优先级的中断（优先级可能为 1, 2 或 3），否则会使用 `rmt_tx_channel_config_t::intr_priority` 指定的优先级。请使用优先级序号 (1, 2, 3)，

<sup>1</sup> 不同 ESP 芯片系列可能具有不同数量的 RMT 通道，详情请参阅 [\[TRM\]](#)。驱动程序对通道申请数量不做限制，但当硬件资源用尽时，驱动程序将返回错误。因此，每次进行 [资源分配](#) 时，请注意检查返回值。

而不是 bitmask 的形式 ( $(1 \ll 1)$ ,  $(1 \ll 2)$ ,  $(1 \ll 3)$ )。请注意, 中断优先级一旦设置, 在 `rmt_del_channel()` 被调用之前不可再次修改。

将必要参数填充到结构体 `rmt_tx_channel_config_t` 后, 可以调用 `rmt_new_tx_channel()` 来分配和初始化 TX 通道。如果函数运行正确, 会返回 RMT 通道句柄; 如果 RMT 资源池内缺少空闲通道, 会返回 `ESP_ERR_NOT_FOUND` 错误; 如果硬件不支持 DMA 后端等部分功能, 则返回 `ESP_ERR_NOT_SUPPORTED` 错误。

```
rmt_channel_handle_t tx_chan = NULL;
rmt_tx_channel_config_t tx_chan_config = {
    .clk_src = RMT_CLK_SRC_DEFAULT,    // 选择时钟源
    .gpio_num = 0,                    // GPIO 编号
    .mem_block_symbols = 64,          // 内存块大小, 即 64 * 4 = 256 字节
    .resolution_hz = 1 * 1000 * 1000, // 1 MHz 滴答分辨率, 即 1 滴答 = 1 μs
    .trans_queue_depth = 4,           // 设置后台等待处理的事务数量
    .flags.invert_out = false,        // 不反转输出信号
    .flags.with_dma = false,          // 不需要 DMA 后端
};
ESP_ERROR_CHECK(rmt_new_tx_channel(&tx_chan_config, &tx_chan));
```

**安装 RMT RX 通道** 要安装 RMT RX 通道, 应预先提供配置结构体 `rmt_rx_channel_config_t`。以下列表介绍了配置结构体中的各个部分。

- `rmt_rx_channel_config_t::gpio_num` 设置接收器使用的 GPIO 编号。
- `rmt_rx_channel_config_t::clk_src` 选择 RMT 通道的时钟源。`rmt_clock_source_t` 中列出了可用的时钟源。注意, 其他通道将使用同一所选时钟源, 因此, 应确保分配的任意 TX 或 RX 通道都享有相同的配置。有关不同时钟源对功耗的影响, 请参阅[电源管理](#)。
- `rmt_rx_channel_config_t::resolution_hz` 设置内部滴答计数器的分辨率。基于此滴答, 可以计算 RMT 信号的定时参数。
- 在启用 DMA 后端和未启用 DMA 后端的情况下, `rmt_rx_channel_config_t::mem_block_symbols` 字段含义稍有不同。
  - 若通过 `rmt_rx_channel_config_t::with_dma` 启用 DMA, 则该字段可以最大化控制内部 DMA 缓冲区大小。
  - 如果未启用 DMA, 则该字段控制通道专用内存块大小, 至少为 48。
- `rmt_rx_channel_config_t::invert_in` 在输入信号传递到 RMT 接收器前对其进行反转。该反转由 GPIO 交换矩阵完成, 而非 RMT 外设。
- `rmt_rx_channel_config_t::with_dma` 为通道启用 DMA 后端。启用 DMA 后端可以释放 CPU 上的大部分通道工作负载, 显著减轻 CPU 负担。但并非所有 ESP 芯片都支持 DMA 后端, 在启用此选项前, 请参阅 [\[TRM\]](#)。若所选芯片不支持 DMA 后端, 可能会报告 `ESP_ERR_NOT_SUPPORTED` 错误。
- `rmt_rx_channel_config_t::io_loop_back` 启用通道所分配的 GPIO 上的输入和输出功能, 将发送通道和接收通道绑定到同一个 GPIO 上, 从而实现回环功能。
- `rmt_rx_channel_config_t::intr_priority` 设置中断的优先级。如果设置为 0, 驱动将会使用一个中低优先级的中断 (优先级可能为 1, 2 或 3), 否则会使用 `rmt_rx_channel_config_t::intr_priority` 指定的优先级。请使用优先级序号 (1, 2, 3), 而不是 bitmask 的形式 ( $(1 \ll 1)$ ,  $(1 \ll 2)$ ,  $(1 \ll 3)$ )。请注意, 中断优先级一旦设置, 在 `rmt_del_channel()` 被调用之前不可再次修改。

将必要参数填充到结构体 `rmt_rx_channel_config_t` 后, 可以调用 `rmt_new_rx_channel()` 来分配和初始化 RX 通道。如果函数运行正确, 会返回 RMT 通道句柄; 如果 RMT 资源池内缺少空闲通道, 会返回 `ESP_ERR_NOT_FOUND` 错误; 如果硬件不支持 DMA 后端等部分功能, 则返回 `ESP_ERR_NOT_SUPPORTED` 错误。

```
rmt_channel_handle_t rx_chan = NULL;
rmt_rx_channel_config_t rx_chan_config = {
    .clk_src = RMT_CLK_SRC_DEFAULT,    // 选择时钟源
    .resolution_hz = 1 * 1000 * 1000, // 1 MHz 滴答分辨率, 即 1 滴答 = 1 μs
    .mem_block_symbols = 64,          // 内存块大小, 即 64 * 4 = 256 字节
    .gpio_num = 2,                    // GPIO 编号
};
```

(下页继续)

(续上页)

```

    .flags.invert_in = false,           // 不反转输入信号
    .flags.with_dma = false,          // 不需要 DMA 后端
};
ESP_ERROR_CHECK(rmt_new_rx_channel(&rx_chan_config, &rx_chan));

```

**备注:** 由于 GPIO 驱动程序中的软件限制, 当 TX 和 RX 通道都绑定到同一 GPIO 时, 请确保在 TX 通道之前初始化 RX 通道。如果先设置 TX 通道, 那么在 RX 通道设置期间, GPIO 控制信号将覆盖先前的 RMT TX 通道信号。

**卸载 RMT 通道** 如果不再需要之前安装的 RMT 通道, 建议调用 `rmt_del_channel()` 回收资源, 使底层软件与硬件重新用于其他功能。

**载波调制与解调** RMT 发射器可以生成载波信号, 并将其调制到消息信号上。载波信号的频率远高于消息信号。此外, 仅支持配置载波信号的频率和占空比。RMT 接收器可以从输入信号中解调出载波信号。注意, 并非所有 ESP 芯片都支持载波调制和解调功能, 在配置载波前, 请参阅 [TRM]。若所选芯片不支持载波调制和解调功能, 可能会报告 `ESP_ERR_NOT_SUPPORTED` 错误。

载波相关配置位于 `rmt_carrier_config_t` 中, 该配置中的各部分详情如下:

- `rmt_carrier_config_t::frequency_hz` 设置载波频率, 单位为 Hz。
- `rmt_carrier_config_t::duty_cycle` 设置载波占空比。
- `rmt_carrier_config_t::polarity_active_low` 设置载波极性, 即应用载波的电平。
- `rmt_carrier_config_t::always_on` 设置是否在数据发送完成后仍输出载波, 该配置仅适用于 TX 通道。

**备注:** RX 通道的载波频率不应设置为理论值, 建议为载波频率留出一定的容差。例如, 以下代码片段的载波频率设置为 25 KHz, 而非 TX 侧配置的 38 KHz。因为信号在空气中传播时会发生反射和折射, 导致接收端接收的频率失真。

```

rmt_carrier_config_t tx_carrier_cfg = {
    .duty_cycle = 0.33,           // 载波占空比为 33%
    .frequency_hz = 38000,       // 38 KHz
    .flags.polarity_active_low = false, // 载波应调制到高电平
};
// 将载波调制到 TX 通道
ESP_ERROR_CHECK(rmt_apply_carrier(tx_chan, &tx_carrier_cfg));

rmt_carrier_config_t rx_carrier_cfg = {
    .duty_cycle = 0.33,           // 载波占空比为 33%
    .frequency_hz = 25000,       // 载波频率为 25
    ↪KHz, 应小于发射器的载波频率
    .flags.polarity_active_low = false, // 载波调制到高电平
};
// 从 RX 通道解调载波
ESP_ERROR_CHECK(rmt_apply_carrier(rx_chan, &rx_carrier_cfg));

```

**注册事件回调** 当 RMT 通道生成发送或接收完成等事件时, 会通过中断告知 CPU。如果需要在发生特定事件时调用函数, 可以为 TX 和 RX 通道分别调用 `rmt_tx_register_event_callbacks()` 和 `rmt_rx_register_event_callbacks()`, 向 RMT 驱动程序的中断服务程序 (ISR) 注册事件回调。由于上述回调函数是在 ISR 中调用的, 因此, 这些函数不应涉及 block 操作。可以检查调用 API 的后缀, 确保在函数中只调用了后缀为 ISR 的 FreeRTOS API。回调函数具有布尔返回值, 指示回调是否解除了更高优先级任务的阻塞状态。

有关 TX 通道支持的事件回调, 请参阅 `rmt_tx_event_callbacks_t`:



- `rmt_tx_event_callbacks_t::on_trans_done` 为“发送完成”的事件设置回调函数，函数原型声明为 `rmt_tx_done_callback_t`。

有关 RX 通道支持的事件回调，请参阅 `rmt_rx_event_callbacks_t`：

- `rmt_rx_event_callbacks_t::on_recv_done` 为“接收完成”的事件设置回调函数，函数原型声明为 `rmt_rx_done_callback_t`。

也可使用参数 `user_data`，在 `rmt_tx_register_event_callbacks()` 和 `rmt_rx_register_event_callbacks()` 中保存自定义上下文。用户数据将直接传递给每个回调函数。

---

**备注：**“receive-done”不等同于“receive-finished”。这个回调函数也可以在“partial-receive-done”时间发生的时候被调用。

---

在回调函数中可以获取驱动程序在 `edata` 中填充的特定事件数据。注意，`edata` 指针仅在回调的持续时间内有效。

有关 TX 完成事件数据的定义，请参阅 `rmt_tx_done_event_data_t`：

- `rmt_tx_done_event_data_t::num_symbols` 表示已发送的 RMT 符号数量，也反映了编码数据大小。注意，该值还考虑了由驱动程序附加的 EOF 符号，该符号标志着一次事务的结束。

有关 RX 完成事件数据的定义，请参阅 `rmt_rx_done_event_data_t`：

- `rmt_rx_done_event_data_t::received_symbols` 指向接收到的 RMT 符号，这些符号存储在 `rmt_receive()` 函数的 `buffer` 参数中，在回调函数返回前不应释放此接收缓冲区。如果你还启用了部分接收的功能，则这个用户缓冲区会被用作“二级缓冲区”，其中的内容可以被随后传入的数据覆盖。在这种情况下，如果你想要保存或者稍后处理一些数据，则需要将接收到的数据复制到其他位置。
- `rmt_rx_done_event_data_t::num_symbols` 表示接收到的 RMT 符号数量，该值不会超过 `rmt_receive()` 函数的 `buffer_size` 参数。如果 `buffer_size` 不足以容纳所有接收到的 RMT 符号，驱动程序将只保存缓冲区能够容纳的最大数量的符号，并丢弃或忽略多余的符号。
- `rmt_rx_done_event_data_t::is_last` 指示收到的数据包是否是当前的接收任务中的最后一个。这个标志在你使能 `rmt_receive_config_t::extra_flags::en_partial_rx` 部分接收功能时非常有用。

**启用及禁用通道** 在发送或接收 RMT 符号前，应预先调用 `rmt_enable()`。启用 TX 通道会启用特定中断，并使硬件准备发送事务。启用 RX 通道也会启用中断，但由于传入信号的特性尚不明确，接收器不会在此时启动，而是在 `rmt_receive()` 中启动。

相反，`rmt_disable()` 会禁用中断并清除队列中的中断，同时禁用发射器和接收器。

```
ESP_ERROR_CHECK(rmt_enable(tx_chan));
ESP_ERROR_CHECK(rmt_enable(rx_chan));
```

**发起 TX 事务** RMT 是一种特殊的通信外设，无法像 SPI 和 I2C 那样发送原始字节流，只能以 `rmt_symbol_word_t` 格式发送数据。然而，硬件无法将用户数据转换为 RMT 符号，该转换只能通过 RMT 编码器在软件中完成。编码器将用户数据编码为 RMT 符号，随后写入 RMT 内存块或 DMA 缓冲区。有关创建 RMT 编码器的详细信息，请参阅 [RMT 编码器](#)。

获取编码器后，调用 `rmt_transmit()` 启动 TX 事务，该函数会接收少数位置参数，如通道句柄、编码器句柄和有效负载缓冲区。此外，还需要在 `rmt_transmit_config_t` 中提供专用于发送的配置，具体如下：

- `rmt_transmit_config_t::loop_count` 设置发送的循环次数。在发射器完成一轮发送后，如果该值未设置为零，则再次启动相同的发送程序。由于循环由硬件控制，RMT 通道可以在几乎不需要 CPU 干预的情况下，生成许多周期性序列。
  - 将 `rmt_transmit_config_t::loop_count` 设置为 -1，会启用无限循环发送机制，此时，除非手动调用 `rmt_disable()`，否则通道不会停止，也不会生成“完成发送”事件。

- 将 `rmt_transmit_config_t::loop_count` 设置为正数，意味着迭代次数有限。此时，“完成发送”事件在指定的迭代次数完成后发生。

**备注：**注意，不是所有 ESP 芯片都支持 **循环发送** 功能，在配置此选项前，请参阅 [TRM]。若所选芯片不支持配置此选项，可能会报告 `ESP_ERR_NOT_SUPPORTED` 错误。

- `rmt_transmit_config_t::eot_level` 设置发射器完成工作时的输出电平，该设置同时适用于调用 `rmt_disable()` 停止发射器工作时的输出电平。
- `rmt_transmit_config_t::queue_nonblocking` 设置当传输队列满的时候该函数是否需要等待。如果该值设置为 `true` 那么当遇到队列满的时候，该函数会立即返回错误代码 `ESP_ERR_INVALID_STATE`。否则，函数会阻塞当前线程，直到传输队列有空档。

**备注：**如果将 `rmt_transmit_config_t::loop_count` 设置为非零值，即启用循环功能，则传输的大小将受到限制。编码的 RMT 符号不应超过 RMT 硬件内存块容量，否则会出现类似 `encoding artifacts can't exceed hw memory block for loop transmission` 的报错信息。如需通过循环启动大型事务，请尝试以下任一方法：

- 增加 `rmt_tx_channel_config_t::mem_block_symbols`。若此时启用了 DMA 后端，该方法将失效。
- 自定义编码器，并在编码函数中构造一个无限循环，详情请参阅 [RMT 编码器](#)。

`rmt_transmit()` 会在其内部构建一个事务描述符，并将其发送到作业队列中，该队列通常会在 ISR 上下文中被调度。因此，在 `rmt_transmit()` 返回时，该事务可能尚未启动。注意，你不能在事务结束前就去回收或者修改 payload 中的内容。通过 `rmt_tx_register_event_callbacks()` 来注册事件回调，可以在事务完成的时候被通知。为确保完成所有挂起的事务，你还可以调用 `rmt_tx_wait_all_done()`。

**多通道同时发送** 在一些实时控制应用程序中，启动多个 TX 通道（例如使两个器械臂同时移动）时，应避免出现任何时间漂移。为此，RMT 驱动程序可以创建 **同步管理器** 帮助管理该过程。在驱动程序中，同步管理器为 `rmt_sync_manager_handle_t`。RMT 同步发送过程如下图所示：



图 21: RMT TX 同步发送

**安装 RMT 同步管理器** 要创建同步管理器，应预先在 `rmt_sync_manager_config_t` 中指定要管理的通道：

- `rmt_sync_manager_config_t::tx_channel_array` 指向要管理的 TX 通道数组。
- `rmt_sync_manager_config_t::array_size` 设置要管理的通道数量。

成功调用 `rmt_new_sync_manager()` 函数将返回管理器句柄，该函数也可能因为无效参数等错误而无法调用。在已经安装了同步管理器，且缺少硬件资源来创建另一个管理器时，该函数将报

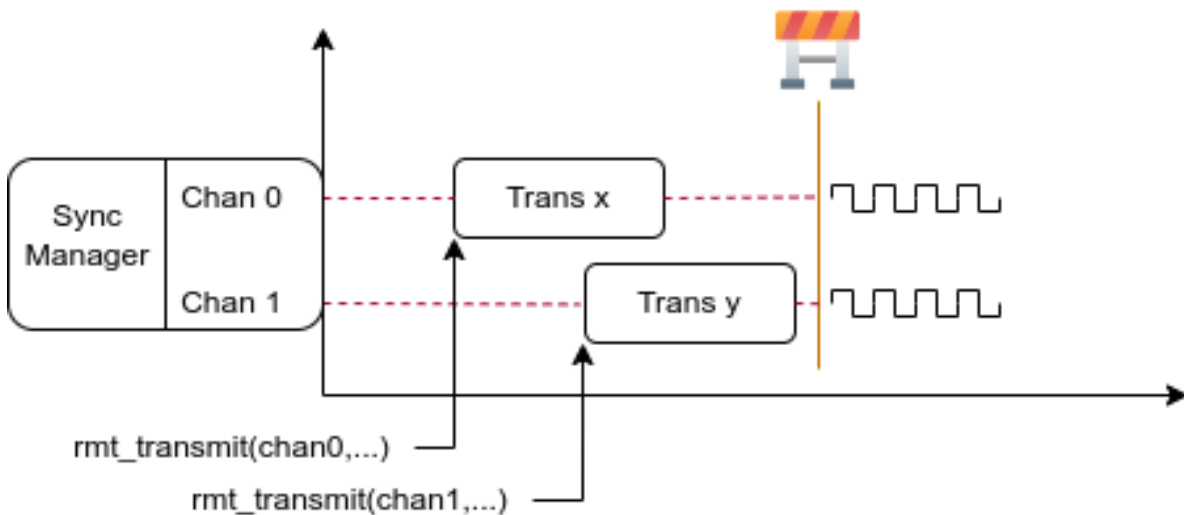
告 `ESP_ERR_NOT_FOUND` 错误。此外，如果硬件不支持同步管理器，将报告 `ESP_ERR_NOT_SUPPORTED` 错误。在使用同步管理器功能之前，请参阅 [TRM]。

**发起同时发送** 在调用 `rmt_sync_manager_config_t::tx_channel_array` 中所有通道上的 `rmt_transmit()` 前，任何受管理的 TX 通道都不会启动发送机制，而是处于待命状态。由于各通道事务不同，TX 通道通常会在不同的时间完成相应事务，这可能导致无法同步。因此，在重新启动同时发送程序之前，应调用 `rmt_sync_reset()` 函数重新同步所有通道。

调用 `rmt_del_sync_manager()` 函数可以回收同步管理器，并使通道可以在将来独立启动发送程序。

```
rmt_channel_handle_t tx_channels[2] = {NULL}; // 声明两个通道
int tx_gpio_number[2] = {0, 2};
// 依次安装通道
for (int i = 0; i < 2; i++) {
    rmt_tx_channel_config_t tx_chan_config = {
        .clk_src = RMT_CLK_SRC_DEFAULT, // 选择时钟源
        .gpio_num = tx_gpio_number[i], // GPIO 编号
        .mem_block_symbols = 64, // 内存块大小，即 64 * 4 = 256 字节
        .resolution_hz = 1 * 1000 * 1000, // 1 MHz 分辨率
        .trans_queue_depth = 1, // 设置可以在后台挂起的事务数量
    };
    ESP_ERROR_CHECK(rmt_new_tx_channel(&tx_chan_config, &tx_channels[i]));
}
// 安装同步管理器
rmt_sync_manager_handle_t synchro = NULL;
rmt_sync_manager_config_t synchro_config = {
    .tx_channel_array = tx_channels,
    .array_size = sizeof(tx_channels) / sizeof(tx_channels[0]),
};
ESP_ERROR_CHECK(rmt_new_sync_manager(&synchro_config, &synchro));

ESP_ERROR_CHECK(rmt_transmit(tx_channels[0], led_strip_encoders[0], led_data, led_
    ↪ num * 3, &transmit_config));
// 只有在调用 tx_channels[1] 的 rmt_transmit() 函数返回后，tx_channels[0]_
    ↪ 才会开始发送数据。
ESP_ERROR_CHECK(rmt_transmit(tx_channels[1], led_strip_encoders[1], led_data, led_
    ↪ num * 3, &transmit_config));
```

**发起 RX 事务** 如 [启用及禁用通道](#) 一节所述，仅调用 `rmt_enable()` 时，RX 通道无法接收 RMT 符号。为此，应在 `rmt_receive_config_t` 中指明传入信号的基本特征：

- `rmt_receive_config_t::signal_range_min_ns` 指定高电平或低电平有效脉冲的最小持续时间。如果脉冲宽度小于指定值，硬件会将其视为干扰信号并忽略。
- `rmt_receive_config_t::signal_range_max_ns` 指定高电平或低电平有效脉冲的最大持续时间。如果脉冲宽度大于指定值，接收器会将其视为 **停止信号**，并立即生成接收完成事件。
- 如果传入的数据包很长，无法一次性保存在用户缓冲区中，可以通过将 `rmt_receive_config_t::extra_flags::en_partial_rx` 设置为 `true` 来开启部分接收功能。在这种情况下，当用户缓冲区快满的时候，驱动会多次调用 `rmt_rx_event_callbacks_t::on_recv_done` 回调函数来通知用户去处理已经收到的数据。你可以检查 `cpp.member::rmt_rx_done_event_data_t::is_last` 的值来了解当前事务是否已经结束。请注意，并不是所有 ESP 系列芯片都支持这个功能，它依赖硬件提供的“ping-pong 接收”或者“DMA 接收”的能力。

根据以上配置调用 `rmt_receive()` 后，RMT 接收器会启动 RX 机制。注意，以上配置均针对特定事务存在，也就是说，要开启新一轮的接收时，需要再次设置 `rmt_receive_config_t` 选项。接收器会将传入信号以 `rmt_symbol_word_t` 的格式保存在内部内存块或 DMA 缓冲区中。

由于内存块大小有限，RMT 接收器会交替提醒驱动程序将累积的符号复制到外部处理。

应在 `rmt_receive()` 函数的 `buffer` 参数中提供复制目标。如果由于缓冲区大小不足而导致缓冲区溢出，接收器仍可继续工作，但会丢弃溢出的符号，并报告此错误信息：`user buffer too small`，



received symbols truncated。请注意 buffer 参数的生命周期，确保在接收器完成或停止工作前不会回收缓冲区。

当接收器完成工作，即接收到持续时间大于 `rmt_receive_config_t::signal_range_max_ns` 的信号时，驱动程序将停止接收器。如有需要，应再次调用 `rmt_receive()` 重新启动接收器。在 `rmt_rx_event_callbacks_t::on_recv_done` 的回调中可以获取接收到的数据。要获取更多有关详情，请参阅[注册事件回调](#)。

```
static bool example_rmt_rx_done_callback(rmt_channel_handle_t channel, const rmt_
↳rx_done_event_data_t *edata, void *user_data)
{
    BaseType_t high_task_wakeup = pdFALSE;
    QueueHandle_t receive_queue = (QueueHandle_t)user_data;
    // 将接收到的 RMT 符号发送到解析任务的消息队列中
    xQueueSendFromISR(receive_queue, edata, &high_task_wakeup);
    // 返回是否唤醒了任何任务
    return high_task_wakeup == pdTRUE;
}

QueueHandle_t receive_queue = xQueueCreate(1, sizeof(rmt_rx_done_event_data_t));
rmt_rx_event_callbacks_t cbs = {
    .on_recv_done = example_rmt_rx_done_callback,
};
ESP_ERROR_CHECK(rmt_rx_register_event_callbacks(rx_channel, &cbs, receive_queue));

// 以下时间要求均基于 NEC 协议
rmt_receive_config_t receive_config = {
    .signal_range_min_ns = 1250, // NEC 信号的最短持续时间为 560 μs, 由于 1250_
↳ns < 560 μs, 有效信号不会视为噪声
    .signal_range_max_ns = 12000000, // NEC 信号的最长持续时间为 9000 μs, 由于_
↳12000000 ns > 9000 μs, 接收不会提前停止
};

rmt_symbol_word_t raw_symbols[64]; // 64 个符号应足够存储一个标准 NEC 帧的数据
// 准备开始接收
ESP_ERROR_CHECK(rmt_receive(rx_channel, raw_symbols, sizeof(raw_symbols), &receive_
↳config));
// 等待 RX 完成信号
rmt_rx_done_event_data_t rx_data;
xQueueReceive(receive_queue, &rx_data, portMAX_DELAY);
// 解析接收到的符号数据
example_parse_nec_frame(rx_data.received_symbols, rx_data.num_symbols);
```

**RMT 编码器** RMT 编码器是 RMT TX 事务的一部分，用于在特定时间生成正确的 RMT 符号，并将其写入硬件内存或 DMA 缓冲区。对于编码函数，存在以下特殊限制条件：

- 由于目标 RMT 内存块无法一次性容纳所有数据，在单个事务中，须多次调用编码函数。为突破这一限制，可以采用 **交替**方式，将编码会话分成多个部分。为此，编码器需要 **记录其状态**，以便从上一部分编码结束之处继续编码。
- 编码函数在 ISR 上下文中运行。为加快编码会话，建议将编码函数放入 IRAM，这也有助于避免在编码过程中出现 cache 失效的情况。

为帮助用户更快速地上手 RMT 驱动程序，该程序默认提供了一些常用编码器，可以单独使用，也可以链式组合成新的编码器，有关原理请参阅[组合模式](#)。驱动程序在 `rmt_encoder_t` 中定义了编码器接口，包含以下函数：

- `rmt_encoder_t::encode` 是编码器的基本函数，编码会话即在此处进行。
  - 在单个事务中，可能会多次调用 `rmt_encoder_t::encode` 函数，该函数会返回当前编码会话的状态。
  - 可能出现的编码状态已在 `rmt_encode_state_t` 列出。如果返回结果中包含 `RMT_ENCODING_COMPLETE`，表示当前编码器已完成编码。

- 如果返回结果中包含 `RMT_ENCODING_MEM_FULL`，表示保存编码数据的空间不足，需要从当前会话中退出。
- `rmt_encoder_t::reset` 会将编码器重置为初始状态（编码器有其特定状态）。
  - 如果在未重置 RMT 发射器对应编码器的情况下，手动停止 RMT 发射器，随后的编码会话将报错。
  - 该函数也会在 `rmt_disable()` 中隐式调用。
- `rmt_encoder_t::del` 可以释放编码器分配的资源。

**拷贝编码器** 调用 `rmt_new_copy_encoder()` 可以创建拷贝编码器，将 RMT 符号从用户空间复制到驱动程序层。拷贝编码器通常用于编码 `const` 数据，即初始化后在运行时不会发生更改的数据，如红外协议中的前导码。

调用 `rmt_new_copy_encoder()` 前，应预先提供配置结构体 `rmt_copy_encoder_config_t`。目前，该配置保留用作未来的扩展功能，暂无具体用途或设置项。

**字节编码器** 调用 `rmt_new_bytes_encoder()` 可以创建字节编码器，将用户空间的字节流动态转化成 RMT 符号。字节编码区通常用于编码动态数据，如红外协议中的地址和命令字段。

调用 `rmt_new_bytes_encoder()` 前，应预先提供配置结构体 `rmt_bytes_encoder_config_t`，具体配置如下：

- `rmt_bytes_encoder_config_t::bit0` 和 `rmt_bytes_encoder_config_t::bit1` 为必要项，用于告知编码器如何以 `rmt_symbol_word_t` 格式表示零位和一位。
- `rmt_bytes_encoder_config_t::msb_first` 设置各字节的位编码。如果设置为真，编码器将首先编码 **最高有效位**，否则将首先编码 **最低有效位**。

除驱动程序提供的原始编码器外，也可以将现有编码器链式组合成自定义编码器。常见编码器链如下图所示：



图 22: RMT 编码器链

**自定义 NEC 协议的 RMT 编码器** 本节将演示编写 NEC 编码器的流程。NEC 红外协议使用脉冲距离编码来发送消息位，每个脉冲突发的持续时间为  $562.5 \mu\text{s}$ ，逻辑位发送详见下文。注意，各字节的最低有效位会优先发送。

- 逻辑 0:  $562.5 \mu\text{s}$  的脉冲突发后有  $562.5 \mu\text{s}$  的空闲时间，总发送时间为  $1.125 \text{ ms}$
- 逻辑 1:  $562.5 \mu\text{s}$  的脉冲突发后有  $1.6875 \text{ ms}$  的空闲时间，总发送时间为  $2.25 \text{ ms}$

在遥控器上按下某个按键时，将按以下顺序发送有关信号：

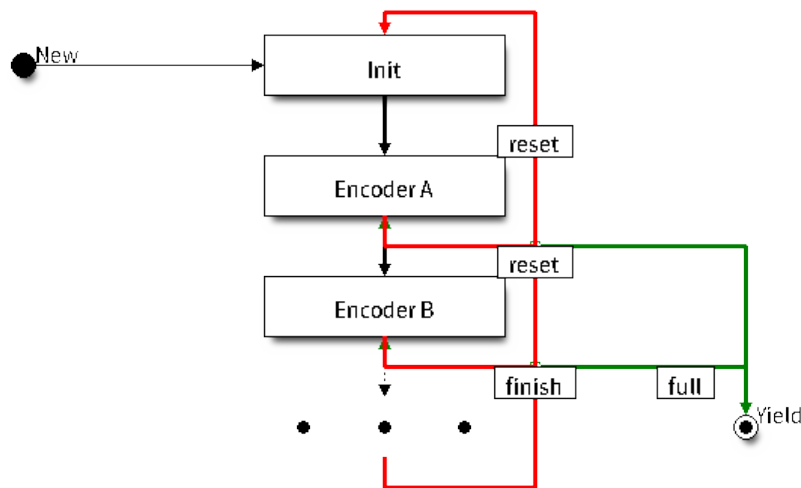
- $9 \text{ ms}$  的引导脉冲发射，也称为 AGC 脉冲



图 23: 红外 NEC 帧

- 4.5 ms 的空闲时间
- 接收设备的 8 位地址
- 地址的 8 位逻辑反码
- 8 位命令
- 命令的 8 位逻辑反码
- 最后的 562.5  $\mu$ s 脉冲突发，表示消息发送结束

随后可以按相同顺序构建 NEC `rmt_encoder_t::encode` 函数，例如

```
// 红外 NEC 扫码表示法
typedef struct {
    uint16_t address;
    uint16_t command;
} ir_nec_scan_code_t;

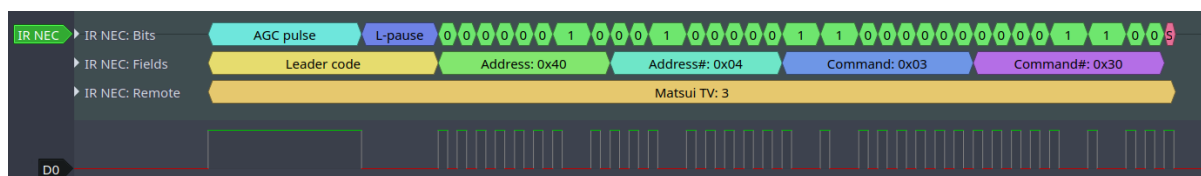
// 通过组合原始编码器构建编码器
typedef struct {
    rmt_encoder_t base; // 基础类 "class" 声明了标准编码器接口
    rmt_encoder_t *copy_encoder; // 使用拷贝编码器来编码前导码和结束码
    rmt_encoder_t *bytes_encoder; // 使用字节编码器来编码地址和命令数据
    rmt_symbol_word_t nec_leading_symbol; // 使用 RMT 表示的 NEC 前导码
    rmt_symbol_word_t nec_ending_symbol; // 使用 RMT 表示的 NEC 结束码
    int state; // 记录当前编码状态,即所处编码阶段
} rmt_ir_nec_encoder_t;

static size_t rmt_encode_ir_nec(rmt_encoder_t *encoder, rmt_channel_handle_t
↪channel, const void *primary_data, size_t data_size, rmt_encode_state_t *ret
↪state)
{
    rmt_ir_nec_encoder_t *nec_encoder = __containerof(encoder, rmt_ir_nec_encoder_
↪t, base);
    rmt_encode_state_t session_state = RMT_ENCODING_RESET;
    rmt_encode_state_t state = RMT_ENCODING_RESET;
    size_t encoded_symbols = 0;
    ir_nec_scan_code_t *scan_code = (ir_nec_scan_code_t *)primary_data;
    rmt_encoder_handle_t copy_encoder = nec_encoder->copy_encoder;
    rmt_encoder_handle_t bytes_encoder = nec_encoder->bytes_encoder;
    switch (nec_encoder->state) {
        case 0: // 发送前导码
            encoded_symbols += copy_encoder->encode(copy_encoder, channel, &nec_
↪encoder->nec_leading_symbol,
                                                    sizeof(rmt_symbol_word_t), &
↪session_state);
            if (session_state & RMT_ENCODING_COMPLETE) {
                nec_encoder->state = 1; //
↪只有在当前编码器完成工作时才能切换到下一个状态
            }
            if (session_state & RMT_ENCODING_MEM_FULL) {
                state |= RMT_ENCODING_MEM_FULL;
                goto out; //
↪如果没有足够的空间来存放其他编码相关的数据,程序会暂停当前操作,并跳转到指定位置继续执行。
            }
            // 继续执行
    }
}
```

(下页继续)

```

    case 1: // 发送地址
        encoded_symbols += bytes_encoder->encode(bytes_encoder, channel, &scan_
↪code->address, sizeof(uint16_t), &session_state);
        if (session_state & RMT_ENCODING_COMPLETE) {
            nec_encoder->state = 2; //↵
↪只有在当前编码器完成工作时才能切换到下一个状态
        }
        if (session_state & RMT_ENCODING_MEM_FULL) {
            state |= RMT_ENCODING_MEM_FULL;
            goto out; //↵
↪如果没有足够的空间来存放其他编码相关的数据，程序会暂停当前操作，并跳转到指定位置继续执行。
        }
        // 继续执行
    case 2: // 发送命令
        encoded_symbols += bytes_encoder->encode(bytes_encoder, channel, &scan_
↪code->command, sizeof(uint16_t), &session_state);
        if (session_state & RMT_ENCODING_COMPLETE) {
            nec_encoder->state = 3; //↵
↪只有在当前编码器完成工作时才能切换到下一个状态
        }
        if (session_state & RMT_ENCODING_MEM_FULL) {
            state |= RMT_ENCODING_MEM_FULL;
            goto out; //↵
↪如果没有足够的空间来存放其他编码相关的数据，程序会暂停当前操作，并跳转到指定位置继续执行。
        }
        // 继续执行
    case 3: // 发送结束码
        encoded_symbols += copy_encoder->encode(copy_encoder, channel, &nec_
↪encoder->nec_ending_symbol,
                                                    sizeof(rmt_symbol_word_t), &
↪session_state);
        if (session_state & RMT_ENCODING_COMPLETE) {
            nec_encoder->state = RMT_ENCODING_RESET; // 返回初始编码会话
            state |= RMT_ENCODING_COMPLETE; // 告知调用者 NEC 编码已完成
        }
        if (session_state & RMT_ENCODING_MEM_FULL) {
            state |= RMT_ENCODING_MEM_FULL;
            goto out; //↵
↪如果没有足够的空间来存放其他编码相关的数据，程序会暂停当前操作，并跳转到指定位置继续执行。
        }
    }
out:
    *ret_state = state;
    return encoded_symbols;
}

```

完整示例代码存放在 `peripherals/rmt/ir_nec_transceiver` 目录下。以上代码片段使用了 `switch-case` 和一些 `goto` 语句实现了一个有限状态机，借助此模式可构建更复杂的红外协议。

**电源管理** 通过 `CONFIG_PM_ENABLE` 选项启用电源管理时，系统会在进入 Light-sleep 模式前调整 APB 频率。该操作可能改变 RMT 内部计数器的分辨率。

然而，驱动程序可以通过获取 `ESP_PM_APB_FREQ_MAX` 类型的电源管理锁，防止系统改变 APB 频率。每当驱动创建以 `RMT_CLK_SRC_APB` 作为时钟源的 RMT 通道时，都会在通过 `rmt_enable()` 启用通道后获取电源管理锁。反之，调用 `rmt_disable()` 时，驱动程序释放锁。这也意味着 `rmt_enable()` 和 `rmt_disable()` 应成对出现。

如果将通道时钟源设置为其他选项，如 `RMT_CLK_SRC_XTAL`，则驱动程序不会为其安装电源管理锁。对于低功耗应用程序来说，只要时钟源仍然可以提供足够的分辨率，不安装电源管理锁更为合适。

**IRAM 安全** 默认情况下，禁用 cache 时，写入/擦除主 flash 等原因将导致 RMT 中断延迟，事件回调函数也将延迟执行。在实时应用程序中，应避免此类情况。此外，当 RMT 事务依赖交替中断连续编码或复制 RMT 符号时，上述中断延迟将导致不可预测的结果。

因此，可以启用 Kconfig 选项 `CONFIG_RMT_ISR_IRAM_SAFE`，该选项：

1. 支持在禁用 cache 时启用所需中断
2. 支持将 ISR 使用的所有函数存放在 IRAM 中<sup>2</sup>
3. 支持将驱动程序实例存放在 DRAM 中，以防其意外映射到 PSRAM 中

启用该选项可以保证 cache 禁用时的中断运行，但会相应增加 IRAM 占用。

另外一个 Kconfig 选项 `CONFIG_RMT_RECV_FUNC_IN_IRAM` 可以将 `rmt_receive()` 函数放进内部的 IRAM 中，从而当 flash cache 被关闭的时候，这个函数也能够被使用。

**线程安全** RMT 驱动程序会确保工厂函数 `rmt_new_tx_channel()`、`rmt_new_rx_channel()` 和 `rmt_new_sync_manager()` 的线程安全。使用时，可以直接从不同的 RTOS 任务中调用此类函数，无需额外锁保护。其他以 `rmt_channel_handle_t` 和 `rmt_sync_manager_handle_t` 作为第一个位置参数的函数均非线程安全，在没有设置互斥锁保护的任中，应避免从多个任务中调用这类函数。

以下函数允许在 ISR 上下文中使用：

- `rmt_receive()`

### Kconfig 选项

- `CONFIG_RMT_ISR_IRAM_SAFE` 控制默认 ISR 处理程序能否在禁用 cache 的情况下工作。详情请参阅 [IRAM 安全](#)。
- `CONFIG_RMT_ENABLE_DEBUG_LOG` 用于启用调试日志输出，启用此选项将增加固件的二进制文件大小。
- `CONFIG_RMT_RECV_FUNC_IN_IRAM` 用于控制 RMT 接收函数被链接到系统存储的哪个位置 (IRAM 还是 Flash)。详情请参阅 [IRAM 安全](#)。

### 应用示例

- 基于 RMT 的 RGB LED 灯带自定义编码器： [peripherals/rmt/led\\_strip](#)
- RMT 红外 NEC 协议的编码与解码： [peripherals/rmt/ir\\_nec\\_transceiver](#)
- 队列中的 RMT 事务： [peripherals/rmt/musical\\_buzzer](#)
- 基于 RMT 的步进电机与 S 曲线算法： [peripherals/rmt/stepper\\_motor](#)
- 用于驱动 DShot ESC 的 RMT 无限循环： [peripherals/rmt/dshot\\_esc](#)
- 模拟 1-wire 协议的 RMT 实现（以 DS18B20 为例）： [peripherals/rmt/onewire](#)

### FAQ

- RMT 为什么会发送比预期更多的数据？  
RMT 的传输层编码是在 ISR 上下文中完成的，如果 RMT 编码耗时较长（例如，增加了过多的调试追踪信息），或者由于中断延迟和抢占导致编码工作被推迟执行，导致传输器在编码器更新内存数据之前就读取了老数据，致使传输器再次发送先前的数据。我们无法告诉硬件传输器自动等待新数据的更新，但是可以通过以下方法来缓解此问题：
  - 增加 `rmt_tx_channel_config_t::mem_block_symbols` 的值，步长为 48。
  - 将编码函数放置在 IRAM 中。
  - 如果所用芯片支持 `rmt_tx_channel_config_t::with_dma`，请启用该选项。
  - 将 RMT 驱动安装在另外一个 CPU 核上，避免和其他高中断频率的外设竞争同一个 CPU 资源。

<sup>2</sup> 注意，回调函数（如 `rmt_tx_event_callbacks_t::on_trans_done`）及回调函数所调用的函数也应位于 IRAM 中。

## API 参考

### Header File

- [components/esp\\_driver\\_rmt/include/driver/rmt\\_tx.h](#)
- This header file can be included with:

```
#include "driver/rmt_tx.h"
```

- This header file is a part of the API provided by the `esp_driver_rmt` component. To declare that your component depends on `esp_driver_rmt`, add the following to your `CMakeLists.txt`:

```
REQUIRES esp_driver_rmt
```

or

```
PRIV_REQUIRES esp_driver_rmt
```

### Functions

`esp_err_t rmt_new_tx_channel` (const `rmt_tx_channel_config_t` \*config, `rmt_channel_handle_t` \*ret\_chan)

Create a RMT TX channel.

#### 参数

- **config** -- [in] TX channel configurations
- **ret\_chan** -- [out] Returned generic RMT channel handle

#### 返回

- `ESP_OK`: Create RMT TX channel successfully
- `ESP_ERR_INVALID_ARG`: Create RMT TX channel failed because of invalid argument
- `ESP_ERR_NO_MEM`: Create RMT TX channel failed because out of memory
- `ESP_ERR_NOT_FOUND`: Create RMT TX channel failed because all RMT channels are used up and no more free one
- `ESP_ERR_NOT_SUPPORTED`: Create RMT TX channel failed because some feature is not supported by hardware, e.g. DMA feature is not supported by hardware
- `ESP_FAIL`: Create RMT TX channel failed because of other error

`esp_err_t rmt_transmit` (`rmt_channel_handle_t` tx\_channel, `rmt_encoder_handle_t` encoder, const void \*payload, size\_t payload\_bytes, const `rmt_transmit_config_t` \*config)

Transmit data by RMT TX channel.

---

**备注:** This function constructs a transaction descriptor then pushes to a queue. The transaction will not start immediately if there's another one under processing. Based on the setting of `rmt_transmit_config_t::queue_nonblocking`, if there're too many transactions pending in the queue, this function can block until it has free slot, otherwise just return quickly.

---



---

**备注:** The payload data to be transmitted will be encoded into RMT symbols by the specific encoder.

---



---

**备注:** You CAN'T modify the `payload` during the transmission, it should be kept valid until the transmission is finished.

---

#### 参数

- **tx\_channel** -- [in] RMT TX channel that created by `rmt_new_tx_channel()`
- **encoder** -- [in] RMT encoder that created by various factory APIs like `rmt_new_bytes_encoder()`
- **payload** -- [in] The raw data to be encoded into RMT symbols
- **payload\_bytes** -- [in] Size of the `payload` in bytes
- **config** -- [in] Transmission specific configuration



**返回**

- ESP\_OK: Transmit data successfully
- ESP\_ERR\_INVALID\_ARG: Transmit data failed because of invalid argument
- ESP\_ERR\_INVALID\_STATE: Transmit data failed because channel is not enabled
- ESP\_ERR\_NOT\_SUPPORTED: Transmit data failed because some feature is not supported by hardware, e.g. unsupported loop count
- ESP\_FAIL: Transmit data failed because of other error

*esp\_err\_t* **rmt\_tx\_wait\_all\_done** (*rmt\_channel\_handle\_t* tx\_channel, int timeout\_ms)

Wait for all pending TX transactions done.

---

**备注:** This function will block forever if the pending transaction can't be finished within a limited time (e.g. an infinite loop transaction). See also `rmt_disable()` for how to terminate a working channel.

---

**参数**

- **tx\_channel** -- **[in]** RMT TX channel that created by `rmt_new_tx_channel()`
- **timeout\_ms** -- **[in]** Wait timeout, in ms. Specially, -1 means to wait forever.

**返回**

- ESP\_OK: Flush transactions successfully
- ESP\_ERR\_INVALID\_ARG: Flush transactions failed because of invalid argument
- ESP\_ERR\_TIMEOUT: Flush transactions failed because of timeout
- ESP\_FAIL: Flush transactions failed because of other error

*esp\_err\_t* **rmt\_tx\_register\_event\_callbacks** (*rmt\_channel\_handle\_t* tx\_channel, const *rmt\_tx\_event\_callbacks\_t* \*cbs, void \*user\_data)

Set event callbacks for RMT TX channel.

---

**备注:** User can deregister a previously registered callback by calling this function and setting the callback member in the `cbs` structure to NULL.

---



---

**备注:** When `CONFIG_RMT_ISR_IRAM_SAFE` is enabled, the callback itself and functions called by it should be placed in IRAM. The variables used in the function should be in the SRAM as well. The `user_data` should also reside in SRAM.

---

**参数**

- **tx\_channel** -- **[in]** RMT generic channel that created by `rmt_new_tx_channel()`
- **cbs** -- **[in]** Group of callback functions
- **user\_data** -- **[in]** User data, which will be passed to callback functions directly

**返回**

- ESP\_OK: Set event callbacks successfully
- ESP\_ERR\_INVALID\_ARG: Set event callbacks failed because of invalid argument
- ESP\_FAIL: Set event callbacks failed because of other error

*esp\_err\_t* **rmt\_new\_sync\_manager** (const *rmt\_sync\_manager\_config\_t* \*config, *rmt\_sync\_manager\_handle\_t* \*ret\_synchro)

Create a synchronization manager for multiple TX channels, so that the managed channel can start transmitting at the same time.

---

**备注:** All the channels to be managed should be enabled by `rmt_enable()` before put them into sync manager.

---

**参数**

- **config** -- **[in]** Synchronization manager configuration
- **ret\_synchro** -- **[out]** Returned synchronization manager handle

**返回**

- ESP\_OK: Create sync manager successfully
- ESP\_ERR\_INVALID\_ARG: Create sync manager failed because of invalid argument
- ESP\_ERR\_NOT\_SUPPORTED: Create sync manager failed because it is not supported by hardware
- ESP\_ERR\_INVALID\_STATE: Create sync manager failed because not all channels are enabled
- ESP\_ERR\_NO\_MEM: Create sync manager failed because out of memory
- ESP\_ERR\_NOT\_FOUND: Create sync manager failed because all sync controllers are used up and no more free one
- ESP\_FAIL: Create sync manager failed because of other error

*esp\_err\_t* **rmt\_del\_sync\_manager** (*rmt\_sync\_manager\_handle\_t* synchro)

Delete synchronization manager.

**参数** **synchro** -- **[in]** Synchronization manager handle returned from `rmt_new_sync_manager()`

**返回**

- ESP\_OK: Delete the synchronization manager successfully
- ESP\_ERR\_INVALID\_ARG: Delete the synchronization manager failed because of invalid argument
- ESP\_FAIL: Delete the synchronization manager failed because of other error

*esp\_err\_t* **rmt\_sync\_reset** (*rmt\_sync\_manager\_handle\_t* synchro)

Reset synchronization manager.

**参数** **synchro** -- **[in]** Synchronization manager handle returned from `rmt_new_sync_manager()`

**返回**

- ESP\_OK: Reset the synchronization manager successfully
- ESP\_ERR\_INVALID\_ARG: Reset the synchronization manager failed because of invalid argument
- ESP\_FAIL: Reset the synchronization manager failed because of other error

**Structures**

struct **rmt\_tx\_event\_callbacks\_t**

Group of RMT TX callbacks.

---

**备注:** The callbacks are all running under ISR environment

---



---

**备注:** When CONFIG\_RMT\_ISR\_IRAM\_SAFE is enabled, the callback itself and functions called by it should be placed in IRAM. The variables used in the function should be in the SRAM as well.

---

**Public Members**

*rmt\_tx\_done\_callback\_t* **on\_trans\_done**

Event callback, invoked when transmission is finished

struct **rmt\_tx\_channel\_config\_t**

RMT TX channel specific configuration.



### Public Members

`gpio_num_t` **gpio\_num**

GPIO number used by RMT TX channel. Set to -1 if unused

`rmt_clock_source_t` **clk\_src**

Clock source of RMT TX channel, channels in the same group must use the same clock source

`uint32_t` **resolution\_hz**

Channel clock resolution, in Hz

`size_t` **mem\_block\_symbols**

Size of memory block, in number of `rmt_symbol_word_t`, must be an even. In the DMA mode, this field controls the DMA buffer size, it can be set to a large value; In the normal mode, this field controls the number of RMT memory block that will be used by the channel.

`size_t` **trans\_queue\_depth**

Depth of internal transfer queue, increase this value can support more transfers pending in the background

`int` **intr\_priority**

RMT interrupt priority, if set to 0, the driver will try to allocate an interrupt with a relative low priority (1,2,3)

`uint32_t` **invert\_out**

Whether to invert the RMT channel signal before output to GPIO pad

`uint32_t` **with\_dma**

If set, the driver will allocate an RMT channel with DMA capability

`uint32_t` **io\_loop\_back**

The signal output from the GPIO will be fed to the input path as well

`uint32_t` **io\_od\_mode**

Configure the GPIO as open-drain mode

struct `rmt_tx_channel_config_t`::[anonymous] **flags**

TX channel config flags

struct **rmt\_transmit\_config\_t**

RMT transmit specific configuration.

### Public Members

`int` **loop\_count**

Specify the times of transmission in a loop, -1 means transmitting in an infinite loop

`uint32_t` **eot\_level**

Set the output level for the "End Of Transmission"

uint32\_t **queue\_nonblocking**

If set, when the transaction queue is full, driver will not block the thread but return directly

struct *rmt\_transmit\_config\_t*::[anonymous] **flags**

Transmit specific config flags

struct **rmt\_sync\_manager\_config\_t**

Synchronous manager configuration.

## Public Members

const *rmt\_channel\_handle\_t* \***tx\_channel\_array**

Array of TX channels that are about to be managed by a synchronous controller

size\_t **array\_size**

Size of the tx\_channel\_array

## Header File

- [components/esp\\_driver\\_rmt/include/driver/rmt\\_rx.h](#)
- This header file can be included with:

```
#include "driver/rmt_rx.h"
```

- This header file is a part of the API provided by the `esp_driver_rmt` component. To declare that your component depends on `esp_driver_rmt`, add the following to your CMakeLists.txt:

```
REQUIRES esp_driver_rmt
```

or

```
PRIV_REQUIRES esp_driver_rmt
```

## Functions

*esp\_err\_t* **rmt\_new\_rx\_channel** (const *rmt\_rx\_channel\_config\_t* \*config, *rmt\_channel\_handle\_t* \*ret\_chan)

Create a RMT RX channel.

### 参数

- **config** -- [in] RX channel configurations
- **ret\_chan** -- [out] Returned generic RMT channel handle

### 返回

- ESP\_OK: Create RMT RX channel successfully
- ESP\_ERR\_INVALID\_ARG: Create RMT RX channel failed because of invalid argument
- ESP\_ERR\_NO\_MEM: Create RMT RX channel failed because out of memory
- ESP\_ERR\_NOT\_FOUND: Create RMT RX channel failed because all RMT channels are used up and no more free one
- ESP\_ERR\_NOT\_SUPPORTED: Create RMT RX channel failed because some feature is not supported by hardware, e.g. DMA feature is not supported by hardware
- ESP\_FAIL: Create RMT RX channel failed because of other error

*esp\_err\_t* **rmt\_receive** (*rmt\_channel\_handle\_t* rx\_channel, void \*buffer, size\_t buffer\_size, const *rmt\_receive\_config\_t* \*config)

Initiate a receive job for RMT RX channel.

---

**备注:** This function is non-blocking, it initiates a new receive job and then returns. User should check the received data from the `on_recv_done` callback that registered by `rmt_rx_register_event_callbacks()`.

---

**备注:** This function can also be called in ISR context.

---

**备注:** If you want this function to work even when the flash cache is disabled, please enable the `CONFIG_RMT_RECV_FUNC_IN_IRAM` option.

---

### 参数

- **rx\_channel** -- **[in]** RMT RX channel that created by `rmt_new_rx_channel()`
- **buffer** -- **[in]** The buffer to store the received RMT symbols
- **buffer\_size** -- **[in]** size of the `buffer`, in bytes
- **config** -- **[in]** Receive specific configurations

### 返回

- `ESP_OK`: Initiate receive job successfully
- `ESP_ERR_INVALID_ARG`: Initiate receive job failed because of invalid argument
- `ESP_ERR_INVALID_STATE`: Initiate receive job failed because channel is not enabled
- `ESP_FAIL`: Initiate receive job failed because of other error

`esp_err_t rmt_rx_register_event_callbacks(rmt_channel_handle_t rx_channel, const rmt_rx_event_callbacks_t *cbs, void *user_data)`

Set callbacks for RMT RX channel.

---

**备注:** User can deregister a previously registered callback by calling this function and setting the callback member in the `cbs` structure to `NULL`.

---

**备注:** When `CONFIG_RMT_ISR_IRAM_SAFE` is enabled, the callback itself and functions called by it should be placed in IRAM. The variables used in the function should be in the SRAM as well. The `user_data` should also reside in SRAM.

---

### 参数

- **rx\_channel** -- **[in]** RMT generic channel that created by `rmt_new_rx_channel()`
- **cbs** -- **[in]** Group of callback functions
- **user\_data** -- **[in]** User data, which will be passed to callback functions directly

### 返回

- `ESP_OK`: Set event callbacks successfully
- `ESP_ERR_INVALID_ARG`: Set event callbacks failed because of invalid argument
- `ESP_FAIL`: Set event callbacks failed because of other error

## Structures

struct `rmt_rx_event_callbacks_t`

Group of RMT RX callbacks.

---

**备注:** The callbacks are all running under ISR environment

---

---

**备注:** When `CONFIG_RMT_ISR_IRAM_SAFE` is enabled, the callback itself and functions called by it should be placed in IRAM. The variables used in the function should be in the SRAM as well.

---

## Public Members

[\*rmt\\_rx\\_done\\_callback\\_t\*](#) **on\_recv\_done**

Event callback, invoked when the RMT channel reception is finished or partial data is received

struct **rmt\_rx\_channel\_config\_t**

RMT RX channel specific configuration.

## Public Members

[\*gpio\\_num\\_t\*](#) **gpio\_num**

GPIO number used by RMT RX channel. Set to -1 if unused

[\*rmt\\_clock\\_source\\_t\*](#) **clk\_src**

Clock source of RMT RX channel, channels in the same group must use the same clock source

[\*uint32\\_t\*](#) **resolution\_hz**

Channel clock resolution, in Hz

[\*size\\_t\*](#) **mem\_block\_symbols**

Size of memory block, in number of [\*rmt\\_symbol\\_word\\_t\*](#), must be an even. In the DMA mode, this field controls the DMA buffer size, it can be set to a large value (e.g. 1024); In the normal mode, this field controls the number of RMT memory block that will be used by the channel.

[\*int\*](#) **intr\_priority**

RMT interrupt priority, if set to 0, the driver will try to allocate an interrupt with a relative low priority (1,2,3)

[\*uint32\\_t\*](#) **invert\_in**

Whether to invert the incoming RMT channel signal

[\*uint32\\_t\*](#) **with\_dma**

If set, the driver will allocate an RMT channel with DMA capability

[\*uint32\\_t\*](#) **io\_loop\_back**

For debug/test, the signal output from the GPIO will be fed to the input path as well

struct [\*rmt\\_rx\\_channel\\_config\\_t\*](#)::[anonymous] **flags**

RX channel config flags

struct **rmt\_receive\_config\_t**

RMT receive specific configuration.

## Public Members

uint32\_t **signal\_range\_min\_ns**

A pulse whose width is smaller than this threshold will be treated as glitch and ignored

uint32\_t **signal\_range\_max\_ns**

RMT will stop receiving if one symbol level has kept more than `signal_range_max_ns`

struct *rmt\_receive\_config\_t::extra\_flags* **flags**

Receive specific config flags

struct **extra\_flags**

Receive specific flags.

## Public Members

uint32\_t **en\_partial\_rx**

Set this flag if the incoming data is very long, and the driver can only receive the data piece by piece, because the user buffer is not sufficient to save all the data.

## Header File

- [components/esp\\_driver\\_rmt/include/driver/rmt\\_common.h](#)
- This header file can be included with:

```
#include "driver/rmt_common.h"
```

- This header file is a part of the API provided by the `esp_driver_rmt` component. To declare that your component depends on `esp_driver_rmt`, add the following to your `CMakeLists.txt`:

```
REQUIRES esp_driver_rmt
```

or

```
PRIV_REQUIRES esp_driver_rmt
```

## Functions

*esp\_err\_t* **rmt\_del\_channel** (*rmt\_channel\_handle\_t* channel)

Delete an RMT channel.

**参数** **channel** -- [in] RMT generic channel that created by `rmt_new_tx_channel()` or `rmt_new_rx_channel()`

**返回**

- ESP\_OK: Delete RMT channel successfully
- ESP\_ERR\_INVALID\_ARG: Delete RMT channel failed because of invalid argument
- ESP\_ERR\_INVALID\_STATE: Delete RMT channel failed because it is still in working
- ESP\_FAIL: Delete RMT channel failed because of other error

*esp\_err\_t* **rmt\_apply\_carrier** (*rmt\_channel\_handle\_t* channel, const *rmt\_carrier\_config\_t* \*config)

Apply modulation feature for TX channel or demodulation feature for RX channel.

**参数**

- **channel** -- [in] RMT generic channel that created by `rmt_new_tx_channel()` or `rmt_new_rx_channel()`
- **config** -- [in] Carrier configuration. Specially, a NULL config means to disable the carrier modulation or demodulation feature

**返回**

- ESP\_OK: Apply carrier configuration successfully
- ESP\_ERR\_INVALID\_ARG: Apply carrier configuration failed because of invalid argument
- ESP\_FAIL: Apply carrier configuration failed because of other error

*esp\_err\_t* **rmt\_enable**(*rmt\_channel\_handle\_t* channel)

Enable the RMT channel.

---

**备注:** This function will acquire a PM lock that might be installed during channel allocation

---

**参数** **channel** -- **[in]** RMT generic channel that created by `rmt_new_tx_channel()` or `rmt_new_rx_channel()`

**返回**

- ESP\_OK: Enable RMT channel successfully
- ESP\_ERR\_INVALID\_ARG: Enable RMT channel failed because of invalid argument
- ESP\_ERR\_INVALID\_STATE: Enable RMT channel failed because it's enabled already
- ESP\_FAIL: Enable RMT channel failed because of other error

*esp\_err\_t* **rmt\_disable**(*rmt\_channel\_handle\_t* channel)

Disable the RMT channel.

---

**备注:** This function will release a PM lock that might be installed during channel allocation

---

**参数** **channel** -- **[in]** RMT generic channel that created by `rmt_new_tx_channel()` or `rmt_new_rx_channel()`

**返回**

- ESP\_OK: Disable RMT channel successfully
- ESP\_ERR\_INVALID\_ARG: Disable RMT channel failed because of invalid argument
- ESP\_ERR\_INVALID\_STATE: Disable RMT channel failed because it's not enabled yet
- ESP\_FAIL: Disable RMT channel failed because of other error

**Structures**

struct **rmt\_carrier\_config\_t**

RMT carrier wave configuration (for either modulation or demodulation)

**Public Members**

uint32\_t **frequency\_hz**

Carrier wave frequency, in Hz, 0 means disabling the carrier

float **duty\_cycle**

Carrier wave duty cycle (0~100%)

uint32\_t **polarity\_active\_low**

Specify the polarity of carrier, by default it's modulated to base signal's high level

uint32\_t **always\_on**

If set, the carrier can always exist even there's not transfer undergoing

```
struct rmt_carrier_config_t::[anonymous] flags
    Carrier config flags
```

## Header File

- `components/esp_driver_rmt/include/driver/rmt_encoder.h`
- This header file can be included with:

```
#include "driver/rmt_encoder.h"
```

- This header file is a part of the API provided by the `esp_driver_rmt` component. To declare that your component depends on `esp_driver_rmt`, add the following to your `CMakeLists.txt`:

```
REQUIRES esp_driver_rmt
```

or

```
PRIV_REQUIRES esp_driver_rmt
```

## Functions

`esp_err_t rmt_new_bytes_encoder` (const *rmt\_bytes\_encoder\_config\_t* \*config, *rmt\_encoder\_handle\_t* \*ret\_encoder)

Create RMT bytes encoder, which can encode byte stream into RMT symbols.

### 参数

- **config** -- [in] Bytes encoder configuration
- **ret\_encoder** -- [out] Returned encoder handle

### 返回

- ESP\_OK: Create RMT bytes encoder successfully
- ESP\_ERR\_INVALID\_ARG: Create RMT bytes encoder failed because of invalid argument
- ESP\_ERR\_NO\_MEM: Create RMT bytes encoder failed because out of memory
- ESP\_FAIL: Create RMT bytes encoder failed because of other error

`esp_err_t rmt_bytes_encoder_update_config` (*rmt\_encoder\_handle\_t* bytes\_encoder, const *rmt\_bytes\_encoder\_config\_t* \*config)

Update the configuration of the bytes encoder.

---

**备注:** The configurations of the bytes encoder is also set up by `rmt_new_bytes_encoder()`. This function is used to update the configuration of the bytes encoder at runtime.

---

### 参数

- **bytes\_encoder** -- [in] Bytes encoder handle, created by e.g `rmt_new_bytes_encoder()`
- **config** -- [in] Bytes encoder configuration

### 返回

- ESP\_OK: Update RMT bytes encoder successfully
- ESP\_ERR\_INVALID\_ARG: Update RMT bytes encoder failed because of invalid argument
- ESP\_FAIL: Update RMT bytes encoder failed because of other error

`esp_err_t rmt_new_copy_encoder` (const *rmt\_copy\_encoder\_config\_t* \*config, *rmt\_encoder\_handle\_t* \*ret\_encoder)

Create RMT copy encoder, which copies the given RMT symbols into RMT memory.

### 参数

- **config** -- [in] Copy encoder configuration

• **ret\_encoder** -- [out] Returned encoder handle

返回

- ESP\_OK: Create RMT copy encoder successfully
- ESP\_ERR\_INVALID\_ARG: Create RMT copy encoder failed because of invalid argument
- ESP\_ERR\_NO\_MEM: Create RMT copy encoder failed because out of memory
- ESP\_FAIL: Create RMT copy encoder failed because of other error

*esp\_err\_t* **rmt\_new\_simple\_encoder** (const *rmt\_simple\_encoder\_config\_t* \*config, *rmt\_encoder\_handle\_t* \*ret\_encoder)

Create RMT simple callback encoder, which uses a callback to convert incoming data into RMT symbols.

参数

- **config** -- [in] Simple callback encoder configuration
- **ret\_encoder** -- [out] Returned encoder handle

返回

- ESP\_OK: Create RMT simple callback encoder successfully
- ESP\_ERR\_INVALID\_ARG: Create RMT simple callback encoder failed because of invalid argument
- ESP\_ERR\_NO\_MEM: Create RMT simple callback encoder failed because out of memory
- ESP\_FAIL: Create RMT simple callback encoder failed because of other error

*esp\_err\_t* **rmt\_del\_encoder** (*rmt\_encoder\_handle\_t* encoder)

Delete RMT encoder.

参数 **encoder** -- [in] RMT encoder handle, created by e.g *rmt\_new\_bytes\_encoder* ()

返回

- ESP\_OK: Delete RMT encoder successfully
- ESP\_ERR\_INVALID\_ARG: Delete RMT encoder failed because of invalid argument
- ESP\_FAIL: Delete RMT encoder failed because of other error

*esp\_err\_t* **rmt\_encoder\_reset** (*rmt\_encoder\_handle\_t* encoder)

Reset RMT encoder.

参数 **encoder** -- [in] RMT encoder handle, created by e.g *rmt\_new\_bytes\_encoder* ()

返回

- ESP\_OK: Reset RMT encoder successfully
- ESP\_ERR\_INVALID\_ARG: Reset RMT encoder failed because of invalid argument
- ESP\_FAIL: Reset RMT encoder failed because of other error

void \***rmt\_alloc\_encoder\_mem** (size\_t size)

A helper function to allocate a proper memory for RMT encoder.

参数 **size** -- Size of memory to be allocated

返回 Pointer to the allocated memory if the allocation is successful, NULL otherwise

## Structures

struct **rmt\_encoder\_t**

Interface of RMT encoder.

## Public Members

size\_t (\***encode**)(*rmt\_encoder\_t* \*encoder, *rmt\_channel\_handle\_t* tx\_channel, const void \*primary\_data, size\_t data\_size, *rmt\_encode\_state\_t* \*ret\_state)

Encode the user data into RMT symbols and write into RMT memory.



---

**备注:** The encoding function will also be called from an ISR context, thus the function must not call any blocking API.

---



---

**备注:** It's recommended to put this function implementation in the IRAM, to achieve a high performance and less interrupt latency.

---

**Param encoder [in]** Encoder handle  
**Param tx\_channel [in]** RMT TX channel handle, returned from `rmt_new_tx_channel()`  
**Param primary\_data [in]** App data to be encoded into RMT symbols  
**Param data\_size [in]** Size of `primary_data`, in bytes  
**Param ret\_state [out]** Returned current encoder's state  
**Return** Number of RMT symbols that the primary data has been encoded into

`esp_err_t (*reset)(rmt_encoder_t *encoder)`

Reset encoding state.

**Param encoder [in]** Encoder handle  
**Return**

- ESP\_OK: reset encoder successfully
- ESP\_FAIL: reset encoder failed

`esp_err_t (*del)(rmt_encoder_t *encoder)`

Delete encoder object.

**Param encoder [in]** Encoder handle  
**Return**

- ESP\_OK: delete encoder successfully
- ESP\_FAIL: delete encoder failed

struct **rmt\_bytes\_encoder\_config\_t**

Bytes encoder configuration.

### Public Members

`rmt_symbol_word_t bit0`

How to represent BIT0 in RMT symbol

`rmt_symbol_word_t bit1`

How to represent BIT1 in RMT symbol

`uint32_t msb_first`

Whether to encode MSB bit first

struct `rmt_bytes_encoder_config_t::[anonymous] flags`

Encoder config flag

struct **rmt\_copy\_encoder\_config\_t**

Copy encoder configuration.

struct **rmt\_simple\_encoder\_config\_t**

Simple callback encoder configuration.

### Public Members

*rmt\_encode\_simple\_cb\_t* **callback**

Callback to call for encoding data into RMT items

void \***arg**

Opaque user-supplied argument for callback

size\_t **min\_chunk\_size**

Minimum amount of free space, in RMT symbols, the encoder needs in order to guarantee it always returns non-zero. Defaults to 64 if zero / not given.

### Type Definitions

```
typedef size_t (rmt_encode_simple_cb_t)(const void *data, size_t data_size, size_t symbols_written, size_t symbols_free, rmt_symbol_word_t *symbols, bool *done, void *arg)
```

Callback for simple callback encoder.

This will get called to encode the data stream of given length (as passed to `rmt_transmit` by the user) into symbols to be sent by the hardware.

The callback will be initially called with `symbol_pos=0`. If the callback encodes `N` symbols and finishes, the next callback will always be with `symbols_written=N`. If the callback then encodes `M` symbols, the next callback will always be with `symbol_pos=N+M`, etc. The only exception is when the encoder is reset (e.g. to begin a new transaction) in which case `symbol_pos` will always restart at 0.

If the amount of free space in the symbol buffer (as indicated by `symbols_free`) is too low, the function can return 0 as result and the RMT will call the function again once there is more space available. Note that the callback should eventually return non-0 if called with free space of *rmt\_simple\_encoder\_config\_t:min\_chunk\_size* or more. It is acceptable to return 0 for a given free space `N`, then on the next call (possibly with a larger free buffer space) return less or more than `N` symbols.

When the transaction is done (all `data_size` data is encoded), the callback can indicate this by setting `*done` to true. This can either happen on the last callback call that returns an amount of symbols encoded, or on a callback that returns zero. In either case, the callback will not be called again for this transaction.

**Param data [in]** Data pointer, as passed to `rmt_transmit()`

**Param data\_size [in]** Size of the data, as passed to `rmt_transmit()`

**Param symbols\_written [in]** Current position in encoded stream, in symbols

**Param symbols\_free [in]** The maximum amount of symbols that can be written into the `symbols` buffer

**Param symbols [out]** Symbols to be sent to the RMT hardware

**Param done [out]** Setting this to true marks this transaction as finished

**Param arg** Opaque argument

**Return** Amount of symbols encoded in this callback round. 0 if more space is needed.

### Enumerations

enum **rmt\_encode\_state\_t**

RMT encoding state.

*Values:*

enumerator **RMT\_ENCODING\_RESET**

The encoding session is in reset state

enumerator **RMT\_ENCODING\_COMPLETE**

The encoding session is finished, the caller can continue with subsequent encoding

enumerator **RMT\_ENCODING\_MEM\_FULL**

The encoding artifact memory is full, the caller should return from current encoding session

### Header File

- [components/esp\\_driver\\_rmt/include/driver/rmt\\_types.h](#)
- This header file can be included with:

```
#include "driver/rmt_types.h"
```

- This header file is a part of the API provided by the `esp_driver_rmt` component. To declare that your component depends on `esp_driver_rmt`, add the following to your `CMakeLists.txt`:

```
REQUIRES esp_driver_rmt
```

or

```
PRIV_REQUIRES esp_driver_rmt
```

### Structures

struct **rmt\_tx\_done\_event\_data\_t**

Type of RMT TX done event data.

#### Public Members

size\_t **num\_symbols**

The number of transmitted RMT symbols, including one EOF symbol, which is appended by the driver to mark the end of a transmission. For a loop transmission, this value only counts for one round.

struct **rmt\_rx\_done\_event\_data\_t**

Type of RMT RX done event data.

#### Public Members

*rmt\_symbol\_word\_t* \***received\_symbols**

Point to the received RMT symbols

size\_t **num\_symbols**

The number of received RMT symbols

uint32\_t **is\_last**

Indicating if the current received data are the last part of the transaction

struct *rmt\_rx\_done\_event\_data\_t*::[anonymous] **flags**

Extra flags

## Type Definitions

```
typedef struct rmt_channel_t *rmt_channel_handle_t
```

Type of RMT channel handle.

```
typedef struct rmt_sync_manager_t *rmt_sync_manager_handle_t
```

Type of RMT synchronization manager handle.

```
typedef struct rmt_encoder_t *rmt_encoder_handle_t
```

Type of RMT encoder handle.

```
typedef bool (*rmt_tx_done_callback_t)(rmt_channel_handle_t tx_chan, const rmt_tx_done_event_data_t *edata, void *user_ctx)
```

Prototype of RMT event callback.

**Param tx\_chan [in]** RMT channel handle, created from `rmt_new_tx_channel()`

**Param edata [in]** Point to RMT event data. The lifecycle of this pointer memory is inside this function, user should copy it into static memory if used outside this function.

**Param user\_ctx [in]** User registered context, passed from `rmt_tx_register_event_callbacks()`

**Return** Whether a high priority task has been waken up by this callback function

```
typedef bool (*rmt_rx_done_callback_t)(rmt_channel_handle_t rx_chan, const rmt_rx_done_event_data_t *edata, void *user_ctx)
```

Prototype of RMT event callback.

**Param rx\_chan [in]** RMT channel handle, created from `rmt_new_rx_channel()`

**Param edata [in]** Point to RMT event data. The lifecycle of this pointer memory is inside this function, user should copy it into static memory if used outside this function.

**Param user\_ctx [in]** User registered context, passed from `rmt_rx_register_event_callbacks()`

**Return** Whether a high priority task has been waken up by this function

## Header File

- [components/hal/include/hal/rmt\\_types.h](#)
- This header file can be included with:

```
#include "hal/rmt_types.h"
```

## Unions

```
union rmt_symbol_word_t
```

*#include <rmt\_types.h>* The layout of RMT symbol stored in memory, which is decided by the hardware design.

## Public Members

```
uint16_t duration0
```

Duration of level0

```
uint16_t level0
```

Level of the first part

```
uint16_t duration1
```

Duration of level1

```
uint16_t level11
```

Level of the second part

```
struct rmt_symbol_word_t:[anonymous] [anonymous]
```

```
uint32_t val
```

Equivalent unsigned value for the RMT symbol

### Type Definitions

```
typedef soc_periph_rmt_clk_src_t rmt_clock_source_t
```

RMT group clock source.

---

**备注:** User should select the clock source based on the power and resolution requirement

---

## 2.6.21 SD SPI 主机驱动程序

### 概述

SD SPI 主机驱动程序支持使用 SPI 主控驱动程序与一或多张 SD 卡通信, SPI 主控驱动程序则利用 SPI 主机实现功能。每张 SD 卡都通过一个 SD SPI 设备访问, 相应设备以 SD SPI 设备句柄 `sdspi_dev_handle_t` 表示。调用 `sdspi_host_init_device()` 将设备连接到 SPI 总线上时会返回所需 SPI 设备句柄。注意, 在使用 SPI 总线前, 需要先通过 `spi_bus_initialize()` 初始化总线。

SD SPI 主机驱动程序基于 [SPI 主机驱动程序](#) 实现。借助 SPI 主控驱动程序, SD 卡及其他 SPI 设备可以共享同一 SPI 总线。SPI 主机驱动程序将处理来自不同任务的独占访问。

SD SPI 驱动程序使用受软件控制的 CS 信号。

### 使用方法

首先, 使用宏 `SDSPI_DEVICE_CONFIG_DEFAULT` 初始化结构体 `sdspi_device_config_t`, 该结构体用于初始化 SD SPI 设备。该宏还会填充默认的管脚映射, 与 SDMMC 主机驱动的管脚映射相同。随后根据需要, 修改结构体中的主机和管脚配置。然后调用 `sdspi_host_init_device` 初始化 SD SPI 设备, 并将其连接到所属的总线上。

接着, 使用宏 `SDSPI_HOST_DEFAULT` 初始化结构体 `sdmmc_host_t`, 该结构体用于存储上层 (SD/SDIO/MMC 驱动) 的状态和配置信息。将结构体中的 `slot` 参数设置为从 `sdspi_host_init_device` 返回的 SD SPI 设备的 SD SPI 句柄。使用 `sdmmc_host_t` 调用 `sdmmc_card_init`, 检测并初始化 SD 卡。

初始化完成后, 即可使用 SD/SDIO/MMC 驱动函数访问 SD 卡。

## 其他细节

通常，大多数应用程序仅使用驱动程序的以下 API 函数：

- `sdspi_host_init()`
- `sdspi_host_init_device()`
- `sdspi_host_remove_device()`
- `sdspi_host_deinit()`

对于其他函数，大多由协议层的 SD/SDIO/MMC 驱动程序通过 `sdmmc_host_t` 结构体中的函数指针使用。更多详情，请参阅 [SD/SDIO/MMC 驱动程序](#)。

**备注：** 由于 SPI 驱动程序的限制，SD 卡在通过 SPI 总线与主设备进行数据传输和通信时，速度不超过 `SDMMC_FREQ_DEFAULT`。

**警告：** 在 SD 卡之间以及其他 SPI 设备间共享 SPI 总线时，存在部分限制，详情请参阅 [SD 卡与其他 SPI 设备共享 SPI 总线](#)。

## 相关文档

### SD 卡与其他 SPI 设备共享 SPI 总线

SD 卡支持 SPI 模式，使其能够作为 SPI 设备通信，但使用时需注意其限制。

**其他设备的管脚负载** 向同一总线添加设备会增加管脚的整体负载，包括交流负载（管脚电容）和直流负载（上拉电阻）。

**交流负载** 在通信速率不超过 50 MHz 的情况下，专为高速通信设计的 SD 卡采用小型管脚电容（交流负载小）。但在同一 SPI 总线上连接其他设备后，会增加管脚的交流负载。

管脚交流负载过高时，可能无法实现电平快速切换。通过使用示波器，你可以观察到管脚状态变化的边缘变得更加平滑，即边缘变化率更低。当 SD 卡连接到交流负载较高的总线时，可能无法满足 SD 卡建立时间 (setup) 的时序要求。高交流负载甚至可能导致 SD 卡和其他 SPI 设备无法正确解析主机发出的时钟信号，影响通信稳定性。

如果连接的其他设备的工作频率与 SD 卡工作频率不同，上述问题可能会更加明显。这是因为其他设备可能具有更大的管脚电容。管脚容量越大，响应时间越长，SD 总线可工作的最高频率越低。

你可以尝试以下测试，判断管脚交流负载是否过重：

术语

- **启动边沿 (launch edge)：** 数据开始切换的时钟边沿；
- **锁存边沿 (latch edge)：** 数据接收侧应进行数据采样的时钟边沿，对 SD 卡来说是上升沿。

1. 使用示波器观察时钟，并比较数据线与时钟。

- 如果时钟不够快，例如上升/下降沿长于时钟周期的 1/4，表明时钟偏斜过大。
- 如果在时钟锁存边沿之前数据线不稳定，表明数据线负载过大。

借助逻辑分析仪，也可以观察到数据与时钟启动沿相比，延迟较大。但比起用示波器，用逻辑分析仪观察到的现象可能不太明显。

2. 尝试使用较低的时钟频率。

如果设备可以在较低的通信频率下正常工作，而在较高的通信频率下出现问题，说明管脚交流负载过大。

如果管脚的交流负载过大，你可以选择使用其他管脚负载更低但通信速度更快的设备，或降低时钟速度。

**直流负载** SD 卡所需的上拉电阻通常在 10 kΩ 至 50 kΩ 之间，注意对某些 SPI 设备来说，这可能是过强的上拉电阻。

请查阅设备的规格说明书，了解其直流输出电流。此直流输出电流应大于 700 μA，否则可能无法正确读取设备输出。

### 初始化顺序

**备注：**如果在执行以下步骤时遇到任何问题，请首先确保时序正确。如前文所述，你可以尝试降低时钟速度，例如将 SD 卡的 `SDMMC_FREQ_PROBING` 设置为 400 kHz，排除管脚交流负载的影响。

在同一 SPI 总线上与其他 SPI 设备一起使用 SD 卡时，由于 SD 卡启动流程的限制，应遵循以下初始化顺序。有关详情，请参阅 [storage/sd\\_card](#)。

1. 通过 `spi_bus_initialize()` 正确初始化总线。
2. 将除 SD 卡外所有设备的 CS 线置为空闲状态（默认为高电平），避免在后续步骤中与 SD 卡发生冲突。

这可以通过以下任一方式实现：

1. 调用 `spi_bus_add_device()` 将设备连接到 SPI 总线，该函数将初始化用作 CS 的 GPIO 管脚到空闲电平：默认为高电平。
2. 在添加新设备前，初始化需要拉高的 CS 管脚 GPIO。
3. 在 ESP 的 GPIO 未初始化前，依靠内部/外部上拉电阻拉高所有 CS 管脚（**不推荐**）。请确保上拉电阻拥有足够强度，且没有其他下拉电阻影响拉高。例如，应启用内部下拉电阻。
3. 调用 `esp_vfs_fat_sdspi_mount()` 将卡挂载到文件系统。  
此步骤将使 SD 卡进入 SPI 模式，**应该**在同一总线上的所有其他 SPI 通信前完成。否则，SD 卡会保持在 SD 模式，即使在未选中其 CS 线的情况下，SD 卡也可能随机响应总线上的任何 SPI 通信。如果你想测试这种行为，请注意，一旦 SD 卡置于 SPI 模式，在下次上电前，也就是断电后重新上电之前，SD 卡将不会返回 SD 模式
4. 此时，即可与其他 SPI 设备自由通信。

## API 参考

### Header File

- `components/esp_driver_sdspi/include/driver/sdspi_host.h`
- This header file can be included with:

```
#include "driver/sdspi_host.h"
```

- This header file is a part of the API provided by the `esp_driver_sdspi` component. To declare that your component depends on `esp_driver_sdspi`, add the following to your `CMakeLists.txt`:

```
REQUIRES esp_driver_sdspi
```

or

```
PRIV_REQUIRES esp_driver_sdspi
```

### Functions

`esp_err_t sdspi_host_init` (void)

Initialize SD SPI driver.

**备注：** This function is not thread safe

### 返回

- `ESP_OK` on success
- other error codes may be returned in future versions

---

*esp\_err\_t* **sdspi\_host\_init\_device** (const *sdspi\_device\_config\_t* \*dev\_config, *sdspi\_dev\_handle\_t* \*out\_handle)

Attach and initialize an SD SPI device on the specific SPI bus.

---

**备注:** This function is not thread safe

---



---

**备注:** Initialize the SPI bus by `spi_bus_initialize()` before calling this function.

---



---

**备注:** The SDIO over sdspi needs an extra interrupt line. Call `gpio_install_isr_service()` before this function.

---

#### 参数

- **dev\_config** -- pointer to device configuration structure
- **out\_handle** -- Output of the handle to the sdspi device.

#### 返回

- ESP\_OK on success
- ESP\_ERR\_INVALID\_ARG if `sdspi_host_init_device` has invalid arguments
- ESP\_ERR\_NO\_MEM if memory can not be allocated
- other errors from the underlying `spi_master` and `gpio` drivers

*esp\_err\_t* **sdspi\_host\_remove\_device** (*sdspi\_dev\_handle\_t* handle)

Remove an SD SPI device.

**参数** **handle** -- Handle of the SD SPI device

**返回** Always ESP\_OK

*esp\_err\_t* **sdspi\_host\_do\_transaction** (*sdspi\_dev\_handle\_t* handle, *sdmmc\_command\_t* \*cmdinfo)

Send command to the card and get response.

This function returns when command is sent and response is received, or data is transferred, or timeout occurs.

---

**备注:** This function is not thread safe w.r.t. `init/deinit` functions, and bus width/clock speed configuration functions. Multiple tasks can call `sdspi_host_do_transaction` as long as other `sdspi_host_*` functions are not called.

---

#### 参数

- **handle** -- Handle of the sdspi device
- **cmdinfo** -- pointer to structure describing command and data to transfer

#### 返回

- ESP\_OK on success
- ESP\_ERR\_TIMEOUT if response or data transfer has timed out
- ESP\_ERR\_INVALID\_CRC if response or data transfer CRC check has failed
- ESP\_ERR\_INVALID\_RESPONSE if the card has sent an invalid response

*esp\_err\_t* **sdspi\_host\_set\_card\_clk** (*sdspi\_dev\_handle\_t* host, *uint32\_t* freq\_khz)

Set card clock frequency.

Currently only integer fractions of 40MHz clock can be used. For High Speed cards, 40MHz can be used. For Default Speed cards, 20MHz can be used.

---

**备注:** This function is not thread safe

---



**参数**

- **host** -- Handle of the sdspi device
- **freq\_khz** -- card clock frequency, in kHz

**返回**

- ESP\_OK on success
- other error codes may be returned in the future

*esp\_err\_t* **sdspi\_host\_get\_real\_freq**(*sdspi\_dev\_handle\_t* handle, int \*real\_freq\_khz)

Calculate working frequency for specific device.

**参数**

- **handle** -- SDSPI device handle
- **real\_freq\_khz** -- [out] output parameter to hold the calculated frequency (in kHz)

**返回**

- ESP\_ERR\_INVALID\_ARG : handle is NULL or invalid or real\_freq\_khz parameter is NULL
- ESP\_OK : Success

*esp\_err\_t* **sdspi\_host\_deinit**(void)

Release resources allocated using sdspi\_host\_init.

---

**备注:** This function is not thread safe

---

**返回**

- ESP\_OK on success
- ESP\_ERR\_INVALID\_STATE if sdspi\_host\_init function has not been called

*esp\_err\_t* **sdspi\_host\_io\_int\_enable**(*sdspi\_dev\_handle\_t* handle)

Enable SDIO interrupt.

**参数** **handle** -- Handle of the sdspi device

**返回**

- ESP\_OK on success

*esp\_err\_t* **sdspi\_host\_io\_int\_wait**(*sdspi\_dev\_handle\_t* handle, TickType\_t timeout\_ticks)

Wait for SDIO interrupt until timeout.

**参数**

- **handle** -- Handle of the sdspi device
- **timeout\_ticks** -- Ticks to wait before timeout.

**返回**

- ESP\_OK on success

*esp\_err\_t* **sdspi\_host\_get\_dma\_info**(int slot, esp\_dma\_mem\_info\_t \*dma\_mem\_info)

Get the DMA memory information for the host driver.

**参数**

- **slot** -- [in] Not used
- **dma\_mem\_info** -- [out] DMA memory information structure

**返回**

- ESP\_OK: ON success.
- ESP\_ERR\_INVALID\_ARG: Invalid argument.

**Structures**

struct **sdspi\_device\_config\_t**

Extra configuration for SD SPI device.

## Public Members

*spi\_host\_device\_t* **host\_id**

SPI host to use, SPIx\_HOST (see spi\_types.h).

gpio\_num\_t **gpio\_cs**

GPIO number of CS signal.

gpio\_num\_t **gpio\_cd**

GPIO number of card detect signal.

gpio\_num\_t **gpio\_wp**

GPIO number of write protect signal.

gpio\_num\_t **gpio\_int**

GPIO number of interrupt line (input) for SDIO card.

bool **gpio\_wp\_polarity**

GPIO write protect polarity 0 means "active low", i.e. card is protected when the GPIO is low; 1 means "active high", i.e. card is protected when GPIO is high.

## Macros

**SDSPI\_DEFAULT\_HOST**

**SDSPI\_DEFAULT\_DMA**

**SDSPI\_HOST\_DEFAULT ()**

Default sdmmc\_host\_t structure initializer for SD over SPI driver.

Uses SPI mode and max frequency set to 20MHz

'slot' should be set to an sdspi device initialized by `sdspi_host_init_device ()`.

**SDSPI\_SLOT\_NO\_CS**

indicates that card select line is not used

**SDSPI\_SLOT\_NO\_CD**

indicates that card detect line is not used

**SDSPI\_SLOT\_NO\_WP**

indicates that write protect line is not used

**SDSPI\_SLOT\_NO\_INT**

indicates that interrupt line is not used

**SDSPI\_IO\_ACTIVE\_LOW**

**SDSPI\_DEVICE\_CONFIG\_DEFAULT ()**

Macro defining default configuration of SD SPI device.

## Type Definitions

```
typedef int sdspi_dev_handle_t
    Handle representing an SD SPI device.
```

## 2.6.22 Sigma-Delta 调制器 (SDM)

### 简介

ESP32-H2 具备二阶 Sigma-Delta 调制器，可以为多个通道生成独立的脉冲密度调制 (PDM) 脉冲。请参阅技术参考手册，查看可用的硬件通道数量。<sup>1</sup>

Sigma-Delta 调制器可以将模拟电压信号转换为脉冲频率或脉冲密度，该过程称为脉冲密度调制 (PDM) (请参阅 [维基百科上有关 Sigma-Delta 调制的介绍](#))。

与 I2S 外设中的 PDM 模式和数模转换器 (DAC) 相比，SDM 中的 PDM 主要有以下特点：

1. SDM 没有时钟信号，类似于 PDM 的 DAC 模式；
2. SDM 没有 DMA 支持，无法持续改变其输出密度。如果需要改变 SDM 的输出密度，可以在定时器的回调函数中进行操作；
3. 基于以上两点，不同于 DAC，要还原模拟波形，还必须使用外部的有源或无源低通滤波器，详情请参阅 [转换为模拟信号 \(可选\)](#)。

Sigma-Delta 调制通道通常应用于以下场景：

- LED 调光
- 使用有源 RC 低通滤波器，实现简单的数模转换（8 位分辨率）
- 结合半桥或全桥回路，以及 LC 低通滤波器，实现 D 级功率放大

### 功能概述

下文将分节概述安装和操作 SDM 通道的一般步骤：

- [资源分配](#) - 介绍如何初始化和配置 SDM 通道，以及在通道完成任务后如何回收相关资源。
- [启用和禁用通道](#) - 介绍如何启用和禁用 SDM 通道。
- [设置脉冲密度](#) - 介绍如何设置 PDM 脉冲的等效占空比。
- [电源管理](#) - 介绍不同时钟源对功耗的影响。
- [IRAM 安全](#) - 介绍禁用 cache 时仍可使用的功能。
- [线程安全](#) - 介绍由驱动程序认证为线程安全的 API。
- [Kconfig 选项](#) - 介绍 SDM 驱动程序支持的各种 Kconfig 选项，这些选项可以给驱动程序的行为造成不同影响。

**资源分配** 在 ESP-IDF 中，SDM 通道的信息和属性通过特定的数据结构进行管理和访问，该数据结构表示为 `sdm_channel_handle_t`。每个通道都可以输出由硬件生成的二进制信号，且这些信号都经过 Sigma-Delta 调制。所有可用通道均存放在资源池中，由驱动程序管理，无需手动将固定通道分配给 GPIO。

要安装 SDM 通道，请调用 `sdm_new_channel()` 获取通道句柄。通道的具体配置信息由结构体 `sdm_config_t` 传递。

- `sdm_config_t::gpio_num` 设置 PDM 脉冲输出的 GPIO 管脚号。
- `sdm_config_t::clk_src` 选择 SDM 模块的时钟源。注意，所有通道选择的时钟源应保持一致。
- `sdm_config_t::sample_rate_hz` 设置 SDM 模块的采样率。
- `sdm_config_t::invert_out` 设置是否反转输出信号。

<sup>1</sup> 不同的 ESP 芯片系列可能具有不同数量的 SDM 通道，请参阅 ESP32-H2 技术参考手册中的 [GPIO 和 IOMUX](#) 章节，了解更多详情。驱动程序对通道申请数量不做限制，但当硬件资源用尽时，驱动程序将返回错误。因此，每次进行通道分配（如调用 `sdm_new_channel()`）时，请注意检查返回值。

- `sdm_config_t::io_loop_back` 通过 GPIO 矩阵外设，启用 GPIO 的输入和输出功能。注意，该字段仅供调试使用。

函数 `sdm_new_channel()` 可能因为各种原因失败，如内存不足、参数无效等。当缺少空闲通道（即所有的硬件 SDM 通道均在使用中）时，将返回 `ESP_ERR_NOT_FOUND`。

SDM 通道完成任务后，请调用 `sdm_del_channel()` 回收相应资源，以便底层硬件通道用于其他目的。在删除 SDM 通道句柄前，请通过 `sdm_channel_disable()` 禁用要删除的通道，或确保该通道尚未由 `sdm_channel_enable()` 启用，再继续删除操作。

### 创建采样率为 1 MHz 的 SDM 通道

```
sdm_channel_handle_t chan = NULL;
sdm_config_t config = {
    .clk_src = SDM_CLK_SRC_DEFAULT,
    .sample_rate_hz = 1 * 1000 * 1000,
    .gpio_num = 0,
};
ESP_ERROR_CHECK(sdm_new_channel(&config, &chan));
```

**启用和禁用通道** 在对 SDM 通道进行进一步的 IO 控制之前，需要先调用 `sdm_channel_enable()` 启用通道。在内部，该函数实现了以下操作：

- 将通道状态从 **init** 切换到 **enable**
- 如果选择了特定时钟源（如 APB 锁），则会获取合适的电源管理锁。要了解更多信息，请参阅 [电源管理](#)。

调用 `sdm_channel_disable()` 则执行相反操作，即将通道恢复到 **init** 状态，并释放电源管理锁。

**设置脉冲密度** 在 PDM 中，脉冲密度决定了低通滤波器转换后的输出模拟电压，该模拟电压可以通过公式  $V_{out} = VDD_{IO} / 256 * duty + VDD_{IO} / 2$  计算。使用函数 `sdm_channel_set_pulse_density()` 时，需要传入一个名为 `density` 的参数。这个参数是一个整数值，范围在 -128 到 127 之间，表示一个 8 位有符号整数。根据 `density` 参数的不同取值，输出信号的占空比也会相应改变。例如，如果将 `density` 参数设置为零，输出信号的占空比约为 50%。

**电源管理** 启用电源管理（即启用 `CONFIG_PM_ENABLE`）时，在进入 Light-sleep 模式前，系统会调整 APB 频率，这可能会改变 Sigma-Delta 调制器的采样率。

但是，通过获取类型为 `ESP_PM_APB_FREQ_MAX` 的电源管理锁，驱动程序可以防止系统改变 APB 频率。每当驱动程序创建 SDM 通道，且该通道选择 `SDM_CLK_SRC_APB` 作为其时钟源时，在通过 `sdm_channel_enable()` 启用通道的过程中，驱动程序会确保获取类型为 `ESP_PM_APB_FREQ_MAX` 的电源管理锁。反之，调用 `sdm_channel_disable()` 禁用通道时，驱动程序释放该锁。

**IRAM 安全** Kconfig 选项 `CONFIG_SDM_CTRL_FUNC_IN_IRAM` 支持将常用的 IO 控制函数存放在 IRAM 中，以保证在禁用 cache 时可以正常使用函数。IO 控制函数如下所示：

- `sdm_channel_set_pulse_density()`

**线程安全** 驱动程序会确保工厂函数 `sdm_new_channel()` 的线程安全，使用时，可以直接从不同的 RTOS 任务中调用此类函数，无需额外锁保护。

驱动程序设置了临界区，以防函数同时在任务和 ISR 中调用。因此，以下函数支持在 ISR 上下文运行：

- `sdm_channel_set_pulse_density()`

其他以 `sdm_channel_handle_t` 作为第一个位置参数的函数均非线程安全，因此应避免从多个任务中调用这类函数。

### Kconfig 选项

- `CONFIG_SDM_CTRL_FUNC_IN_IRAM` 控制 SDM 通道控制函数的存放位置 (IRAM 或 flash)。更多信息请参阅 [IRAM 安全](#)。
- `CONFIG_SDM_ENABLE_DEBUG_LOG` 用于启用调试日志输出。启用此选项将增加固件的二进制文件大小。

### 转换为模拟信号 (可选)

一般而言, Sigma-Delta 信号连接到 LED 用来调节明暗时, 无需在信号和 LED 之间添加滤波器, 因为人眼本身对光强变化有低通滤波作用。但是, 如果你想测量实际电压, 或观察模拟波形, 就需要设计一个模拟低通滤波器。此外, 建议使用有源滤波器, 相较于无源滤波器, 有源滤波器在处理信号时具有更强的抗干扰性, 且损失的电压较少。

请参阅如下示例 [Sallen-Key 拓扑低通滤波器](#), 了解滤波器的相关知识。



图 24: Sallen-Key 拓扑低通滤波器

### 应用示例

- 使用 Sigma-Delta 调制的 100 Hz 正弦波: [peripherals/sigma\\_delta/sdm\\_dac](#)。
- 使用 Sigma-Delta 调制、并由 GPIO 驱动的 LED: [peripherals/sigma\\_delta/sdm\\_led](#)。

### API 参考

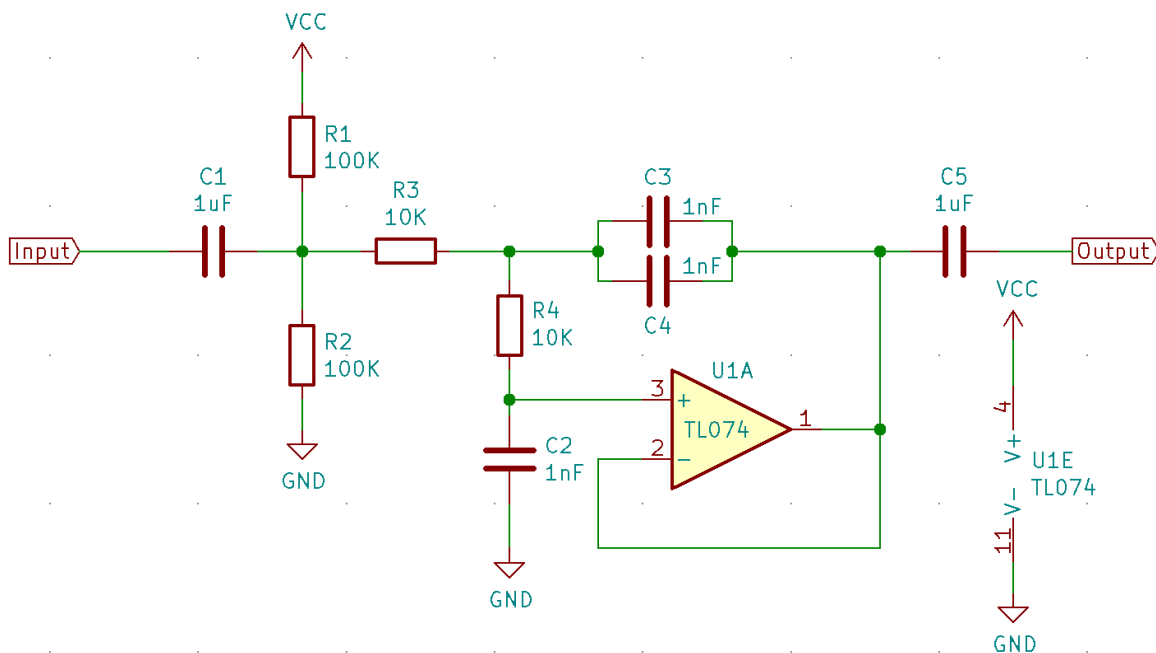
#### Header File

- `components/esp_driver_sdm/include/driver/sdm.h`
- This header file can be included with:

```
#include "driver/sdm.h"
```

- This header file is a part of the API provided by the `esp_driver_sdm` component. To declare that your component depends on `esp_driver_sdm`, add the following to your `CMakeLists.txt`:

```
REQUIRES esp_driver_sdm
```

or

```
PRIV_REQUIRES esp_driver_sdm
```

## Functions

*esp\_err\_t* **sdm\_new\_channel** (const *sdm\_config\_t* \*config, *sdm\_channel\_handle\_t* \*ret\_chan)

Create a new Sigma Delta channel.

### 参数

- **config** -- [in] SDM configuration
- **ret\_chan** -- [out] Returned SDM channel handle

### 返回

- ESP\_OK: Create SDM channel successfully
- ESP\_ERR\_INVALID\_ARG: Create SDM channel failed because of invalid argument
- ESP\_ERR\_NO\_MEM: Create SDM channel failed because out of memory
- ESP\_ERR\_NOT\_FOUND: Create SDM channel failed because all channels are used up and no more free one
- ESP\_FAIL: Create SDM channel failed because of other error

*esp\_err\_t* **sdm\_del\_channel** (*sdm\_channel\_handle\_t* chan)

Delete the Sigma Delta channel.

参数 **chan** -- [in] SDM channel created by `sdm_new_channel`

### 返回

- ESP\_OK: Delete the SDM channel successfully
- ESP\_ERR\_INVALID\_ARG: Delete the SDM channel failed because of invalid argument
- ESP\_ERR\_INVALID\_STATE: Delete the SDM channel failed because the channel is not in init state
- ESP\_FAIL: Delete the SDM channel failed because of other error

*esp\_err\_t* **sdm\_channel\_enable** (*sdm\_channel\_handle\_t* chan)

Enable the Sigma Delta channel.

---

备注: This function will transit the channel state from init to enable.

---



---

备注: This function will acquire a PM lock, if a specific source clock (e.g. APB) is selected in the *sdm\_config\_t*, while `CONFIG_PM_ENABLE` is enabled.

---

参数 **chan** -- [in] SDM channel created by `sdm_new_channel`

### 返回

- ESP\_OK: Enable SDM channel successfully
- ESP\_ERR\_INVALID\_ARG: Enable SDM channel failed because of invalid argument
- ESP\_ERR\_INVALID\_STATE: Enable SDM channel failed because the channel is already enabled
- ESP\_FAIL: Enable SDM channel failed because of other error

*esp\_err\_t* **sdm\_channel\_disable** (*sdm\_channel\_handle\_t* chan)

Disable the Sigma Delta channel.

---

备注: This function will do the opposite work to the `sdm_channel_enable()`

---

参数 **chan** -- [in] SDM channel created by `sdm_new_channel`

**返回**

- ESP\_OK: Disable SDM channel successfully
- ESP\_ERR\_INVALID\_ARG: Disable SDM channel failed because of invalid argument
- ESP\_ERR\_INVALID\_STATE: Disable SDM channel failed because the channel is not enabled yet
- ESP\_FAIL: Disable SDM channel failed because of other error

*esp\_err\_t* **sdm\_channel\_set\_pulse\_density** (*sdm\_channel\_handle\_t* chan, int8\_t density)

Set the pulse density of the PDM output signal.

---

**备注:** The raw output signal requires a low-pass filter to restore it into analog voltage, the restored analog output voltage could be  $V_{out} = VDD_{IO} / 256 * density + VDD_{IO} / 2$

---

---

**备注:** This function is allowed to run within ISR context

---

---

**备注:** This function will be placed into IRAM if CONFIG\_SDM\_CTRL\_FUNC\_IN\_IRAM is on, so that it's allowed to be executed when Cache is disabled

---

**参数**

- **chan** -- [in] SDM channel created by `sdm_new_channel`
- **density** -- [in] Quantized pulse density of the PDM output signal, ranges from -128 to 127. But the range of [-90, 90] can provide a better randomness.

**返回**

- ESP\_OK: Set pulse density successfully
- ESP\_ERR\_INVALID\_ARG: Set pulse density failed because of invalid argument
- ESP\_FAIL: Set pulse density failed because of other error

*esp\_err\_t* **sdm\_channel\_set\_duty** (*sdm\_channel\_handle\_t* chan, int8\_t duty)

The alias function of `sdm_channel_set_pulse_density`, it decides the pulse density of the output signal.

---

**备注:** `sdm_channel_set_pulse_density` has a more appropriate name compare this alias function, suggest to turn to `sdm_channel_set_pulse_density` instead

---

**参数**

- **chan** -- [in] SDM channel created by `sdm_new_channel`
- **duty** -- [in] Actually it's the quantized pulse density of the PDM output signal

**返回**

- ESP\_OK: Set duty cycle successfully
- ESP\_ERR\_INVALID\_ARG: Set duty cycle failed because of invalid argument
- ESP\_FAIL: Set duty cycle failed because of other error

**Structures**

struct **sdm\_config\_t**

Sigma Delta channel configuration.

**Public Members**

int **gpio\_num**

GPIO number

*sdm\_clock\_source\_t* **clk\_src**

Clock source

uint32\_t **sample\_rate\_hz**

Over sample rate in Hz, it determines the frequency of the carrier pulses

uint32\_t **invert\_out**

Whether to invert the output signal

uint32\_t **io\_loop\_back**

For debug/test, the signal output from the GPIO will be fed to the input path as well

struct *sdm\_config\_t*::[anonymous] **flags**

Extra flags

### Type Definitions

typedef struct *sdm\_channel\_t* \***sdm\_channel\_handle\_t**

Type of Sigma Delta channel handle.

### Header File

- [components/hal/include/hal/sdm\\_types.h](#)
- This header file can be included with:

```
#include "hal/sdm_types.h"
```

### Type Definitions

typedef *soc\_periph\_sdm\_clk\_src\_t* **sdm\_clock\_source\_t**

## 2.6.23 SPI flash API

### 概述

*spi\_flash* 组件提供外部 flash 数据读取、写入、擦除和内存映射相关的 API 函数。

关于更多高层次的用于访问分区（分区表定义于分区表）的 API 函数，参见分区 API。

---

**备注：**访问主 flash 芯片时，建议使用上述 *esp\_partition\_\** API 函数，而非低层级的 *esp\_flash\_\** API 函数。分区表 API 函数根据存储在分区表中的数据，进行边界检查并计算在 flash 中的正确偏移量。不过，仍支持使用 *esp\_flash\_\** 函数直接访问外部（额外）的 SPI flash 芯片。

---

与 ESP-IDF v4.0 之前的 API 不同，这一版 *esp\_flash\_\** API 功能并不局限于主 SPI flash 芯片（即运行程序的 SPI flash 芯片）。通过使用不同的芯片指针，可以访问连接到 SPI0/1 或 SPI2 总线的外部 flash 芯片。



**备注：**大多数 `esp_flash_*` API 使用 SPI1, SPI2 等外设而非通过 SPI0 上的 cache。这使得它们不仅能访问主 flash, 也能访问外部 flash。

而由于 cache 的限制, 所有经过 cache 的操作都只能对主 flash 进行。这些操作的地址同样受到 cache 能力的限制。Cache 无法访问外部 flash 或者高于它能力的地址段。这些 cache 操作包括: mmap、加密读写、执行代码或者访问在 flash 中的变量。

---

**备注：**ESP-IDF v4.0 之后的 flash API 不再是原子的。因此, 如果读操作执行过程中发生写操作, 且读操作和写操作的 flash 地址出现重叠, 读操作返回的数据可能会包含旧数据和新数据 (新数据为写操作更新产生的数据)。

---

**备注：**仅有主 flash 芯片支持加密操作, 外接 (经 SPI1 使用其他不同片选访问, 或经其它 SPI 总线访问) 的 flash 芯片则不支持加密操作。硬件的限制也决定了仅有主 flash 支持从 cache 当中读取。

---

### flash 功能支持情况

**支持的 flash 列表** 不同厂家的 flash 特性有不同的操作方式, 因此需要特殊的驱动支持。当前驱动支持大多数厂家 flash 24 位地址范围内的快速/慢速读, 以及二线模式 (DIO/DOOUT), 因为他们不需要任何厂家的自定义命令。

当前驱动支持以下厂家/型号的 flash 的四线模式 (QIO/QOUT):

1. ISSI
2. GD
3. MXIC
4. FM
5. Winbond
6. XMC
7. BOYA

**备注：**只有 ESP32-H2 支持上述某个 flash 时, 芯片的驱动才默认支持这款 flash。可使用 `menuconfig` 中的 `Component config > SPI flash driver > Auto-detect flash chips` 选项来使能/禁用某个 flash。

---

### flash 可选的功能

**Optional Features for Flash** Some features are not supported on all ESP chips and Flash chips. You can check the list below for more information.

- *Auto Suspend & Resume*
- *Flash unique ID*
- *High Performance Mode of QSPI Flash Chips*
- *32-bit Address Support of QSPI Flash Chips*
- *OPI Flash Support*

**备注：**When Flash optional features listed in this page are used, aside from the capability of ESP chips, and ESP-IDF version you are using, you will also need to make sure these features are supported by flash chips used.

- If you are using an official Espressif modules/SiP. Some of the modules/SiPs always support the feature, in this case you can see these features listed in the datasheet. Otherwise please contact [Espressif's business team](#) to know if we can supply such products for you.

- If you are making your own modules with your own bought flash chips, and you need features listed above. Please contact your vendor if they support the those features, and make sure that the chips can be supplied continuously.
- 

**注意:** This document only shows that ESP-IDF code has supported the features of those flash chips. It is not a list of stable flash chips certified by Espressif. If you build your own hardware from flash chips with your own brought flash chips (even with flash listed in this page), you need to validate the reliability of flash chips yourself.

**Auto Suspend & Resume** This feature is only supported on ESP32-S3, ESP32-C2, ESP32-C3, ESP32-C6, ESP32-H2 for now.

The support for ESP32-P4 may be added in the future.

List of Flash chips that support this feature:

1. XM25QxxC series.
2. GD25QxxE series.
3. FM25Q32

**注意:** There are multiple limitations about the auto-suspend feature, please do read [flash 自动暂停功能](#) for more information before you enable this feature.

**Flash Unique ID** This feature is supported on all Espressif chips.

Unique ID is not flash id, which means flash has 64-Bit unique ID for each device. The instruction to read the unique ID (4Bh) accesses a factory-set read-only 64-bit number that is unique to each flash device. This ID number helps you to recognize each single device. Not all flash vendors support this feature. If you try to read the unique ID on a chip which does not have this feature, the behavior is not determined. The support list is as follows.

List of Flash chips that support this feature:

1. ISSI
2. GD
3. TH
4. FM
5. Winbond
6. XMC
7. BOYA

**High Performance Mode of QSPI Flash Chips** This featurer is only supported on ESP32-S3 for now.

The support for ESP32-S2, ESP32-C3, ESP32-C6, ESP32-H2, ESP32-P4 may be added in the future.

---

**备注:** This section is provided for QSPI flash chips. Octal flash used on ESP-chips support High performance mode by default so far, please refer to the [OPI Flash Support](#) for the list of supported octal flash chips.

---

**32-bit Address Support of QSPI Flash Chips** This feature is supported on all Espressif chips (see restrictions to application below).

---

**备注:** This section is provided for QSPI flash chips. The 32-bit address support of Octal Flash chips are considered as part of the Octal flash support. Please refer to the [OPI Flash Support](#) for the list of supported octal flash chips.

---

Most NOR flash chips used by Espressif chips use 24-bits address, which can cover 16 MBytes memory. However, for larger memory (usually equal to or larger than 32 MBytes), flash uses a 32-bits address to address memory region higher than 16 MBytes. Unfortunately, 32-bits address chips have vendor-specific commands, so we need to support the chips one by one.

List of Flash chips that support this feature:

1. W25Q256
2. GD25Q256

### Restrictions

**重要:** Over 16 MBytes space on flash mentioned above can be only used for data saving, like file system.

Mapping data/instructions to 32-bit physical address space (so as to be accessed by the CPU) needs the support of MMU. However ESP32-H2 doesn't support this feature. Only ESP32-S3 supports this up to now.

---

**OPI Flash Support** This feature is only supported on ESP32-S3 for now.

OPI flash means that the flash chip supports octal peripheral interface, which has octal I/O pins. Different octal flash has different configurations and different commands. Hence, it is necessary to carefully check the support list.

有一些功能可能不是所有的 flash 芯片都支持，或不是所有的 ESP 芯片都支持。这些功能包括：

- 32 比特地址的 flash 支持 - 通常意味着拥有大于 16 MB 内存空间的大容量 flash 需要更长的地址去访问。
- flash 的私有 ID (unique ID) - 表示 flash 支持它自己的 64-bit 独有 ID。
- 暂停与恢复 - 表示 flash 可以在读/写的过程中接受暂停/恢复的命令。ESP32-H2 可以在 flash 正在写/擦除的过程中保持 cache 开启，并能随机读取 flash 中的内容。

如果想使用这些功能，则需保证 ESP32-H2 支持这些功能，且产品里所使用的 flash 芯片也要支持这些功能。请参阅 [Optional Features for Flash](#)，查看更多信息。

也可以自定义 flash 芯片驱动。请参阅 [Overriding Default Chip Drivers](#)，查看详细信息。

**警告:** Customizing SPI Flash Chip Drivers is considered an "expert" feature. Users should only do so at their own risk. (See the notes below)

**Overriding Default Chip Drivers** During the SPI Flash driver's initialization (i.e., `esp_flash_init()`), there is a chip detection step during which the driver iterates through a Default Chip Driver List and determine which chip driver can properly support the currently connected flash chip. The Default Chip Drivers are provided by the ESP-IDF, thus are updated in together with each ESP-IDF version. However ESP-IDF also allows users to customize their own chip drivers.

Users should note the following when customizing chip drivers:

1. You may need to rely on some non-public ESP-IDF functions, which have slight possibility to change between ESP-IDF versions. On the one hand, these changes may be useful bug fixes for your driver, on the other hand, they may also be breaking changes (i.e., breaks your code).
2. Some ESP-IDF bug fixes to other chip drivers are not automatically applied to your own custom chip drivers.
3. If the protection of flash is not handled properly, there may be some random reliability issues.
4. If you update to a newer ESP-IDF version that has support for more chips, you will have to manually add those new chip drivers into your custom chip driver list. Otherwise the driver will only search for the drivers in custom list you provided.

## Steps For Creating Custom Chip Drivers and Overriding the ESP-IDF Default Driver List

1. Enable the `CONFIG_SPI_FLASH_OVERRIDE_CHIP_DRIVER_LIST` config option. This prevents compilation and linking of the Default Chip Driver List (`default_registered_chips`) provided by ESP-IDF. Instead, the linker searches for the structure of the same name (`default_registered_chips`) that must be provided by the user.
2. Add a new component in your project, e.g., `custom_chip_driver`.
3. Copy the necessary chip driver files from the `spi_flash` component in ESP-IDF. This may include:
  - `spi_flash_chip_drivers.c` (to provide the `default_registered_chips` structure)
  - Any of the `spi_flash_chip_*.c` files that matches your own flash model best
  - `CMakeLists.txt` and `linker.lf` files

Modify the files above properly. Including:

- Change the `default_registered_chips` variable to non-static and remove the `#ifdef` logic around it.
- Update `linker.lf` file to rename the fragment header and the library name to match the new component.
- If reusing other drivers, some header names need prefixing with `spi_flash/` when included from outside `spi_flash` component.

### 备注:

- When writing your own flash chip driver, you can set your flash chip capabilities through `spi_flash_chip_***(vendor)_get_caps` and points the function pointer `get_chip_caps` for protection to the `spi_flash_chip_***_get_caps` function. The steps are as follows.
  1. Please check whether your flash chip have the capabilities listed in `spi_flash_caps_t` by checking the flash datasheet.
  2. Write a function named `spi_flash_chip_***(vendor)_get_caps`. Take the example below as a reference. (if the flash support suspend and read unique id).
  3. Points the pointer `get_chip_caps` (in `spi_flash_chip_t`) to the function mentioned above.

```
spi_flash_caps_t spi_flash_chip_***(vendor)_get_caps(esp_flash_t *chip)
{
    spi_flash_caps_t caps_flags = 0;
    // 32-bit-address flash is not supported
    flash-suspend is supported
    caps_flags |= SPI_FLASH_CHIP_CAP_SUSPEND;
    // flash read unique id.
    caps_flags |= SPI_FLASH_CHIP_CAP_UNIQUE_ID;
    return caps_flags;
}
```

```
const spi_flash_chip_t esp_flash_chip_eon = {
    // Other function pointers
    .get_chip_caps = spi_flash_chip_eon_get_caps,
};
```

- You also can see how to implement this in the example [storage/custom\\_flash\\_driver](#).

4. Write a new `CMakeLists.txt` file for the `custom_chip_driver` component, including an additional line to add a linker dependency from `spi_flash` to `custom_chip_driver`:

```
idf_component_register(SRCS "spi_flash_chip_drivers.c"
                      "spi_flash_chip_mychip.c" # modify as needed
                      REQUIRES hal
                      PRIV_REQUIRES spi_flash
                      LDFRAGMENTS linker.lf)
idf_component_add_link_dependency(FROM spi_flash)
```

- An example of this component `CMakeLists.txt` can be found in [storage/custom\\_flash\\_driver/components/custom\\_chip\\_driver/CMakeLists.txt](#)

5. The `linker.lf` is used to put every chip driver that you are going to use whilst cache is disabled into internal RAM. See [链接器脚本生成机制](#) for more details. Make sure this file covers all the source files that you add.
6. Build your project, and you will see the new flash driver is used.

**Example** See also [storage/custom\\_flash\\_driver](#).

### 初始化 flash 设备

在使用 `esp_flash_*` API 之前，需要在 SPI 总线上初始化芯片，步骤如下：

1. 调用 `spi_bus_initialize()` 初始化 SPI 总线。此函数将初始化总线上设备间共享的资源，如 I/O、DMA、中断等。
2. 调用 `spi_bus_add_flash_device()` 将 flash 设备连接到总线上。然后分配内存，填充 `esp_flash_t` 结构体，同时初始化 CS I/O。
3. 调用 `esp_flash_init()` 与芯片进行通信。后续操作会依据芯片类型不同而有差异。

---

**备注：**当前，已支持多个 flash 芯片连接到同一总线。

---

### SPI flash 访问 API

如下所示为处理 flash 中数据的函数集：

- `esp_flash_read()`：将数据从 flash 读取到 RAM；
- `esp_flash_write()`：将数据从 RAM 写入到 flash；
- `esp_flash_erase_region()`：擦除 flash 中指定区域的数据；
- `esp_flash_erase_chip()`：擦除整个 flash；
- `esp_flash_get_chip_size()`：返回 `menuconfig` 中设置的 flash 芯片容量（以字节为单位）。

一般来说，请尽量避免对主 SPI flash 芯片直接使用原始 SPI flash 函数。如需对主 SPI flash 芯片进行操作，请使用 [分区专用函数](#)。

### SPI flash 容量

SPI flash 容量由引导加载程序镜像头部（烧录偏移量为 0x1000）的一个字段进行配置。

默认情况下，引导程序被写入 flash 时，`esptool.py` 会自动检测 SPI flash 容量，同时使用正确容量更新引导程序的头部。也可以在工程配置中设置 `CONFIG_ESPTOOLPY_FLASHSIZE`，生成固定的 flash 容量。

如需在运行时覆盖已配置的 flash 容量，请配置 `g_rom_flashchip` 结构中的 `chip_size`。`esp_flash_*` 函数使用此容量（于软件和 ROM 中）进行边界检查。

### SPI1 flash 并发约束

#### SPI1 flash 并发约束

指令/数据 cache（用以执行固件）与 SPI1 外设（由像 SPI flash 驱动一样的驱动程序控制）共享 SPI0/1 总线。因此，SPI1 外设上的操作会对整个系统造成显著的影响。这类操作包括调用 SPI flash API 或者 SPI1 总线上的其他驱动、任何 flash 操作（如读取、写入、擦除）或是由其他用户定义的 SPI 操作（对主 flash 或是其他 SPI 从机）。

在 ESP32-H2 上，flash 读取/写入/擦除时，必须禁用 cache。

在 ESP32-H2 上，配置选项 `CONFIG_SPI_FLASH_AUTO_SUSPEND` 允许 flash/PSRAM 的 cache 访问和 SPI1 的操作并发执行。该选项是可选的，依赖于特定的 SPI Flash 型号，因此默认是关闭的。请参阅 [flash 自动暂停功能](#)，查看详细信息。

禁用该选项时，在读取/写入/擦除 flash 期间，必须禁用 cache。使用驱动访问 SPI1 的相关约束参见 [禁用 cache 时](#)。这些约束会带来更多的 IRAM/DRAM 消耗。

**禁用 cache 时** 此时，在 flash 擦写操作中，所有的 CPU 都只能执行 IRAM 中的代码，而且必须从 DRAM 中读取数据。如果使用本文档中的 API 函数，上述限制将自动生效且透明（无需额外关注），但这些限制可能会影响系统中的其他任务的性能。

为避免意外读取 flash cache，在 flash 操作完成前，所有 CPU 上，会禁用所有在 CPU 上非 IRAM 安全的中断。

另请参阅 [OS 函数](#) 和 [SPI 总线锁](#)。

除 SPI0/1 以外，SPI 总线上的其他 flash 芯片则不受这种限制。

请参阅 [应用程序内存分布](#)，查看内部 RAM（如 IRAM、DRAM）和 flash cache 的区别。

**IRAM 安全中断处理程序** 如果需要在 flash 操作期间运行中断处理程序（比如低延迟操作），请在 [注册中断处理程序](#) 时设置 `ESP_INTR_FLAG_IRAM`。

请确保中断处理程序访问的所有数据和函数（包括其调用的数据和函数）都存储在 IRAM 或 DRAM 中。参见 [如何将代码放入 IRAM](#)。

在未将函数或符号正确放入 IRAM/DRAM 的情况下，在 flash 操作期间，中断处理程序从 flash cache 中读取数据时，会导致程序崩溃。这可能是由于代码未正确放入 IRAM，产生了非法指令异常，也可能是因为常数未正确放入 DRAM，读取到了垃圾数据。

---

**备注：**在 ISRs 中处理字符串时，不建议使用 `printf` 和其他输出函数。为了方便调试，在从 ISRs 中获取数据时，请使用 `ESP_DRAM_LOGE()` 和类似的宏。请确保 TAG 和格式字符串都放置于 DRAM 中。

---

**非 IRAM 安全中断处理程序** 如果在注册时没有设置 `ESP_INTR_FLAG_IRAM` 标志，当禁用 cache 时，将不会执行中断处理程序。一旦 cache 恢复，非 IRAM 安全的中断将重新启用，中断处理程序随即再次正常运行。这意味着，只要禁用了 cache，就不会发生相应的硬件事件。

## flash 自动暂停功能

### 重要：

1. 应使用支持暂停/恢复功能的 flash。
2. 应使用支持自动暂停功能的 MSPI 硬件，即硬件支持自动发送暂停命令。

如果在不支持自动暂停的 flash 上使用该功能，可能会造成严重的程序崩溃。因此，强烈建议提前阅读规格书，确保 flash 至少满足如下条件：

1. 基于当前软件的实现限制，flash 状态寄存器中的 SUS 位应当位于 SR2 bit7 或 SR bit15。
2. 基于当前软件的实现限制，flash 暂停命令应为 75H，恢复命令为 7AH。
3. flash 成功暂停后，除已擦除的段或块外，flash 地址中的任何内容都支持读取。也可以在此种状态下立即下达恢复命令。
4. flash 从暂停模式恢复后，支持立即下达另一个暂停命令。

---

启用 `CONFIG_SPI_FLASH_AUTO_SUSPEND` 后，缓存将保持启用状态，禁用该选项即可禁用缓存。SPI0 和 SPI1 之间的仲裁由硬件决定。当 SPI1 进行读取等耗时较短的操作时，CPU 和缓存将等待至 SPI1 操作完成。然而，在擦除、页面写入或状态寄存器写入等过程中，如 SE、PP 和 WRSR，自动暂停功能将中断正在进行的 flash 操作，使 CPU 得以在有限的时间内读取缓存及 flash 中的数据。

基于此功能，部分的代码及变量现可存放在 flash/PSRAM 中，同时仍能保证在 flash 擦除期间的正常执行，减少了 IRAM/DRAM 的消耗。

需注意，使用此功能暂停/恢复 flash 时，会导致额外开销。在 flash 擦除期间，频繁触发中断将显著延长擦除时间。为避免这种情况，建议调整 FreeRTOS 任务优先级，仅将实时关键的任务排在擦除操作前，从而确保在合理时间内完成 flash 擦除操作。

代码可以分为以下三类：

1. 关键代码：存放在 IRAM/DRAM 中。这类代码通常有较高的性能要求，与 cache/flash/PSRAM 相关，或者被频繁调用。



2. 缓存访问的代码：存放在 flash/PSRAM 中。这类代码的性能要求较低，或者较少被调用。flash 擦除时将执行这类代码，导致一定的开销。
3. 低优先级代码：存放在 flash/PSRAM 中，且在 flash 擦除期间禁止运行。这类代码的任务优先级应低于擦除操作，避免影响 flash 擦除的速度。

关于 flash 自动暂停功能的用法和对应的响应时间延迟，请参考 [system/flash\\_suspend](#) 示例。

**备注：**由于 flash 自动暂停功能极度依赖时序，其多用作一种优化方案，而非万能解法。例如 LCD 刷新、蓝牙、Wi-Fi 等场景对实时系统要求较高、或需要频繁触发中断，所以此方案并不适用。建议参照以下步骤，选择搭配 flash 自动暂停功能使用的 ISR 类型：

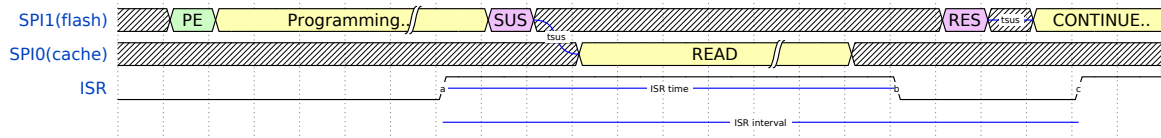

需注意图中的两个关键值：

1. **ISR 时间 (ISR time)：**ISR 时间不能过长，需小于 IWDT 中设置的值。ISR 时间会显著增加擦除/写入操作的完成时间。
2. **ISR 间隔时间 (ISR interval)：**由于不能频繁触发 ISR，需格外注意 **ISR 间隔时间减去 ISR 时间后的剩余时间**（图中 b 点至 c 点的距离）。在此期间，SPI1 会发送恢复命令重新启动操作，所需准备时间  $t_{sus}$  的典型值约为 **40 us**。如果在 SPI1 完成恢复操作前接收到了新的暂停命令，可能导致 CPU 饥饿，触发 TWDT。

对于第 2 点中所提到的  $t_{sus}$  时间可以通过翻阅 flash datasheets 查找，通常在 AC CHARACTERISTICS 章节中。用户需要保证从 datasheets 获得的  $t_{sus}$  值不大于 `CONFIG_SPI_FLASH_SUSPEND_TSUS_VAL_US` 值。

此外，flash 暂停可能延迟。CPU 和缓存通过 SPI0 频繁访问 flash，且 SPI1 频繁发送暂停命令时，会导致 MSPI 数据传输效率下降。可以通过在内部使用 **锁** 来避免此种情况。当 SPI1 发送暂停命令时，SPI0 将接管内存 SPI 总线并启用锁。SPI0 完成数据传输后，在锁延迟时间结束前，都将保有对内存 SPI 总线的控制权。在此锁延迟期间，如果接收到其他 SPI0 事务，则该 SPI0 事务将正常进行，并开启新一轮锁延迟周期。如无其他 SPI0 事务，则 SPI0 释放内存总线并启动 SPI0/1 仲裁。

**注意：**指令/数据 cache（用以执行固件）与 SPI1 外设（由像 SPI flash 驱动一样的驱动程序控制）共享 SPI0/1 总线。因此，在 SPI1 总线上调用 SPI flash API（包括访问主 flash）会对整个系统造成显著的影响。请参阅 [SPI1 flash 并发约束](#)，查看详细信息。

## SPI flash 加密

SPI flash 内容支持加密，并在硬件层进行透明解密。

请参阅 [flash 加密](#)，查看详细信息。

## 内存映射 API

ESP32-H2 的内存硬件可以将 flash 部分区域映射到指令地址空间和数据地址空间。此映射仅用于读操作，不能通过写入 flash 映射的存储区域来改变 flash 中的内容。

flash 在 64 KB 页进行映射。内存映射硬件既可将 flash 映射到数据地址空间，也能映射到指令地址空间。请查看技术参考手册，了解内存映射硬件的详细信息及有关限制。

请注意，有些页被用于将应用程序映射到内存中，因此实际可用的页会少于硬件提供的总数。

启用 [flash 加密](#) 时，使用内存映射区域从 flash 读取数据是解密 flash 的唯一方法，解密需在硬件层进行。

内存映射 API 在 `spi_flash_mmap.h` 和 `esp_partition.h` 中声明：

- `spi_flash_mmap()`：将 flash 物理地址区域映射到 CPU 指令空间或数据空间；

- `spi_flash_munmap()`: 取消上述区域的映射;
  - `esp_partition_mmap()`: 将分区的一部分映射至 CPU 指令空间或数据空间;
- `spi_flash_mmap()` 和 `esp_partition_mmap()` 的区别如下:
- `spi_flash_mmap()`: 需要给定一个 64 KB 对齐的物理地址;
  - `esp_partition_mmap()`: 给定分区内任意偏移量即可, 此函数根据需要将返回的指针调整至指向映射内存。

内存映射以页为单位, 即使传递给 `esp_partition_mmap` 的是一个分区, 分区外的数据也是可以被读取到的, 不会受到分区边界的影响。

---

**备注:** 由于 `mmap` 是由 `cache` 支持的, 因此, `mmap` 也仅能用在主 `flash` 上。

---

## SPI flash 实现

`esp_flash_t` 结构体包含芯片数据和该 API 的三个重要部分:

1. 主机驱动, 为访问芯片提供硬件支持;
2. 芯片驱动, 为不同芯片提供兼容性服务;
3. OS 函数, 在不同阶段 (一级或二级 Boot 或者应用程序阶段) 为部分 OS 函数 (如锁、延迟) 提供支持。

**主机驱动** 主机驱动依赖 `hal/include/hal` 文件夹下 `spi_flash_types.h` 定义的 `spi_flash_host_driver_t` 接口。该接口提供了一些常用的函数, 用于与芯片通信。

在 SPI HAL 文件中, 有些函数是基于现有的 ESP32-H2 `memory-spi` 来实现的。但是, 由于 ESP32-H2 的速度限制, HAL 层无法提供某些读命令的高速实现 (所以这些命令根本没有在 HAL 的文件中被实现)。`memspi_host_driver.h` 和 `.c` 文件使用 HAL 提供的 `common_command` 函数实现上述读命令的高速版本, 并将所有它实现的以及 HAL 函数封装为 `spi_flash_host_driver_t` 供更上层调用。

仅通过 GPIO, 也可实现自己的主机驱动。只要实现了 `spi_flash_host_driver_t` 中所有函数, 不管底层硬件是什么, `esp_flash` API 都可以访问 `flash`。

**芯片驱动** 芯片驱动在 `spi_flash_chip_driver.h` 中进行定义, 并将主机驱动提供的基本函数进行封装以供 API 层使用。

有些操作需在执行前先发送命令, 或在执行后读取状态, 因此有些芯片需要不同的命令或值以及通信方式。

`generic chip` 芯片代表了常见的 `flash` 芯片, 其他芯片驱动可以在这种通用芯片的基础上进行开发。

芯片驱动依赖主机驱动。

## OS 函数

## SPI 特性

## SPI 主机

**SPI 总线锁** 为了多路复用来自 SPI 主机、SPI flash 等不同驱动的设备, 每个 SPI 总线上都配有 SPI 总线锁。驱动程序可以通过对锁实施仲裁, 将设备连接到总线上。

每个总线锁都已初始化并注册了后台服务 (BG)。设备应在 BG 禁用后, 再在总线上进行传输。



- SPI1 总线的后台服务为高速缓存。在设备操作开始前，总线锁可以禁用高速缓存，并在设备释放锁后将其再次启用。高速缓存处于禁用状态时，让出当前任务的执行权毫无意义，因此，该情况下 SPI1 总线上的任何设备都无法使用 ISR。  
SPI 主机驱动程序暂不支持 SPI1 总线。只有 SPI flash 驱动程序可以连接到该总线。
- 对于其他总线，驱动程序可以将 ISR 注册为后台服务。若设备任务要求独占总线，则总线锁将阻塞该任务，同时禁用 ISR，随即解除对该任务的阻塞。任务释放锁后，如果 ISR 中还有待处理的事务，则锁将尝试重新启用 ISR。

OS 函数层目前支持访问锁和延迟的方法。

锁（见 [SPI 总线锁](#)）用于解决同一 SPI 总线上的设备访问和 SPI flash 芯片访问之间的冲突。例如：

1. 经 SPI1 总线访问 flash 芯片时，应当禁用 cache（平时用于获取代码和 PSRAM 数据）。
2. 经其他总线访问 flash 芯片时，应当禁用 flash 上 SPI 主驱动器注册的 ISR 以避免冲突。
3. SPI 主驱动器上某些没有 CS 线或者 CS 线受软件（如 SDSPI）控制的设备需要在一段时间内独占总线。

延时则用于某些长时操作，需要主机处于等待状态或执行轮询。

顶层 API 将芯片驱动和 OS 函数封装成一个完整的组件，并提供参数检查。

使用 OS 函数还可以在在一定程度上避免在擦除大块 flash 区域时出现看门狗超时的情况。在这段时间内，CPU 将被 flash 擦除任务占用，从而阻止其他任务的执行，包括为看门狗定时器 (WDT) 供电的空闲任务。若已选中配置选项 `CONFIG_ESP_TASK_WDT_PANIC`，并且 flash 操作时间长于看门狗的超时时间，系统将重新启动。

不过，由于不同的 flash 芯片擦除时间不同，flash 驱动几乎无法兼容，很难完全规避超时的风险，这一点需要格外注意。请遵照以下指南：

1. 建议启用 `CONFIG_SPI_FLASH_YIELD_DURING_ERASE` 选项，允许调度器在擦除 flash 时进行重新调度。此外，还可以使用下列参数。
  - 在 `menuconfig` 中增加 `CONFIG_SPI_FLASH_ERASE_YIELD_TICKS` 或减少 `CONFIG_SPI_FLASH_ERASE_YIELD_DURATION_MS` 的时间。
  - 在 `menuconfig` 中增加 `CONFIG_ESP_TASK_WDT_TIMEOUT_S` 的时间，以设置更长的看门狗超时周期。然而，看门狗超时周期拉长后，可能无法再检测到以前可检测到的超时。
1. 请注意，在进行长时间的 SPI flash 操作时，启用 `CONFIG_ESP_TASK_WDT_PANIC` 选项将会在超时触发紧急处理程序。不过，启用该选项也可以帮助处理应用程序中的意外异常，请根据实际情况决定是否启用这个选项。
2. 在开发过程中，请根据项目对擦除 flash 的具体要求和时间限制，谨慎进行 flash 操作。在配置 flash 擦除超时周期时，请在实际产品要求的基础上留出合理的冗余时间，从而提高产品的可靠性。

## 实现细节

必须确保操作期间，两个 CPU 均未从 flash 运行代码，实现细节如下：

- 单核模式下，SDK 在执行 flash 操作前将禁用中断或调度算法。
- 双核模式下，SDK 需确保两个 CPU 均未运行 flash 代码。

如果有 SPI flash API 在 CPU A (PRO 或 APP) 上调用，它使用 `esp_ipc_call` API 在 CPU B 上运行 `spi_flash_op_block_func` 函数。`esp_ipc_call` API 会在 CPU B 上唤醒一个高优先级任务，即运行 `spi_flash_op_block_func` 函数。运行该函数将禁用 CPU B 上的 cache，并使用 `s_flash_op_can_start` 旗帜来标志 cache 已禁用。然后，CPU A 上的任务也会禁用 cache 并继续执行 flash 操作。

执行 flash 操作时，CPU A 和 CPU B 仍然可以执行中断操作。默认中断代码均存储于 RAM 中，如果新添加了中断分配 API，则应添加一个标志位以请求在 flash 操作期间禁用该新分配的中断。

flash 操作完成后，CPU A 上的函数将设置另一标志位，即 `s_flash_op_complete`，用以通知 CPU B 上的任务可以重新启用 cache 并释放 CPU。接着，CPU A 上的函数也重新启用 cache，并将控制权返还给调用者。

另外，所有 API 函数均受互斥量 `s_flash_op_mutex` 保护。

在单核环境中（启用`CONFIG_FREERTOS_UNICORE`），需要禁用上述两个 cache，以防发生 CPU 间通信。

## 相关文档

- [Optional Features for Flash](#)
- [SPI flash 并发约束](#)
- [SPI Flash API ESP-IDF Version vs Chip-ROM Version](#)

**SPI Flash API ESP-IDF Version vs Chip-ROM Version** There is a set of SPI Flash drivers in Chip-ROM which you can use by enabling `CONFIG_SPI_FLASH_ROM_IMPL`. Most of the ESP-IDF SPI Flash driver code are in internal RAM, therefore enabling this option frees some internal RAM usage. Note if you enable this option, this means some SPI Flash driver features and bugfixes that are done in ESP-IDF might not be included in the Chip-ROM version.

## Feature Supported by ESP-IDF but Not in Chip-ROM

- Octal Flash chip support. See [OPI Flash Support](#) for details.
- 32-bit-address support for GD25Q256. Note this feature is an optional feature, please do read [32-bit Address Support of QSPI Flash Chips](#) for details.
- TH Flash chip support.
- Kconfig option `CONFIG_SPI_FLASH_CHECK_ERASE_TIMEOUT_DISABLED`.
- `CONFIG_SPI_FLASH_VERIFY_WRITE`, enabling this option helps you detect bad writing.
- `CONFIG_SPI_FLASH_LOG_FAILED_WRITE`, enabling this option prints the bad writing.
- `CONFIG_SPI_FLASH_WARN_SETTING_ZERO_TO_ONE`, enabling this option checks if you are writing zero to one.
- `CONFIG_SPI_FLASH_DANGEROUS_WRITE`, enabling this option checks for flash programming to certain protected regions like bootloader, partition table or application itself.
- `CONFIG_SPI_FLASH_ENABLE_COUNTERS`, enabling this option to collect performance data for ESP-IDF SPI Flash driver APIs.
- `CONFIG_SPI_FLASH_AUTO_SUSPEND`, enabling this option to automatically suspend / resume a long Flash operation when short Flash operation happens. Note this feature is an optional feature, please do read [Auto Suspend & Resume](#) for more limitations.

## Bugfixes Introduced in ESP-IDF but Not in Chip-ROM

- Detected Flash physical size correctly, for larger than 256MBit Flash chips. (Commit ID: b4964279d44f73cce7cfd5cf684567fbdfd6fd9e)

## SPI flash API 参考

### Header File

- `components/spi_flash/include/esp_flash_spi_init.h`
- This header file can be included with:

```
#include "esp_flash_spi_init.h"
```

- This header file is a part of the API provided by the `spi_flash` component. To declare that your component depends on `spi_flash`, add the following to your `CMakeLists.txt`:

```
REQUIRES spi_flash
```

or

```
PRIV_REQUIRES spi_flash
```

## Functions

`esp_err_t spi_bus_add_flash_device` (`esp_flash_t **out_chip`, const `esp_flash_spi_device_config_t *config`)

Add a SPI Flash device onto the SPI bus.

The bus should be already initialized by `spi_bus_initialization`.

### 参数

- **out\_chip** -- Pointer to hold the initialized chip.
- **config** -- Configuration of the chips to initialize.

### 返回

- `ESP_ERR_INVALID_ARG`: `out_chip` is NULL, or some field in the config is invalid.
- `ESP_ERR_NO_MEM`: failed to allocate memory for the chip structures.
- `ESP_OK`: success.

`esp_err_t spi_bus_remove_flash_device` (`esp_flash_t *chip`)

Remove a SPI Flash device from the SPI bus.

**参数 chip** -- The flash device to remove.

### 返回

- `ESP_ERR_INVALID_ARG`: The chip is invalid.
- `ESP_OK`: success.

## Structures

struct `esp_flash_spi_device_config_t`

Configurations for the SPI Flash to init.

## Public Members

`spi_host_device_t host_id`

Bus to use.

int `cs_io_num`

GPIO pin to output the CS signal.

`esp_flash_io_mode_t io_mode`

IO mode to read from the Flash.

enum `esp_flash_speed_s speed`

Speed of the Flash clock. Replaced by `freq_mhz`.

int `input_delay_ns`

Input delay of the data pins, in ns. Set to 0 if unknown.

int `cs_id`

CS line ID, ignored when not `host_id` is not `SPI1_HOST`, or `CONFIG_SPI_FLASH_SHARE_SPI1_BUS` is enabled. In this case, the CS line used is automatically assigned by the SPI bus lock.

int `freq_mhz`

The frequency of flash chip(MHZ)

## Header File

- [components/spi\\_flash/include/esp\\_flash.h](#)
- This header file can be included with:

```
#include "esp_flash.h"
```

- This header file is a part of the API provided by the `spi_flash` component. To declare that your component depends on `spi_flash`, add the following to your `CMakeLists.txt`:

```
REQUIRES spi_flash
```

or

```
PRIV_REQUIRES spi_flash
```

## Functions

*esp\_err\_t* **esp\_flash\_init** (*esp\_flash\_t* \*chip)

Initialise SPI flash chip interface.

This function must be called before any other API functions are called for this chip.

---

**备注:** Only the `host` and `read_mode` fields of the chip structure must be initialised before this function is called. Other fields may be auto-detected if left set to zero or NULL.

---



---

**备注:** If the `chip->drv` pointer is NULL, `chip chip_drv` will be auto-detected based on its manufacturer & product IDs. See `esp_flash_registered_flash_drivers` pointer for details of this process.

---

**参数** `chip` -- Pointer to SPI flash chip to use. If NULL, `esp_flash_default_chip` is substituted.

**返回** `ESP_OK` on success, or a flash error code if initialisation fails.

bool **esp\_flash\_chip\_driver\_initialized** (const *esp\_flash\_t* \*chip)

Check if appropriate chip driver is set.

**参数** `chip` -- Pointer to SPI flash chip to use. If NULL, `esp_flash_default_chip` is substituted.

**返回** true if set, otherwise false.

*esp\_err\_t* **esp\_flash\_read\_id** (*esp\_flash\_t* \*chip, uint32\_t \*out\_id)

Read flash ID via the common "RDID" SPI flash command.

ID is a 24-bit value. Lower 16 bits of 'id' are the chip ID, upper 8 bits are the manufacturer ID.

**参数**

- **chip** -- Pointer to identify flash chip. Must have been successfully initialised via `esp_flash_init()`
- **out\_id** -- [out] Pointer to receive ID value.

**返回** `ESP_OK` on success, or a flash error code if operation failed.

*esp\_err\_t* **esp\_flash\_get\_size** (*esp\_flash\_t* \*chip, uint32\_t \*out\_size)

Detect flash size based on flash ID.

---

**备注:** 1. Most flash chips use a common format for flash ID, where the lower 4 bits specify the size as a power of 2. If the manufacturer doesn't follow this convention, the size may be incorrectly detected.

- The `out_size` returned only stands for The `out_size` stands for the size in the binary image header. If you want to get the real size of the chip, please call `esp_flash_get_physical_size` instead.
-

**参数**

- **chip** -- Pointer to identify flash chip. Must have been successfully initialised via `esp_flash_init()`
- **out\_size** -- [out] Detected size in bytes, standing for the size in the binary image header.

**返回** ESP\_OK on success, or a flash error code if operation failed.

*esp\_err\_t* **esp\_flash\_get\_physical\_size** (*esp\_flash\_t* \*chip, uint32\_t \*flash\_size)

Detect flash size based on flash ID.

---

**备注:** Most flash chips use a common format for flash ID, where the lower 4 bits specify the size as a power of 2. If the manufacturer doesn't follow this convention, the size may be incorrectly detected.

---

**参数**

- **chip** -- Pointer to identify flash chip. Must have been successfully initialised via `esp_flash_init()`
- **flash\_size** -- [out] Detected size in bytes.

**返回** ESP\_OK on success, or a flash error code if operation failed.

*esp\_err\_t* **esp\_flash\_read\_unique\_chip\_id** (*esp\_flash\_t* \*chip, uint64\_t \*out\_id)

Read flash unique ID via the common "RDUID" SPI flash command.

ID is a 64-bit value.

---

**备注:** This is an optional feature, which is not supported on all flash chips. READ PROGRAMMING GUIDE FIRST!

---

**参数**

- **chip** -- Pointer to identify flash chip. Must have been successfully initialised via `esp_flash_init()`.
- **out\_id** -- [out] Pointer to receive unique ID value.

**返回**

- ESP\_OK on success, or a flash error code if operation failed.
- ESP\_ERR\_NOT\_SUPPORTED if the chip doesn't support read id.

*esp\_err\_t* **esp\_flash\_erase\_chip** (*esp\_flash\_t* \*chip)

Erase flash chip contents.

**参数** **chip** -- Pointer to identify flash chip. Must have been successfully initialised via `esp_flash_init()`

**返回**

- ESP\_OK on success,
- ESP\_ERR\_NOT\_SUPPORTED if the chip is not able to perform the operation. This is indicated by WREN = 1 after the command is sent.
- ESP\_ERR\_NOT\_ALLOWED if a read-only partition is present.
- Other flash error code if operation failed.

*esp\_err\_t* **esp\_flash\_erase\_region** (*esp\_flash\_t* \*chip, uint32\_t start, uint32\_t len)

Erase a region of the flash chip.

Sector size is specified in `chip->drv->sector_size` field (typically 4096 bytes.) ESP\_ERR\_INVALID\_ARG will be returned if the start & length are not a multiple of this size.

Erase is performed using block (multi-sector) erases where possible (block size is specified in `chip->drv->block_erase_size` field, typically 65536 bytes). Remaining sectors are erased using individual sector erase commands.

**参数**

- **chip** -- Pointer to identify flash chip. If NULL, `esp_flash_default_chip` is substituted. Must have been successfully initialised via `esp_flash_init()`
- **start** -- Address to start erasing flash. Must be sector aligned.
- **len** -- Length of region to erase. Must also be sector aligned.

**返回**

- ESP\_OK on success,
- ESP\_ERR\_NOT\_SUPPORTED if the chip is not able to perform the operation. This is indicated by `WREN = 1` after the command is sent.
- ESP\_ERR\_NOT\_ALLOWED if the address range (`start - start + len`) overlaps with a read-only partition address space
- Other flash error code if operation failed.

*esp\_err\_t* **esp\_flash\_get\_chip\_write\_protect** (*esp\_flash\_t* \*chip, bool \*write\_protected)

Read if the entire chip is write protected.

---

**备注:** A correct result for this flag depends on the SPI flash chip model and `chip_drv` in use (via the 'chip->drv' field).

---

**参数**

- **chip** -- Pointer to identify flash chip. If NULL, `esp_flash_default_chip` is substituted. Must have been successfully initialised via `esp_flash_init()`
- **write\_protected** -- [out] Pointer to boolean, set to the value of the write protect flag.

**返回** ESP\_OK on success, or a flash error code if operation failed.

*esp\_err\_t* **esp\_flash\_set\_chip\_write\_protect** (*esp\_flash\_t* \*chip, bool write\_protect)

Set write protection for the SPI flash chip.

Some SPI flash chips may require a power cycle before write protect status can be cleared. Otherwise, write protection can be removed via a follow-up call to this function.

---

**备注:** Correct behaviour of this function depends on the SPI flash chip model and `chip_drv` in use (via the 'chip->drv' field).

---

**参数**

- **chip** -- Pointer to identify flash chip. If NULL, `esp_flash_default_chip` is substituted. Must have been successfully initialised via `esp_flash_init()`
- **write\_protect** -- Boolean value for the write protect flag

**返回** ESP\_OK on success, or a flash error code if operation failed.

*esp\_err\_t* **esp\_flash\_get\_protectable\_regions** (const *esp\_flash\_t* \*chip, const *esp\_flash\_region\_t* \*\*out\_regions, uint32\_t \*out\_num\_regions)

Read the list of individually protectable regions of this SPI flash chip.

---

**备注:** Correct behaviour of this function depends on the SPI flash chip model and `chip_drv` in use (via the 'chip->drv' field).

---

**参数**

- **chip** -- Pointer to identify flash chip. Must have been successfully initialised via `esp_flash_init()`
- **out\_regions** -- [out] Pointer to receive a pointer to the array of protectable regions of the chip.
- **out\_num\_regions** -- [out] Pointer to an integer receiving the count of protectable regions in the array returned in 'regions'.

返回 ESP\_OK on success, or a flash error code if operation failed.

*esp\_err\_t* **esp\_flash\_get\_protected\_region** (*esp\_flash\_t* \*chip, const *esp\_flash\_region\_t* \*region, bool \*out\_protected)

Detect if a region of the SPI flash chip is protected.

---

**备注:** It is possible for this result to be false and write operations to still fail, if protection is enabled for the entire chip.

---



---

**备注:** Correct behaviour of this function depends on the SPI flash chip model and `chip_drv` in use (via the 'chip->drv' field).

---

#### 参数

- **chip** -- Pointer to identify flash chip. Must have been successfully initialised via `esp_flash_init()`
- **region** -- Pointer to a struct describing a protected region. This must match one of the regions returned from `esp_flash_get_protectable_regions(...)`.
- **out\_protected** -- [out] Pointer to a flag which is set based on the protected status for this region.

返回 ESP\_OK on success, or a flash error code if operation failed.

*esp\_err\_t* **esp\_flash\_set\_protected\_region** (*esp\_flash\_t* \*chip, const *esp\_flash\_region\_t* \*region, bool protect)

Update the protected status for a region of the SPI flash chip.

---

**备注:** It is possible for the region protection flag to be cleared and write operations to still fail, if protection is enabled for the entire chip.

---



---

**备注:** Correct behaviour of this function depends on the SPI flash chip model and `chip_drv` in use (via the 'chip->drv' field).

---

#### 参数

- **chip** -- Pointer to identify flash chip. Must have been successfully initialised via `esp_flash_init()`
- **region** -- Pointer to a struct describing a protected region. This must match one of the regions returned from `esp_flash_get_protectable_regions(...)`.
- **protect** -- Write protection flag to set.

返回 ESP\_OK on success, or a flash error code if operation failed.

*esp\_err\_t* **esp\_flash\_read** (*esp\_flash\_t* \*chip, void \*buffer, uint32\_t address, uint32\_t length)

Read data from the SPI flash chip.

There are no alignment constraints on buffer, address or length.



---

**备注:** If on-chip flash encryption is used, this function returns raw (ie encrypted) data. Use the flash cache to transparently decrypt data.

---

**参数**

- **chip** -- Pointer to identify flash chip. If NULL, `esp_flash_default_chip` is substituted. Must have been successfully initialised via `esp_flash_init()`
- **buffer** -- Pointer to a buffer where the data will be read. To get better performance, this should be in the DRAM and word aligned.
- **address** -- Address on flash to read from. Must be less than `chip->size` field.
- **length** -- Length (in bytes) of data to read.

**返回**

- `ESP_OK`: success
- `ESP_ERR_NO_MEM`: Buffer is in external PSRAM which cannot be concurrently accessed, and a temporary internal buffer could not be allocated.
- or a flash error code if operation failed.

`esp_err_t esp_flash_write(esp_flash_t *chip, const void *buffer, uint32_t address, uint32_t length)`

Write data to the SPI flash chip.

There are no alignment constraints on buffer, address or length.

**参数**

- **chip** -- Pointer to identify flash chip. If NULL, `esp_flash_default_chip` is substituted. Must have been successfully initialised via `esp_flash_init()`
- **address** -- Address on flash to write to. Must be previously erased (SPI NOR flash can only write bits 1->0).
- **buffer** -- Pointer to a buffer with the data to write. To get better performance, this should be in the DRAM and word aligned.
- **length** -- Length (in bytes) of data to write.

**返回**

- `ESP_OK` on success
- `ESP_FAIL`, bad write, this will be detected only when `CONFIG_SPI_FLASH_VERIFY_WRITE` is enabled
- `ESP_ERR_NOT_SUPPORTED` if the chip is not able to perform the operation. This is indicated by `WREN = 1` after the command is sent.
- `ESP_ERR_NOT_ALLOWED` if the address range (`address - address + length`) overlaps with a read-only partition address space
- Other flash error code if operation failed.

`esp_err_t esp_flash_write_encrypted(esp_flash_t *chip, uint32_t address, const void *buffer, uint32_t length)`

Encrypted and write data to the SPI flash chip using on-chip hardware flash encryption.

---

**备注:** Both address & length must be 16 byte aligned, as this is the encryption block size

---

**参数**

- **chip** -- Pointer to identify flash chip. Must be NULL (the main flash chip). For other chips, encrypted write is not supported.
- **address** -- Address on flash to write to. 16 byte aligned. Must be previously erased (SPI NOR flash can only write bits 1->0).
- **buffer** -- Pointer to a buffer with the data to write.
- **length** -- Length (in bytes) of data to write. 16 byte aligned.

**返回**

- `ESP_OK`: on success



- `ESP_FAIL`: bad write, this will be detected only when `CONFIG_SPI_FLASH_VERIFY_WRITE` is enabled
- `ESP_ERR_NOT_SUPPORTED`: encrypted write not supported for this chip.
- `ESP_ERR_INVALID_ARG`: Either the address, buffer or length is invalid.
- `ESP_ERR_NOT_ALLOWED` if the address range (address –address + length) overlaps with a read-only partition address space

`esp_err_t esp_flash_read_encrypted(esp_flash_t *chip, uint32_t address, void *out_buffer, uint32_t length)`

Read and decrypt data from the SPI flash chip using on-chip hardware flash encryption.

#### 参数

- **chip** -- Pointer to identify flash chip. Must be NULL (the main flash chip). For other chips, encrypted read is not supported.
- **address** -- Address on flash to read from.
- **out\_buffer** -- Pointer to a buffer for the data to read to.
- **length** -- Length (in bytes) of data to read.

#### 返回

- `ESP_OK`: on success
- `ESP_ERR_NOT_SUPPORTED`: encrypted read not supported for this chip.

static inline bool `esp_flash_is_quad_mode` (const `esp_flash_t` \*chip)

Returns true if chip is configured for Quad I/O or Quad Fast Read.

**参数 chip** -- Pointer to SPI flash chip to use. If NULL, `esp_flash_default_chip` is substituted.

**返回** true if flash works in quad mode, otherwise false

## Structures

struct `esp_flash_region_t`

Structure for describing a region of flash.

### Public Members

uint32\_t **offset**

Start address of this region.

uint32\_t **size**

Size of the region.

struct `esp_flash_os_functions_t`

OS-level integration hooks for accessing flash chips inside a running OS.

It's in the public header because some instances should be allocated statically in the startup code. May be updated according to hardware version and new flash chip feature requirements, shouldn't be treated as public API.

For advanced developers, you may replace some of them with your implementations at your own risk.

### Public Members

`esp_err_t (*start)(void *arg)`

Called before commencing any flash operation. Does not need to be recursive (ie is called at most once for each call to 'end').

*esp\_err\_t* (\***end**)(void \*arg)

Called after completing any flash operation.

*esp\_err\_t* (\***region\_protected**)(void \*arg, size\_t start\_addr, size\_t size)

Called before any erase/write operations to check whether the region is limited by the OS

*esp\_err\_t* (\***delay\_us**)(void \*arg, uint32\_t us)

Delay for at least 'us' microseconds. Called in between 'start' and 'end'.

void (\***get\_temp\_buffer**)(void \*arg, size\_t request\_size, size\_t \*out\_size)

Called for get temp buffer when buffer from application cannot be directly read into/write from.

void (\***release\_temp\_buffer**)(void \*arg, void \*temp\_buf)

Called for release temp buffer.

*esp\_err\_t* (\***check\_yield**)(void \*arg, uint32\_t chip\_status, uint32\_t \*out\_request)

Yield to other tasks. Called during erase operations.

**Return** ESP\_OK means yield needs to be called (got an event to handle), while ESP\_ERR\_TIMEOUT means skip yield.

*esp\_err\_t* (\***yield**)(void \*arg, uint32\_t \*out\_status)

Yield to other tasks. Called during erase operations.

int64\_t (\***get\_system\_time**)(void \*arg)

Called for get system time.

void (\***set\_flash\_op\_status**)(uint32\_t op\_status)

Call to set flash operation status

struct **esp\_flash\_t**

Structure to describe a SPI flash chip connected to the system.

Structure must be initialized before use (passed to `esp_flash_init()`). It's in the public header because some instances should be allocated statically in the startup code. May be updated according to hardware version and new flash chip feature requirements, shouldn't be treated as public API.

For advanced developers, you may replace some of them with your implementations at your own risk.

## Public Members

*spi\_flash\_host\_inst\_t* \***host**

Pointer to hardware-specific "host\_driver" structure. Must be initialized before used.

const *spi\_flash\_chip\_t* \***chip\_drv**

Pointer to chip-model-specific "adapter" structure. If NULL, will be detected during initialisation.

const *esp\_flash\_os\_functions\_t* \***os\_func**

Pointer to os-specific hook structure. Call `esp_flash_init_os_functions()` to setup this field, after the host is properly initialized.

void **\*os\_func\_data**

Pointer to argument for os-specific hooks. Left NULL and will be initialized with `os_func`.

*esp\_flash\_io\_mode\_t* **read\_mode**

Configured SPI flash read mode. Set before `esp_flash_init` is called.

uint32\_t **size**

Size of SPI flash in bytes. If 0, size will be detected during initialisation. Note: this stands for the size in the binary image header. If you want to get the flash physical size, please call `esp_flash_get_physical_size`.

uint32\_t **chip\_id**

Detected chip id.

uint32\_t **busy**

This flag is used to verify chip's status.

uint32\_t **hpm\_dummy\_ena**

This flag is used to verify whether flash works under HPM status.

uint32\_t **reserved\_flags**

reserved.

## Macros

**SPI\_FLASH\_YIELD\_REQ\_YIELD**

**SPI\_FLASH\_YIELD\_REQ\_SUSPEND**

**SPI\_FLASH\_YIELD\_STA\_RESUME**

**SPI\_FLASH\_OS\_IS\_ERASING\_STATUS\_FLAG**

## Type Definitions

typedef struct *spi\_flash\_chip\_t* **spi\_flash\_chip\_t**

## Header File

- [components/spi\\_flash/include/spi\\_flash\\_mmap.h](#)
- This header file can be included with:

```
#include "spi_flash_mmap.h"
```

- This header file is a part of the API provided by the `spi_flash` component. To declare that your component depends on `spi_flash`, add the following to your `CMakeLists.txt`:

```
REQUIRES spi_flash
```

or

```
PRIV_REQUIRES spi_flash
```

**Functions**

`esp_err_t spi_flash_mmap` (`size_t src_addr`, `size_t size`, `spi_flash_mmap_memory_t memory`, `const void **out_ptr`, `spi_flash_mmap_handle_t *out_handle`)

Map region of flash memory into data or instruction address space.

This function allocates sufficient number of 64kB MMU pages and configures them to map the requested region of flash memory into the address space. It may reuse MMU pages which already provide the required mapping.

As with any allocator, if `mmap/munmap` are heavily used then the address space may become fragmented. To troubleshoot issues with page allocation, use `spi_flash_mmap_dump()` function.

**参数**

- **src\_addr** -- Physical address in flash where requested region starts. This address *must* be aligned to 64kB boundary (`SPI_FLASH_MMU_PAGE_SIZE`)
- **size** -- Size of region to be mapped. This size will be rounded up to a 64kB boundary
- **memory** -- Address space where the region should be mapped (data or instruction)
- **out\_ptr** -- [out] Output, pointer to the mapped memory region
- **out\_handle** -- [out] Output, handle which should be used for `spi_flash_munmap` call

**返回** `ESP_OK` on success, `ESP_ERR_NO_MEM` if pages can not be allocated

`esp_err_t spi_flash_mmap_pages` (`const int *pages`, `size_t page_count`, `spi_flash_mmap_memory_t memory`, `const void **out_ptr`, `spi_flash_mmap_handle_t *out_handle`)

Map sequences of pages of flash memory into data or instruction address space.

This function allocates sufficient number of 64kB MMU pages and configures them to map the indicated pages of flash memory contiguously into address space. In this respect, it works in a similar way as `spi_flash_mmap()` but it allows mapping a (maybe non-contiguous) set of pages into a contiguous region of memory.

**参数**

- **pages** -- An array of numbers indicating the 64kB pages in flash to be mapped contiguously into memory. These indicate the indexes of the 64kB pages, not the byte-size addresses as used in other functions. Array must be located in internal memory.
- **page\_count** -- Number of entries in the pages array
- **memory** -- Address space where the region should be mapped (instruction or data)
- **out\_ptr** -- [out] Output, pointer to the mapped memory region
- **out\_handle** -- [out] Output, handle which should be used for `spi_flash_munmap` call

**返回**

- `ESP_OK` on success
- `ESP_ERR_NO_MEM` if pages can not be allocated
- `ESP_ERR_INVALID_ARG` if pagecount is zero or pages array is not in internal memory

void `spi_flash_munmap` (`spi_flash_mmap_handle_t handle`)

Release region previously obtained using `spi_flash_mmap`.

---

**备注:** Calling this function will not necessarily unmap memory region. Region will only be unmapped when there are no other handles which reference this region. In case of partially overlapping regions it is possible that memory will be unmapped partially.

---

**参数** `handle` -- Handle obtained from `spi_flash_mmap`

void `spi_flash_mmap_dump` (void)

Display information about mapped regions.

This function lists handles obtained using `spi_flash_mmap`, along with range of pages allocated to each handle. It also lists all non-zero entries of MMU table and corresponding reference counts.

uint32\_t `spi_flash_mmap_get_free_pages` (`spi_flash_mmap_memory_t memory`)

get free pages number which can be mmap

This function will return number of free pages available in mmu table. This could be useful before calling actual `spi_flash_mmap` (maps flash range to DCache or ICache memory) to check if there is sufficient space available for mapping.

**参数** `memory` -- memory type of MMU table free page

**返回** number of free pages which can be mmaped

`size_t spi_flash_cache2phys` (const void \*cached)

Given a memory address where flash is mapped, return the corresponding physical flash offset.

Cache address does not have been assigned via `spi_flash_mmap()`, any address in memory mapped flash space can be looked up.

**参数** `cached` -- Pointer to flashed cached memory.

**返回**

- `SPI_FLASH_CACHE2PHYS_FAIL` If cache address is outside flash cache region, or the address is not mapped.
- Otherwise, returns physical offset in flash

`const void *spi_flash_phys2cache` (size\_t phys\_offs, *spi\_flash\_mmap\_memory\_t* memory)

Given a physical offset in flash, return the address where it is mapped in the memory space.

Physical address does not have to have been assigned via `spi_flash_mmap()`, any address in flash can be looked up.

---

**备注:** Only the first matching cache address is returned. If MMU flash cache table is configured so multiple entries point to the same physical address, there may be more than one cache address corresponding to that physical address. It is also possible for a single physical address to be mapped to both the IROM and DROM regions.

---

---

**备注:** This function doesn't impose any alignment constraints, but if memory argument is `SPI_FLASH_MMAP_INST` and `phys_offs` is not 4-byte aligned, then reading from the returned pointer will result in a crash.

---

**参数**

- `phys_offs` -- Physical offset in flash memory to look up.
- `memory` -- Address space type to look up a flash cache address mapping for (instruction or data)

**返回**

- NULL if the physical address is invalid or not mapped to flash cache of the specified memory type.
- Cached memory address (in IROM or DROM space) corresponding to `phys_offs`.

## Macros

### `ESP_ERR_FLASH_OP_FAIL`

This file contains `spi_flash_mmap_xx` APIs, mainly for doing memory mapping to an SPI0-connected external Flash, as well as some helper functions to convert between virtual and physical address

### `ESP_ERR_FLASH_OP_TIMEOUT`

### `SPI_FLASH_SEC_SIZE`

SPI Flash sector size

### `SPI_FLASH_MMU_PAGE_SIZE`

Flash cache MMU mapping page size

**SPI\_FLASH\_CACHE2PHYS\_FAIL**

### Type Definitions

typedef uint32\_t **spi\_flash\_mmap\_handle\_t**

Opaque handle for memory region obtained from spi\_flash\_mmap.

### Enumerations

enum **spi\_flash\_mmap\_memory\_t**

Enumeration which specifies memory space requested in an mmap call.

*Values:*

enumerator **SPI\_FLASH\_MMAP\_DATA**

map to data memory, allows byte-aligned access

enumerator **SPI\_FLASH\_MMAP\_INST**

map to instruction memory, allows only 4-byte-aligned access

### Header File

- `components/hal/include/hal/spi_flash_types.h`
- This header file can be included with:

```
#include "hal/spi_flash_types.h"
```

### Structures

struct **spi\_flash\_trans\_t**

Definition of a common transaction. Also holds the return value.

### Public Members

uint8\_t **reserved**

Reserved, must be 0.

uint8\_t **mosi\_len**

Output data length, in bytes.

uint8\_t **miso\_len**

Input data length, in bytes.

uint8\_t **address\_bitlen**

Length of address in bits, set to 0 if command does not need an address.

uint32\_t **address**

Address to perform operation on.

const uint8\_t \***mosi\_data**

Output data to salve.

uint8\_t \***miso\_data**

[out] Input data from slave, little endian

uint32\_t **flags**

Flags for this transaction. Set to 0 for now.

uint16\_t **command**

Command to send.

uint8\_t **dummy\_bitlen**

Basic dummy bits to use.

uint32\_t **io\_mode**

Flash working mode when `SPI_FLASH_IGNORE_BASEIO` is specified.

struct **spi\_flash\_sus\_cmd\_conf**

Configuration structure for the flash chip suspend feature.

### Public Members

uint32\_t **sus\_mask**

SUS/SUS1/SUS2 bit in flash register.

uint32\_t **cmd\_rdsr**

Read flash status register(2) command.

uint32\_t **sus\_cmd**

Flash suspend command.

uint32\_t **res\_cmd**

Flash resume command.

uint32\_t **reserved**

Reserved, set to 0.

struct **spi\_flash\_encryption\_t**

Structure for flash encryption operations.

### Public Members

void (\***flash\_encryption\_enable**)(void)

Enable the flash encryption.

void (\***flash\_encryption\_disable**)(void)

Disable the flash encryption.

void (**\*flash\_encryption\_data\_prepare**)(uint32\_t address, const uint32\_t \*buffer, uint32\_t size)

Prepare flash encryption before operation.

---

**备注:** address and buffer must be 8-word aligned.

---

**Param address** The destination address in flash for the write operation.

**Param buffer** Data for programming

**Param size** Size to program.

void (**\*flash\_encryption\_done**)(void)

flash data encryption operation is done.

void (**\*flash\_encryption\_destroy**)(void)

Destroy encrypted result

bool (**\*flash\_encryption\_check**)(uint32\_t address, uint32\_t length)

Check if is qualified to encrypt the buffer

**Param address** the address of written flash partition.

**Param length** Buffer size.

struct **spi\_flash\_host\_inst\_t**

SPI Flash Host driver instance

### Public Members

const struct *spi\_flash\_host\_driver\_s* \***driver**

Pointer to the implementation function table.

struct **spi\_flash\_host\_driver\_s**

Host driver configuration and context structure.

### Public Members

*esp\_err\_t* (**\*dev\_config**)(*spi\_flash\_host\_inst\_t* \*host)

Configure the device-related register before transactions. This saves some time to re-configure those registers when we send continuously

*esp\_err\_t* (**\*common\_command**)(*spi\_flash\_host\_inst\_t* \*host, *spi\_flash\_trans\_t* \*t)

Send an user-defined spi transaction to the device.

*esp\_err\_t* (**\*read\_id**)(*spi\_flash\_host\_inst\_t* \*host, uint32\_t \*id)

Read flash ID.

void (**\*erase\_chip**)(*spi\_flash\_host\_inst\_t* \*host)

Erase whole flash chip.



`void (*erase_sector)(spi_flash_host_inst_t *host, uint32_t start_address)`

Erase a specific sector by its start address.

`void (*erase_block)(spi_flash_host_inst_t *host, uint32_t start_address)`

Erase a specific block by its start address.

`esp_err_t (*read_status)(spi_flash_host_inst_t *host, uint8_t *out_sr)`

Read the status of the flash chip.

`esp_err_t (*set_write_protect)(spi_flash_host_inst_t *host, bool wp)`

Disable write protection.

`void (*program_page)(spi_flash_host_inst_t *host, const void *buffer, uint32_t address, uint32_t length)`

Program a page of the flash. Check `max_write_bytes` for the maximum allowed writing length.

`bool (*supports_direct_write)(spi_flash_host_inst_t *host, const void *p)`

Check whether the SPI host supports direct write.

When cache is disabled, SPI1 doesn't support directly write when buffer isn't internal.

`int (*write_data_slicer)(spi_flash_host_inst_t *host, uint32_t address, uint32_t len, uint32_t *align_addr, uint32_t page_size)`

Slicer for write data. The `program_page` should be called iteratively with the return value of this function.

**Param address** Beginning flash address to write

**Param len** Length request to write

**Param align\_addr** Output of the aligned address to write to

**Param page\_size** Physical page size of the flash chip

**Return** Length that can be actually written in one `program_page` call

`esp_err_t (*read)(spi_flash_host_inst_t *host, void *buffer, uint32_t address, uint32_t read_len)`

Read data from the flash. Check `max_read_bytes` for the maximum allowed reading length.

`bool (*supports_direct_read)(spi_flash_host_inst_t *host, const void *p)`

Check whether the SPI host supports direct read.

When cache is disabled, SPI1 doesn't support directly read when the given buffer isn't internal.

`int (*read_data_slicer)(spi_flash_host_inst_t *host, uint32_t address, uint32_t len, uint32_t *align_addr, uint32_t page_size)`

Slicer for read data. The `read` should be called iteratively with the return value of this function.

**Param address** Beginning flash address to read

**Param len** Length request to read

**Param align\_addr** Output of the aligned address to read

**Param page\_size** Physical page size of the flash chip

**Return** Length that can be actually read in one `read` call

`uint32_t (*host_status)(spi_flash_host_inst_t *host)`

Check the host status, 0:busy, 1:idle, 2:suspended.

`esp_err_t (*configure_host_io_mode)(spi_flash_host_inst_t *host, uint32_t command, uint32_t addr_bitlen, int dummy_bitlen_base, spi_flash_io_mode_t io_mode)`

Configure the host to work at different read mode. Responsible to compensate the timing and set IO mode.

void (**\*poll\_cmd\_done**)(*spi\_flash\_host\_inst\_t* \*host)

Internal use, poll the HW until the last operation is done.

*esp\_err\_t* (**\*flush\_cache**)(*spi\_flash\_host\_inst\_t* \*host, uint32\_t addr, uint32\_t size)

For some host (SPI1), they are shared with a cache. When the data is modified, the cache needs to be flushed. Left NULL if not supported.

void (**\*check\_suspend**)(*spi\_flash\_host\_inst\_t* \*host)

Suspend check erase/program operation, reserved for ESP32-C3 and ESP32-S3 spi flash ROM IMPL.

void (**\*resume**)(*spi\_flash\_host\_inst\_t* \*host)

Resume flash from suspend manually

void (**\*suspend**)(*spi\_flash\_host\_inst\_t* \*host)

Set flash in suspend status manually

*esp\_err\_t* (**\*sus\_setup**)(*spi\_flash\_host\_inst\_t* \*host, const *spi\_flash\_sus\_cmd\_conf* \*sus\_conf)

Suspend feature setup for setting cmd and status register mask.

## Macros

### **SPI\_FLASH\_TRANS\_FLAG\_CMD16**

Send command of 16 bits.

### **SPI\_FLASH\_TRANS\_FLAG\_IGNORE\_BASEIO**

Not applying the basic io mode configuration for this transaction.

### **SPI\_FLASH\_TRANS\_FLAG\_BYTE\_SWAP**

Used for DTR mode, to swap the bytes of a pair of rising/falling edge.

### **SPI\_FLASH\_TRANS\_FLAG\_PE\_CMD**

Indicates that this transaction is to erase/program flash chip.

### **SPI\_FLASH\_CONFIG\_CONF\_BITS**

OR the io\_mode with this mask, to enable the dummy output feature or replace the first several dummy bits into address to meet the requirements of conf bits. (Used in DIO/QIO/OIO mode)

### **SPI\_FLASH\_OPI\_FLAG**

A flag for flash work in opi mode, the io mode below are opi, above are SPI/QSPI mode. DO NOT use this value in any API.

### **SPI\_FLASH\_READ\_MODE\_MIN**

Slowest io mode supported by ESP32, currently SlowRd.

## Type Definitions

typedef enum *esp\_flash\_speed\_s* **esp\_flash\_speed\_t**

SPI flash clock speed values, always refer to them by the enum rather than the actual value (more speed may be appended into the list).

A strategy to select the maximum allowed speed is to enumerate from the `ESP_FLASH_SPEED_MAX-1` or highest frequency supported by your flash, and decrease the speed until the probing success.

typedef struct *spi\_flash\_host\_driver\_s* **spi\_flash\_host\_driver\_t**

## Enumerations

enum **esp\_flash\_speed\_s**

SPI flash clock speed values, always refer to them by the enum rather than the actual value (more speed may be appended into the list).

A strategy to select the maximum allowed speed is to enumerate from the `ESP_FLASH_SPEED_MAX-1` or highest frequency supported by your flash, and decrease the speed until the probing success.

*Values:*

enumerator **ESP\_FLASH\_5MHZ**

The flash runs under 5MHz.

enumerator **ESP\_FLASH\_10MHZ**

The flash runs under 10MHz.

enumerator **ESP\_FLASH\_20MHZ**

The flash runs under 20MHz.

enumerator **ESP\_FLASH\_26MHZ**

The flash runs under 26MHz.

enumerator **ESP\_FLASH\_40MHZ**

The flash runs under 40MHz.

enumerator **ESP\_FLASH\_80MHZ**

The flash runs under 80MHz.

enumerator **ESP\_FLASH\_120MHZ**

The flash runs under 120MHz, 120MHZ can only be used by main flash after timing tuning in system. Do not use this directly in any API.

enumerator **ESP\_FLASH\_SPEED\_MAX**

The maximum frequency supported by the host is `ESP_FLASH_SPEED_MAX-1`.

enum **esp\_flash\_io\_mode\_t**

Mode used for reading from SPI flash.

*Values:*

enumerator **SPI\_FLASH\_SLOWRD**

Data read using single I/O, some limits on speed.

enumerator **SPI\_FLASH\_FASTRD**

Data read using single I/O, no limit on speed.

enumerator **SPI\_FLASH\_DOUT**

Data read using dual I/O.

enumerator **SPI\_FLASH\_DIO**

Both address & data transferred using dual I/O.

enumerator **SPI\_FLASH\_QOUT**

Data read using quad I/O.

enumerator **SPI\_FLASH\_QIO**

Both address & data transferred using quad I/O.

enumerator **SPI\_FLASH\_OPI\_STR**

Only support on OPI flash, flash read and write under STR mode.

enumerator **SPI\_FLASH\_OPI\_DTR**

Only support on OPI flash, flash read and write under DTR mode.

enumerator **SPI\_FLASH\_READ\_MODE\_MAX**

The fastest io mode supported by the host is `ESP_FLASH_READ_MODE_MAX-1`.

### Header File

- [components/hal/include/hal/esp\\_flash\\_err.h](#)
- This header file can be included with:

```
#include "hal/esp_flash_err.h"
```

### Macros

**ESP\_ERR\_FLASH\_NOT\_INITIALISED**

`esp_flash_chip_t` structure not correctly initialised by `esp_flash_init()`.

**ESP\_ERR\_FLASH\_UNSUPPORTED\_HOST**

Requested operation isn't supported via this host SPI bus (`chip->spi` field).

**ESP\_ERR\_FLASH\_UNSUPPORTED\_CHIP**

Requested operation isn't supported by this model of SPI flash chip.

**ESP\_ERR\_FLASH\_PROTECTED**

Write operation failed due to chip's write protection being enabled.

### Enumerations

enum **[anonymous]**

*Values:*

enumerator **ESP\_ERR\_FLASH\_SIZE\_NOT\_MATCH**

The chip doesn't have enough space for the current partition table.

enumerator **ESP\_ERR\_FLASH\_NO\_RESPONSE**

Chip did not respond to the command, or timed out.

### Header File

- [components/spi\\_flash/include/esp\\_spi\\_flash\\_counters.h](#)
- This header file can be included with:

```
#include "esp_spi_flash_counters.h"
```

- This header file is a part of the API provided by the `spi_flash` component. To declare that your component depends on `spi_flash`, add the following to your `CMakeLists.txt`:

```
REQUIRES spi_flash
```

or

```
PRIV_REQUIRES spi_flash
```

### Functions

void **esp\_flash\_reset\_counters** (void)

Reset SPI flash operation counters.

void **spi\_flash\_reset\_counters** (void)

void **esp\_flash\_dump\_counters** (FILE \*stream)

Print SPI flash operation counters.

void **spi\_flash\_dump\_counters** (void)

const [esp\\_flash\\_counters\\_t](#) \***esp\_flash\_get\_counters** (void)

Return current SPI flash operation counters.

返回 pointer to the [esp\\_flash\\_counters\\_t](#) structure holding values of the operation counters

const [spi\\_flash\\_counters\\_t](#) \***spi\_flash\_get\_counters** (void)

### Structures

struct **esp\_flash\_counter\_t**

Structure holding statistics for one type of operation

#### Public Members

uint32\_t **count**

number of times operation was executed

uint32\_t **time**

total time taken, in microseconds

uint32\_t **bytes**

total number of bytes

struct **esp\_flash\_counters\_t**

Structure for counters of flash actions

### Public Members

*esp\_flash\_counter\_t* **read**

counters for read action, like `esp_flash_read`

*esp\_flash\_counter\_t* **write**

counters for write action, like `esp_flash_write`

*esp\_flash\_counter\_t* **erase**

counters for erase action, like `esp_flash_erase`

### Type Definitions

typedef *esp\_flash\_counter\_t* **spi\_flash\_counter\_t**

typedef *esp\_flash\_counters\_t* **spi\_flash\_counters\_t**

### flash 加密 API 参考

#### Header File

- [components/bootloader\\_support/include/esp\\_flash\\_encrypt.h](#)
- This header file can be included with:

```
#include "esp_flash_encrypt.h"
```

- This header file is a part of the API provided by the `bootloader_support` component. To declare that your component depends on `bootloader_support`, add the following to your `CMakeLists.txt`:

```
REQUIRES bootloader_support
```

or

```
PRIV_REQUIRES bootloader_support
```

#### Functions

bool **esp\_flash\_encryption\_enabled** (void)

Is flash encryption currently enabled in hardware?

Flash encryption is enabled if the `FLASH_CRYPT_CNT` efuse has an odd number of bits set.

**返回** true if flash encryption is enabled.

*esp\_err\_t* **esp\_flash\_encrypt\_check\_and\_update** (void)

bool **esp\_flash\_encrypt\_state** (void)

Returns the Flash Encryption state and prints it.

**返回** True - Flash Encryption is enabled False - Flash Encryption is not enabled

bool **esp\_flash\_encrypt\_initialized\_once** (void)

Checks if the first initialization was done.

If the first initialization was done then FLASH\_CRYPT\_CNT != 0

返回 true - the first initialization was done false - the first initialization was NOT done

*esp\_err\_t* **esp\_flash\_encrypt\_init** (void)

The first initialization of Flash Encryption key and related eFuses.

返回 ESP\_OK if all operations succeeded

*esp\_err\_t* **esp\_flash\_encrypt\_contents** (void)

Encrypts flash content.

返回 ESP\_OK if all operations succeeded

*esp\_err\_t* **esp\_flash\_encrypt\_enable** (void)

Activates Flash encryption on the chip.

It burns FLASH\_CRYPT\_CNT eFuse based on the CONFIG\_SECURE\_FLASH\_ENCRYPTION\_MODE\_RELEASE option.

返回 ESP\_OK if all operations succeeded

bool **esp\_flash\_encrypt\_is\_write\_protected** (bool print\_error)

Returns True if the write protection of FLASH\_CRYPT\_CNT is set.

参数 **print\_error** -- Print error if it is write protected

返回 true - if FLASH\_CRYPT\_CNT is write protected

*esp\_err\_t* **esp\_flash\_encrypt\_region** (uint32\_t src\_addr, size\_t data\_length)

Encrypt-in-place a block of flash sectors.

---

备注: This function resets RTC\_WDT between operations with sectors.

---

#### 参数

- **src\_addr** -- Source offset in flash. Should be multiple of 4096 bytes.
- **data\_length** -- Length of data to encrypt in bytes. Will be rounded up to next multiple of 4096 bytes.

返回 ESP\_OK if all operations succeeded, ESP\_ERR\_FLASH\_OP\_FAIL if SPI flash fails, ESP\_ERR\_FLASH\_OP\_TIMEOUT if flash times out.

void **esp\_flash\_write\_protect\_crypt\_cnt** (void)

Write protect FLASH\_CRYPT\_CNT.

Intended to be called as a part of boot process if flash encryption is enabled but secure boot is not used. This should protect against serial re-flashing of an unauthorised code in absence of secure boot.

---

备注: On ESP32 V3 only, write protecting FLASH\_CRYPT\_CNT will also prevent disabling UART Down-load Mode. If both are wanted, call esp\_efuse\_disable\_rom\_download\_mode() before calling this function.

---

*esp\_flash\_enc\_mode\_t* **esp\_get\_flash\_encryption\_mode** (void)

Return the flash encryption mode.

The API is called during boot process but can also be called by application to check the current flash encryption mode of ESP32

返回

void **esp\_flash\_encryption\_init\_checks** (void)

Check the flash encryption mode during startup.

Verifies the flash encryption config during startup:

- Correct any insecure flash encryption settings if hardware Secure Boot is enabled.
- Log warnings if the efuse config doesn't match the project config in any way

---

**备注:** This function is called automatically during app startup, it doesn't need to be called from the app.

---

bool **esp\_flash\_encryption\_cfg\_verify\_release\_mode** (void)

Returns the verification status for all physical security features of flash encryption in release mode.

If the device has flash encryption feature configured in the release mode, then it is highly recommended to call this API in the application startup code. This API verifies the sanity of the eFuse configuration against the release (production) mode of the flash encryption feature.

**返回**

- True - all eFuses are configured correctly
- False - not all eFuses are configured correctly.

void **esp\_flash\_encryption\_set\_release\_mode** (void)

Switches Flash Encryption from "Development" to "Release".

If already in "Release" mode, the function will do nothing. If flash encryption efuse is not enabled yet then abort. It burns:

- "disable encrypt in dl mode"
- set FLASH\_CRYPT\_CNT efuse to max

## Enumerations

enum **esp\_flash\_enc\_mode\_t**

*Values:*

enumerator **ESP\_FLASH\_ENC\_MODE\_DISABLED**

enumerator **ESP\_FLASH\_ENC\_MODE\_DEVELOPMENT**

enumerator **ESP\_FLASH\_ENC\_MODE\_RELEASE**

### 2.6.24 SPI 主机驱动程序

SPI 主机驱动程序是一个软件程序，用于在 ESP32-H2 的通用 SPI (GP-SPI) 外设工作在主控模式时，对其进行控制。

有关 GP-SPI 硬件相关信息，请参考 [ESP32-H2 技术参考手册 > SPI 控制器 \[PDF\]](#)。



## 术语

下表为 SPI 主机驱动的相关术语。

术语	定义
主机 (Host)	ESP32-H2 内置的 SPI 控制器外设。用作 SPI 主机，在总线上发起 SPI 传输。
设备 (Device)	SPI 从机设备。一条 SPI 总线与一或多个设备连接。每个设备共享 MOSI、MISO 和 SCLK 信号，但只有当主机向设备的专属 CS 线发出信号时，设备才会在总线上处于激活状态。
总线 (Bus)	信号总线，由连接到同一主机的所有设备共用。一般来说，每条总线包括以下线：MISO、MOSI、SCLK、一条或多条 CS 线，以及可选的 QUADWP 和 QUADHD。因此，除每个设备都有单独的 CS 线外，所有设备都连接在相同的线下。多个设备也可以菊花链的方式共享一条 CS 线。
MOSI	主机输出，从机输入，也写作 D。数据从主机发送至设备。在 Octal/OPI 模式下也表示为 data0 信号。
MISO	主机输入，从机输出，也写作 Q。数据从设备发送至主机。在 Octal/OPI 模式下也表示为 data1 信号。
SCLK	串行时钟。由主机产生的振荡信号，使数据位的传输保持同步。
CS	片选。允许主机选择连接到总线上的单个设备，以便发送或接收数据。
QUADWP	写保护信号。只用于 4 位 (qio/qout) 传输。在 Octal/OPI 模式下也表示为 data2 信号。
QUADHD	保持信号。只用于 4 位 (qio/qout) 传输。在 Octal/OPI 模式下也表示为 data3 信号。
DATA4	在 Octal/OPI 模式下表示为 data4 信号。
DATA5	在 Octal/OPI 模式下表示为 data5 信号。
DATA6	在 Octal/OPI 模式下表示为 data6 信号。
DATA7	在 Octal/OPI 模式下表示为 data7 信号。
断言 (Assertion)	指激活一条线路的操作。
去断言 (De-assertion)	指将线路恢复到非活动状态（回到空闲状态）的操作。
传输事务 (Transaction)	即主机断言设备的 CS 线，向设备发送数据/从设备读取数据，接着去断言 CS 线的过程。传输事务为原子操作，不可打断。
发射沿 (Launch Edge)	源寄存器将信号发射到线路上的时钟边沿。
锁存沿 (Latch Edge)	目的寄存器锁存信号的时钟边沿。

## 主机驱动特性

SPI 主机驱动程序负责管理主机与设备间的通信，具有以下特性：

- 支持多线程环境使用
- 读写数据过程中 DMA 透明传输
- 同一信号总线上不同设备的数据可自动时分复用，请参阅[SPI 总线锁](#)。

**警告：** SPI 主机驱动允许总线上连接多个设备（共享单个 ESP32-H2 SPI 外设）。每个设备仅由一个任务访问时，驱动程序线程安全。反之，若多个任务尝试访问同一 SPI 设备，则驱动程序 **非线程安全**。此时，建议执行以下任一操作：

- 重构应用程序，确保每个 SPI 外设在同一时间仅由一个任务访问。使用 `spi_bus_config_t::isr_cpu_id` 将 SPI ISR 注册到与 SPI 外设相关任务相同的内核，以确保线程安全。
- 使用 `xSemaphoreCreateMutex` 为共享设备添加互斥锁。

## SPI 传输事务

SPI 总线传输事务由五个阶段构成，详见下表（任意阶段均可跳过）。

阶段名称	描述
命令阶段 (Command)	在此阶段，主机向总线发送命令字段，长度为 0-16 位。
地址阶段 (Address)	在此阶段，主机向总线发送地址字段，长度为 0-32 位。
Dummy 阶段	此阶段可自行配置，用于适配时序要求。
写入阶段 (Write)	此阶段主机向设备传输数据，这些数据在紧随命令阶段（可选）和地址阶段（可选）之后。从电平的角度来看，数据与命令没有区别。
读取阶段 (Read)	此阶段主机读取设备数据。

传输事务属性由总线配置结构体 `spi_bus_config_t`、设备配置结构体 `spi_device_interface_config_t` 和传输事务配置结构体 `spi_transaction_t` 共同决定。

一个 SPI 主机可以发送全双工传输事务，此时读取和写入阶段同步进行。传输事务总长度取决于以下结构体成员长度总和：

- `spi_device_interface_config_t::command_bits`
- `spi_device_interface_config_t::address_bits`
- `spi_transaction_t::length`

而 `spi_transaction_t::rxlength` 则决定了接收到的数据包长度。

在半双工传输事务中，读取和写入阶段独立进行（一次一个方向）。写入和读取阶段的长度由 `spi_transaction_t::length` 和 `spi_transaction_t::rxlength` 分别决定。

并非每个 SPI 设备都要求命令和/或地址，因此命令阶段和地址阶段为可选项。这反映在设备的配置中：如果 `spi_device_interface_config_t::command_bits` 和/或 `spi_device_interface_config_t::address_bits` 被设置为零，则不会唤起命令或地址阶段。

并非每个传输事务都需要写入和读取数据，因此读取和写入阶段也是可选项。如果将 `spi_transaction_t::rx_buffer` 设置为 NULL，且未设置 `SPI_TRANS_USE_RXDATA`，读取阶段将被跳过。如果将 `spi_transaction_t::tx_buffer` 设置为 NULL，且未设置 `SPI_TRANS_USE_TXDATA`，写入阶段将被跳过。

主机驱动程序支持两种类型的传输事务：中断传输事务和轮询传输事务。用户可以选择在不同设备上使用不同的传输事务类型。若设备需要同时使用两种传输事务类型，请参阅[向同一设备发送混合传输事务的注意事项](#)。

**中断传输事务** 中断传输事务将阻塞传输事务程序，直至传输事务完成，以使 CPU 运行其他任务程序。

应用任务中可以将多个传输事务加入到队列中，驱动程序将在中断服务程序 (ISR) 中自动逐一发送队列中的数据。在所有传输事务完成以前，任务可切换到其他程序中。

**轮询传输事务** 轮询传输事务不依赖于中断，程序将不断轮询 SPI 主机的状态位，直到传输事务完成。

所有执行中断传输事务的任务都可能被队列阻塞。在此情况下，用户需要等待 ISR 和传输事务传输完成。轮询传输事务节省了原本用于队列处理和上下文切换的时间，减少了传输事务持续时间。传输事务类型的缺点是在这些事务进行期间，CPU 将被占用而处于忙碌状态。

传输事务完成后，`spi_device_polling_end()` 程序需要至少 1  $\mu$ s 的时间来解除阻塞其他任务。此处强烈建议调用函数 `spi_device_acquire_bus()` 和 `spi_device_release_bus()` 来打包一系列轮询传输事务以避免开销。详情请参阅[获取总线](#)。

**传输线模式配置** ESP32-H2 支持的线路模式如下。要使用这些模式，请在结构体 `spi_transaction_t` 中设置 flags，如传输事务标志信号一栏所示。要检查相应的 IO 管脚是否被设置，请在 `spi_bus_config_t` 中设置 flags，如总线 IO 设置标志信号一栏所示。

模式	命令位宽	地址位宽	数据位宽	传输事务标志信号	总线 IO 设置标志信号
普通 SPI 模式	1	1	1	0	0
双线输出模式	1	1	2	SPI_TRANS_MODE_DUAL	SPICOM-MON_BUSFLAG_DUAL
双线 I/O 模式	1	2	2	SPI_TRANS_MODE_DUAL SPI_TRANS_MULTILINE	SPICOM-MON_BUSFLAG_DUAL
四线输出模式	1	1	4	SPI_TRANS_MODE_QUAD	SPICOM-MON_BUSFLAG_QUAD
四线 I/O 模式	1	4	4	SPI_TRANS_MODE_QUAD SPI_TRANS_MULTILINE	SPICOM-MON_BUSFLAG_QUAD

**命令阶段和地址阶段** 在命令阶段和地址阶段, `spi_transaction_t::cmd` 和 `spi_transaction_t::addr` 将被发送到总线, 该过程中无数据读取。命令阶段和地址阶段的默认长度通过调用 `spi_bus_add_device()` 在 `spi_device_interface_config_t` 中设置。如果 `spi_transaction_t::flags` 中的标志信号 `SPI_TRANS_VARIABLE_CMD` 和 `SPI_TRANS_VARIABLE_ADDR` 未设置, 则驱动程序将在设备初始化期间自动将这些阶段的长度设置为默认值。

如需更改命令阶段和地址阶段的长度, 可通过以下步骤实现: 声明结构体 `spi_transaction_ext_t`, 在 `spi_transaction_ext_t::base` 中设置标志信号 `SPI_TRANS_VARIABLE_CMD` 和/或 `SPI_TRANS_VARIABLE_ADDR`, 随后按正常步骤完成余下配置。这样一来, 各阶段的长度将等于结构体 `spi_transaction_ext_t` 中设置的 `spi_transaction_ext_t::command_bits` 和 `spi_transaction_ext_t::address_bits` 长度。

如果需要命令阶段和地址阶段的线数与数据阶段保持一致, 则应在结构体 `spi_transaction_t` 中将 `SPI_TRANS_MULTILINE_CMD` 和/或 `SPI_TRANS_MULTILINE_ADDR` 设置进该结构体的 `flags` 成员变量。请参阅 [传输线模式配置](#)。

**写入和读取阶段** 一般而言, 需要传输到设备或由设备读取的数据将由 `spi_transaction_t::rx_buffer` 和 `spi_transaction_t::tx_buffer` 指向的内存块中读取或写入。如果传输时启用了 DMA, 则缓冲区应:

1. 申请支持 DMA 的内存。具体操作请参阅 [支持 DMA 的内存](#)。
2. 32 位对齐 (从 32 位边界开始, 长度为 4 字节的倍数)。

若未满足以上要求, 传输事务效率将受到临时缓冲区分配和复制的影响。

如果使用多条数据线传输, 请在结构体 `spi_device_interface_config_t` 中的 `flags` 设置 `SPI_DEVICE_HALFDUPLEX` 标志信号。结构体 `spi_transaction_t` 中的 `flags` 应按照 [传输线模式配置](#) 中的描述设置。

---

**备注:** 不支持同时具有读取和写入阶段的半双工传输事务。请使用全双工模式。

---

**获取总线** 若需连续发送专门的 SPI 传输事务以提高效率, 可采用获取总线的方式。获取总线后, 与其他设备间的传输事务 (包括轮询传输事务或中断传输事务) 将处于待处理状态, 直到总线被释放。要获取和释放总线, 请调用函数 `spi_device_acquire_bus()` 和 `spi_device_release_bus()`。

### 使用驱动程序

- 通过调用函数 `spi_bus_initialize()` 初始化 SPI 总线。确保在结构体 `spi_bus_config_t` 中设置正确的 I/O 管脚。不需要的信号设置为 -1。
- 通过调用函数 `spi_bus_add_device()` 注册连接到总线的设备。确保用参数 `dev_config` 配置设备可能需要的任何时序要求。完成上述操作后可获得设备句柄, 以便在向设备发送传输事务时使用。

- 要与设备交互，请在—个或多个 `spi_transaction_t` 结构体中填充所需的传输事务参数，随后使用轮询传输事务或中断传输事务发送这些结构体：
  - **中断传输事务** 调用函数 `spi_device_queue_trans()` 将传输事务添加到队列中，随后使用函数 `spi_device_get_trans_result()` 查询结果，或将所有请求输入 `spi_device_transmit()` 实现同步处理。
  - **轮询传输事务** 调用函数 `spi_device_polling_transmit()` 发送轮询传输事务。若有插入内容的需要，也可使用 `spi_device_polling_start()` 和 `spi_device_polling_end()` 发送传输事务。
- (可选) 若要向设备发送背对背传输事务，请在发送传输事务前调用函数 `spi_device_acquire_bus()`，并在发送传输事务后调用函数 `spi_device_release_bus()`。
- (可选) 要从总线上移除特定设备，请以设备句柄为参数调用函数 `spi_bus_remove_device()`。
- (可选) 要复位 (或重置) 总线，请确保总线上未连接其他设备，并调用函数 `spi_bus_free()`。

SPI 主机驱动程序的示例代码存放在 ESP-IDF 示例项目的 `peripherals/spi_master` 目录下。

**传输数据小于 32 位的传输事务** 当传输事务数据等于或小于 32 位时，为数据分配—个缓冲区将是—个较好的选择。实际上，数据可以直接存储于传输事务结构体中。对已传输的数据，可通过调用函数 `spi_transaction_t::tx_data` 并在传输时设置 `SPI_TRANS_USE_TXDATA` 标志信号来实现。对已接收的数据，可通过调用函数 `spi_transaction_t::rx_data` 并设置 `SPI_TRANS_USE_RXDATA` 来实现。在这两种情况下，请勿修改 `spi_transaction_t::tx_buffer` 或 `spi_transaction_t::rx_buffer`，因为它们与 `spi_transaction_t::tx_data` 和 `spi_transaction_t::rx_data` 的内存位置相同。

**非 `uint8_t` 的整数传输事务** SPI 主机逐字节地将数据读入和写入内存。默认情况下，数据优先以最高有效位 (MSB) 发送，极少数情况下会优先使用最低有效位 (LSB)。如果需要发送—个小于 8 位的值，这些位应以 MSB 优先的方式写入内存。

例如，如果需要发送 `0b00010`，则应将其写成 `uint8_t` 变量，读取长度设置为 5 位。此时，设备仍然会收到 8 位数据，并另有 3 个“随机”位，所以读取过程必须准确。

此外，ESP32-H2 属于小端芯片，即 `uint16_t` 和 `uint32_t` 变量的最低有效位存储在最小的地址。因此，如果 `uint16_t` 存储在内存中，则首先发送位 [7:0]，其次是位 [15:8]。

在某些情况下，要传输的数据大小与 `uint8_t` 数组不同，可使用以下宏将数据转换为可由 SPI 驱动直接发送的格式：

- 需传输的数据，使用 `SPI_SWAP_DATA_TX`
- 接收到的数据，使用 `SPI_SWAP_DATA_RX`

**向同一设备发送混合传输事务的注意事项** 为避免代码过于复杂，请—次只向单个设备发送—种类型的传输事务 (中断或轮询)。如有需要，可交替发送中断传输事务和轮询传输事务，详见下文。

所有的轮询传输事务和中断传输事务完成后，方可发送轮询传输事务。

由于未完成的轮询传输事务将阻塞其他传输事务，请务必在 `spi_device_polling_start()` 之后调用函数 `spi_device_polling_end()` 以允许其他事务或其他设备使用总线。如果在轮询过程中无需切换到其他任务，可调用函数 `spi_device_polling_transmit()` 启动传输事务，则该传输事务将自动结束。

ISR 会干扰飞行中的轮询传输事务，以适应中断传输事务。在调用 `spi_device_polling_start()` 前，需确保所有发送到 ISR 的中断传输事务已经完成。为此可持续调用 `spi_device_get_trans_result()`，直至全部传输事务返回。

为更好地控制函数的调用顺序，只在单个任务中向同一设备发送混合传输事务。

**GPIO 矩阵与 IO\_MUX 管脚** 芯片的大多数外围信号都与之专用的 IO\_MUX 管脚连接，但这些信号也可以通过较不直接的 GPIO 矩阵路由到任何其他可用的管脚。只要有一个信号是通过 GPIO 矩阵路由的，那么所有的信号都将通过它路由。



当 SPI 主机被设置为 80 MHz 或更低的频率时，通过 GPIO 矩阵路由 SPI 管脚的行为将与通过 IOMUX 路由相同。

SPI 总线的 IO\_MUX 管脚如下表所示。

管脚名称	GPIO 编号 (SPI2)
CS0 <sup>1</sup>	1
SCLK	4
MISO	0
MOSI	5
QUADWP	2
QUADHD	3

### 传输速度的影响因素

传输速度主要有以下三个限制因素

- 传输事务间隔时间
- SPI 时钟频率
- 缓存缺失的 SPI 函数，包括回调

影响大传输事务传输速度的主要参数是时钟频率。而多个小传输事务的传输速度主要由传输事务间隔时长决定。

**传输事务持续时间** 传输事务持续时间包括设置 SPI 外设寄存器，将数据复制到 FIFO 或设置 DMA 链接，以及 SPI 传输事务时间。

中断传输事务允许附加额外的开销，以适应 FreeRTOS 队列的成本以及任务与 ISR 切换所需的时间。

对于 **中断传输事务**，CPU 可以在传输事务进行过程中切换到其他任务，这能够节约 CPU 时间，会延长传输事务持续时间，请参阅 [中断传输事务](#)。对于 **轮询传输事务**，它不会阻塞任务，但允许在传输事务进行时轮询。详情请参阅 [轮询传输事务](#)。

如果 DMA 被启用，每个传输事务设置链接列表需要约 2  $\mu$ s。当主机传输数据时，它会自动从链接列表中读取数据。如果不启用 DMA，CPU 必须自己从 FIFO 中写入和读取每个字节。这一过程时长通常不到 2  $\mu$ s，但写入和读取的传输事务长度都被限制在 64 字节。

单个字节数据的典型传输事务持续时间如下。

- 使用 DMA 的中断传输事务：58  $\mu$ s。
- 使用 CPU 的中断传输事务：54  $\mu$ s。
- 使用 DMA 的轮询传输事务：28  $\mu$ s。
- 使用 CPU 的轮询传输事务：24  $\mu$ s。

请注意，以上数据测试时，`CONFIG_SPI_MASTER_ISR_IN_IRAM` 选项处于启用状态，SPI 传输事务相关的代码放置在 IRAM 中。若关闭此选项（例如为了节省 IRAM），可能影响传输事务持续时间。

**SPI 时钟频率** GPSPI 外设的时钟源可以通过设置 `spi_device_handle_t::cfg::clock_source` 选择，可用的时钟源请参阅 [spi\\_clock\\_source\\_t](#)。

默认情况下，驱动程序将把 `spi_device_handle_t::cfg::clock_source` 设置为 `SPI_CLK_SRC_DEFAULT`。这往往代表 GPSPI 时钟源中的最高频率，在不同的芯片中这一数值会有所不同。

设备的实际时钟频率可能不完全等于所设置的数字，驱动会将其重新计算为与硬件兼容的最接近的数字，并且不超过时钟源的时钟频率。调用函数 `spi_device_get_actual_freq()` 以了解驱动计算的频率。

写入或读取阶段的理论最大传输速度可根据下表计算：

<sup>1</sup> 只有连接到总线的设备可以使用 CS0 管脚。

写入/读取阶段的线宽	速度 (Bps)
1-Line	$SPI \text{ 频率} / 8$
2-Line	$SPI \text{ 频率} / 4$
4-Line	$SPI \text{ 频率} / 2$

其他阶段（命令阶段、地址阶段、Dummy 阶段）的传输速度计算与此类似。

**缓存缺失** 默认配置只将 ISR 置于 IRAM 中。其他 SPI 相关功能，包括驱动本身和回调都可能发生缓存缺失，需等待代码从 flash 中读取。为避免缓存缺失，可参考 [CONFIG\\_SPI\\_MASTER\\_IN\\_IRAM](#)，将整个 SPI 驱动置入 IRAM，并将整个回调及其 callee 函数一起置入 IRAM。

**备注：** SPI 驱动是基于 FreeRTOS 的 API 实现的，在使用 [CONFIG\\_SPI\\_MASTER\\_IN\\_IRAM](#) 时，不得启用 [CONFIG\\_FREERTOS\\_PLACE\\_FUNCTIONS\\_INTO\\_FLASH](#)。

单个中断传输事务传输 n 字节的总成本为  $20+8n/F_{spi}[MHz]$  [ $\mu s$ ]，故传输速度为  $n/(20+8n/F_{spi})$ 。8 MHz 时钟速度的传输速度见下表。

频率 (MHz)	传输事务间隔 ( $\mu s$ )	传输事务长度 (bytes)	传输时长 ( $\mu s$ )	传输速度 (KBps)
8	25	1	26	38.5
8	25	8	33	242.4
8	25	16	41	490.2
8	25	64	89	719.1
8	25	128	153	836.6

传输事务长度较短时将提高传输事务间隔成本，因此应尽可能将几个短传输事务压缩成一个传输事务，以提升传输速度。

注意，ISR 在 flash 操作期间默认处于禁用状态。要在 flash 操作期间继续发送传输事务，请启用 [CONFIG\\_SPI\\_MASTER\\_ISR\\_IN\\_IRAM](#)，并在 `spi_bus_config_t::intr_flags` 中设置 [ESP\\_INTR\\_FLAG\\_IRAM](#)。此时，flash 操作前列队的传输事务将由 ISR 并行处理。此外，每个设备的回调和它们的 callee 函数都应该在 IRAM 中，避免回调因缓存丢失而崩溃。详情请参阅 [IRAM 安全中断处理程序](#)。

## 应用示例

查看使用 SPI 主机驱动程序在半双工模式下读取/写入 AT93C46D EEPROM（8 位模式）的示例代码，请前往 ESP-IDF 示例的 [peripherals/spi\\_master/hd\\_eeprom](#) 目录。

查看使用 SPI 主机驱动程序在全双工模式下驱动 LCD 屏幕（如 ST7789V 或 ILI9341）的示例代码，请前往 ESP-IDF 示例的 [peripherals/spi\\_master/lcd](#) 目录。

## API 参考 - SPI Common

### Header File

- [components/hal/include/hal/spi\\_types.h](#)
- This header file can be included with:

```
#include "hal/spi_types.h"
```

## Structures

struct **spi\_line\_mode\_t**

Line mode of SPI transaction phases: CMD, ADDR, DOUT/DIN.

## Public Members

uint8\_t **cmd\_lines**

The line width of command phase, e.g. 2-line-cmd-phase.

uint8\_t **addr\_lines**

The line width of address phase, e.g. 1-line-addr-phase.

uint8\_t **data\_lines**

The line width of data phase, e.g. 4-line-data-phase.

## Type Definitions

typedef *soc\_periph\_spi\_clk\_src\_t* **spi\_clock\_source\_t**

Type of SPI clock source.

## Enumerations

enum **spi\_host\_device\_t**

Enum with the three SPI peripherals that are software-accessible in it.

*Values:*

enumerator **SPI1\_HOST**

SPI1.

enumerator **SPI2\_HOST**

SPI2.

enumerator **SPI\_HOST\_MAX**

invalid host value

enum **spi\_event\_t**

SPI Events.

*Values:*

enumerator **SPI\_EV\_BUF\_TX**

The buffer has sent data to master.

enumerator **SPI\_EV\_BUF\_RX**

The buffer has received data from master.

enumerator **SPI\_EV\_SEND\_DMA\_READY**

Slave has loaded its TX data buffer to the hardware (DMA).

enumerator **SPI\_EV\_SEND**

Master has received certain number of the data, the number is determined by Master.

enumerator **SPI\_EV\_RECV\_DMA\_READY**

Slave has loaded its RX data buffer to the hardware (DMA).

enumerator **SPI\_EV\_RECV**

Slave has received certain number of data from master, the number is determined by Master.

enumerator **SPI\_EV\_CMD9**

Received CMD9 from master.

enumerator **SPI\_EV\_CMDA**

Received CMDA from master.

enumerator **SPI\_EV\_TRANS**

A transaction has done.

enum **spi\_command\_t**

SPI command.

*Values:*

enumerator **SPI\_CMD\_HD\_WRBUF**

enumerator **SPI\_CMD\_HD\_RDBUF**

enumerator **SPI\_CMD\_HD\_WRDMA**

enumerator **SPI\_CMD\_HD\_RDDMA**

enumerator **SPI\_CMD\_HD\_SEG\_END**

enumerator **SPI\_CMD\_HD\_EN\_QPI**

enumerator **SPI\_CMD\_HD\_WR\_END**

enumerator **SPI\_CMD\_HD\_INT0**

enumerator **SPI\_CMD\_HD\_INT1**

enumerator **SPI\_CMD\_HD\_INT2**

### Header File

- [components/esp\\_driver\\_spi/include/driver/spi\\_common.h](#)
- This header file can be included with:



```
#include "driver/spi_common.h"
```

- This header file is a part of the API provided by the `esp_driver_spi` component. To declare that your component depends on `esp_driver_spi`, add the following to your `CMakeLists.txt`:

```
REQUIRES esp_driver_spi
```

or

```
PRIV_REQUIRES esp_driver_spi
```

## Functions

`esp_err_t spi_bus_initialize` (*spi\_host\_device\_t* host\_id, const *spi\_bus\_config\_t* \*bus\_config, *spi\_dma\_chan\_t* dma\_chan)

Initialize a SPI bus.

**警告:** SPI0/1 is not supported

**警告:** If a DMA channel is selected, any transmit and receive buffer used should be allocated in DMA-capable memory.

**警告:** The ISR of SPI is always executed on the core which calls this function. Never starve the ISR on this core or the SPI transactions will not be handled.

### 参数

- **host\_id** -- SPI peripheral that controls this bus
- **bus\_config** -- Pointer to a *spi\_bus\_config\_t* struct specifying how the host should be initialized
- **dma\_chan** -- - Selecting a DMA channel for an SPI bus allows transactions on the bus with size only limited by the amount of internal memory.
  - Selecting `SPI_DMA_DISABLED` limits the size of transactions.
  - Set to `SPI_DMA_DISABLED` if only the SPI flash uses this bus.
  - Set to `SPI_DMA_CH_AUTO` to let the driver to allocate the DMA channel.

### 返回

- `ESP_ERR_INVALID_ARG` if configuration is invalid
- `ESP_ERR_INVALID_STATE` if host already is in use
- `ESP_ERR_NOT_FOUND` if there is no available DMA channel
- `ESP_ERR_NO_MEM` if out of memory
- `ESP_OK` on success

`esp_err_t spi_bus_free` (*spi\_host\_device\_t* host\_id)

Free a SPI bus.

**警告:** In order for this to succeed, all devices have to be removed first.

**参数** **host\_id** -- SPI peripheral to free

### 返回

- `ESP_ERR_INVALID_ARG` if parameter is invalid
- `ESP_ERR_INVALID_STATE` if bus hasn't been initialized before, or not all devices on the bus are freed
- `ESP_OK` on success

## Structures

struct **spi\_bus\_config\_t**

This is a configuration structure for a SPI bus.

You can use this structure to specify the GPIO pins of the bus. Normally, the driver will use the GPIO matrix to route the signals. An exception is made when all signals either can be routed through the IO\_MUX or are -1. In that case, the IO\_MUX is used. On ESP32, using GPIO matrix will bring about 25ns of input delay, which may cause incorrect read for >40MHz speeds.

---

**备注:** Be advised that the slave driver does not use the quadwp/quadhd lines and fields in *spi\_bus\_config\_t* referring to these lines will be ignored and can thus safely be left uninitialized.

---

## Public Members

int **mosi\_io\_num**

GPIO pin for Master Out Slave In (=spi\_d) signal, or -1 if not used.

int **data0\_io\_num**

GPIO pin for spi data0 signal in quad/octal mode, or -1 if not used.

int **miso\_io\_num**

GPIO pin for Master In Slave Out (=spi\_q) signal, or -1 if not used.

int **data1\_io\_num**

GPIO pin for spi data1 signal in quad/octal mode, or -1 if not used.

int **sclk\_io\_num**

GPIO pin for SPI Clock signal, or -1 if not used.

int **quadwp\_io\_num**

GPIO pin for WP (Write Protect) signal, or -1 if not used.

int **data2\_io\_num**

GPIO pin for spi data2 signal in quad/octal mode, or -1 if not used.

int **quadhd\_io\_num**

GPIO pin for HD (Hold) signal, or -1 if not used.

int **data3\_io\_num**

GPIO pin for spi data3 signal in quad/octal mode, or -1 if not used.

int **data4\_io\_num**

GPIO pin for spi data4 signal in octal mode, or -1 if not used.

int **data5\_io\_num**

GPIO pin for spi data5 signal in octal mode, or -1 if not used.

int **data6\_io\_num**

GPIO pin for spi data6 signal in octal mode, or -1 if not used.

int **data7\_io\_num**

GPIO pin for spi data7 signal in octal mode, or -1 if not used.

int **max\_transfer\_sz**

Maximum transfer size, in bytes. Defaults to 4092 if 0 when DMA enabled, or to SOC\_SPI\_MAXIMUM\_BUFFER\_SIZE if DMA is disabled.

uint32\_t **flags**

Abilities of bus to be checked by the driver. Or-ed value of SPICOMMON\_BUSFLAG\_\* flags.

*esp\_intr\_cpu\_affinity\_t* **isr\_cpu\_id**

Select cpu core to register SPI ISR.

int **intr\_flags**

Interrupt flag for the bus to set the priority, and IRAM attribute, see *esp\_intr\_alloc.h*. Note that the EDGE, INTRDISABLED attribute are ignored by the driver. Note that if ESP\_INTR\_FLAG\_IRAM is set, ALL the callbacks of the driver, and their callee functions, should be put in the IRAM.

## Macros

**SPI\_MAX\_DMA\_LEN**

**SPI\_SWAP\_DATA\_TX** (DATA, LEN)

Transform unsigned integer of length <= 32 bits to the format which can be sent by the SPI driver directly.

E.g. to send 9 bits of data, you can:

```
uint16_t data = SPI_SWAP_DATA_TX(0x145, 9);
```

Then points tx\_buffer to &data.

### 参数

- **DATA** -- Data to be sent, can be uint8\_t, uint16\_t or uint32\_t.
- **LEN** -- Length of data to be sent, since the SPI peripheral sends from the MSB, this helps to shift the data to the MSB.

**SPI\_SWAP\_DATA\_RX** (DATA, LEN)

Transform received data of length <= 32 bits to the format of an unsigned integer.

E.g. to transform the data of 15 bits placed in a 4-byte array to integer:

```
uint16_t data = SPI_SWAP_DATA_RX(*(uint32_t*)t->rx_data, 15);
```

### 参数

- **DATA** -- Data to be rearranged, can be uint8\_t, uint16\_t or uint32\_t.
- **LEN** -- Length of data received, since the SPI peripheral writes from the MSB, this helps to shift the data to the LSB.

**SPICOMMON\_BUSFLAG\_SLAVE**

Initialize I/O in slave mode.

**SPICOMMON\_BUSFLAG\_MASTER**

Initialize I/O in master mode.

**SPICOMMON\_BUSFLAG\_IOMUX\_PINS**

Check using iomux pins. Or indicates the pins are configured through the IO mux rather than GPIO matrix.

**SPICOMMON\_BUSFLAG\_GPIO\_PINS**

Force the signals to be routed through GPIO matrix. Or indicates the pins are routed through the GPIO matrix.

**SPICOMMON\_BUSFLAG\_SCLK**

Check existing of SCLK pin. Or indicates CLK line initialized.

**SPICOMMON\_BUSFLAG\_MISO**

Check existing of MISO pin. Or indicates MISO line initialized.

**SPICOMMON\_BUSFLAG\_MOSI**

Check existing of MOSI pin. Or indicates MOSI line initialized.

**SPICOMMON\_BUSFLAG\_DUAL**

Check MOSI and MISO pins can output. Or indicates bus able to work under DIO mode.

**SPICOMMON\_BUSFLAG\_WPHD**

Check existing of WP and HD pins. Or indicates WP & HD pins initialized.

**SPICOMMON\_BUSFLAG\_QUAD**

Check existing of MOSI/MISO/WP/HD pins as output. Or indicates bus able to work under QIO mode.

**SPICOMMON\_BUSFLAG\_IO4\_IO7**

Check existing of IO4~IO7 pins. Or indicates IO4~IO7 pins initialized.

**SPICOMMON\_BUSFLAG\_OCTAL**

Check existing of MOSI/MISO/WP/HD/SPIIO4/SPIIO5/SPIIO6/SPIIO7 pins as output. Or indicates bus able to work under octal mode.

**SPICOMMON\_BUSFLAG\_NATIVE\_PINS****Type Definitions**

```
typedef spi_common_dma_t spi_dma_chan_t
```

**Enumerations**

```
enum spi_common_dma_t
```

SPI DMA channels.

*Values:*

```
enumerator SPI_DMA_DISABLED
```

Do not enable DMA for SPI.

enumerator **SPI\_DMA\_CH\_AUTO**

Enable DMA, channel is automatically selected by driver.

## API 参考 - SPI Master

### Header File

- [components/esp\\_driver\\_spi/include/driver/spi\\_master.h](#)
- This header file can be included with:

```
#include "driver/spi_master.h"
```

- This header file is a part of the API provided by the `esp_driver_spi` component. To declare that your component depends on `esp_driver_spi`, add the following to your `CMakeLists.txt`:

```
REQUIRES esp_driver_spi
```

or

```
PRIV_REQUIRES esp_driver_spi
```

### Functions

`esp_err_t spi_bus_add_device` (*spi\_host\_device\_t* host\_id, const *spi\_device\_interface\_config\_t* \*dev\_config, *spi\_device\_handle\_t* \*handle)

Allocate a device on a SPI bus.

This initializes the internal structures for a device, plus allocates a CS pin on the indicated SPI master peripheral and routes it to the indicated GPIO. All SPI master devices have three CS pins and can thus control up to three devices.

There's no notable delay on chips other than ESP32.

---

**备注:** On ESP32, due to the delay of GPIO matrix, the maximum frequency SPI Master can correctly samples the slave's output is lower than the case using IOMUX. Typical maximum frequency communicating with an ideal slave without data output delay: 80MHz (IOMUX pins) and 26MHz (GPIO matrix pins). With the help of extra dummy cycles in half-duplex mode, the delay can be compensated by setting `input_delay_ns` in `dev_config` structure correctly.

---

#### 参数

- **host\_id** -- SPI peripheral to allocate device on
- **dev\_config** -- SPI interface protocol config for the device
- **handle** -- Pointer to variable to hold the device handle

#### 返回

- `ESP_ERR_INVALID_ARG` if parameter is invalid or configuration combination is not supported (e.g. `dev_config->post_cb` isn't set while flag `SPI_DEVICE_NO_RETURN_RESULT` is enabled)
- `ESP_ERR_INVALID_STATE` if selected clock source is unavailable or spi bus not initialized
- `ESP_ERR_NOT_FOUND` if host doesn't have any free CS slots
- `ESP_ERR_NO_MEM` if out of memory
- `ESP_OK` on success

`esp_err_t spi_bus_remove_device` (*spi\_device\_handle\_t* handle)

Remove a device from the SPI bus.

参数 **handle** -- Device handle to free

**返回**

- ESP\_ERR\_INVALID\_ARG if parameter is invalid
- ESP\_ERR\_INVALID\_STATE if device already is freed
- ESP\_OK on success

*esp\_err\_t* **spi\_device\_queue\_trans** (*spi\_device\_handle\_t* handle, *spi\_transaction\_t* \*trans\_desc, TickType\_t ticks\_to\_wait)

Queue a SPI transaction for interrupt transaction execution. Get the result by `spi_device_get_trans_result`.

---

**备注:** Normally a device cannot start (queue) polling and interrupt transactions simultaneously.

---

**参数**

- **handle** -- Device handle obtained using `spi_host_add_dev`
- **trans\_desc** -- Description of transaction to execute
- **ticks\_to\_wait** -- Ticks to wait until there's room in the queue; use `portMAX_DELAY` to never time out.

**返回**

- ESP\_ERR\_INVALID\_ARG if parameter is invalid. This can happen if `SPI_TRANS_CS_KEEP_ACTIVE` flag is specified while the bus was not acquired (`spi_device_acquire_bus()` should be called first) or set flag `SPI_TRANS_DMA_BUFFER_ALIGN_MANUAL` but tx or rx buffer not DMA-capable, or `addr&len` not align to cache line size
- ESP\_ERR\_TIMEOUT if there was no room in the queue before `ticks_to_wait` expired
- ESP\_ERR\_NO\_MEM if allocating DMA-capable temporary buffer failed
- ESP\_ERR\_INVALID\_STATE if previous transactions are not finished
- ESP\_OK on success

*esp\_err\_t* **spi\_device\_get\_trans\_result** (*spi\_device\_handle\_t* handle, *spi\_transaction\_t* \*\*trans\_desc, TickType\_t ticks\_to\_wait)

Get the result of a SPI transaction queued earlier by `spi_device_queue_trans`.

This routine will wait until a transaction to the given device successfully completed. It will then return the description of the completed transaction so software can inspect the result and e.g. free the memory or reuse the buffers.

**参数**

- **handle** -- Device handle obtained using `spi_host_add_dev`
- **trans\_desc** -- Pointer to variable able to contain a pointer to the description of the transaction that is executed. The descriptor should not be modified until the descriptor is returned by `spi_device_get_trans_result`.
- **ticks\_to\_wait** -- Ticks to wait until there's a returned item; use `portMAX_DELAY` to never time out.

**返回**

- ESP\_ERR\_INVALID\_ARG if parameter is invalid
- ESP\_ERR\_NOT\_SUPPORTED if flag `SPI_DEVICE_NO_RETURN_RESULT` is set
- ESP\_ERR\_TIMEOUT if there was no completed transaction before `ticks_to_wait` expired
- ESP\_OK on success

*esp\_err\_t* **spi\_device\_transmit** (*spi\_device\_handle\_t* handle, *spi\_transaction\_t* \*trans\_desc)

Send a SPI transaction, wait for it to complete, and return the result.

This function is the equivalent of calling `spi_device_queue_trans()` followed by `spi_device_get_trans_result()`. Do not use this when there is still a transaction separately queued (started) from `spi_device_queue_trans()` or `polling_start/transmit` that hasn't been finalized.

---

**备注:** This function is not thread safe when multiple tasks access the same SPI device. Normally a device

---

cannot start (queue) polling and interrupt transactions simultaneously.

---

**参数**

- **handle** -- Device handle obtained using `spi_host_add_dev`
- **trans\_desc** -- Description of transaction to execute

**返回**

- `ESP_ERR_INVALID_ARG` if parameter is invalid
- `ESP_OK` on success

*esp\_err\_t* **spi\_device\_polling\_start** (*spi\_device\_handle\_t* handle, *spi\_transaction\_t* \*trans\_desc, TickType\_t ticks\_to\_wait)

Immediately start a polling transaction.

---

**备注:** Normally a device cannot start (queue) polling and interrupt transactions simultaneously. Moreover, a device cannot start a new polling transaction if another polling transaction is not finished.

---

**参数**

- **handle** -- Device handle obtained using `spi_host_add_dev`
- **trans\_desc** -- Description of transaction to execute
- **ticks\_to\_wait** -- Ticks to wait until there's room in the queue; currently only `portMAX_DELAY` is supported.

**返回**

- `ESP_ERR_INVALID_ARG` if parameter is invalid. This can happen if `SPI_TRANS_CS_KEEP_ACTIVE` flag is specified while the bus was not acquired (`spi_device_acquire_bus()` should be called first) or set flag `SPI_TRANS_DMA_BUFFER_ALIGN_MANUAL` but tx or rx buffer not DMA-capable, or `addr&len` not align to cache line size
- `ESP_ERR_TIMEOUT` if the device cannot get control of the bus before `ticks_to_wait` expired
- `ESP_ERR_NO_MEM` if allocating DMA-capable temporary buffer failed
- `ESP_ERR_INVALID_STATE` if previous transactions are not finished
- `ESP_OK` on success

*esp\_err\_t* **spi\_device\_polling\_end** (*spi\_device\_handle\_t* handle, TickType\_t ticks\_to\_wait)

Poll until the polling transaction ends.

This routine will not return until the transaction to the given device has successfully completed. The task is not blocked, but actively busy-spins for the transaction to be completed.

**参数**

- **handle** -- Device handle obtained using `spi_host_add_dev`
- **ticks\_to\_wait** -- Ticks to wait until there's a returned item; use `portMAX_DELAY` to never time out.

**返回**

- `ESP_ERR_INVALID_ARG` if parameter is invalid
- `ESP_ERR_TIMEOUT` if the transaction cannot finish before `ticks_to_wait` expired
- `ESP_OK` on success

*esp\_err\_t* **spi\_device\_polling\_transmit** (*spi\_device\_handle\_t* handle, *spi\_transaction\_t* \*trans\_desc)

Send a polling transaction, wait for it to complete, and return the result.

This function is the equivalent of calling `spi_device_polling_start()` followed by `spi_device_polling_end()`. Do not use this when there is still a transaction that hasn't been finalized.

---

**备注:** This function is not thread safe when multiple tasks access the same SPI device. Normally a device

---

cannot start (queue) polling and interrupt transactions simultaneously.

---

**参数**

- **handle** -- Device handle obtained using `spi_host_add_dev`
- **trans\_desc** -- Description of transaction to execute

**返回**

- `ESP_ERR_INVALID_ARG` if parameter is invalid
- `ESP_ERR_TIMEOUT` if the device cannot get control of the bus
- `ESP_ERR_NO_MEM` if allocating DMA-capable temporary buffer failed
- `ESP_ERR_INVALID_STATE` if previous transactions of same device are not finished
- `ESP_OK` on success

`esp_err_t spi_device_acquire_bus` (`spi_device_handle_t` device, `TickType_t` wait)

Occupy the SPI bus for a device to do continuous transactions.

Transactions to all other devices will be put off until `spi_device_release_bus` is called.

---

**备注:** The function will wait until all the existing transactions have been sent.

---

**参数**

- **device** -- The device to occupy the bus.
- **wait** -- Time to wait before the the bus is occupied by the device. Currently MUST set to `portMAX_DELAY`.

**返回**

- `ESP_ERR_INVALID_ARG` : `wait` is not set to `portMAX_DELAY`.
- `ESP_OK` : Success.

void `spi_device_release_bus` (`spi_device_handle_t` dev)

Release the SPI bus occupied by the device. All other devices can start sending transactions.

**参数** `dev` -- The device to release the bus.

`esp_err_t spi_device_get_actual_freq` (`spi_device_handle_t` handle, int \*`freq_khz`)

Calculate working frequency for specific device.

**参数**

- **handle** -- SPI device handle
- **freq\_khz** -- [out] output parameter to hold calculated frequency in kHz

**返回**

- `ESP_ERR_INVALID_ARG` : `handle` or `freq_khz` parameter is NULL
- `ESP_OK` : Success

int `spi_get_actual_clock` (int `fapb`, int `hz`, int `duty_cycle`)

Calculate the working frequency that is most close to desired frequency.

**参数**

- **fapb** -- The frequency of apb clock, should be `APB_CLK_FREQ`.
- **hz** -- Desired working frequency
- **duty\_cycle** -- Duty cycle of the spi clock

**返回** Actual working frequency that most fit.

void `spi_get_timing` (bool `gpio_is_used`, int `input_delay_ns`, int `eff_clk`, int \*`dummy_o`, int \*`cycles_remain_o`)

Calculate the timing settings of specified frequency and settings.

---

**备注:** If \*\*`dummy_o`\*\* is not zero, it means dummy bits should be applied in half duplex mode, and full duplex mode may not work.

---



**参数**

- **gpio\_is\_used** -- True if using GPIO matrix, or False if iomux pins are used.
- **input\_delay\_ns** -- Input delay from SCLK launch edge to MISO data valid.
- **eff\_clk** -- Effective clock frequency (in Hz) from `spi_get_actual_clock()`.
- **dummy\_o** -- Address of dummy bits used output. Set to NULL if not needed.
- **cycles\_remain\_o** -- Address of cycles remaining (after dummy bits are used) output.
  - -1 If too many cycles remaining, suggest to compensate half a clock.
  - 0 If no remaining cycles or dummy bits are not used.
  - positive value: cycles suggest to compensate.

int **spi\_get\_freq\_limit** (bool gpio\_is\_used, int input\_delay\_ns)

Get the frequency limit of current configurations. SPI master working at this limit is OK, while above the limit, full duplex mode and DMA will not work, and dummy bits will be applied in the half duplex mode.

**参数**

- **gpio\_is\_used** -- True if using GPIO matrix, or False if native pins are used.
- **input\_delay\_ns** -- Input delay from SCLK launch edge to MISO data valid.

**返回** Frequency limit of current configurations.

*esp\_err\_t* **spi\_bus\_get\_max\_transaction\_len** (*spi\_host\_device\_t* host\_id, size\_t \*max\_bytes)

Get max length (in bytes) of one transaction.

**参数**

- **host\_id** -- SPI peripheral
- **max\_bytes** -- [out] Max length of one transaction, in bytes

**返回**

- ESP\_OK: On success
- ESP\_ERR\_INVALID\_ARG: Invalid argument

**Structures**

struct **spi\_device\_interface\_config\_t**

This is a configuration for a SPI slave device that is connected to one of the SPI buses.

**Public Members**

uint8\_t **command\_bits**

Default amount of bits in command phase (0-16), used when SPI\_TRANS\_VARIABLE\_CMD is not used, otherwise ignored.

uint8\_t **address\_bits**

Default amount of bits in address phase (0-64), used when SPI\_TRANS\_VARIABLE\_ADDR is not used, otherwise ignored.

uint8\_t **dummy\_bits**

Amount of dummy bits to insert between address and data phase.

uint8\_t **mode**

SPI mode, representing a pair of (CPOL, CPHA) configuration:

- 0: (0, 0)
- 1: (0, 1)
- 2: (1, 0)
- 3: (1, 1)

***spi\_clock\_source\_t* clock\_source**

Select SPI clock source, `SPI_CLK_SRC_DEFAULT` by default.

**uint16\_t duty\_cycle\_pos**

Duty cycle of positive clock, in 1/256th increments (128 = 50%/50% duty). Setting this to 0 (=not setting it) is equivalent to setting this to 128.

**uint16\_t cs\_ena\_pretrans**

Amount of SPI bit-cycles the cs should be activated before the transmission (0-16). This only works on half-duplex transactions.

**uint8\_t cs\_ena\_posttrans**

Amount of SPI bit-cycles the cs should stay active after the transmission (0-16)

**int clock\_speed\_hz**

SPI clock speed in Hz. Derived from `clock_source`.

**int input\_delay\_ns**

Maximum data valid time of slave. The time required between SCLK and MISO valid, including the possible clock delay from slave to master. The driver uses this value to give an extra delay before the MISO is ready on the line. Leave at 0 unless you know you need a delay. For better timing performance at high frequency (over 8MHz), it's suggest to have the right value.

**int spics\_io\_num**

CS GPIO pin for this device, or -1 if not used.

**uint32\_t flags**

Bitwise OR of `SPI_DEVICE_*` flags.

**int queue\_size**

Transaction queue size. This sets how many transactions can be 'in the air' (queued using `spi_device_queue_trans` but not yet finished using `spi_device_get_trans_result`) at the same time.

***transaction\_cb\_t* pre\_cb**

Callback to be called before a transmission is started.

This callback is called within interrupt context should be in IRAM for best performance, see "Transferring Speed" section in the SPI Master documentation for full details. If not, the callback may crash during flash operation when the driver is initialized with `ESP_INTR_FLAG_IRAM`.

***transaction\_cb\_t* post\_cb**

Callback to be called after a transmission has completed.

This callback is called within interrupt context should be in IRAM for best performance, see "Transferring Speed" section in the SPI Master documentation for full details. If not, the callback may crash during flash operation when the driver is initialized with `ESP_INTR_FLAG_IRAM`.

**struct spi\_transaction\_t**

This structure describes one SPI transaction. The descriptor should not be modified until the transaction finishes.

## Public Members

### uint32\_t flags

Bitwise OR of SPI\_TRANS\_\* flags.

### uint16\_t cmd

Command data, of which the length is set in the `command_bits` of *spi\_device\_interface\_config\_t*.

**NOTE: this field, used to be "command" in ESP-IDF 2.1 and before, is re-written to be used in a new way in ESP-IDF 3.0.**

Example: write 0x0123 and `command_bits=12` to send command 0x12, 0x3\_ (in previous version, you may have to write 0x3\_12).

### uint64\_t addr

Address data, of which the length is set in the `address_bits` of *spi\_device\_interface\_config\_t*.

**NOTE: this field, used to be "address" in ESP-IDF 2.1 and before, is re-written to be used in a new way in ESP-IDF 3.0.**

Example: write 0x123400 and `address_bits=24` to send address of 0x12, 0x34, 0x00 (in previous version, you may have to write 0x12340000).

### size\_t length

Total data length, in bits.

### size\_t rxlength

Total data length received, should be not greater than `length` in full-duplex mode (0 defaults this to the value of `length`).

### void \*user

User-defined variable. Can be used to store eg transaction ID.

### const void \*tx\_buffer

Pointer to transmit buffer, or NULL for no MOSI phase.

### uint8\_t tx\_data[4]

If SPI\_TRANS\_USE\_TXDATA is set, data set here is sent directly from this variable.

### void \*rx\_buffer

Pointer to receive buffer, or NULL for no MISO phase. Written by 4 bytes-unit if DMA is used.

### uint8\_t rx\_data[4]

If SPI\_TRANS\_USE\_RXDATA is set, data is received directly to this variable.

### struct spi\_transaction\_ext\_t

This struct is for SPI transactions which may change their address and command length. Please do set the flags in base to SPI\_TRANS\_VARIABLE\_CMD\_ADR to use the bit length here.

## Public Members

struct *spi\_transaction\_t* **base**

Transaction data, so that pointer to *spi\_transaction\_t* can be converted into *spi\_transaction\_ext\_t*.

uint8\_t **command\_bits**

The command length in this transaction, in bits.

uint8\_t **address\_bits**

The address length in this transaction, in bits.

uint8\_t **dummy\_bits**

The dummy length in this transaction, in bits.

## Macros

**SPI\_MASTER\_FREQ\_8M**

SPI common used frequency (in Hz)

---

备注: SPI peripheral only has an integer divider, and the default clock source can be different on other targets, so the actual frequency may be slightly different from the desired frequency. 8MHz

---

**SPI\_MASTER\_FREQ\_9M**

8.89MHz

**SPI\_MASTER\_FREQ\_10M**

10MHz

**SPI\_MASTER\_FREQ\_11M**

11.43MHz

**SPI\_MASTER\_FREQ\_13M**

13.33MHz

**SPI\_MASTER\_FREQ\_16M**

16MHz

**SPI\_MASTER\_FREQ\_20M**

20MHz

**SPI\_MASTER\_FREQ\_26M**

26.67MHz

**SPI\_MASTER\_FREQ\_40M**

40MHz

**SPI\_MASTER\_FREQ\_80M**

80MHz

**SPI\_DEVICE\_TXBIT\_LSBFIRST**

Transmit command/address/data LSB first instead of the default MSB first.

**SPI\_DEVICE\_RXBIT\_LSBFIRST**

Receive data LSB first instead of the default MSB first.

**SPI\_DEVICE\_BIT\_LSBFIRST**

Transmit and receive LSB first.

**SPI\_DEVICE\_3WIRE**

Use MOSI (=spid) for both sending and receiving data.

**SPI\_DEVICE\_POSITIVE\_CS**

Make CS positive during a transaction instead of negative.

**SPI\_DEVICE\_HALFDUPLEX**

Transmit data before receiving it, instead of simultaneously.

**SPI\_DEVICE\_CLK\_AS\_CS**

Output clock on CS line if CS is active.

**SPI\_DEVICE\_NO\_DUMMY**

There are timing issue when reading at high frequency (the frequency is related to whether iomux pins are used, valid time after slave sees the clock).

- In half-duplex mode, the driver automatically inserts dummy bits before reading phase to fix the timing issue. Set this flag to disable this feature.
- In full-duplex mode, however, the hardware cannot use dummy bits, so there is no way to prevent data being read from getting corrupted. Set this flag to confirm that you're going to work with output only, or read without dummy bits at your own risk.

**SPI\_DEVICE\_DDRCLK****SPI\_DEVICE\_NO\_RETURN\_RESULT**

Don't return the descriptor to the host on completion (use `post_cb` to notify instead)

**SPI\_TRANS\_MODE\_DIO**

Transmit/receive data in 2-bit mode.

**SPI\_TRANS\_MODE\_QIO**

Transmit/receive data in 4-bit mode.

**SPI\_TRANS\_USE\_RXDATA**

Receive into `rx_data` member of *spi\_transaction\_t* instead into memory at `rx_buffer`.

**SPI\_TRANS\_USE\_TXDATA**

Transmit `tx_data` member of *spi\_transaction\_t* instead of data at `tx_buffer`. Do not set `tx_buffer` when using this.

**SPI\_TRANS\_MODE\_DIOQIO\_ADDR**

Also transmit address in mode selected by `SPI_MODE_DIO/SPI_MODE_QIO`.

**SPI\_TRANS\_VARIABLE\_CMD**

Use the `command_bits` in `spi_transaction_ext_t` rather than default value in `spi_device_interface_config_t`.

**SPI\_TRANS\_VARIABLE\_ADDR**

Use the `address_bits` in `spi_transaction_ext_t` rather than default value in `spi_device_interface_config_t`.

**SPI\_TRANS\_VARIABLE\_DUMMY**

Use the `dummy_bits` in `spi_transaction_ext_t` rather than default value in `spi_device_interface_config_t`.

**SPI\_TRANS\_CS\_KEEP\_ACTIVE**

Keep CS active after data transfer.

**SPI\_TRANS\_MULTILINE\_CMD**

The data lines used at command phase is the same as data phase (otherwise, only one data line is used at command phase)

**SPI\_TRANS\_MODE\_OCT**

Transmit/receive data in 8-bit mode.

**SPI\_TRANS\_MULTILINE\_ADDR**

The data lines used at address phase is the same as data phase (otherwise, only one data line is used at address phase)

**SPI\_TRANS\_DMA\_BUFFER\_ALIGN\_MANUAL**

By default driver will automatically re-alloc dma buffer if it doesn't meet hardware alignment or `dma_capable` requirements, this flag is for you to disable this feature, you will need to take care of the alignment otherwise driver will return you error `ESP_ERR_INVALID_ARG`.

**Type Definitions**

```
typedef void (*transaction_cb_t)(spi_transaction_t *trans)
```

```
typedef struct spi_device_t *spi_device_handle_t
```

Handle for a device on a SPI bus.

## 2.6.25 SPI 从机驱动程序

SPI 从机驱动程序控制在 ESP32-H2 中作为从机的 GP-SPI 外设。

有关 GP-SPI 硬件相关信息，请参考 [ESP32-H2 技术参考手册 > SPI 控制器 \[PDF\]](#)。

**术语**

下表为 SPI 从机驱动的相关术语。

术语	定义
主机 (Host)	ESP32-H2 外部的 SPI 控制器外设。用作 SPI 主机，在总线上发起 SPI 传输。
从机设备 (Device)	SPI 从机设备（通用 SPI 控制器）。每个从机设备共享 MOSI、MISO 和 SCLK 信号，但只有当主机向从机设备的专属 CS 线发出信号时，从机设备才会在总线上处于激活状态。
总线 (Bus)	信号总线，由连接到同一主机的所有从机设备共用。一般来说，一条总线包括以下线路：MISO、MOSI、SCLK、一条或多条 CS 线，以及可选的 QUADWP 和 QUADHD。每个从机设备都有单独的 CS 线，除此之外，所有从机设备都连接在相同的线路下。如果以菊花链的方式连接，几个从机设备也可以共享一条 CS 线。
MISO	主机输入，从机输出，也写作 Q。数据从从机设备发送至主机。
MOSI	主机输出，从机输入，也写作 D。数据从主机发送至从机设备。
SCLK	串行时钟。由主机产生的振荡信号，使数据位的传输保持同步。
CS	片选。允许主机选择连接到总线上的单个从机设备，以便发送或接收数据。
QUADWP	写保护信号。只用于 4 位 (qio/qout) 传输。
QUADHD	保持信号。只用于 4 位 (qio/qout) 传输。
断言 (Assertion)	指激活一条线的操作。反之，将线路恢复到非活动状态（回到空闲状态）的操作则称为 <b>去断言</b> 。
传输事务 (Transaction)	即主机断言从机设备的 CS 线，向从机设备传输数据，接着去断言 CS 线的过程。传输事务为原子操作，不可打断。
发射沿 (Launch Edge)	源寄存器将信号 <b>发射</b> 到线路上的时钟边沿。
锁存沿 (Latch Edge)	目的寄存器 <b>锁存</b> 信号的时钟边沿。

## 驱动程序的功能

SPI 从机驱动程序允许将 SPI 外设作为全双工设备使用。驱动程序可以发送/接收长度不超过 64 字节的传输事务，或者利用 DMA 来发送/接收更长的传输事务。然而，存在一些与 DMA 有关的 **已知问题**。

SPI 从机驱动程序支持将 SPI ISR 注册至指定 CPU 内核。如果多个任务同时尝试访问一个 SPI 设备，建议重构应用程序，以使每个 SPI 外设一次只由一个任务访问。此外，请使用 `spi_bus_config_t::isr_cpu_id` 将 SPI ISR 注册至与 SPI 外设相关任务相同的内核，确保线程安全。

## SPI 传输事务

主机断言 CS 线并在 SCLK 线上发出时钟脉冲时，一次全双工 SPI 传输事务就此开始。每个时钟脉冲都意味着通过 MOSI 线从主机转移一个数据位到从机设备上，并同时通过 MISO 线返回一个数据位。传输事务结束后，主机去断言 CS 线。

传输事务的属性由作为从机设备的 SPI 外设的配置结构体 `spi_slave_interface_config_t` 和传输事务配置结构体 `spi_slave_transaction_t` 决定。

由于并非每次传输事务都需要写入和读取数据，可以选择配置 `spi_transaction_t` 为仅 TX、仅 RX 或同时 TX 和 RX 传输事务。如果将 `spi_slave_transaction_t::rx_buffer` 设置为 NULL，读取阶段将被跳过。与之类似，如果将 `spi_slave_transaction_t::tx_buffer` 设置为 NULL，则写入阶段将被跳过。

**备注：**主机应在从机设备准备好接收数据之后再进行传输事务。建议使用另外一个 GPIO 管脚作为握手信号来同步设备。更多细节，请参阅 [传输事务间隔](#)。

## 使用驱动程序

- 调用函数 `spi_slave_initialize()`，将 SPI 外设初始化为从机设备。请确保在 `bus_config` 中设置正确的 I/O 管脚，并将未使用的信号设置为 -1。
  - 传输事务开始前，需用要求的事务参数填充一个或多个 `spi_slave_transaction_t` 结构体。可以通过调用函数 `spi_slave_queue_trans()` 来将所有传输事务排进队列，并在稍后使用函数 `spi_slave_get_trans_result()` 查询结果；也可以将所有请求输入 `spi_slave_transmit()` 中单独处理。主机上的传输事务完成前，后两个函数将被阻塞，以便发送并接收队列中的数据。
- (可选) 如需卸载 SPI 从机驱动程序，请调用 `spi_slave_free()`。

## 传输事务数据和主/从机长度不匹配

通常，通过从机设备进行传输的数据会被读取或写入到由 `spi_slave_transaction_t::rx_buffer` 和 `spi_slave_transaction_t::tx_buffer` 指示的大块内存中。可以配置 SPI 驱动程序，使用 DMA 进行传输。在这种情况下，则必须使用 `pvPortMallocCaps(size, MALLOC_CAP_DMA)` 将缓存区分配到具备 DMA 功能的内存中。

驱动程序可以读取或写入缓存区的数据量取决于 `spi_slave_transaction_t::length`，但其并不会定义一次 SPI 传输的实际长度。传输事务的长度由主机的时钟线和 CS 线决定，且只有在传输事务完成后，才能从 `spi_slave_transaction_t::trans_len` 中读取实际长度。

如果传输长度超过缓存区长度，则只有在 `spi_slave_transaction_t::length` 中指定的初始比特数会被发送和接收。此时，`spi_slave_transaction_t::trans_len` 被设置为 `spi_slave_transaction_t::length` 而非实际传输事务长度。若需满足实际传输事务长度的要求，请将 `spi_slave_transaction_t::length` 设置为大于 `spi_slave_transaction_t::trans_len` 预期最大值的值。如果传输长度短于缓存区长度，则只传输与缓存区长度相等的数据。

## GPIO 交换矩阵和 IO\_MUX

ESP32-H2 的大多数外设信号都直接连接到其专用的 IO\_MUX 管脚。不过，也可以使用 GPIO 交换矩阵，将信号路由到任何可用的其他管脚。如果通过 GPIO 交换矩阵路由了至少一个信号，则所有信号都将通过 GPIO 交换矩阵路由。

当 SPI 主机频率配置为 80 MHz 或更低时，则通过 GPIO 交换矩阵或 IO\_MUX 路由 SPI 管脚效果相同。

下表列出了 SPI 总线的 IO\_MUX 管脚。

管脚名称	GPIO 编号 (SPI2)
CS0	1
SCLK	4
MISO	0
MOSI	5
QUADWP	2
QUADHD	3

## 速度与时钟

**传输事务间隔** ESP32-H2 的 SPI 从机外设是由 CPU 控制的通用从机设备。与专用的从机相比，在内嵌 CPU 的 SPI 从机设备中，预定义寄存器的数量有限，所有的传输事务都必须由 CPU 处理。也就是说，传输和响应并不是实时的，且可能存在明显的延迟。

解决方案为，首先使用函数 `spi_slave_queue_trans()`，然后使用 `spi_slave_get_trans_result()`，来代替 `spi_slave_transmit()`。由此一来，可使从机设备的响应速度提高一倍。



也可以配置一个 GPIO 管脚，当从机设备开始新一次传输事务前，它将通过该管脚向主机发出信号。示例代码存放在 `peripherals/spi_slave` 目录下。

**时钟频率要求** SPI 从机的工作频率最高可达 32 MHz。如果时钟频率过快或占空比不足 50%，数据就无法被正确识别或接收。

### 限制条件和已知问题

1. 若启用了 DMA，则 RX 缓冲区应该以字对齐（从 32 位边界开始，字节长度为 4 的倍数）。否则，DMA 可能无法正确写入或无法实现边界对齐。若此项条件不满足，驱动程序将会报错。此外，主机写入字节长度应为 4 的倍数。长度不符合的数据将被丢弃。

### 应用示例

从机设备/主机通信的示例代码存放在 ESP-IDF 示例项目的 `peripherals/spi_slave` 目录下。

## API 参考

### Header File

- `components/esp_driver_spi/include/driver/spi_slave.h`
- This header file can be included with:

```
#include "driver/spi_slave.h"
```

- This header file is a part of the API provided by the `esp_driver_spi` component. To declare that your component depends on `esp_driver_spi`, add the following to your `CMakeLists.txt`:

```
REQUIRES esp_driver_spi
```

or

```
PRIV_REQUIRES esp_driver_spi
```

### Functions

`esp_err_t spi_slave_initialize` (`spi_host_device_t` host, const `spi_bus_config_t` \*bus\_config, const `spi_slave_interface_config_t` \*slave\_config, `spi_dma_chan_t` dma\_chan)

Initialize a SPI bus as a slave interface.

**警告:** SPI0/1 is not supported

**警告:** If a DMA channel is selected, any transmit and receive buffer used should be allocated in DMA-capable memory.

**警告:** The ISR of SPI is always executed on the core which calls this function. Never starve the ISR on this core or the SPI transactions will not be handled.

### 参数

- **host** -- SPI peripheral to use as a SPI slave interface
- **bus\_config** -- Pointer to a `spi_bus_config_t` struct specifying how the host should be initialized

- **slave\_config** -- Pointer to a *spi\_slave\_interface\_config\_t* struct specifying the details for the slave interface
- **dma\_chan** -- - Selecting a DMA channel for an SPI bus allows transactions on the bus with size only limited by the amount of internal memory.
  - Selecting SPI\_DMA\_DISABLED limits the size of transactions.
  - Set to SPI\_DMA\_DISABLED if only the SPI flash uses this bus.
  - Set to SPI\_DMA\_CH\_AUTO to let the driver to allocate the DMA channel.

**返回**

- ESP\_ERR\_INVALID\_ARG if configuration is invalid
- ESP\_ERR\_INVALID\_STATE if host already is in use
- ESP\_ERR\_NOT\_FOUND if there is no available DMA channel
- ESP\_ERR\_NO\_MEM if out of memory
- ESP\_OK on success

*esp\_err\_t* **spi\_slave\_free** (*spi\_host\_device\_t* host)

Free a SPI bus claimed as a SPI slave interface.

**参数** **host** -- SPI peripheral to free

**返回**

- ESP\_ERR\_INVALID\_ARG if parameter is invalid
- ESP\_ERR\_INVALID\_STATE if not all devices on the bus are freed
- ESP\_OK on success

*esp\_err\_t* **spi\_slave\_queue\_trans** (*spi\_host\_device\_t* host, const *spi\_slave\_transaction\_t* \*trans\_desc, TickType\_t ticks\_to\_wait)

Queue a SPI transaction for execution.

Queues a SPI transaction to be executed by this slave device. (The transaction queue size was specified when the slave device was initialised via *spi\_slave\_initialize*.) This function may block if the queue is full (depending on the *ticks\_to\_wait* parameter). No SPI operation is directly initiated by this function, the next queued transaction will happen when the master initiates a SPI transaction by pulling down CS and sending out clock signals.

This function hands over ownership of the buffers in *trans\_desc* to the SPI slave driver; the application is not to access this memory until *spi\_slave\_queue\_trans* is called to hand ownership back to the application.

---

**备注:** On esp32, if trans length not WORD aligned, the rx buffer last word memory will still overwritten by DMA HW

---

**参数**

- **host** -- SPI peripheral that is acting as a slave
- **trans\_desc** -- Description of transaction to execute. Not const because we may want to write status back into the transaction description.
- **ticks\_to\_wait** -- Ticks to wait until there's room in the queue; use port-MAX\_DELAY to never time out.

**返回**

- ESP\_ERR\_INVALID\_ARG if parameter is invalid
- ESP\_ERR\_NO\_MEM if set flag SPI\_SLAVE\_TRANS\_DMA\_BUFFER\_ALIGN\_AUTO but there is no free memory
- ESP\_ERR\_INVALID\_STATE if sync data between Cache and memory failed
- ESP\_OK on success

*esp\_err\_t* **spi\_slave\_get\_trans\_result** (*spi\_host\_device\_t* host, *spi\_slave\_transaction\_t* \*\*trans\_desc, TickType\_t ticks\_to\_wait)

Get the result of a SPI transaction queued earlier.

This routine will wait until a transaction to the given device (queued earlier with `spi_slave_queue_trans`) has successfully completed. It will then return the description of the completed transaction so software can inspect the result and e.g. free the memory or reuse the buffers.

It is mandatory to eventually use this function for any transaction queued by `spi_slave_queue_trans`.

#### 参数

- **host** -- SPI peripheral to that is acting as a slave
- **trans\_desc** -- **[out]** Pointer to variable able to contain a pointer to the description of the transaction that is executed
- **ticks\_to\_wait** -- Ticks to wait until there's a returned item; use `portMAX_DELAY` to never time out.

#### 返回

- `ESP_ERR_INVALID_ARG` if parameter is invalid
- `ESP_ERR_NOT_SUPPORTED` if flag `SPI_SLAVE_NO_RETURN_RESULT` is set
- `ESP_OK` on success

*esp\_err\_t* **spi\_slave\_transmit** (*spi\_host\_device\_t* host, *spi\_slave\_transaction\_t* \*trans\_desc, TickType\_t ticks\_to\_wait)

Do a SPI transaction.

Essentially does the same as `spi_slave_queue_trans` followed by `spi_slave_get_trans_result`. Do not use this when there is still a transaction queued that hasn't been finalized using `spi_slave_get_trans_result`.

#### 参数

- **host** -- SPI peripheral to that is acting as a slave
- **trans\_desc** -- Pointer to variable able to contain a pointer to the description of the transaction that is executed. Not const because we may want to write status back into the transaction description.
- **ticks\_to\_wait** -- Ticks to wait until there's a returned item; use `portMAX_DELAY` to never time out.

#### 返回

- `ESP_ERR_INVALID_ARG` if parameter is invalid
- `ESP_OK` on success

## Structures

struct **spi\_slave\_interface\_config\_t**

This is a configuration for a SPI host acting as a slave device.

### Public Members

int **spics\_io\_num**

CS GPIO pin for this device.

uint32\_t **flags**

Bitwise OR of `SPI_SLAVE_*` flags.

int **queue\_size**

Transaction queue size. This sets how many transactions can be 'in the air' (queued using `spi_slave_queue_trans` but not yet finished using `spi_slave_get_trans_result`) at the same time.

uint8\_t **mode**

SPI mode, representing a pair of (CPOL, CPHA) configuration:

- 0: (0, 0)
- 1: (0, 1)

- 2: (1, 0)
- 3: (1, 1)

#### *slave\_transaction\_cb\_t* **post\_setup\_cb**

Callback called after the SPI registers are loaded with new data.

This callback is called within interrupt context should be in IRAM for best performance, see "Transferring Speed" section in the SPI Master documentation for full details. If not, the callback may crash during flash operation when the driver is initialized with `ESP_INTR_FLAG_IRAM`.

#### *slave\_transaction\_cb\_t* **post\_trans\_cb**

Callback called after a transaction is done.

This callback is called within interrupt context should be in IRAM for best performance, see "Transferring Speed" section in the SPI Master documentation for full details. If not, the callback may crash during flash operation when the driver is initialized with `ESP_INTR_FLAG_IRAM`.

#### struct **spi\_slave\_transaction\_t**

This structure describes one SPI transaction

#### **Public Members**

##### `uint32_t flags`

Bitwise OR of `SPI_SLAVE_TRANS_*` flags.

##### `size_t length`

Total data length, in bits.

##### `size_t trans_len`

Transaction data length, in bits.

##### `const void *tx_buffer`

Pointer to transmit buffer, or NULL for no MOSI phase.

##### `void *rx_buffer`

Pointer to receive buffer, or NULL for no MISO phase. When the DMA is enabled, must start at WORD boundary (`rx_buffer%4==0`), and has length of a multiple of 4 bytes.

##### `void *user`

User-defined variable. Can be used to store eg transaction ID.

#### **Macros**

##### **SPI\_SLAVE\_TXBIT\_LSBFIRST**

Transmit command/address/data LSB first instead of the default MSB first.

##### **SPI\_SLAVE\_RXBIT\_LSBFIRST**

Receive data LSB first instead of the default MSB first.

##### **SPI\_SLAVE\_BIT\_LSBFIRST**

Transmit and receive LSB first.

**SPI\_SLAVE\_NO\_RETURN\_RESULT**

Don't return the descriptor to the host on completion (use `post_trans_cb` to notify instead)

**SPI\_SLAVE\_TRANS\_DMA\_BUFFER\_ALIGN\_AUTO**

Automatically re-malloc dma buffer if user buffer doesn't meet hardware alignment or `dma_capable`, this process may loss some memory and performance.

**Type Definitions**

```
typedef void (*slave_transaction_cb_t)(spi_slave_transaction_t *trans)
```

## 2.6.26 SPI 从机半双工模式

### 简介

半双工 (HD) 模式是 ESP SPI 从机外设提供了一种特殊模式。比起全双工 (FD) 模式 (用于 GPSPI 事务, 详情请参阅 [SPI 从机驱动程序](#)), 在半双工模式下, 硬件会提供更多服务。这些服务减轻了 CPU 负载, 提高了 SPI 从机的响应速度。然而, 通信格式由硬件确定, 始终为半双工模式, 即在同一时刻只能进行单向数据传输, 半双工模式因此得名。

当进行 SPI 事务时, 根据事务的 **命令阶段**, 可以将事务分为不同的类型。每个事务可能包含以下阶段: 命令、地址、dummy、数据。命令阶段是必需的, 其他阶段存在与否则取决于命令的需求。在命令、地址、dummy 阶段, 总线的控制权始终由主设备 (通常是主机) 控制, 数据阶段的方向则取决于命令。数据阶段可以是输入阶段, 即主设备将数据写入从设备 (例如, 主机向从机发送数据); 也可以是输出阶段, 即主设备从从设备读取数据 (例如, 主机从从机接收数据)。

**协议** 有关主设备与 SPI 从机通信的详细信息, 请参阅 [ESP SPI 从机 HD \(半双工\) 模式协议](#)。

通过不同类型的事务, 从设备为主设备提供以下服务:

- 一个 DMA 通道, 支持主设备向从设备写入大量数据。
- 一个 DMA 通道, 支持主设备从从设备读取大量数据。
- 一些通用寄存器, 由主设备和从设备共享。
- 一些通用中断, 用于主设备打断从设备的软件执行。

### 术语

- 事务 (transaction)
- 通道 (channel)
- 发送 (sending)
- 接收 (receiving)
- 数据描述符 (data descriptor)

### 驱动程序特性

- 支持主设备以分段方式读写事务
- 支持发送数据队列和接收数据队列

## 驱动程序使用

**从机初始化** 调用 `spi_slave_hd_init()` 初始化 SPI 总线、外设和驱动程序。在初始化之后，SPI 从机将独占使用 SPI 外设和总线上的管脚。这意味着在反初始化前，其他设备无法使用这些资源。因此，为了确保其他设备可以正确利用 SPI 资源并进行正常通信，从机的大部分配置应在其初始化过程中完成。

结构体 `spi_bus_config_t` 指定了总线的初始化方式，结构体 `spi_slave_hd_slot_config_t` 指定了 SPI 从机驱动程序的运行方式。

**从机反初始化 (可选)** 调用 `spi_slave_hd_deinit()` 卸载驱动程序。该反初始化函数会释放相关资源，包括管脚、SPI 外设、驱动程序所用内存、中断源等。

**通过 DMA 通道发送/接收数据** 要通过 DMA 通道向主设备发送数据，应用程序需要先将数据正确地封装在 `spi_slave_hd_data_t` 描述符结构体中，然后再将数据描述符和通道参数 `SPI_SLAVE_CHAN_TX` 传递给 `spi_slave_hd_queue_trans()`。数据描述符的指针存储在队列中，一旦接收到主设备的 `Rd_DMA` 命令，就会按照调用 `spi_slave_hd_queue_trans()` 时数据进入队列的顺序，依次将数据发送给主设备。

应用程序需要检查数据发送的结果。为此，应用程序可以调用 `spi_slave_hd_get_trans_res()`，并将通道参数设置为 `SPI_SLAVE_CHAN_TX`。该函数将阻塞程序，直到主设备发起的 `Rd_DMA` 命令事务成功完成或超时。函数中的参数 `out_trans` 将输出刚刚完成的数据描述符的指针，从而提供有关已完成的发送操作的信息。

通过 DMA 通道从主设备接收数据的操作与发送数据类似。应用程序需要使用正确的数据描述符调用 `spi_slave_hd_queue_trans()`，并将通道参数设置为 `SPI_SLAVE_CHAN_RX`。随后，应用程序调用 `spi_slave_hd_get_trans_res()` 获取接收 `buffer` 的描述符，然后处理接收 `buffer` 中的数据。

---

**备注：** 驱动程序本身并没有用于发送或接收数据的内部 `buffer`。应用程序需要通过数据描述符为驱动程序提供 `buffer`，从而向主设备发送数据，或接收来自主设备的数据。

在使用 `spi_slave_hd_queue_trans()` 将数据描述符成功发送到驱动程序的内部队列后、并由 `spi_slave_hd_get_trans_res()` 返回前，应用程序需要正确地维护数据描述符以及它所指向的 `buffer`。在此期间，根据需要，硬件和驱动程序可以随时读取或写入 `buffer` 和描述符。

---

注意，在使用该驱动程序进行数据传输时，可以根据实际需要提前终止数据传输，而不需要等待整个 `buffer` 填满或者完全发送完毕。例如，在分段事务模式下，无论发送/接收 `buffer` 是否已使用完（已满），主设备都需要发送 `CMD7` 终止 `Wr_DMA` 事务，或发送 `CMD8` 以分段方式终止 `Rd_DMA` 事务。

**以自定义用户参数使用数据描述符** 在某些情况下，发送包函数和回收包函数可能会分散在不同位置。发送包函数用于发送数据描述符，回收包函数用于处理返回的数据描述符。在回收包函数中获取返回的数据描述符时，可能需要一些额外信息，帮助处理数据传输完成后返回给应用程序的描述符。例如，多次发送相同数据时，你可能想知道返回的描述符来自哪一轮发送。

为此，可以通过强制类型转换，将数据描述符中的 `arg` 设置为变量，提供事务信息；或者将其指向一个包含处理发送/接收数据所需的所有信息的结构体。在回收包函数处理返回的描述符时，即可使用这个额外信息。

## 使用回调函数

**备注：** 这些回调函数在 `ISR` 中调用，因此需要迅速处理所需操作，并尽快返回，确保系统正常运行。因此，在编写 `ISR` 的代码时，需要十分谨慎。

由于中断处理过程是与主程序并发执行的，长时间的延迟或阻塞操作可能会导致系统响应变慢，或导致不可预测的行为。因此，在编写回调函数时，应避免使用可能引起延迟或阻塞的操作，例如等待、睡眠、资源锁等。

---

在初始化 SPI 从机半双工驱动程序时，会传递结构体 `spi_slave_hd_slot_config_t` 中的 `spi_slave_hd_callback_config_t`，为任意事件设置回调函数。



每个不为 `NULL` 的回调函数都将使能对应的中断，所以回调函数会在对应的中断事件触发时立即调用。对于不感兴趣的事件，则无需为其提供回调函数。

配置结构体中的 `arg` 可以给回调函数传递部分上下文信息，或在使用相同的回调函数处理多个 SPI 从机外设时，指明特定的 SPI 从机实例。通过强制类型转换，可以将 `arg` 设置为表示 SPI 从机实例的变量，或者将其指向某个上下文结构体变量。所有回调函数都会使用在初始化回调函数时设置的 `arg` 参数。

配置结构体中的 `event` 和 `awoken` 参数也可以给回调函数传递上下文信息。

- 参数 `event` 向回调函数传递当前事件信息。`spi_slave_hd_event_t` 包含事件类型和刚刚处理完的数据描述符等信息，此时，通常会使用 *data argument*。
- 参数 `awoken` 是一个输出参数，用于告知 ISR，在回调函数后已有其他操作唤醒任务，ISR 应调用 `portYIELD_FROM_ISR()` 调度这些任务。只需将 `awoken` 参数传递给可能解除任务阻塞的 FreeRTOS API，ISR 即可接收 `awoken` 的返回值。

**写入/读取共享寄存器** 调用 `spi_slave_hd_write_buffer()` 写入共享 `buffer`，调用 `spi_slave_hd_read_buffer()` 读取共享 `buffer`。

**备注：**在 ESP32-H2 上，应用程序以字为单位读取/写入共享寄存器，但主机以字节为单位读取/写入共享寄存器。这样一来，就无法确保从主机读取的四个连续字节是来自从机应用程序写入的同一个字。同时，如果从机在主机写入字节时读取了一个字，可能会得到这样的字：主机刚刚写入它的一半，另一半尚未写入。

通过两次读取同个字，并对两次读取的值做比较，主机可以确保读取的字处于非过渡态。

对从机而言，要确保读取的字处于非过渡态则更为困难，因为主机写入四个字的过程可能会非常长，达到 32 个 SPI 时钟周期。为此，可以在写入的字的最后一个（最大地址）字节中添加一些冗余校验码 (CRC)，确保在写入含有 CRC 的字节时，即代表整个字完全写入。

从软件读取/写入和从主机读取/写入可能存在冲突，在多核心系统中尤为如此。因此，建议在数据传输过程中，一个字只在一个方向上使用，即要么只由主机写入，要么只由从机写入。

**接收来自主机的通用中断** 当主机发送 `CMD8`、`CMD9` 或 `CMDA` 时，从机会触发相应的动作。目前，`CMD8` 固定用于指示 `Rd_DMA` 段的终止。要接收通用中断，可以在从机初始化时为 `CMD9` 和 `CMDA` 注册回调函数，详情请参阅 [使用回调函数](#)。

## 应用示例

查看从机设备/主机通信的示例代码，请前往 ESP-IDF 示例的 `peripherals/spi_slave_hd` 目录。

## API 参考

### Header File

- `components/esp_driver_spi/include/driver/spi_slave_hd.h`
- This header file can be included with:

```
#include "driver/spi_slave_hd.h"
```

- This header file is a part of the API provided by the `esp_driver_spi` component. To declare that your component depends on `esp_driver_spi`, add the following to your `CMakeLists.txt`:

```
REQUIRES esp_driver_spi
```

or

```
PRIV_REQUIRES esp_driver_spi
```

**Functions**

*esp\_err\_t* **spi\_slave\_hd\_init** (*spi\_host\_device\_t* host\_id, const *spi\_bus\_config\_t* \*bus\_config, const *spi\_slave\_hd\_slot\_config\_t* \*config)

Initialize the SPI Slave HD driver.

**参数**

- **host\_id** -- The host to use
- **bus\_config** -- Bus configuration for the bus used
- **config** -- Configuration for the SPI Slave HD driver

**返回**

- ESP\_OK: on success
- ESP\_ERR\_INVALID\_ARG: invalid argument given
- ESP\_ERR\_INVALID\_STATE: function called in invalid state, may be some resources are already in use
- ESP\_ERR\_NOT\_FOUND if there is no available DMA channel
- ESP\_ERR\_NO\_MEM: memory allocation failed
- or other return value from *esp\_intr\_alloc*

*esp\_err\_t* **spi\_slave\_hd\_deinit** (*spi\_host\_device\_t* host\_id)

Deinitialize the SPI Slave HD driver.

**参数** **host\_id** -- The host to deinitialize the driver

**返回**

- ESP\_OK: on success
- ESP\_ERR\_INVALID\_ARG: if the host\_id is not correct

*esp\_err\_t* **spi\_slave\_hd\_queue\_trans** (*spi\_host\_device\_t* host\_id, *spi\_slave\_chan\_t* chan, *spi\_slave\_hd\_data\_t* \*trans, TickType\_t timeout)

Queue transactions (segment mode)

**参数**

- **host\_id** -- Host to queue the transaction
- **chan** -- SPI\_SLAVE\_CHAN\_TX or SPI\_SLAVE\_CHAN\_RX
- **trans** -- Transaction descriptors
- **timeout** -- Timeout before the data is queued

**返回**

- ESP\_OK: on success
- ESP\_ERR\_INVALID\_ARG: The input argument is invalid. Can be the following reason:
  - The buffer given is not DMA capable
  - The length of data is invalid (not larger than 0, or exceed the max transfer length)
  - The transaction direction is invalid
- ESP\_ERR\_TIMEOUT: Cannot queue the data before timeout. Master is still processing previous transaction.
- ESP\_ERR\_INVALID\_STATE: Function called in invalid state. This API should be called under segment mode.

*esp\_err\_t* **spi\_slave\_hd\_get\_trans\_res** (*spi\_host\_device\_t* host\_id, *spi\_slave\_chan\_t* chan, *spi\_slave\_hd\_data\_t* \*\*out\_trans, TickType\_t timeout)

Get the result of a data transaction (segment mode)

---

**备注:** This API should be called successfully the same times as the *spi\_slave\_hd\_queue\_trans*.

---

**参数**

- **host\_id** -- Host to queue the transaction
- **chan** -- Channel to get the result, SPI\_SLAVE\_CHAN\_TX or SPI\_SLAVE\_CHAN\_RX
- **out\_trans** -- [out] Pointer to the transaction descriptor (*spi\_slave\_hd\_data\_t*) passed to the driver before. Hardware has finished this transaction. Member *trans\_len* indicates the actual number of bytes of received data, it's meaningless for TX.
- **timeout** -- Timeout before the result is got



**返回**

- **ESP\_OK**: on success
- **ESP\_ERR\_INVALID\_ARG**: Function is not valid
- **ESP\_ERR\_TIMEOUT**: There's no transaction done before timeout
- **ESP\_ERR\_INVALID\_STATE**: Function called in invalid state. This API should be called under segment mode.

void **spi\_slave\_hd\_read\_buffer** (*spi\_host\_device\_t* host\_id, int addr, uint8\_t \*out\_data, size\_t len)

Read the shared registers.

**参数**

- **host\_id** -- Host to read the shared registers
- **addr** -- Address of register to read, 0 to SOC\_SPI\_MAXIMUM\_BUFFER\_SIZE-1
- **out\_data** -- **[out]** Output buffer to store the read data
- **len** -- Length to read, not larger than SOC\_SPI\_MAXIMUM\_BUFFER\_SIZE-addr

void **spi\_slave\_hd\_write\_buffer** (*spi\_host\_device\_t* host\_id, int addr, uint8\_t \*data, size\_t len)

Write the shared registers.

**参数**

- **host\_id** -- Host to write the shared registers
- **addr** -- Address of register to write, 0 to SOC\_SPI\_MAXIMUM\_BUFFER\_SIZE-1
- **data** -- Buffer holding the data to write
- **len** -- Length to write, SOC\_SPI\_MAXIMUM\_BUFFER\_SIZE-addr

*esp\_err\_t* **spi\_slave\_hd\_append\_trans** (*spi\_host\_device\_t* host\_id, *spi\_slave\_chan\_t* chan, *spi\_slave\_hd\_data\_t* \*trans, TickType\_t timeout)

Load transactions (append mode)

---

**备注:** In this mode, user transaction descriptors will be appended to the DMA and the DMA will keep processing the data without stopping

---

**参数**

- **host\_id** -- Host to load transactions
- **chan** -- SPI\_SLAVE\_CHAN\_TX or SPI\_SLAVE\_CHAN\_RX
- **trans** -- Transaction descriptor
- **timeout** -- Timeout before the transaction is loaded

**返回**

- **ESP\_OK**: on success
- **ESP\_ERR\_INVALID\_ARG**: The input argument is invalid. Can be the following reason:
  - The buffer given is not DMA capable
  - The length of data is invalid (not larger than 0, or exceed the max transfer length)
  - The transaction direction is invalid
- **ESP\_ERR\_TIMEOUT**: Master is still processing previous transaction. There is no available transaction for slave to load
- **ESP\_ERR\_INVALID\_STATE**: Function called in invalid state. This API should be called under append mode.

*esp\_err\_t* **spi\_slave\_hd\_get\_append\_trans\_res** (*spi\_host\_device\_t* host\_id, *spi\_slave\_chan\_t* chan, *spi\_slave\_hd\_data\_t* \*\*out\_trans, TickType\_t timeout)

Get the result of a data transaction (append mode)

---

**备注:** This API should be called the same times as the `spi_slave_hd_append_trans`

---

**参数**

- **host\_id** -- Host to load the transaction
- **chan** -- SPI\_SLAVE\_CHAN\_TX or SPI\_SLAVE\_CHAN\_RX
- **out\_trans** -- [out] Pointer to the transaction descriptor (*spi\_slave\_hd\_data\_t*) passed to the driver before. Hardware has finished this transaction. Member `trans_len` indicates the actual number of bytes of received data, it's meaningless for TX.
- **timeout** -- Timeout before the result is got

#### 返回

- ESP\_OK: on success
- ESP\_ERR\_INVALID\_ARG: Function is not valid
- ESP\_ERR\_TIMEOUT: There's no transaction done before timeout
- ESP\_ERR\_INVALID\_STATE: Function called in invalid state. This API should be called under append mode.

## Structures

struct **spi\_slave\_hd\_data\_t**

Descriptor of data to send/receive.

### Public Members

uint8\_t \***data**

Buffer to send, must be DMA capable.

size\_t **len**

Len of data to send/receive. For receiving the buffer length should be multiples of 4 bytes, otherwise the extra part will be truncated.

size\_t **trans\_len**

For RX direction, it indicates the data actually received. For TX direction, it is meaningless.

uint32\_t **flags**

Bitwise OR of SPI\_SLAVE\_HD\_TRANS\_\* flags.

void \***arg**

Extra argument indicating this data.

struct **spi\_slave\_hd\_event\_t**

Information of SPI Slave HD event.

### Public Members

*spi\_event\_t* **event**

Event type.

*spi\_slave\_hd\_data\_t* \***trans**

Corresponding transaction for SPI\_EV\_SEND and SPI\_EV\_RECV events.

struct **spi\_slave\_hd\_callback\_config\_t**

Callback configuration structure for SPI Slave HD.

### Public Members

#### *slave\_cb\_t* **cb\_buffer\_tx**

Callback when master reads from shared buffer.

#### *slave\_cb\_t* **cb\_buffer\_rx**

Callback when master writes to shared buffer.

#### *slave\_cb\_t* **cb\_send\_dma\_ready**

Callback when TX data buffer is loaded to the hardware (DMA)

#### *slave\_cb\_t* **cb\_sent**

Callback when data are sent.

#### *slave\_cb\_t* **cb\_recv\_dma\_ready**

Callback when RX data buffer is loaded to the hardware (DMA)

#### *slave\_cb\_t* **cb\_recv**

Callback when data are received.

#### *slave\_cb\_t* **cb\_cmd9**

Callback when CMD9 received.

#### *slave\_cb\_t* **cb\_cmdA**

Callback when CMDA received.

#### void \***arg**

Argument indicating this SPI Slave HD peripheral instance.

#### struct **spi\_slave\_hd\_slot\_config\_t**

Configuration structure for the SPI Slave HD driver.

### Public Members

#### uint8\_t **mode**

SPI mode, representing a pair of (CPOL, CPHA) configuration:

- 0: (0, 0)
- 1: (0, 1)
- 2: (1, 0)
- 3: (1, 1)

#### uint32\_t **spics\_io\_num**

CS GPIO pin for this device.

#### uint32\_t **flags**

Bitwise OR of SPI\_SLAVE\_HD\_\* flags.

uint32\_t **command\_bits**

command field bits, multiples of 8 and at least 8.

uint32\_t **address\_bits**

address field bits, multiples of 8 and at least 8.

uint32\_t **dummy\_bits**

dummy field bits, multiples of 8 and at least 8.

uint32\_t **queue\_size**

Transaction queue size. This sets how many transactions can be 'in the air' (queued using `spi_slave_hd_queue_trans` but not yet finished using `spi_slave_hd_get_trans_result`) at the same time.

*spi\_dma\_chan\_t* **dma\_chan**

DMA channel to used.

*spi\_slave\_hd\_callback\_config\_t* **cb\_config**

Callback configuration.

## Macros

**SPI\_SLAVE\_HD\_TRANS\_DMA\_BUFFER\_ALIGN\_AUTO**

Automatically re-malloc dma buffer if user buffer doesn't meet hardware alignment or `dma_capable`, this process may lose some memory and performance.

**SPI\_SLAVE\_HD\_TXBIT\_LSBFIRST**

Transmit command/address/data LSB first instead of the default MSB first.

**SPI\_SLAVE\_HD\_RXBIT\_LSBFIRST**

Receive data LSB first instead of the default MSB first.

**SPI\_SLAVE\_HD\_BIT\_LSBFIRST**

Transmit and receive LSB first.

**SPI\_SLAVE\_HD\_APPEND\_MODE**

Adopt DMA append mode for transactions. In this mode, users can load(append) DMA descriptors without stopping the DMA.

## Type Definitions

typedef bool (\***slave\_cb\_t**)(void \*arg, *spi\_slave\_hd\_event\_t* \*event, BaseType\_t \*awoken)

Callback for SPI Slave HD.

## Enumerations

enum **spi\_slave\_chan\_t**

Channel of SPI Slave HD to do data transaction.

*Values:*

enumerator **SPI\_SLAVE\_CHAN\_TX**

The output channel (RDDMA)

enumerator **SPI\_SLAVE\_CHAN\_RX**

The input channel (WRDMA)

## 2.6.27 温度传感器

### 简介

ESP32-H2 内置传感器，用于测量芯片内部的温度。该温度传感器模组包含一个 8 位 Sigma-Delta 模拟-数字转换器 (ADC) 和一个数字-模拟转换器 (DAC)，可以补偿测量结果，减少温度测量的误差。

由于硬件限制，温度传感器存在预定义的测量范围及其对应误差，详见下表：

预定义测量范围 (°C)	测量误差 (°C)
50 ~ 125	< 3
20 ~ 100	< 2
-10 ~ 80	< 1
-30 ~ 50	< 2
-40 ~ 20	< 3

**备注：** 温度传感器主要用于测量芯片内部的温度变化。芯片内部温度通常高于环境温度，并且受到微控制器的时钟频率或 I/O 负载、外部散热环境等因素影响。

### 功能概述

下文将分节概述温度传感器的功能：

- **资源分配** - 介绍了部分参数，设置这些参数可以获取温度传感器句柄；还介绍了在温度传感器完成工作后如何回收资源。
- **启用及禁用温度传感器** - 介绍如何启用及禁用温度传感器。
- **获取测量的温度值** - 介绍如何获取实时温度值。
- **安装温度阈值回调函数** - 介绍如何注册温度阈值回调函数。
- **电源管理** - 介绍更改功耗模式（如 Light-sleep 模式）对温度传感器造成的影响。
- **IRAM 安全** - 介绍在禁用 cache 时如何提高温度传感器的性能。
- **线程安全** - 介绍如何使驱动程序具备线程安全性。
- **ETM 事件和任务** - 介绍哪些事件和任务可以连接到 ETM 通道。

**资源分配** ESP32-H2 只有一个内置温度传感器硬件。`temperature_sensor_handle_t` 表示温度传感器模块，该变量也是不同函数之间的纽带。通过使用相同的 `temperature_sensor_handle_t` 变量，可以在不同的函数调用中访问和修改温度传感器属性，以控制和管理温度传感器。该变量会作为温度 API 的参数，携带有关硬件和配置的信息，你只需创建类型为 `temperature_sensor_handle_t` 的指针，并将其传递给所需 API。

请在安装内置温度传感器模块前评估测量环境的温度范围。例如，如果在室内测量，环境温度可能在 10 °C ~ 30 °C；如果在灯泡中测量，环境温度则可能在 60 °C ~ 110 °C。在环境温度范围的基础上，请先根据以下值定义配置结构体 `temperature_sensor_config_t`，再安装内置温度传感器：

- `range_min`: 所测量温度范围的最小值。
- `range_max`: 所测量温度范围的最大值。

设置好温度范围后，将配置结构体传递给 `temperature_sensor_install()`，该函数将创建温度传感器模块并返回句柄。

如前文所述，不同测量范围对应不同测量误差。然而你无需自行比对测量误差，乐鑫提供了一个内部机制，可以根据所给温度范围选择最小误差。

温度传感器使用完毕后，请调用 `temperature_sensor_uninstall()` 释放相应资源。

### 创建温度传感器句柄

- 第 1 步：评估测量范围。本示例的温度范围为 20 °C ~ 50 °C。
- 第 2 步：配置测量范围，获取温度传感器句柄。

```
temperature_sensor_handle_t temp_handle = NULL;
temperature_sensor_config_t temp_sensor_config = TEMPERATURE_SENSOR_CONFIG_
↳DEFAULT(20, 50);
ESP_ERROR_CHECK(temperature_sensor_install(&temp_sensor_config, &temp_handle));
```

### 启用及禁用温度传感器

1. 调用 `temperature_sensor_enable()` 启用温度传感器。此时，内部温度传感器回路开始工作，驱动程序从初始化状态转为启用状态。
2. 调用 `temperature_sensor_disable()` 禁用温度传感器。

**获取测量的温度值** 通过 `temperature_sensor_enable()` 启用温度传感器后，可以调用 `temperature_sensor_get_celsius()` 获取当前测量的温度值。

```
// 启用温度传感器
ESP_ERROR_CHECK(temperature_sensor_enable(temp_handle));
// 获取传输的传感器数据
float tsens_out;
ESP_ERROR_CHECK(temperature_sensor_get_celsius(temp_handle, &tsens_out));
printf("Temperature in %f °C\n", tsens_out);
// 温度传感器使用完毕后，禁用温度传感器，节约功耗
ESP_ERROR_CHECK(temperature_sensor_disable(temp_handle));
```

**安装温度阈值回调函数** ESP32-H2 支持自动触发温度传感器，持续监测内部温度，内部温度达到给定阈值时将触发中断。因此，可以安装中断回调函数执行所需操作，如报警、重启等。下文介绍了如何准备阈值回调函数。

- 函数 `temperature_sensor_event_callbacks_t::on_threshold` 在中断服务程序 (ISR) 的上下文中调用，请确保该函数不会涉及 `block` 操作。为此，可以检查调用 API 的后缀，确保仅从函数内调用具有 ISR 后缀的 FreeRTOS API 等。函数原型在 `temperature_thres_cb_t` 中声明。

通过参数 `user_arg` 可以将自定义上下文保存到 `temperature_sensor_register_callbacks()` 中，用户数据将直接传递给回调函数。

```
IRAM_ATTR static bool temp_sensor_monitor_cbs(temperature_sensor_handle_t tsens,
↳const temperature_sensor_threshold_event_data_t *edata, void *user_data)
{
    ESP_DRAM_LOGI("tsens", "Temperature value is higher or lower than threshold,
↳value is %d\n...\n\n", edata->celsius_value);
    return false;
}

// 配置回调函数
```

(下页继续)

```

temperature_sensor_abs_threshold_config_t threshold_cfg = {
    .high_threshold = 50,
    .low_threshold = -10,
};
// 设置监控阈值
temperature_sensor_set_absolute_threshold(temp_sensor, &threshold_cfg);
// 注册中断回调函数
temperature_sensor_event_callbacks_t cbs = {
    .on_threshold = temp_sensor_monitor_cbs,
};
// 安装温度回调函数
temperature_sensor_register_callbacks(temp_sensor, &cbs, NULL);

```

**电源管理** 由于温度传感器不使用 APB 时钟，无论是否激活 CONFIG\_PM\_ENABLE 启用电源管理，温度传感器仍可以继续工作。

**IRAM 安全** 默认情况下，禁用 cache 时，写入/擦除 flash 等原因将导致温度传感器中断延迟，事件回调函数也将延迟执行。在实时应用程序中，应避免此类情况。

因此，可以启用 Kconfig 选项 `CONFIG_TEMP_SENSOR_ISR_IRAM_SAFE`，该选项：

1. 支持在禁用 cache 时启用所需中断
2. 支持将 ISR 使用的所有函数存放在 IRAM 中

启用该选项可以保证 cache 禁用时的中断运行，但会占用更多的 IRAM。

**线程安全** 温度传感器中并未添加任何确保线程安全的额外保护，因为温度传感器通常只在一个任务中调用。如果要在不同任务中使用该驱动程序，请设置额外的锁进行保护。

**ETM 事件和任务** 温度传感器能够生成事件，这些事件可以与 `doc:ETM` [模块](#) 进行交互。`temperature_sensor_etm_event_type_t` 中列出了所有支持的事件。可以调用 `temperature_sensor_new_etm_event` 来获取相应的 ETM 事件句柄。`temperature_sensor_etm_task_type_t` 中列出了所有支持的任务。可以调用 `temperature_sensor_new_etm_task` 来获取相应的 ETM 任务句柄。

#### 备注：

- 对于 `temperature_sensor_etm_event_type_t::event_type` 的 `TEMPERATURE_SENSOR_EVENT_OVER_LIMIT` 取决于首先设置的阈值类型。如果是通过 `temperature_sensor_set_absolute_threshold()` 设置了绝对阈值，那么 `TEMPERATURE_SENSOR_EVENT_OVER_LIMIT` 将指代绝对阈值。同样，如果是通过 `temperature_sensor_set_delta_threshold()` 设置了增量阈值，那么 `TEMPERATURE_SENSOR_EVENT_OVER_LIMIT` 将指代增量阈值。

有关如何将事件和任务连接到 ETM 通道的详细信息，请参阅 `doc:ETM` [文档](#)。

#### 意外情况

1. 从芯片获取的温度值通常与环境温度不同，因为温度传感器内置于芯片，从某种程度来说，温度传感器测量的是芯片内的温度。
2. 安装温度传感器失败时，如果驱动程序打印的错误信息为 `the boundary you gave cannot meet the range of internal temperature sensor`，说明内置温度传感器温度测量范围的限制影响了安装过程，该错误通常由以下几种不正确的 `temperature_sensor_config_t` 配置造成：

- (1) 超出温度测量范围，如 200 °C ~ 300 °C。
- (2) 超过了预定义测量范围的界限，如 40 °C ~ 110 °C。

## 应用示例

- 读取温度传感器测量值：[peripherals/temperature\\_sensor/temp\\_sensor](#)。
- 监测温度传感器测量值：[peripherals/temperature\\_sensor/temp\\_sensor\\_monitor](#)。

## API 参考

### Header File

- [components/esp\\_driver\\_tsens/include/driver/temperature\\_sensor.h](#)
- This header file can be included with:

```
#include "driver/temperature_sensor.h"
```

- This header file is a part of the API provided by the `esp_driver_tsens` component. To declare that your component depends on `esp_driver_tsens`, add the following to your `CMakeLists.txt`:

```
REQUIRES esp_driver_tsens
```

or

```
PRIV_REQUIRES esp_driver_tsens
```

### Functions

`esp_err_t temperature_sensor_install` (const *temperature\_sensor\_config\_t* \*tsens\_config, *temperature\_sensor\_handle\_t* \*ret\_tsens)

Install temperature sensor driver.

#### 参数

- **tsens\_config** -- Pointer to config structure.
- **ret\_tsens** -- Return the pointer of temperature sensor handle.

#### 返回

- ESP\_OK if succeed

`esp_err_t temperature_sensor_uninstall` (*temperature\_sensor\_handle\_t* tsens)

Uninstall the temperature sensor driver.

**参数** **tsens** -- The handle created by `temperature_sensor_install()`.

#### 返回

- ESP\_OK if succeed.

`esp_err_t temperature_sensor_enable` (*temperature\_sensor\_handle\_t* tsens)

Enable the temperature sensor.

**参数** **tsens** -- The handle created by `temperature_sensor_install()`.

#### 返回

- ESP\_OK Success
- ESP\_ERR\_INVALID\_STATE if temperature sensor is enabled already.

`esp_err_t temperature_sensor_disable` (*temperature\_sensor\_handle\_t* tsens)

Disable temperature sensor.

**参数** **tsens** -- The handle created by `temperature_sensor_install()`.

#### 返回

- ESP\_OK Success
- ESP\_ERR\_INVALID\_STATE if temperature sensor is not enabled yet.



---

*esp\_err\_t* **temperature\_sensor\_get\_celsius** (*temperature\_sensor\_handle\_t* tsens, float \*out\_celsius)

Read temperature sensor data that is converted to degrees Celsius.

---

**备注:** Should not be called from interrupt.

---

#### 参数

- **tsens** -- The handle created by `temperature_sensor_install()`.
- **out\_celsius** -- The measure output value.

#### 返回

- ESP\_OK Success
- ESP\_ERR\_INVALID\_ARG invalid arguments
- ESP\_ERR\_INVALID\_STATE Temperature sensor is not enabled yet.
- ESP\_FAIL Parse the sensor data into ambient temperature failed (e.g. out of the range).

*esp\_err\_t* **temperature\_sensor\_set\_absolute\_threshold** (*temperature\_sensor\_handle\_t* tsens, const *temperature\_sensor\_abs\_threshold\_config\_t* \*abs\_cfg)

Set temperature sensor absolute mode automatic monitor.

---

**备注:** This function should not be called with `temperature_sensor_set_delta_threshold`.

---

#### 参数

- **tsens** -- The handle created by `temperature_sensor_install()`.
- **abs\_cfg** -- Configuration of temperature sensor absolute mode interrupt, see `temperature_sensor_abs_threshold_config_t`.

#### 返回

- ESP\_OK: Set absolute threshold successfully.
- ESP\_ERR\_INVALID\_STATE: Set absolute threshold failed because of wrong state.
- ESP\_ERR\_INVALID\_ARG: Set absolute threshold failed because of invalid argument.

*esp\_err\_t* **temperature\_sensor\_set\_delta\_threshold** (*temperature\_sensor\_handle\_t* tsens, const *temperature\_sensor\_delta\_threshold\_config\_t* \*delta\_cfg)

Set temperature sensor differential mode automatic monitor.

---

**备注:** This function should not be called with `temperature_sensor_set_absolute_threshold`

---

#### 参数

- **tsens** -- The handle created by `temperature_sensor_install()`.
- **delta\_cfg** -- Configuration of temperature sensor delta mode interrupt, see `temperature_sensor_delta_threshold_config_t`.

#### 返回

- ESP\_OK: Set differential value threshold successfully.
- ESP\_ERR\_INVALID\_STATE: Set absolute threshold failed because of wrong state.
- ESP\_ERR\_INVALID\_ARG: Set differential value threshold failed because of invalid argument.

*esp\_err\_t* **temperature\_sensor\_register\_callbacks** (*temperature\_sensor\_handle\_t* tsens, const *temperature\_sensor\_event\_callbacks\_t* \*cbs, void \*user\_arg)

Install temperature sensor interrupt callback. Temperature sensor interrupt will be enabled at same time.

**参数**

- **tsens** -- The handle created by `temperature_sensor_install()`.
- **cbs** -- Pointer to the group of temperature sensor interrupt callbacks.
- **user\_arg** -- Callback argument.

**返回**

- **ESP\_OK**: Set event callbacks successfully
- **ESP\_ERR\_INVALID\_ARG**: Set event callbacks failed because of invalid argument
- **ESP\_FAIL**: Set event callbacks failed because of other error

**Structures**

struct **temperature\_sensor\_config\_t**

Configuration of measurement range for the temperature sensor.

---

**备注:** If you see the log the boundary you gave cannot meet the range of internal temperature sensor. You may need to refer to predefined range listed [doc api-reference/peripherals/Temperature sensor](#).

---

**Public Members**

int **range\_min**

the minimum value of the temperature you want to test

int **range\_max**

the maximum value of the temperature you want to test

[temperature\\_sensor\\_clk\\_src\\_t](#) **clk\_src**

the clock source of the temperature sensor.

struct **temperature\_sensor\_threshold\_event\_data\_t**

Temperature sensor event data.

**Public Members**

int **celsius\_value**

Celsius value in interrupt callback.

[temperature\\_val\\_intr\\_condition\\_t](#) **intr\_condition**

Can be used to judge temperature sensor interrupts in which reason

struct **temperature\_sensor\_event\_callbacks\_t**

Group of temperature sensor callback functions, all of them will be run in ISR.

**Public Members**

[temperature\\_thres\\_cb\\_t](#) **on\_threshold**

Temperature value interrupt callback

struct **temperature\_sensor\_abs\_threshold\_config\_t**

Config options for temperature value absolute interrupt.

### Public Members

float **high\_threshold**

High threshold value(Celsius). Interrupt will be triggered if temperature value is higher than this value

float **low\_threshold**

Low threshold value(Celsius). Interrupt will be triggered if temperature value is lower than this value

struct **temperature\_sensor\_delta\_threshold\_config\_t**

Config options for temperature value delta interrupt.

### Public Members

float **increase\_delta**

Interrupt will be triggered if the temperature increment of two consecutive samplings if larger than `increase_delta`

float **decrease\_delta**

Interrupt will be triggered if the temperature decrement of two consecutive samplings if smaller than `decrease_delta`

### Macros

**TEMPERATURE\_SENSOR\_CONFIG\_DEFAULT** (min, max)

*temperature\_sensor\_config\_t* default constructor

### Type Definitions

typedef struct temperature\_sensor\_obj\_t \***temperature\_sensor\_handle\_t**

Type of temperature sensor driver handle.

typedef bool (\***temperature\_thres\_cb\_t**)(*temperature\_sensor\_handle\_t* tsens, const *temperature\_sensor\_threshold\_event\_data\_t* \*edata, void \*user\_data)

Callback for temperature sensor threshold interrupt.

**Param tsens** [in] The handle created by `temperature_sensor_install()`.

**Param edata** [in] temperature sensor event data, fed by driver.

**Param user\_data** [in] User data, set in `temperature_sensor_register_callbacks()`.

**Return** Whether a high priority task has been waken up by this function.

### Enumerations

enum **temperature\_val\_intr\_condition\_t**

Enum for temperature sensor interrupt condition.

*Values:*

enumerator **TEMPERATURE\_VAL\_HIGHER\_THAN\_HIGH\_THRESHOLD**  
temperature sensor value is higher than high threshold

enumerator **TEMPERATURE\_VAL\_LOWER\_THAN\_LOW\_THRESHOLD**  
temperature sensor value is lower than low threshold

### Header File

- [components/hal/include/hal/temperature\\_sensor\\_types.h](#)
- This header file can be included with:

```
#include "hal/temperature_sensor_types.h"
```

### Type Definitions

typedef *soc\_periph\_temperature\_sensor\_clk\_src\_t* **temperature\_sensor\_clk\_src\_t**  
temperature sensor clock source

### Enumerations

enum **temperature\_sensor\_etm\_event\_type\_t**  
temperature sensor event types enum

*Values:*

enumerator **TEMPERATURE\_SENSOR\_EVENT\_OVER\_LIMIT**  
Temperature sensor over limit event

enumerator **TEMPERATURE\_SENSOR\_EVENT\_MAX**  
Maximum number of temperature sensor events

enum **temperature\_sensor\_etm\_task\_type\_t**  
temperature sensor task types enum

*Values:*

enumerator **TEMPERATURE\_SENSOR\_TASK\_START**  
Temperature sensor start task

enumerator **TEMPERATURE\_SENSOR\_TASK\_STOP**  
Temperature sensor stop task

enumerator **TEMPERATURE\_SENSOR\_TASK\_MAX**  
Maximum number of temperature sensor tasks

### Header File

- [components/esp\\_driver\\_tsens/include/driver/temperature\\_sensor\\_etm.h](#)
- This header file can be included with:

```
#include "driver/temperature_sensor_etm.h"
```

- This header file is a part of the API provided by the `esp_driver_tsens` component. To declare that your component depends on `esp_driver_tsens`, add the following to your `CMakeLists.txt`:

```
REQUIRES esp_driver_tsens
```

or

```
PRIV_REQUIRES esp_driver_tsens
```

## Functions

*esp\_err\_t* **temperature\_sensor\_new\_etm\_event** (*temperature\_sensor\_handle\_t* tsens, const *temperature\_sensor\_etm\_event\_config\_t* \*config, *esp\_etm\_event\_handle\_t* \*out\_event)

Get the ETM event for Temperature Sensor.

---

**备注:** The created ETM event object can be deleted later by calling `esp_etm_del_event`

---

### 参数

- **tsens** -- **[in]** Temperature Sensor handle, allocated by `temperature_sensor_install()`
- **config** -- **[in]** Temperature Sensor ETM event configuration
- **out\_event** -- **[out]** Returned ETM event handle

### 返回

- ESP\_OK: Get ETM event successfully
- ESP\_ERR\_INVALID\_ARG: Get ETM event failed because of invalid argument
- ESP\_FAIL: Get ETM event failed because of other error

*esp\_err\_t* **temperature\_sensor\_new\_etm\_task** (*temperature\_sensor\_handle\_t* tsens, const *temperature\_sensor\_etm\_task\_config\_t* \*config, *esp\_etm\_task\_handle\_t* \*out\_task)

Get the ETM task for Temperature Sensor.

---

**备注:** The created ETM task object can be deleted later by calling `esp_etm_del_task`

---

### 参数

- **tsens** -- **[in]** Temperature Sensor, allocated by `temperature_sensor_install()`
- **config** -- **[in]** Temperature Sensor ETM task configuration
- **out\_task** -- **[out]** Returned ETM task handle

### 返回

- ESP\_OK: Get ETM task successfully
- ESP\_ERR\_INVALID\_ARG: Get ETM task failed because of invalid argument
- ESP\_FAIL: Get ETM task failed because of other error

## Structures

struct **temperature\_sensor\_etm\_event\_config\_t**

Temperature Sensor ETM event configuration.

## Public Members

*temperature\_sensor\_etm\_event\_type\_t* **event\_type**

Temperature Sensor ETM event type

```
struct temperature_sensor_etm_task_config_t
```

Temperature Sensor ETM task configuration.

### Public Members

```
temperature_sensor_etm_task_type_1 task_type
```

Temperature Sensor ETM task type

## 2.6.28 Two-Wire Automotive Interface (TWAI)

### Overview

The Two-Wire Automotive Interface (TWAI) is a real-time serial communication protocol suited for automotive and industrial applications. It is compatible with ISO11898-1 Classical frames, thus can support Standard Frame Format (11-bit ID) and Extended Frame Format (29-bit ID). The ESP32-H2 contains 1 TWAI controller(s) that can be configured to communicate on a TWAI bus via an external transceiver.

**警告:** The TWAI controller is not compatible with ISO11898-1 FD Format frames, and will interpret such frames as errors.

This programming guide is split into the following sections:

#### Sections

- *Two-Wire Automotive Interface (TWAI)*
  - *Overview*
  - *TWAI Protocol Summary*
  - *Signals Lines and Transceiver*
  - *API Naming Conventions*
  - *Driver Configuration*
  - *Driver Operation*
  - *Examples*
  - *API Reference*

### TWAI Protocol Summary

The TWAI is a multi-master, multi-cast, asynchronous, serial communication protocol. TWAI also supports error detection and signalling, and inbuilt message prioritization.

**Multi-master:** Any node on the bus can initiate the transfer of a message.

**Multi-cast:** When a node transmits a message, all nodes on the bus will receive the message (i.e., broadcast) thus ensuring data consistency across all nodes. However, some nodes can selectively choose which messages to accept via the use of acceptance filtering (multi-cast).

**Asynchronous:** The bus does not contain a clock signal. All nodes on the bus operate at the same bit rate and synchronize using the edges of the bits transmitted on the bus.

**Error Detection and Signaling:** Every node constantly monitors the bus. When any node detects an error, it signals the detection by transmitting an error frame. Other nodes will receive the error frame and transmit their own error frames in response. This results in an error detection being propagated to all nodes on the bus.

**Message Priorities:** Messages contain an ID field. If two or more nodes attempt to transmit simultaneously, the node transmitting the message with the lower ID value will win arbitration of the bus. All other nodes will become receivers ensuring that there is at most one transmitter at any time.

**TWAI Messages** TWAI Messages are split into Data Frames and Remote Frames. Data Frames are used to deliver a data payload to other nodes, whereas a Remote Frame is used to request a Data Frame from other nodes (other nodes can optionally respond with a Data Frame). Data and Remote Frames have two frame formats known as **Extended Frame** and **Standard Frame** which contain a 29-bit ID and an 11-bit ID respectively. A TWAI message consists of the following fields:

- 29-bit or 11-bit ID: Determines the priority of the message (lower value has higher priority).
- Data Length Code (DLC) between 0 to 8: Indicates the size (in bytes) of the data payload for a Data Frame, or the amount of data to request for a Remote Frame.
- Up to 8 bytes of data for a Data Frame (should match DLC).

**Error States and Counters** The TWAI protocol implements a feature known as "fault confinement" where a persistently erroneous node will eventually eliminate itself from the bus. This is implemented by requiring every node to maintain two internal error counters known as the **Transmit Error Counter (TEC)** and the **Receive Error Counter (REC)**. The two error counters are incremented and decremented according to a set of rules (where the counters increase on an error, and decrease on a successful message transmission/reception). The values of the counters are used to determine a node's **error state**, namely **Error Active**, **Error Passive**, and **Bus-Off**.

**Error Active:** A node is Error Active when **both TEC and REC are less than 128** and indicates that the node is operating normally. Error Active nodes are allowed to participate in bus communications, and will actively signal the detection of any errors by automatically transmitting an **Active Error Flag** over the bus.

**Error Passive:** A node is Error Passive when **either the TEC or REC becomes greater than or equal to 128**. Error Passive nodes are still able to take part in bus communications, but will instead transmit a **Passive Error Flag** upon detection of an error.

**Bus-Off:** A node becomes Bus-Off when the **TEC becomes greater than or equal to 256**. A Bus-Off node is unable influence the bus in any manner (essentially disconnected from the bus) thus eliminating itself from the bus. A node will remain in the Bus-Off state until it undergoes bus-off recovery.

### Signals Lines and Transceiver

The TWAI controller does not contain an integrated transceiver. Therefore, to connect the TWAI controller to a TWAI bus, **an external transceiver is required**. The type of external transceiver used should depend on the application's physical layer specification (e.g., using SN65HVD23x transceivers for ISO 11898-2 compatibility).

The TWAI controller's interface consists of 4 signal lines known as **TX, RX, BUS-OFF, and CLKOUT**. These four signal lines can be routed through the GPIO Matrix to the ESP32-H2's GPIO pads.

**TX and RX:** The TX and RX signal lines are required to interface with an external transceiver. Both signal lines represent/interpret a dominant bit as a low logic level (0 V), and a recessive bit as a high logic level (3.3 V).

**BUS-OFF:** The BUS-OFF signal line is **optional** and is set to a low logic level (0 V) whenever the TWAI controller reaches a bus-off state. The BUS-OFF signal line is set to a high logic level (3.3 V) otherwise.

**CLKOUT:** The CLKOUT signal line is **optional** and outputs a prescaled version of the controller's source clock.

---

**备注:** An external transceiver **must internally loopback the TX to RX** such that a change in logic level to the TX signal line can be observed on the RX line. Failing to do so will cause the TWAI controller to interpret differences in logic levels between the two signal lines as a loss in arbitration or a bit error.

---



图 25: Signal lines of the TWAI controller

### API Naming Conventions

**备注:** The TWAI driver provides two sets of API. One is handle-free and is widely used in IDF versions earlier than v5.2, but it can only support one TWAI hardware controller. The other set is with handles, and the function name is usually suffixed with "v2", which can support any number of TWAI controllers. These two sets of API can be used at the same time, but it is recommended to use the "v2" version in your new projects.

### Driver Configuration

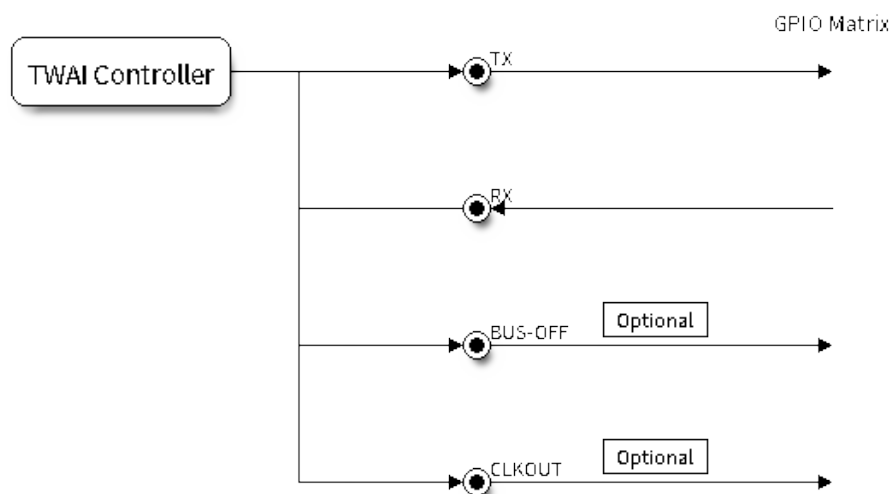
This section covers how to configure the TWAI driver.

**Operating Modes** The TWAI driver supports the following modes of operations:

**Normal Mode:** The normal operating mode allows the TWAI controller to take part in bus activities such as transmitting and receiving messages/error frames. Acknowledgement from another node is required when transmitting a message.

**No Ack Mode:** The No Acknowledgement mode is similar to normal mode, however acknowledgements are not required for a message transmission to be considered successful. This mode is useful when self testing the TWAI controller (loopback of transmissions).

**Listen Only Mode:** This mode prevents the TWAI controller from influencing the bus. Therefore, transmission of messages/acknowledgement/error frames will be disabled. However the TWAI controller is still able to receive messages but will not acknowledge the message. This mode is suited for bus monitor applications.

**Alerts** The TWAI driver contains an alert feature that is used to notify the application layer of certain TWAI controller or TWAI bus events. Alerts are selectively enabled when the TWAI driver is installed, but can be reconfigured during runtime by calling `twai_reconfigure_alerts()`. The application can then wait for any enabled alerts to occur by calling `twai_read_alerts()`. The TWAI driver supports the following alerts:



表 3: TWAI Driver Alerts

Alert Flag	Description
TWAI_ALERT_TX_IDLE	No more messages queued for transmission
TWAI_ALERT_TX_SUCCESS	The previous transmission was successful
TWAI_ALERT_RX_DATA	A frame has been received and added to the RX queue
TWAI_ALERT_BELOW_ERR_WARN	Both error counters have dropped below error warning limit
TWAI_ALERT_ERR_ACTIVE	TWAI controller has become error active
TWAI_ALERT_RECOVERY_IN_PROGRESS	TWAI controller is undergoing bus recovery
TWAI_ALERT_BUS_RECOVERED	TWAI controller has successfully completed bus recovery
TWAI_ALERT_ARB_LOST	The previous transmission lost arbitration
TWAI_ALERT_ABOVE_ERR_WARN	One of the error counters have exceeded the error warning limit
TWAI_ALERT_BUS_ERROR	A (Bit, Stuff, CRC, Form, ACK) error has occurred on the bus
TWAI_ALERT_TX_FAILED	The previous transmission has failed
TWAI_ALERT_RX_QUEUE_FULL	The RX queue is full causing a received frame to be lost
TWAI_ALERT_ERR_PASS	TWAI controller has become error passive
TWAI_ALERT_BUS_OFF	Bus-off condition occurred. TWAI controller can no longer influence bus

**备注:** The TWAI controller's **error warning limit** is used to preemptively warn the application of bus errors before the error passive state is reached. By default, the TWAI driver sets the **error warning limit** to **96**. The TWAI\_ALERT\_ABOVE\_ERR\_WARN is raised when the TEC or REC becomes larger than or equal to the error warning limit. The TWAI\_ALERT\_BELOW\_ERR\_WARN is raised when both TEC and REC return back to values below **96**.

**备注:** When enabling alerts, the TWAI\_ALERT\_AND\_LOG flag can be used to cause the TWAI driver to log any raised alerts to UART. However, alert logging is disabled and TWAI\_ALERT\_AND\_LOG if the [CONFIG\\_TWAI\\_ISR\\_IN\\_IRAM](#) option is enabled (see [Placing ISR into IRAM](#)).

**备注:** The TWAI\_ALERT\_ALL and TWAI\_ALERT\_NONE macros can also be used to enable/disable all alerts during configuration/reconfiguration.

**Bit Timing** The operating bit rate of the TWAI driver is configured using the `twai_timing_config_t` structure. The period of each bit is made up of multiple **time quanta**, and the period of a **time quantum** is determined by a pre-scaled version of the TWAI controller's source clock. A single bit contains the following segments in the following order:

1. The **Synchronization Segment** consists of a single time quantum
2. **Timing Segment 1** consists of 1 to 16 time quanta before sample point
3. **Timing Segment 2** consists of 1 to 8 time quanta after sample point

The **Baudrate Prescaler** is used to determine the period of each time quantum by dividing the TWAI controller's source clock. On the ESP32-H2, the `brp` can be **any even number from 2 to 32768**. Alternatively, you can decide the resolution of each quantum, by setting `twai_timing_config_t::quanta_resolution_hz` to a non-zero value. In this way, the driver can calculate the underlying `brp` value for you. It is useful when you set different clock sources but want the bitrate to keep the same.

Supported clock source for a TWAI controller is listed in the `twai_clock_source_t` and can be specified in `twai_timing_config_t::clk_src`.

The sample point of a bit is located on the intersection of Timing Segment 1 and 2. Enabling **Triple Sampling** causes 3 time quanta to be sampled per bit instead of 1 (extra samples are located at the tail end of Timing Segment 1).



图 26: Bit timing configuration for 500kbit/s given BRP = 8, clock source frequency is 80MHz

The **Synchronization Jump Width** is used to determine the maximum number of time quanta a single bit time can be lengthened/shortened for synchronization purposes. `sjw` can **range from 1 to 4**.

**备注:** Multiple combinations of `brp`, `tseg_1`, `tseg_2`, and `sjw` can achieve the same bit rate. Users should tune these values to the physical characteristics of their bus by taking into account factors such as **propagation delay, node information processing time, and phase errors**.

Bit timing **macro initializers** are also available for commonly used bit rates. The following macro initializers are provided by the TWAI driver.

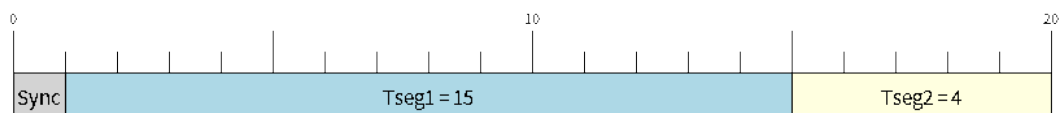
- `TWAI_TIMING_CONFIG_1MBITS`
- `TWAI_TIMING_CONFIG_800KBITS`
- `TWAI_TIMING_CONFIG_500KBITS`
- `TWAI_TIMING_CONFIG_250KBITS`
- `TWAI_TIMING_CONFIG_125KBITS`
- `TWAI_TIMING_CONFIG_100KBITS`
- `TWAI_TIMING_CONFIG_50KBITS`
- `TWAI_TIMING_CONFIG_25KBITS`
- `TWAI_TIMING_CONFIG_20KBITS`
- `TWAI_TIMING_CONFIG_16KBITS`
- `TWAI_TIMING_CONFIG_12_5KBITS`
- `TWAI_TIMING_CONFIG_10KBITS`
- `TWAI_TIMING_CONFIG_5KBITS`
- `TWAI_TIMING_CONFIG_1KBITS`

**Acceptance Filter** The TWAI controller contains a hardware acceptance filter which can be used to filter messages of a particular ID. A node that filters out a message **does not receive the message, but will still acknowledge it**. Acceptance filters can make a node more efficient by filtering out messages sent over the bus that are irrelevant to the node. The acceptance filter is configured using two 32-bit values within `twai_filter_config_t` known as the **acceptance code** and the **acceptance mask**.

The **acceptance code** specifies the bit sequence which a message's ID, RTR, and data bytes must match in order for the message to be received by the TWAI controller. The **acceptance mask** is a bit sequence specifying which bits of the acceptance code can be ignored. This allows for a messages of different IDs to be accepted by a single acceptance code.

The acceptance filter can be used under **Single or Dual Filter Mode**. Single Filter Mode uses the acceptance code and mask to define a single filter. This allows for the first two data bytes of a standard frame to be filtered, or the entirety of an extended frame's 29-bit ID. The following diagram illustrates how the 32-bit acceptance code and mask are interpreted under Single Filter Mode (Note: The yellow and blue fields represent standard and extended frame formats respectively).

**Dual Filter Mode** uses the acceptance code and mask to define two separate filters allowing for increased flexibility of ID's to accept, but does not allow for all 29-bits of an extended ID to be filtered. The following diagram illustrates how the 32-bit acceptance code and mask are interpreted under **Dual Filter Mode** (Note: The yellow and blue fields represent standard and extended frame formats respectively).



图 27: Bit layout of single filter mode (Right side MSBit)



图 28: Bit layout of dual filter mode (Right side MSBit)

**Disabling TX Queue** The TX queue can be disabled during configuration by setting the `tx_queue_len` member of `twai_general_config_t` to 0. This allows applications that do not require message transmission to save a small amount of memory when using the TWAI driver.

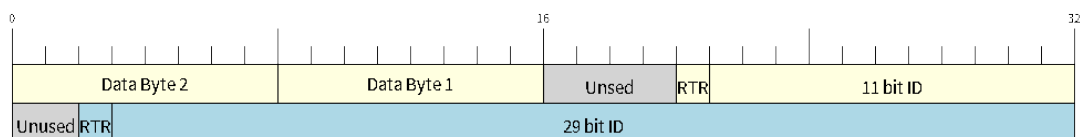
**Placing ISR into IRAM** The TWAI driver's ISR (Interrupt Service Routine) can be placed into IRAM so that the ISR can still run whilst the cache is disabled. Placing the ISR into IRAM may be necessary to maintain the TWAI driver's functionality during lengthy cache disabling operations (such as SPI Flash writes, OTA updates etc). Whilst the cache is disabled, the ISR continues to:

- Read received messages from the RX buffer and place them into the driver's RX queue.
- Load messages pending transmission from the driver's TX queue and write them into the TX buffer.

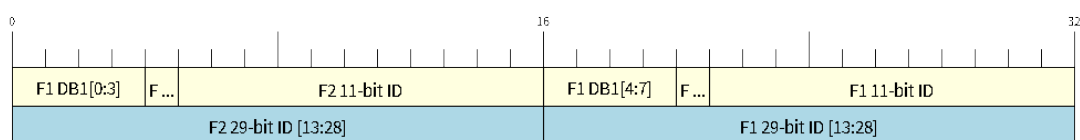
To place the TWAI driver's ISR, users must do the following:

- Enable the `CONFIG_TWAI_ISR_IN_IRAM` option using `idf.py menuconfig`.
- When calling `twai_driver_install()`, the `intr_flags` member of `twai_general_config_t` should set the `ESP_INTR_FLAG_IRAM` set.

**备注:** When the `CONFIG_TWAI_ISR_IN_IRAM` option is enabled, the TWAI driver will no longer log any alerts (i.e., the `TWAI_ALERT_AND_LOG` flag will not have any effect).

## Driver Operation

The TWAI driver is designed with distinct states and strict rules regarding the functions or conditions that trigger a state transition. The following diagram illustrates the various states and their transitions.

Label	Transition	Action/Condition
A	Uninstalled > Stopped	<code>twai_driver_install()</code>
B	Stopped > Uninstalled	<code>twai_driver_uninstall()</code>
C	Stopped > Running	<code>twai_start()</code>
D	Running > Stopped	<code>twai_stop()</code>
E	Running > Bus-Off	Transmit Error Counter $\geq$ 256
F	Bus-Off > Uninstalled	<code>twai_driver_uninstall()</code>
G	Bus-Off > Recovering	<code>twai_initiate_recovery()</code>
H	Recovering > Stopped	128 occurrences of 11 consecutive recessive bits.



图 29: State transition diagram of the TWAI driver (see table below)

**Driver States** **Uninstalled:** In the uninstalled state, no memory is allocated for the driver and the TWAI controller is powered OFF.

**Stopped:** In this state, the TWAI controller is powered ON and the TWAI driver has been installed. However the TWAI controller is unable to take part in any bus activities such as transmitting, receiving, or acknowledging messages.

**Running:** In the running state, the TWAI controller is able to take part in bus activities. Therefore messages can be transmitted/received/acknowledged. Furthermore, the TWAI controller is able to transmit error frames upon detection of errors on the bus.

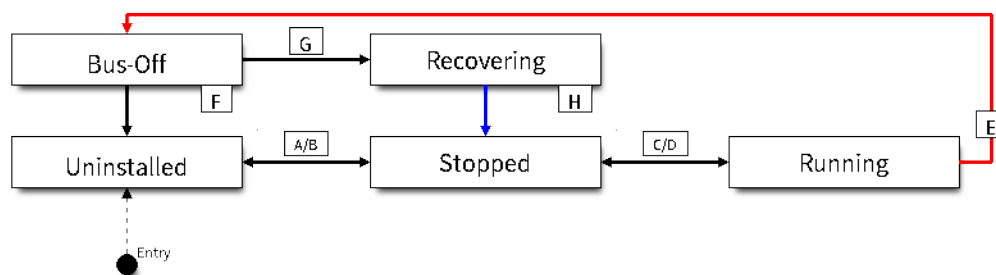
**Bus-Off:** The bus-off state is automatically entered when the TWAI controller's Transmit Error Counter becomes greater than or equal to 256. The bus-off state indicates the occurrence of severe errors on the bus or in the TWAI controller. Whilst in the bus-off state, the TWAI controller is unable to take part in any bus activities. To exit the bus-off state, the TWAI controller must undergo the bus recovery process.

**Recovering:** The recovering state is entered when the TWAI controller undergoes bus recovery. The TWAI controller/TWAI driver remains in the recovering state until the 128 occurrences of 11 consecutive recessive bits is observed on the bus.

**Message Fields and Flags** The TWAI driver distinguishes different types of messages by using the various bit field members of the `twai_message_t` structure. These bit field members determine whether a message is in standard or extended format, a remote frame, and the type of transmission to use when transmitting such a message.

These bit field members can also be toggled using the `flags` member of `twai_message_t` and the following message flags:

Message Flag	Description
TWAI_MSG_FLAG_EXTD	Message is in Extended Frame Format (29bit ID)
TWAI_MSG_FLAG_RTR	Message is a Remote Frame (Remote Transmission Request)
TWAI_MSG_FLAG_SS	Transmit message using Single Shot Transmission (Message will not be re-transmitted upon error or loss of arbitration). Unused for received message.
TWAI_MSG_FLAG_SELF	Transmit message using Self Reception Request (Transmitted message will also be received by the same node). Unused for received message.
TWAI_MSG_FLAG_DLC_NON	Message's Data length code is larger than 8. This will break compliance with TWAI
TWAI_MSG_FLAG_NONE	Clears all bit fields. Equivalent to a Standard Frame Format (11bit ID) Data Frame.

## Examples

**Configuration & Installation** The following code snippet demonstrates how to configure, install, and start the TWAI driver via the use of the various configuration structures, macro initializers, the `twai_driver_install()` function, and the `twai_start()` function.

```

#include "driver/gpio.h"
#include "driver/twai.h"

void app_main()
{
    //Initialize configuration structures using macro initializers
    twai_general_config_t g_config = TWAI_GENERAL_CONFIG_DEFAULT(GPIO_NUM_21, GPIO_
↪NUM_22, TWAI_MODE_NORMAL);
    twai_timing_config_t t_config = TWAI_TIMING_CONFIG_500KBITS();
    twai_filter_config_t f_config = TWAI_FILTER_CONFIG_ACCEPT_ALL();

    //Install TWAI driver
    if (twai_driver_install(&g_config, &t_config, &f_config) == ESP_OK) {
        printf("Driver installed\n");
    } else {
        printf("Failed to install driver\n");
        return;
    }

    //Start TWAI driver
    if (twai_start() == ESP_OK) {
        printf("Driver started\n");
    } else {
        printf("Failed to start driver\n");
        return;
    }

    ...
}

```

The usage of macro initializers is not mandatory and each of the configuration structures can be manually.

**Install Multiple TWAI Instances** The following code snippet demonstrates how to install multiple TWAI instances via the use of the `twai_driver_install_v2()` function.

```

#include "driver/gpio.h"
#include "driver/twai.h"

void app_main()
{
    twai_handle_t twai_bus_0;
    twai_handle_t twai_bus_1;
    //Initialize configuration structures using macro initializers
    twai_general_config_t g_config = TWAI_GENERAL_CONFIG_DEFAULT(GPIO_NUM_0, GPIO_
↪NUM_1, TWAI_MODE_NORMAL);
    twai_timing_config_t t_config = TWAI_TIMING_CONFIG_500KBITS();
    twai_filter_config_t f_config = TWAI_FILTER_CONFIG_ACCEPT_ALL();

    //Install driver for TWAI bus 0
    g_config.controller_id = 0;
    if (twai_driver_install_v2(&g_config, &t_config, &f_config, &twai_bus_0) ==_
↪ESP_OK) {
        printf("Driver installed\n");
    } else {
        printf("Failed to install driver\n");
        return;
    }

    //Start TWAI driver
    if (twai_start_v2(twai_bus_0) == ESP_OK) {
        printf("Driver started\n");
    }
}

```

(下页继续)

```

} else {
    printf("Failed to start driver\n");
    return;
}

//Install driver for TWAI bus 1
g_config.controller_id = 1;
g_config.tx_io = GPIO_NUM_2;
g_config.rx_io = GPIO_NUM_3;
if (twai_driver_install_v2(&g_config, &t_config, &f_config, &twai_bus_1) ==_
↳ESP_OK) {
    printf("Driver installed\n");
} else {
    printf("Failed to install driver\n");
    return;
}
//Start TWAI driver
if (twai_start_v2(twai_bus_1) == ESP_OK) {
    printf("Driver started\n");
} else {
    printf("Failed to start driver\n");
    return;
}

//Other Driver operations must use version 2 API as well
...
}

```

**Message Transmission** The following code snippet demonstrates how to transmit a message via the usage of the `twai_message_t` type and `twai_transmit()` function.

```

#include "driver/twai.h"

...

// Configure message to transmit
twai_message_t message = {
    // Message type and format settings
    .extd = 1,           // Standard vs extended format
    .rtr = 0,           // Data vs RTR frame
    .ss = 0,            // Whether the message is single shot (i.e., does not_
↳repeat on error)
    .self = 0,          // Whether the message is a self reception request_
↳(loopback)
    .dlc_non_comp = 0, // DLC is less than 8
    // Message ID and payload
    .identifier = 0xAAAA,
    .data_length_code = 4,
    .data = {0, 1, 2, 3},
};

//Queue message for transmission
if (twai_transmit(&message, pdMS_TO_TICKS(1000)) == ESP_OK) {
    printf("Message queued for transmission\n");
} else {
    printf("Failed to queue message for transmission\n");
}

```

**Message Reception** The following code snippet demonstrates how to receive a message via the usage of the `twai_message_t` type and `twai_receive()` function.

```
#include "driver/twai.h"

...

//Wait for message to be received
twai_message_t message;
if (twai_receive(&message, pdMS_TO_TICKS(10000)) == ESP_OK) {
    printf("Message received\n");
} else {
    printf("Failed to receive message\n");
    return;
}

//Process received message
if (message.extd) {
    printf("Message is in Extended Format\n");
} else {
    printf("Message is in Standard Format\n");
}
printf("ID is %d\n", message.identifier);
if (!(message.rtr)) {
    for (int i = 0; i < message.data_length_code; i++) {
        printf("Data byte %d = %d\n", i, message.data[i]);
    }
}
```

**Reconfiguring and Reading Alerts** The following code snippet demonstrates how to reconfigure and read TWAI driver alerts via the use of the `twai_reconfigure_alerts()` and `twai_read_alerts()` functions.

```
#include "driver/twai.h"

...

//Reconfigure alerts to detect Error Passive and Bus-Off error states
uint32_t alerts_to_enable = TWAI_ALERT_ERR_PASS | TWAI_ALERT_BUS_OFF;
if (twai_reconfigure_alerts(alerts_to_enable, NULL) == ESP_OK) {
    printf("Alerts reconfigured\n");
} else {
    printf("Failed to reconfigure alerts");
}

//Block indefinitely until an alert occurs
uint32_t alerts_triggered;
twai_read_alerts(&alerts_triggered, portMAX_DELAY);
```

**Stop and Uninstall** The following code demonstrates how to stop and uninstall the TWAI driver via the use of the `twai_stop()` and `twai_driver_uninstall()` functions.

```
#include "driver/twai.h"

...

//Stop the TWAI driver
if (twai_stop() == ESP_OK) {
    printf("Driver stopped\n");
} else {
    printf("Failed to stop driver\n");
}
```

(下页继续)

```

    return;
}

//Uninstall the TWAI driver
if (twai_driver_uninstall() == ESP_OK) {
    printf("Driver uninstalled\n");
} else {
    printf("Failed to uninstall driver\n");
    return;
}

```

**Multiple ID Filter Configuration** The acceptance mask in `twai_filter_config_t` can be configured such that two or more IDs are accepted for a single filter. For a particular filter to accept multiple IDs, the conflicting bit positions amongst the IDs must be set in the acceptance mask. The acceptance code can be set to any one of the IDs.

The following example shows how to calculate the acceptance mask given multiple IDs:

```

ID1 = 11'b101 1010 0000
ID2 = 11'b101 1010 0001
ID3 = 11'b101 1010 0100
ID4 = 11'b101 1010 1000
//Acceptance Mask
MASK = 11'b000 0000 1101

```

**Application Examples** **Network Example:** The TWAI Network example demonstrates communication between two ESP32-H2s using the TWAI driver API. One TWAI node acts as a network master that initiates and ceases the transfer of a data from another node acting as a network slave. The example can be found via [peripherals/twai/twai\\_network](#).

**Alert and Recovery Example:** This example demonstrates how to use the TWAI driver's alert and bus-off recovery API. The example purposely introduces errors on the bus to put the TWAI controller into the Bus-Off state. An alert is used to detect the Bus-Off state and trigger the bus recovery process. The example can be found via [peripherals/twai/twai\\_alert\\_and\\_recovery](#).

**Self Test Example:** This example uses the No Acknowledge Mode and Self Reception Request to cause the TWAI controller to send and simultaneously receive a series of messages. This example can be used to verify if the connections between the TWAI controller and the external transceiver are working correctly. The example can be found via [peripherals/twai/twai\\_self\\_test](#).

## API Reference

### Header File

- `components/hal/include/hal/twai_types.h`
- This header file can be included with:

```
#include "hal/twai_types.h"
```

### Structures

struct `twai_message_t`

Structure to store a TWAI message.

---

备注: The flags member is deprecated

---



**Public Members****uint32\_t extd**

Extended Frame Format (29bit ID)

**uint32\_t rtr**

Message is a Remote Frame

**uint32\_t ss**

Transmit as a Single Shot Transmission. Unused for received.

**uint32\_t self**

Transmit as a Self Reception Request. Unused for received.

**uint32\_t dlc\_non\_comp**

Message's Data length code is larger than 8. This will break compliance with ISO 11898-1

**uint32\_t reserved**

Reserved bits

**uint32\_t flags**

Deprecated: Alternate way to set bits using message flags

**uint32\_t identifier**

11 or 29 bit identifier

**uint8\_t data\_length\_code**

Data length code

**uint8\_t data[TWAI\_FRAME\_MAX\_DLC]**

Data bytes (not relevant in RTR frame)

**struct twai\_timing\_config\_t**

Structure for bit timing configuration of the TWAI driver.

---

**备注:** Macro initializers are available for this structure

---

**Public Members*****twai\_clock\_source\_t* clk\_src**

Clock source, set to 0 or TWAI\_CLK\_SRC\_DEFAULT if you want a default clock source

**uint32\_t quanta\_resolution\_hz**The resolution of one timing quanta, in Hz. Note: the value of `brp` will be reflected by this field if it's non-zero, otherwise, `brp` needs to be set manually

uint32\_t **brp**

Baudrate prescale (i.e., clock divider). Any even number from 2 to 128 for ESP32, 2 to 32768 for non-ESP32 chip. Note: For ESP32 ECO 2 or later, multiples of 4 from 132 to 256 are also supported

uint8\_t **tseg\_1**

Timing segment 1 (Number of time quanta, between 1 to 16)

uint8\_t **tseg\_2**

Timing segment 2 (Number of time quanta, 1 to 8)

uint8\_t **sjw**

Synchronization Jump Width (Max time quanta jump for synchronize from 1 to 4)

bool **triple\_sampling**

Enables triple sampling when the TWAI controller samples a bit

struct **twai\_filter\_config\_t**

Structure for acceptance filter configuration of the TWAI driver (see documentation)

---

备注: Macro initializers are available for this structure

---

### Public Members

uint32\_t **acceptance\_code**

32-bit acceptance code

uint32\_t **acceptance\_mask**

32-bit acceptance mask

bool **single\_filter**

Use Single Filter Mode (see documentation)

### Macros

**TWAI\_EXTD\_ID\_MASK**

TWAI Constants.

Bit mask for 29 bit Extended Frame Format ID

**TWAI\_STD\_ID\_MASK**

Bit mask for 11 bit Standard Frame Format ID

**TWAI\_FRAME\_MAX\_DLC**

Max data bytes allowed in TWAI

**TWAI\_FRAME\_EXTD\_ID\_LEN\_BYTES**

EFF ID requires 4 bytes (29bit)

**TWAI\_FRAME\_STD\_ID\_LEN\_BYTES**

SFF ID requires 2 bytes (11bit)

**TWAI\_ERR\_PASS\_THRESH**

Error counter threshold for error passive

**Type Definitions**

typedef *soc\_periph\_twai\_clk\_src\_t* **twai\_clock\_source\_t**

RMT group clock source.

---

**备注:** User should select the clock source based on the power and resolution requirement

---

**Enumerations**

enum **twai\_mode\_t**

TWAI Controller operating modes.

*Values:*

enumerator **TWAI\_MODE\_NORMAL**

Normal operating mode where TWAI controller can send/receive/acknowledge messages

enumerator **TWAI\_MODE\_NO\_ACK**

Transmission does not require acknowledgment. Use this mode for self testing

enumerator **TWAI\_MODE\_LISTEN\_ONLY**

The TWAI controller will not influence the bus (No transmissions or acknowledgments) but can receive messages

**Header File**

- [components/driver/twai/include/driver/twai.h](#)
- This header file can be included with:

```
#include "driver/twai.h"
```

- This header file is a part of the API provided by the `driver` component. To declare that your component depends on `driver`, add the following to your `CMakeLists.txt`:

```
REQUIRES driver
```

or

```
PRIV_REQUIRES driver
```

**Functions**

*esp\_err\_t* **twai\_driver\_install** (const *twai\_general\_config\_t* \*g\_config, const *twai\_timing\_config\_t* \*t\_config, const *twai\_filter\_config\_t* \*f\_config)

Install TWAI driver.

This function installs the TWAI driver using three configuration structures. The required memory is allocated and the TWAI driver is placed in the stopped state after running this function.

---

**备注:** Macro initializers are available for the configuration structures (see documentation)

---



---

**备注:** To reinstall the TWAI driver, call `twai_driver_uninstall()` first

---

#### 参数

- **g\_config** -- **[in]** General configuration structure
- **t\_config** -- **[in]** Timing configuration structure
- **f\_config** -- **[in]** Filter configuration structure

#### 返回

- ESP\_OK: Successfully installed TWAI driver
- ESP\_ERR\_INVALID\_ARG: Arguments are invalid, e.g. invalid clock source, invalid quanta resolution
- ESP\_ERR\_NO\_MEM: Insufficient memory
- ESP\_ERR\_INVALID\_STATE: Driver is already installed

*esp\_err\_t twai\_driver\_install\_v2* (const *twai\_general\_config\_t* \*g\_config, const *twai\_timing\_config\_t* \*t\_config, const *twai\_filter\_config\_t* \*f\_config, *twai\_handle\_t* \*ret\_twai)

Install TWAI driver and return a handle.

---

**备注:** This is an advanced version of `twai_driver_install` that can return a driver handle, so that it allows you to install multiple TWAI drivers. Don't forget to set the proper `controller_id` in the *twai\_general\_config\_t*. Please refer to the documentation of `twai_driver_install` for more details.

---

#### 参数

- **g\_config** -- **[in]** General configuration structure
- **t\_config** -- **[in]** Timing configuration structure
- **f\_config** -- **[in]** Filter configuration structure
- **ret\_twai** -- **[out]** Pointer to a new created TWAI handle

#### 返回

- ESP\_OK: Successfully installed TWAI driver
- ESP\_ERR\_INVALID\_ARG: Arguments are invalid, e.g. invalid clock source, invalid quanta resolution, invalid controller ID
- ESP\_ERR\_NO\_MEM: Insufficient memory
- ESP\_ERR\_INVALID\_STATE: Driver is already installed

*esp\_err\_t twai\_driver\_uninstall* (void)

Uninstall the TWAI driver.

This function uninstalls the TWAI driver, freeing the memory utilized by the driver. This function can only be called when the driver is in the stopped state or the bus-off state.

**警告:** The application must ensure that no tasks are blocked on TX/RX queues or alerts when this function is called.

#### 返回

- ESP\_OK: Successfully uninstalled TWAI driver
- ESP\_ERR\_INVALID\_STATE: Driver is not in stopped/bus-off state, or is not installed

*esp\_err\_t twai\_driver\_uninstall\_v2* (*twai\_handle\_t* handle)

Uninstall the TWAI driver with a given handle.

---

**备注:** This is an advanced version of `twai_driver_uninstall` that can uninstall a TWAI driver with a given handle. Please refer to the documentation of `twai_driver_uninstall` for more details.

---

**参数** `handle` -- [in] TWAI driver handle returned by `twai_driver_install_v2`

**返回**

- ESP\_OK: Successfully uninstalled TWAI driver
- ESP\_ERR\_INVALID\_STATE: Driver is not in stopped/bus-off state, or is not installed

*esp\_err\_t twai\_start* (void)

Start the TWAI driver.

This function starts the TWAI driver, putting the TWAI driver into the running state. This allows the TWAI driver to participate in TWAI bus activities such as transmitting/receiving messages. The TX and RX queue are reset in this function, clearing any messages that are unread or pending transmission. This function can only be called when the TWAI driver is in the stopped state.

**返回**

- ESP\_OK: TWAI driver is now running
- ESP\_ERR\_INVALID\_STATE: Driver is not in stopped state, or is not installed

*esp\_err\_t twai\_start\_v2* (*twai\_handle\_t* handle)

Start the TWAI driver with a given handle.

---

**备注:** This is an advanced version of `twai_start` that can start a TWAI driver with a given handle. Please refer to the documentation of `twai_start` for more details.

---

**参数** `handle` -- [in] TWAI driver handle returned by `twai_driver_install_v2`

**返回**

- ESP\_OK: TWAI driver is now running
- ESP\_ERR\_INVALID\_STATE: Driver is not in stopped state, or is not installed

*esp\_err\_t twai\_stop* (void)

Stop the TWAI driver.

This function stops the TWAI driver, preventing any further message from being transmitted or received until `twai_start()` is called. Any messages in the TX queue are cleared. Any messages in the RX queue should be read by the application after this function is called. This function can only be called when the TWAI driver is in the running state.

**警告:** A message currently being transmitted/received on the TWAI bus will be ceased immediately. This may lead to other TWAI nodes interpreting the unfinished message as an error.

**返回**

- ESP\_OK: TWAI driver is now Stopped
- ESP\_ERR\_INVALID\_STATE: Driver is not in running state, or is not installed

*esp\_err\_t twai\_stop\_v2* (*twai\_handle\_t* handle)

Stop the TWAI driver with a given handle.

---

**备注:** This is an advanced version of `twai_stop` that can stop a TWAI driver with a given handle. Please refer to the documentation of `twai_stop` for more details.

---

**参数** `handle` -- **[in]** TWAI driver handle returned by `twai_driver_install_v2`

- 返回**
- `ESP_OK`: TWAI driver is now Stopped
  - `ESP_ERR_INVALID_STATE`: Driver is not in running state, or is not installed

*esp\_err\_t* `twai_transmit` (const *twai\_message\_t* \*message, TickType\_t ticks\_to\_wait)

Transmit a TWAI message.

This function queues a TWAI message for transmission. Transmission will start immediately if no other messages are queued for transmission. If the TX queue is full, this function will block until more space becomes available or until it times out. If the TX queue is disabled (TX queue length = 0 in configuration), this function will return immediately if another message is undergoing transmission. This function can only be called when the TWAI driver is in the running state and cannot be called under Listen Only Mode.

---

**备注:** This function does not guarantee that the transmission is successful. The `TX_SUCCESS/TX_FAILED` alert can be enabled to alert the application upon the success/failure of a transmission.

---



---

**备注:** The `TX_IDLE` alert can be used to alert the application when no other messages are awaiting transmission.

---

**参数**

- **message** -- **[in]** Message to transmit
- **ticks\_to\_wait** -- **[in]** Number of FreeRTOS ticks to block on the TX queue

**返回**

- `ESP_OK`: Transmission successfully queued/initiated
- `ESP_ERR_INVALID_ARG`: Arguments are invalid
- `ESP_ERR_TIMEOUT`: Timed out waiting for space on TX queue
- `ESP_FAIL`: TX queue is disabled and another message is currently transmitting
- `ESP_ERR_INVALID_STATE`: TWAI driver is not in running state, or is not installed
- `ESP_ERR_NOT_SUPPORTED`: Listen Only Mode does not support transmissions

*esp\_err\_t* `twai_transmit_v2` (*twai\_handle\_t* handle, const *twai\_message\_t* \*message, TickType\_t ticks\_to\_wait)

Transmit a TWAI message via a given handle.

---

**备注:** This is an advanced version of `twai_transmit` that can transmit a TWAI message with a given handle. Please refer to the documentation of `twai_transmit` for more details.

---

**参数**

- **handle** -- **[in]** TWAI driver handle returned by `twai_driver_install_v2`
- **message** -- **[in]** Message to transmit
- **ticks\_to\_wait** -- **[in]** Number of FreeRTOS ticks to block on the TX queue

**返回**

- `ESP_OK`: Transmission successfully queued/initiated
- `ESP_ERR_INVALID_ARG`: Arguments are invalid
- `ESP_ERR_TIMEOUT`: Timed out waiting for space on TX queue
- `ESP_FAIL`: TX queue is disabled and another message is currently transmitting
- `ESP_ERR_INVALID_STATE`: TWAI driver is not in running state, or is not installed
- `ESP_ERR_NOT_SUPPORTED`: Listen Only Mode does not support transmissions

*esp\_err\_t twai\_receive* (*twai\_message\_t* \*message, TickType\_t ticks\_to\_wait)

Receive a TWAI message.

This function receives a message from the RX queue. The flags field of the message structure will indicate the type of message received. This function will block if there are no messages in the RX queue

**警告:** The flags field of the received message should be checked to determine if the received message contains any data bytes.

#### 参数

- **message** -- [out] Received message
- **ticks\_to\_wait** -- [in] Number of FreeRTOS ticks to block on RX queue

#### 返回

- ESP\_OK: Message successfully received from RX queue
- ESP\_ERR\_TIMEOUT: Timed out waiting for message
- ESP\_ERR\_INVALID\_ARG: Arguments are invalid
- ESP\_ERR\_INVALID\_STATE: TWAI driver is not installed

*esp\_err\_t twai\_receive\_v2* (*twai\_handle\_t* handle, *twai\_message\_t* \*message, TickType\_t ticks\_to\_wait)

Receive a TWAI message via a given handle.

---

**备注:** This is an advanced version of `twai_receive` that can receive a TWAI message with a given handle. Please refer to the documentation of `twai_receive` for more details.

---

#### 参数

- **handle** -- [in] TWAI driver handle returned by `twai_driver_install_v2`
- **message** -- [out] Received message
- **ticks\_to\_wait** -- [in] Number of FreeRTOS ticks to block on RX queue

#### 返回

- ESP\_OK: Message successfully received from RX queue
- ESP\_ERR\_TIMEOUT: Timed out waiting for message
- ESP\_ERR\_INVALID\_ARG: Arguments are invalid
- ESP\_ERR\_INVALID\_STATE: TWAI driver is not installed

*esp\_err\_t twai\_read\_alerts* (uint32\_t \*alerts, TickType\_t ticks\_to\_wait)

Read TWAI driver alerts.

This function will read the alerts raised by the TWAI driver. If no alert has been issued when this function is called, this function will block until an alert occurs or until it timeouts.

---

**备注:** Multiple alerts can be raised simultaneously. The application should check for all alerts that have been enabled.

---

#### 参数

- **alerts** -- [out] Bit field of raised alerts (see documentation for alert flags)
- **ticks\_to\_wait** -- [in] Number of FreeRTOS ticks to block for alert

#### 返回

- ESP\_OK: Alerts read
- ESP\_ERR\_TIMEOUT: Timed out waiting for alerts
- ESP\_ERR\_INVALID\_ARG: Arguments are invalid
- ESP\_ERR\_INVALID\_STATE: TWAI driver is not installed

*esp\_err\_t twai\_read\_alerts\_v2* (*twai\_handle\_t* handle, uint32\_t \*alerts, TickType\_t ticks\_to\_wait)

Read TWAI driver alerts with a given handle.

---

**备注:** This is an advanced version of `twai_read_alerts` that can read TWAI driver alerts with a given handle. Please refer to the documentation of `twai_read_alerts` for more details.

---

#### 参数

- **handle** -- [in] TWAI driver handle returned by `twai_driver_install_v2`
- **alerts** -- [out] Bit field of raised alerts (see documentation for alert flags)
- **ticks\_to\_wait** -- [in] Number of FreeRTOS ticks to block for alert

#### 返回

- ESP\_OK: Alerts read
- ESP\_ERR\_TIMEOUT: Timed out waiting for alerts
- ESP\_ERR\_INVALID\_ARG: Arguments are invalid
- ESP\_ERR\_INVALID\_STATE: TWAI driver is not installed

*esp\_err\_t twai\_reconfigure\_alerts* (uint32\_t alerts\_enabled, uint32\_t \*current\_alerts)

Reconfigure which alerts are enabled.

This function reconfigures which alerts are enabled. If there are alerts which have not been read whilst reconfiguring, this function can read those alerts.

#### 参数

- **alerts\_enabled** -- [in] Bit field of alerts to enable (see documentation for alert flags)
- **current\_alerts** -- [out] Bit field of currently raised alerts. Set to NULL if unused

#### 返回

- ESP\_OK: Alerts reconfigured
- ESP\_ERR\_INVALID\_STATE: TWAI driver is not installed

*esp\_err\_t twai\_reconfigure\_alerts\_v2* (*twai\_handle\_t* handle, uint32\_t alerts\_enabled, uint32\_t \*current\_alerts)

Reconfigure which alerts are enabled, with a given handle.

---

**备注:** This is an advanced version of `twai_reconfigure_alerts` that can reconfigure which alerts are enabled with a given handle. Please refer to the documentation of `twai_reconfigure_alerts` for more details.

---

#### 参数

- **handle** -- [in] TWAI driver handle returned by `twai_driver_install_v2`
- **alerts\_enabled** -- [in] Bit field of alerts to enable (see documentation for alert flags)
- **current\_alerts** -- [out] Bit field of currently raised alerts. Set to NULL if unused

#### 返回

- ESP\_OK: Alerts reconfigured
- ESP\_ERR\_INVALID\_STATE: TWAI driver is not installed

*esp\_err\_t twai\_initiate\_recovery* (void)

Start the bus recovery process.

This function initiates the bus recovery process when the TWAI driver is in the bus-off state. Once initiated, the TWAI driver will enter the recovering state and wait for 128 occurrences of the bus-free signal on the TWAI bus before returning to the stopped state. This function will reset the TX queue, clearing any messages pending transmission.

---

**备注:** The BUS\_RECOVERED alert can be enabled to alert the application when the bus recovery process completes.

---



**返回**

- ESP\_OK: Bus recovery started
- ESP\_ERR\_INVALID\_STATE: TWAI driver is not in the bus-off state, or is not installed

*esp\_err\_t twai\_initiate\_recovery\_v2* (*twai\_handle\_t* handle)

Start the bus recovery process with a given handle.

---

**备注:** This is an advanced version of `twai_initiate_recovery` that can start the bus recovery process with a given handle. Please refer to the documentation of `twai_initiate_recovery` for more details.

---

**参数** **handle** -- [in] TWAI driver handle returned by `twai_driver_install_v2`

**返回**

- ESP\_OK: Bus recovery started
- ESP\_ERR\_INVALID\_STATE: TWAI driver is not in the bus-off state, or is not installed

*esp\_err\_t twai\_get\_status\_info* (*twai\_status\_info\_t* \*status\_info)

Get current status information of the TWAI driver.

**参数** **status\_info** -- [out] Status information

**返回**

- ESP\_OK: Status information retrieved
- ESP\_ERR\_INVALID\_ARG: Arguments are invalid
- ESP\_ERR\_INVALID\_STATE: TWAI driver is not installed

*esp\_err\_t twai\_get\_status\_info\_v2* (*twai\_handle\_t* handle, *twai\_status\_info\_t* \*status\_info)

Get current status information of a given TWAI driver handle.

---

**备注:** This is an advanced version of `twai_get_status_info` that can get current status information of a given TWAI driver handle. Please refer to the documentation of `twai_get_status_info` for more details.

---

**参数**

- **handle** -- [in] TWAI driver handle returned by `twai_driver_install_v2`
- **status\_info** -- [out] Status information

**返回**

- ESP\_OK: Status information retrieved
- ESP\_ERR\_INVALID\_ARG: Arguments are invalid
- ESP\_ERR\_INVALID\_STATE: TWAI driver is not installed

*esp\_err\_t twai\_clear\_transmit\_queue* (void)

Clear the transmit queue.

This function will clear the transmit queue of all messages.

---

**备注:** The transmit queue is automatically cleared when `twai_stop()` or `twai_initiate_recovery()` is called.

---

**返回**

- ESP\_OK: Transmit queue cleared
- ESP\_ERR\_INVALID\_STATE: TWAI driver is not installed or TX queue is disabled

*esp\_err\_t twai\_clear\_transmit\_queue\_v2* (*twai\_handle\_t* handle)

Clear the transmit queue of a given TWAI driver handle.

---

**备注:** This is an advanced version of `twai_clear_transmit_queue` that can clear the transmit queue of a given TWAI driver handle. Please refer to the documentation of `twai_clear_transmit_queue` for more details.

---

**参数** `handle` -- [in] TWAI driver handle returned by `twai_driver_install_v2`

**返回**

- `ESP_OK`: Transmit queue cleared
- `ESP_ERR_INVALID_STATE`: TWAI driver is not installed or TX queue is disabled

*esp\_err\_t* `twai_clear_receive_queue` (void)

Clear the receive queue.

This function will clear the receive queue of all messages.

---

**备注:** The receive queue is automatically cleared when `twai_start()` is called.

---

**返回**

- `ESP_OK`: Transmit queue cleared
- `ESP_ERR_INVALID_STATE`: TWAI driver is not installed

*esp\_err\_t* `twai_clear_receive_queue_v2` (*twai\_handle\_t* handle)

Clear the receive queue of a given TWAI driver handle.

---

**备注:** This is an advanced version of `twai_clear_receive_queue` that can clear the receive queue of a given TWAI driver handle. Please refer to the documentation of `twai_clear_receive_queue` for more details.

---

**参数** `handle` -- [in] TWAI driver handle returned by `twai_driver_install_v2`

**返回**

- `ESP_OK`: Transmit queue cleared
- `ESP_ERR_INVALID_STATE`: TWAI driver is not installed

## Structures

struct `twai_general_config_t`

Structure for general configuration of the TWAI driver.

---

**备注:** Macro initializers are available for this structure

---

## Public Members

int `controller_id`

TWAI controller ID, index from 0. If you want to install TWAI driver with a non-zero `controller_id`, please use `twai_driver_install_v2`

*twai\_mode\_t* `mode`

Mode of TWAI controller

`gpio_num_t tx_io`

Transmit GPIO number

`gpio_num_t rx_io`

Receive GPIO number

`gpio_num_t clkout_io`

CLKOUT GPIO number (optional, set to -1 if unused)

`gpio_num_t bus_off_io`

Bus off indicator GPIO number (optional, set to -1 if unused)

`uint32_t tx_queue_len`

Number of messages TX queue can hold (set to 0 to disable TX Queue)

`uint32_t rx_queue_len`

Number of messages RX queue can hold

`uint32_t alerts_enabled`

Bit field of alerts to enable (see documentation)

`uint32_t clkout_divider`

CLKOUT divider. Can be 1 or any even number from 2 to 14 (optional, set to 0 if unused)

`int intr_flags`

Interrupt flags to set the priority of the driver's ISR. Note that to use the `ESP_INTR_FLAG_IRAM`, the `CONFIG_TWAI_ISR_IN_IRAM` option should be enabled first.

struct `twai_status_info_t`

Structure to store status information of TWAI driver.

## Public Members

`twai_state_t state`

Current state of TWAI controller (Stopped/Running/Bus-Off/Recovery)

`uint32_t msgs_to_tx`

Number of messages queued for transmission or awaiting transmission completion

`uint32_t msgs_to_rx`

Number of messages in RX queue waiting to be read

`uint32_t tx_error_counter`

Current value of Transmit Error Counter

`uint32_t rx_error_counter`

Current value of Receive Error Counter

uint32\_t **tx\_failed\_count**

Number of messages that failed transmissions

uint32\_t **rx\_missed\_count**

Number of messages that were lost due to a full RX queue (or errata workaround if enabled)

uint32\_t **rx\_overrun\_count**

Number of messages that were lost due to a RX FIFO overrun

uint32\_t **arb\_lost\_count**

Number of instances arbitration was lost

uint32\_t **bus\_error\_count**

Number of instances a bus error has occurred

## Macros

**TWAI\_IO\_UNUSED**

Marks GPIO as unused in TWAI configuration

## Type Definitions

typedef struct twai\_obj\_t \***twai\_handle\_t**

TWAI controller handle.

## Enumerations

enum **twai\_state\_t**

TWAI driver states.

*Values:*

enumerator **TWAI\_STATE\_STOPPED**

Stopped state. The TWAI controller will not participate in any TWAI bus activities

enumerator **TWAI\_STATE\_RUNNING**

Running state. The TWAI controller can transmit and receive messages

enumerator **TWAI\_STATE\_BUS\_OFF**

Bus-off state. The TWAI controller cannot participate in bus activities until it has recovered

enumerator **TWAI\_STATE\_RECOVERING**

Recovering state. The TWAI controller is undergoing bus recovery

## 2.6.29 通用异步接收器/发送器 (UART)

## 简介

通用异步接收器/发送器 (UART) 属于一种硬件功能，通过使用 RS232、RS422、RS485 等常见异步串行通信接口来处理通信时序要求和数据帧。UART 是实现不同设备之间全双工或半双工数据交换的一种常用且经济的方式。

ESP32-H2 芯片有 2 个 UART 控制器（也称为端口），每个控制器都有一组相同的寄存器以简化编程并提高灵活性。

每个 UART 控制器可以独立配置波特率、数据位长度、位顺序、停止位位数、奇偶校验位等参数。所有具备完整功能的 UART 控制器都能与不同制造商的 UART 设备兼容，并且支持红外数据协会 (IrDA) 定义的标准协议。

## 功能概述

下文介绍了如何使用 UART 驱动程序的函数和数据类型在 ESP32-H2 和其他 UART 设备之间建立通信。基本编程流程分为以下几个步骤：

1. **设置通信参数** - 设置波特率、数据位、停止位等
2. **设置通信管脚** - 分配连接设备的管脚
3. **安装驱动程序** - 为 UART 驱动程序分配 ESP32-H2 资源
4. **运行 UART 通信** - 发送/接收数据
5. **使用中断** - 触发特定通信事件的中断
6. **删除驱动程序** - 如无需 UART 通信，则释放已分配的资源

步骤 1 到 3 为配置阶段，步骤 4 为 UART 运行阶段，步骤 5 和 6 为可选步骤。

UART 驱动程序函数通过 `uart_port_t` 识别不同的 UART 控制器。调用以下所有函数均需此标识。

**设置通信参数** UART 通信参数可以在一个步骤中完成全部配置，也可以在多个步骤中单独配置。

**一次性配置所有参数** 调用函数 `uart_param_config()` 并向其传递 `uart_config_t` 结构体，`uart_config_t` 结构体应包含所有必要的参数。请参考以下示例。

```
const uart_port_t uart_num = UART_NUM_1;
uart_config_t uart_config = {
    .baud_rate = 115200,
    .data_bits = UART_DATA_8_BITS,
    .parity = UART_PARITY_DISABLE,
    .stop_bits = UART_STOP_BITS_1,
    .flow_ctrl = UART_HW_FLOWCTRL_CTS_RTS,
    .rx_flow_ctrl_thresh = 122,
};
// Configure UART parameters
ESP_ERROR_CHECK(uart_param_config(uart_num, &uart_config));
```

了解配置硬件流控模式的更多信息，请参考 [peripherals/uart/uart\\_echo](#)。

此外，置位 `uart_config_t::backup_before_sleep` 会使能在进入睡眠模式前备份 UART 配置寄存器并在退出睡眠后恢复这些寄存器。这个功能使 UART 能够在系统唤醒后继续正常工作，即使其电源域在睡眠过程中被完全关闭。此选项需要用户在功耗和内存使用之间取得平衡。如果功耗不是一个问题，可以禁用这个选项来节省内存。

**分步依次配置每个参数** 调用下表中的专用函数，能够单独配置特定参数。如需重新配置某个参数，也可使用这些函数。

表 4: 单独配置特定参数的函数

配置参数	函数
波特率	<code>uart_set_baudrate()</code>
传输位	调用 <code>uart_set_word_length()</code> 设置 <code>uart_word_length_t</code>
奇偶控制	调用 <code>uart_parity_t</code> 设置 <code>uart_set_parity()</code>
停止位	调用 <code>uart_set_stop_bits()</code> 设置 <code>uart_stop_bits_t</code>
硬件流控模式	调用 <code>uart_set_hw_flow_ctrl()</code> 设置 <code>uart_hw_flowcontrol_t</code>
通信模式	调用 <code>uart_set_mode()</code> 设置 <code>uart_mode_t</code>

表中每个函数都可使用 `_get_` 对应项来查看当前设置值。例如，查看当前波特率值，请调用 `uart_get_baudrate()`。

**设置通信管脚** 通信参数设置完成后，可以配置其他 UART 设备连接的 GPIO 管脚。调用函数 `uart_set_pin()`，指定配置 Tx、Rx、RTS 和 CTS 信号的 GPIO 管脚编号。如要为特定信号保留当前分配的管脚编号，可传递宏 `UART_PIN_NO_CHANGE`。

请为不使用的管脚都指定为宏 `UART_PIN_NO_CHANGE`。

```
// Set UART pins (TX: IO4, RX: IO5, RTS: IO18, CTS: IO19)
ESP_ERROR_CHECK(uart_set_pin(UART_NUM_1, 4, 5, 18, 19));
```

**安装驱动程序** 通信管脚设置完成后，请调用 `uart_driver_install()` 安装驱动程序并指定以下参数：

- UART 控制器编号
- Tx 环形缓冲区的大小
- Rx 环形缓冲区的大小
- 指向事件队列句柄的指针
- 事件队列大小
- 分配中断的标志

该函数将为 UART 驱动程序分配所需的内部资源。

```
// Setup UART buffered IO with event queue
const int uart_buffer_size = (1024 * 2);
QueueHandle_t uart_queue;
// Install UART driver using an event queue here
ESP_ERROR_CHECK(uart_driver_install(UART_NUM_1, uart_buffer_size, \
                                   uart_buffer_size, 10, &uart_queue, 0));
```

此步骤完成后，可连接外部 UART 设备检查通信。

**运行 UART 通信** 串行通信由每个 UART 控制器的有限状态机 (FSM) 控制。

发送数据的过程分为以下步骤：

1. 将数据写入 Tx FIFO 缓冲区
2. FSM 序列化数据
3. FSM 发送数据

接收数据的过程类似，只是步骤相反：

1. FSM 处理且并行化传入的串行流
2. FSM 将数据写入 Rx FIFO 缓冲区
3. 从 Rx FIFO 缓冲区读取数据

因此，应用程序仅会通过 `uart_write_bytes()` 和 `uart_read_bytes()` 从特定缓冲区写入或读取数据，其余工作由 FSM 完成。

**发送数据** 发送数据准备好后，调用函数 `uart_write_bytes()`，并向其传递数据缓冲区的地址和数据长度。该函数会立即或在有足够可用空间时将数据复制到 Tx 环形缓冲区，随后退出。当 Tx FIFO 缓冲区中有可用空间时，中断服务例程 (ISR) 会在后台将数据从 Tx 环形缓冲区移动到 Tx FIFO 缓冲区。调用函数请参考以下代码。

```
// Write data to UART.
char* test_str = "This is a test string.\n";
uart_write_bytes(uart_num, (const char*)test_str, strlen(test_str));
```

函数 `uart_write_bytes_with_break()` 与 `uart_write_bytes()` 类似，但在传输结束时会添加串行中断信号。“串行中断信号”意味着 Tx 线保持低电平的时间长于一个数据帧。

```
// Write data to UART, end with a break signal.
uart_write_bytes_with_break(uart_num, "test break\n", strlen("test break\n"), 100);
```

能够将数据写入 Tx FIFO 缓冲区的另一函数是 `uart_tx_chars()`。与 `uart_write_bytes()` 不同，此函数在没有可用空间之前不会阻塞。相反，它将写入所有可以立即放入硬件 Tx FIFO 的数据，然后返回写入的字节数。

“配套”函数 `uart_wait_tx_done()` 用于监听 Tx FIFO 缓冲区的状态，并在缓冲区为空时返回。

```
// Wait for packet to be sent
const uart_port_t uart_num = UART_NUM_1;
ESP_ERROR_CHECK(uart_wait_tx_done(uart_num, 100)); // wait timeout is 100 RTOS_
↳ticks (TickType_t)
```

**接收数据** 一旦 UART 接收了数据，并将其保存在 Rx FIFO 缓冲区中，就需要使用函数 `uart_read_bytes()` 检索数据。读取数据之前，调用 `uart_get_buffered_data_len()` 能够查看 Rx FIFO 缓冲区中可用的字节数。请参考以下示例。

```
// Read data from UART.
const uart_port_t uart_num = UART_NUM_1;
uint8_t data[128];
int length = 0;
ESP_ERROR_CHECK(uart_get_buffered_data_len(uart_num, (size_t*)&length));
length = uart_read_bytes(uart_num, data, length, 100);
```

如果不再需要 Rx FIFO 缓冲区中的数据，可以调用 `uart_flush()` 清空缓冲区。

**软件流控** 如果硬件流控处于禁用状态，可使用函数 `uart_set_rts()` 和 `uart_set_dtr()` 分别手动设置 RTS 和 DTR 信号电平。

**通信方式选择** UART 控制器支持多种通信模式，使用函数 `uart_set_mode()` 可以选择模式。选择特定模式后，UART 驱动程序将处理已连接 UART 设备的相应行为。例如，使用 RTS 线控制 RS485 驱动芯片，能够实现半双工 RS485 通信。

```
// Setup UART in rs485 half duplex mode
ESP_ERROR_CHECK(uart_set_mode(uart_num, UART_MODE_RS485_HALF_DUPLEX));
```

**使用中断** 根据特定的 UART 状态或检测到的错误，可以生成许多不同的中断。**ESP32-H2 技术参考手册 > UART 控制器 (UART) > UART 中断和 UHCI 中断 [PDF]** 中提供了可用中断的完整列表。调用 `uart_enable_intr_mask()` 或 `uart_disable_intr_mask()` 能够分别启用或禁用特定中断。

UART 驱动提供了一种便利的方法来处理特定的中断，即将中断包装成相应的事件。这些事件定义在 `uart_event_type_t` 中，FreeRTOS 队列功能可将这些事件报告给用户应用程序。

要接收已发生的事件，请调用 `uart_driver_install()` 函数并获取返回的事件队列句柄，可参考上述示例代码。



UART 驱动可处理的事件包括：

- **FIFO 空间溢出** (*UART\_FIFO\_OVF*)：当接收到的数据超过 FIFO 的存储能力时，Rx FIFO 会触发中断。
  - (可选) 配置 FIFO 阈值：在结构体 *uart\_intr\_config\_t* 中输入阈值，然后调用 *uart\_intr\_config()* 使能配置。这有助于驱动及时处理 RX FIFO 中的数据，避免 FIFO 溢出。
  - 启用中断：调用函数 *uart\_enable\_rx\_intr()*
  - 禁用中断：调用函数 *uart\_disable\_rx\_intr()*

```
const uart_port_t uart_num = UART_NUM_1;
// Configure a UART interrupt threshold and timeout
uart_intr_config_t uart_intr = {
    .intr_enable_mask = UART_INTR_RXFIFO_FULL | UART_INTR_RXFIFO_TOUT,
    .rxfifo_full_thresh = 100,
    .rx_timeout_thresh = 10,
};
ESP_ERROR_CHECK(uart_intr_config(uart_num, &uart_intr));

// Enable UART RX FIFO full threshold and timeout interrupts
ESP_ERROR_CHECK(uart_enable_rx_intr(uart_num));
```

- **模式检测** (*UART\_PATTERN\_DET*)：在检测到重复接收/发送同一字符的“模式”时触发中断，例如，模式检测可用于检测命令字符串末尾是否存在特定数量的相同字符（“模式”）。可以调用以下函数：
  - 配置并启用此中断：调用 *uart\_enable\_pattern\_det\_baud\_intr()*
  - 禁用中断：调用 *uart\_disable\_pattern\_det\_intr()*

```
//Set UART pattern detect function
uart_enable_pattern_det_baud_intr(EX_UART_NUM, '+', PATTERN_CHR_NUM, 9, 0, 0);
```

- **其他事件**：UART 驱动可处理的其他事件包括数据接收 (*UART\_DATA*)、环形缓冲区已满 (*UART\_BUFFER\_FULL*)、在停止位后检测到 NULL (*UART\_BREAK*)、奇偶校验错误 (*UART\_PARITY\_ERR*)、以及帧错误 (*UART\_FRAME\_ERR*)。

括号中的字符串为相应的事件名称。请参考 [peripherals/uart/uart\\_events](#) 中处理 UART 事件的示例。

**删除驱动程序** 如不再需要与 *uart\_driver\_install()* 建立通信，则可调用 *uart\_driver\_delete()* 删除驱动程序，释放已分配的资源。

**宏指令** API 还定义了一些宏指令。例如，*UART\_HW\_FIFO\_LEN* 定义了硬件 FIFO 缓冲区的长度，*UART\_BITRATE\_MAX* 定义了 UART 控制器支持的最大波特率。

## RS485 特定通信模式简介

**备注：**下文将使用 `[UART_REGISTER_NAME].[UART_FIELD_BIT]` 指代 UART 寄存器字段/位。了解特定模式位的更多信息，请参考 [ESP32-H2 技术参考手册 > UART 控制器 \(UART\) > 寄存器摘要 \[PDF\]](#)。请搜索寄存器名称导航至寄存器描述，找到相应字段/位。

- `UART_RS485_CONF_REG.UART_RS485_EN`：设置此位将启用 RS485 通信模式支持。
- `UART_RS485_CONF_REG.UART_RS485TX_RX_EN`：设置此位，发送器的输出信号将环回到接收器的输入信号。
- `UART_RS485_CONF_REG.UART_RS485RXBY_TX_EN`：设置此位，如果接收器繁忙，发送器仍将发送数据（由硬件自动解决冲突）。

ESP32-H2 的 RS485 UART 硬件能够检测数据报传输期间的信号冲突，并在启用此中断时生成中断 `UART_RS485_CLASH_INT`。术语冲突表示发送的数据报与另一端接收到的数据报不同。数据冲突通常与总线上其他活跃设备的存在有关，或者是由于总线错误而出现。



冲突检测功能允许在激活和触发中断时处理冲突。中断 `UART_RS485_FRM_ERR_INT` 和 `UART_RS485_PARITY_ERR_INT` 可与冲突检测功能一起使用，在 RS485 模式下分别控制帧错误和奇偶校验位错误。UART 驱动程序支持此功能，通过选择 `UART_MODE_RS485_APP_CTRL` 模式可以使用（参考函数 `uart_set_mode()`）。

冲突检测功能可与电路 A 和电路 C 一起使用（参考章节[接口连接选项](#)）。在使用电路 A 或 B 时，连接到总线驱动 DE 管脚的 RTS 管脚应由用户应用程序控制。调用函数 `uart_get_collision_flag()` 能够查看是否触发冲突检测标志。

ESP32-H2 UART 控制器本身不支持半双工通信，因其无法自动控制连接到 RS485 总线驱动 RE/DE 输入的 RTS 管脚。然而，半双工通信能够通过 UART 驱动程序对 RTS 管脚的软件控制来实现，调用 `uart_set_mode()` 并选择 `UART_MODE_RS485_HALF_DUPLEX` 模式能够启用这一功能。

主机开始向 Tx FIFO 缓冲区写入数据时，UART 驱动程序会自动置位 RTS 管脚（逻辑 1）；最后一位数据传输完成后，驱动程序就会取消置位 RTS 管脚（逻辑 0）。要使用此模式，软件必须禁用硬件流控功能。此模式适用于下文所有已用电路。

**接口连接选项** 本节提供了示例原理图来介绍 ESP32-H2 RS485 接口连接的基本内容。

#### 备注:

- 下列原理图不一定包含所有必要元素。
- 模拟设备 ADM483 和 ADM2483 是 RS485 收发器的常见示例，也可使用其他类似的收发器。

#### 电路 A：冲突检测电路

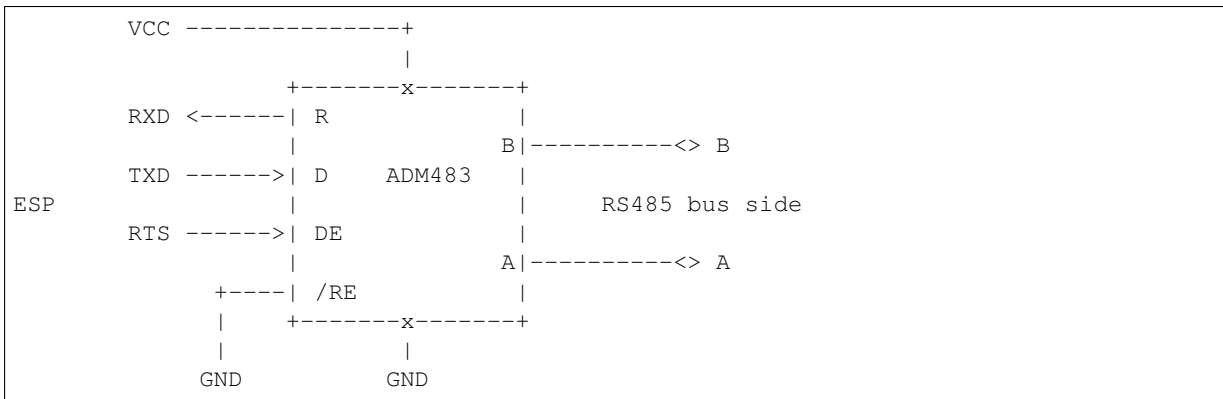

推荐这一电路，因为该电路较为简单，同时能够检测冲突。持续启用线路驱动中的接收器时，UART 将会监控 RS485 总线。启用 `UART_RS485_CONF_REG.UART_RS485TX_RX_EN` 位时，UART 外设会执行回波抑制。

#### 电路 B：无冲突检测的手动切换发射器/接收器

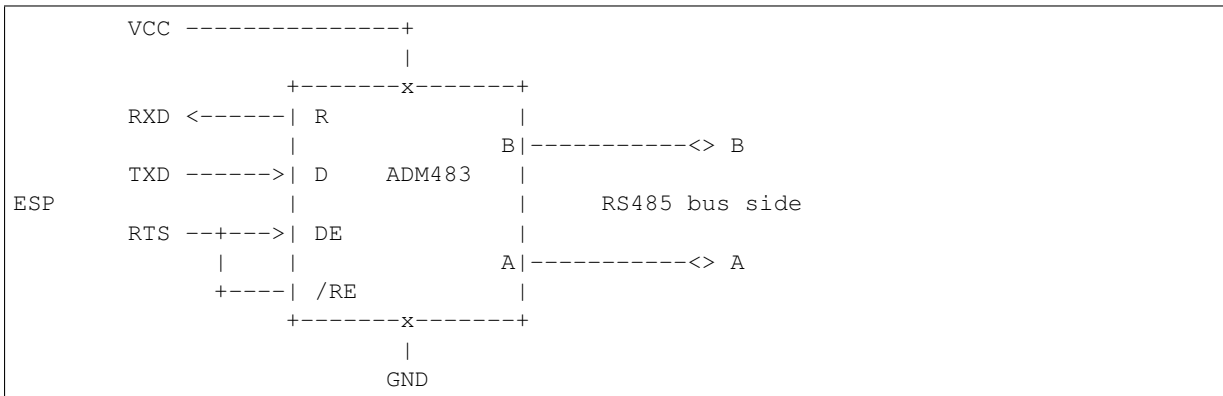

该电路无法检测冲突。置位 `UART_RS485_CONF_REG.UART_RS485TX_RX_EN` 位时，电路将抑制硬件收到的空字节。这种情况下 `UART_RS485_CONF_REG.UART_RS485RXBY_TX_EN` 位不适用。

### 电路 C：自动切换发射器/接收器

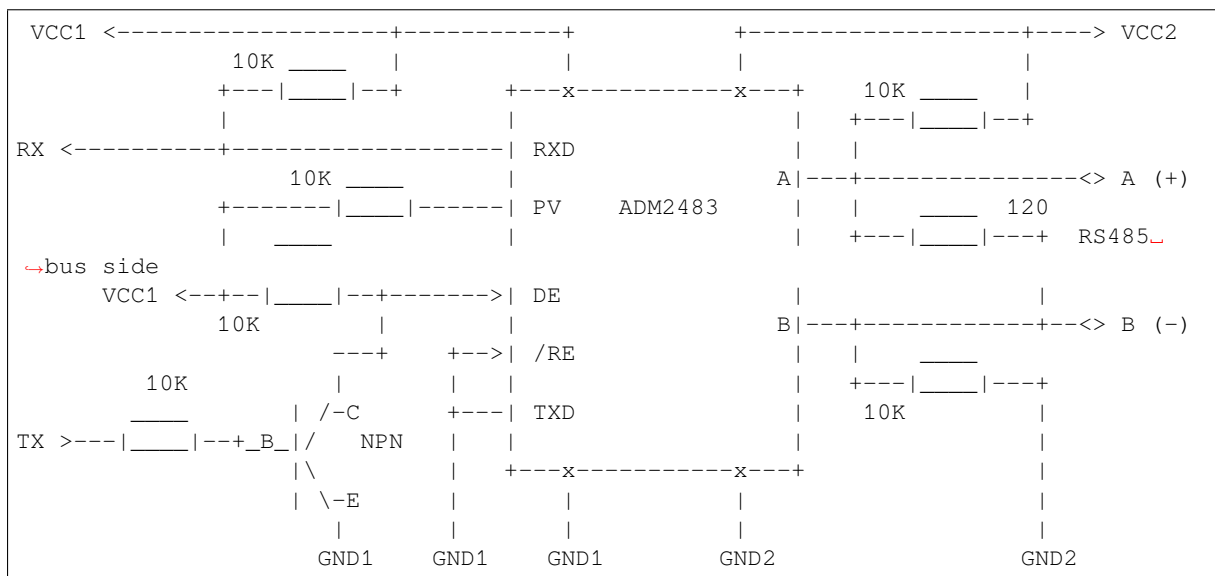

这种电气隔离电路不需要用软件应用程序或驱动程序控制 RTS 管脚，因为电路能够自动控制收发器方向。但是在传输过程中，需要将 `UART_RS485_CONF_REG.UART_RS485RXBY_TX_EN` 设置为 1 并将 `UART_RS485_CONF_REG.UART_RS485TX_RX_EN` 设置为 0 来抑制空字节。此设置可以在任何 RS485 UART 模式下工作，包括 `UART_MODE_UART`。

### 应用示例

下表列出了目录 `peripherals/uart/` 下可用的代码示例。

代码示例	描述
<a href="#">peripherals/uart/uart_echo</a>	配置 UART 设置、安装 UART 驱动程序以及通过 UART1 接口读取/写入。
<a href="#">peripherals/uart/uart_events</a>	报告各种通信事件，使用模式检测中断。
<a href="#">peripherals/uart/uart_async_rxtxtasks</a>	通过同一 UART 在两个独立的 FreeRTOS 任务中发送和接收数据。
<a href="#">peripherals/uart/uart_select</a>	针对 UART 文件描述符使用同步 I/O 多路复用。
<a href="#">peripherals/uart/uart_echo_rs485</a>	设置 UART 驱动程序以半双工模式通过 RS485 接口进行通信。此示例与 <a href="#">peripherals/uart/uart_echo</a> 类似，但允许通过连接到 ESP32-H2 管脚的 RS485 接口芯片进行通信。
<a href="#">peripherals/uart/nmea0183_parser</a>	解析通过 UART 外设从 GPS 收到的 NMEA0183 语句来获取 GPS 信息。

### API 参考

#### Header File

- [components/esp\\_driver\\_uart/include/driver/uart.h](#)
- This header file can be included with:

```
#include "driver/uart.h"
```

- This header file is a part of the API provided by the `esp_driver_uart` component. To declare that your component depends on `esp_driver_uart`, add the following to your `CMakeLists.txt`:

```
REQUIRES esp_driver_uart
```

or

```
PRIV_REQUIRES esp_driver_uart
```

## Functions

*esp\_err\_t* **uart\_driver\_install** (*uart\_port\_t* uart\_num, int rx\_buffer\_size, int tx\_buffer\_size, int queue\_size, *QueueHandle\_t* \*uart\_queue, int intr\_alloc\_flags)

Install UART driver and set the UART to the default configuration.

UART ISR handler will be attached to the same CPU core that this function is running on.

---

**备注:** Rx\_buffer\_size should be greater than UART\_HW\_FIFO\_LEN(uart\_num). Tx\_buffer\_size should be either zero or greater than UART\_HW\_FIFO\_LEN(uart\_num).

---

### 参数

- **uart\_num** -- UART port number, the max port number is (UART\_NUM\_MAX -1).
- **rx\_buffer\_size** -- UART RX ring buffer size.
- **tx\_buffer\_size** -- UART TX ring buffer size. If set to zero, driver will not use TX buffer, TX function will block task until all data have been sent out.
- **queue\_size** -- UART event queue size/depth.
- **uart\_queue** -- UART event queue handle (out param). On success, a new queue handle is written here to provide access to UART events. If set to NULL, driver will not use an event queue.
- **intr\_alloc\_flags** -- Flags used to allocate the interrupt. One or multiple (ORred) ESP\_INTR\_FLAG\_\* values. See esp\_intr\_alloc.h for more info. Do not set ESP\_INTR\_FLAG\_IRAM here (the driver's ISR handler is not located in IRAM)

### 返回

- ESP\_OK Success
- ESP\_FAIL Parameter error

*esp\_err\_t* **uart\_driver\_delete** (*uart\_port\_t* uart\_num)

Uninstall UART driver.

**参数** **uart\_num** -- UART port number, the max port number is (UART\_NUM\_MAX -1).

### 返回

- ESP\_OK Success
- ESP\_FAIL Parameter error

bool **uart\_is\_driver\_installed** (*uart\_port\_t* uart\_num)

Checks whether the driver is installed or not.

**参数** **uart\_num** -- UART port number, the max port number is (UART\_NUM\_MAX -1).

### 返回

- true driver is installed
- false driver is not installed

*esp\_err\_t* **uart\_set\_word\_length** (*uart\_port\_t* uart\_num, *uart\_word\_length\_t* data\_bit)

Set UART data bits.

### 参数

- **uart\_num** -- UART port number, the max port number is (UART\_NUM\_MAX -1).
- **data\_bit** -- UART data bits

### 返回

- ESP\_OK Success
- ESP\_FAIL Parameter error

*esp\_err\_t* **uart\_get\_word\_length** (*uart\_port\_t* uart\_num, *uart\_word\_length\_t* \*data\_bit)

Get the UART data bit configuration.

**参数**

- **uart\_num** -- UART port number, the max port number is (UART\_NUM\_MAX -1).
- **data\_bit** -- Pointer to accept value of UART data bits.

**返回**

- ESP\_FAIL Parameter error
- ESP\_OK Success, result will be put in (\*data\_bit)

*esp\_err\_t* **uart\_set\_stop\_bits** (*uart\_port\_t* uart\_num, *uart\_stop\_bits\_t* stop\_bits)

Set UART stop bits.

**参数**

- **uart\_num** -- UART port number, the max port number is (UART\_NUM\_MAX -1).
- **stop\_bits** -- UART stop bits

**返回**

- ESP\_OK Success
- ESP\_FAIL Fail

*esp\_err\_t* **uart\_get\_stop\_bits** (*uart\_port\_t* uart\_num, *uart\_stop\_bits\_t* \*stop\_bits)

Get the UART stop bit configuration.

**参数**

- **uart\_num** -- UART port number, the max port number is (UART\_NUM\_MAX -1).
- **stop\_bits** -- Pointer to accept value of UART stop bits.

**返回**

- ESP\_FAIL Parameter error
- ESP\_OK Success, result will be put in (\*stop\_bit)

*esp\_err\_t* **uart\_set\_parity** (*uart\_port\_t* uart\_num, *uart\_parity\_t* parity\_mode)

Set UART parity mode.

**参数**

- **uart\_num** -- UART port number, the max port number is (UART\_NUM\_MAX -1).
- **parity\_mode** -- the enum of uart parity configuration

**返回**

- ESP\_FAIL Parameter error
- ESP\_OK Success

*esp\_err\_t* **uart\_get\_parity** (*uart\_port\_t* uart\_num, *uart\_parity\_t* \*parity\_mode)

Get the UART parity mode configuration.

**参数**

- **uart\_num** -- UART port number, the max port number is (UART\_NUM\_MAX -1).
- **parity\_mode** -- Pointer to accept value of UART parity mode.

**返回**

- ESP\_FAIL Parameter error
- ESP\_OK Success, result will be put in (\*parity\_mode)

*esp\_err\_t* **uart\_get\_sclk\_freq** (*uart\_sclk\_t* sclk, uint32\_t \*out\_freq\_hz)

Get the frequency of a clock source for the HP UART port.

**参数**

- **sclk** -- Clock source
- **out\_freq\_hz** -- [out] Output of frequency, in Hz

**返回**

- ESP\_ERR\_INVALID\_ARG: if the clock source is not supported
- otherwise ESP\_OK

*esp\_err\_t* **uart\_set\_baudrate** (*uart\_port\_t* uart\_num, uint32\_t baudrate)

Set UART baud rate.

**参数**

- **uart\_num** -- UART port number, the max port number is (UART\_NUM\_MAX -1).
- **baudrate** -- UART baud rate.

**返回**

- ESP\_FAIL Parameter error
- ESP\_OK Success

*esp\_err\_t* **uart\_get\_baudrate** (*uart\_port\_t* uart\_num, uint32\_t \*baudrate)

Get the UART baud rate configuration.

**参数**

- **uart\_num** -- UART port number, the max port number is (UART\_NUM\_MAX -1).
- **baudrate** -- Pointer to accept value of UART baud rate

**返回**

- ESP\_FAIL Parameter error
- ESP\_OK Success, result will be put in (\*baudrate)

*esp\_err\_t* **uart\_set\_line\_inverse** (*uart\_port\_t* uart\_num, uint32\_t inverse\_mask)

Set UART line inverse mode.

**参数**

- **uart\_num** -- UART port number, the max port number is (UART\_NUM\_MAX -1).
- **inverse\_mask** -- Choose the wires that need to be inverted. Using the ORred mask of *uart\_signal\_inv\_t*

**返回**

- ESP\_OK Success
- ESP\_FAIL Parameter error

*esp\_err\_t* **uart\_set\_hw\_flow\_ctrl** (*uart\_port\_t* uart\_num, *uart\_hw\_flowcontrol\_t* flow\_ctrl, uint8\_t rx\_thresh)

Set hardware flow control.

**参数**

- **uart\_num** -- UART port number, the max port number is (UART\_NUM\_MAX -1).
- **flow\_ctrl** -- Hardware flow control mode
- **rx\_thresh** -- Threshold of Hardware RX flow control (0 ~ UART\_HW\_FIFO\_LEN(*uart\_num*)). Only when UART\_HW\_FLOWCTRL\_RTS is set, will the rx\_thresh value be set.

**返回**

- ESP\_OK Success
- ESP\_FAIL Parameter error

*esp\_err\_t* **uart\_set\_sw\_flow\_ctrl** (*uart\_port\_t* uart\_num, bool enable, uint8\_t rx\_thresh\_xon, uint8\_t rx\_thresh\_xoff)

Set software flow control.

**参数**

- **uart\_num** -- UART port number, the max port number is (UART\_NUM\_MAX -1)
- **enable** -- switch on or off
- **rx\_thresh\_xon** -- low water mark
- **rx\_thresh\_xoff** -- high water mark

**返回**

- ESP\_OK Success
- ESP\_FAIL Parameter error

*esp\_err\_t* **uart\_get\_hw\_flow\_ctrl** (*uart\_port\_t* uart\_num, *uart\_hw\_flowcontrol\_t* \*flow\_ctrl)

Get the UART hardware flow control configuration.

**参数**

- **uart\_num** -- UART port number, the max port number is (UART\_NUM\_MAX -1).
- **flow\_ctrl** -- Option for different flow control mode.

**返回**

- ESP\_FAIL Parameter error
- ESP\_OK Success, result will be put in (\*flow\_ctrl)

*esp\_err\_t* **uart\_clear\_intr\_status** (*uart\_port\_t* uart\_num, uint32\_t clr\_mask)

Clear UART interrupt status.

#### 参数

- **uart\_num** -- UART port number, the max port number is (UART\_NUM\_MAX -1).
- **clr\_mask** -- Bit mask of the interrupt status to be cleared.

#### 返回

- ESP\_OK Success
- ESP\_FAIL Parameter error

*esp\_err\_t* **uart\_enable\_intr\_mask** (*uart\_port\_t* uart\_num, uint32\_t enable\_mask)

Set UART interrupt enable.

#### 参数

- **uart\_num** -- UART port number, the max port number is (UART\_NUM\_MAX -1).
- **enable\_mask** -- Bit mask of the enable bits.

#### 返回

- ESP\_OK Success
- ESP\_FAIL Parameter error

*esp\_err\_t* **uart\_disable\_intr\_mask** (*uart\_port\_t* uart\_num, uint32\_t disable\_mask)

Clear UART interrupt enable bits.

#### 参数

- **uart\_num** -- UART port number, the max port number is (UART\_NUM\_MAX -1).
- **disable\_mask** -- Bit mask of the disable bits.

#### 返回

- ESP\_OK Success
- ESP\_FAIL Parameter error

*esp\_err\_t* **uart\_enable\_rx\_intr** (*uart\_port\_t* uart\_num)

Enable UART RX interrupt (RX\_FULL & RX\_TIMEOUT INTERRUPT)

**参数** **uart\_num** -- UART port number, the max port number is (UART\_NUM\_MAX -1).

#### 返回

- ESP\_OK Success
- ESP\_FAIL Parameter error

*esp\_err\_t* **uart\_disable\_rx\_intr** (*uart\_port\_t* uart\_num)

Disable UART RX interrupt (RX\_FULL & RX\_TIMEOUT INTERRUPT)

**参数** **uart\_num** -- UART port number, the max port number is (UART\_NUM\_MAX -1).

#### 返回

- ESP\_OK Success
- ESP\_FAIL Parameter error

*esp\_err\_t* **uart\_disable\_tx\_intr** (*uart\_port\_t* uart\_num)

Disable UART TX interrupt (TX\_FULL & TX\_TIMEOUT INTERRUPT)

**参数** **uart\_num** -- UART port number

#### 返回

- ESP\_OK Success
- ESP\_FAIL Parameter error

*esp\_err\_t* **uart\_enable\_tx\_intr** (*uart\_port\_t* uart\_num, int enable, int thresh)

Enable UART TX interrupt (TX\_FULL & TX\_TIMEOUT INTERRUPT)

#### 参数

- **uart\_num** -- UART port number, the max port number is (UART\_NUM\_MAX -1).
- **enable** -- 1: enable; 0: disable

- **thresh** -- Threshold of TX interrupt, 0 ~ UART\_HW\_FIFO\_LEN(uart\_num)

**返回**

- ESP\_OK Success
- ESP\_FAIL Parameter error

*esp\_err\_t* **uart\_set\_pin** (*uart\_port\_t* uart\_num, int tx\_io\_num, int rx\_io\_num, int rts\_io\_num, int cts\_io\_num)

Assign signals of a UART peripheral to GPIO pins.

---

**备注:** If the GPIO number configured for a UART signal matches one of the IOMUX signals for that GPIO, the signal will be connected directly via the IOMUX. Otherwise the GPIO and signal will be connected via the GPIO Matrix. For example, if on an ESP32 the call `uart_set_pin(0, 1, 3, -1, -1)` is performed, as GPIO1 is UART0's default TX pin and GPIO3 is UART0's default RX pin, both will be connected to respectively U0TXD and U0RXD through the IOMUX, totally bypassing the GPIO matrix. The check is performed on a per-pin basis. Thus, it is possible to have RX pin binded to a GPIO through the GPIO matrix, whereas TX is binded to its GPIO through the IOMUX.

---



---

**备注:** Internal signal can be output to multiple GPIO pads. Only one GPIO pad can connect with input signal.

---

**参数**

- **uart\_num** -- UART port number, the max port number is (UART\_NUM\_MAX -1).
- **tx\_io\_num** -- UART TX pin GPIO number.
- **rx\_io\_num** -- UART RX pin GPIO number.
- **rts\_io\_num** -- UART RTS pin GPIO number.
- **cts\_io\_num** -- UART CTS pin GPIO number.

**返回**

- ESP\_OK Success
- ESP\_FAIL Parameter error

*esp\_err\_t* **uart\_set\_rts** (*uart\_port\_t* uart\_num, int level)

Manually set the UART RTS pin level.

---

**备注:** UART must be configured with hardware flow control disabled.

---

**参数**

- **uart\_num** -- UART port number, the max port number is (UART\_NUM\_MAX -1).
- **level** -- 1: RTS output low (active); 0: RTS output high (block)

**返回**

- ESP\_OK Success
- ESP\_FAIL Parameter error

*esp\_err\_t* **uart\_set\_dtr** (*uart\_port\_t* uart\_num, int level)

Manually set the UART DTR pin level.

**参数**

- **uart\_num** -- UART port number, the max port number is (UART\_NUM\_MAX -1).
- **level** -- 1: DTR output low; 0: DTR output high

**返回**

- ESP\_OK Success
- ESP\_FAIL Parameter error

*esp\_err\_t* **uart\_set\_tx\_idle\_num** (*uart\_port\_t* uart\_num, uint16\_t idle\_num)

Set UART idle interval after tx FIFO is empty.

**参数**

- **uart\_num** -- UART port number, the max port number is (UART\_NUM\_MAX -1).
- **idle\_num** -- idle interval after tx FIFO is empty(unit: the time it takes to send one bit under current baudrate)

**返回**

- ESP\_OK Success
- ESP\_FAIL Parameter error

*esp\_err\_t* **uart\_param\_config** (*uart\_port\_t* uart\_num, const *uart\_config\_t* \*uart\_config)

Set UART configuration parameters.

**参数**

- **uart\_num** -- UART port number, the max port number is (UART\_NUM\_MAX -1).
- **uart\_config** -- UART parameter settings

**返回**

- ESP\_OK Success
- ESP\_FAIL Parameter error

*esp\_err\_t* **uart\_intr\_config** (*uart\_port\_t* uart\_num, const *uart\_intr\_config\_t* \*intr\_conf)

Configure UART interrupts.

**参数**

- **uart\_num** -- UART port number, the max port number is (UART\_NUM\_MAX -1).
- **intr\_conf** -- UART interrupt settings

**返回**

- ESP\_OK Success
- ESP\_FAIL Parameter error

*esp\_err\_t* **uart\_wait\_tx\_done** (*uart\_port\_t* uart\_num, TickType\_t ticks\_to\_wait)

Wait until UART TX FIFO is empty.

**参数**

- **uart\_num** -- UART port number, the max port number is (UART\_NUM\_MAX -1).
- **ticks\_to\_wait** -- Timeout, count in RTOS ticks

**返回**

- ESP\_OK Success
- ESP\_FAIL Parameter error
- ESP\_ERR\_TIMEOUT Timeout

int **uart\_tx\_chars** (*uart\_port\_t* uart\_num, const char \*buffer, uint32\_t len)

Send data to the UART port from a given buffer and length.

This function will not wait for enough space in TX FIFO. It will just fill the available TX FIFO and return when the FIFO is full.

---

**备注:** This function should only be used when UART TX buffer is not enabled.

---

**参数**

- **uart\_num** -- UART port number, the max port number is (UART\_NUM\_MAX -1).
- **buffer** -- data buffer address
- **len** -- data length to send

**返回**

- (-1) Parameter error
- OTHERS (>=0) The number of bytes pushed to the TX FIFO

int **uart\_write\_bytes** (*uart\_port\_t* uart\_num, const void \*src, size\_t size)

Send data to the UART port from a given buffer and length,.

If the UART driver's parameter 'tx\_buffer\_size' is set to zero: This function will not return until all the data have been sent out, or at least pushed into TX FIFO.



Otherwise, if the 'tx\_buffer\_size' > 0, this function will return after copying all the data to tx ring buffer, UART ISR will then move data from the ring buffer to TX FIFO gradually.

**参数**

- **uart\_num** -- UART port number, the max port number is (UART\_NUM\_MAX -1).
- **src** -- data buffer address
- **size** -- data length to send

**返回**

- (-1) Parameter error
- OTHERS (>=0) The number of bytes pushed to the TX FIFO

int **uart\_write\_bytes\_with\_break** (*uart\_port\_t* uart\_num, const void \*src, size\_t size, int brk\_len)

Send data to the UART port from a given buffer and length,.

If the UART driver's parameter 'tx\_buffer\_size' is set to zero: This function will not return until all the data and the break signal have been sent out. After all data is sent out, send a break signal.

Otherwise, if the 'tx\_buffer\_size' > 0, this function will return after copying all the data to tx ring buffer, UART ISR will then move data from the ring buffer to TX FIFO gradually. After all data sent out, send a break signal.

**参数**

- **uart\_num** -- UART port number, the max port number is (UART\_NUM\_MAX -1).
- **src** -- data buffer address
- **size** -- data length to send
- **brk\_len** -- break signal duration(unit: the time it takes to send one bit at current baudrate)

**返回**

- (-1) Parameter error
- OTHERS (>=0) The number of bytes pushed to the TX FIFO

int **uart\_read\_bytes** (*uart\_port\_t* uart\_num, void \*buf, uint32\_t length, TickType\_t ticks\_to\_wait)

UART read bytes from UART buffer.

**参数**

- **uart\_num** -- UART port number, the max port number is (UART\_NUM\_MAX -1).
- **buf** -- pointer to the buffer.
- **length** -- data length
- **ticks\_to\_wait** -- sTimeout, count in RTOS ticks

**返回**

- (-1) Error
- OTHERS (>=0) The number of bytes read from UART buffer

*esp\_err\_t* **uart\_flush** (*uart\_port\_t* uart\_num)

Alias of `uart_flush_input`. UART ring buffer flush. This will discard all data in the UART RX buffer.

---

**备注:** Instead of waiting the data sent out, this function will clear UART rx buffer. In order to send all the data in tx FIFO, we can use `uart_wait_tx_done` function.

---

**参数** **uart\_num** -- UART port number, the max port number is (UART\_NUM\_MAX -1).

**返回**

- ESP\_OK Success
- ESP\_FAIL Parameter error

*esp\_err\_t* **uart\_flush\_input** (*uart\_port\_t* uart\_num)

Clear input buffer, discard all the data is in the ring-buffer.

---

**备注:** In order to send all the data in tx FIFO, we can use `uart_wait_tx_done` function.

---

参数 **uart\_num** -- UART port number, the max port number is (UART\_NUM\_MAX -1).

返回

- ESP\_OK Success
- ESP\_FAIL Parameter error

*esp\_err\_t* **uart\_get\_buffered\_data\_len** (*uart\_port\_t* uart\_num, size\_t \*size)

UART get RX ring buffer cached data length.

参数

- **uart\_num** -- UART port number, the max port number is (UART\_NUM\_MAX -1).
- **size** -- Pointer of size\_t to accept cached data length

返回

- ESP\_OK Success
- ESP\_FAIL Parameter error

*esp\_err\_t* **uart\_get\_tx\_buffer\_free\_size** (*uart\_port\_t* uart\_num, size\_t \*size)

UART get TX ring buffer free space size.

参数

- **uart\_num** -- UART port number, the max port number is (UART\_NUM\_MAX -1).
- **size** -- Pointer of size\_t to accept the free space size

返回

- ESP\_OK Success
- ESP\_ERR\_INVALID\_ARG Parameter error

*esp\_err\_t* **uart\_disable\_pattern\_det\_intr** (*uart\_port\_t* uart\_num)

UART disable pattern detect function. Designed for applications like 'AT commands'. When the hardware detects a series of one same character, the interrupt will be triggered.

参数 **uart\_num** -- UART port number, the max port number is (UART\_NUM\_MAX -1).

返回

- ESP\_OK Success
- ESP\_FAIL Parameter error

*esp\_err\_t* **uart\_enable\_pattern\_det\_baud\_intr** (*uart\_port\_t* uart\_num, char pattern\_chr, uint8\_t chr\_num, int chr\_tout, int post\_idle, int pre\_idle)

UART enable pattern detect function. Designed for applications like 'AT commands'. When the hardware detect a series of one same character, the interrupt will be triggered.

参数

- **uart\_num** -- UART port number.
- **pattern\_chr** -- character of the pattern.
- **chr\_num** -- number of the character, 8bit value.
- **chr\_tout** -- timeout of the interval between each pattern characters, 16bit value, unit is the baud-rate cycle you configured. When the duration is more than this value, it will not take this data as at\_cmd char.
- **post\_idle** -- idle time after the last pattern character, 16bit value, unit is the baud-rate cycle you configured. When the duration is less than this value, it will not take the previous data as the last at\_cmd char
- **pre\_idle** -- idle time before the first pattern character, 16bit value, unit is the baud-rate cycle you configured. When the duration is less than this value, it will not take this data as the first at\_cmd char.

返回

- ESP\_OK Success
- ESP\_FAIL Parameter error

int **uart\_pattern\_pop\_pos** (*uart\_port\_t* uart\_num)

Return the nearest detected pattern position in buffer. The positions of the detected pattern are saved in a queue, this function will dequeue the first pattern position and move the pointer to next pattern position.

The following APIs will modify the pattern position info: `uart_flush_input`, `uart_read_bytes`, `uart_driver_delete`, `uart_pop_pattern_pos`. It is the application's responsibility to ensure atomic access to the pattern queue and the rx data buffer when using pattern detect feature.

---

**备注:** If the RX buffer is full and flow control is not enabled, the detected pattern may not be found in the rx buffer due to overflow.

---

**参数** `uart_num` -- UART port number, the max port number is (UART\_NUM\_MAX -1).

**返回**

- (-1) No pattern found for current index or parameter error
- others the pattern position in rx buffer.

`int uart_pattern_get_pos (uart_port_t uart_num)`

Return the nearest detected pattern position in buffer. The positions of the detected pattern are saved in a queue, This function do nothing to the queue.

The following APIs will modify the pattern position info: `uart_flush_input`, `uart_read_bytes`, `uart_driver_delete`, `uart_pop_pattern_pos`. It is the application's responsibility to ensure atomic access to the pattern queue and the rx data buffer when using pattern detect feature.

---

**备注:** If the RX buffer is full and flow control is not enabled, the detected pattern may not be found in the rx buffer due to overflow.

---

**参数** `uart_num` -- UART port number, the max port number is (UART\_NUM\_MAX -1).

**返回**

- (-1) No pattern found for current index or parameter error
- others the pattern position in rx buffer.

`esp_err_t uart_pattern_queue_reset (uart_port_t uart_num, int queue_length)`

Allocate a new memory with the given length to save record the detected pattern position in rx buffer.

**参数**

- **uart\_num** -- UART port number, the max port number is (UART\_NUM\_MAX -1).
- **queue\_length** -- Max queue length for the detected pattern. If the queue length is not large enough, some pattern positions might be lost. Set this value to the maximum number of patterns that could be saved in data buffer at the same time.

**返回**

- ESP\_ERR\_NO\_MEM No enough memory
- ESP\_ERR\_INVALID\_STATE Driver not installed
- ESP\_FAIL Parameter error
- ESP\_OK Success

`esp_err_t uart_set_mode (uart_port_t uart_num, uart_mode_t mode)`

UART set communication mode.

---

**备注:** This function must be executed after `uart_driver_install()`, when the driver object is initialized.

---

**参数**

- **uart\_num** -- Uart number to configure, the max port number is (UART\_NUM\_MAX -1).
- **mode** -- UART mode to set

**返回**

- ESP\_OK Success

- ESP\_ERR\_INVALID\_ARG Parameter error

*esp\_err\_t* **uart\_set\_rx\_full\_threshold** (*uart\_port\_t* uart\_num, int threshold)

Set uart threshold value for RX fifo full.

---

**备注:** If application is using higher baudrate and it is observed that bytes in hardware RX fifo are overwritten then this threshold can be reduced

---

#### 参数

- **uart\_num** -- UART port number, the max port number is (UART\_NUM\_MAX -1)
- **threshold** -- Threshold value above which RX fifo full interrupt is generated

#### 返回

- ESP\_OK Success
- ESP\_ERR\_INVALID\_ARG Parameter error
- ESP\_ERR\_INVALID\_STATE Driver is not installed

*esp\_err\_t* **uart\_set\_tx\_empty\_threshold** (*uart\_port\_t* uart\_num, int threshold)

Set uart threshold values for TX fifo empty.

#### 参数

- **uart\_num** -- UART port number, the max port number is (UART\_NUM\_MAX -1)
- **threshold** -- Threshold value below which TX fifo empty interrupt is generated

#### 返回

- ESP\_OK Success
- ESP\_ERR\_INVALID\_ARG Parameter error
- ESP\_ERR\_INVALID\_STATE Driver is not installed

*esp\_err\_t* **uart\_set\_rx\_timeout** (*uart\_port\_t* uart\_num, const uint8\_t tout\_thresh)

UART set threshold timeout for TOUT feature.

#### 参数

- **uart\_num** -- Uart number to configure, the max port number is (UART\_NUM\_MAX -1).
- **tout\_thresh** -- This parameter defines timeout threshold in uart symbol periods. The maximum value of threshold is 126. tout\_thresh = 1, defines TOUT interrupt timeout equal to transmission time of one symbol (~11 bit) on current baudrate. If the time is expired the UART\_RXFIFO\_TOUT\_INT interrupt is triggered. If tout\_thresh == 0, the TOUT feature is disabled.

#### 返回

- ESP\_OK Success
- ESP\_ERR\_INVALID\_ARG Parameter error
- ESP\_ERR\_INVALID\_STATE Driver is not installed

*esp\_err\_t* **uart\_get\_collision\_flag** (*uart\_port\_t* uart\_num, bool \*collision\_flag)

Returns collision detection flag for RS485 mode Function returns the collision detection flag into variable pointed by collision\_flag. \*collision\_flag = true, if collision detected else it is equal to false. This function should be executed when actual transmission is completed (after uart\_write\_bytes()).

#### 参数

- **uart\_num** -- Uart number to configure the max port number is (UART\_NUM\_MAX -1).
- **collision\_flag** -- Pointer to variable of type bool to return collision flag.

#### 返回

- ESP\_OK Success
- ESP\_ERR\_INVALID\_ARG Parameter error

*esp\_err\_t* **uart\_set\_wakeup\_threshold** (*uart\_port\_t* uart\_num, int wakeup\_threshold)

Set the number of RX pin signal edges for light sleep wakeup.

UART can be used to wake up the system from light sleep. This feature works by counting the number of positive edges on RX pin and comparing the count to the threshold. When the count exceeds the threshold, system is woken up from light sleep. This function allows setting the threshold value.

Stop bit and parity bits (if enabled) also contribute to the number of edges. For example, letter 'a' with ASCII code 97 is encoded as 0100001101 on the wire (with 8n1 configuration), start and stop bits included. This sequence has 3 positive edges (transitions from 0 to 1). Therefore, to wake up the system when 'a' is sent, set `wakeup_threshold=3`.

The character that triggers wakeup is not received by UART (i.e. it can not be obtained from UART FIFO). Depending on the baud rate, a few characters after that will also not be received. Note that when the chip enters and exits light sleep mode, APB frequency will be changing. To ensure that UART has correct Baud rate all the time, it is necessary to select a source clock which has a fixed frequency and remains active during sleep. For the supported clock sources of the chips, please refer to `uart_sclk_t` or `soc_periph_uart_clk_src_legacy_t`

---

**备注:** in ESP32, the wakeup signal can only be input via IO\_MUX (i.e. GPIO3 should be configured as `function_1` to wake up UART0, GPIO9 should be configured as `function_5` to wake up UART1), UART2 does not support light sleep wakeup feature.

---

#### 参数

- **uart\_num** -- UART number, the max port number is (UART\_NUM\_MAX -1).
- **wakeup\_threshold** -- number of RX edges for light sleep wakeup, value is 3 .. 0x3ff.

#### 返回

- ESP\_OK on success
- ESP\_ERR\_INVALID\_ARG if `uart_num` is incorrect or `wakeup_threshold` is outside of [3, 0x3ff] range.

*esp\_err\_t* **uart\_get\_wakeup\_threshold** (*uart\_port\_t* uart\_num, int \*out\_wakeup\_threshold)

Get the number of RX pin signal edges for light sleep wakeup.

See description of `uart_set_wakeup_threshold` for the explanation of UART wakeup feature.

#### 参数

- **uart\_num** -- UART number, the max port number is (UART\_NUM\_MAX -1).
- **out\_wakeup\_threshold** -- [out] output, set to the current value of wakeup threshold for the given UART.

#### 返回

- ESP\_OK on success
- ESP\_ERR\_INVALID\_ARG if `out_wakeup_threshold` is NULL

*esp\_err\_t* **uart\_wait\_tx\_idle\_polling** (*uart\_port\_t* uart\_num)

Wait until UART tx memory empty and the last char send ok (polling mode).

•

#### 返回

- ESP\_OK on success
- ESP\_ERR\_INVALID\_ARG Parameter error
- ESP\_FAIL Driver not installed

**参数** `uart_num` -- UART number

*esp\_err\_t* **uart\_set\_loop\_back** (*uart\_port\_t* uart\_num, bool loop\_back\_en)

Configure TX signal loop back to RX module, just for the test usage.

•

**返回**

- ESP\_OK on success
- ESP\_ERR\_INVALID\_ARG Parameter error
- ESP\_FAIL Driver not installed

**参数**

- **uart\_num** -- UART number
- **loop\_back\_en** -- Set true to enable the loop back function, else set it false.

void **uart\_set\_always\_rx\_timeout** (*uart\_port\_t* uart\_num, bool always\_rx\_timeout\_en)

Configure behavior of UART RX timeout interrupt.

When always\_rx\_timeout is true, timeout interrupt is triggered even if FIFO is full. This function can cause extra timeout interrupts triggered only to send the timeout event. Call this function only if you want to ensure timeout interrupt will always happen after a byte stream.

**参数**

- **uart\_num** -- UART number
- **always\_rx\_timeout\_en** -- Set to false enable the default behavior of timeout interrupt, set it to true to always trigger timeout interrupt.

**Structures**

struct **uart\_config\_t**

UART configuration parameters for `uart_param_config` function.

**Public Members**

int **baud\_rate**

UART baud rate

*uart\_word\_length\_t* **data\_bits**

UART byte size

*uart\_parity\_t* **parity**

UART parity mode

*uart\_stop\_bits\_t* **stop\_bits**

UART stop bits

*uart\_hw\_flowcontrol\_t* **flow\_ctrl**

UART HW flow control mode (cts/rts)

uint8\_t **rx\_flow\_ctrl\_thresh**

UART HW RTS threshold

*uart\_sclk\_t* **source\_clk**

UART source clock selection

uint32\_t **backup\_before\_sleep**

If set, the driver will backup/restore the HP UART registers before entering/after exiting sleep mode. By this approach, the system can power off HP UART's power domain. This can save power, but at the expense of more RAM being consumed

struct *uart\_config\_t*::[anonymous] **flags**

Configuration flags

struct **uart\_intr\_config\_t**

UART interrupt configuration parameters for `uart_intr_config` function.

### Public Members

uint32\_t **intr\_enable\_mask**

UART interrupt enable mask, choose from `UART_XXXX_INT_ENA_M` under `UART_INT_ENA_REG(i)`, connect with bit-or operator

uint8\_t **rx\_timeout\_thresh**

UART timeout interrupt threshold (unit: time of sending one byte)

uint8\_t **txfifo\_empty\_intr\_thresh**

UART TX empty interrupt threshold.

uint8\_t **rxfifo\_full\_thresh**

UART RX full interrupt threshold.

struct **uart\_event\_t**

Event structure used in UART event queue.

### Public Members

*uart\_event\_type\_t* **type**

UART event type

size\_t **size**

UART data size for `UART_DATA` event

bool **timeout\_flag**

UART data read timeout flag for `UART_DATA` event (no new data received during configured RX TOUT) If the event is caused by FIFO-full interrupt, then there will be no event with the timeout flag before the next byte coming.

### Macros

**UART\_PIN\_NO\_CHANGE**

**UART\_FIFO\_LEN**

Length of the HP UART HW FIFO.

**UART\_HW\_FIFO\_LEN** (*uart\_num*)

Length of the UART HW FIFO.

**UART\_BITRATE\_MAX**

Maximum configurable bitrate.

## Type Definitions

```
typedef intr_handle_t uart_isr_handle_t
```

## Enumerations

```
enum uart_event_type_t  
    UART event types used in the ring buffer.
```

*Values:*

```
enumerator UART_DATA  
    UART data event
```

```
enumerator UART_BREAK  
    UART break event
```

```
enumerator UART_BUFFER_FULL  
    UART RX buffer full event
```

```
enumerator UART_FIFO_OVF  
    UART FIFO overflow event
```

```
enumerator UART_FRAME_ERR  
    UART RX frame error event
```

```
enumerator UART_PARITY_ERR  
    UART RX parity event
```

```
enumerator UART_DATA_BREAK  
    UART TX data and break event
```

```
enumerator UART_PATTERN_DET  
    UART pattern detected
```

```
enumerator UART_WAKEUP  
    UART wakeup event
```

```
enumerator UART_EVENT_MAX  
    UART event max index
```

## Header File

- [components/hal/include/hal/uart\\_types.h](#)
- This header file can be included with:

```
#include "hal/uart_types.h"
```

## Structures

```
struct uart_at_cmd_t  
    UART AT cmd char configuration parameters Note that this function may different on different chip. Please refer to the TRM at configuration.
```



### Public Members

uint8\_t **cmd\_char**

UART AT cmd char

uint8\_t **char\_num**

AT cmd char repeat number

uint32\_t **gap\_tout**

gap time(in baud-rate) between AT cmd char

uint32\_t **pre\_idle**

the idle time(in baud-rate) between the non AT char and first AT char

uint32\_t **post\_idle**

the idle time(in baud-rate) between the last AT char and the none AT char

struct **uart\_sw\_flowctrl\_t**

UART software flow control configuration parameters.

### Public Members

uint8\_t **xon\_char**

Xon flow control char

uint8\_t **xoff\_char**

Xoff flow control char

uint8\_t **xon\_thrd**

If the software flow control is enabled and the data amount in rxfifo is less than xon\_thrd, an xon\_char will be sent

uint8\_t **xoff\_thrd**

If the software flow control is enabled and the data amount in rxfifo is more than xoff\_thrd, an xoff\_char will be sent

### Type Definitions

typedef *soc\_periph\_uart\_clk\_src\_legacy\_t* **uart\_sclk\_t**

UART source clock.

### Enumerations

enum **uart\_port\_t**

UART port number, can be UART\_NUM\_0 ~ (UART\_NUM\_MAX -1).

*Values:*

enumerator **UART\_NUM\_0**

UART port 0

enumerator **UART\_NUM\_1**

UART port 1

enumerator **UART\_NUM\_MAX**

UART port max

enum **uart\_mode\_t**

UART mode selection.

*Values:*

enumerator **UART\_MODE\_UART**

mode: regular UART mode

enumerator **UART\_MODE\_RS485\_HALF\_DUPLEX**

mode: half duplex RS485 UART mode control by RTS pin

enumerator **UART\_MODE\_IRDA**

mode: IRDA UART mode

enumerator **UART\_MODE\_RS485\_COLLISION\_DETECT**

mode: RS485 collision detection UART mode (used for test purposes)

enumerator **UART\_MODE\_RS485\_APP\_CTRL**

mode: application control RS485 UART mode (used for test purposes)

enum **uart\_word\_length\_t**

UART word length constants.

*Values:*

enumerator **UART\_DATA\_5\_BITS**

word length: 5bits

enumerator **UART\_DATA\_6\_BITS**

word length: 6bits

enumerator **UART\_DATA\_7\_BITS**

word length: 7bits

enumerator **UART\_DATA\_8\_BITS**

word length: 8bits

enumerator **UART\_DATA\_BITS\_MAX**

enum **uart\_stop\_bits\_t**

UART stop bits number.

*Values:*

enumerator **UART\_STOP\_BITS\_1**

stop bit: 1bit

enumerator **UART\_STOP\_BITS\_1\_5**

stop bit: 1.5bits

enumerator **UART\_STOP\_BITS\_2**

stop bit: 2bits

enumerator **UART\_STOP\_BITS\_MAX**

enum **uart\_parity\_t**

UART parity constants.

*Values:*

enumerator **UART\_PARITY\_DISABLE**

Disable UART parity

enumerator **UART\_PARITY\_EVEN**

Enable UART even parity

enumerator **UART\_PARITY\_ODD**

Enable UART odd parity

enum **uart\_hw\_flowcontrol\_t**

UART hardware flow control modes.

*Values:*

enumerator **UART\_HW\_FLOWCTRL\_DISABLE**

disable hardware flow control

enumerator **UART\_HW\_FLOWCTRL\_RTS**

enable RX hardware flow control (rts)

enumerator **UART\_HW\_FLOWCTRL\_CTS**

enable TX hardware flow control (cts)

enumerator **UART\_HW\_FLOWCTRL\_CTS\_RTS**

enable hardware flow control

enumerator **UART\_HW\_FLOWCTRL\_MAX**

enum **uart\_signal\_inv\_t**

UART signal bit map.

*Values:*

enumerator **UART\_SIGNAL\_INV\_DISABLE**

Disable UART signal inverse

enumerator **UART\_SIGNAL\_IRDA\_TX\_INV**

inverse the UART irda\_tx signal

enumerator **UART\_SIGNAL\_IRDA\_RX\_INV**

inverse the UART irda\_rx signal

enumerator **UART\_SIGNAL\_RXD\_INV**

inverse the UART rxd signal

enumerator **UART\_SIGNAL\_CTS\_INV**

inverse the UART cts signal

enumerator **UART\_SIGNAL\_DSR\_INV**

inverse the UART dsr signal

enumerator **UART\_SIGNAL\_TXD\_INV**

inverse the UART txd signal

enumerator **UART\_SIGNAL\_RTS\_INV**

inverse the UART rts signal

enumerator **UART\_SIGNAL\_DTR\_INV**

inverse the UART dtr signal

**GPIO 查找宏指令** UART 外设提供直接连接的专用 IO\_MUX 管脚，但也可用非直接的 GPIO 矩阵将信号配置到其他管脚。如要直接连接，需要知道哪一管脚为 UART 通道的专用 IO\_MUX 管脚。GPIO 查找宏简化了查找和分配 IO\_MUX 管脚的过程，可根据 IO\_MUX 管脚编号或所需 UART 通道名称选择一个宏，该宏将返回匹配的对项。请查看下列示例。

**备注：**如需较高的 UART 波特率（超过 40 MHz），即仅使用 IO\_MUX 管脚时，可以使用此类宏。在其他情况下可以忽略这些宏，并使用 GPIO 矩阵为 UART 功能配置任一 GPIO 管脚。

1. `UART_NUM_2_TXD_DIRECT_GPIO_NUM` 返回 UART 通道 2 TXD 管脚的 IO\_MUX 管脚编号（管脚 17）
2. `UART_GPIO19_DIRECT_CHANNEL` 在通过 IO\_MUX 连接到 UART 外设时返回 GPIO 19 的 UART 编号（即 `UART_NUM_0`）
3. GPIO 19 在通过 IO\_MUX 用作 UART CTS 管脚时，`UART_CTS_GPIO19_DIRECT_CHANNEL` 将返回 GPIO 19 的 UART 编号（即 `UART_NUM_0`）。该宏类似于上述宏，但指定了管脚功能，这也是 IO\_MUX 分配的一部分。

### Header File

- `components/soc/esp32h2/include/soc/uart_channel.h`
- This header file can be included with:

```
#include "soc/uart_channel.h"
```

### Macros

**UART\_GPIO24\_DIRECT\_CHANNEL**

```
UART_NUM_0_TXD_DIRECT_GPIO_NUM
```

```
UART_GPIO23_DIRECT_CHANNEL
```

```
UART_NUM_0_RXD_DIRECT_GPIO_NUM
```

```
UART_TXD_GPIO24_DIRECT_CHANNEL
```

```
UART_RXD_GPIO23_DIRECT_CHANNEL
```

本部分的 API 示例代码存放在 ESP-IDF 示例项目的 `peripherals` 目录下。

## 2.7 项目配置

### 2.7.1 简介

ESP-IDF 使用基于 `kconfiglib` 的 `esp-idf-kconfig` 包，而 `kconfiglib` 是 `Kconfig` 系统的 Python 扩展。`Kconfig` 提供了编译时的项目配置机制，以及多种类型的配置选项（如整数、字符串和布尔值等）。`Kconfig` 文件指定了选项之间的依赖关系、默认值、组合方式等。

了解所有可用功能，请查看 `Kconfig` 和 `kconfiglib` 扩展。

### 2.7.2 项目配置菜单

应用程序开发人员可以通过 `idf.py menuconfig` 构建目标，在终端中打开项目配置菜单。

更新后，此配置将保存在项目根目录的 `sdkconfig` 文件中。借助 `sdkconfig`，应用程序构建目标将在构建目录中生成 `sdkconfig.h` 文件，并使得 `sdkconfig` 选项可用于项目构建系统和源文件。

### 2.7.3 使用 `sdkconfig.defaults`

在某些情况下，例如 `sdkconfig` 文件处于版本控制状态时，构建系统可能会不便于更改 `sdkconfig` 文件。要避免上述情况，可以在构建系统中创建 `sdkconfig.defaults` 文件。该文件可以手动或自动创建，且构建系统永远不会对其进行更改。该文件包含所有不同于默认选项的重要选项，其格式与 `sdkconfig` 文件格式相同。如果用户记得所有已更改的配置，则可以手动创建 `sdkconfig.defaults`，或运行 `idf.py save-defconfig` 命令来自动生成此文件。

`sdkconfig.defaults` 创建后，用户可以删除 `sdkconfig` 或将其添加到版本控制系统的忽略列表中（例如 `git` 的 `.gitignore` 文件）。项目构建目标将自动创建 `sdkconfig` 文件，填充 `sdkconfig.defaults` 文件中的设置，并将其他设置配置为默认值。请注意，构建时 `sdkconfig.defaults` 中的设置不会覆盖 `sdkconfig` 的已有设置。了解更多信息，请查看 [自定义 `sdkconfig` 的默认值](#)。

### 2.7.4 `Kconfig` 格式规定

`Kconfig` 文件的格式规定如下：

- 在所有菜单中，选项名称的前缀需保持一致。目前，前缀长度应为至少 3 个字符。
- 每级采用 4 个空格的缩进方式，子项需比父项多缩进一级。例如，`menu` 缩进 0 个空格，`menu` 中的 `config` 则缩进 4 个空格，`config` 中的 `help` 缩进 8 个空格，`help` 下的文本缩进 12 个空格。
- 行末不得出现尾随空格。

- 选项最长为 50 个字符。
- 每行最长为 120 个字符。

**备注：** 菜单中不同配置的 help 小节默认视为 reStructuredText 格式，以便生成相应选项的参考文档。

## 格式检查器

esp-idf-kconfig 软件包中的 kconfcheck 工具可以检查 Kconfig 文件是否符合上述格式规定。检查器会检查作为参数给出的所有 Kconfig 和 Kconfig.projbuild 文件，并生成一个后缀为 .new 的新文件。如有格式错误，便会在此文件中提供修改建议。注意，检查器不能解决所有格式问题，开发人员仍需终审并修改文件，使其通过测试。例如，在没有其他误导性格式的情况下，检查器能够更正缩进，但无法为菜单内选项提供常用的前缀。

esp-idf-kconfig 软件包可以在 ESP-IDF 环境中使用。运行命令 `python -m kconfcheck <path_to_kconfig_file>` 即可调用检查工具。

如需了解更多内容，请参考 [esp-idf-kconfig 相关文档](#)。

## 2.7.5 Kconfig 选项的向后兼容性

标准 Kconfig 工具会忽略 sdkconfig 中的未知选项。因此，如果开发人员对某些选项进行了自定义设置，但这些选项在 ESP-IDF 新版本中重新命名，标准 Kconfig 工具将忽略原有设置。以下功能可以避免上述情况：

1. 工具链使用 kconfgen 预处理 sdkconfig 文件。例如，menuconfig 会读取这些文件，从而保留旧选项设置。
2. kconfgen 递归查找 ESP-IDF 目录中所有包含新旧 Kconfig 选项名称的 sdkconfig.rename 文件。在 sdkconfig 文件中，新选项将替换旧选项。针对单个目标的重命名可以放在特定目标的重命名文件 sdkconfig.rename.TARGET 中，其中 TARGET 是目标名称，例如 sdkconfig.rename.esp32s2。
3. kconfgen 通过添加兼容性语句列表（即经过修改后，将旧选项的值设置为新选项的值），后处理 sdkconfig 文件，并生成所有构建结果（sdkconfig.h、sdkconfig.cmake 以及 auto.conf）。如果用户在其代码中仍然使用旧选项，此举可以防止用户代码出现问题。
4. kconfgen 会自动生成 *Deprecated options and their replacements*。

## 2.7.6 配置选项参考

以下小节包含由 Kconfig 文件自动生成的 ESP-IDF 可用选项列表。请注意，由于所选选项不同，下列某些选项可能在 menuconfig 界面中默认不可见。

按照惯例，所有选项名称均为大写字母加下划线。当 Kconfig 生成 sdkconfig 和 sdkconfig.h 文件时，选项名称会以 CONFIG\_ 为前缀。因此，如果 Kconfig 文件定义了 ENABLE\_FOO 选项且 menuconfig 中选择了该选项，则 sdkconfig 和 sdkconfig.h 文件也将定义 CONFIG\_ENABLE\_FOO。在以下小节中，选项名称也以 CONFIG\_ 为前缀，与源代码相同。

### Build type

Contains:

- `CONFIG_APP_BUILD_TYPE`
- `CONFIG_APP_BUILD_TYPE_PURE_RAM_APP`
- `CONFIG_APP_REPRODUCIBLE_BUILD`
- `CONFIG_APP_NO_BLOBS`

## CONFIG\_APP\_BUILD\_TYPE

Application build type

Found in: *Build type*

Select the way the application is built.

By default, the application is built as a binary file in a format compatible with the ESP-IDF bootloader. In addition to this application, 2nd stage bootloader is also built. Application and bootloader binaries can be written into flash and loaded/executed from there.

Another option, useful for only very small and limited applications, is to only link the .elf file of the application, such that it can be loaded directly into RAM over JTAG or UART. Note that since IRAM and DRAM sizes are very limited, it is not possible to build any complex application this way. However for some kinds of testing and debugging, this option may provide faster iterations, since the application does not need to be written into flash.

Note: when APP\_BUILD\_TYPE\_RAM is selected and loaded with JTAG, ESP-IDF does not contain all the startup code required to initialize the CPUs and ROM memory (data/bss). Therefore it is necessary to execute a bit of ROM code prior to executing the application. A gdbinit file may look as follows (for ESP32):

```
# Connect to a running instance of OpenOCD target remote :3333 # Reset and halt the target
mon reset halt # Run to a specific point in ROM code, # where most of initialization is
complete. thb *0x40007d54 c # Load the application into RAM load # Run till app_main tb
app_main c
```

Execute this gdbinit file as follows:

```
xtensa-esp32-elf-gdb build/app-name.elf -x gdbinit
```

Example gdbinit files for other targets can be found in tools/test\_apps/system/gdb\_loadable\_elf/

When loading the BIN with UART, the ROM will jump to ram and run the app after finishing the ROM startup code, so there's no additional startup initialization required. You can use the *load\_ram* in esptool.py to load the generated .bin file into ram and execute.

**Example:** esptool.py --chip {chip} -p {port} -b {baud} --no-stub load\_ram {app.bin}

Recommended sdkconfig.defaults for building loadable ELF files is as follows. CONFIG\_APP\_BUILD\_TYPE\_RAM is required, other options help reduce application memory footprint.

```
CONFIG_APP_BUILD_TYPE_RAM=y CONFIG_VFS_SUPPORT_TERMIOS= CON-
FIG_NEWLIB_NANO_FORMAT=y CONFIG_ESP_SYSTEM_PANIC_PRINT_HALT=y
CONFIG_ESP_DEBUG_STUBS_ENABLE= CONFIG_ESP_ERR_TO_NAME_LOOKUP=
```

Available options:

- Default (binary application + 2nd stage bootloader) (CONFIG\_APP\_BUILD\_TYPE\_APP\_2NDBOOT)
- Build app runs entirely in RAM (EXPERIMENTAL) (CONFIG\_APP\_BUILD\_TYPE\_RAM)

## CONFIG\_APP\_BUILD\_TYPE\_PURE\_RAM\_APP

Build app without SPI\_FLASH/PSRAM support (saves ram)

Found in: *Build type*

If this option is enabled, external memory and related peripherals, such as Cache, MMU, Flash and PSRAM, won't be initialized. Corresponding drivers won't be introduced either. Components that depend on the spi\_flash component will also be unavailable, such as app\_update, etc. When this option is enabled, about 26KB of RAM space can be saved.

## CONFIG\_APP\_REPRODUCIBLE\_BUILD

Enable reproducible build

*Found in: Build type*

If enabled, all date, time, and path information would be eliminated. A .gdbinit file would be create automatically. (or will be append if you have one already)

**Default value:**

- No (disabled)

## CONFIG\_APP\_NO\_BLOBS

No Binary Blobs

*Found in: Build type*

If enabled, this disables the linking of binary libraries in the application build. Note that after enabling this Wi-Fi/Bluetooth will not work.

**Default value:**

- No (disabled)

## Bootloader config

Contains:

- *CONFIG\_BOOTLOADER\_LOG\_LEVEL*
- *Bootloader manager*
- *CONFIG\_BOOTLOADER\_COMPILER\_OPTIMIZATION*
- *CONFIG\_BOOTLOADER\_APP\_ROLLBACK\_ENABLE*
- *CONFIG\_BOOTLOADER\_REGION\_PROTECTION\_ENABLE*
- *CONFIG\_BOOTLOADER\_APP\_TEST*
- *CONFIG\_BOOTLOADER\_FACTORY\_RESET*
- *CONFIG\_BOOTLOADER\_HOLD\_TIME\_GPIO*
- *CONFIG\_BOOTLOADER\_CUSTOM\_RESERVE\_RTC*
- *Serial Flash Configurations*
- *CONFIG\_BOOTLOADER\_SKIP\_VALIDATE\_ALWAYS*
- *CONFIG\_BOOTLOADER\_SKIP\_VALIDATE\_ON\_POWER\_ON*
- *CONFIG\_BOOTLOADER\_SKIP\_VALIDATE\_IN\_DEEP\_SLEEP*
- *CONFIG\_BOOTLOADER\_WDT\_ENABLE*
- *CONFIG\_BOOTLOADER\_VDDSDIO\_BOOST*

**Bootloader manager** Contains:

- *CONFIG\_BOOTLOADER\_PROJECT\_VER*
- *CONFIG\_BOOTLOADER\_COMPILE\_TIME\_DATE*

## CONFIG\_BOOTLOADER\_COMPILE\_TIME\_DATE

Use time/date stamp for bootloader

*Found in: Bootloader config > Bootloader manager*

If set, then the bootloader will be built with the current time/date stamp. It is stored in the bootloader description structure. If not set, time/date stamp will be excluded from bootloader image. This can be useful for getting the same binary image files made from the same source, but at different times.



## CONFIG\_BOOTLOADER\_PROJECT\_VER

Project version

Found in: *Bootloader config* > *Bootloader manager*

Project version. It is placed in "version" field of the esp\_bootloader\_desc structure. The type of this field is "uint32\_t".

**Range:**

- from 0 to 4294967295

**Default value:**

- 1

## CONFIG\_BOOTLOADER\_COMPILER\_OPTIMIZATION

Bootloader optimization Level

Found in: *Bootloader config*

This option sets compiler optimization level (gcc -O argument) for the bootloader.

- The default "Size" setting will add the -Os flag to CFLAGS.
- The "Debug" setting will add the -Og flag to CFLAGS.
- The "Performance" setting will add the -O2 flag to CFLAGS.

Note that custom optimization levels may be unsupported.

Available options:

- Size (-Os) (CONFIG\_BOOTLOADER\_COMPILER\_OPTIMIZATION\_SIZE)
- Debug (-Og) (CONFIG\_BOOTLOADER\_COMPILER\_OPTIMIZATION\_DEBUG)
- Optimize for performance (-O2) (CONFIG\_BOOTLOADER\_COMPILER\_OPTIMIZATION\_PERF)
- Debug without optimization (-O0) (Deprecated, will be removed in IDF v6.0) (CONFIG\_BOOTLOADER\_COMPILER\_OPTIMIZATION\_NONE)

## CONFIG\_BOOTLOADER\_LOG\_LEVEL

Bootloader log verbosity

Found in: *Bootloader config*

Specify how much output to see in bootloader logs.

Available options:

- No output (CONFIG\_BOOTLOADER\_LOG\_LEVEL\_NONE)
- Error (CONFIG\_BOOTLOADER\_LOG\_LEVEL\_ERROR)
- Warning (CONFIG\_BOOTLOADER\_LOG\_LEVEL\_WARN)
- Info (CONFIG\_BOOTLOADER\_LOG\_LEVEL\_INFO)
- Debug (CONFIG\_BOOTLOADER\_LOG\_LEVEL\_DEBUG)
- Verbose (CONFIG\_BOOTLOADER\_LOG\_LEVEL\_VERBOSE)

**Serial Flash Configurations** Contains:

- *CONFIG\_BOOTLOADER\_FLASH\_DC\_AWARE*
- *CONFIG\_BOOTLOADER\_FLASH\_XMC\_SUPPORT*

### CONFIG\_BOOTLOADER\_FLASH\_DC\_AWARE

Allow app adjust Dummy Cycle bits in SPI Flash for higher frequency (READ HELP FIRST)

*Found in: [Bootloader config](#) > [Serial Flash Configurations](#)*

This will force 2nd bootloader to be loaded by DOUT mode, and will restore Dummy Cycle setting by resetting the Flash

### CONFIG\_BOOTLOADER\_FLASH\_XMC\_SUPPORT

Enable the support for flash chips of XMC (READ DOCS FIRST)

*Found in: [Bootloader config](#) > [Serial Flash Configurations](#)*

Perform the startup flow recommended by XMC. Please consult XMC for the details of this flow. XMC chips will be forbidden to be used, when this option is disabled.

DON'T DISABLE THIS UNLESS YOU KNOW WHAT YOU ARE DOING.

comment "Features below require specific hardware (READ DOCS FIRST!)"

**Default value:**

- Yes (enabled)

### CONFIG\_BOOTLOADER\_VDDSDIO\_BOOST

VDDSDIO LDO voltage

*Found in: [Bootloader config](#)*

If this option is enabled, and VDDSDIO LDO is set to 1.8V (using eFuse or MTDI bootstrapping pin), bootloader will change LDO settings to output 1.9V instead. This helps prevent flash chip from browning out during flash programming operations.

This option has no effect if VDDSDIO is set to 3.3V, or if the internal VDDSDIO regulator is disabled via eFuse.

Available options:

- 1.8V (CONFIG\_BOOTLOADER\_VDDSDIO\_BOOST\_1\_8V)
- 1.9V (CONFIG\_BOOTLOADER\_VDDSDIO\_BOOST\_1\_9V)

### CONFIG\_BOOTLOADER\_FACTORY\_RESET

GPIO triggers factory reset

*Found in: [Bootloader config](#)*

Allows to reset the device to factory settings: - clear one or more data partitions; - boot from "factory" partition. The factory reset will occur if there is a GPIO input held at the configured level while device starts up. See settings below.

**Default value:**

- No (disabled)

### CONFIG\_BOOTLOADER\_NUM\_PIN\_FACTORY\_RESET

Number of the GPIO input for factory reset

*Found in: [Bootloader config](#) > [CONFIG\\_BOOTLOADER\\_FACTORY\\_RESET](#)*

The selected GPIO will be configured as an input with internal pull-up enabled (note that on some SoCs, not all pins have an internal pull-up, consult the hardware datasheet for details.) To trigger a factory reset, this GPIO must be held high or low (as configured) on startup.

**Default value:**

- 4 if `CONFIG_BOOTLOADER_FACTORY_RESET`

**CONFIG\_BOOTLOADER\_FACTORY\_RESET\_PIN\_LEVEL**

Factory reset GPIO level

*Found in: [Bootloader config](#) > `CONFIG_BOOTLOADER_FACTORY_RESET`*

Pin level for factory reset, can be triggered on low or high.

Available options:

- Reset on GPIO low (`CONFIG_BOOTLOADER_FACTORY_RESET_PIN_LOW`)
- Reset on GPIO high (`CONFIG_BOOTLOADER_FACTORY_RESET_PIN_HIGH`)

**CONFIG\_BOOTLOADER\_OTA\_DATA\_ERASE**

Clear OTA data on factory reset (select factory partition)

*Found in: [Bootloader config](#) > `CONFIG_BOOTLOADER_FACTORY_RESET`*

The device will boot from "factory" partition (or OTA slot 0 if no factory partition is present) after a factory reset.

**CONFIG\_BOOTLOADER\_DATA\_FACTORY\_RESET**

Comma-separated names of partitions to clear on factory reset

*Found in: [Bootloader config](#) > `CONFIG_BOOTLOADER_FACTORY_RESET`*

Allows customers to select which data partitions will be erased while factory reset.

Specify the names of partitions as a comma-delimited with optional spaces for readability. (Like this: "nvs, phy\_init, ...") Make sure that the name specified in the partition table and here are the same. Partitions of type "app" cannot be specified here.

**Default value:**

- "nvs" if `CONFIG_BOOTLOADER_FACTORY_RESET`

**CONFIG\_BOOTLOADER\_APP\_TEST**

GPIO triggers boot from test app partition

*Found in: [Bootloader config](#)*

Allows to run the test app from "TEST" partition. A boot from "test" partition will occur if there is a GPIO input pulled low while device starts up. See settings below.

**CONFIG\_BOOTLOADER\_NUM\_PIN\_APP\_TEST**

Number of the GPIO input to boot TEST partition

*Found in: [Bootloader config](#) > `CONFIG_BOOTLOADER_APP_TEST`*

The selected GPIO will be configured as an input with internal pull-up enabled. To trigger a test app, this GPIO must be pulled low on reset. After the GPIO input is deactivated and the device reboots, the old application will boot. (factory or OTA[x]). Note that GPIO34-39 do not have an internal pullup and an external one must be provided.

**Range:**

- from 0 to 39 if `CONFIG_BOOTLOADER_APP_TEST`

**Default value:**

- 18 if `CONFIG_BOOTLOADER_APP_TEST`

### **CONFIG\_BOOTLOADER\_APP\_TEST\_PIN\_LEVEL**

App test GPIO level

*Found in:* `Bootloader config` > `CONFIG_BOOTLOADER_APP_TEST`

Pin level for app test, can be triggered on low or high.

Available options:

- Enter test app on GPIO low (`CONFIG_BOOTLOADER_APP_TEST_PIN_LOW`)
- Enter test app on GPIO high (`CONFIG_BOOTLOADER_APP_TEST_PIN_HIGH`)

### **CONFIG\_BOOTLOADER\_HOLD\_TIME\_GPIO**

Hold time of GPIO for reset/test mode (seconds)

*Found in:* `Bootloader config`

The GPIO must be held low continuously for this period of time after reset before a factory reset or test partition boot (as applicable) is performed.

**Default value:**

- 5 if `CONFIG_BOOTLOADER_FACTORY_RESET` || `CONFIG_BOOTLOADER_APP_TEST`

### **CONFIG\_BOOTLOADER\_REGION\_PROTECTION\_ENABLE**

Enable protection for unmapped memory regions

*Found in:* `Bootloader config`

Protects the unmapped memory regions of the entire address space from unintended accesses. This will ensure that an exception will be triggered whenever the CPU performs a memory operation on unmapped regions of the address space.

**Default value:**

- Yes (enabled)

### **CONFIG\_BOOTLOADER\_WDT\_ENABLE**

Use RTC watchdog in start code

*Found in:* `Bootloader config`

Tracks the execution time of startup code. If the execution time is exceeded, the `RTC_WDT` will restart system. It is also useful to prevent a lock up in start code caused by an unstable power source. **NOTE:** Tracks the execution time starts from the bootloader code - re-set timeout, while selecting the source for `slow_clk` - and ends calling `app_main`. Re-set timeout is needed due to WDT uses a `SLOW_CLK` clock source. After changing a frequency `slow_clk` a time of WDT needs to re-set for new frequency. `slow_clk` depends on `RTC_CLK_SRC` (`INTERNAL_RC` or `EXTERNAL_CRYSTAL`).

**Default value:**

- Yes (enabled)

### **CONFIG\_BOOTLOADER\_WDT\_DISABLE\_IN\_USER\_CODE**

Allows RTC watchdog disable in user code

*Found in:* `Bootloader config` > `CONFIG_BOOTLOADER_WDT_ENABLE`

If this option is set, the ESP-IDF app must explicitly reset, feed, or disable the `rtc_wdt` in the app's own code. If this option is not set (default), then `rtc_wdt` will be disabled by ESP-IDF before calling the `app_main()` function.

Use function `wdt_hal_feed()` for resetting counter of `RTC_WDT`. For esp32/s2 you can also use `rtc_wdt_feed()`.

Use function `wdt_hal_disable()` for disabling `RTC_WDT`. For esp32/s2 you can also use `rtc_wdt_disable()`.

**Default value:**

- No (disabled)

### CONFIG\_BOOTLOADER\_WDT\_TIME\_MS

Timeout for RTC watchdog (ms)

*Found in: [Bootloader config](#) > [CONFIG\\_BOOTLOADER\\_WDT\\_ENABLE](#)*

Verify that this parameter is correct and more then the execution time. Pay attention to options such as reset to factory, trigger test partition and encryption on boot - these options can increase the execution time. Note: `RTC_WDT` will reset while encryption operations will be performed.

**Range:**

- from 0 to 120000

**Default value:**

- 9000

### CONFIG\_BOOTLOADER\_APP\_ROLLBACK\_ENABLE

Enable app rollback support

*Found in: [Bootloader config](#)*

After updating the app, the bootloader runs a new app with the "ESP\_OTA\_IMG\_PENDING\_VERIFY" state set. This state prevents the re-run of this app. After the first boot of the new app in the user code, the function should be called to confirm the operability of the app or vice versa about its non-operability. If the app is working, then it is marked as valid. Otherwise, it is marked as not valid and rolls back to the previous working app. A reboot is performed, and the app is booted before the software update. Note: If during the first boot a new app the power goes out or the WDT works, then roll back will happen. Rollback is possible only between the apps with the same security versions.

**Default value:**

- No (disabled)

### CONFIG\_BOOTLOADER\_APP\_ANTI\_ROLLBACK

Enable app anti-rollback support

*Found in: [Bootloader config](#) > [CONFIG\\_BOOTLOADER\\_APP\\_ROLLBACK\\_ENABLE](#)*

This option prevents rollback to previous firmware/application image with lower security version.

**Default value:**

- No (disabled) if [CONFIG\\_BOOTLOADER\\_APP\\_ROLLBACK\\_ENABLE](#)

### CONFIG\_BOOTLOADER\_APP\_SECURE\_VERSION

eFuse secure version of app

*Found in: [Bootloader config](#) > [CONFIG\\_BOOTLOADER\\_APP\\_ROLLBACK\\_ENABLE](#) > [CONFIG\\_BOOTLOADER\\_APP\\_ANTI\\_ROLLBACK](#)*

The secure version is the sequence number stored in the header of each firmware. The security version is set in the bootloader, version is recorded in the eFuse field as the number of set ones. The allocated number of bits in the efuse field for storing the security version is limited (see `BOOTLOADER_APP_SEC_VER_SIZE_EFUSE_FIELD` option).

Bootloader: When bootloader selects an app to boot, an app is selected that has a security version greater or equal that recorded in eFuse field. The app is booted with a higher (or equal) secure version.

The security version is worth increasing if in previous versions there is a significant vulnerability and their use is not acceptable.

Your partition table should has a scheme with `ota_0 + ota_1` (without factory).

**Default value:**

- 0 if `CONFIG_BOOTLOADER_APP_ANTI_ROLLBACK`

### **CONFIG\_BOOTLOADER\_APP\_SEC\_VER\_SIZE\_EFUSE\_FIELD**

Size of the efuse secure version field

*Found in:* `Bootloader config > CONFIG_BOOTLOADER_APP_ROLLBACK_ENABLE > CONFIG_BOOTLOADER_APP_ANTI_ROLLBACK`

The size of the efuse secure version field. Its length is limited to 32 bits for ESP32 and 16 bits for ESP32-S2. This determines how many times the security version can be increased.

**Range:**

- from 1 to 16 if `CONFIG_BOOTLOADER_APP_ANTI_ROLLBACK`

**Default value:**

- 16 if `CONFIG_BOOTLOADER_APP_ANTI_ROLLBACK`

### **CONFIG\_BOOTLOADER\_EFUSE\_SECURE\_VERSION\_EMULATE**

Emulate operations with efuse secure version(only test)

*Found in:* `Bootloader config > CONFIG_BOOTLOADER_APP_ROLLBACK_ENABLE > CONFIG_BOOTLOADER_APP_ANTI_ROLLBACK`

This option allows to emulate read/write operations with all eFuses and efuse secure version. It allows to test anti-rollback implementation without permanent write eFuse bits. There should be an entry in partition table with following details: `emul_efuse, data, efuse, , 0x2000`.

This option enables: `EFUSE_VIRTUAL` and `EFUSE_VIRTUAL_KEEP_IN_FLASH`.

**Default value:**

- No (disabled) if `CONFIG_BOOTLOADER_APP_ANTI_ROLLBACK`

### **CONFIG\_BOOTLOADER\_SKIP\_VALIDATE\_IN\_DEEP\_SLEEP**

Skip image validation when exiting deep sleep

*Found in:* `Bootloader config`

This option disables the normal validation of an image coming out of deep sleep (checksums, SHA256, and signature). This is a trade-off between wakeup performance from deep sleep, and image integrity checks.

Only enable this if you know what you are doing. It should not be used in conjunction with using `deep_sleep()` entry and changing the active OTA partition as this would skip the validation upon first load of the new OTA partition.

It is possible to enable this option with Secure Boot if "allow insecure options" is enabled, however it's strongly recommended to NOT enable it as it may allow a Secure Boot bypass.

**Default value:**

- No (disabled) if `CONFIG_SECURE_BOOT` && `CONFIG_SECURE_BOOT_INSECURE`

### **CONFIG\_BOOTLOADER\_SKIP\_VALIDATE\_ON\_POWER\_ON**

Skip image validation from power on reset (READ HELP FIRST)

*Found in: [Bootloader config](#)*

Some applications need to boot very quickly from power on. By default, the entire app binary is read from flash and verified which takes up a significant portion of the boot time.

Enabling this option will skip validation of the app when the SoC boots from power on. Note that in this case it's not possible for the bootloader to detect if an app image is corrupted in the flash, therefore it's not possible to safely fall back to a different app partition. Flash corruption of this kind is unlikely but can happen if there is a serious firmware bug or physical damage.

Following other reset types, the bootloader will still validate the app image. This increases the chances that flash corruption resulting in a crash can be detected following soft reset, and the bootloader will fall back to a valid app image. To increase the chances of successfully recovering from a flash corruption event, keep the option `BOOTLOADER_WDT_ENABLE` enabled and consider also enabling `BOOTLOADER_WDT_DISABLE_IN_USER_CODE` - then manually disable the RTC Watchdog once the app is running. In addition, enable both the Task and Interrupt watchdog timers with reset options set.

**Default value:**

- No (disabled)

### **CONFIG\_BOOTLOADER\_SKIP\_VALIDATE\_ALWAYS**

Skip image validation always (READ HELP FIRST)

*Found in: [Bootloader config](#)*

Selecting this option prevents the bootloader from ever validating the app image before booting it. Any flash corruption of the selected app partition will make the entire SoC unbootable.

Although flash corruption is a very rare case, it is not recommended to select this option. Consider selecting "Skip image validation from power on reset" instead. However, if boot time is the only important factor then it can be enabled.

**Default value:**

- No (disabled)

### **CONFIG\_BOOTLOADER\_CUSTOM\_RESERVE\_RTC**

Reserve RTC FAST memory for custom purposes

*Found in: [Bootloader config](#)*

This option allows the customer to place data in the RTC FAST memory, this area remains valid when rebooted, except for power loss. This memory is located at a fixed address and is available for both the bootloader and the application. (The application and bootloader must be compiled with the same option). The RTC FAST memory has access only through `PRO_CPU`.

**Default value:**

- No (disabled)

### **CONFIG\_BOOTLOADER\_CUSTOM\_RESERVE\_RTC\_IN\_CRC**

Include custom memory in the CRC calculation

*Found in: [Bootloader config](#) > [CONFIG\\_BOOTLOADER\\_CUSTOM\\_RESERVE\\_RTC](#)*

This option allows the customer to use the legacy bootloader behavior when the RTC FAST memory CRC calculation takes place. When this option is enabled, the allocated user custom data will be taken

into account in the CRC calculation. This means that any change to the custom data would need a CRC update to prevent the bootloader from marking this data as corrupted. If this option is disabled, the custom data will not be taken into account when calculating the RTC FAST memory CRC. The user custom data can be changed freely, without the need to update the CRC. THIS OPTION MUST BE THE SAME FOR BOTH THE BOOTLOADER AND THE APPLICATION BUILDS.

**Default value:**

- No (disabled) if `CONFIG_BOOTLOADER_CUSTOM_RESERVE_RTC`

**CONFIG\_BOOTLOADER\_CUSTOM\_RESERVE\_RTC\_SIZE**

Size in bytes for custom purposes

*Found in:* `Bootloader config` > `CONFIG_BOOTLOADER_CUSTOM_RESERVE_RTC`

This option reserves in RTC FAST memory the area for custom purposes. If you want to create your own bootloader and save more information in this area of memory, you can increase it. It must be a multiple of 4 bytes. This area (`rtc_retain_mem_t`) is reserved and has access from the bootloader and an application.

**Default value:**

- 0 if `CONFIG_BOOTLOADER_CUSTOM_RESERVE_RTC`

**Security features**

Contains:

- `CONFIG_SECURE_BOOT_INSECURE`
- `CONFIG_SECURE_SIGNED_APPS_SCHEME`
- `CONFIG_SECURE_SIGNED_ON_BOOT_NO_SECURE_BOOT`
- `CONFIG_SECURE_FLASH_CHECK_ENC_EN_IN_APP`
- `CONFIG_SECURE_BOOT_ECDSA_KEY_LEN_SIZE`
- `CONFIG_SECURE_BOOT_ENABLE_AGGRESSIVE_KEY_REVOKE`
- `CONFIG_SECURE_FLASH_ENC_ENABLED`
- `CONFIG_SECURE_BOOT`
- `CONFIG_SECURE_FLASH_ENCRYPT_ONLY_IMAGE_LEN_IN_APP_PART`
- `CONFIG_SECURE_BOOT_FLASH_BOOTLOADER_DEFAULT`
- `CONFIG_SECURE_BOOTLOADER_KEY_ENCODING`
- *Potentially insecure options*
- `CONFIG_SECURE_SIGNED_APPS_NO_SECURE_BOOT`
- `CONFIG_SECURE_BOOT_VERIFICATION_KEY`
- `CONFIG_SECURE_BOOTLOADER_MODE`
- `CONFIG_SECURE_BOOT_BUILD_SIGNED_BINARIES`
- `CONFIG_SECURE_UART_ROM_DL_MODE`
- `CONFIG_SECURE_SIGNED_ON_UPDATE_NO_SECURE_BOOT`

**CONFIG\_SECURE\_SIGNED\_APPS\_NO\_SECURE\_BOOT**

Require signed app images

*Found in:* `Security features`

Require apps to be signed to verify their integrity.

This option uses the same app signature scheme as hardware secure boot, but unlike hardware secure boot it does not prevent the bootloader from being physically updated. This means that the device can be secured against remote network access, but not physical access. Compared to using hardware Secure Boot this option is much simpler to implement.



## CONFIG\_SECURE\_SIGNED\_APPS\_SCHEME

App Signing Scheme

*Found in: Security features*

Select the Secure App signing scheme. Depends on the Chip Revision. There are two secure boot versions:

1. **Secure boot V1**
  - Legacy custom secure boot scheme. Supported in ESP32 SoC.
2. **Secure boot V2**
  - RSA based secure boot scheme. Supported in ESP32-ECO3 (ESP32 Chip Revision 3 onwards), ESP32-S2, ESP32-C3, ESP32-S3 SoCs.
  - ECDSA based secure boot scheme. Supported in ESP32-C2 SoC.

Available options:

- ECDSA (CONFIG\_SECURE\_SIGNED\_APPS\_ECDSA\_SCHEME)  
Embeds the ECDSA public key in the bootloader and signs the application with an ECDSA key. Refer to the documentation before enabling.
- RSA (CONFIG\_SECURE\_SIGNED\_APPS\_RSA\_SCHEME)  
Appends the RSA-3072 based Signature block to the application. Refer to <Secure Boot Version 2 documentation link> before enabling.
- ECDSA (V2) (CONFIG\_SECURE\_SIGNED\_APPS\_ECDSA\_V2\_SCHEME)  
For Secure boot V2 (e.g., ESP32-C2 SoC), appends ECDSA based signature block to the application. Refer to documentation before enabling.

## CONFIG\_SECURE\_BOOT\_ECDSA\_KEY\_LEN\_SIZE

ECDSA key size

*Found in: Security features*

Select the ECDSA key size. Two key sizes are supported

- 192 bit key using NISTP192 curve
- 256 bit key using NISTP256 curve (Recommended)

The advantage of using 256 bit key is the extra randomness which makes it difficult to be bruteforced compared to 192 bit key. At present, both key sizes are practically implausible to bruteforce.

Available options:

- Using ECC curve NISTP192 (CONFIG\_SECURE\_BOOT\_ECDSA\_KEY\_LEN\_192\_BITS)
- Using ECC curve NISTP256 (Recommended) (CONFIG\_SECURE\_BOOT\_ECDSA\_KEY\_LEN\_256\_BITS)

## CONFIG\_SECURE\_SIGNED\_ON\_BOOT\_NO\_SECURE\_BOOT

Bootloader verifies app signatures

*Found in: Security features*

If this option is set, the bootloader will be compiled with code to verify that an app is signed before booting it.

If hardware secure boot is enabled, this option is always enabled and cannot be disabled. If hardware secure boot is not enabled, this option doesn't add significant security by itself so most users will want to leave it disabled.

**Default value:**

- No (disabled) if `CONFIG_SECURE_SIGNED_APPS_NO_SECURE_BOOT` && `CONFIG_SECURE_SIGNED_APPS_ECDSA_SCHEME`

### **CONFIG\_SECURE\_SIGNED\_ON\_UPDATE\_NO\_SECURE\_BOOT**

Verify app signature on update

*Found in:* [Security features](#)

If this option is set, any OTA updated apps will have the signature verified before being considered valid.

When enabled, the signature is automatically checked whenever the `esp_ota_ops.h` APIs are used for OTA updates, or `esp_image_format.h` APIs are used to verify apps.

If hardware secure boot is enabled, this option is always enabled and cannot be disabled. If hardware secure boot is not enabled, this option still adds significant security against network-based attackers by preventing spoofing of OTA updates.

**Default value:**

- Yes (enabled) if `CONFIG_SECURE_SIGNED_APPS_NO_SECURE_BOOT`

### **CONFIG\_SECURE\_BOOT**

Enable hardware Secure Boot in bootloader (READ DOCS FIRST)

*Found in:* [Security features](#)

Build a bootloader which enables Secure Boot on first boot.

Once enabled, Secure Boot will not boot a modified bootloader. The bootloader will only load a partition table or boot an app if the data has a verified digital signature. There are implications for reflashing updated apps once secure boot is enabled.

When enabling secure boot, JTAG and ROM BASIC Interpreter are permanently disabled by default.

**Default value:**

- No (disabled)

### **CONFIG\_SECURE\_BOOT\_VERSION**

Select secure boot version

*Found in:* [Security features](#) > `CONFIG_SECURE_BOOT`

Select the Secure Boot Version. Depends on the Chip Revision. Secure Boot V2 is the new RSA / ECDSA based secure boot scheme.

- RSA based scheme is supported in ESP32 (Revision 3 onwards), ESP32-S2, ESP32-C3 (ECO3), ESP32-S3.
- ECDSA based scheme is supported in ESP32-C2 SoC.

Please note that, RSA or ECDSA secure boot is property of specific SoC based on its HW design, supported crypto accelerators, die-size, cost and similar parameters. Please note that RSA scheme has requirement for bigger key sizes but at the same time it is comparatively faster than ECDSA verification.

Secure Boot V1 is the AES based (custom) secure boot scheme supported in ESP32 SoC.

Available options:

- Enable Secure Boot version 1 (`CONFIG_SECURE_BOOT_V1_ENABLED`)  
Build a bootloader which enables secure boot version 1 on first boot. Refer to the Secure Boot section of the ESP-IDF Programmer's Guide for this version before enabling.
- Enable Secure Boot version 2 (`CONFIG_SECURE_BOOT_V2_ENABLED`)  
Build a bootloader which enables Secure Boot version 2 on first boot. Refer to Secure Boot V2 section of the ESP-IDF Programmer's Guide for this version before enabling.

## CONFIG\_SECURE\_BOOTLOADER\_MODE

Secure bootloader mode

*Found in: Security features*

Available options:

- One-time flash (CONFIG\_SECURE\_BOOTLOADER\_ONE\_TIME\_FLASH)  
On first boot, the bootloader will generate a key which is not readable externally or by software. A digest is generated from the bootloader image itself. This digest will be verified on each subsequent boot.  
Enabling this option means that the bootloader cannot be changed after the first time it is booted.
- Reflashable (CONFIG\_SECURE\_BOOTLOADER\_REFLASHABLE)  
Generate a reusable secure bootloader key, derived (via SHA-256) from the secure boot signing key.  
This allows the secure bootloader to be re-flashed by anyone with access to the secure boot signing key.  
This option is less secure than one-time flash, because a leak of the digest key from one device allows reflashing of any device that uses it.

## CONFIG\_SECURE\_BOOT\_BUILD\_SIGNED\_BINARIES

Sign binaries during build

*Found in: Security features*

Once secure boot or signed app requirement is enabled, app images are required to be signed.

If enabled (default), these binary files are signed as part of the build process. The file named in "Secure boot private signing key" will be used to sign the image.

If disabled, unsigned app/partition data will be built. They must be signed manually using `espsecure.py`. Version 1 to enable ECDSA Based Secure Boot and Version 2 to enable RSA based Secure Boot. (for example, on a remote signing server.)

## CONFIG\_SECURE\_BOOT\_SIGNING\_KEY

Secure boot private signing key

*Found in: Security features > CONFIG\_SECURE\_BOOT\_BUILD\_SIGNED\_BINARIES*

Path to the key file used to sign app images.

Key file is an ECDSA private key (NIST256p curve) in PEM format for Secure Boot V1. Key file is an RSA private key in PEM format for Secure Boot V2.

Path is evaluated relative to the project directory.

You can generate a new signing key by running the following command: `espsecure.py generate_signing_key secure_boot_signing_key.pem`

See the Secure Boot section of the ESP-IDF Programmer's Guide for this version for details.

**Default value:**

- "secure\_boot\_signing\_key.pem" if *CONFIG\_SECURE\_BOOT\_BUILD\_SIGNED\_BINARIES*

## CONFIG\_SECURE\_BOOT\_VERIFICATION\_KEY

Secure boot public signature verification key

*Found in: Security features*

Path to a public key file used to verify signed images. Secure Boot V1: This ECDSA public key is compiled into the bootloader and/or app, to verify app images.

Key file is in raw binary format, and can be extracted from a PEM formatted private key using the `espsecure.py extract_public_key` command.

Refer to the Secure Boot section of the ESP-IDF Programmer's Guide for this version before enabling.

### **CONFIG\_SECURE\_BOOT\_ENABLE\_AGGRESSIVE\_KEY\_REVOKE**

Enable Aggressive key revoke strategy

*Found in: Security features*

If this option is set, ROM bootloader will revoke the public key digest burned in efuse block if it fails to verify the signature of software bootloader with it. Revocation of keys does not happen when enabling secure boot. Once secure boot is enabled, key revocation checks will be done on subsequent boot-up, while verifying the software bootloader

This feature provides a strong resistance against physical attacks on the device.

NOTE: Once a digest slot is revoked, it can never be used again to verify an image This can lead to permanent bricking of the device, in case all keys are revoked because of signature verification failure.

#### **Default value:**

- No (disabled) if `CONFIG_SECURE_BOOT`

### **CONFIG\_SECURE\_BOOT\_FLASH\_BOOTLOADER\_DEFAULT**

Flash bootloader along with other artifacts when using the default flash command

*Found in: Security features*

When Secure Boot V2 is enabled, by default the bootloader is not flashed along with other artifacts like the application and the partition table images, i.e. bootloader has to be separately flashed using the command `idf.py bootloader flash`, whereas, the application and partition table can be flashed using the command `idf.py flash` itself. Enabling this option allows flashing the bootloader along with the other artifacts by invocation of the command `idf.py flash`.

If this option is enabled make sure that even the bootloader is signed using the correct secure boot key, otherwise the bootloader signature verification would fail, as hash of the public key which is present in the bootloader signature would not match with the digest stored into the efuses and thus the device will not be able to boot up.

#### **Default value:**

- No (disabled) if `CONFIG_SECURE_BOOT_V2_ENABLED` && `CONFIG_SECURE_BOOT_BUILD_SIGNED_BINARIES`

### **CONFIG\_SECURE\_BOOTLOADER\_KEY\_ENCODING**

Hardware Key Encoding

*Found in: Security features*

In reflashable secure bootloader mode, a hardware key is derived from the signing key (with SHA-256) and can be written to eFuse with `espefuse.py`.

Normally this is a 256-bit key, but if 3/4 Coding Scheme is used on the device then the eFuse key is truncated to 192 bits.

This configuration item doesn't change any firmware code, it only changes the size of key binary which is generated at build time.

Available options:

- No encoding (256 bit key) (CONFIG\_SECURE\_BOOTLOADER\_KEY\_ENCODING\_256BIT)
- 3/4 encoding (192 bit key) (CONFIG\_SECURE\_BOOTLOADER\_KEY\_ENCODING\_192BIT)

### CONFIG\_SECURE\_BOOT\_INSECURE

Allow potentially insecure options

*Found in: Security features*

You can disable some of the default protections offered by secure boot, in order to enable testing or a custom combination of security features.

Only enable these options if you are very sure.

Refer to the Secure Boot section of the ESP-IDF Programmer's Guide for this version before enabling.

**Default value:**

- No (disabled) if *CONFIG\_SECURE\_BOOT*

### CONFIG\_SECURE\_FLASH\_ENC\_ENABLED

Enable flash encryption on boot (READ DOCS FIRST)

*Found in: Security features*

If this option is set, flash contents will be encrypted by the bootloader on first boot.

Note: After first boot, the system will be permanently encrypted. Re-flashing an encrypted system is complicated and not always possible.

Read *flash 加密* before enabling.

**Default value:**

- No (disabled)

### CONFIG\_SECURE\_FLASH\_ENCRYPTION\_KEYSIZE

Size of generated XTS-AES key

*Found in: Security features > CONFIG\_SECURE\_FLASH\_ENC\_ENABLED*

Size of generated XTS-AES key.

- AES-128 uses a 256-bit key (32 bytes) derived from 128 bits (16 bytes) burned in half Efuse key block. Internally, it calculates SHA256(128 bits)
- AES-128 uses a 256-bit key (32 bytes) which occupies one Efuse key block.
- AES-256 uses a 512-bit key (64 bytes) which occupies two Efuse key blocks.

This setting is ignored if either type of key is already burned to Efuse before the first boot. In this case, the pre-burned key is used and no new key is generated.

Available options:

- AES-128 key derived from 128 bits (SHA256(128 bits)) (CONFIG\_SECURE\_FLASH\_ENCRYPTION\_AES128\_DERIVED)
- AES-128 (256-bit key) (CONFIG\_SECURE\_FLASH\_ENCRYPTION\_AES128)
- AES-256 (512-bit key) (CONFIG\_SECURE\_FLASH\_ENCRYPTION\_AES256)

### CONFIG\_SECURE\_FLASH\_ENCRYPTION\_MODE

Enable usage mode

*Found in: Security features > CONFIG\_SECURE\_FLASH\_ENC\_ENABLED*

By default Development mode is enabled which allows ROM download mode to perform flash encryption operations (plaintext is sent to the device, and it encrypts it internally and writes ciphertext to flash.) This mode is not secure, it's possible for an attacker to write their own chosen plaintext to flash.

Release mode should always be selected for production or manufacturing. Once enabled it's no longer possible for the device in ROM Download Mode to use the flash encryption hardware.

When EFUSE\_VIRTUAL is enabled, SECURE\_FLASH\_ENCRYPTION\_MODE\_RELEASE is not available. For CI tests we use IDF\_CI\_BUILD to bypass it ("export IDF\_CI\_BUILD=1"). We do not recommend bypassing it for other purposes.

Refer to the Flash Encryption section of the ESP-IDF Programmer's Guide for details.

Available options:

- Development (NOT SECURE) (CONFIG\_SECURE\_FLASH\_ENCRYPTION\_MODE\_DEVELOPMENT)
- Release (CONFIG\_SECURE\_FLASH\_ENCRYPTION\_MODE\_RELEASE)

**Potentially insecure options** Contains:

- [CONFIG\\_SECURE\\_BOOT\\_V2\\_ALLOW\\_EFUSE\\_RD\\_DIS](#)
- [CONFIG\\_SECURE\\_BOOT\\_ALLOW\\_SHORT\\_APP\\_PARTITION](#)
- [CONFIG\\_SECURE\\_BOOT\\_ALLOW\\_JTAG](#)
- [CONFIG\\_SECURE\\_FLASH\\_UART\\_BOOTLOADER\\_ALLOW\\_ENC](#)
- [CONFIG\\_SECURE\\_FLASH\\_UART\\_BOOTLOADER\\_ALLOW\\_CACHE](#)
- [CONFIG\\_SECURE\\_BOOT\\_ALLOW\\_UNUSED\\_DIGEST\\_SLOTS](#)
- [CONFIG\\_SECURE\\_FLASH\\_REQUIRE\\_ALREADY\\_ENABLED](#)
- [CONFIG\\_SECURE\\_FLASH\\_SKIP\\_WRITE\\_PROTECTION\\_CACHE](#)

### CONFIG\_SECURE\_BOOT\_ALLOW\_JTAG

Allow JTAG Debugging

*Found in: Security features > Potentially insecure options*

If not set (default), the bootloader will permanently disable JTAG (across entire chip) on first boot when either secure boot or flash encryption is enabled.

Setting this option leaves JTAG on for debugging, which negates all protections of flash encryption and some of the protections of secure boot.

Only set this option in testing environments.

**Default value:**

- No (disabled) if `CONFIG_SECURE_BOOT_INSECURE` || `CONFIG_SECURE_FLASH_ENCRYPTION_MODE_DEVELOPMENT`

### CONFIG\_SECURE\_BOOT\_ALLOW\_SHORT\_APP\_PARTITION

Allow app partition length not 64KB aligned

*Found in: Security features > Potentially insecure options*

If not set (default), app partition size must be a multiple of 64KB. App images are padded to 64KB length, and the bootloader checks any trailing bytes after the signature (before the next 64KB boundary) have not been written. This is because flash cache maps entire 64KB pages into the address space. This prevents an attacker from appending unverified data after the app image in the flash, causing it to be mapped into the address space.

Setting this option allows the app partition length to be unaligned, and disables padding of the app image to this length. It is generally not recommended to set this option, unless you have a legacy partitioning scheme which doesn't support 64KB aligned partition lengths.

### CONFIG\_SECURE\_BOOT\_V2\_ALLOW\_EFUSE\_RD\_DIS

Allow additional read protecting of efuses

*Found in: Security features > Potentially insecure options*

If not set (default, recommended), on first boot the bootloader will burn the WR\_DIS\_RD\_DIS efuse when Secure Boot is enabled. This prevents any more efuses from being read protected.

If this option is set, it will remain possible to write the EFUSE\_RD\_DIS efuse field after Secure Boot is enabled. This may allow an attacker to read-protect the BLK2 efuse (for ESP32) and BLOCK4-BLOCK10 (i.e. BLOCK\_KEY0-BLOCK\_KEY5)(for other chips) holding the public key digest, causing an immediate denial of service and possibly allowing an additional fault injection attack to bypass the signature protection.

NOTE: Once a BLOCK is read-protected, the application will read all zeros from that block

NOTE: If "UART ROM download mode (Permanently disabled (recommended))" or "UART ROM download mode (Permanently switch to Secure mode (recommended))" is set, then it is NOT possible to read/write efuses using espfuse.py utility. However, efuse can be read/written from the application

### CONFIG\_SECURE\_BOOT\_ALLOW\_UNUSED\_DIGEST\_SLOTS

Leave unused digest slots available (not revoke)

*Found in: Security features > Potentially insecure options*

If not set (default), during startup in the app all unused digest slots will be revoked. To revoke unused slot will be called `esp_efuse_set_digest_revoke(num_digest)` for each digest. Revoking unused digest slots makes ensures that no trusted keys can be added later by an attacker. If set, it means that you have a plan to use unused digests slots later.

Note that if you plan to enable secure boot during the first boot up, the bootloader will intentionally revoke the unused digest slots while enabling secure boot, even if the above config is enabled because keeping the unused key slots un-revoked would a security hazard. In case for any development workflow if you need to avoid this revocation, you should enable secure boot externally (host based mechanism) rather than enabling it during the boot up, so that the bootloader would not need to enable secure boot and thus you could avoid its revocation strategy.

**Default value:**

- No (disabled) if `CONFIG_SECURE_BOOT_INSECURE`

### CONFIG\_SECURE\_FLASH\_UART\_BOOTLOADER\_ALLOW\_ENC

Leave UART bootloader encryption enabled

*Found in: Security features > Potentially insecure options*

If not set (default), the bootloader will permanently disable UART bootloader encryption access on first boot. If set, the UART bootloader will still be able to access hardware encryption.

It is recommended to only set this option in testing environments.

**Default value:**

- No (disabled) if `CONFIG_SECURE_FLASH_ENCRYPTION_MODE_DEVELOPMENT`

### CONFIG\_SECURE\_FLASH\_UART\_BOOTLOADER\_ALLOW\_CACHE

Leave UART bootloader flash cache enabled

*Found in: Security features > Potentially insecure options*

If not set (default), the bootloader will permanently disable UART bootloader flash cache access on first boot. If set, the UART bootloader will still be able to access the flash cache.



Only set this option in testing environments.

**Default value:**

- No (disabled) if `CONFIG_SECURE_FLASH_ENCRYPTION_MODE_DEVELOPMENT` && `(SOC_EFUSE_DIS_DOWNLOAD_ICACHE || SOC_EFUSE_DIS_DOWNLOAD_DCACHE)`

## CONFIG\_SECURE\_FLASH\_REQUIRE\_ALREADY\_ENABLED

Require flash encryption to be already enabled

*Found in: Security features > Potentially insecure options*

If not set (default), and flash encryption is not yet enabled in eFuses, the 2nd stage bootloader will enable flash encryption: generate the flash encryption key and program eFuses. If this option is set, and flash encryption is not yet enabled, the bootloader will error out and reboot. If flash encryption is enabled in eFuses, this option does not change the bootloader behavior.

Only use this option in testing environments, to avoid accidentally enabling flash encryption on the wrong device. The device needs to have flash encryption already enabled using `espefuse.py`.

**Default value:**

- No (disabled) if `CONFIG_SECURE_FLASH_ENCRYPTION_MODE_DEVELOPMENT`

## CONFIG\_SECURE\_FLASH\_SKIP\_WRITE\_PROTECTION\_CACHE

Skip write-protection of DIS\_CACHE (DIS\_ICACHE, DIS\_DCACHE)

*Found in: Security features > Potentially insecure options*

If not set (default, recommended), on the first boot the bootloader will burn the write-protection of DIS\_CACHE(for ESP32) or DIS\_ICACHE/DIS\_DCACHE(for other chips) eFuse when Flash Encryption is enabled. Write protection for cache disable efuse prevents the chip from being blocked if it is set by accident. App and bootloader use cache so disabling it makes the chip useless for IDF. Due to other eFuses are linked with the same write protection bit (see the list below) then write-protection will not be done if these `SECURE_FLASH_UART_BOOTLOADER_ALLOW_ENC`, `SECURE_BOOT_ALLOW_JTAG` or `SECURE_FLASH_UART_BOOTLOADER_ALLOW_CACHE` options are selected to give a chance to turn on the chip into the release mode later.

List of eFuses with the same write protection bit: ESP32: `MAC`, `MAC_CRC`, `DISABLE_APP_CPU`, `DISABLE_BT`, `DIS_CACHE`, `VOL_LEVEL_HP_INV`.

ESP32-C3: `DIS_ICACHE`, `DIS_USB_JTAG`, `DIS_DOWNLOAD_ICACHE`, `DIS_USB_SERIAL_JTAG`, `DIS_FORCE_DOWNLOAD`, `DIS_TWAI`, `JTAG_SEL_ENABLE`, `DIS_PAD_JTAG`, `DIS_DOWNLOAD_MANUAL_ENCRYPT`.

ESP32-C6: `SWAP_UART_SDIO_EN`, `DIS_ICACHE`, `DIS_USB_JTAG`, `DIS_DOWNLOAD_ICACHE`, `DIS_USB_SERIAL_JTAG`, `DIS_FORCE_DOWNLOAD`, `DIS_TWAI`, `JTAG_SEL_ENABLE`, `DIS_PAD_JTAG`, `DIS_DOWNLOAD_MANUAL_ENCRYPT`.

ESP32-H2: `DIS_ICACHE`, `DIS_USB_JTAG`, `POWERGLITCH_EN`, `DIS_FORCE_DOWNLOAD`, `SPI_DOWNLOAD_MSPI_DIS`, `DIS_TWAI`, `JTAG_SEL_ENABLE`, `DIS_PAD_JTAG`, `DIS_DOWNLOAD_MANUAL_ENCRYPT`.

ESP32-S2: `DIS_ICACHE`, `DIS_DCACHE`, `DIS_DOWNLOAD_ICACHE`, `DIS_DOWNLOAD_DCACHE`, `DIS_FORCE_DOWNLOAD`, `DIS_USB`, `DIS_TWAI`, `DIS_BOOT_REMAP`, `SOFT_DIS_JTAG`, `HARD_DIS_JTAG`, `DIS_DOWNLOAD_MANUAL_ENCRYPT`.

ESP32-S3: `DIS_ICACHE`, `DIS_DCACHE`, `DIS_DOWNLOAD_ICACHE`, `DIS_DOWNLOAD_DCACHE`, `DIS_FORCE_DOWNLOAD`, `DIS_USB_OTG`, `DIS_TWAI`, `DIS_APP_CPU`, `DIS_PAD_JTAG`, `DIS_DOWNLOAD_MANUAL_ENCRYPT`, `DIS_USB_JTAG`, `DIS_USB_SERIAL_JTAG`, `STRAP_JTAG_SEL`, `USB_PHY_SEL`.



### CONFIG\_SECURE\_FLASH\_ENCRYPT\_ONLY\_IMAGE\_LEN\_IN\_APP\_PART

Encrypt only the app image that is present in the partition of type app

*Found in: Security features*

If set (default), optimise encryption time for the partition of type APP, by only encrypting the app image that is present in the partition, instead of the whole partition. The image length used for encryption is derived from the image metadata, which includes the size of the app image, checksum, hash and also the signature sector when secure boot is enabled.

If not set, the whole partition of type APP would be encrypted, which increases the encryption time but might be useful if there is any custom data appended to the firmware image.

### CONFIG\_SECURE\_FLASH\_CHECK\_ENC\_EN\_IN\_APP

Check Flash Encryption enabled on app startup

*Found in: Security features*

If set (default), in an app during startup code, there is a check of the flash encryption eFuse bit is on (as the bootloader should already have set it). The app requires this bit is on to continue work otherwise abort.

If not set, the app does not care if the flash encryption eFuse bit is set or not.

**Default value:**

- Yes (enabled) if `CONFIG_SECURE_FLASH_ENC_ENABLED`

### CONFIG\_SECURE\_UART\_ROM\_DL\_MODE

UART ROM download mode

*Found in: Security features*

Available options:

- UART ROM download mode (Permanently disabled (recommended)) (`CONFIG_SECURE_DISABLE_ROM_DL_MODE`)  
If set, during startup the app will burn an eFuse bit to permanently disable the UART ROM Download Mode. This prevents any future use of `esptool.py`, `espefuse.py` and similar tools.  
Once disabled, if the SoC is booted with strapping pins set for ROM Download Mode then an error is printed instead.  
It is recommended to enable this option in any production application where Flash Encryption and/or Secure Boot is enabled and access to Download Mode is not required.  
It is also possible to permanently disable Download Mode by calling `esp_efuse_disable_rom_download_mode()` at runtime.
- UART ROM download mode (Permanently switch to Secure mode (recommended)) (`CONFIG_SECURE_ENABLE_SECURE_ROM_DL_MODE`)  
If set, during startup the app will burn an eFuse bit to permanently switch the UART ROM Download Mode into a separate Secure Download mode. This option can only work if Download Mode is not already disabled by eFuse.  
Secure Download mode limits the use of Download Mode functions to update SPI config, changing baud rate, basic flash write and a command to return a summary of currently enabled security features (`get_security_info`).  
Secure Download mode is not compatible with the `esptool.py` flasher stub feature, `espefuse.py`, read/writing memory or registers, encrypted download, or any other features that interact with unsupported Download Mode commands.  
Secure Download mode should be enabled in any application where Flash Encryption and/or Secure Boot is enabled. Disabling this option does not immediately cancel the

benefits of the security features, but it increases the potential "attack surface" for an attacker to try and bypass them with a successful physical attack.

It is also possible to enable secure download mode at runtime by calling `esp_efuse_enable_rom_secure_download_mode()`

Note: Secure Download mode is not available for ESP32 (includes revisions till ECO3).

- UART ROM download mode (Enabled (not recommended)) (`CONFIG_SECURE_INSECURE_ALLOW_DL_MODE`)

This is a potentially insecure option. Enabling this option will allow the full UART download mode to stay enabled. This option SHOULD NOT BE ENABLED for production use cases.

## Application manager

Contains:

- `CONFIG_APP_EXCLUDE_PROJECT_NAME_VAR`
- `CONFIG_APP_EXCLUDE_PROJECT_VER_VAR`
- `CONFIG_APP_PROJECT_VER_FROM_CONFIG`
- `CONFIG_APP_RETRIEVE_LEN_ELF_SHA`
- `CONFIG_APP_COMPILE_TIME_DATE`

### CONFIG\_APP\_COMPILE\_TIME\_DATE

Use time/date stamp for app

*Found in: Application manager*

If set, then the app will be built with the current time/date stamp. It is stored in the app description structure. If not set, time/date stamp will be excluded from app image. This can be useful for getting the same binary image files made from the same source, but at different times.

### CONFIG\_APP\_EXCLUDE\_PROJECT\_VER\_VAR

Exclude `PROJECT_VER` from firmware image

*Found in: Application manager*

The `PROJECT_VER` variable from the build system will not affect the firmware image. This value will not be contained in the `esp_app_desc` structure.

**Default value:**

- No (disabled)

### CONFIG\_APP\_EXCLUDE\_PROJECT\_NAME\_VAR

Exclude `PROJECT_NAME` from firmware image

*Found in: Application manager*

The `PROJECT_NAME` variable from the build system will not affect the firmware image. This value will not be contained in the `esp_app_desc` structure.

**Default value:**

- No (disabled)

### CONFIG\_APP\_PROJECT\_VER\_FROM\_CONFIG

Get the project version from Kconfig

*Found in: Application manager*

If this is enabled, then config item APP\_PROJECT\_VER will be used for the variable PROJECT\_VER. Other ways to set PROJECT\_VER will be ignored.

**Default value:**

- No (disabled)

**CONFIG\_APP\_PROJECT\_VER**

Project version

*Found in: Application manager > CONFIG\_APP\_PROJECT\_VER\_FROM\_CONFIG*

Project version

**Default value:**

- 1 if *CONFIG\_APP\_PROJECT\_VER\_FROM\_CONFIG*

**CONFIG\_APP\_RETRIEVE\_LEN\_ELF\_SHA**

The length of APP ELF SHA is stored in RAM(chars)

*Found in: Application manager*

At startup, the app will read the embedded APP ELF SHA-256 hash value from flash and convert it into a string and store it in a RAM buffer. This ensures the panic handler and core dump will be able to print this string even when cache is disabled. The size of the buffer is APP\_RETRIEVE\_LEN\_ELF\_SHA plus the null terminator. Changing this value will change the size of this buffer, in bytes.

**Range:**

- from 8 to 64

**Default value:**

- 9

**Boot ROM Behavior**

Contains:

- *CONFIG\_BOOT\_ROM\_LOG\_SCHEME*

**CONFIG\_BOOT\_ROM\_LOG\_SCHEME**

Permanently change Boot ROM output

*Found in: Boot ROM Behavior*

Controls the Boot ROM log behavior. The rom log behavior can only be changed for once, specific eFuse bit(s) will be burned at app boot stage.

Available options:

- Always Log (CONFIG\_BOOT\_ROM\_LOG\_ALWAYS\_ON)  
Always print ROM logs, this is the default behavior.
- Permanently disable logging (CONFIG\_BOOT\_ROM\_LOG\_ALWAYS\_OFF)  
Don't print ROM logs.
- Log on GPIO High (CONFIG\_BOOT\_ROM\_LOG\_ON\_GPIO\_HIGH)  
Print ROM logs when GPIO level is high during start up. The GPIO number is chip dependent, e.g. on ESP32-S2, the control GPIO is GPIO46.
- Log on GPIO Low (CONFIG\_BOOT\_ROM\_LOG\_ON\_GPIO\_LOW)  
Print ROM logs when GPIO level is low during start up. The GPIO number is chip dependent, e.g. on ESP32-S2, the control GPIO is GPIO46.

## Serial flasher config

Contains:

- `CONFIG_ESPTOOLPY_AFTER`
- `CONFIG_ESPTOOLPY_BEFORE`
- `CONFIG_ESPTOOLPY_HEADER_FLASHSIZE_UPDATE`
- `CONFIG_ESPTOOLPY_NO_STUB`
- `CONFIG_ESPTOOLPY_FLASH_SAMPLE_MODE`
- `CONFIG_ESPTOOLPY_FLASHSIZE`
- `CONFIG_ESPTOOLPY_FLASHMODE`
- `CONFIG_ESPTOOLPY_FLASHFREQ`

### CONFIG\_ESPTOOLPY\_NO\_STUB

Disable download stub

*Found in: Serial flasher config*

The flasher tool sends a precompiled download stub first by default. That stub allows things like compressed downloads and more. Usually you should not need to disable that feature

### CONFIG\_ESPTOOLPY\_FLASHMODE

Flash SPI mode

*Found in: Serial flasher config*

Mode the flash chip is flashed in, as well as the default mode for the binary to run in.

Available options:

- QIO (`CONFIG_ESPTOOLPY_FLASHMODE_QIO`)
- QOUT (`CONFIG_ESPTOOLPY_FLASHMODE_QOUT`)
- DIO (`CONFIG_ESPTOOLPY_FLASHMODE_DIO`)
- DOUT (`CONFIG_ESPTOOLPY_FLASHMODE_DOUT`)
- OPI (`CONFIG_ESPTOOLPY_FLASHMODE_OPI`)

### CONFIG\_ESPTOOLPY\_FLASH\_SAMPLE\_MODE

Flash Sampling Mode

*Found in: Serial flasher config*

Available options:

- STR Mode (`CONFIG_ESPTOOLPY_FLASH_SAMPLE_MODE_STR`)
- DTR Mode (`CONFIG_ESPTOOLPY_FLASH_SAMPLE_MODE_DTR`)

### CONFIG\_ESPTOOLPY\_FLASHFREQ

Flash SPI speed

*Found in: Serial flasher config*

Available options:

- 120 MHz (READ DOCS FIRST) (`CONFIG_ESPTOOLPY_FLASHFREQ_120M`)

- Optional feature for QSPI Flash. Read docs and enable `CONFIG_SPI_FLASH_HPM_ENA` first!
- Flash 120 MHz SDR mode is stable.
- Flash 120 MHz DDR mode is an experimental feature, it works when the temperature is stable.

**Risks:** If your chip powers on at a certain temperature, then after the temperature increases or decreases by approximately 20 Celsius degrees (depending on the chip), the program will crash randomly.

- 80 MHz (`CONFIG_ESPTOOLPY_FLASHFREQ_80M`)
- 64 MHz (`CONFIG_ESPTOOLPY_FLASHFREQ_64M`)
- 60 MHz (`CONFIG_ESPTOOLPY_FLASHFREQ_60M`)
- 48 MHz (`CONFIG_ESPTOOLPY_FLASHFREQ_48M`)
- 40 MHz (`CONFIG_ESPTOOLPY_FLASHFREQ_40M`)
- 32 MHz (`CONFIG_ESPTOOLPY_FLASHFREQ_32M`)
- 30 MHz (`CONFIG_ESPTOOLPY_FLASHFREQ_30M`)
- 26 MHz (`CONFIG_ESPTOOLPY_FLASHFREQ_26M`)
- 24 MHz (`CONFIG_ESPTOOLPY_FLASHFREQ_24M`)
- 20 MHz (`CONFIG_ESPTOOLPY_FLASHFREQ_20M`)
- 16 MHz (`CONFIG_ESPTOOLPY_FLASHFREQ_16M`)
- 15 MHz (`CONFIG_ESPTOOLPY_FLASHFREQ_15M`)

## CONFIG\_ESPTOOLPY\_FLASHSIZE

Flash size

*Found in: [Serial flasher config](#)*

SPI flash size, in megabytes

Available options:

- 1 MB (`CONFIG_ESPTOOLPY_FLASHSIZE_1MB`)
- 2 MB (`CONFIG_ESPTOOLPY_FLASHSIZE_2MB`)
- 4 MB (`CONFIG_ESPTOOLPY_FLASHSIZE_4MB`)
- 8 MB (`CONFIG_ESPTOOLPY_FLASHSIZE_8MB`)
- 16 MB (`CONFIG_ESPTOOLPY_FLASHSIZE_16MB`)
- 32 MB (`CONFIG_ESPTOOLPY_FLASHSIZE_32MB`)
- 64 MB (`CONFIG_ESPTOOLPY_FLASHSIZE_64MB`)
- 128 MB (`CONFIG_ESPTOOLPY_FLASHSIZE_128MB`)

## CONFIG\_ESPTOOLPY\_HEADER\_FLASHSIZE\_UPDATE

Detect flash size when flashing bootloader

*Found in: [Serial flasher config](#)*

If this option is set, flashing the project will automatically detect the flash size of the target chip and update the bootloader image before it is flashed.

Enabling this option turns off the image protection against corruption by a SHA256 digest. Updating the bootloader image before flashing would invalidate the digest.

## CONFIG\_ESPTOOLPY\_BEFORE

Before flashing

*Found in: [Serial flasher config](#)*

Configure whether esptool.py should reset the ESP32 before flashing.

Automatic resetting depends on the RTS & DTR signals being wired from the serial port to the ESP32. Most USB development boards do this internally.

Available options:

- Reset to bootloader (CONFIG\_ESPTOOLPY\_BEFORE\_RESET)
- No reset (CONFIG\_ESPTOOLPY\_BEFORE\_NORESET)

### CONFIG\_ESPTOOLPY\_AFTER

After flashing

*Found in: [Serial flasher config](#)*

Configure whether esptool.py should reset the ESP32 after flashing.

Automatic resetting depends on the RTS & DTR signals being wired from the serial port to the ESP32. Most USB development boards do this internally.

Available options:

- Reset after flashing (CONFIG\_ESPTOOLPY\_AFTER\_RESET)
- Stay in bootloader (CONFIG\_ESPTOOLPY\_AFTER\_NORESET)

### Partition Table

Contains:

- [CONFIG\\_PARTITION\\_TABLE\\_CUSTOM\\_FILENAME](#)
- [CONFIG\\_PARTITION\\_TABLE\\_MD5](#)
- [CONFIG\\_PARTITION\\_TABLE\\_OFFSET](#)
- [CONFIG\\_PARTITION\\_TABLE\\_TYPE](#)

### CONFIG\_PARTITION\_TABLE\_TYPE

Partition Table

*Found in: [Partition Table](#)*

The partition table to flash to the ESP32. The partition table determines where apps, data and other resources are expected to be found.

The predefined partition table CSV descriptions can be found in the components/partition\_table directory. These are mostly intended for example and development use, it's expect that for production use you will copy one of these CSV files and create a custom partition CSV for your application.

Available options:

- Single factory app, no OTA (CONFIG\_PARTITION\_TABLE\_SINGLE\_APP)  
This is the default partition table, designed to fit into a 2MB or larger flash with a single 1MB app partition.  
The corresponding CSV file in the IDF directory is components/partition\_table/partitions\_singleapp.csv  
This partition table is not suitable for an app that needs OTA (over the air update) capability.
- Single factory app (large), no OTA (CONFIG\_PARTITION\_TABLE\_SINGLE\_APP\_LARGE)  
This is a variation of the default partition table, that expands the 1MB app partition size to 1.5MB to fit more code.

The corresponding CSV file in the IDF directory is `components/partition_table/partitions_singleapp_large.csv`

This partition table is not suitable for an app that needs OTA (over the air update) capability.

- **Factory app, two OTA definitions (CONFIG\_PARTITION\_TABLE\_TWO\_OTA)**  
This is a basic OTA-enabled partition table with a factory app partition plus two OTA app partitions. All are 1MB, so this partition table requires 4MB or larger flash size.  
The corresponding CSV file in the IDF directory is `components/partition_table/partitions_two_ota.csv`
- **Custom partition table CSV (CONFIG\_PARTITION\_TABLE\_CUSTOM)**  
Specify the path to the partition table CSV to use for your project.  
Consult the Partition Table section in the ESP-IDF Programmers Guide for more information.
- **Single factory app, no OTA, encrypted NVS (CONFIG\_PARTITION\_TABLE\_SINGLE\_APP\_ENCRYPTED\_NVS)**  
This is a variation of the default "Single factory app, no OTA" partition table that supports encrypted NVS when using flash encryption. See the Flash Encryption section in the ESP-IDF Programmers Guide for more information.  
The corresponding CSV file in the IDF directory is `components/partition_table/partitions_singleapp_encr_nvs.csv`
- **Single factory app (large), no OTA, encrypted NVS (CONFIG\_PARTITION\_TABLE\_SINGLE\_APP\_LARGE\_ENC\_NVS)**  
This is a variation of the "Single factory app (large), no OTA" partition table that supports encrypted NVS when using flash encryption. See the Flash Encryption section in the ESP-IDF Programmers Guide for more information.  
The corresponding CSV file in the IDF directory is `components/partition_table/partitions_singleapp_large_encr_nvs.csv`
- **Factory app, two OTA definitions, encrypted NVS (CONFIG\_PARTITION\_TABLE\_TWO\_OTA\_ENCRYPTED\_NVS)**  
This is a variation of the "Factory app, two OTA definitions" partition table that supports encrypted NVS when using flash encryption. See the Flash Encryption section in the ESP-IDF Programmers Guide for more information.  
The corresponding CSV file in the IDF directory is `components/partition_table/partitions_two_ota_encr_nvs.csv`

### CONFIG\_PARTITION\_TABLE\_CUSTOM\_FILENAME

Custom partition CSV file

*Found in:* [Partition Table](#)

Name of the custom partition CSV filename. This path is evaluated relative to the project root directory by default. However, if the absolute path for the CSV file is provided, then the absolute path is configured.

**Default value:**

- "partitions.csv"

### CONFIG\_PARTITION\_TABLE\_OFFSET

Offset of partition table

*Found in:* [Partition Table](#)

The address of partition table (by default 0x8000). Allows you to move the partition table, it gives more space for the bootloader. Note that the bootloader and app will both need to be compiled with the same PARTITION\_TABLE\_OFFSET value.

This number should be a multiple of 0x1000.

Note that partition offsets in the partition table CSV file may need to be changed if this value is set to a higher value. To have each partition offset adapt to the configured partition table offset, leave all partition

offsets blank in the CSV file.

**Default value:**

- "0x8000"

### CONFIG\_PARTITION\_TABLE\_MD5

Generate an MD5 checksum for the partition table

*Found in: Partition Table*

Generate an MD5 checksum for the partition table for protecting the integrity of the table. The generation should be turned off for legacy bootloaders which cannot recognize the MD5 checksum in the partition table.

**Default value:**

- Yes (enabled)

### Compiler options

Contains:

- *CONFIG\_COMPILER\_OPTIMIZATION\_ASSERTION\_LEVEL*
- *CONFIG\_COMPILER\_FLOAT\_LIB\_FROM*
- *CONFIG\_COMPILER\_RT\_LIB*
- *CONFIG\_COMPILER\_OPTIMIZATION\_CHECKS\_SILENT*
- *CONFIG\_COMPILER\_DISABLE\_GCC12\_WARNINGS*
- *CONFIG\_COMPILER\_DISABLE\_GCC13\_WARNINGS*
- *CONFIG\_COMPILER\_DUMP\_RTL\_FILES*
- *CONFIG\_COMPILER\_SAVE\_RESTORE\_LIBCALLS*
- *CONFIG\_COMPILER\_WARN\_WRITE\_STRINGS*
- *CONFIG\_COMPILER\_CXX\_EXCEPTIONS*
- *CONFIG\_COMPILER\_CXX\_RTTI*
- *CONFIG\_COMPILER\_OPTIMIZATION*
- *CONFIG\_COMPILER\_ORPHAN\_SECTIONS*
- *CONFIG\_COMPILER\_HIDE\_PATHS\_MACROS*
- *CONFIG\_COMPILER\_STACK\_CHECK\_MODE*

### CONFIG\_COMPILER\_OPTIMIZATION

Optimization Level

*Found in: Compiler options*

This option sets compiler optimization level (gcc -O argument) for the app.

- The "Debug" setting will add the -Og flag to CFLAGS.
- The "Size" setting will add the -Os flag to CFLAGS.
- The "Performance" setting will add the -O2 flag to CFLAGS.
- The "None" setting will add the -O0 flag to CFLAGS.

The "Size" setting cause the compiled code to be smaller and faster, but may lead to difficulties of correlating code addresses to source file lines when debugging.

The "Performance" setting causes the compiled code to be larger and faster, but will be easier to correlated code addresses to source file lines.

"None" with -O0 produces compiled code without optimization.

Note that custom optimization levels may be unsupported.

Compiler optimization for the IDF bootloader is set separately, see the `BOOT-LOADER_COMPILER_OPTIMIZATION` setting.



Available options:

- Debug (-Og) (CONFIG\_COMPILER\_OPTIMIZATION\_DEBUG)
- Optimize for size (-Os) (CONFIG\_COMPILER\_OPTIMIZATION\_SIZE)
- Optimize for performance (-O2) (CONFIG\_COMPILER\_OPTIMIZATION\_PERF)
- Debug without optimization (-O0) (CONFIG\_COMPILER\_OPTIMIZATION\_NONE)

### CONFIG\_COMPILER\_OPTIMIZATION\_ASSERTION\_LEVEL

Assertion level

*Found in: Compiler options*

Assertions can be:

- Enabled. Failure will print verbose assertion details. This is the default.
- Set to "silent" to save code size (failed assertions will abort() but user needs to use the aborting address to find the line number with the failed assertion.)
- Disabled entirely (not recommended for most configurations.) -DNDEBUG is added to CPPFLAGS in this case.

Available options:

- Enabled (CONFIG\_COMPILER\_OPTIMIZATION\_ASSERTIONS\_ENABLE)  
Enable assertions. Assertion content and line number will be printed on failure.
- Silent (saves code size) (CONFIG\_COMPILER\_OPTIMIZATION\_ASSERTIONS\_SILENT)  
Enable silent assertions. Failed assertions will abort(), user needs to use the aborting address to find the line number with the failed assertion.
- Disabled (sets -DNDEBUG) (CONFIG\_COMPILER\_OPTIMIZATION\_ASSERTIONS\_DISABLE)  
If assertions are disabled, -DNDEBUG is added to CPPFLAGS.

### CONFIG\_COMPILER\_FLOAT\_LIB\_FROM

Compiler float lib source

*Found in: Compiler options*

In the soft-fp part of libgcc, riscv version is written in C, and handles all edge cases in IEEE754, which makes it larger and performance is slow.

RVfplib is an optimized RISC-V library for FP arithmetic on 32-bit integer processors, for single and double-precision FP. RVfplib is "fast", but it has a few exceptions from IEEE 754 compliance.

Available options:

- libgcc (CONFIG\_COMPILER\_FLOAT\_LIB\_FROM\_GCCLIB)
- librvfp (CONFIG\_COMPILER\_FLOAT\_LIB\_FROM\_RVFPLIB)

### CONFIG\_COMPILER\_OPTIMIZATION\_CHECKS\_SILENT

Disable messages in ESP\_RETURN\_ON\_\* and ESP\_EXIT\_ON\_\* macros

*Found in: Compiler options*

If enabled, the error messages will be discarded in following check macros: -  
ESP\_RETURN\_ON\_ERROR - ESP\_EXIT\_ON\_ERROR - ESP\_RETURN\_ON\_FALSE -  
ESP\_EXIT\_ON\_FALSE

**Default value:**

- No (disabled)

## CONFIG\_COMPILER\_HIDE\_PATHS\_MACROS

Replace ESP-IDF and project paths in binaries

*Found in: [Compiler options](#)*

When expanding the `__FILE__` and `__BASE_FILE__` macros, replace paths inside ESP-IDF with paths relative to the placeholder string "IDF", and convert paths inside the project directory to relative paths.

This allows building the project with assertions or other code that embeds file paths, without the binary containing the exact path to the IDF or project directories.

This option passes `-macro-prefix-map` options to the GCC command line. To replace additional paths in your binaries, modify the project `CMakeLists.txt` file to pass custom `-macro-prefix-map` or `-file-prefix-map` arguments.

**Default value:**

- Yes (enabled)

## CONFIG\_COMPILER\_CXX\_EXCEPTIONS

Enable C++ exceptions

*Found in: [Compiler options](#)*

Enabling this option compiles all IDF C++ files with exception support enabled.

Disabling this option disables C++ exception support in all compiled files, and any `libstdc++` code which throws an exception will abort instead.

Enabling this option currently adds an additional ~500 bytes of heap overhead when an exception is thrown in user code for the first time.

**Default value:**

- No (disabled)

Contains:

- [CONFIG\\_COMPILER\\_CXX\\_EXCEPTIONS\\_EMG\\_POOL\\_SIZE](#)

## CONFIG\_COMPILER\_CXX\_EXCEPTIONS\_EMG\_POOL\_SIZE

Emergency Pool Size

*Found in: [Compiler options](#) > [CONFIG\\_COMPILER\\_CXX\\_EXCEPTIONS](#)*

Size (in bytes) of the emergency memory pool for C++ exceptions. This pool will be used to allocate memory for thrown exceptions when there is not enough memory on the heap.

**Default value:**

- 0 if [CONFIG\\_COMPILER\\_CXX\\_EXCEPTIONS](#)

## CONFIG\_COMPILER\_CXX\_RTTI

Enable C++ run-time type info (RTTI)

*Found in: [Compiler options](#)*

Enabling this option compiles all C++ files with RTTI support enabled. This increases binary size (typically by tens of kB) but allows using `dynamic_cast` conversion and `typeid` operator.

**Default value:**

- No (disabled)

## CONFIG\_COMPILER\_STACK\_CHECK\_MODE

Stack smashing protection mode

*Found in: [Compiler options](#)*

Stack smashing protection mode. Emit extra code to check for buffer overflows, such as stack smashing attacks. This is done by adding a guard variable to functions with vulnerable objects. The guards are initialized when a function is entered and then checked when the function exits. If a guard check fails, program is halted. Protection has the following modes:

- In NORMAL mode (GCC flag: `-fstack-protector`) only functions that call `alloca`, and functions with buffers larger than 8 bytes are protected.
- STRONG mode (GCC flag: `-fstack-protector-strong`) is like NORMAL, but includes additional functions to be protected -- those that have local array definitions, or have references to local frame addresses.
- In OVERALL mode (GCC flag: `-fstack-protector-all`) all functions are protected.

Modes have the following impact on code performance and coverage:

- performance: NORMAL > STRONG > OVERALL
- coverage: NORMAL < STRONG < OVERALL

The performance impact includes increasing the amount of stack memory required for each task.

Available options:

- None (CONFIG\_COMPILER\_STACK\_CHECK\_MODE\_NONE)
- Normal (CONFIG\_COMPILER\_STACK\_CHECK\_MODE\_NORM)
- Strong (CONFIG\_COMPILER\_STACK\_CHECK\_MODE\_STRONG)
- Overall (CONFIG\_COMPILER\_STACK\_CHECK\_MODE\_ALL)

## CONFIG\_COMPILER\_WARN\_WRITE\_STRINGS

Enable `-Wwrite-strings` warning flag

*Found in: [Compiler options](#)*

Adds `-Wwrite-strings` flag for the C/C++ compilers.

For C, this gives string constants the type `const char []` so that copying the address of one into a non-const `char *` pointer produces a warning. This warning helps to find at compile time code that tries to write into a string constant.

For C++, this warns about the deprecated conversion from string literals to `char *`.

**Default value:**

- No (disabled)

## CONFIG\_COMPILER\_SAVE\_RESTORE\_LIBCALLS

Enable `-msave-restore` flag to reduce code size

*Found in: [Compiler options](#)*

Adds `-msave-restore` to C/C++ compilation flags.

When this flag is enabled, compiler will call library functions to save/restore registers in function prologues/epilogues. This results in lower overall code size, at the expense of slightly reduced performance.

This option can be enabled for RISC-V targets only.

### CONFIG\_COMPILER\_DISABLE\_GCC12\_WARNINGS

Disable new warnings introduced in GCC 12

*Found in:* [Compiler options](#)

Enable this option if use GCC 12 or newer, and want to disable warnings which don't appear with GCC 11.

**Default value:**

- No (disabled)

### CONFIG\_COMPILER\_DISABLE\_GCC13\_WARNINGS

Disable new warnings introduced in GCC 13

*Found in:* [Compiler options](#)

Enable this option if use GCC 13 or newer, and want to disable warnings which don't appear with GCC 12.

**Default value:**

- No (disabled)

### CONFIG\_COMPILER\_DUMP\_RTL\_FILES

Dump RTL files during compilation

*Found in:* [Compiler options](#)

If enabled, RTL files will be produced during compilation. These files can be used by other tools, for example to calculate call graphs.

### CONFIG\_COMPILER\_RT\_LIB

Compiler runtime library

*Found in:* [Compiler options](#)

Select runtime library to be used by compiler. - GCC toolchain supports libgcc only. - Clang allows to choose between libgcc or libclang\_rt. - For host builds ("linux" target), uses the default library.

Available options:

- libgcc (CONFIG\_COMPILER\_RT\_LIB\_GCCLIB)
- libclang\_rt (CONFIG\_COMPILER\_RT\_LIB\_CLANGRT)
- Host (CONFIG\_COMPILER\_RT\_LIB\_HOST)

### CONFIG\_COMPILER\_ORPHAN\_SECTIONS

Orphan sections handling

*Found in:* [Compiler options](#)

If the linker finds orphan sections, it attempts to place orphan sections after sections of the same attribute such as code vs data, loadable vs non-loadable, etc. That means that orphan sections could be placed between sections defined in IDF linker scripts. This could lead to corruption of the binary image. Configure the linker action here.

Available options:

- Place with warning (CONFIG\_COMPILER\_ORPHAN\_SECTIONS\_WARNING)  
Places orphan sections without a warning message.

- Place silently (CONFIG\_COMPILER\_ORPHAN\_SECTIONS\_PLACE)  
Places orphan sections without a warning/error message.

## Component config

Contains:

- *ADC and ADC Calibration*
- *Application Level Tracing*
- *Bluetooth*
- *Common ESP-related*
- *Console Library*
- *Core dump*
- *Driver Configurations*
- *eFuse Bit Manager*
- *CONFIG\_BLE\_MESH*
- *ESP HTTP client*
- *ESP HTTPS OTA*
- *ESP HTTPS server*
- *ESP NETIF Adapter*
- *ESP PSRAM*
- *ESP Ringbuf*
- *ESP System Settings*
- *ESP Timer (High Resolution Timer)*
- *ESP-Driver:Analog Comparator Configurations*
- *ESP-Driver:Camera Controller Configurations*
- *ESP-Driver:DAC Configurations*
- *ESP-Driver:GPIO Configurations*
- *ESP-Driver:GPTimer Configurations*
- *ESP-Driver:I2C Configurations*
- *ESP-Driver:I2S Configurations*
- *ESP-Driver:ISP Configurations*
- *ESP-Driver:JPEG-Codec Configurations*
- *ESP-Driver:LEDC Configurations*
- *ESP-Driver:MCPWM Configurations*
- *ESP-Driver:Parallel IO Configurations*
- *ESP-Driver:PCNT Configurations*
- *ESP-Driver:RMT Configurations*
- *ESP-Driver:Sigma Delta Modulator Configurations*
- *ESP-Driver:SPI Configurations*
- *ESP-Driver:Temperature Sensor Configurations*
- *ESP-Driver:Touch Sensor Configurations*
- *ESP-Driver:UART Configurations*
- *ESP-Driver:USB Serial/JTAG Configuration*
- *ESP-MQTT Configurations*
- *ESP-TLS*
- *Ethernet*
- *Event Loop Library*
- *FAT Filesystem support*
- *FreeRTOS*
- *GDB Stub*
- *Hardware Abstraction Layer (HAL) and Low Level (LL)*
- *Hardware Settings*
- *Heap memory debugging*
- *HTTP Server*
- *IEEE 802.15.4*
- *IPC (Inter-Processor Call)*
- *LCD and Touch Panel*

- *Log output*
- *LWIP*
- *Main Flash configuration*
- *mbedTLS*
- *Newlib*
- *NVS*
- *NVS Security Provider*
- *OpenThread*
- *Partition API Configuration*
- *PHY*
- *Power Management*
- *Protocomm*
- *PThreads*
- *SoC Settings*
- *SPI Flash driver*
- *SPIFFS Configuration*
- *TCP Transport*
- *Ultra Low Power (ULP) Co-processor*
- *Unity unit testing library*
- *USB-OTG*
- *Virtual file system*
- *Wear Levelling*
- *Wi-Fi*
- *Wi-Fi Provisioning Manager*
- *Wireless Coexistence*

**Application Level Tracing** Contains:

- *CONFIG\_APPTRACE\_DESTINATION1*
- *CONFIG\_APPTRACE\_DESTINATION2*
- *FreeRTOS System View Tracing*
- *CONFIG\_APPTRACE\_GCOV\_ENABLE*
- *CONFIG\_APPTRACE\_BUF\_SIZE*
- *CONFIG\_APPTRACE\_PENDING\_DATA\_SIZE\_MAX*
- *CONFIG\_APPTRACE\_POSTMORTEM\_FLUSH\_THRESH*
- *CONFIG\_APPTRACE\_ONPANIC\_HOST\_FLUSH\_TMO*
- *CONFIG\_APPTRACE\_UART\_BAUDRATE*
- *CONFIG\_APPTRACE\_UART\_RX\_GPIO*
- *CONFIG\_APPTRACE\_UART\_RX\_BUFF\_SIZE*
- *CONFIG\_APPTRACE\_UART\_TASK\_PRIO*
- *CONFIG\_APPTRACE\_UART\_TX\_MSG\_SIZE*
- *CONFIG\_APPTRACE\_UART\_TX\_GPIO*
- *CONFIG\_APPTRACE\_UART\_TX\_BUFF\_SIZE*

**CONFIG\_APPTRACE\_DESTINATION1**

Data Destination 1

*Found in: Component config > Application Level Tracing*

Select destination for application trace: JTAG or none (to disable).

Available options:

- JTAG (CONFIG\_APPTRACE\_DEST\_JTAG)
- None (CONFIG\_APPTRACE\_DEST\_NONE)

### CONFIG\_APPTRACE\_DESTINATION2

Data Destination 2

*Found in: [Component config](#) > [Application Level Tracing](#)*

Select destination for application trace: UART(XX) or none (to disable).

Available options:

- UART0 (CONFIG\_APPTRACE\_DEST\_UART0)
- UART1 (CONFIG\_APPTRACE\_DEST\_UART1)
- UART2 (CONFIG\_APPTRACE\_DEST\_UART2)
- USB\_CDC (CONFIG\_APPTRACE\_DEST\_USB\_CDC)
- None (CONFIG\_APPTRACE\_DEST\_UART\_NONE)

### CONFIG\_APPTRACE\_UART\_TX\_GPIO

UART TX on GPIO#

*Found in: [Component config](#) > [Application Level Tracing](#)*

This GPIO is used for UART TX pin.

### CONFIG\_APPTRACE\_UART\_RX\_GPIO

UART RX on GPIO#

*Found in: [Component config](#) > [Application Level Tracing](#)*

This GPIO is used for UART RX pin.

### CONFIG\_APPTRACE\_UART\_BAUDRATE

UART baud rate

*Found in: [Component config](#) > [Application Level Tracing](#)*

This baud rate is used for UART.

The app's maximum baud rate depends on the UART clock source. If Power Management is disabled, the UART clock source is the APB clock and all baud rates in the available range will be sufficiently accurate. If Power Management is enabled, REF\_TICK clock source is used so the baud rate is divided from 1MHz. Baud rates above 1Mbps are not possible and values between 500Kbps and 1Mbps may not be accurate.

### CONFIG\_APPTRACE\_UART\_RX\_BUFF\_SIZE

UART RX ring buffer size

*Found in: [Component config](#) > [Application Level Tracing](#)*

Size of the UART input ring buffer. This size related to the baudrate, system tick frequency and amount of data to transfer. The data placed to this buffer before sent out to the interface.

### CONFIG\_APPTRACE\_UART\_TX\_BUFF\_SIZE

UART TX ring buffer size

*Found in: [Component config](#) > [Application Level Tracing](#)*

Size of the UART output ring buffer. This size related to the baudrate, system tick frequency and amount of data to transfer.

**CONFIG\_APPTRACE\_UART\_TX\_MSG\_SIZE**

UART TX message size

*Found in: Component config > Application Level Tracing*

Maximum size of the single message to transfer.

**CONFIG\_APPTRACE\_UART\_TASK\_PRIO**

UART Task Priority

*Found in: Component config > Application Level Tracing*

UART task priority. In case of high events rate, this parameter could be changed up to (config-MAX\_PRIORITIES-1).

**Range:**

- from 1 to 32

**Default value:**

- 1

**CONFIG\_APPTRACE\_ONPANIC\_HOST\_FLUSH\_TMO**

Timeout for flushing last trace data to host on panic

*Found in: Component config > Application Level Tracing*

Timeout for flushing last trace data to host in case of panic. In ms. Use -1 to disable timeout and wait forever.

**CONFIG\_APPTRACE\_POSTMORTEM\_FLUSH\_THRESH**

Threshold for flushing last trace data to host on panic

*Found in: Component config > Application Level Tracing*

Threshold for flushing last trace data to host on panic in post-mortem mode. This is minimal amount of data needed to perform flush. In bytes.

**CONFIG\_APPTRACE\_BUF\_SIZE**

Size of the apptrace buffer

*Found in: Component config > Application Level Tracing*

Size of the memory buffer for trace data in bytes.

**CONFIG\_APPTRACE\_PENDING\_DATA\_SIZE\_MAX**

Size of the pending data buffer

*Found in: Component config > Application Level Tracing*

Size of the buffer for events in bytes. It is useful for buffering events from the time critical code (scheduler, ISRs etc). If this parameter is 0 then events will be discarded when main HW buffer is full.

**FreeRTOS SystemView Tracing** Contains:

- *CONFIG\_APPTRACE\_SV\_CPU*
- *CONFIG\_APPTRACE\_SV\_EVT\_ISR\_ENTER\_ENABLE*
- *CONFIG\_APPTRACE\_SV\_EVT\_ISR\_EXIT\_ENABLE*
- *CONFIG\_APPTRACE\_SV\_EVT\_ISR\_TO\_SCHED\_ENABLE*
- *CONFIG\_APPTRACE\_SV\_MAX\_TASKS*



- [CONFIG\\_APPTRACE\\_SV\\_EVT\\_IDLE\\_ENABLE](#)
- [CONFIG\\_APPTRACE\\_SV\\_ENABLE](#)
- [CONFIG\\_APPTRACE\\_SV\\_EVT\\_TASK\\_CREATE\\_ENABLE](#)
- [CONFIG\\_APPTRACE\\_SV\\_EVT\\_TASK\\_START\\_EXEC\\_ENABLE](#)
- [CONFIG\\_APPTRACE\\_SV\\_EVT\\_TASK\\_START\\_READY\\_ENABLE](#)
- [CONFIG\\_APPTRACE\\_SV\\_EVT\\_TASK\\_STOP\\_EXEC\\_ENABLE](#)
- [CONFIG\\_APPTRACE\\_SV\\_EVT\\_TASK\\_STOP\\_READY\\_ENABLE](#)
- [CONFIG\\_APPTRACE\\_SV\\_EVT\\_TASK\\_TERMINATE\\_ENABLE](#)
- [CONFIG\\_APPTRACE\\_SV\\_EVT\\_TIMER\\_ENTER\\_ENABLE](#)
- [CONFIG\\_APPTRACE\\_SV\\_EVT\\_TIMER\\_EXIT\\_ENABLE](#)
- [CONFIG\\_APPTRACE\\_SV\\_TS\\_SOURCE](#)
- [CONFIG\\_APPTRACE\\_SV\\_EVT\\_OVERFLOW\\_ENABLE](#)
- [CONFIG\\_APPTRACE\\_SV\\_BUF\\_WAIT\\_TMO](#)

### **CONFIG\_APPTRACE\_SV\_ENABLE**

SystemView Tracing Enable

*Found in: [Component config](#) > [Application Level Tracing](#) > [FreeRTOS SystemView Tracing](#)*

Enables support for SEGGER SystemView tracing functionality.

### **CONFIG\_APPTRACE\_SV\_DEST**

SystemView destination

*Found in: [Component config](#) > [Application Level Tracing](#) > [FreeRTOS SystemView Tracing](#) > [CONFIG\\_APPTRACE\\_SV\\_ENABLE](#)*

SystemView will transfer data through defined interface.

Available options:

- Data destination JTAG ([CONFIG\\_APPTRACE\\_SV\\_DEST\\_JTAG](#))  
Send SEGGER SystemView events through JTAG interface.
- Data destination UART ([CONFIG\\_APPTRACE\\_SV\\_DEST\\_UART](#))  
Send SEGGER SystemView events through UART interface.

### **CONFIG\_APPTRACE\_SV\_CPU**

CPU to trace

*Found in: [Component config](#) > [Application Level Tracing](#) > [FreeRTOS SystemView Tracing](#)*

Define the CPU to trace by SystemView.

Available options:

- CPU0 ([CONFIG\\_APPTRACE\\_SV\\_DEST\\_CPU\\_0](#))  
Send SEGGER SystemView events for Pro CPU.
- CPU1 ([CONFIG\\_APPTRACE\\_SV\\_DEST\\_CPU\\_1](#))  
Send SEGGER SystemView events for App CPU.

### **CONFIG\_APPTRACE\_SV\_TS\_SOURCE**

Timer to use as timestamp source

*Found in: [Component config](#) > [Application Level Tracing](#) > [FreeRTOS SystemView Tracing](#)*

SystemView needs to use a hardware timer as the source of timestamps when tracing. This option selects the timer for it.

Available options:

- CPU cycle counter (CCOUNT) (CONFIG\_APPTRACE\_SV\_TS\_SOURCE\_CCOUNT)
- General Purpose Timer (Timer Group) (CONFIG\_APPTRACE\_SV\_TS\_SOURCE\_GPTIMER)
- esp\_timer high resolution timer (CONFIG\_APPTRACE\_SV\_TS\_SOURCE\_ESP\_TIMER)

### **CONFIG\_APPTRACE\_SV\_MAX\_TASKS**

Maximum supported tasks

*Found in: Component config > Application Level Tracing > FreeRTOS SystemView Tracing*

Configures maximum supported tasks in sysview debug

### **CONFIG\_APPTRACE\_SV\_BUF\_WAIT\_TMO**

Trace buffer wait timeout

*Found in: Component config > Application Level Tracing > FreeRTOS SystemView Tracing*

Configures timeout (in us) to wait for free space in trace buffer. Set to -1 to wait forever and avoid lost events.

### **CONFIG\_APPTRACE\_SV\_EVT\_OVERFLOW\_ENABLE**

Trace Buffer Overflow Event

*Found in: Component config > Application Level Tracing > FreeRTOS SystemView Tracing*

Enables "Trace Buffer Overflow" event.

### **CONFIG\_APPTRACE\_SV\_EVT\_ISR\_ENTER\_ENABLE**

ISR Enter Event

*Found in: Component config > Application Level Tracing > FreeRTOS SystemView Tracing*

Enables "ISR Enter" event.

### **CONFIG\_APPTRACE\_SV\_EVT\_ISR\_EXIT\_ENABLE**

ISR Exit Event

*Found in: Component config > Application Level Tracing > FreeRTOS SystemView Tracing*

Enables "ISR Exit" event.

### **CONFIG\_APPTRACE\_SV\_EVT\_ISR\_TO\_SCHED\_ENABLE**

ISR Exit to Scheduler Event

*Found in: Component config > Application Level Tracing > FreeRTOS SystemView Tracing*

Enables "ISR to Scheduler" event.

### **CONFIG\_APPTRACE\_SV\_EVT\_TASK\_START\_EXEC\_ENABLE**

Task Start Execution Event

*Found in: [Component config](#) > [Application Level Tracing](#) > [FreeRTOS System View Tracing](#)*

Enables "Task Start Execution" event.

### **CONFIG\_APPTRACE\_SV\_EVT\_TASK\_STOP\_EXEC\_ENABLE**

Task Stop Execution Event

*Found in: [Component config](#) > [Application Level Tracing](#) > [FreeRTOS System View Tracing](#)*

Enables "Task Stop Execution" event.

### **CONFIG\_APPTRACE\_SV\_EVT\_TASK\_START\_READY\_ENABLE**

Task Start Ready State Event

*Found in: [Component config](#) > [Application Level Tracing](#) > [FreeRTOS System View Tracing](#)*

Enables "Task Start Ready State" event.

### **CONFIG\_APPTRACE\_SV\_EVT\_TASK\_STOP\_READY\_ENABLE**

Task Stop Ready State Event

*Found in: [Component config](#) > [Application Level Tracing](#) > [FreeRTOS System View Tracing](#)*

Enables "Task Stop Ready State" event.

### **CONFIG\_APPTRACE\_SV\_EVT\_TASK\_CREATE\_ENABLE**

Task Create Event

*Found in: [Component config](#) > [Application Level Tracing](#) > [FreeRTOS System View Tracing](#)*

Enables "Task Create" event.

### **CONFIG\_APPTRACE\_SV\_EVT\_TASK\_TERMINATE\_ENABLE**

Task Terminate Event

*Found in: [Component config](#) > [Application Level Tracing](#) > [FreeRTOS System View Tracing](#)*

Enables "Task Terminate" event.

### **CONFIG\_APPTRACE\_SV\_EVT\_IDLE\_ENABLE**

System Idle Event

*Found in: [Component config](#) > [Application Level Tracing](#) > [FreeRTOS System View Tracing](#)*

Enables "System Idle" event.

### **CONFIG\_APPTRACE\_SV\_EVT\_TIMER\_ENTER\_ENABLE**

Timer Enter Event

*Found in: [Component config](#) > [Application Level Tracing](#) > [FreeRTOS System View Tracing](#)*

Enables "Timer Enter" event.

### CONFIG\_APPTRACE\_SV\_EVT\_TIMER\_EXIT\_ENABLE

Timer Exit Event

*Found in: Component config > Application Level Tracing > FreeRTOS SystemView Tracing*

Enables "Timer Exit" event.

### CONFIG\_APPTRACE\_GCOV\_ENABLE

GCOV to Host Enable

*Found in: Component config > Application Level Tracing*

Enables support for GCOV data transfer to host.

### CONFIG\_APPTRACE\_GCOV\_DUMP\_TASK\_STACK\_SIZE

Gcov dump task stack size

*Found in: Component config > Application Level Tracing > CONFIG\_APPTRACE\_GCOV\_ENABLE*

Configures stack size of Gcov dump task

**Default value:**

- 2048 if *CONFIG\_APPTRACE\_GCOV\_ENABLE*

**Bluetooth** Contains:

- *Bluedroid Options*
- *CONFIG\_BT\_ENABLED*
- *Common Options*
- *Controller Options*
- *CONFIG\_BT\_HCI\_LOG\_DEBUG\_EN*
- *NimBLE Options*
- *CONFIG\_BT\_RELEASE\_IRAM*

### CONFIG\_BT\_ENABLED

Bluetooth

*Found in: Component config > Bluetooth*

Select this option to enable Bluetooth and show the submenu with Bluetooth configuration choices.

### CONFIG\_BT\_HOST

Host

*Found in: Component config > Bluetooth > CONFIG\_BT\_ENABLED*

This helps to choose Bluetooth host stack

Available options:

- **Bluedroid - Dual-mode** (*CONFIG\_BT\_BLUEDROID\_ENABLED*)  
This option is recommended for classic Bluetooth or for dual-mode usecases
- **NimBLE - BLE only** (*CONFIG\_BT\_NIMBLE\_ENABLED*)  
This option is recommended for BLE only usecases to save on memory
- **Disabled** (*CONFIG\_BT\_CONTROLLER\_ONLY*)  
This option is recommended when you want to communicate directly with the controller (without any host) or when you are using any other host stack not supported by Espressif (not mentioned here).

## CONFIG\_BT\_CONTROLLER

Controller

Found in: *Component config > Bluetooth > CONFIG\_BT\_ENABLED*

This helps to choose Bluetooth controller stack

Available options:

- Enabled (CONFIG\_BT\_CONTROLLER\_ENABLED)  
This option is recommended for Bluetooth controller usecases
- Disabled (CONFIG\_BT\_CONTROLLER\_DISABLED)  
This option is recommended for Bluetooth Host only usecases

**Bluedroid Options** Contains:

- *CONFIG\_BT\_BLE\_HOST\_QUEUE\_CONG\_CHECK*
- *CONFIG\_BT\_BLUEDROID\_MEM\_DEBUG*
- *CONFIG\_BT\_BTU\_TASK\_STACK\_SIZE*
- *CONFIG\_BT\_BTC\_TASK\_STACK\_SIZE*
- *CONFIG\_BT\_BLE\_ENABLED*
- *BT\_DEBUG\_LOG\_LEVEL*
- *CONFIG\_BT\_ACL\_CONNECTIONS*
- *CONFIG\_BT\_SMP\_MAX\_BONDS*
- *CONFIG\_BT\_ALLOCATION\_FROM\_SPIRAM\_FIRST*
- *CONFIG\_BT\_CLASSIC\_ENABLED*
- *CONFIG\_BT\_HID\_ENABLED*
- *CONFIG\_BT\_STACK\_NO\_LOG*
- *CONFIG\_BT\_BLE\_42\_FEATURES\_SUPPORTED*
- *CONFIG\_BT\_BLE\_50\_FEATURES\_SUPPORTED*
- *CONFIG\_BT\_BLE\_HIGH\_DUTY\_ADV\_INTERVAL*
- *CONFIG\_BT\_MULTI\_CONNECTION\_ENBALE*
- *CONFIG\_BT\_BLE\_FEAT\_PERIODIC\_ADV\_SYNC\_TRANSFER*
- *CONFIG\_BT\_BLE\_FEAT\_CREATE\_SYNC\_ENH*
- *CONFIG\_BT\_BLUEDROID\_ESP\_COEX\_VSC*
- *CONFIG\_BT\_BLE\_FEAT\_PERIODIC\_ADV\_ENH*
- *CONFIG\_BT\_MAX\_DEVICE\_NAME\_LEN*
- *CONFIG\_BT\_BLE\_ACT\_SCAN\_REP\_ADV\_SCAN*
- *CONFIG\_BT\_BLUEDROID\_PINNED\_TO\_CORE\_CHOICE*
- *CONFIG\_BT\_BLE\_ESTAB\_LINK\_CONN\_TOUT*
- *CONFIG\_BT\_BLE\_RPA\_TIMEOUT*
- *CONFIG\_BT\_BLE\_RPA\_SUPPORTED*
- *CONFIG\_BT\_BLE\_DYNAMIC\_ENV\_MEMORY*
- *CONFIG\_BT\_HFP\_WBS\_ENABLE*

## CONFIG\_BT\_BTC\_TASK\_STACK\_SIZE

Bluetooth event (callback to application) task stack size

Found in: *Component config > Bluetooth > Bluedroid Options*

This select btc task stack size

**Default value:**

- 3072 if *CONFIG\_BT\_BLUEDROID\_ENABLED* && *CONFIG\_BT\_BLUEDROID\_ENABLED*

## CONFIG\_BT\_BLUEDROID\_PINNED\_TO\_CORE\_CHOICE

The cpu core which Bluetooth run

Found in: *Component config > Bluetooth > Bluetooth Options*

Which the cpu core to run Bluetooth. Can choose core0 and core1. Can not specify no-affinity.

Available options:

- Core 0 (PRO CPU) (`CONFIG_BT_BLUEDROID_PINNED_TO_CORE_0`)
- Core 1 (APP CPU) (`CONFIG_BT_BLUEDROID_PINNED_TO_CORE_1`)

### CONFIG\_BT\_BTU\_TASK\_STACK\_SIZE

Bluetooth Bluetooth Host Stack task stack size

Found in: *Component config > Bluetooth > Bluetooth Options*

This select btu task stack size

**Default value:**

- 4352 if `CONFIG_BT_BLUEDROID_ENABLED` && `CONFIG_BT_BLUEDROID_ENABLED`

### CONFIG\_BT\_BLUEDROID\_MEM\_DEBUG

Bluetooth memory debug

Found in: *Component config > Bluetooth > Bluetooth Options*

Bluetooth memory debug

**Default value:**

- No (disabled) if `CONFIG_BT_BLUEDROID_ENABLED` && `CONFIG_BT_BLUEDROID_ENABLED`

### CONFIG\_BT\_BLUEDROID\_ESP\_COEX\_VSC

Enable Espressif Vendor-specific HCI commands for coexist status configuration

Found in: *Component config > Bluetooth > Bluetooth Options*

Enable Espressif Vendor-specific HCI commands for coexist status configuration

**Default value:**

- Yes (enabled) if `CONFIG_BT_BLUEDROID_ENABLED` && `CONFIG_BT_BLUEDROID_ENABLED`

### CONFIG\_BT\_CLASSIC\_ENABLED

Classic Bluetooth

Found in: *Component config > Bluetooth > Bluetooth Options*

For now this option needs "SMP\_ENABLE" to be set to yes

**Default value:**

- No (disabled) if `CONFIG_BT_BLUEDROID_ENABLED` && `((CONFIG_BT_CONTROLLER_ENABLED && SOC_BT_CLASSIC_SUPPORTED) || CONFIG_BT_CONTROLLER_DISABLED)` && `CONFIG_BT_BLUEDROID_ENABLED`

## CONFIG\_BT\_ENC\_KEY\_SIZE\_CTRL\_ENABLED

configure encryption key size

*Found in: Component config > Bluetooth > Bluebird Options > CONFIG\_BT\_CLASSIC\_ENABLED*

This chooses the support status of configuring encryption key size

Available options:

- Supported by standard HCI command (CONFIG\_BT\_ENC\_KEY\_SIZE\_CTRL\_STD)
- Supported by Vendor-specific HCI command (CONFIG\_BT\_ENC\_KEY\_SIZE\_CTRL\_VSC)
- Not supported (CONFIG\_BT\_ENC\_KEY\_SIZE\_CTRL\_NONE)

## CONFIG\_BT\_CLASSIC\_BQB\_ENABLED

Host Qualification support for Classic Bluetooth

*Found in: Component config > Bluetooth > Bluebird Options > CONFIG\_BT\_CLASSIC\_ENABLED*

This enables functionalities of Host qualification for Classic Bluetooth.

**Default value:**

- No (disabled) if *CONFIG\_BT\_CLASSIC\_ENABLED* && *CONFIG\_BT\_BLUEBIRD\_ENABLED*

## CONFIG\_BT\_A2DP\_ENABLE

A2DP

*Found in: Component config > Bluetooth > Bluebird Options > CONFIG\_BT\_CLASSIC\_ENABLED*

Advanced Audio Distribution Profile

**Default value:**

- No (disabled) if *CONFIG\_BT\_CLASSIC\_ENABLED* && *CONFIG\_BT\_BLUEBIRD\_ENABLED*

## CONFIG\_BT\_SPP\_ENABLED

SPP

*Found in: Component config > Bluetooth > Bluebird Options > CONFIG\_BT\_CLASSIC\_ENABLED*

This enables the Serial Port Profile

**Default value:**

- No (disabled) if *CONFIG\_BT\_CLASSIC\_ENABLED* && *CONFIG\_BT\_BLUEBIRD\_ENABLED*

## CONFIG\_BT\_L2CAP\_ENABLED

BT L2CAP

*Found in: Component config > Bluetooth > Bluebird Options > CONFIG\_BT\_CLASSIC\_ENABLED*

This enables the Logical Link Control and Adaptation Layer Protocol. Only supported classic bluetooth.

**Default value:**

- No (disabled) if *CONFIG\_BT\_CLASSIC\_ENABLED* && *CONFIG\_BT\_BLUEBIRD\_ENABLED*

## CONFIG\_BT\_HFP\_ENABLE

Hands Free/Handset Profile

*Found in: Component config > Bluetooth > Bluebird Options > CONFIG\_BT\_CLASSIC\_ENABLED*

Hands Free Unit and Audio Gateway can be included simultaneously but they cannot run simultaneously due to internal limitations.

**Default value:**

- No (disabled) if `CONFIG_BT_CLASSIC_ENABLED` && `CONFIG_BT_BLUEBIRD_ENABLED`

Contains:

- `CONFIG_BT_HFP_AG_ENABLE`
- `CONFIG_BT_HFP_AUDIO_DATA_PATH`
- `CONFIG_BT_HFP_CLIENT_ENABLE`

## CONFIG\_BT\_HFP\_CLIENT\_ENABLE

Hands Free Unit

*Found in: Component config > Bluetooth > Bluebird Options > CONFIG\_BT\_CLASSIC\_ENABLED > CONFIG\_BT\_HFP\_ENABLE*

**Default value:**

- Yes (enabled) if `CONFIG_BT_HFP_ENABLE` && `CONFIG_BT_BLUEBIRD_ENABLED`

## CONFIG\_BT\_HFP\_AG\_ENABLE

Audio Gateway

*Found in: Component config > Bluetooth > Bluebird Options > CONFIG\_BT\_CLASSIC\_ENABLED > CONFIG\_BT\_HFP\_ENABLE*

**Default value:**

- Yes (enabled) if `CONFIG_BT_HFP_ENABLE` && `CONFIG_BT_BLUEBIRD_ENABLED`

## CONFIG\_BT\_HFP\_AUDIO\_DATA\_PATH

audio(SCO) data path

*Found in: Component config > Bluetooth > Bluebird Options > CONFIG\_BT\_CLASSIC\_ENABLED > CONFIG\_BT\_HFP\_ENABLE*

SCO data path, i.e. HCI or PCM. This option is set using API "esp\_bredr\_sco\_datapath\_set" in Bluetooth host. Default SCO data path can also be set in Bluetooth Controller.

Available options:

- PCM (`CONFIG_BT_HFP_AUDIO_DATA_PATH_PCM`)
- HCI (`CONFIG_BT_HFP_AUDIO_DATA_PATH_HCI`)

## CONFIG\_BT\_HFP\_WBS\_ENABLE

Wide Band Speech

*Found in: Component config > Bluetooth > Bluebird Options*

This enables Wide Band Speech. Should disable it when SCO data path is PCM. Otherwise there will be no data transmitted via GPIOs.

**Default value:**



- Yes (enabled) if `CONFIG_BT_HFP_AUDIO_DATA_PATH_HCI` && `CONFIG_BT_BLUEDROID_ENABLED`

### **CONFIG\_BT\_HID\_ENABLED**

Classic BT HID

*Found in: Component config > Bluetooth > Bluedroid Options*

This enables the BT HID Host

**Default value:**

- No (disabled) if `CONFIG_BT_CLASSIC_ENABLED` && `CONFIG_BT_BLUEDROID_ENABLED`

Contains:

- `CONFIG_BT_HID_DEVICE_ENABLED`
- `CONFIG_BT_HID_HOST_ENABLED`

### **CONFIG\_BT\_HID\_HOST\_ENABLED**

Classic BT HID Host

*Found in: Component config > Bluetooth > Bluedroid Options > CONFIG\_BT\_HID\_ENABLED*

This enables the BT HID Host

**Default value:**

- No (disabled) if `CONFIG_BT_HID_ENABLED` && `CONFIG_BT_BLUEDROID_ENABLED`

### **CONFIG\_BT\_HID\_DEVICE\_ENABLED**

Classic BT HID Device

*Found in: Component config > Bluetooth > Bluedroid Options > CONFIG\_BT\_HID\_ENABLED*

This enables the BT HID Device

### **CONFIG\_BT\_BLE\_ENABLED**

Bluetooth Low Energy

*Found in: Component config > Bluetooth > Bluedroid Options*

This enables Bluetooth Low Energy

**Default value:**

- Yes (enabled) if `CONFIG_BT_BLUEDROID_ENABLED` && `CONFIG_BT_BLUEDROID_ENABLED`

### **CONFIG\_BT\_GATTS\_ENABLE**

Include GATT server module(GATTS)

*Found in: Component config > Bluetooth > Bluedroid Options > CONFIG\_BT\_BLE\_ENABLED*

This option can be disabled when the app work only on gatt client mode

**Default value:**

- Yes (enabled) if `CONFIG_BT_BLE_ENABLED` && `CONFIG_BT_BLUEDROID_ENABLED`

**CONFIG\_BT\_GATTS\_PPCP\_CHAR\_GAP**

Enable Peripheral Preferred Connection Parameters characteristic in GAP service

*Found in: Component config > Bluetooth > Bluedroid Options > CONFIG\_BT\_BLE\_ENABLED > CONFIG\_BT\_GATTS\_ENABLE*

This enables "Peripheral Preferred Connection Parameters" characteristic (UUID: 0x2A04) in GAP service that has connection parameters like min/max connection interval, slave latency and supervision timeout multiplier

**Default value:**

- No (disabled) if *CONFIG\_BT\_GATTS\_ENABLE* && *CONFIG\_BT\_BLUEDROID\_ENABLED*

**CONFIG\_BT\_BLE\_BLUFI\_ENABLE**

Include blufi function

*Found in: Component config > Bluetooth > Bluedroid Options > CONFIG\_BT\_BLE\_ENABLED > CONFIG\_BT\_GATTS\_ENABLE*

This option can be close when the app does not require blufi function.

**Default value:**

- No (disabled) if *CONFIG\_BT\_GATTS\_ENABLE* && *CONFIG\_BT\_BLUEDROID\_ENABLED*

**CONFIG\_BT\_GATT\_MAX\_SR\_PROFILES**

Max GATT Server Profiles

*Found in: Component config > Bluetooth > Bluedroid Options > CONFIG\_BT\_BLE\_ENABLED > CONFIG\_BT\_GATTS\_ENABLE*

Maximum GATT Server Profiles Count

**Range:**

- from 1 to 32 if *CONFIG\_BT\_GATTS\_ENABLE* && *CONFIG\_BT\_BLUEDROID\_ENABLED* && *CONFIG\_BT\_BLUEDROID\_ENABLED*

**Default value:**

- 8 if *CONFIG\_BT\_GATTS\_ENABLE* && *CONFIG\_BT\_BLUEDROID\_ENABLED* && *CONFIG\_BT\_BLUEDROID\_ENABLED*

**CONFIG\_BT\_GATT\_MAX\_SR\_ATTRIBUTES**

Max GATT Service Attributes

*Found in: Component config > Bluetooth > Bluedroid Options > CONFIG\_BT\_BLE\_ENABLED > CONFIG\_BT\_GATTS\_ENABLE*

Maximum GATT Service Attributes Count

**Range:**

- from 1 to 500 if *CONFIG\_BT\_GATTS\_ENABLE* && *CONFIG\_BT\_BLUEDROID\_ENABLED* && *CONFIG\_BT\_BLUEDROID\_ENABLED*

**Default value:**

- 100 if *CONFIG\_BT\_GATTS\_ENABLE* && *CONFIG\_BT\_BLUEDROID\_ENABLED* && *CONFIG\_BT\_BLUEDROID\_ENABLED*

**CONFIG\_BT\_GATTS\_SEND\_SERVICE\_CHANGE\_MODE**

GATTS Service Change Mode

*Found in: Component config > Bluetooth > Bluedroid Options > CONFIG\_BT\_BLE\_ENABLED > CONFIG\_BT\_GATTS\_ENABLE*

Service change indication mode for GATT Server.

Available options:

- GATTS manually send service change indication (CONFIG\_BT\_GATTS\_SEND\_SERVICE\_CHANGE\_MANUAL)  
Manually send service change indication through API `esp_ble_gatts_send_service_change_indication()`
- GATTS automatically send service change indication (CONFIG\_BT\_GATTS\_SEND\_SERVICE\_CHANGE\_AUTO)  
Let Bluetooth handle the service change indication internally

### CONFIG\_BT\_GATTS\_ROBUST\_CACHING\_ENABLED

Enable Robust Caching on Server Side

*Found in: Component config > Bluetooth > Bluetooth Options > CONFIG\_BT\_BLE\_ENABLED > CONFIG\_BT\_GATTS\_ENABLE*

This option enables the GATT robust caching feature on the server. If turned on, the Client Supported Features characteristic, Database Hash characteristic, and Server Supported Features characteristic will be included in the GAP SERVICE.

**Default value:**

- No (disabled) if *CONFIG\_BT\_GATTS\_ENABLE* && *CONFIG\_BT\_BLUEDROID\_ENABLED*

### CONFIG\_BT\_GATTS\_DEVICE\_NAME\_WRITABLE

Allow to write device name by GATT clients

*Found in: Component config > Bluetooth > Bluetooth Options > CONFIG\_BT\_BLE\_ENABLED > CONFIG\_BT\_GATTS\_ENABLE*

Enabling this option allows remote GATT clients to write device name

**Default value:**

- No (disabled) if *CONFIG\_BT\_GATTS\_ENABLE* && *CONFIG\_BT\_BLUEDROID\_ENABLED*

### CONFIG\_BT\_GATTS\_APPEARANCE\_WRITABLE

Allow to write appearance by GATT clients

*Found in: Component config > Bluetooth > Bluetooth Options > CONFIG\_BT\_BLE\_ENABLED > CONFIG\_BT\_GATTS\_ENABLE*

Enabling this option allows remote GATT clients to write appearance

**Default value:**

- No (disabled) if *CONFIG\_BT\_GATTS\_ENABLE* && *CONFIG\_BT\_BLUEDROID\_ENABLED*

### CONFIG\_BT\_GATTC\_ENABLE

Include GATT client module(GATTC)

*Found in: Component config > Bluetooth > Bluetooth Options > CONFIG\_BT\_BLE\_ENABLED*

This option can be close when the app work only on gatt server mode

**Default value:**

- Yes (enabled) if *CONFIG\_BT\_BLE\_ENABLED* && *CONFIG\_BT\_BLUEDROID\_ENABLED*

### CONFIG\_BT\_GATTC\_MAX\_CACHE\_CHAR

Max gattc cache characteristic for discover

*Found in: Component config > Bluetooth > Bluedroid Options > CONFIG\_BT\_BLE\_ENABLED > CONFIG\_BT\_GATTC\_ENABLE*

Maximum GATTC cache characteristic count

**Range:**

- from 1 to 500 if *CONFIG\_BT\_GATTC\_ENABLE* && *CONFIG\_BT\_BLUEDROID\_ENABLED*

**Default value:**

- 40 if *CONFIG\_BT\_GATTC\_ENABLE* && *CONFIG\_BT\_BLUEDROID\_ENABLED*

### CONFIG\_BT\_GATTC\_NOTIF\_REG\_MAX

Max gattc notify(indication) register number

*Found in: Component config > Bluetooth > Bluedroid Options > CONFIG\_BT\_BLE\_ENABLED > CONFIG\_BT\_GATTC\_ENABLE*

Maximum GATTC notify(indication) register number

**Range:**

- from 1 to 64 if *CONFIG\_BT\_GATTC\_ENABLE* && *CONFIG\_BT\_BLUEDROID\_ENABLED*

**Default value:**

- 5 if *CONFIG\_BT\_GATTC\_ENABLE* && *CONFIG\_BT\_BLUEDROID\_ENABLED*

### CONFIG\_BT\_GATTC\_CACHE\_NVS\_FLASH

Save gattc cache data to nvs flash

*Found in: Component config > Bluetooth > Bluedroid Options > CONFIG\_BT\_BLE\_ENABLED > CONFIG\_BT\_GATTC\_ENABLE*

This select can save gattc cache data to nvs flash

**Default value:**

- No (disabled) if *CONFIG\_BT\_GATTC\_ENABLE* && *CONFIG\_BT\_BLUEDROID\_ENABLED*

### CONFIG\_BT\_GATTC\_CONNECT\_RETRY\_COUNT

The number of attempts to reconnect if the connection establishment failed

*Found in: Component config > Bluetooth > Bluedroid Options > CONFIG\_BT\_BLE\_ENABLED > CONFIG\_BT\_GATTC\_ENABLE*

The number of attempts to reconnect if the connection establishment failed

**Range:**

- from 0 to 255 if *CONFIG\_BT\_GATTC\_ENABLE* && *CONFIG\_BT\_BLUEDROID\_ENABLED*

**Default value:**

- 3 if *CONFIG\_BT\_GATTC\_ENABLE* && *CONFIG\_BT\_BLUEDROID\_ENABLED*

### CONFIG\_BT\_BLE\_SMP\_ENABLE

Include BLE security module(SMP)

*Found in: Component config > Bluetooth > Bluedroid Options > CONFIG\_BT\_BLE\_ENABLED*

This option can be close when the app not used the ble security connect.

**Default value:**

- Yes (enabled) if *CONFIG\_BT\_BLE\_ENABLED* && *CONFIG\_BT\_BLUEDROID\_ENABLED*

**CONFIG\_BT\_SMP\_SLAVE\_CON\_PARAMS\_UPD\_ENABLE**

Slave enable connection parameters update during pairing

*Found in: Component config > Bluetooth > Bluedroid Options > CONFIG\_BT\_BLE\_ENABLED > CONFIG\_BT\_BLE\_SMP\_ENABLE*

In order to reduce the pairing time, slave actively initiates connection parameters update during pairing.

**Default value:**

- No (disabled) if `CONFIG_BT_BLE_SMP_ENABLE` && `CONFIG_BT_BLUEDROID_ENABLED`

**CONFIG\_BT\_BLE\_SMP\_ID\_RESET\_ENABLE**

Reset device identity when all bonding records are deleted

*Found in: Component config > Bluetooth > Bluedroid Options > CONFIG\_BT\_BLE\_ENABLED > CONFIG\_BT\_BLE\_SMP\_ENABLE*

There are tracking risks associated with using a fixed or static IRK. If enabled this option, Bluedroid will assign a new randomly-generated IRK when all pairing and bonding records are deleted. This would decrease the ability of a previously paired peer to be used to determine whether a device with which it previously shared an IRK is within range.

**Default value:**

- No (disabled) if `CONFIG_BT_BLE_SMP_ENABLE` && `CONFIG_BT_BLUEDROID_ENABLED`

**CONFIG\_BT\_STACK\_NO\_LOG**

Disable BT debug logs (minimize bin size)

*Found in: Component config > Bluetooth > Bluedroid Options*

This select can save the rodata code size

**Default value:**

- No (disabled) if `CONFIG_BT_BLUEDROID_ENABLED` && `CONFIG_BT_BLUEDROID_ENABLED`

**BT DEBUG LOG LEVEL** Contains:

- `CONFIG_BT_LOG_A2D_TRACE_LEVEL`
- `CONFIG_BT_LOG_APPL_TRACE_LEVEL`
- `CONFIG_BT_LOG_AVCT_TRACE_LEVEL`
- `CONFIG_BT_LOG_AVDT_TRACE_LEVEL`
- `CONFIG_BT_LOG_AVRC_TRACE_LEVEL`
- `CONFIG_BT_LOG_BLUFI_TRACE_LEVEL`
- `CONFIG_BT_LOG_BNEP_TRACE_LEVEL`
- `CONFIG_BT_LOG_BTC_TRACE_LEVEL`
- `CONFIG_BT_LOG_BTIF_TRACE_LEVEL`
- `CONFIG_BT_LOG_BTM_TRACE_LEVEL`
- `CONFIG_BT_LOG_GAP_TRACE_LEVEL`
- `CONFIG_BT_LOG_GATT_TRACE_LEVEL`
- `CONFIG_BT_LOG_HCI_TRACE_LEVEL`
- `CONFIG_BT_LOG_HID_TRACE_LEVEL`
- `CONFIG_BT_LOG_L2CAP_TRACE_LEVEL`
- `CONFIG_BT_LOG_MCA_TRACE_LEVEL`
- `CONFIG_BT_LOG_OSI_TRACE_LEVEL`
- `CONFIG_BT_LOG_PAN_TRACE_LEVEL`
- `CONFIG_BT_LOG_RFCOMM_TRACE_LEVEL`

- [CONFIG\\_BT\\_LOG\\_SDP\\_TRACE\\_LEVEL](#)
- [CONFIG\\_BT\\_LOG\\_SMP\\_TRACE\\_LEVEL](#)

### **CONFIG\_BT\_LOG\_HCI\_TRACE\_LEVEL**

HCI layer

*Found in: [Component config](#) > [Bluetooth](#) > [Bluedroid Options](#) > [BT DEBUG LOG LEVEL](#)*

Define BT trace level for HCI layer

Available options:

- NONE (CONFIG\_BT\_LOG\_HCI\_TRACE\_LEVEL\_NONE)
- ERROR (CONFIG\_BT\_LOG\_HCI\_TRACE\_LEVEL\_ERROR)
- WARNING (CONFIG\_BT\_LOG\_HCI\_TRACE\_LEVEL\_WARNING)
- API (CONFIG\_BT\_LOG\_HCI\_TRACE\_LEVEL\_API)
- EVENT (CONFIG\_BT\_LOG\_HCI\_TRACE\_LEVEL\_EVENT)
- DEBUG (CONFIG\_BT\_LOG\_HCI\_TRACE\_LEVEL\_DEBUG)
- VERBOSE (CONFIG\_BT\_LOG\_HCI\_TRACE\_LEVEL\_VERBOSE)

### **CONFIG\_BT\_LOG\_BTM\_TRACE\_LEVEL**

BTM layer

*Found in: [Component config](#) > [Bluetooth](#) > [Bluedroid Options](#) > [BT DEBUG LOG LEVEL](#)*

Define BT trace level for BTM layer

Available options:

- NONE (CONFIG\_BT\_LOG\_BTM\_TRACE\_LEVEL\_NONE)
- ERROR (CONFIG\_BT\_LOG\_BTM\_TRACE\_LEVEL\_ERROR)
- WARNING (CONFIG\_BT\_LOG\_BTM\_TRACE\_LEVEL\_WARNING)
- API (CONFIG\_BT\_LOG\_BTM\_TRACE\_LEVEL\_API)
- EVENT (CONFIG\_BT\_LOG\_BTM\_TRACE\_LEVEL\_EVENT)
- DEBUG (CONFIG\_BT\_LOG\_BTM\_TRACE\_LEVEL\_DEBUG)
- VERBOSE (CONFIG\_BT\_LOG\_BTM\_TRACE\_LEVEL\_VERBOSE)

### **CONFIG\_BT\_LOG\_L2CAP\_TRACE\_LEVEL**

L2CAP layer

*Found in: [Component config](#) > [Bluetooth](#) > [Bluedroid Options](#) > [BT DEBUG LOG LEVEL](#)*

Define BT trace level for L2CAP layer

Available options:

- NONE (CONFIG\_BT\_LOG\_L2CAP\_TRACE\_LEVEL\_NONE)
- ERROR (CONFIG\_BT\_LOG\_L2CAP\_TRACE\_LEVEL\_ERROR)
- WARNING (CONFIG\_BT\_LOG\_L2CAP\_TRACE\_LEVEL\_WARNING)
- API (CONFIG\_BT\_LOG\_L2CAP\_TRACE\_LEVEL\_API)
- EVENT (CONFIG\_BT\_LOG\_L2CAP\_TRACE\_LEVEL\_EVENT)
- DEBUG (CONFIG\_BT\_LOG\_L2CAP\_TRACE\_LEVEL\_DEBUG)
- VERBOSE (CONFIG\_BT\_LOG\_L2CAP\_TRACE\_LEVEL\_VERBOSE)

### **CONFIG\_BT\_LOG\_RFCOMM\_TRACE\_LEVEL**

RFCOMM layer

*Found in: [Component config](#) > [Bluetooth](#) > [Blueroid Options](#) > [BT DEBUG LOG LEVEL](#)*

Define BT trace level for RFCOMM layer

Available options:

- NONE (CONFIG\_BT\_LOG\_RFCOMM\_TRACE\_LEVEL\_NONE)
- ERROR (CONFIG\_BT\_LOG\_RFCOMM\_TRACE\_LEVEL\_ERROR)
- WARNING (CONFIG\_BT\_LOG\_RFCOMM\_TRACE\_LEVEL\_WARNING)
- API (CONFIG\_BT\_LOG\_RFCOMM\_TRACE\_LEVEL\_API)
- EVENT (CONFIG\_BT\_LOG\_RFCOMM\_TRACE\_LEVEL\_EVENT)
- DEBUG (CONFIG\_BT\_LOG\_RFCOMM\_TRACE\_LEVEL\_DEBUG)
- VERBOSE (CONFIG\_BT\_LOG\_RFCOMM\_TRACE\_LEVEL\_VERBOSE)

### **CONFIG\_BT\_LOG\_SDP\_TRACE\_LEVEL**

SDP layer

*Found in: [Component config](#) > [Bluetooth](#) > [Blueroid Options](#) > [BT DEBUG LOG LEVEL](#)*

Define BT trace level for SDP layer

Available options:

- NONE (CONFIG\_BT\_LOG\_SDP\_TRACE\_LEVEL\_NONE)
- ERROR (CONFIG\_BT\_LOG\_SDP\_TRACE\_LEVEL\_ERROR)
- WARNING (CONFIG\_BT\_LOG\_SDP\_TRACE\_LEVEL\_WARNING)
- API (CONFIG\_BT\_LOG\_SDP\_TRACE\_LEVEL\_API)
- EVENT (CONFIG\_BT\_LOG\_SDP\_TRACE\_LEVEL\_EVENT)
- DEBUG (CONFIG\_BT\_LOG\_SDP\_TRACE\_LEVEL\_DEBUG)
- VERBOSE (CONFIG\_BT\_LOG\_SDP\_TRACE\_LEVEL\_VERBOSE)

### **CONFIG\_BT\_LOG\_GAP\_TRACE\_LEVEL**

GAP layer

*Found in: [Component config](#) > [Bluetooth](#) > [Blueroid Options](#) > [BT DEBUG LOG LEVEL](#)*

Define BT trace level for GAP layer

Available options:

- NONE (CONFIG\_BT\_LOG\_GAP\_TRACE\_LEVEL\_NONE)
- ERROR (CONFIG\_BT\_LOG\_GAP\_TRACE\_LEVEL\_ERROR)
- WARNING (CONFIG\_BT\_LOG\_GAP\_TRACE\_LEVEL\_WARNING)
- API (CONFIG\_BT\_LOG\_GAP\_TRACE\_LEVEL\_API)
- EVENT (CONFIG\_BT\_LOG\_GAP\_TRACE\_LEVEL\_EVENT)
- DEBUG (CONFIG\_BT\_LOG\_GAP\_TRACE\_LEVEL\_DEBUG)
- VERBOSE (CONFIG\_BT\_LOG\_GAP\_TRACE\_LEVEL\_VERBOSE)

### **CONFIG\_BT\_LOG\_BNEP\_TRACE\_LEVEL**

BNEP layer

*Found in: [Component config](#) > [Bluetooth](#) > [Blueroid Options](#) > [BT DEBUG LOG LEVEL](#)*

Define BT trace level for BNEP layer

Available options:

- NONE (CONFIG\_BT\_LOG\_BNEP\_TRACE\_LEVEL\_NONE)
- ERROR (CONFIG\_BT\_LOG\_BNEP\_TRACE\_LEVEL\_ERROR)
- WARNING (CONFIG\_BT\_LOG\_BNEP\_TRACE\_LEVEL\_WARNING)
- API (CONFIG\_BT\_LOG\_BNEP\_TRACE\_LEVEL\_API)
- EVENT (CONFIG\_BT\_LOG\_BNEP\_TRACE\_LEVEL\_EVENT)
- DEBUG (CONFIG\_BT\_LOG\_BNEP\_TRACE\_LEVEL\_DEBUG)
- VERBOSE (CONFIG\_BT\_LOG\_BNEP\_TRACE\_LEVEL\_VERBOSE)

### **CONFIG\_BT\_LOG\_PAN\_TRACE\_LEVEL**

PAN layer

*Found in: [Component config](#) > [Bluetooth](#) > [Blueroid Options](#) > [BT DEBUG LOG LEVEL](#)*

Define BT trace level for PAN layer

Available options:

- NONE (CONFIG\_BT\_LOG\_PAN\_TRACE\_LEVEL\_NONE)
- ERROR (CONFIG\_BT\_LOG\_PAN\_TRACE\_LEVEL\_ERROR)
- WARNING (CONFIG\_BT\_LOG\_PAN\_TRACE\_LEVEL\_WARNING)
- API (CONFIG\_BT\_LOG\_PAN\_TRACE\_LEVEL\_API)
- EVENT (CONFIG\_BT\_LOG\_PAN\_TRACE\_LEVEL\_EVENT)
- DEBUG (CONFIG\_BT\_LOG\_PAN\_TRACE\_LEVEL\_DEBUG)
- VERBOSE (CONFIG\_BT\_LOG\_PAN\_TRACE\_LEVEL\_VERBOSE)

### **CONFIG\_BT\_LOG\_A2D\_TRACE\_LEVEL**

A2D layer

*Found in: [Component config](#) > [Bluetooth](#) > [Blueroid Options](#) > [BT DEBUG LOG LEVEL](#)*

Define BT trace level for A2D layer

Available options:

- NONE (CONFIG\_BT\_LOG\_A2D\_TRACE\_LEVEL\_NONE)
- ERROR (CONFIG\_BT\_LOG\_A2D\_TRACE\_LEVEL\_ERROR)
- WARNING (CONFIG\_BT\_LOG\_A2D\_TRACE\_LEVEL\_WARNING)
- API (CONFIG\_BT\_LOG\_A2D\_TRACE\_LEVEL\_API)
- EVENT (CONFIG\_BT\_LOG\_A2D\_TRACE\_LEVEL\_EVENT)
- DEBUG (CONFIG\_BT\_LOG\_A2D\_TRACE\_LEVEL\_DEBUG)
- VERBOSE (CONFIG\_BT\_LOG\_A2D\_TRACE\_LEVEL\_VERBOSE)

### **CONFIG\_BT\_LOG\_AVDT\_TRACE\_LEVEL**

AVDT layer

*Found in: [Component config](#) > [Bluetooth](#) > [Blueroid Options](#) > [BT DEBUG LOG LEVEL](#)*

Define BT trace level for AVDT layer

Available options:



- NONE (CONFIG\_BT\_LOG\_AVDT\_TRACE\_LEVEL\_NONE)
- ERROR (CONFIG\_BT\_LOG\_AVDT\_TRACE\_LEVEL\_ERROR)
- WARNING (CONFIG\_BT\_LOG\_AVDT\_TRACE\_LEVEL\_WARNING)
- API (CONFIG\_BT\_LOG\_AVDT\_TRACE\_LEVEL\_API)
- EVENT (CONFIG\_BT\_LOG\_AVDT\_TRACE\_LEVEL\_EVENT)
- DEBUG (CONFIG\_BT\_LOG\_AVDT\_TRACE\_LEVEL\_DEBUG)
- VERBOSE (CONFIG\_BT\_LOG\_AVDT\_TRACE\_LEVEL\_VERBOSE)

### CONFIG\_BT\_LOG\_AVCT\_TRACE\_LEVEL

AVCT layer

*Found in: [Component config](#) > [Bluetooth](#) > [Bluedroid Options](#) > [BT DEBUG LOG LEVEL](#)*

Define BT trace level for AVCT layer

Available options:

- NONE (CONFIG\_BT\_LOG\_AVCT\_TRACE\_LEVEL\_NONE)
- ERROR (CONFIG\_BT\_LOG\_AVCT\_TRACE\_LEVEL\_ERROR)
- WARNING (CONFIG\_BT\_LOG\_AVCT\_TRACE\_LEVEL\_WARNING)
- API (CONFIG\_BT\_LOG\_AVCT\_TRACE\_LEVEL\_API)
- EVENT (CONFIG\_BT\_LOG\_AVCT\_TRACE\_LEVEL\_EVENT)
- DEBUG (CONFIG\_BT\_LOG\_AVCT\_TRACE\_LEVEL\_DEBUG)
- VERBOSE (CONFIG\_BT\_LOG\_AVCT\_TRACE\_LEVEL\_VERBOSE)

### CONFIG\_BT\_LOG\_AVRC\_TRACE\_LEVEL

AVRC layer

*Found in: [Component config](#) > [Bluetooth](#) > [Bluedroid Options](#) > [BT DEBUG LOG LEVEL](#)*

Define BT trace level for AVRC layer

Available options:

- NONE (CONFIG\_BT\_LOG\_AVRC\_TRACE\_LEVEL\_NONE)
- ERROR (CONFIG\_BT\_LOG\_AVRC\_TRACE\_LEVEL\_ERROR)
- WARNING (CONFIG\_BT\_LOG\_AVRC\_TRACE\_LEVEL\_WARNING)
- API (CONFIG\_BT\_LOG\_AVRC\_TRACE\_LEVEL\_API)
- EVENT (CONFIG\_BT\_LOG\_AVRC\_TRACE\_LEVEL\_EVENT)
- DEBUG (CONFIG\_BT\_LOG\_AVRC\_TRACE\_LEVEL\_DEBUG)
- VERBOSE (CONFIG\_BT\_LOG\_AVRC\_TRACE\_LEVEL\_VERBOSE)

### CONFIG\_BT\_LOG\_MCA\_TRACE\_LEVEL

MCA layer

*Found in: [Component config](#) > [Bluetooth](#) > [Bluedroid Options](#) > [BT DEBUG LOG LEVEL](#)*

Define BT trace level for MCA layer

Available options:

- NONE (CONFIG\_BT\_LOG\_MCA\_TRACE\_LEVEL\_NONE)
- ERROR (CONFIG\_BT\_LOG\_MCA\_TRACE\_LEVEL\_ERROR)
- WARNING (CONFIG\_BT\_LOG\_MCA\_TRACE\_LEVEL\_WARNING)
- API (CONFIG\_BT\_LOG\_MCA\_TRACE\_LEVEL\_API)
- EVENT (CONFIG\_BT\_LOG\_MCA\_TRACE\_LEVEL\_EVENT)

- DEBUG (CONFIG\_BT\_LOG\_MCA\_TRACE\_LEVEL\_DEBUG)
- VERBOSE (CONFIG\_BT\_LOG\_MCA\_TRACE\_LEVEL\_VERBOSE)

### CONFIG\_BT\_LOG\_HID\_TRACE\_LEVEL

HID layer

*Found in: [Component config](#) > [Bluetooth](#) > [Bluedroid Options](#) > [BT DEBUG LOG LEVEL](#)*

Define BT trace level for HID layer

Available options:

- NONE (CONFIG\_BT\_LOG\_HID\_TRACE\_LEVEL\_NONE)
- ERROR (CONFIG\_BT\_LOG\_HID\_TRACE\_LEVEL\_ERROR)
- WARNING (CONFIG\_BT\_LOG\_HID\_TRACE\_LEVEL\_WARNING)
- API (CONFIG\_BT\_LOG\_HID\_TRACE\_LEVEL\_API)
- EVENT (CONFIG\_BT\_LOG\_HID\_TRACE\_LEVEL\_EVENT)
- DEBUG (CONFIG\_BT\_LOG\_HID\_TRACE\_LEVEL\_DEBUG)
- VERBOSE (CONFIG\_BT\_LOG\_HID\_TRACE\_LEVEL\_VERBOSE)

### CONFIG\_BT\_LOG\_APPL\_TRACE\_LEVEL

APPL layer

*Found in: [Component config](#) > [Bluetooth](#) > [Bluedroid Options](#) > [BT DEBUG LOG LEVEL](#)*

Define BT trace level for APPL layer

Available options:

- NONE (CONFIG\_BT\_LOG\_APPL\_TRACE\_LEVEL\_NONE)
- ERROR (CONFIG\_BT\_LOG\_APPL\_TRACE\_LEVEL\_ERROR)
- WARNING (CONFIG\_BT\_LOG\_APPL\_TRACE\_LEVEL\_WARNING)
- API (CONFIG\_BT\_LOG\_APPL\_TRACE\_LEVEL\_API)
- EVENT (CONFIG\_BT\_LOG\_APPL\_TRACE\_LEVEL\_EVENT)
- DEBUG (CONFIG\_BT\_LOG\_APPL\_TRACE\_LEVEL\_DEBUG)
- VERBOSE (CONFIG\_BT\_LOG\_APPL\_TRACE\_LEVEL\_VERBOSE)

### CONFIG\_BT\_LOG\_GATT\_TRACE\_LEVEL

GATT layer

*Found in: [Component config](#) > [Bluetooth](#) > [Bluedroid Options](#) > [BT DEBUG LOG LEVEL](#)*

Define BT trace level for GATT layer

Available options:

- NONE (CONFIG\_BT\_LOG\_GATT\_TRACE\_LEVEL\_NONE)
- ERROR (CONFIG\_BT\_LOG\_GATT\_TRACE\_LEVEL\_ERROR)
- WARNING (CONFIG\_BT\_LOG\_GATT\_TRACE\_LEVEL\_WARNING)
- API (CONFIG\_BT\_LOG\_GATT\_TRACE\_LEVEL\_API)
- EVENT (CONFIG\_BT\_LOG\_GATT\_TRACE\_LEVEL\_EVENT)
- DEBUG (CONFIG\_BT\_LOG\_GATT\_TRACE\_LEVEL\_DEBUG)
- VERBOSE (CONFIG\_BT\_LOG\_GATT\_TRACE\_LEVEL\_VERBOSE)

### CONFIG\_BT\_LOG\_SMP\_TRACE\_LEVEL

SMP layer

*Found in: [Component config](#) > [Bluetooth](#) > [Bluedroid Options](#) > [BT DEBUG LOG LEVEL](#)*

Define BT trace level for SMP layer

Available options:

- NONE (CONFIG\_BT\_LOG\_SMP\_TRACE\_LEVEL\_NONE)
- ERROR (CONFIG\_BT\_LOG\_SMP\_TRACE\_LEVEL\_ERROR)
- WARNING (CONFIG\_BT\_LOG\_SMP\_TRACE\_LEVEL\_WARNING)
- API (CONFIG\_BT\_LOG\_SMP\_TRACE\_LEVEL\_API)
- EVENT (CONFIG\_BT\_LOG\_SMP\_TRACE\_LEVEL\_EVENT)
- DEBUG (CONFIG\_BT\_LOG\_SMP\_TRACE\_LEVEL\_DEBUG)
- VERBOSE (CONFIG\_BT\_LOG\_SMP\_TRACE\_LEVEL\_VERBOSE)

### CONFIG\_BT\_LOG\_BTIF\_TRACE\_LEVEL

BTIF layer

*Found in: [Component config](#) > [Bluetooth](#) > [Bluedroid Options](#) > [BT DEBUG LOG LEVEL](#)*

Define BT trace level for BTIF layer

Available options:

- NONE (CONFIG\_BT\_LOG\_BTIF\_TRACE\_LEVEL\_NONE)
- ERROR (CONFIG\_BT\_LOG\_BTIF\_TRACE\_LEVEL\_ERROR)
- WARNING (CONFIG\_BT\_LOG\_BTIF\_TRACE\_LEVEL\_WARNING)
- API (CONFIG\_BT\_LOG\_BTIF\_TRACE\_LEVEL\_API)
- EVENT (CONFIG\_BT\_LOG\_BTIF\_TRACE\_LEVEL\_EVENT)
- DEBUG (CONFIG\_BT\_LOG\_BTIF\_TRACE\_LEVEL\_DEBUG)
- VERBOSE (CONFIG\_BT\_LOG\_BTIF\_TRACE\_LEVEL\_VERBOSE)

### CONFIG\_BT\_LOG\_BTC\_TRACE\_LEVEL

BTC layer

*Found in: [Component config](#) > [Bluetooth](#) > [Bluedroid Options](#) > [BT DEBUG LOG LEVEL](#)*

Define BT trace level for BTC layer

Available options:

- NONE (CONFIG\_BT\_LOG\_BTC\_TRACE\_LEVEL\_NONE)
- ERROR (CONFIG\_BT\_LOG\_BTC\_TRACE\_LEVEL\_ERROR)
- WARNING (CONFIG\_BT\_LOG\_BTC\_TRACE\_LEVEL\_WARNING)
- API (CONFIG\_BT\_LOG\_BTC\_TRACE\_LEVEL\_API)
- EVENT (CONFIG\_BT\_LOG\_BTC\_TRACE\_LEVEL\_EVENT)
- DEBUG (CONFIG\_BT\_LOG\_BTC\_TRACE\_LEVEL\_DEBUG)
- VERBOSE (CONFIG\_BT\_LOG\_BTC\_TRACE\_LEVEL\_VERBOSE)

### CONFIG\_BT\_LOG\_OSI\_TRACE\_LEVEL

OSI layer

*Found in: [Component config](#) > [Bluetooth](#) > [Bluedroid Options](#) > [BT DEBUG LOG LEVEL](#)*

Define BT trace level for OSI layer

Available options:

- NONE (CONFIG\_BT\_LOG\_OSI\_TRACE\_LEVEL\_NONE)
- ERROR (CONFIG\_BT\_LOG\_OSI\_TRACE\_LEVEL\_ERROR)
- WARNING (CONFIG\_BT\_LOG\_OSI\_TRACE\_LEVEL\_WARNING)
- API (CONFIG\_BT\_LOG\_OSI\_TRACE\_LEVEL\_API)
- EVENT (CONFIG\_BT\_LOG\_OSI\_TRACE\_LEVEL\_EVENT)
- DEBUG (CONFIG\_BT\_LOG\_OSI\_TRACE\_LEVEL\_DEBUG)
- VERBOSE (CONFIG\_BT\_LOG\_OSI\_TRACE\_LEVEL\_VERBOSE)

### CONFIG\_BT\_LOG\_BLUFI\_TRACE\_LEVEL

BLUFI layer

*Found in: Component config > Bluetooth > Bluedroid Options > BT DEBUG LOG LEVEL*

Define BT trace level for BLUFI layer

Available options:

- NONE (CONFIG\_BT\_LOG\_BLUFI\_TRACE\_LEVEL\_NONE)
- ERROR (CONFIG\_BT\_LOG\_BLUFI\_TRACE\_LEVEL\_ERROR)
- WARNING (CONFIG\_BT\_LOG\_BLUFI\_TRACE\_LEVEL\_WARNING)
- API (CONFIG\_BT\_LOG\_BLUFI\_TRACE\_LEVEL\_API)
- EVENT (CONFIG\_BT\_LOG\_BLUFI\_TRACE\_LEVEL\_EVENT)
- DEBUG (CONFIG\_BT\_LOG\_BLUFI\_TRACE\_LEVEL\_DEBUG)
- VERBOSE (CONFIG\_BT\_LOG\_BLUFI\_TRACE\_LEVEL\_VERBOSE)

### CONFIG\_BT\_ACL\_CONNECTIONS

BT/BLE MAX ACL CONNECTIONS(1~9)

*Found in: Component config > Bluetooth > Bluedroid Options*

Maximum BT/BLE connection count. The ESP32-C3/S3 chip supports a maximum of 10 instances, including ADV, SCAN and connections. The ESP32-C3/S3 chip can connect up to 9 devices if ADV or SCAN uses only one. If ADV and SCAN are both used, The ESP32-C3/S3 chip is connected to a maximum of 8 devices. Because Bluetooth cannot reclaim used instances once ADV or SCAN is used.

**Range:**

- from 1 to 9 if `CONFIG_BT_BLUEDROID_ENABLED` && `CONFIG_BT_BLUEDROID_ENABLED`

**Default value:**

- 4 if `CONFIG_BT_BLUEDROID_ENABLED` && `CONFIG_BT_BLUEDROID_ENABLED`

### CONFIG\_BT\_MULTI\_CONNECTION\_ENBALE

Enable BLE multi-connections

*Found in: Component config > Bluetooth > Bluedroid Options*

Enable this option if there are multiple connections

**Default value:**

- Yes (enabled) if `CONFIG_BT_BLE_ENABLED` && `CONFIG_BT_BLUEDROID_ENABLED`

### CONFIG\_BT\_ALLOCATION\_FROM\_SPIRAM\_FIRST

BT/BLE will first malloc the memory from the PSRAM

*Found in: Component config > Bluetooth > Bluebird Options*

This select can save the internal RAM if there have the PSRAM

**Default value:**

- No (disabled) if `CONFIG_BT_BLUEBIRD_ENABLED` && `CONFIG_BT_BLUEBIRD_ENABLED`

### CONFIG\_BT\_BLE\_DYNAMIC\_ENV\_MEMORY

Use dynamic memory allocation in BT/BLE stack

*Found in: Component config > Bluetooth > Bluebird Options*

This select can make the allocation of memory will become more flexible

**Default value:**

- No (disabled) if `CONFIG_BT_BLUEBIRD_ENABLED` && `CONFIG_BT_BLUEBIRD_ENABLED`

### CONFIG\_BT\_BLE\_HOST\_QUEUE\_CONG\_CHECK

BLE queue congestion check

*Found in: Component config > Bluetooth > Bluebird Options*

When scanning and scan duplicate is not enabled, if there are a lot of adv packets around or application layer handling adv packets is slow, it will cause the controller memory to run out. if enabled, adv packets will be lost when host queue is congested.

**Default value:**

- No (disabled) if `CONFIG_BT_BLE_ENABLED` && `CONFIG_BT_BLUEBIRD_ENABLED`

### CONFIG\_BT\_SMP\_MAX BONDS

BT/BLE maximum bond device count

*Found in: Component config > Bluetooth > Bluebird Options*

The number of security records for peer devices.

### CONFIG\_BT\_BLE\_ACT\_SCAN\_REP\_ADV\_SCAN

Report adv data and scan response individually when BLE active scan

*Found in: Component config > Bluetooth > Bluebird Options*

Originally, when doing BLE active scan, Bluebird will not report adv to application layer until receive scan response. This option is used to disable the behavior. When enable this option, Bluebird will report adv data or scan response to application layer immediately.

# Memory reserved at start of DRAM for Bluetooth stack

**Default value:**

- No (disabled) if `CONFIG_BT_BLUEBIRD_ENABLED` && `CONFIG_BT_BLE_ENABLED` && `CONFIG_BT_BLUEBIRD_ENABLED`

**CONFIG\_BT\_BLE\_ESTAB\_LINK\_CONN\_TOUT**

Timeout of BLE connection establishment

*Found in: Component config > Bluetooth > Bluedroid Options*

Bluetooth Connection establishment maximum time, if connection time exceeds this value, the connection establishment fails, ESP\_GATTC\_OPEN\_EVT or ESP\_GATTS\_OPEN\_EVT is triggered.

**Range:**

- from 1 to 60 if `CONFIG_BT_BLE_ENABLED` && `CONFIG_BT_BLUEDROID_ENABLED`

**Default value:**

- 30 if `CONFIG_BT_BLE_ENABLED` && `CONFIG_BT_BLUEDROID_ENABLED`

**CONFIG\_BT\_MAX\_DEVICE\_NAME\_LEN**

length of bluetooth device name

*Found in: Component config > Bluetooth > Bluedroid Options*

Bluetooth Device name length shall be no larger than 248 octets, If the broadcast data cannot contain the complete device name, then only the shortname will be displayed, the rest parts that can't fit in will be truncated.

**Range:**

- from 32 to 248 if `CONFIG_BT_BLUEDROID_ENABLED` && `CONFIG_BT_BLUEDROID_ENABLED`

**Default value:**

- 32 if `CONFIG_BT_BLUEDROID_ENABLED` && `CONFIG_BT_BLUEDROID_ENABLED`

**CONFIG\_BT\_BLE\_RPA\_SUPPORTED**

Update RPA to Controller

*Found in: Component config > Bluetooth > Bluedroid Options*

This enables controller RPA list function. For ESP32, ESP32 only support network privacy mode. If this option is enabled, ESP32 will only accept advertising packets from peer devices that contain private address, HW will not receive the advertising packets contain identity address after IRK changed. If this option is disabled, address resolution will be performed in the host, so the functions that require controller to resolve address in the white list cannot be used. This option is disabled by default on ESP32, please enable or disable this option according to your own needs.

For other BLE chips, devices support network privacy mode and device privacy mode, users can switch the two modes according to their own needs. So this option is enabled by default.

**Default value:**

- Yes (enabled) if `CONFIG_BT_CONTROLLER_DISABLED` && `CONFIG_BT_BLUEDROID_ENABLED` && `CONFIG_BT_CONTROLLER_DISABLED` && `CONFIG_BT_BLUEDROID_ENABLED`

**CONFIG\_BT\_BLE\_RPA\_TIMEOUT**

Timeout of resolvable private address

*Found in: Component config > Bluetooth > Bluedroid Options*

This set RPA timeout of Controller and Host. Default is 900 s (15 minutes). Range is 1 s to 1 hour (3600 s).

**Range:**

- from 1 to 3600 if `CONFIG_BT_BLE_ENABLED` && `CONFIG_BT_BLUEDROID_ENABLED`

**Default value:**

- 900 if `CONFIG_BT_BLE_ENABLED` && `CONFIG_BT_BLUEDROID_ENABLED`

## CONFIG\_BT\_BLE\_50\_FEATURES\_SUPPORTED

Enable BLE 5.0 features

*Found in: Component config > Bluetooth > Bluedroid Options*

Enabling this option activates BLE 5.0 features. This option is universally supported in chips that support BLE, except for ESP32.

**Default value:**

- Yes (enabled) if `CONFIG_BT_BLE_ENABLED` && (`CONFIG_BT_CONTROLLER_ENABLED` || `CONFIG_BT_CONTROLLER_DISABLED`) && `CONFIG_BT_BLUEDROID_ENABLED`

## CONFIG\_BT\_BLE\_42\_FEATURES\_SUPPORTED

Enable BLE 4.2 features

*Found in: Component config > Bluetooth > Bluedroid Options*

This enables BLE 4.2 features.

**Default value:**

- No (disabled) if `CONFIG_BT_BLE_ENABLED` && (`CONFIG_BT_CONTROLLER_ENABLED` || `CONFIG_BT_CONTROLLER_DISABLED`) && `CONFIG_BT_BLUEDROID_ENABLED`

## CONFIG\_BT\_BLE\_FEAT\_PERIODIC\_ADV\_SYNC\_TRANSFER

Enable BLE periodic advertising sync transfer feature

*Found in: Component config > Bluetooth > Bluedroid Options*

This enables BLE periodic advertising sync transfer feature

**Default value:**

- No (disabled) if `CONFIG_BT_BLUEDROID_ENABLED` && `CONFIG_BT_BLE_50_FEATURES_SUPPORTED` && (`CONFIG_BT_CONTROLLER_ENABLED` || `CONFIG_BT_CONTROLLER_DISABLED`) && `CONFIG_BT_BLUEDROID_ENABLED`

## CONFIG\_BT\_BLE\_FEAT\_PERIODIC\_ADV\_ENH

Enable periodic adv enhancements(adi support)

*Found in: Component config > Bluetooth > Bluedroid Options*

Enable the periodic advertising enhancements

**Default value:**

- No (disabled) if `CONFIG_BT_BLUEDROID_ENABLED` && `CONFIG_BT_BLE_50_FEATURES_SUPPORTED` && (`CONFIG_BT_CONTROLLER_ENABLED` || `CONFIG_BT_CONTROLLER_DISABLED`) && `CONFIG_BT_BLUEDROID_ENABLED`

## CONFIG\_BT\_BLE\_FEAT\_CREATE\_SYNC\_ENH

Enable create sync enhancements(reporting disable and duplicate filtering enable support)

*Found in: Component config > Bluetooth > Bluedroid Options*

Enable the create sync enhancements

**Default value:**

- No (disabled) if `CONFIG_BT_BLUEDROID_ENABLED` && `CONFIG_BT_BLE_50_FEATURES_SUPPORTED` && (`CONFIG_BT_CONTROLLER_ENABLED` || `CONFIG_BT_CONTROLLER_DISABLED`) && `CONFIG_BT_BLUEDROID_ENABLED`

**CONFIG\_BT\_BLE\_HIGH\_DUTY\_ADV\_INTERVAL**

Enable BLE high duty advertising interval feature

*Found in: Component config > Bluetooth > Bluedroid Options*

This enable BLE high duty advertising interval feature

**Default value:**

- No (disabled) if *CONFIG\_BT\_BLE\_ENABLED* && *CONFIG\_BT\_BLUEDROID\_ENABLED*

**NimBLE Options** Contains:

- *CONFIG\_BT\_NIMBLE\_SVC\_GAP\_DEVICE\_NAME*
- *CONFIG\_BT\_NIMBLE\_HS\_STOP\_TIMEOUT\_MS*
- *CONFIG\_BT\_NIMBLE\_HOST\_QUEUE\_CONG\_CHECK*
- *BLE Services*
- *CONFIG\_BT\_NIMBLE\_WHITELIST\_SIZE*
- *CONFIG\_BT\_NIMBLE\_BLE\_GATT\_BLOB\_TRANSFER*
- *CONFIG\_BT\_NIMBLE\_50\_FEATURE\_SUPPORT*
- *CONFIG\_BT\_NIMBLE\_ROLE\_BROADCASTER*
- *CONFIG\_BT\_NIMBLE\_ROLE\_CENTRAL*
- *CONFIG\_BT\_NIMBLE\_HIGH\_DUTY\_ADV\_ITVL*
- *CONFIG\_BT\_NIMBLE\_MESH*
- *CONFIG\_BT\_NIMBLE\_ROLE\_OBSERVER*
- *CONFIG\_BT\_NIMBLE\_ROLE\_PERIPHERAL*
- *CONFIG\_BT\_NIMBLE\_SECURITY\_ENABLE*
- *CONFIG\_BT\_NIMBLE\_BLUFI\_ENABLE*
- *CONFIG\_BT\_NIMBLE\_ENABLE\_CONN\_REATTEMPT*
- *CONFIG\_BT\_NIMBLE\_DYNAMIC\_SERVICE*
- *CONFIG\_BT\_NIMBLE\_USE\_ESP\_TIMER*
- *CONFIG\_BT\_NIMBLE\_DEBUG*
- *CONFIG\_BT\_NIMBLE\_HS\_FLOW\_CTRL*
- *CONFIG\_BT\_NIMBLE\_VS\_SUPPORT*
- *CONFIG\_BT\_NIMBLE\_OPTIMIZE\_MULTI\_CONN*
- *CONFIG\_BT\_NIMBLE\_ENC\_ADV\_DATA*
- *CONFIG\_BT\_NIMBLE\_SVC\_GAP\_APPEARANCE*
- *GAP Service*
- *Host-controller Transport*
- *CONFIG\_BT\_NIMBLE\_GAP\_DEVICE\_NAME\_MAX\_LEN*
- *CONFIG\_BT\_NIMBLE\_MAX\_BONDS*
- *CONFIG\_BT\_NIMBLE\_MAX\_CCCDS*
- *CONFIG\_BT\_NIMBLE\_MAX\_CONNECTIONS*
- *CONFIG\_BT\_NIMBLE\_L2CAP\_COC\_MAX\_NUM*
- *CONFIG\_BT\_NIMBLE\_GATT\_MAX\_PROCS*
- *CONFIG\_BT\_NIMBLE\_MEM\_ALLOC\_MODE*
- *Memory Settings*
- *CONFIG\_BT\_NIMBLE\_LOG\_LEVEL*
- *CONFIG\_BT\_NIMBLE\_HOST\_TASK\_STACK\_SIZE*
- *CONFIG\_BT\_NIMBLE\_CRYPTO\_STACK\_MBEDTLS*
- *CONFIG\_BT\_NIMBLE\_NVS\_PERSIST*
- *CONFIG\_BT\_NIMBLE\_ATT\_PREFERRED\_MTU*
- *CONFIG\_BT\_NIMBLE\_SMP\_ID\_RESET*
- *CONFIG\_BT\_NIMBLE\_RPA\_TIMEOUT*
- *CONFIG\_BT\_NIMBLE\_PINNED\_TO\_CORE\_CHOICE*
- *CONFIG\_BT\_NIMBLE\_TEST\_THROUGHPUT\_TEST*

**CONFIG\_BT\_NIMBLE\_MEM\_ALLOC\_MODE**

Memory allocation strategy



Found in: [Component config](#) > [Bluetooth](#) > [NimBLE Options](#)

Allocation strategy for NimBLE host stack, essentially provides ability to allocate all required dynamic allocations from,

- Internal DRAM memory only
- External SPIRAM memory only
- Either internal or external memory based on default malloc() behavior in ESP-IDF
- Internal IRAM memory wherever applicable else internal DRAM

Available options:

- Internal memory (CONFIG\_BT\_NIMBLE\_MEM\_ALLOC\_MODE\_INTERNAL)
- External SPIRAM (CONFIG\_BT\_NIMBLE\_MEM\_ALLOC\_MODE\_EXTERNAL)
- Default alloc mode (CONFIG\_BT\_NIMBLE\_MEM\_ALLOC\_MODE\_DEFAULT)
- Internal IRAM (CONFIG\_BT\_NIMBLE\_MEM\_ALLOC\_MODE\_IRAM\_8BIT)  
Allows to use IRAM memory region as 8bit accessible region.  
Every unaligned (8bit or 16bit) access will result in an exception and incur penalty of certain clock cycles per unaligned read/write.

## CONFIG\_BT\_NIMBLE\_LOG\_LEVEL

NimBLE Host log verbosity

Found in: [Component config](#) > [Bluetooth](#) > [NimBLE Options](#)

Select NimBLE log level. Please make a note that the selected NimBLE log verbosity can not exceed the level set in "Component config --> Log output --> Default log verbosity".

Available options:

- No logs (CONFIG\_BT\_NIMBLE\_LOG\_LEVEL\_NONE)
- Error logs (CONFIG\_BT\_NIMBLE\_LOG\_LEVEL\_ERROR)
- Warning logs (CONFIG\_BT\_NIMBLE\_LOG\_LEVEL\_WARNING)
- Info logs (CONFIG\_BT\_NIMBLE\_LOG\_LEVEL\_INFO)
- Debug logs (CONFIG\_BT\_NIMBLE\_LOG\_LEVEL\_DEBUG)

## CONFIG\_BT\_NIMBLE\_MAX\_CONNECTIONS

Maximum number of concurrent connections

Found in: [Component config](#) > [Bluetooth](#) > [NimBLE Options](#)

Defines maximum number of concurrent BLE connections. For ESP32, user is expected to configure BTDM\_CTRL\_BLE\_MAX\_CONN from controller menu along with this option. Similarly for ESP32-C3 or ESP32-S3, user is expected to configure BT\_CTRL\_BLE\_MAX\_ACT from controller menu. For ESP32C2, ESP32C6 and ESP32H2, each connection will take about 1k DRAM.

**Range:**

- from 1 to 35 if `CONFIG_BT_NIMBLE_ENABLED` && `CONFIG_BT_NIMBLE_ENABLED`
- from 1 to 9 if `CONFIG_BT_NIMBLE_ENABLED` && `CONFIG_BT_NIMBLE_ENABLED`

**Default value:**

- 3 if `CONFIG_BT_NIMBLE_ENABLED` && `CONFIG_BT_NIMBLE_ENABLED`

## CONFIG\_BT\_NIMBLE\_MAX BONDS

Maximum number of bonds to save across reboots

Found in: [Component config](#) > [Bluetooth](#) > [NimBLE Options](#)

Defines maximum number of bonds to save for peer security and our security

**Default value:**

- 3 if `CONFIG_BT_NIMBLE_ENABLED` && `CONFIG_BT_NIMBLE_ENABLED`

**CONFIG\_BT\_NIMBLE\_MAX\_CCCDS**

Maximum number of CCC descriptors to save across reboots

*Found in: Component config > Bluetooth > NimBLE Options*

Defines maximum number of CCC descriptors to save

**Default value:**

- 8 if `CONFIG_BT_NIMBLE_ENABLED` && `CONFIG_BT_NIMBLE_ENABLED`

**CONFIG\_BT\_NIMBLE\_L2CAP\_COC\_MAX\_NUM**

Maximum number of connection oriented channels

*Found in: Component config > Bluetooth > NimBLE Options*

Defines maximum number of BLE Connection Oriented Channels. When set to (0), BLE COC is not compiled in

**Range:**

- from 0 to 9 if `CONFIG_BT_NIMBLE_ENABLED` && `CONFIG_BT_NIMBLE_ENABLED`

**Default value:**

- 0 if `CONFIG_BT_NIMBLE_ENABLED` && `CONFIG_BT_NIMBLE_ENABLED`

**CONFIG\_BT\_NIMBLE\_PINNED\_TO\_CORE\_CHOICE**

The CPU core on which NimBLE host will run

*Found in: Component config > Bluetooth > NimBLE Options*

The CPU core on which NimBLE host will run. You can choose Core 0 or Core 1. Cannot specify no-affinity

Available options:

- Core 0 (PRO CPU) (`CONFIG_BT_NIMBLE_PINNED_TO_CORE_0`)
- Core 1 (APP CPU) (`CONFIG_BT_NIMBLE_PINNED_TO_CORE_1`)

**CONFIG\_BT\_NIMBLE\_HOST\_TASK\_STACK\_SIZE**

NimBLE Host task stack size

*Found in: Component config > Bluetooth > NimBLE Options*

This configures stack size of NimBLE host task

**Default value:**

- 5120 if `CONFIG_BLE_MESH` && `CONFIG_BT_NIMBLE_ENABLED` && `CONFIG_BT_NIMBLE_ENABLED`
- 4096 if `CONFIG_BT_NIMBLE_ENABLED` && `CONFIG_BT_NIMBLE_ENABLED`

**CONFIG\_BT\_NIMBLE\_ROLE\_CENTRAL**

Enable BLE Central role

*Found in: Component config > Bluetooth > NimBLE Options*

Enables central role

**Default value:**

- Yes (enabled) if `CONFIG_BT_NIMBLE_ENABLED` && `CONFIG_BT_NIMBLE_ENABLED`

### **CONFIG\_BT\_NIMBLE\_ROLE\_PERIPHERAL**

Enable BLE Peripheral role

*Found in: Component config > Bluetooth > NimBLE Options*

Enable peripheral role

**Default value:**

- Yes (enabled) if `CONFIG_BT_NIMBLE_ENABLED` && `CONFIG_BT_NIMBLE_ENABLED`

### **CONFIG\_BT\_NIMBLE\_ROLE\_BROADCASTER**

Enable BLE Broadcaster role

*Found in: Component config > Bluetooth > NimBLE Options*

Enables broadcaster role

**Default value:**

- Yes (enabled) if `CONFIG_BT_NIMBLE_ENABLED` && `CONFIG_BT_NIMBLE_ENABLED`

### **CONFIG\_BT\_NIMBLE\_ROLE\_OBSERVER**

Enable BLE Observer role

*Found in: Component config > Bluetooth > NimBLE Options*

Enables observer role

**Default value:**

- Yes (enabled) if `CONFIG_BT_NIMBLE_ENABLED` && `CONFIG_BT_NIMBLE_ENABLED`

### **CONFIG\_BT\_NIMBLE\_NVS\_PERSIST**

Persist the BLE Bonding keys in NVS

*Found in: Component config > Bluetooth > NimBLE Options*

Enable this flag to make bonding persistent across device reboots

**Default value:**

- No (disabled) if `CONFIG_BT_NIMBLE_ENABLED` && `CONFIG_BT_NIMBLE_ENABLED`

### **CONFIG\_BT\_NIMBLE\_SMP\_ID\_RESET**

Reset device identity when all bonding records are deleted

*Found in: Component config > Bluetooth > NimBLE Options*

There are tracking risks associated with using a fixed or static IRK. If enabled this option, BlueDroid will assign a new randomly-generated IRK when all pairing and bonding records are deleted. This would decrease the ability of a previously paired peer to be used to determine whether a device with which it previously shared an IRK is within range.

**Default value:**

- No (disabled) if `CONFIG_BT_NIMBLE_ENABLED`

**CONFIG\_BT\_NIMBLE\_SECURITY\_ENABLE**

Enable BLE SM feature

*Found in:* [Component config](#) > [Bluetooth](#) > [NimBLE Options](#)

Enable BLE sm feature

**Default value:**

- Yes (enabled) if [CONFIG\\_BT\\_NIMBLE\\_ENABLED](#) && [CONFIG\\_BT\\_NIMBLE\\_ENABLED](#)

Contains:

- [CONFIG\\_BT\\_NIMBLE\\_LL\\_CFG\\_FEAT\\_LE\\_ENCRYPTION](#)
- [CONFIG\\_BT\\_NIMBLE\\_SM\\_LVL](#)
- [CONFIG\\_BT\\_NIMBLE\\_SM\\_LEGACY](#)
- [CONFIG\\_BT\\_NIMBLE\\_SM\\_SC](#)

**CONFIG\_BT\_NIMBLE\_SM\_LEGACY**

Security manager legacy pairing

*Found in:* [Component config](#) > [Bluetooth](#) > [NimBLE Options](#) > [CONFIG\\_BT\\_NIMBLE\\_SECURITY\\_ENABLE](#)

Enable security manager legacy pairing

**Default value:**

- Yes (enabled) if [CONFIG\\_BT\\_NIMBLE\\_SECURITY\\_ENABLE](#) && [CONFIG\\_BT\\_NIMBLE\\_ENABLED](#)

**CONFIG\_BT\_NIMBLE\_SM\_SC**

Security manager secure connections (4.2)

*Found in:* [Component config](#) > [Bluetooth](#) > [NimBLE Options](#) > [CONFIG\\_BT\\_NIMBLE\\_SECURITY\\_ENABLE](#)

Enable security manager secure connections

**Default value:**

- Yes (enabled) if [CONFIG\\_BT\\_NIMBLE\\_SECURITY\\_ENABLE](#) && [CONFIG\\_BT\\_NIMBLE\\_ENABLED](#)

**CONFIG\_BT\_NIMBLE\_SM\_SC\_DEBUG\_KEYS**

Use predefined public-private key pair

*Found in:* [Component config](#) > [Bluetooth](#) > [NimBLE Options](#) > [CONFIG\\_BT\\_NIMBLE\\_SECURITY\\_ENABLE](#) > [CONFIG\\_BT\\_NIMBLE\\_SM\\_SC](#)

If this option is enabled, SM uses predefined DH key pair as described in Core Specification, Vol. 3, Part H, 2.3.5.6.1. This allows to decrypt air traffic easily and thus should only be used for debugging.

**Default value:**

- No (disabled) if [CONFIG\\_BT\\_NIMBLE\\_SECURITY\\_ENABLE](#) && [CONFIG\\_BT\\_NIMBLE\\_SM\\_SC](#) && [CONFIG\\_BT\\_NIMBLE\\_ENABLED](#)

**CONFIG\_BT\_NIMBLE\_LL\_CFG\_FEAT\_LE\_ENCRYPTION**

Enable LE encryption

*Found in:* [Component config](#) > [Bluetooth](#) > [NimBLE Options](#) > [CONFIG\\_BT\\_NIMBLE\\_SECURITY\\_ENABLE](#)

Enable encryption connection

**Default value:**

- Yes (enabled) if `CONFIG_BT_NIMBLE_SECURITY_ENABLE` && `CONFIG_BT_NIMBLE_ENABLED` && `CONFIG_BT_NIMBLE_ENABLED`

**CONFIG\_BT\_NIMBLE\_SM\_LVL**

Security level

*Found in:* `Component config > Bluetooth > NimBLE Options > CONFIG_BT_NIMBLE_SECURITY_ENABLE`

LE Security Mode 1 Levels: 1. No Security 2. Unauthenticated pairing with encryption 3. Authenticated pairing with encryption 4. Authenticated LE Secure Connections pairing with encryption using a 128-bit strength encryption key.

**Default value:**

- 0 if `CONFIG_BT_NIMBLE_SECURITY_ENABLE` && `CONFIG_BT_NIMBLE_ENABLED`

**CONFIG\_BT\_NIMBLE\_DEBUG**

Enable extra runtime asserts and host debugging

*Found in:* `Component config > Bluetooth > NimBLE Options`

This enables extra runtime asserts and host debugging

**Default value:**

- No (disabled) if `CONFIG_BT_NIMBLE_ENABLED` && `CONFIG_BT_NIMBLE_ENABLED`

**CONFIG\_BT\_NIMBLE\_DYNAMIC\_SERVICE**

Enable dynamic services

*Found in:* `Component config > Bluetooth > NimBLE Options`

This enables user to add/remove Gatt services at runtime

**CONFIG\_BT\_NIMBLE\_SVC\_GAP\_DEVICE\_NAME**

BLE GAP default device name

*Found in:* `Component config > Bluetooth > NimBLE Options`

The Device Name characteristic shall contain the name of the device as an UTF-8 string. This name can be changed by using API `ble_svc_gap_device_name_set()`

**Default value:**

- "nimble" if `CONFIG_BT_NIMBLE_ENABLED` && `CONFIG_BT_NIMBLE_ENABLED`

**CONFIG\_BT\_NIMBLE\_GAP\_DEVICE\_NAME\_MAX\_LEN**

Maximum length of BLE device name in octets

*Found in:* `Component config > Bluetooth > NimBLE Options`

Device Name characteristic value shall be 0 to 248 octets in length

**Default value:**

- 31 if `CONFIG_BT_NIMBLE_ENABLED` && `CONFIG_BT_NIMBLE_ENABLED`

### CONFIG\_BT\_NIMBLE\_ATT\_PREFERRED\_MTU

Preferred MTU size in octets

*Found in: Component config > Bluetooth > NimBLE Options*

This is the default value of ATT MTU indicated by the device during an ATT MTU exchange. This value can be changed using API `ble_att_set_preferred_mtu()`

**Default value:**

- 256 if `CONFIG_BT_NIMBLE_ENABLED` && `CONFIG_BT_NIMBLE_ENABLED`

### CONFIG\_BT\_NIMBLE\_SVC\_GAP\_APPEARANCE

External appearance of the device

*Found in: Component config > Bluetooth > NimBLE Options*

Standard BLE GAP Appearance value in HEX format e.g. 0x02C0

**Default value:**

- 0 if `CONFIG_BT_NIMBLE_ENABLED` && `CONFIG_BT_NIMBLE_ENABLED`

**Memory Settings** Contains:

- `CONFIG_BT_NIMBLE_TRANSPORT_ACL_FROM_LL_COUNT`
- `CONFIG_BT_NIMBLE_TRANSPORT_EVT_DISCARD_COUNT`
- `CONFIG_BT_NIMBLE_MSYS_BUF_FROM_HEAP`
- `CONFIG_BT_NIMBLE_L2CAP_COC_SDU_BUFF_COUNT`
- `CONFIG_BT_NIMBLE_MSYS_1_BLOCK_COUNT`
- `CONFIG_BT_NIMBLE_MSYS_1_BLOCK_SIZE`
- `CONFIG_BT_NIMBLE_MSYS_2_BLOCK_COUNT`
- `CONFIG_BT_NIMBLE_MSYS_2_BLOCK_SIZE`
- `CONFIG_BT_NIMBLE_TRANSPORT_ACL_SIZE`
- `CONFIG_BT_NIMBLE_TRANSPORT_EVT_COUNT`
- `CONFIG_BT_NIMBLE_TRANSPORT_EVT_SIZE`

### CONFIG\_BT\_NIMBLE\_MSYS\_1\_BLOCK\_COUNT

MSYS\_1 Block Count

*Found in: Component config > Bluetooth > NimBLE Options > Memory Settings*

MSYS is a system level mbuf registry. For prepare write & prepare responses Mbufs are allocated out of `msys_1` pool. For NIMBLE\_MESH enabled cases, this block count is increased by 8 than user defined count.

**Default value:**

- 24 if `CONFIG_BT_NIMBLE_ENABLED`

### CONFIG\_BT\_NIMBLE\_MSYS\_1\_BLOCK\_SIZE

MSYS\_1 Block Size

*Found in: Component config > Bluetooth > NimBLE Options > Memory Settings*

Dynamic memory size of block 1

**Default value:**

- 128 if `CONFIG_BT_NIMBLE_ENABLED`

**CONFIG\_BT\_NIMBLE\_MSYS\_2\_BLOCK\_COUNT**

MSYS\_2 Block Count

*Found in: Component config > Bluetooth > NimBLE Options > Memory Settings*

Dynamic memory count

**Default value:**

- 24 if *CONFIG\_BT\_NIMBLE\_ENABLED*

**CONFIG\_BT\_NIMBLE\_MSYS\_2\_BLOCK\_SIZE**

MSYS\_2 Block Size

*Found in: Component config > Bluetooth > NimBLE Options > Memory Settings*

Dynamic memory size of block 2

**Default value:**

- 320 if *CONFIG\_BT\_NIMBLE\_ENABLED*

**CONFIG\_BT\_NIMBLE\_MSYS\_BUF\_FROM\_HEAP**

Get Msys Mbuf from heap

*Found in: Component config > Bluetooth > NimBLE Options > Memory Settings*

This option sets the source of the shared msys mbuf memory between the Host and the Controller. Allocate the memory from the heap if this option is sets, from the mempool otherwise.

**CONFIG\_BT\_NIMBLE\_TRANSPORT\_ACL\_FROM\_LL\_COUNT**

ACL Buffer count

*Found in: Component config > Bluetooth > NimBLE Options > Memory Settings*

The number of ACL data buffers allocated for host.

**Default value:**

- 24 if *CONFIG\_BT\_NIMBLE\_ENABLED* && *CONFIG\_BT\_NIMBLE\_ENABLED*

**CONFIG\_BT\_NIMBLE\_TRANSPORT\_ACL\_SIZE**

Transport ACL Buffer size

*Found in: Component config > Bluetooth > NimBLE Options > Memory Settings*

This is the maximum size of the data portion of HCI ACL data packets. It does not include the HCI data header (of 4 bytes)

**Default value:**

- 255 if *CONFIG\_BT\_NIMBLE\_ENABLED* && *CONFIG\_BT\_NIMBLE\_ENABLED*

**CONFIG\_BT\_NIMBLE\_TRANSPORT\_EVT\_SIZE**

Transport Event Buffer size

*Found in: Component config > Bluetooth > NimBLE Options > Memory Settings*

This is the size of each HCI event buffer in bytes. In case of extended advertising, packets can be fragmented. 257 bytes is the maximum size of a packet.

**Default value:**

- 257 if *CONFIG\_BT\_NIMBLE\_EXT\_ADV* && *CONFIG\_BT\_NIMBLE\_ENABLED* && *CONFIG\_BT\_NIMBLE\_ENABLED*

- 70 if `CONFIG_BT_NIMBLE_ENABLED` && `CONFIG_BT_NIMBLE_ENABLED`

### **CONFIG\_BT\_NIMBLE\_TRANSPORT\_EVT\_COUNT**

Transport Event Buffer count

*Found in: Component config > Bluetooth > NimBLE Options > Memory Settings*

This is the high priority HCI events' buffer size. High-priority event buffers are for everything except advertising reports. If there are no free high-priority event buffers then host will try to allocate a low-priority buffer instead

**Default value:**

- 30 if `CONFIG_BT_NIMBLE_ENABLED` && `CONFIG_BT_NIMBLE_ENABLED`

### **CONFIG\_BT\_NIMBLE\_TRANSPORT\_EVT\_DISCARD\_COUNT**

Discardable Transport Event Buffer count

*Found in: Component config > Bluetooth > NimBLE Options > Memory Settings*

This is the low priority HCI events' buffer size. Low-priority event buffers are only used for advertising reports. If there are no free low-priority event buffers, then an incoming advertising report will get dropped

**Default value:**

- 8 if `CONFIG_BT_NIMBLE_ENABLED` && `CONFIG_BT_NIMBLE_ENABLED`

### **CONFIG\_BT\_NIMBLE\_L2CAP\_COC\_SDU\_BUFF\_COUNT**

L2cap coc Service Data Unit Buffer count

*Found in: Component config > Bluetooth > NimBLE Options > Memory Settings*

This is the service data unit buffer count for l2cap coc.

**Default value:**

- 1 if `CONFIG_BT_NIMBLE_ENABLED` && `CONFIG_BT_NIMBLE_ENABLED`

### **CONFIG\_BT\_NIMBLE\_GATT\_MAX\_PROCS**

Maximum number of GATT client procedures

*Found in: Component config > Bluetooth > NimBLE Options*

Maximum number of GATT client procedures that can be executed.

**Default value:**

- 4 if `CONFIG_BT_NIMBLE_ENABLED` && `CONFIG_BT_NIMBLE_ENABLED`

### **CONFIG\_BT\_NIMBLE\_HS\_FLOW\_CTRL**

Enable Host Flow control

*Found in: Component config > Bluetooth > NimBLE Options*

Enable Host Flow control

**Default value:**

- No (disabled) if `CONFIG_BT_NIMBLE_ENABLED` && `CONFIG_BT_NIMBLE_ENABLED`



**CONFIG\_BT\_NIMBLE\_HS\_FLOW\_CTRL\_ITVL**

Host Flow control interval

*Found in: Component config > Bluetooth > NimBLE Options > CONFIG\_BT\_NIMBLE\_HS\_FLOW\_CTRL*

Host flow control interval in msecs

**Default value:**

- 1000 if `CONFIG_BT_NIMBLE_HS_FLOW_CTRL` && `CONFIG_BT_NIMBLE_ENABLED`

**CONFIG\_BT\_NIMBLE\_HS\_FLOW\_CTRL\_THRESH**

Host Flow control threshold

*Found in: Component config > Bluetooth > NimBLE Options > CONFIG\_BT\_NIMBLE\_HS\_FLOW\_CTRL*

Host flow control threshold, if the number of free buffers are at or below this threshold, send an immediate number-of-completed-packets event

**Default value:**

- 2 if `CONFIG_BT_NIMBLE_HS_FLOW_CTRL` && `CONFIG_BT_NIMBLE_ENABLED`

**CONFIG\_BT\_NIMBLE\_HS\_FLOW\_CTRL\_TX\_ON\_DISCONNECT**

Host Flow control on disconnect

*Found in: Component config > Bluetooth > NimBLE Options > CONFIG\_BT\_NIMBLE\_HS\_FLOW\_CTRL*

Enable this option to send number-of-completed-packets event to controller after disconnection

**Default value:**

- Yes (enabled) if `CONFIG_BT_NIMBLE_HS_FLOW_CTRL` && `CONFIG_BT_NIMBLE_ENABLED`

**CONFIG\_BT\_NIMBLE\_RPA\_TIMEOUT**

RPA timeout in seconds

*Found in: Component config > Bluetooth > NimBLE Options*

Time interval between RPA address change.

**Range:**

- from 1 to 41400 if `CONFIG_BT_NIMBLE_ENABLED` && `CONFIG_BT_NIMBLE_ENABLED`

**Default value:**

- 900 if `CONFIG_BT_NIMBLE_ENABLED` && `CONFIG_BT_NIMBLE_ENABLED`

**CONFIG\_BT\_NIMBLE\_MESH**

Enable BLE mesh functionality

*Found in: Component config > Bluetooth > NimBLE Options*

Enable BLE Mesh example present in upstream mynewt-nimble and not maintained by Espressif.

IDF maintains ESP-BLE-MESH as the official Mesh solution. Please refer to ESP-BLE-MESH guide at: `./doc/./esp32/api-guides/esp-ble-mesh/ble-mesh-index`

**Default value:**

- No (disabled) if `CONFIG_BT_NIMBLE_ENABLED` && `CONFIG_BT_NIMBLE_ENABLED`

Contains:

- `CONFIG_BT_NIMBLE_MESH_PROVISIONER`
- `CONFIG_BT_NIMBLE_MESH_PROV`

- `CONFIG_BT_NIMBLE_MESH_GATT_PROXY`
- `CONFIG_BT_NIMBLE_MESH_FRIEND`
- `CONFIG_BT_NIMBLE_MESH_LOW_POWER`
- `CONFIG_BT_NIMBLE_MESH_PROXY`
- `CONFIG_BT_NIMBLE_MESH_RELAY`
- `CONFIG_BT_NIMBLE_MESH_DEVICE_NAME`
- `CONFIG_BT_NIMBLE_MESH_NODE_COUNT`

### **CONFIG\_BT\_NIMBLE\_MESH\_PROXY**

Enable mesh proxy functionality

*Found in:* [Component config](#) > [Bluetooth](#) > [NimBLE Options](#) > [CONFIG\\_BT\\_NIMBLE\\_MESH](#)

Enable proxy. This is automatically set whenever `NIMBLE_MESH_PB_GATT` or `NIMBLE_MESH_GATT_PROXY` is set

**Default value:**

- No (disabled) if `CONFIG_BT_NIMBLE_MESH` && `CONFIG_BT_NIMBLE_ENABLED`

### **CONFIG\_BT\_NIMBLE\_MESH\_PROV**

Enable BLE mesh provisioning

*Found in:* [Component config](#) > [Bluetooth](#) > [NimBLE Options](#) > [CONFIG\\_BT\\_NIMBLE\\_MESH](#)

Enable mesh provisioning

**Default value:**

- Yes (enabled) if `CONFIG_BT_NIMBLE_MESH` && `CONFIG_BT_NIMBLE_ENABLED`

### **CONFIG\_BT\_NIMBLE\_MESH\_PB\_ADV**

Enable mesh provisioning over advertising bearer

*Found in:* [Component config](#) > [Bluetooth](#) > [NimBLE Options](#) > [CONFIG\\_BT\\_NIMBLE\\_MESH](#) > [CONFIG\\_BT\\_NIMBLE\\_MESH\\_PROV](#)

Enable this option to allow the device to be provisioned over the advertising bearer

**Default value:**

- Yes (enabled) if `CONFIG_BT_NIMBLE_MESH_PROV` && `CONFIG_BT_NIMBLE_ENABLED`

### **CONFIG\_BT\_NIMBLE\_MESH\_PB\_GATT**

Enable mesh provisioning over GATT bearer

*Found in:* [Component config](#) > [Bluetooth](#) > [NimBLE Options](#) > [CONFIG\\_BT\\_NIMBLE\\_MESH](#) > [CONFIG\\_BT\\_NIMBLE\\_MESH\\_PROV](#)

Enable this option to allow the device to be provisioned over the GATT bearer

**Default value:**

- Yes (enabled) if `CONFIG_BT_NIMBLE_MESH_PROV` && `CONFIG_BT_NIMBLE_ENABLED`

### **CONFIG\_BT\_NIMBLE\_MESH\_GATT\_PROXY**

Enable GATT Proxy functionality

*Found in:* [Component config](#) > [Bluetooth](#) > [NimBLE Options](#) > [CONFIG\\_BT\\_NIMBLE\\_MESH](#)

This option enables support for the Mesh GATT Proxy Service, i.e. the ability to act as a proxy between a Mesh GATT Client and a Mesh network

**Default value:**

- Yes (enabled) if `CONFIG_BT_NIMBLE_MESH` && `CONFIG_BT_NIMBLE_ENABLED`

### **CONFIG\_BT\_NIMBLE\_MESH\_RELAY**

Enable mesh relay functionality

*Found in: Component config > Bluetooth > NimBLE Options > CONFIG\_BT\_NIMBLE\_MESH*

Support for acting as a Mesh Relay Node

**Default value:**

- No (disabled) if `CONFIG_BT_NIMBLE_MESH` && `CONFIG_BT_NIMBLE_ENABLED`

### **CONFIG\_BT\_NIMBLE\_MESH\_LOW\_POWER**

Enable mesh low power mode

*Found in: Component config > Bluetooth > NimBLE Options > CONFIG\_BT\_NIMBLE\_MESH*

Enable this option to be able to act as a Low Power Node

**Default value:**

- No (disabled) if `CONFIG_BT_NIMBLE_MESH` && `CONFIG_BT_NIMBLE_ENABLED`

### **CONFIG\_BT\_NIMBLE\_MESH\_FRIEND**

Enable mesh friend functionality

*Found in: Component config > Bluetooth > NimBLE Options > CONFIG\_BT\_NIMBLE\_MESH*

Enable this option to be able to act as a Friend Node

**Default value:**

- No (disabled) if `CONFIG_BT_NIMBLE_MESH` && `CONFIG_BT_NIMBLE_ENABLED`

### **CONFIG\_BT\_NIMBLE\_MESH\_DEVICE\_NAME**

Set mesh device name

*Found in: Component config > Bluetooth > NimBLE Options > CONFIG\_BT\_NIMBLE\_MESH*

This value defines Bluetooth Mesh device/node name

**Default value:**

- "nimble-mesh-node" if `CONFIG_BT_NIMBLE_MESH` && `CONFIG_BT_NIMBLE_ENABLED`

### **CONFIG\_BT\_NIMBLE\_MESH\_NODE\_COUNT**

Set mesh node count

*Found in: Component config > Bluetooth > NimBLE Options > CONFIG\_BT\_NIMBLE\_MESH*

Defines mesh node count.

**Default value:**

- 1 if `CONFIG_BT_NIMBLE_MESH` && `CONFIG_BT_NIMBLE_ENABLED`

### CONFIG\_BT\_NIMBLE\_MESH\_PROVISIONER

Enable BLE mesh provisioner

*Found in: Component config > Bluetooth > NimBLE Options > CONFIG\_BT\_NIMBLE\_MESH*

Enable mesh provisioner.

**Default value:**

- 0 if `CONFIG_BT_NIMBLE_MESH` && `CONFIG_BT_NIMBLE_ENABLED`

### CONFIG\_BT\_NIMBLE\_CRYPTO\_STACK\_MBEDTLS

Override TinyCrypt with mbedTLS for crypto computations

*Found in: Component config > Bluetooth > NimBLE Options*

Enable this option to choose mbedTLS instead of TinyCrypt for crypto computations.

**Default value:**

- Yes (enabled) if `CONFIG_BT_NIMBLE_ENABLED` && `CONFIG_BT_NIMBLE_ENABLED`

### CONFIG\_BT\_NIMBLE\_HS\_STOP\_TIMEOUT\_MS

BLE host stop timeout in msec

*Found in: Component config > Bluetooth > NimBLE Options*

BLE Host stop procedure timeout in milliseconds.

**Default value:**

- 2000 if `CONFIG_BT_NIMBLE_ENABLED` && `CONFIG_BT_NIMBLE_ENABLED`

### CONFIG\_BT\_NIMBLE\_ENABLE\_CONN\_REATTEMPT

Enable connection reattempts on connection establishment error

*Found in: Component config > Bluetooth > NimBLE Options*

Enable to make the NimBLE host to reattempt GAP connection on connection establishment failure.

**Default value:**

- Yes (enabled) if `CONFIG_BT_NIMBLE_ENABLED`

### CONFIG\_BT\_NIMBLE\_MAX\_CONN\_REATTEMPT

Maximum number connection reattempts

*Found in: Component config > Bluetooth > NimBLE Options > CONFIG\_BT\_NIMBLE\_ENABLE\_CONN\_REATTEMPT*

Defines maximum number of connection reattempts.

**Range:**

- from 1 to 255 if `CONFIG_BT_NIMBLE_ENABLED` && `CONFIG_BT_NIMBLE_ENABLE_CONN_REATTEMPT` && `CONFIG_BT_NIMBLE_ENABLED`

**Default value:**

- 3 if `CONFIG_BT_NIMBLE_ENABLED` && `CONFIG_BT_NIMBLE_ENABLE_CONN_REATTEMPT` && `CONFIG_BT_NIMBLE_ENABLED`

**CONFIG\_BT\_NIMBLE\_50\_FEATURE\_SUPPORT**

Enable BLE 5 feature

*Found in: Component config > Bluetooth > NimBLE Options*

Enable BLE 5 feature

**Default value:**

- Yes (enabled) if *CONFIG\_BT\_NIMBLE\_ENABLED* && *CONFIG\_BT\_NIMBLE\_ENABLED*

Contains:

- *CONFIG\_BT\_NIMBLE\_LL\_CFG\_FEAT\_LE\_2M\_PHY*
- *CONFIG\_BT\_NIMBLE\_LL\_CFG\_FEAT\_LE\_CODED\_PHY*
- *CONFIG\_BT\_NIMBLE\_EXT\_ADV*
- *CONFIG\_BT\_NIMBLE\_GATT\_CACHING*
- *CONFIG\_BT\_NIMBLE\_BLE\_POWER\_CONTROL*
- *CONFIG\_BT\_NIMBLE\_MAX\_PERIODIC\_ADVERTISER\_LIST*
- *CONFIG\_BT\_NIMBLE\_MAX\_PERIODIC\_SYNC*
- *CONFIG\_BT\_NIMBLE\_PERIODIC\_ADV\_ENH*

**CONFIG\_BT\_NIMBLE\_LL\_CFG\_FEAT\_LE\_2M\_PHY**

Enable 2M Phy

*Found in: Component config > Bluetooth > NimBLE Options > CONFIG\_BT\_NIMBLE\_50\_FEATURE\_SUPPORT*

Enable 2M-PHY

**Default value:**

- Yes (enabled) if *CONFIG\_BT\_NIMBLE\_50\_FEATURE\_SUPPORT* && *CONFIG\_BT\_NIMBLE\_ENABLED*

**CONFIG\_BT\_NIMBLE\_LL\_CFG\_FEAT\_LE\_CODED\_PHY**

Enable coded Phy

*Found in: Component config > Bluetooth > NimBLE Options > CONFIG\_BT\_NIMBLE\_50\_FEATURE\_SUPPORT*

Enable coded-PHY

**Default value:**

- Yes (enabled) if *CONFIG\_BT\_NIMBLE\_50\_FEATURE\_SUPPORT* && *CONFIG\_BT\_NIMBLE\_ENABLED*

**CONFIG\_BT\_NIMBLE\_EXT\_ADV**

Enable extended advertising

*Found in: Component config > Bluetooth > NimBLE Options > CONFIG\_BT\_NIMBLE\_50\_FEATURE\_SUPPORT*

Enable this option to do extended advertising. Extended advertising will be supported from BLE 5.0 onwards.

**Default value:**

- No (disabled) if *CONFIG\_BT\_NIMBLE\_50\_FEATURE\_SUPPORT* && *CONFIG\_BT\_NIMBLE\_ENABLED*

**CONFIG\_BT\_NIMBLE\_MAX\_EXT\_ADV\_INSTANCES**

Maximum number of extended advertising instances.

*Found in:* [Component config](#) > [Bluetooth](#) > [NimBLE Options](#) > [CONFIG\\_BT\\_NIMBLE\\_50\\_FEATURE\\_SUPPORT](#) > [CONFIG\\_BT\\_NIMBLE\\_EXT\\_ADV](#)

Change this option to set maximum number of extended advertising instances. Minimum there is always one instance of advertising. Enter how many more advertising instances you want. For ESP32C2, ESP32C6 and ESP32H2, each extended advertising instance will take about 0.5k DRAM.

**Range:**

- from 0 to 4 if [CONFIG\\_BT\\_NIMBLE\\_EXT\\_ADV](#) && [CONFIG\\_BT\\_NIMBLE\\_EXT\\_ADV](#) && [CONFIG\\_BT\\_NIMBLE\\_ENABLED](#)

**Default value:**

- 1 if [CONFIG\\_BT\\_NIMBLE\\_EXT\\_ADV](#) && [CONFIG\\_BT\\_NIMBLE\\_EXT\\_ADV](#) && [CONFIG\\_BT\\_NIMBLE\\_EXT\\_ADV](#) && [CONFIG\\_BT\\_NIMBLE\\_ENABLED](#)
- 0 if [CONFIG\\_BT\\_NIMBLE\\_EXT\\_ADV](#) && [CONFIG\\_BT\\_NIMBLE\\_EXT\\_ADV](#) && [CONFIG\\_BT\\_NIMBLE\\_ENABLED](#)

**CONFIG\_BT\_NIMBLE\_EXT\_ADV\_MAX\_SIZE**

Maximum length of the advertising data.

*Found in:* [Component config](#) > [Bluetooth](#) > [NimBLE Options](#) > [CONFIG\\_BT\\_NIMBLE\\_50\\_FEATURE\\_SUPPORT](#) > [CONFIG\\_BT\\_NIMBLE\\_EXT\\_ADV](#)

Defines the length of the extended adv data. The value should not exceed 1650.

**Range:**

- from 0 to 1650 if [CONFIG\\_BT\\_NIMBLE\\_EXT\\_ADV](#) && [CONFIG\\_BT\\_NIMBLE\\_EXT\\_ADV](#) && [CONFIG\\_BT\\_NIMBLE\\_ENABLED](#)

**Default value:**

- 1650 if [CONFIG\\_BT\\_NIMBLE\\_EXT\\_ADV](#) && [CONFIG\\_BT\\_NIMBLE\\_EXT\\_ADV](#) && [CONFIG\\_BT\\_NIMBLE\\_ENABLED](#)
- 0 if [CONFIG\\_BT\\_NIMBLE\\_EXT\\_ADV](#) && [CONFIG\\_BT\\_NIMBLE\\_EXT\\_ADV](#) && [CONFIG\\_BT\\_NIMBLE\\_ENABLED](#)

**CONFIG\_BT\_NIMBLE\_ENABLE\_PERIODIC\_ADV**

Enable periodic advertisement.

*Found in:* [Component config](#) > [Bluetooth](#) > [NimBLE Options](#) > [CONFIG\\_BT\\_NIMBLE\\_50\\_FEATURE\\_SUPPORT](#) > [CONFIG\\_BT\\_NIMBLE\\_EXT\\_ADV](#)

Enable this option to start periodic advertisement.

**Default value:**

- Yes (enabled) if [CONFIG\\_BT\\_NIMBLE\\_EXT\\_ADV](#) && [CONFIG\\_BT\\_NIMBLE\\_EXT\\_ADV](#) && [CONFIG\\_BT\\_NIMBLE\\_ENABLED](#)

**CONFIG\_BT\_NIMBLE\_PERIODIC\_ADV\_SYNC\_TRANSFER**

Enable Transfer Sync Events

*Found in:* [Component config](#) > [Bluetooth](#) > [NimBLE Options](#) > [CONFIG\\_BT\\_NIMBLE\\_50\\_FEATURE\\_SUPPORT](#) > [CONFIG\\_BT\\_NIMBLE\\_EXT\\_ADV](#) > [CONFIG\\_BT\\_NIMBLE\\_ENABLE\\_PERIODIC\\_ADV](#)

This enables controller transfer periodic sync events to host

**Default value:**

- Yes (enabled) if [CONFIG\\_BT\\_NIMBLE\\_ENABLE\\_PERIODIC\\_ADV](#) && [CONFIG\\_BT\\_NIMBLE\\_EXT\\_ADV](#) && [CONFIG\\_BT\\_NIMBLE\\_ENABLED](#)

**CONFIG\_BT\_NIMBLE\_MAX\_PERIODIC\_SYNCS**

Maximum number of periodic advertising syncs

*Found in:* [Component config](#) > [Bluetooth](#) > [NimBLE Options](#) > [CONFIG\\_BT\\_NIMBLE\\_50\\_FEATURE\\_SUPPORT](#)

Set this option to set the upper limit for number of periodic sync connections. This should be less than maximum connections allowed by controller.

**Range:**

- from 0 to 8 if [CONFIG\\_BT\\_NIMBLE\\_50\\_FEATURE\\_SUPPORT](#) && [CONFIG\\_BT\\_NIMBLE\\_ENABLED](#)

**Default value:**

- 1 if [CONFIG\\_BT\\_NIMBLE\\_ENABLE\\_PERIODIC\\_ADV](#) && [CONFIG\\_BT\\_NIMBLE\\_50\\_FEATURE\\_SUPPORT](#) && [CONFIG\\_BT\\_NIMBLE\\_ENABLED](#)
- 0 if [CONFIG\\_BT\\_NIMBLE\\_50\\_FEATURE\\_SUPPORT](#) && [CONFIG\\_BT\\_NIMBLE\\_ENABLED](#)

**CONFIG\_BT\_NIMBLE\_MAX\_PERIODIC\_ADVERTISER\_LIST**

Maximum number of periodic advertiser list

*Found in:* [Component config](#) > [Bluetooth](#) > [NimBLE Options](#) > [CONFIG\\_BT\\_NIMBLE\\_50\\_FEATURE\\_SUPPORT](#)

Set this option to set the upper limit for number of periodic advertiser list.

**Range:**

- from 1 to 5 if [CONFIG\\_BT\\_NIMBLE\\_50\\_FEATURE\\_SUPPORT](#) && [CONFIG\\_BT\\_NIMBLE\\_ENABLED](#)

**Default value:**

- 5 if [CONFIG\\_BT\\_NIMBLE\\_50\\_FEATURE\\_SUPPORT](#) && [CONFIG\\_BT\\_NIMBLE\\_50\\_FEATURE\\_SUPPORT](#) && [CONFIG\\_BT\\_NIMBLE\\_ENABLED](#)

**CONFIG\_BT\_NIMBLE\_BLE\_POWER\_CONTROL**

Enable support for BLE Power Control

*Found in:* [Component config](#) > [Bluetooth](#) > [NimBLE Options](#) > [CONFIG\\_BT\\_NIMBLE\\_50\\_FEATURE\\_SUPPORT](#)

Set this option to enable the Power Control feature

**Default value:**

- No (disabled) if [CONFIG\\_BT\\_NIMBLE\\_50\\_FEATURE\\_SUPPORT](#) && [CONFIG\\_BT\\_NIMBLE\\_ENABLED](#)

**CONFIG\_BT\_NIMBLE\_PERIODIC\_ADV\_ENH**

Periodic adv enhancements(adi support)

*Found in:* [Component config](#) > [Bluetooth](#) > [NimBLE Options](#) > [CONFIG\\_BT\\_NIMBLE\\_50\\_FEATURE\\_SUPPORT](#)

Enable the periodic advertising enhancements

**CONFIG\_BT\_NIMBLE\_GATT\_CACHING**

Enable GATT caching

*Found in:* [Component config](#) > [Bluetooth](#) > [NimBLE Options](#) > [CONFIG\\_BT\\_NIMBLE\\_50\\_FEATURE\\_SUPPORT](#)

Enable GATT caching

Contains:

- [CONFIG\\_BT\\_NIMBLE\\_GATT\\_CACHING\\_MAX\\_CONNS](#)
- [CONFIG\\_BT\\_NIMBLE\\_GATT\\_CACHING\\_MAX\\_CHRS](#)
- [CONFIG\\_BT\\_NIMBLE\\_GATT\\_CACHING\\_MAX\\_DSCS](#)
- [CONFIG\\_BT\\_NIMBLE\\_GATT\\_CACHING\\_MAX\\_SVCS](#)

### **CONFIG\_BT\_NIMBLE\_GATT\_CACHING\_MAX\_CONNS**

Maximum connections to be cached

*Found in:* [Component config](#) > [Bluetooth](#) > [NimBLE Options](#) > [CONFIG\\_BT\\_NIMBLE\\_50\\_FEATURE\\_SUPPORT](#) > [CONFIG\\_BT\\_NIMBLE\\_GATT\\_CACHING](#)

Set this option to set the upper limit on number of connections to be cached.

**Default value:**

- 1 if [CONFIG\\_BT\\_NIMBLE\\_GATT\\_CACHING](#) && [CONFIG\\_BT\\_NIMBLE\\_ENABLED](#)

### **CONFIG\_BT\_NIMBLE\_GATT\_CACHING\_MAX\_SVCS**

Maximum number of services per connection

*Found in:* [Component config](#) > [Bluetooth](#) > [NimBLE Options](#) > [CONFIG\\_BT\\_NIMBLE\\_50\\_FEATURE\\_SUPPORT](#) > [CONFIG\\_BT\\_NIMBLE\\_GATT\\_CACHING](#)

Set this option to set the upper limit on number of services per connection to be cached.

**Default value:**

- 64 if [CONFIG\\_BT\\_NIMBLE\\_GATT\\_CACHING](#) && [CONFIG\\_BT\\_NIMBLE\\_ENABLED](#)

### **CONFIG\_BT\_NIMBLE\_GATT\_CACHING\_MAX\_CHRS**

Maximum number of characteristics per connection

*Found in:* [Component config](#) > [Bluetooth](#) > [NimBLE Options](#) > [CONFIG\\_BT\\_NIMBLE\\_50\\_FEATURE\\_SUPPORT](#) > [CONFIG\\_BT\\_NIMBLE\\_GATT\\_CACHING](#)

Set this option to set the upper limit on number of characteristics per connection to be cached.

**Default value:**

- 64 if [CONFIG\\_BT\\_NIMBLE\\_GATT\\_CACHING](#) && [CONFIG\\_BT\\_NIMBLE\\_ENABLED](#)

### **CONFIG\_BT\_NIMBLE\_GATT\_CACHING\_MAX\_DSCS**

Maximum number of descriptors per connection

*Found in:* [Component config](#) > [Bluetooth](#) > [NimBLE Options](#) > [CONFIG\\_BT\\_NIMBLE\\_50\\_FEATURE\\_SUPPORT](#) > [CONFIG\\_BT\\_NIMBLE\\_GATT\\_CACHING](#)

Set this option to set the upper limit on number of descriptors per connection to be cached.

**Default value:**

- 64 if [CONFIG\\_BT\\_NIMBLE\\_GATT\\_CACHING](#) && [CONFIG\\_BT\\_NIMBLE\\_ENABLED](#)

### **CONFIG\_BT\_NIMBLE\_WHITELIST\_SIZE**

BLE white list size

*Found in:* [Component config](#) > [Bluetooth](#) > [NimBLE Options](#)

BLE list size

**Range:**



- from 1 to 15 if `CONFIG_BT_NIMBLE_ENABLED` && `CONFIG_BT_NIMBLE_ENABLED`

**Default value:**

- 12 if `CONFIG_BT_NIMBLE_ENABLED` && `CONFIG_BT_NIMBLE_ENABLED`

**CONFIG\_BT\_NIMBLE\_TEST\_THROUGHPUT\_TEST**

Throughput Test Mode enable

*Found in: Component config > Bluetooth > NimBLE Options*

Enable the throughput test mode

**Default value:**

- No (disabled) if `CONFIG_BT_NIMBLE_ENABLED`

**CONFIG\_BT\_NIMBLE\_BLUFI\_ENABLE**

Enable blufi functionality

*Found in: Component config > Bluetooth > NimBLE Options*

Set this option to enable blufi functionality.

**Default value:**

- No (disabled) if `CONFIG_BT_NIMBLE_ENABLED` && `CONFIG_BT_NIMBLE_ENABLED`

**CONFIG\_BT\_NIMBLE\_USE\_ESP\_TIMER**

Enable Esp Timer for Nimble

*Found in: Component config > Bluetooth > NimBLE Options*

Set this option to use Esp Timer which has higher priority timer instead of FreeRTOS timer

**Default value:**

- Yes (enabled) if `CONFIG_BT_NIMBLE_ENABLED`

**CONFIG\_BT\_NIMBLE\_BLE\_GATT\_BLOB\_TRANSFER**

Blob transfer

*Found in: Component config > Bluetooth > NimBLE Options*

This option is used when data to be sent is more than 512 bytes. For peripheral role, `BT_NIMBLE_MSYS_1_BLOCK_COUNT` needs to be increased according to the need.

**GAP Service** Contains:

- *GAP Appearance write permissions*
- `CONFIG_BT_NIMBLE_SVC_GAP_CENT_ADDR_RESOLUTION`
- *GAP device name write permissions*
- `CONFIG_BT_NIMBLE_SVC_GAP_PPCP_MAX_CONN_INTERVAL`
- `CONFIG_BT_NIMBLE_SVC_GAP_PPCP_MIN_CONN_INTERVAL`
- `CONFIG_BT_NIMBLE_SVC_GAP_PPCP_SLAVE_LATENCY`
- `CONFIG_BT_NIMBLE_SVC_GAP_PPCP_SUPERVISION_TMO`

**GAP Appearance write permissions** Contains:

- `CONFIG_BT_NIMBLE_SVC_GAP_APPEAR_WRITE`

## CONFIG\_BT\_NIMBLE\_SVC\_GAP\_APPEAR\_WRITE

Write

*Found in: Component config > Bluetooth > NimBLE Options > GAP Service > GAP Appearance write permissions*

Enable write permission (BLE\_GATT\_CHR\_F\_WRITE)

**Default value:**

- No (disabled) if *CONFIG\_BT\_NIMBLE\_ENABLED*

## CONFIG\_BT\_NIMBLE\_SVC\_GAP\_APPEAR\_WRITE\_ENC

Write with encryption

*Found in: Component config > Bluetooth > NimBLE Options > GAP Service > GAP Appearance write permissions > CONFIG\_BT\_NIMBLE\_SVC\_GAP\_APPEAR\_WRITE*

Enable write with encryption permission (BLE\_GATT\_CHR\_F\_WRITE\_ENC)

**Default value:**

- No (disabled) if *CONFIG\_BT\_NIMBLE\_SVC\_GAP\_APPEAR\_WRITE* && *CONFIG\_BT\_NIMBLE\_ENABLED*

## CONFIG\_BT\_NIMBLE\_SVC\_GAP\_APPEAR\_WRITE\_AUTHEN

Write with authentication

*Found in: Component config > Bluetooth > NimBLE Options > GAP Service > GAP Appearance write permissions > CONFIG\_BT\_NIMBLE\_SVC\_GAP\_APPEAR\_WRITE*

Enable write with authentication permission (BLE\_GATT\_CHR\_F\_WRITE\_AUTHEN)

**Default value:**

- No (disabled) if *CONFIG\_BT\_NIMBLE\_SVC\_GAP\_APPEAR\_WRITE* && *CONFIG\_BT\_NIMBLE\_ENABLED*

## CONFIG\_BT\_NIMBLE\_SVC\_GAP\_APPEAR\_WRITE\_AUTHOR

Write with authorisation

*Found in: Component config > Bluetooth > NimBLE Options > GAP Service > GAP Appearance write permissions > CONFIG\_BT\_NIMBLE\_SVC\_GAP\_APPEAR\_WRITE*

Enable write with authorisation permission (BLE\_GATT\_CHR\_F\_WRITE\_AUTHOR)

**Default value:**

- No (disabled) if *CONFIG\_BT\_NIMBLE\_SVC\_GAP\_APPEAR\_WRITE* && *CONFIG\_BT\_NIMBLE\_ENABLED*

## CONFIG\_BT\_NIMBLE\_SVC\_GAP\_CENT\_ADDR\_RESOLUTION

GAP Characteristic - Central Address Resolution

*Found in: Component config > Bluetooth > NimBLE Options > GAP Service*

Weather or not Central Address Resolution characteristic is supported on the device, and if supported, weather or not Central Address Resolution is supported.

- Central Address Resolution characteristic not supported
- Central Address Resolution not supported
- Central Address Resolution supported

Available options:

- Characteristic not supported (CONFIG\_BT\_NIMBLE\_SVC\_GAP\_CAR\_CHAR\_NOT\_SUPP)
- Central Address Resolution not supported (CONFIG\_BT\_NIMBLE\_SVC\_GAP\_CAR\_NOT\_SUPP)
- Central Address Resolution supported (CONFIG\_BT\_NIMBLE\_SVC\_GAP\_CAR\_SUPP)

**GAP device name write permissions** Contains:

- `CONFIG_BT_NIMBLE_SVC_GAP_NAME_WRITE`

### **CONFIG\_BT\_NIMBLE\_SVC\_GAP\_NAME\_WRITE**

Write

*Found in: Component config > Bluetooth > NimBLE Options > GAP Service > GAP device name write permissions*

Enable write permission (BLE\_GATT\_CHR\_F\_WRITE)

**Default value:**

- No (disabled) if `CONFIG_BT_NIMBLE_ENABLED`

### **CONFIG\_BT\_NIMBLE\_SVC\_GAP\_NAME\_WRITE\_ENC**

Write with encryption

*Found in: Component config > Bluetooth > NimBLE Options > GAP Service > GAP device name write permissions > CONFIG\_BT\_NIMBLE\_SVC\_GAP\_NAME\_WRITE*

Enable write with encryption permission (BLE\_GATT\_CHR\_F\_WRITE\_ENC)

**Default value:**

- No (disabled) if `CONFIG_BT_NIMBLE_SVC_GAP_NAME_WRITE` && `CONFIG_BT_NIMBLE_ENABLED`

### **CONFIG\_BT\_NIMBLE\_SVC\_GAP\_NAME\_WRITE\_AUTHEN**

Write with authentication

*Found in: Component config > Bluetooth > NimBLE Options > GAP Service > GAP device name write permissions > CONFIG\_BT\_NIMBLE\_SVC\_GAP\_NAME\_WRITE*

Enable write with authentication permission (BLE\_GATT\_CHR\_F\_WRITE\_AUTHEN)

**Default value:**

- No (disabled) if `CONFIG_BT_NIMBLE_SVC_GAP_NAME_WRITE` && `CONFIG_BT_NIMBLE_ENABLED`

### **CONFIG\_BT\_NIMBLE\_SVC\_GAP\_NAME\_WRITE\_AUTHOR**

Write with authorisation

*Found in: Component config > Bluetooth > NimBLE Options > GAP Service > GAP device name write permissions > CONFIG\_BT\_NIMBLE\_SVC\_GAP\_NAME\_WRITE*

Enable write with authorisation permission (BLE\_GATT\_CHR\_F\_WRITE\_AUTHOR)

**Default value:**

- No (disabled) if `CONFIG_BT_NIMBLE_SVC_GAP_NAME_WRITE` && `CONFIG_BT_NIMBLE_ENABLED`

**CONFIG\_BT\_NIMBLE\_SVC\_GAP\_PPCP\_MAX\_CONN\_INTERVAL**

PPCP Connection Interval Max (Unit: 1.25 ms)

*Found in: Component config > Bluetooth > NimBLE Options > GAP Service*

Peripheral Preferred Connection Parameter: Connection Interval maximum value Interval Max = value \* 1.25 ms

**Default value:**

- 0 if *CONFIG\_BT\_NIMBLE\_ROLE\_PERIPHERAL* && *CONFIG\_BT\_NIMBLE\_ENABLED*

**CONFIG\_BT\_NIMBLE\_SVC\_GAP\_PPCP\_MIN\_CONN\_INTERVAL**

PPCP Connection Interval Min (Unit: 1.25 ms)

*Found in: Component config > Bluetooth > NimBLE Options > GAP Service*

Peripheral Preferred Connection Parameter: Connection Interval minimum value Interval Min = value \* 1.25 ms

**Default value:**

- 0 if *CONFIG\_BT\_NIMBLE\_ROLE\_PERIPHERAL* && *CONFIG\_BT\_NIMBLE\_ENABLED*

**CONFIG\_BT\_NIMBLE\_SVC\_GAP\_PPCP\_SLAVE\_LATENCY**

PPCP Slave Latency

*Found in: Component config > Bluetooth > NimBLE Options > GAP Service*

Peripheral Preferred Connection Parameter: Slave Latency

**Default value:**

- 0 if *CONFIG\_BT\_NIMBLE\_ENABLED*

**CONFIG\_BT\_NIMBLE\_SVC\_GAP\_PPCP\_SUPERVISION\_TMO**

PPCP Supervision Timeout (Unit: 10 ms)

*Found in: Component config > Bluetooth > NimBLE Options > GAP Service*

Peripheral Preferred Connection Parameter: Supervision Timeout Timeout = Value \* 10 ms

**Default value:**

- 0 if *CONFIG\_BT\_NIMBLE\_ENABLED*

**BLE Services** Contains:

- *CONFIG\_BT\_NIMBLE\_HID\_SERVICE*

**CONFIG\_BT\_NIMBLE\_HID\_SERVICE**

HID service

*Found in: Component config > Bluetooth > NimBLE Options > BLE Services*

Enable HID service support

**Default value:**

- No (disabled) if *CONFIG\_BT\_NIMBLE\_ENABLED* && *CONFIG\_BT\_NIMBLE\_ENABLED*

Contains:

- *CONFIG\_BT\_NIMBLE\_SVC\_HID\_MAX\_RPTS*
- *CONFIG\_BT\_NIMBLE\_SVC\_HID\_MAX\_INSTANCES*

### CONFIG\_BT\_NIMBLE\_SVC\_HID\_MAX\_INSTANCES

Maximum HID service instances

*Found in:* [Component config](#) > [Bluetooth](#) > [NimBLE Options](#) > [BLE Services](#) > [CONFIG\\_BT\\_NIMBLE\\_HID\\_SERVICE](#)

Defines maximum number of HID service instances

**Default value:**

- 2 if [CONFIG\\_BT\\_NIMBLE\\_HID\\_SERVICE](#) && [CONFIG\\_BT\\_NIMBLE\\_ENABLED](#)

### CONFIG\_BT\_NIMBLE\_SVC\_HID\_MAX\_RPTS

Maximum HID Report characteristics per service instance

*Found in:* [Component config](#) > [Bluetooth](#) > [NimBLE Options](#) > [BLE Services](#) > [CONFIG\\_BT\\_NIMBLE\\_HID\\_SERVICE](#)

Defines maximum number of report characteristics per service instance

**Default value:**

- 3 if [CONFIG\\_BT\\_NIMBLE\\_HID\\_SERVICE](#) && [CONFIG\\_BT\\_NIMBLE\\_ENABLED](#)

### CONFIG\_BT\_NIMBLE\_VS\_SUPPORT

Enable support for VSC and VSE

*Found in:* [Component config](#) > [Bluetooth](#) > [NimBLE Options](#)

This option is used to enable support for sending Vendor Specific HCI commands and handling Vendor Specific HCI Events.

### CONFIG\_BT\_NIMBLE\_OPTIMIZE\_MULTI\_CONN

Enable the optimization of multi-connection

*Found in:* [Component config](#) > [Bluetooth](#) > [NimBLE Options](#)

This option enables the use of vendor-specific APIs for multi-connections, which can greatly enhance the stability of coexistence between numerous central and peripheral devices. It will prohibit the usage of standard APIs.

**Default value:**

- No (disabled) if [CONFIG\\_BT\\_NIMBLE\\_ENABLED](#)

### CONFIG\_BT\_NIMBLE\_ENC\_ADV\_DATA

Encrypted Advertising Data

*Found in:* [Component config](#) > [Bluetooth](#) > [NimBLE Options](#)

This option is used to enable encrypted advertising data.

### CONFIG\_BT\_NIMBLE\_MAX\_EADS

Maximum number of EAD devices to save across reboots

*Found in:* [Component config](#) > [Bluetooth](#) > [NimBLE Options](#) > [CONFIG\\_BT\\_NIMBLE\\_ENC\\_ADV\\_DATA](#)

Defines maximum number of encrypted advertising data key material to save

**Default value:**

- 10 if [CONFIG\\_BT\\_NIMBLE\\_ENABLED](#) && [CONFIG\\_BT\\_NIMBLE\\_ENC\\_ADV\\_DATA](#) && [CONFIG\\_BT\\_NIMBLE\\_ENABLED](#)

**CONFIG\_BT\_NIMBLE\_HIGH\_DUTY\_ADV\_ITVL**

Enable BLE high duty advertising interval feature

*Found in: Component config > Bluetooth > NimBLE Options*

This enable BLE high duty advertising interval feature

**CONFIG\_BT\_NIMBLE\_HOST\_QUEUE\_CONG\_CHECK**

BLE queue congestion check

*Found in: Component config > Bluetooth > NimBLE Options*

When scanning and scan duplicate is not enabled, if there are a lot of adv packets around or application layer handling adv packets is slow, it will cause the controller memory to run out. if enabled, adv packets will be lost when host queue is congested.

**Default value:**

- No (disabled) if `CONFIG_BT_NIMBLE_ENABLED` && `CONFIG_BT_NIMBLE_ENABLED`

**Host-controller Transport** Contains:

- `CONFIG_BT_NIMBLE_TRANSPORT_UART`
- `CONFIG_BT_NIMBLE_HCI_UART_CTS_PIN`
- `CONFIG_BT_NIMBLE_USE_HCI_UART_FLOW_CTRL`
- `CONFIG_BT_NIMBLE_HCI_UART_RTS_PIN`

**CONFIG\_BT\_NIMBLE\_TRANSPORT\_UART**

Enable Uart Transport

*Found in: Component config > Bluetooth > NimBLE Options > Host-controller Transport*

Use UART transport

**Default value:**

- Yes (enabled) if `CONFIG_BT_CONTROLLER_DISABLED` && `CONFIG_BT_NIMBLE_ENABLED`

**CONFIG\_BT\_NIMBLE\_TRANSPORT\_UART\_PORT**

Uart port

*Found in: Component config > Bluetooth > NimBLE Options > Host-controller Transport > CONFIG\_BT\_NIMBLE\_TRANSPORT\_UART*

Uart port

**Default value:**

- 1 if `CONFIG_BT_CONTROLLER_DISABLED` && `CONFIG_BT_NIMBLE_TRANSPORT_UART` && `CONFIG_BT_NIMBLE_ENABLED`

**CONFIG\_BT\_NIMBLE\_HCI\_USE\_UART\_BAUDRATE**

Uart Hci Baud Rate

*Found in: Component config > Bluetooth > NimBLE Options > Host-controller Transport > CONFIG\_BT\_NIMBLE\_TRANSPORT\_UART*

Uart Baud Rate

Available options:

- 115200 (CONFIG\_UART\_BAUDRATE\_115200)
- 230400 (CONFIG\_UART\_BAUDRATE\_230400)
- 460800 (CONFIG\_UART\_BAUDRATE\_460800)
- 921600 (CONFIG\_UART\_BAUDRATE\_921600)

### CONFIG\_BT\_NIMBLE\_USE\_HCI\_UART\_PARITY

Uart PARITY

*Found in: Component config > Bluetooth > NimBLE Options > Host-controller Transport > CONFIG\_BT\_NIMBLE\_TRANSPORT\_UART*

Uart Parity

Available options:

- None (CONFIG\_UART\_PARITY\_NONE)
- Odd (CONFIG\_UART\_PARITY\_ODD)
- Even (CONFIG\_UART\_PARITY\_EVEN)

### CONFIG\_BT\_NIMBLE\_UART\_RX\_PIN

UART Rx pin

*Found in: Component config > Bluetooth > NimBLE Options > Host-controller Transport > CONFIG\_BT\_NIMBLE\_TRANSPORT\_UART*

Rx pin for Nimble Transport

**Default value:**

- 5 if `CONFIG_BT_CONTROLLER_DISABLED` && `CONFIG_BT_NIMBLE_TRANSPORT_UART` && `CONFIG_BT_NIMBLE_ENABLED`

### CONFIG\_BT\_NIMBLE\_UART\_TX\_PIN

UART Tx pin

*Found in: Component config > Bluetooth > NimBLE Options > Host-controller Transport > CONFIG\_BT\_NIMBLE\_TRANSPORT\_UART*

Tx pin for Nimble Transport

**Default value:**

- 4 if `CONFIG_BT_CONTROLLER_DISABLED` && `CONFIG_BT_NIMBLE_TRANSPORT_UART` && `CONFIG_BT_NIMBLE_ENABLED`

### CONFIG\_BT\_NIMBLE\_USE\_HCI\_UART\_FLOW\_CTRL

Uart Flow Control

*Found in: Component config > Bluetooth > NimBLE Options > Host-controller Transport*

Uart Flow Control

Available options:

- Disable (CONFIG\_UART\_HW\_FLOWCTRL\_DISABLE)
- Enable hardware flow control (CONFIG\_UART\_HW\_FLOWCTRL\_CTS\_RTS)

**CONFIG\_BT\_NIMBLE\_HCI\_UART\_RTS\_PIN**

UART Rts Pin

*Found in: Component config > Bluetooth > NimBLE Options > Host-controller Transport*

UART HCI RTS pin

**Default value:**

- 19 if *CONFIG\_BT\_NIMBLE\_ENABLED*

**CONFIG\_BT\_NIMBLE\_HCI\_UART\_CTS\_PIN**

UART Cts Pin

*Found in: Component config > Bluetooth > NimBLE Options > Host-controller Transport*

UART HCI CTS pin

**Default value:**

- 23 if *CONFIG\_BT\_NIMBLE\_ENABLED*

**Controller Options** Contains:

- *CONFIG\_BT\_CTRL\_BLE\_ADV\_REPORT\_FLOW\_CTRL\_SUPP*
- *CONFIG\_BT\_LE\_DFT\_TX\_POWER\_LEVEL\_DBM*
- *CONFIG\_BT\_LE\_LL\_DUP\_SCAN\_LIST\_COUNT*
- *CONFIG\_BT\_LE\_LL\_RESOLV\_LIST\_SIZE*
- *CONFIG\_BT\_LE\_LP\_CLK\_SRC*
- *CONFIG\_BT\_LE\_SCAN\_DUPL*
- *CONFIG\_BT\_LE\_LL\_SCA*
- *CONFIG\_BT\_LE\_WHITELIST\_SIZE*
- *CONFIG\_BT\_LE\_COEX\_PHY\_CODED\_TX\_RX\_TLIM*
- *CONFIG\_BT\_LE\_CONTROLLER\_LOG\_ENABLED*
- *CONFIG\_BT\_LE\_CONTROLLER\_TASK\_STACK\_SIZE*
- *CONFIG\_BT\_LE\_50\_FEATURE\_SUPPORT*
- *CONFIG\_BT\_LE\_SLEEP\_ENABLE*
- *CONFIG\_BT\_LE\_SECURITY\_ENABLE*
- *CONFIG\_BT\_LE\_USE\_ESP\_TIMER*
- *CONFIG\_BT\_LE\_TX\_CCA\_ENABLED*
- *HCI Config*
- *CONFIG\_BT\_LE\_MAX\_CONNECTIONS*
- *Memory Settings*
- *CONFIG\_BT\_LE\_CRYPTOSTACK\_MBEDTLS*

**HCI Config** Contains:

- *CONFIG\_BT\_LE\_HCI\_INTERFACE*
- *CONFIG\_BT\_LE\_HCI\_TRANS\_TASK\_STACK\_SIZE*
- *CONFIG\_BT\_LE\_HCI\_UART\_BAUD*
- *CONFIG\_BT\_LE\_HCI\_UART\_CTS\_PIN*
- *CONFIG\_BT\_LE\_HCI\_UART\_FLOWCTRL*
- *CONFIG\_BT\_LE\_HCI\_UART\_PORT*
- *CONFIG\_BT\_LE\_HCI\_UART\_RTS\_PIN*
- *CONFIG\_BT\_LE\_HCI\_UART\_RX\_PIN*
- *CONFIG\_BT\_LE\_HCI\_UART\_TX\_PIN*
- *CONFIG\_BT\_LE\_HCI\_UART\_PARITY*
- *CONFIG\_BT\_LE\_HCI\_LLDESCS\_POOL\_NUM*
- *CONFIG\_BT\_LE\_HCI\_TRANS\_RX\_MEM\_NUM*
- *CONFIG\_BT\_LE\_HCI\_UART\_RX\_BUFFER\_SIZE*
- *CONFIG\_BT\_LE\_HCI\_UART\_TX\_BUFFER\_SIZE*



- [CONFIG\\_BT\\_LE\\_UART\\_HCI\\_MODE\\_CHOICE](#)

### CONFIG\_BT\_LE\_HCI\_INTERFACE

HCI mode

*Found in: Component config > Bluetooth > Controller Options > HCI Config*

Available options:

- VHCI (CONFIG\_BT\_LE\_HCI\_INTERFACE\_USE\_RAM)  
Use RAM as HCI interface
- UART(H4) (CONFIG\_BT\_LE\_HCI\_INTERFACE\_USE\_UART)  
Use UART as HCI interface

### CONFIG\_BT\_LE\_UART\_HCI\_MODE\_CHOICE

UART HCI mode

*Found in: Component config > Bluetooth > Controller Options > HCI Config*

Specify UART HCI mode: DMA or No DMA

Available options:

- UHCI(UART with DMA)(EXPERIMENTAL) (CONFIG\_BT\_LE\_UART\_HCI\_DMA\_MODE)  
UART HCI Mode with DMA functionality.
- UART(NO DMA) (CONFIG\_BT\_LE\_UART\_HCI\_NO\_DMA\_MODE)  
UART HCI Mode without DMA functionality.

### CONFIG\_BT\_LE\_HCI\_UART\_PORT

HCI UART port

*Found in: Component config > Bluetooth > Controller Options > HCI Config*

Set the port number of HCI UART

**Default value:**

- 1 if `CONFIG_BT_LE_HCI_INTERFACE_USE_UART` && `CONFIG_BT_CONTROLLER_ENABLED`

### CONFIG\_BT\_LE\_HCI\_UART\_FLOWCTRL

HCI uart Hardware Flow ctrl

*Found in: Component config > Bluetooth > Controller Options > HCI Config*

**Default value:**

- No (disabled) if `CONFIG_BT_LE_HCI_INTERFACE_USE_UART` && `CONFIG_BT_CONTROLLER_ENABLED`

### CONFIG\_BT\_LE\_HCI\_UART\_TX\_PIN

HCI uart Tx gpio

*Found in: Component config > Bluetooth > Controller Options > HCI Config*

**Default value:**

- 19 if `CONFIG_BT_LE_HCI_INTERFACE_USE_UART` && `CONFIG_BT_CONTROLLER_ENABLED`

### CONFIG\_BT\_LE\_HCI\_UART\_RX\_PIN

HCI uart Rx gpio

*Found in: Component config > Bluetooth > Controller Options > HCI Config*

**Default value:**

- 10 if `CONFIG_BT_LE_HCI_INTERFACE_USE_UART` && `CONFIG_BT_CONTROLLER_ENABLED`

### CONFIG\_BT\_LE\_HCI\_UART\_RTS\_PIN

HCI uart RTS gpio

*Found in: Component config > Bluetooth > Controller Options > HCI Config*

**Default value:**

- 4 if `CONFIG_BT_LE_HCI_UART_FLOWCTRL` && `CONFIG_BT_CONTROLLER_ENABLED`

### CONFIG\_BT\_LE\_HCI\_UART\_CTS\_PIN

HCI uart CTS gpio

*Found in: Component config > Bluetooth > Controller Options > HCI Config*

**Default value:**

- 5 if `CONFIG_BT_LE_HCI_UART_FLOWCTRL` && `CONFIG_BT_CONTROLLER_ENABLED`

### CONFIG\_BT\_LE\_HCI\_UART\_BAUD

HCI uart baudrate

*Found in: Component config > Bluetooth > Controller Options > HCI Config*

HCI uart baud rate 115200 ~ 1000000

**Default value:**

- 921600 if `CONFIG_BT_LE_HCI_INTERFACE_USE_UART` && `CONFIG_BT_CONTROLLER_ENABLED`

### CONFIG\_BT\_LE\_HCI\_UART\_PARITY

select uart parity

*Found in: Component config > Bluetooth > Controller Options > HCI Config*

Available options:

- PARITY\_DISABLE (CONFIG\_BT\_LE\_HCI\_UART\_UART\_PARITY\_DISABLE)  
UART\_PARITY\_DISABLE
- PARITY\_EVEN (CONFIG\_BT\_LE\_HCI\_UART\_UART\_PARITY\_EVEN)  
UART\_PARITY\_EVEN
- PARITY\_ODD (CONFIG\_BT\_LE\_HCI\_UART\_UART\_PARITY\_ODD)  
UART\_PARITY\_ODD

**CONFIG\_BT\_LE\_HCI\_UART\_RX\_BUFFER\_SIZE**

The size of rx ring buffer memory

*Found in: Component config > Bluetooth > Controller Options > HCI Config*

The size of rx ring buffer memory

**Default value:**

- 512 if `CONFIG_BT_LE_UART_HCI_NO_DMA_MODE` && `CONFIG_BT_CONTROLLER_ENABLED`

**CONFIG\_BT\_LE\_HCI\_UART\_TX\_BUFFER\_SIZE**

The size of tx ring buffer memory

*Found in: Component config > Bluetooth > Controller Options > HCI Config*

The size of tx ring buffer memory

**Default value:**

- 256 if `CONFIG_BT_LE_UART_HCI_NO_DMA_MODE` && `CONFIG_BT_CONTROLLER_ENABLED`

**CONFIG\_BT\_LE\_HCI\_TRANS\_TASK\_STACK\_SIZE**

HCI transport task stack size

*Found in: Component config > Bluetooth > Controller Options > HCI Config*

This configures stack size of hci transport task

**CONFIG\_BT\_LE\_HCI\_TRANS\_RX\_MEM\_NUM**

The amount of rx memory received at the same time

*Found in: Component config > Bluetooth > Controller Options > HCI Config*

The amount of rx memory received at the same time

**Default value:**

- 3 if `CONFIG_BT_LE_UART_HCI_DMA_MODE` && `CONFIG_BT_CONTROLLER_ENABLED`

**CONFIG\_BT\_LE\_HCI\_LLDESCS\_POOL\_NUM**

The amount of lldec memory for driver dma mode

*Found in: Component config > Bluetooth > Controller Options > HCI Config*

The amount of lldec memory for driver dma mode

**Default value:**

- 20 if `CONFIG_BT_LE_UART_HCI_DMA_MODE` && `CONFIG_BT_CONTROLLER_ENABLED`

**CONFIG\_BT\_LE\_50\_FEATURE\_SUPPORT**

Enable BLE 5 feature

*Found in: Component config > Bluetooth > Controller Options*

Enable BLE 5 feature

Contains:

- `CONFIG_BT_LE_LL_CFG_FEAT_LE_2M_PHY`

- `CONFIG_BT_LE_LL_CFG_FEAT_LE_CODED_PHY`
- `CONFIG_BT_LE_POWER_CONTROL_ENABLED`
- `CONFIG_BT_LE_EXT_ADV`
- `CONFIG_BT_LE_MAX_PERIODIC_ADVERTISER_LIST`
- `CONFIG_BT_LE_MAX_PERIODIC_SYNC`

### **CONFIG\_BT\_LE\_LL\_CFG\_FEAT\_LE\_2M\_PHY**

Enable 2M Phy

*Found in:* [Component config](#) > [Bluetooth](#) > [Controller Options](#) > [CONFIG\\_BT\\_LE\\_50\\_FEATURE\\_SUPPORT](#)

Enable 2M-PHY

**Default value:**

- Yes (enabled) if `CONFIG_BT_LE_50_FEATURE_SUPPORT` && `CONFIG_BT_CONTROLLER_ENABLED`

### **CONFIG\_BT\_LE\_LL\_CFG\_FEAT\_LE\_CODED\_PHY**

Enable coded Phy

*Found in:* [Component config](#) > [Bluetooth](#) > [Controller Options](#) > [CONFIG\\_BT\\_LE\\_50\\_FEATURE\\_SUPPORT](#)

Enable coded-PHY

**Default value:**

- Yes (enabled) if `CONFIG_BT_LE_50_FEATURE_SUPPORT` && `CONFIG_BT_CONTROLLER_ENABLED`

### **CONFIG\_BT\_LE\_EXT\_ADV**

Enable extended advertising

*Found in:* [Component config](#) > [Bluetooth](#) > [Controller Options](#) > [CONFIG\\_BT\\_LE\\_50\\_FEATURE\\_SUPPORT](#)

Enable this option to do extended advertising. Extended advertising will be supported from BLE 5.0 onwards.

**Default value:**

- Yes (enabled) if `CONFIG_BT_LE_50_FEATURE_SUPPORT` && `CONFIG_BT_CONTROLLER_ENABLED`

### **CONFIG\_BT\_LE\_MAX\_EXT\_ADV\_INSTANCES**

Maximum number of extended advertising instances.

*Found in:* [Component config](#) > [Bluetooth](#) > [Controller Options](#) > [CONFIG\\_BT\\_LE\\_50\\_FEATURE\\_SUPPORT](#) > [CONFIG\\_BT\\_LE\\_EXT\\_ADV](#)

Change this option to set maximum number of extended advertising instances. Minimum there is always one instance of advertising. Enter how many more advertising instances you want. Each extended advertising instance will take about 0.5k DRAM.

**Range:**

- from 0 to 4 if `CONFIG_BT_LE_EXT_ADV` && `CONFIG_BT_LE_EXT_ADV` && `CONFIG_BT_CONTROLLER_ENABLED`

**Default value:**

- 1 if `CONFIG_BT_LE_EXT_ADV` && `CONFIG_BT_LE_EXT_ADV` && `CONFIG_BT_CONTROLLER_ENABLED`

### CONFIG\_BT\_LE\_EXT\_ADV\_MAX\_SIZE

Maximum length of the advertising data.

*Found in:* [Component config](#) > [Bluetooth](#) > [Controller Options](#) > [CONFIG\\_BT\\_LE\\_50\\_FEATURE\\_SUPPORT](#) > [CONFIG\\_BT\\_LE\\_EXT\\_ADV](#)

Defines the length of the extended adv data. The value should not exceed 1650.

**Range:**

- from 0 to 1650 if [CONFIG\\_BT\\_LE\\_EXT\\_ADV](#) && [CONFIG\\_BT\\_LE\\_EXT\\_ADV](#) && [CONFIG\\_BT\\_CONTROLLER\\_ENABLED](#)

**Default value:**

- 1650 if [CONFIG\\_BT\\_LE\\_EXT\\_ADV](#) && [CONFIG\\_BT\\_LE\\_EXT\\_ADV](#) && [CONFIG\\_BT\\_CONTROLLER\\_ENABLED](#)

### CONFIG\_BT\_LE\_ENABLE\_PERIODIC\_ADV

Enable periodic advertisement.

*Found in:* [Component config](#) > [Bluetooth](#) > [Controller Options](#) > [CONFIG\\_BT\\_LE\\_50\\_FEATURE\\_SUPPORT](#) > [CONFIG\\_BT\\_LE\\_EXT\\_ADV](#)

Enable this option to start periodic advertisement.

**Default value:**

- Yes (enabled) if [CONFIG\\_BT\\_LE\\_EXT\\_ADV](#) && [CONFIG\\_BT\\_LE\\_EXT\\_ADV](#) && [CONFIG\\_BT\\_CONTROLLER\\_ENABLED](#)

### CONFIG\_BT\_LE\_PERIODIC\_ADV\_SYNC\_TRANSFER

Enable Transfer Sync Events

*Found in:* [Component config](#) > [Bluetooth](#) > [Controller Options](#) > [CONFIG\\_BT\\_LE\\_50\\_FEATURE\\_SUPPORT](#) > [CONFIG\\_BT\\_LE\\_EXT\\_ADV](#) > [CONFIG\\_BT\\_LE\\_ENABLE\\_PERIODIC\\_ADV](#)

This enables controller transfer periodic sync events to host

**Default value:**

- Yes (enabled) if [CONFIG\\_BT\\_LE\\_ENABLE\\_PERIODIC\\_ADV](#) && [CONFIG\\_BT\\_LE\\_EXT\\_ADV](#) && [CONFIG\\_BT\\_CONTROLLER\\_ENABLED](#)

### CONFIG\_BT\_LE\_MAX\_PERIODIC\_SYNCS

Maximum number of periodic advertising syncs

*Found in:* [Component config](#) > [Bluetooth](#) > [Controller Options](#) > [CONFIG\\_BT\\_LE\\_50\\_FEATURE\\_SUPPORT](#)

Set this option to set the upper limit for number of periodic sync connections. This should be less than maximum connections allowed by controller.

### CONFIG\_BT\_LE\_MAX\_PERIODIC\_ADVERTISER\_LIST

Maximum number of periodic advertiser list

*Found in:* [Component config](#) > [Bluetooth](#) > [Controller Options](#) > [CONFIG\\_BT\\_LE\\_50\\_FEATURE\\_SUPPORT](#)

Set this option to set the upper limit for number of periodic advertiser list.

## CONFIG\_BT\_LE\_POWER\_CONTROL\_ENABLED

Enable controller support for BLE Power Control

*Found in:* [Component config](#) > [Bluetooth](#) > [Controller Options](#) > [CONFIG\\_BT\\_LE\\_50\\_FEATURE\\_SUPPORT](#)

Set this option to enable the Power Control feature on controller

**Memory Settings** Contains:

- [CONFIG\\_BT\\_LE\\_ACL\\_BUF\\_COUNT](#)
- [CONFIG\\_BT\\_LE\\_ACL\\_BUF\\_SIZE](#)
- [CONFIG\\_BT\\_LE\\_HCI\\_EVT\\_BUF\\_SIZE](#)
- [CONFIG\\_BT\\_LE\\_HCI\\_EVT\\_HI\\_BUF\\_COUNT](#)
- [CONFIG\\_BT\\_LE\\_HCI\\_EVT\\_LO\\_BUF\\_COUNT](#)
- [CONFIG\\_BT\\_LE\\_MSYS\\_1\\_BLOCK\\_COUNT](#)
- [CONFIG\\_BT\\_LE\\_MSYS\\_1\\_BLOCK\\_SIZE](#)
- [CONFIG\\_BT\\_LE\\_MSYS\\_2\\_BLOCK\\_COUNT](#)
- [CONFIG\\_BT\\_LE\\_MSYS\\_2\\_BLOCK\\_SIZE](#)

## CONFIG\_BT\_LE\_MSYS\_1\_BLOCK\_COUNT

MSYS\_1 Block Count

*Found in:* [Component config](#) > [Bluetooth](#) > [Controller Options](#) > [Memory Settings](#)

MSYS is a system level mbuf registry. For prepare write & prepare responses Mbufs are allocated out of msys\_1 pool. For NIMBLE\_MESH enabled cases, this block count is increased by 8 than user defined count.

## CONFIG\_BT\_LE\_MSYS\_1\_BLOCK\_SIZE

MSYS\_1 Block Size

*Found in:* [Component config](#) > [Bluetooth](#) > [Controller Options](#) > [Memory Settings](#)

Dynamic memory size of block 1

## CONFIG\_BT\_LE\_MSYS\_2\_BLOCK\_COUNT

MSYS\_2 Block Count

*Found in:* [Component config](#) > [Bluetooth](#) > [Controller Options](#) > [Memory Settings](#)

Dynamic memory count

## CONFIG\_BT\_LE\_MSYS\_2\_BLOCK\_SIZE

MSYS\_2 Block Size

*Found in:* [Component config](#) > [Bluetooth](#) > [Controller Options](#) > [Memory Settings](#)

Dynamic memory size of block 2

## CONFIG\_BT\_LE\_ACL\_BUF\_COUNT

ACL Buffer count

*Found in:* [Component config](#) > [Bluetooth](#) > [Controller Options](#) > [Memory Settings](#)

The number of ACL data buffers.

### CONFIG\_BT\_LE\_ACL\_BUF\_SIZE

ACL Buffer size

*Found in: Component config > Bluetooth > Controller Options > Memory Settings*

This is the maximum size of the data portion of HCI ACL data packets. It does not include the HCI data header (of 4 bytes)

### CONFIG\_BT\_LE\_HCI\_EVT\_BUF\_SIZE

HCI Event Buffer size

*Found in: Component config > Bluetooth > Controller Options > Memory Settings*

This is the size of each HCI event buffer in bytes. In case of extended advertising, packets can be fragmented. 257 bytes is the maximum size of a packet.

### CONFIG\_BT\_LE\_HCI\_EVT\_HI\_BUF\_COUNT

High Priority HCI Event Buffer count

*Found in: Component config > Bluetooth > Controller Options > Memory Settings*

This is the high priority HCI events' buffer size. High-priority event buffers are for everything except advertising reports. If there are no free high-priority event buffers then host will try to allocate a low-priority buffer instead

### CONFIG\_BT\_LE\_HCI\_EVT\_LO\_BUF\_COUNT

Low Priority HCI Event Buffer count

*Found in: Component config > Bluetooth > Controller Options > Memory Settings*

This is the low priority HCI events' buffer size. Low-priority event buffers are only used for advertising reports. If there are no free low-priority event buffers, then an incoming advertising report will get dropped

### CONFIG\_BT\_LE\_CONTROLLER\_TASK\_STACK\_SIZE

Controller task stack size

*Found in: Component config > Bluetooth > Controller Options*

This configures stack size of NimBLE controller task

**Default value:**

- 5120 if `CONFIG_BLE_MESH` && `CONFIG_BT_CONTROLLER_ENABLED`
- 4096 if `CONFIG_BT_CONTROLLER_ENABLED`

### CONFIG\_BT\_LE\_CONTROLLER\_LOG\_ENABLED

Controller log enable

*Found in: Component config > Bluetooth > Controller Options*

Enable controller log

**Default value:**

- No (disabled) if `CONFIG_BT_CONTROLLER_ENABLED`

Contains:

- `CONFIG_BT_LE_CONTROLLER_LOG_DUMP_ONLY`
- `CONFIG_BT_LE_CONTROLLER_LOG_CTRL_ENABLED`
- `CONFIG_BT_LE_CONTROLLER_LOG_HCI_ENABLED`

- [CONFIG\\_BT\\_LE\\_LOG\\_HCI\\_BUF\\_SIZE](#)
- [CONFIG\\_BT\\_LE\\_LOG\\_CTRL\\_BUF1\\_SIZE](#)
- [CONFIG\\_BT\\_LE\\_LOG\\_CTRL\\_BUF2\\_SIZE](#)
- [CONFIG\\_BT\\_LE\\_CONTROLLER\\_LOG\\_STORAGE\\_ENABLE](#)

### CONFIG\_BT\_LE\_CONTROLLER\_LOG\_CTRL\_ENABLED

enable controller log module

*Found in:* [Component config](#) > [Bluetooth](#) > [Controller Options](#) > [CONFIG\\_BT\\_LE\\_CONTROLLER\\_LOG\\_ENABLED](#)

Enable controller log module

#### Default value:

- Yes (enabled) if [CONFIG\\_BT\\_LE\\_CONTROLLER\\_LOG\\_ENABLED](#) && [CONFIG\\_BT\\_CONTROLLER\\_ENABLED](#)

### CONFIG\_BT\_LE\_CONTROLLER\_LOG\_HCI\_ENABLED

enable HCI log module

*Found in:* [Component config](#) > [Bluetooth](#) > [Controller Options](#) > [CONFIG\\_BT\\_LE\\_CONTROLLER\\_LOG\\_ENABLED](#)

Enable hci log module

#### Default value:

- Yes (enabled) if [CONFIG\\_BT\\_LE\\_CONTROLLER\\_LOG\\_ENABLED](#) && [CONFIG\\_BT\\_CONTROLLER\\_ENABLED](#)

### CONFIG\_BT\_LE\_CONTROLLER\_LOG\_DUMP\_ONLY

Controller log dump mode only

*Found in:* [Component config](#) > [Bluetooth](#) > [Controller Options](#) > [CONFIG\\_BT\\_LE\\_CONTROLLER\\_LOG\\_ENABLED](#)

Only operate in dump mode

#### Default value:

- Yes (enabled) if [CONFIG\\_BT\\_LE\\_CONTROLLER\\_LOG\\_ENABLED](#) && [CONFIG\\_BT\\_CONTROLLER\\_ENABLED](#)

### CONFIG\_BT\_LE\_CONTROLLER\_LOG\_STORAGE\_ENABLE

Store ble controller logs to flash(Experimental)

*Found in:* [Component config](#) > [Bluetooth](#) > [Controller Options](#) > [CONFIG\\_BT\\_LE\\_CONTROLLER\\_LOG\\_ENABLED](#)

Store ble controller logs to flash memory.

### CONFIG\_BT\_LE\_CONTROLLER\_LOG\_PARTITION\_SIZE

size of ble controller log partition(Multiples of 4K)

*Found in:* [Component config](#) > [Bluetooth](#) > [Controller Options](#) > [CONFIG\\_BT\\_LE\\_CONTROLLER\\_LOG\\_ENABLED](#) > [CONFIG\\_BT\\_LE\\_CONTROLLER\\_LOG\\_STORAGE\\_ENABLE](#)

The size of ble controller log partition shall be a multiples of 4K. The name of log partition shall be "bt\_ctrl\_log". The partition type shall be ESP\_PARTITION\_TYPE\_DATA. The partition sub\_type shall be ESP\_PARTITION\_SUBTYPE\_ANY.



**Default value:**

- 65536 if `CONFIG_BT_LE_CONTROLLER_LOG_STORAGE_ENABLE` && `CONFIG_BT_CONTROLLER_ENABLED`

**CONFIG\_BT\_LE\_LOG\_CTRL\_BUF1\_SIZE**

size of the first BLE controller LOG buffer

*Found in:* `Component config > Bluetooth > Controller Options > CONFIG_BT_LE_CONTROLLER_LOG_ENABLED`

Configure the size of the first BLE controller LOG buffer.

**Default value:**

- 4096 if `CONFIG_BT_LE_CONTROLLER_LOG_ENABLED` && `CONFIG_BT_CONTROLLER_ENABLED`

**CONFIG\_BT\_LE\_LOG\_CTRL\_BUF2\_SIZE**

size of the second BLE controller LOG buffer

*Found in:* `Component config > Bluetooth > Controller Options > CONFIG_BT_LE_CONTROLLER_LOG_ENABLED`

Configure the size of the second BLE controller LOG buffer.

**Default value:**

- 1024 if `CONFIG_BT_LE_CONTROLLER_LOG_ENABLED` && `CONFIG_BT_CONTROLLER_ENABLED`

**CONFIG\_BT\_LE\_LOG\_HCI\_BUF\_SIZE**

size of the BLE HCI LOG buffer

*Found in:* `Component config > Bluetooth > Controller Options > CONFIG_BT_LE_CONTROLLER_LOG_ENABLED`

Configure the size of the BLE HCI LOG buffer.

**Default value:**

- 4096 if `CONFIG_BT_LE_CONTROLLER_LOG_ENABLED` && `CONFIG_BT_CONTROLLER_ENABLED`

**CONFIG\_BT\_LE\_LL\_RESOLV\_LIST\_SIZE**

BLE LL Resolving list size

*Found in:* `Component config > Bluetooth > Controller Options`

Configure the size of resolving list used in link layer.

**Range:**

- from 1 to 5 if `CONFIG_BT_CONTROLLER_ENABLED`

**Default value:**

- 4 if `CONFIG_BT_CONTROLLER_ENABLED`

**CONFIG\_BT\_LE\_SECURITY\_ENABLE**

Enable BLE SM feature

*Found in:* `Component config > Bluetooth > Controller Options`

Enable BLE sm feature

Contains:

- `CONFIG_BT_LE_LL_CFG_FEAT_LE_ENCRYPTION`
- `CONFIG_BT_LE_SM_LEGACY`
- `CONFIG_BT_LE_SM_SC`

### CONFIG\_BT\_LE\_SM\_LEGACY

Security manager legacy pairing

*Found in: Component config > Bluetooth > Controller Options > CONFIG\_BT\_LE\_SECURITY\_ENABLE*

Enable security manager legacy pairing

**Default value:**

- Yes (enabled) if `CONFIG_BT_LE_SECURITY_ENABLE` && `CONFIG_BT_CONTROLLER_ENABLED`

### CONFIG\_BT\_LE\_SM\_SC

Security manager secure connections (4.2)

*Found in: Component config > Bluetooth > Controller Options > CONFIG\_BT\_LE\_SECURITY\_ENABLE*

Enable security manager secure connections

**Default value:**

- Yes (enabled) if `CONFIG_BT_LE_SECURITY_ENABLE` && `CONFIG_BT_CONTROLLER_ENABLED`

### CONFIG\_BT\_LE\_SM\_SC\_DEBUG\_KEYS

Use predefined public-private key pair

*Found in: Component config > Bluetooth > Controller Options > CONFIG\_BT\_LE\_SECURITY\_ENABLE > CONFIG\_BT\_LE\_SM\_SC*

If this option is enabled, SM uses predefined DH key pair as described in Core Specification, Vol. 3, Part H, 2.3.5.6.1. This allows to decrypt air traffic easily and thus should only be used for debugging.

**Default value:**

- No (disabled) if `CONFIG_BT_LE_SECURITY_ENABLE` && `CONFIG_BT_LE_SM_SC` && `CONFIG_BT_CONTROLLER_ENABLED`

### CONFIG\_BT\_LE\_LL\_CFG\_FEAT\_LE\_ENCRYPTION

Enable LE encryption

*Found in: Component config > Bluetooth > Controller Options > CONFIG\_BT\_LE\_SECURITY\_ENABLE*

Enable encryption connection

**Default value:**

- Yes (enabled) if `CONFIG_BT_LE_SECURITY_ENABLE` && `CONFIG_BT_CONTROLLER_ENABLED`

### CONFIG\_BT\_LE\_CRYPTOSTACK\_MBEDTLS

Override TinyCrypt with mbedTLS for crypto computations

*Found in: Component config > Bluetooth > Controller Options*

Enable this option to choose mbedTLS instead of TinyCrypt for crypto computations.

### CONFIG\_BT\_LE\_WHITELIST\_SIZE

BLE white list size

*Found in: Component config > Bluetooth > Controller Options*

BLE list size

### CONFIG\_BT\_LE\_LL\_DUP\_SCAN\_LIST\_COUNT

BLE duplicate scan list count

*Found in: Component config > Bluetooth > Controller Options*

config the max count of duplicate scan list

**Range:**

- from 5 to 100 if `CONFIG_BT_CONTROLLER_ENABLED`

**Default value:**

- 20 if `CONFIG_BT_CONTROLLER_ENABLED`

### CONFIG\_BT\_LE\_LL\_SCA

BLE Sleep clock accuracy

*Found in: Component config > Bluetooth > Controller Options*

Sleep clock accuracy of our device (in ppm)

**Range:**

- from 0 to 500 if `CONFIG_BT_CONTROLLER_ENABLED`

**Default value:**

- 60 if `CONFIG_BT_CONTROLLER_ENABLED`

### CONFIG\_BT\_LE\_MAX\_CONNECTIONS

Maximum number of concurrent connections

*Found in: Component config > Bluetooth > Controller Options*

Defines maximum number of concurrent BLE connections. For ESP32, user is expected to configure `BTDM_CTRL_BLE_MAX_CONN` from controller menu along with this option. Similarly for ESP32-C3 or ESP32-S3, user is expected to configure `BT_CTRL_BLE_MAX_ACT` from controller menu. Each connection will take about 1k DRAM.

### CONFIG\_BT\_LE\_COEX\_PHY\_CODED\_TX\_RX\_TLIM

Coexistence: limit on MAX Tx/Rx time for coded-PHY connection

*Found in: Component config > Bluetooth > Controller Options*

When using PHY-Coded in BLE connection, limitation on max tx/rx time can be applied to better avoid dramatic performance deterioration of Wi-Fi.

Available options:

- Force Enable (`CONFIG_BT_LE_COEX_PHY_CODED_TX_RX_TLIM_EN`)  
Always enable the limitation on max tx/rx time for Coded-PHY connection
- Force Disable (`CONFIG_BT_LE_COEX_PHY_CODED_TX_RX_TLIM_DIS`)  
Disable the limitation on max tx/rx time for Coded-PHY connection

### CONFIG\_BT\_LE\_SLEEP\_ENABLE

Enable BLE sleep

*Found in: Component config > Bluetooth > Controller Options*

Enable BLE sleep

**Default value:**

- No (disabled) if *CONFIG\_BT\_CONTROLLER\_ENABLED*

### CONFIG\_BT\_LE\_LP\_CLK\_SRC

BLE low power clock source

*Found in: Component config > Bluetooth > Controller Options*

Available options:

- Use main XTAL as RTC clock source (*CONFIG\_BT\_LE\_LP\_CLK\_SRC\_MAIN\_XTAL*)  
User main XTAL as RTC clock source. This option is recommended if external 32.768k XTAL is not available. Using the external 32.768 kHz XTAL will have lower current consumption in light sleep compared to using the main XTAL.
- Use system RTC slow clock source (*CONFIG\_BT\_LE\_LP\_CLK\_SRC\_DEFAULT*)  
Use the same slow clock source as system RTC Using any clock source other than external 32.768 kHz XTAL supports only legacy ADV and SCAN due to low clock accuracy.

### CONFIG\_BT\_LE\_USE\_ESP\_TIMER

Enable Esp Timer for Callout

*Found in: Component config > Bluetooth > Controller Options*

Set this option to use Esp Timer which has higher priority timer instead of FreeRTOS timer

### CONFIG\_BT\_CTRL\_BLE\_ADV\_REPORT\_FLOW\_CTRL\_SUPP

BLE adv report flow control supported

*Found in: Component config > Bluetooth > Controller Options*

The function is mainly used to enable flow control for advertising reports. When it is enabled, advertising reports will be discarded by the controller if the number of unprocessed advertising reports exceeds the size of BLE adv report flow control.

**Default value:**

- Yes (enabled) if *CONFIG\_BT\_CONTROLLER\_ENABLED*

### CONFIG\_BT\_CTRL\_BLE\_ADV\_REPORT\_FLOW\_CTRL\_NUM

BLE adv report flow control number

*Found in: Component config > Bluetooth > Controller Options > CONFIG\_BT\_CTRL\_BLE\_ADV\_REPORT\_FLOW\_CTRL\_SUPP*

The number of unprocessed advertising report that bluetooth host can save. If you set *BT\_CTRL\_BLE\_ADV\_REPORT\_FLOW\_CTRL\_NUM* to a small value, this may cause adv packets lost. If you set *BT\_CTRL\_BLE\_ADV\_REPORT\_FLOW\_CTRL\_NUM* to a large value, bluetooth host may cache a lot of adv packets and this may cause system memory run out. For example, if you set it to 50, the maximum memory consumed by host is 35 \* 50 bytes. Please set *BT\_CTRL\_BLE\_ADV\_REPORT\_FLOW\_CTRL\_NUM* according to your system free memory and handle adv packets as fast as possible, otherwise it will cause adv packets lost.

**Range:**

- from 50 to 1000 if `CONFIG_BT_CTRL_BLE_ADV_REPORT_FLOW_CTRL_SUPP` && `CONFIG_BT_CONTROLLER_ENABLED`

**Default value:**

- 100 if `CONFIG_BT_CTRL_BLE_ADV_REPORT_FLOW_CTRL_SUPP` && `CONFIG_BT_CONTROLLER_ENABLED`

**CONFIG\_BT\_CTRL\_BLE\_ADV\_REPORT\_DISCARD\_THRSHOLD**

BLE adv lost event threshold value

*Found in:* `Component config > Bluetooth > Controller Options > CONFIG_BT_CTRL_BLE_ADV_REPORT_FLOW_CTRL_SUPP`

When adv report flow control is enabled, The ADV lost event will be generated when the number of ADV packets lost in the controller reaches this threshold. It is better to set a larger value. If you set `BT_CTRL_BLE_ADV_REPORT_DISCARD_THRSHOLD` to a small value or printf every adv lost event, it may cause adv packets lost more.

**Range:**

- from 1 to 1000 if `CONFIG_BT_CTRL_BLE_ADV_REPORT_FLOW_CTRL_SUPP` && `CONFIG_BT_CONTROLLER_ENABLED`

**Default value:**

- 20 if `CONFIG_BT_CTRL_BLE_ADV_REPORT_FLOW_CTRL_SUPP` && `CONFIG_BT_CONTROLLER_ENABLED`

**CONFIG\_BT\_LE\_SCAN\_DUPL**

BLE Scan Duplicate Options

*Found in:* `Component config > Bluetooth > Controller Options`

This select enables parameters setting of BLE scan duplicate.

**Default value:**

- Yes (enabled) if `CONFIG_BT_CONTROLLER_ENABLED`

**CONFIG\_BT\_LE\_SCAN\_DUPL\_TYPE**

Scan Duplicate Type

*Found in:* `Component config > Bluetooth > Controller Options > CONFIG_BT_LE_SCAN_DUPL`

Scan duplicate have three ways. one is "Scan Duplicate By Device Address", This way is to use advertiser address filtering. The adv packet of the same address is only allowed to be reported once. Another way is "Scan Duplicate By Device Address And Advertising Data". This way is to use advertising data and device address filtering. All different adv packets with the same address are allowed to be reported. The last way is "Scan Duplicate By Advertising Data". This way is to use advertising data filtering. All same advertising data only allow to be reported once even though they are from different devices.

Available options:

- Scan Duplicate By Device Address (`CONFIG_BT_LE_SCAN_DUPL_TYPE_DEVICE`)  
This way is to use advertiser address filtering. The adv packet of the same address is only allowed to be reported once
- Scan Duplicate By Advertising Data (`CONFIG_BT_LE_SCAN_DUPL_TYPE_DATA`)  
This way is to use advertising data filtering. All same advertising data only allow to be reported once even though they are from different devices.
- Scan Duplicate By Device Address And Advertising Data (`CONFIG_BT_LE_SCAN_DUPL_TYPE_DATA_DEVICE`)

This way is to use advertising data and device address filtering. All different adv packets with the same address are allowed to be reported.

### CONFIG\_BT\_LE\_SCAN\_DUPL\_CACHE\_REFRESH\_PERIOD

Duplicate scan list refresh period (seconds)

*Found in: Component config > Bluetooth > Controller Options > CONFIG\_BT\_LE\_SCAN\_DUPL*

If the period value is non-zero, the controller will periodically clear the device information stored in the scan duplicate filter. If it is 0, the scan duplicate filter will not be cleared until the scanning is disabled. Duplicate advertisements for this period should not be sent to the Host in advertising report events. There are two scenarios where the ADV packet will be repeatedly reported: 1. The duplicate scan cache is full, the controller will delete the oldest device information and add new device information. 2. When the refresh period is up, the controller will clear all device information and start filtering again.

**Range:**

- from 0 to 1000 if `CONFIG_BT_LE_SCAN_DUPL` && `CONFIG_BT_CONTROLLER_ENABLED`

**Default value:**

- 0 if `CONFIG_BT_LE_SCAN_DUPL` && `CONFIG_BT_CONTROLLER_ENABLED`

### CONFIG\_BT\_LE\_TX\_CCA\_ENABLED

Enable TX CCA feature

*Found in: Component config > Bluetooth > Controller Options*

Enable CCA feature to cancel sending the packet if the signal power is stronger than CCA threshold.

**Default value:**

- No (disabled) if `CONFIG_BT_CONTROLLER_ENABLED`

### CONFIG\_BT\_LE\_CCA\_RSSI\_THRESH

CCA RSSI threshold value

*Found in: Component config > Bluetooth > Controller Options > CONFIG\_BT\_LE\_TX\_CCA\_ENABLED*

Power threshold of CCA in unit of -1 dBm.

**Range:**

- from 20 to 100 if `CONFIG_BT_LE_TX_CCA_ENABLED` && `CONFIG_BT_CONTROLLER_ENABLED`

**Default value:**

- 20 if `CONFIG_BT_LE_TX_CCA_ENABLED` && `CONFIG_BT_CONTROLLER_ENABLED`

### CONFIG\_BT\_LE\_DFT\_TX\_POWER\_LEVEL\_DBM

BLE default Tx power level(dBm)

*Found in: Component config > Bluetooth > Controller Options*

Specify default Tx power level(dBm).

Available options:

- -24dBm (`CONFIG_BT_LE_DFT_TX_POWER_LEVEL_N24`)
- -21dBm (`CONFIG_BT_LE_DFT_TX_POWER_LEVEL_N21`)
- -18dBm (`CONFIG_BT_LE_DFT_TX_POWER_LEVEL_N18`)
- -15dBm (`CONFIG_BT_LE_DFT_TX_POWER_LEVEL_N15`)
- -12dBm (`CONFIG_BT_LE_DFT_TX_POWER_LEVEL_N12`)

- **-9dBm** (CONFIG\_BT\_LE\_DFT\_TX\_POWER\_LEVEL\_N9)
- **-6dBm** (CONFIG\_BT\_LE\_DFT\_TX\_POWER\_LEVEL\_N6)
- **-3dBm** (CONFIG\_BT\_LE\_DFT\_TX\_POWER\_LEVEL\_N3)
- **0dBm** (CONFIG\_BT\_LE\_DFT\_TX\_POWER\_LEVEL\_N0)
- **+3dBm** (CONFIG\_BT\_LE\_DFT\_TX\_POWER\_LEVEL\_P3)
- **+6dBm** (CONFIG\_BT\_LE\_DFT\_TX\_POWER\_LEVEL\_P6)
- **+9dBm** (CONFIG\_BT\_LE\_DFT\_TX\_POWER\_LEVEL\_P9)
- **+12dBm** (CONFIG\_BT\_LE\_DFT\_TX\_POWER\_LEVEL\_P12)
- **+15dBm** (CONFIG\_BT\_LE\_DFT\_TX\_POWER\_LEVEL\_P15)
- **+18dBm** (CONFIG\_BT\_LE\_DFT\_TX\_POWER\_LEVEL\_P18)
- **+20dBm** (CONFIG\_BT\_LE\_DFT\_TX\_POWER\_LEVEL\_P20)

### CONFIG\_BT\_RELEASE\_IRAM

Release Bluetooth text (READ DOCS FIRST)

Found in: *Component config > Bluetooth*

This option release Bluetooth text section and merge Bluetooth data, bss & text into a large free heap region when esp\_bt\_mem\_release is called, total saving ~21kB or more of IRAM. ESP32-C2 only 3 configurable PMP entries available, rest of them are hard-coded. We cannot split the memory into 3 different regions (IRAM, BLE-IRAM, DRAM). So this option will disable the PMP (ESP\_SYSTEM\_PMP\_IDRAM\_SPLIT)

**Default value:**

- No (disabled) if *CONFIG\_BT\_ENABLED* && *BT\_LE\_RELEASE\_IRAM\_SUPPORTED*

**Common Options** Contains:

- *CONFIG\_BT\_ALARM\_MAX\_NUM*

### CONFIG\_BT\_ALARM\_MAX\_NUM

Maximum number of Bluetooth alarms

Found in: *Component config > Bluetooth > Common Options*

This option decides the maximum number of alarms which could be used by Bluetooth host.

**Default value:**

- 50

### CONFIG\_BT\_HCI\_LOG\_DEBUG\_EN

Enable Bluetooth HCI debug mode

Found in: *Component config > Bluetooth*

This option is used to enable bluetooth debug mode, which saves the hci layer data stream.

**Default value:**

- No (disabled) if *CONFIG\_BT\_BLUEDROID\_ENABLED* || *CONFIG\_BT\_NIMBLE\_ENABLED*

### CONFIG\_BT\_HCI\_LOG\_DATA\_BUFFER\_SIZE

Size of the cache used for HCI data in Bluetooth HCI debug mode (N\*1024 bytes)

Found in: *Component config > Bluetooth > CONFIG\_BT\_HCI\_LOG\_DEBUG\_EN*

This option is to configure the buffer size of the hci data steam cache in hci debug mode. This is a ring buffer, the new data will overwrite the oldest data if the buffer is full.

**Range:**

- from 1 to 100 if `CONFIG_BT_HCI_LOG_DEBUG_EN`

**Default value:**

- 5 if `CONFIG_BT_HCI_LOG_DEBUG_EN`

**CONFIG\_BT\_HCI\_LOG\_ADV\_BUFFER\_SIZE**

Size of the cache used for adv report in Bluetooth HCI debug mode (N\*1024 bytes)

*Found in: Component config > Bluetooth > CONFIG\_BT\_HCI\_LOG\_DEBUG\_EN*

This option is to configure the buffer size of the hci adv report cache in hci debug mode. This is a ring buffer, the new data will overwrite the oldest data if the buffer is full.

**Range:**

- from 1 to 100 if `CONFIG_BT_HCI_LOG_DEBUG_EN`

**Default value:**

- 8 if `CONFIG_BT_HCI_LOG_DEBUG_EN`

**CONFIG\_BLE\_MESH**

ESP BLE Mesh Support

*Found in: Component config*

This option enables ESP BLE Mesh support. The specific features that are available may depend on other features that have been enabled in the stack, such as Bluetooth Support, Bluedroid Support & GATT support.

Contains:

- *BLE Mesh and BLE coexistence support*
- `CONFIG_BLE_MESH_GATT_PROXY_CLIENT`
- `CONFIG_BLE_MESH_GATT_PROXY_SERVER`
- `BLE Mesh NET BUF DEBUG LOG LEVEL`
- `CONFIG_BLE_MESH_PROV`
- `CONFIG_BLE_MESH_PROXY`
- *BLE Mesh specific test option*
- `BLE Mesh STACK DEBUG LOG LEVEL`
- `CONFIG_BLE_MESH_NO_LOG`
- `CONFIG_BLE_MESH_IVU_DIVIDER`
- `CONFIG_BLE_MESH_FAST_PROV`
- `CONFIG_BLE_MESH_FREERTOS_STATIC_ALLOC`
- `CONFIG_BLE_MESH_EXPERIMENTAL`
- `CONFIG_BLE_MESH_CRPL`
- `CONFIG_BLE_MESH_RX_SDU_MAX`
- `CONFIG_BLE_MESH_MODEL_KEY_COUNT`
- `CONFIG_BLE_MESH_APP_KEY_COUNT`
- `CONFIG_BLE_MESH_MODEL_GROUP_COUNT`
- `CONFIG_BLE_MESH_LABEL_COUNT`
- `CONFIG_BLE_MESH_SUBNET_COUNT`
- `CONFIG_BLE_MESH_TX_SEG_MAX`
- `CONFIG_BLE_MESH_RX_SEG_MSG_COUNT`
- `CONFIG_BLE_MESH_TX_SEG_MSG_COUNT`
- `CONFIG_BLE_MESH_MEM_ALLOC_MODE`
- `CONFIG_BLE_MESH_MSG_CACHE_SIZE`
- `CONFIG_BLE_MESH_NOT_RELAY_REPLAY_MSG`
- `CONFIG_BLE_MESH_ADV_BUF_COUNT`
- `CONFIG_BLE_MESH_PB_GATT`
- `CONFIG_BLE_MESH_PB_ADV`
- `CONFIG_BLE_MESH_IVU_RECOVERY_IVI`
- `CONFIG_BLE_MESH_RELAY`



- [CONFIG\\_BLE\\_MESH\\_SAR\\_ENHANCEMENT](#)
- [CONFIG\\_BLE\\_MESH\\_SETTINGS](#)
- [CONFIG\\_BLE\\_MESH\\_ACTIVE\\_SCAN](#)
- [CONFIG\\_BLE\\_MESH\\_DEINIT](#)
- [CONFIG\\_BLE\\_MESH\\_USE\\_DUPLICATE\\_SCAN](#)
- [Support for BLE Mesh Client/Server models](#)
- [Support for BLE Mesh Foundation models](#)
- [CONFIG\\_BLE\\_MESH\\_NODE](#)
- [CONFIG\\_BLE\\_MESH\\_PROVISIONER](#)
- [CONFIG\\_BLE\\_MESH\\_FRIEND](#)
- [CONFIG\\_BLE\\_MESH\\_LOW\\_POWER](#)
- [CONFIG\\_BLE\\_MESH\\_HCI\\_5\\_0](#)
- [CONFIG\\_BLE\\_MESH\\_RANDOM\\_ADV\\_INTERVAL](#)
- [CONFIG\\_BLE\\_MESH\\_IV\\_UPDATE\\_TEST](#)
- [CONFIG\\_BLE\\_MESH\\_CLIENT\\_MSG\\_TIMEOUT](#)

### **CONFIG\_BLE\_MESH\_HCI\_5\_0**

Support sending 20ms non-connectable adv packets

*Found in: Component config > CONFIG\_BLE\_MESH*

It is a temporary solution and needs further modifications.

**Default value:**

- Yes (enabled) if [CONFIG\\_BLE\\_MESH](#)

### **CONFIG\_BLE\_MESH\_RANDOM\_ADV\_INTERVAL**

Support using random adv interval for mesh packets

*Found in: Component config > CONFIG\_BLE\_MESH*

Enable this option to allow using random advertising interval for mesh packets. And this could help avoid collision of advertising packets.

**Default value:**

- No (disabled) if [CONFIG\\_BLE\\_MESH](#)

### **CONFIG\_BLE\_MESH\_USE\_DUPLICATE\_SCAN**

Support Duplicate Scan in BLE Mesh

*Found in: Component config > CONFIG\_BLE\_MESH*

Enable this option to allow using specific duplicate scan filter in BLE Mesh, and Scan Duplicate Type must be set by choosing the option in the Bluetooth Controller section in menuconfig, which is "Scan Duplicate By Device Address and Advertising Data".

**Default value:**

- Yes (enabled) if [CONFIG\\_BLE\\_MESH](#)

### **CONFIG\_BLE\_MESH\_ACTIVE\_SCAN**

Support Active Scan in BLE Mesh

*Found in: Component config > CONFIG\_BLE\_MESH*

Enable this option to allow using BLE Active Scan for BLE Mesh.

## CONFIG\_BLE\_MESH\_MEM\_ALLOC\_MODE

Memory allocation strategy

Found in: *Component config* > *CONFIG\_BLE\_MESH*

Allocation strategy for BLE Mesh stack, essentially provides ability to allocate all required dynamic allocations from,

- Internal DRAM memory only
- External SPIRAM memory only
- Either internal or external memory based on default malloc() behavior in ESP-IDF
- Internal IRAM memory wherever applicable else internal DRAM

Recommended mode here is always internal (\*), since that is most preferred from security perspective. But if application requirement does not allow sufficient free internal memory then alternate mode can be selected.

(\*) In case of ESP32-S2/ESP32-S3, hardware allows encryption of external SPIRAM contents provided hardware flash encryption feature is enabled. In that case, using external SPIRAM allocation strategy is also safe choice from security perspective.

Available options:

- Internal DRAM (CONFIG\_BLE\_MESH\_MEM\_ALLOC\_MODE\_INTERNAL)
- External SPIRAM (CONFIG\_BLE\_MESH\_MEM\_ALLOC\_MODE\_EXTERNAL)
- Default alloc mode (CONFIG\_BLE\_MESH\_MEM\_ALLOC\_MODE\_DEFAULT)  
Enable this option to use the default memory allocation strategy when external SPIRAM is enabled. See the SPIRAM options for more details.
- Internal IRAM (CONFIG\_BLE\_MESH\_MEM\_ALLOC\_MODE\_IRAM\_8BIT)  
Allows to use IRAM memory region as 8bit accessible region. Every unaligned (8bit or 16bit) access will result in an exception and incur penalty of certain clock cycles per unaligned read/write.

## CONFIG\_BLE\_MESH\_FREERTOS\_STATIC\_ALLOC

Enable FreeRTOS static allocation

Found in: *Component config* > *CONFIG\_BLE\_MESH*

Enable this option to use FreeRTOS static allocation APIs for BLE Mesh, which provides the ability to use different dynamic memory (i.e. SPIRAM or IRAM) for FreeRTOS objects. If this option is disabled, the FreeRTOS static allocation APIs will not be used, and internal DRAM will be allocated for FreeRTOS objects.

**Default value:**

- No (disabled) if ESP32\_IRAM\_AS\_8BIT\_ACCESSIBLE\_MEMORY && *CONFIG\_BLE\_MESH*

## CONFIG\_BLE\_MESH\_FREERTOS\_STATIC\_ALLOC\_MODE

Memory allocation for FreeRTOS objects

Found in: *Component config* > *CONFIG\_BLE\_MESH* > *CONFIG\_BLE\_MESH\_FREERTOS\_STATIC\_ALLOC*

Choose the memory to be used for FreeRTOS objects.

Available options:

- External SPIRAM (CONFIG\_BLE\_MESH\_FREERTOS\_STATIC\_ALLOC\_EXTERNAL)  
If enabled, BLE Mesh allocates dynamic memory from external SPIRAM for FreeRTOS objects, i.e. mutex, queue, and task stack. External SPIRAM can only be used for task stack when SPIRAM\_ALLOW\_STACK\_EXTERNAL\_MEMORY is enabled. See the SPIRAM options for more details.
- Internal IRAM (CONFIG\_BLE\_MESH\_FREERTOS\_STATIC\_ALLOC\_IRAM\_8BIT)  
If enabled, BLE Mesh allocates dynamic memory from internal IRAM for FreeRTOS objects, i.e. mutex, queue. Note: IRAM region cannot be used as task stack.

### CONFIG\_BLE\_MESH\_DEINIT

Support de-initialize BLE Mesh stack

*Found in: Component config > CONFIG\_BLE\_MESH*

If enabled, users can use the function `esp_ble_mesh_deinit()` to de-initialize the whole BLE Mesh stack.

**Default value:**

- Yes (enabled) if *CONFIG\_BLE\_MESH*

**BLE Mesh and BLE coexistence support** Contains:

- *CONFIG\_BLE\_MESH\_SUPPORT\_BLE\_SCAN*
- *CONFIG\_BLE\_MESH\_SUPPORT\_BLE\_ADV*

### CONFIG\_BLE\_MESH\_SUPPORT\_BLE\_ADV

Support sending normal BLE advertising packets

*Found in: Component config > CONFIG\_BLE\_MESH > BLE Mesh and BLE coexistence support*

When selected, users can send normal BLE advertising packets with specific API.

**Default value:**

- No (disabled) if *CONFIG\_BLE\_MESH*

### CONFIG\_BLE\_MESH\_BLE\_ADV\_BUF\_COUNT

Number of advertising buffers for BLE advertising packets

*Found in: Component config > CONFIG\_BLE\_MESH > BLE Mesh and BLE coexistence support > CONFIG\_BLE\_MESH\_SUPPORT\_BLE\_ADV*

Number of advertising buffers for BLE packets available.

**Range:**

- from 1 to 255 if *CONFIG\_BLE\_MESH\_SUPPORT\_BLE\_ADV* && *CONFIG\_BLE\_MESH*

**Default value:**

- 3 if *CONFIG\_BLE\_MESH\_SUPPORT\_BLE\_ADV* && *CONFIG\_BLE\_MESH*

### CONFIG\_BLE\_MESH\_SUPPORT\_BLE\_SCAN

Support scanning normal BLE advertising packets

*Found in: Component config > CONFIG\_BLE\_MESH > BLE Mesh and BLE coexistence support*

When selected, users can register a callback and receive normal BLE advertising packets in the application layer.

**Default value:**

- No (disabled) if *CONFIG\_BLE\_MESH*

### CONFIG\_BLE\_MESH\_FAST\_PROV

Enable BLE Mesh Fast Provisioning

*Found in:* [Component config](#) > [CONFIG\\_BLE\\_MESH](#)

Enable this option to allow BLE Mesh fast provisioning solution to be used. When there are multiple unprovisioned devices around, fast provisioning can greatly reduce the time consumption of the whole provisioning process. When this option is enabled, and after an unprovisioned device is provisioned into a node successfully, it can be changed to a temporary Provisioner.

**Default value:**

- No (disabled) if [CONFIG\\_BLE\\_MESH](#)

### CONFIG\_BLE\_MESH\_NODE

Support for BLE Mesh Node

*Found in:* [Component config](#) > [CONFIG\\_BLE\\_MESH](#)

Enable the device to be provisioned into a node. This option should be enabled when an unprovisioned device is going to be provisioned into a node and communicate with other nodes in the BLE Mesh network.

### CONFIG\_BLE\_MESH\_PROVISIONER

Support for BLE Mesh Provisioner

*Found in:* [Component config](#) > [CONFIG\\_BLE\\_MESH](#)

Enable the device to be a Provisioner. The option should be enabled when a device is going to act as a Provisioner and provision unprovisioned devices into the BLE Mesh network.

### CONFIG\_BLE\_MESH\_WAIT\_FOR\_PROV\_MAX\_DEV\_NUM

Maximum number of unprovisioned devices that can be added to device queue

*Found in:* [Component config](#) > [CONFIG\\_BLE\\_MESH](#) > [CONFIG\\_BLE\\_MESH\\_PROVISIONER](#)

This option specifies how many unprovisioned devices can be added to device queue for provisioning. Users can use this option to define the size of the queue in the bottom layer which is used to store unprovisioned device information (e.g. Device UUID, address).

**Range:**

- from 1 to 100 if [CONFIG\\_BLE\\_MESH\\_PROVISIONER](#) && [CONFIG\\_BLE\\_MESH](#)

**Default value:**

- 10 if [CONFIG\\_BLE\\_MESH\\_PROVISIONER](#) && [CONFIG\\_BLE\\_MESH](#)

### CONFIG\_BLE\_MESH\_MAX\_PROV\_NODES

Maximum number of devices that can be provisioned by Provisioner

*Found in:* [Component config](#) > [CONFIG\\_BLE\\_MESH](#) > [CONFIG\\_BLE\\_MESH\\_PROVISIONER](#)

This option specifies how many devices can be provisioned by a Provisioner. This value indicates the maximum number of unprovisioned devices which can be provisioned by a Provisioner. For instance, if the value is 6, it means the Provisioner can provision up to 6 unprovisioned devices. Theoretically a Provisioner without the limitation of its memory can provision up to 32766 unprovisioned devices, here we limit the maximum number to 100 just to limit the memory used by a Provisioner. The bigger the value is, the more memory it will cost by a Provisioner to store the information of nodes.

**Range:**

- from 1 to 1000 if [CONFIG\\_BLE\\_MESH\\_PROVISIONER](#) && [CONFIG\\_BLE\\_MESH](#)

**Default value:**

- 10 if `CONFIG_BLE_MESH_PROVISIONER` && `CONFIG_BLE_MESH`

### **CONFIG\_BLE\_MESH\_PBA\_SAME\_TIME**

Maximum number of PB-ADV running at the same time by Provisioner

*Found in: Component config > CONFIG\_BLE\_MESH > CONFIG\_BLE\_MESH\_PROVISIONER*

This option specifies how many devices can be provisioned at the same time using PB-ADV. For example, if the value is 2, it means a Provisioner can provision two unprovisioned devices with PB-ADV at the same time.

**Range:**

- from 1 to 10 if `CONFIG_BLE_MESH_PB_ADV` && `CONFIG_BLE_MESH_PROVISIONER` && `CONFIG_BLE_MESH`

**Default value:**

- 2 if `CONFIG_BLE_MESH_PB_ADV` && `CONFIG_BLE_MESH_PROVISIONER` && `CONFIG_BLE_MESH`

### **CONFIG\_BLE\_MESH\_PBG\_SAME\_TIME**

Maximum number of PB-GATT running at the same time by Provisioner

*Found in: Component config > CONFIG\_BLE\_MESH > CONFIG\_BLE\_MESH\_PROVISIONER*

This option specifies how many devices can be provisioned at the same time using PB-GATT. For example, if the value is 2, it means a Provisioner can provision two unprovisioned devices with PB-GATT at the same time.

**Range:**

- from 1 to 5 if `CONFIG_BLE_MESH_PB_GATT` && `CONFIG_BLE_MESH_PROVISIONER` && `CONFIG_BLE_MESH`

**Default value:**

- 1 if `CONFIG_BLE_MESH_PB_GATT` && `CONFIG_BLE_MESH_PROVISIONER` && `CONFIG_BLE_MESH`

### **CONFIG\_BLE\_MESH\_PROVISIONER\_SUBNET\_COUNT**

Maximum number of mesh subnets that can be created by Provisioner

*Found in: Component config > CONFIG\_BLE\_MESH > CONFIG\_BLE\_MESH\_PROVISIONER*

This option specifies how many subnets per network a Provisioner can create. Indeed, this value decides the number of network keys which can be added by a Provisioner.

**Range:**

- from 1 to 4096 if `CONFIG_BLE_MESH_PROVISIONER` && `CONFIG_BLE_MESH`

**Default value:**

- 3 if `CONFIG_BLE_MESH_PROVISIONER` && `CONFIG_BLE_MESH`

### **CONFIG\_BLE\_MESH\_PROVISIONER\_APP\_KEY\_COUNT**

Maximum number of application keys that can be owned by Provisioner

*Found in: Component config > CONFIG\_BLE\_MESH > CONFIG\_BLE\_MESH\_PROVISIONER*

This option specifies how many application keys the Provisioner can have. Indeed, this value decides the number of the application keys which can be added by a Provisioner.

**Range:**

- from 1 to 4096 if `CONFIG_BLE_MESH_PROVISIONER` && `CONFIG_BLE_MESH`

**Default value:**

- 3 if `CONFIG_BLE_MESH_PROVISIONER` && `CONFIG_BLE_MESH`

### CONFIG\_BLE\_MESH\_PROVISIONER\_RECV\_HB

Support receiving Heartbeat messages

*Found in:* *Component config* > *CONFIG\_BLE\_MESH* > *CONFIG\_BLE\_MESH\_PROVISIONER*

When this option is enabled, Provisioner can call specific functions to enable or disable receiving Heartbeat messages and notify them to the application layer.

**Default value:**

- No (disabled) if *CONFIG\_BLE\_MESH\_PROVISIONER* && *CONFIG\_BLE\_MESH*

### CONFIG\_BLE\_MESH\_PROVISIONER\_RECV\_HB\_FILTER\_SIZE

Maximum number of filter entries for receiving Heartbeat messages

*Found in:* *Component config* > *CONFIG\_BLE\_MESH* > *CONFIG\_BLE\_MESH\_PROVISIONER* > *CONFIG\_BLE\_MESH\_PROVISIONER\_RECV\_HB*

This option specifies how many heartbeat filter entries Provisioner supports. The heartbeat filter (acceptlist or rejectlist) entries are used to store a list of SRC and DST which can be used to decide if a heartbeat message will be processed and notified to the application layer by Provisioner. Note: The filter is an empty rejectlist by default.

**Range:**

- from 1 to 1000 if *CONFIG\_BLE\_MESH\_PROVISIONER\_RECV\_HB* && *CONFIG\_BLE\_MESH\_PROVISIONER* && *CONFIG\_BLE\_MESH*

**Default value:**

- 3 if *CONFIG\_BLE\_MESH\_PROVISIONER\_RECV\_HB* && *CONFIG\_BLE\_MESH\_PROVISIONER* && *CONFIG\_BLE\_MESH*

### CONFIG\_BLE\_MESH\_PROV

BLE Mesh Provisioning support

*Found in:* *Component config* > *CONFIG\_BLE\_MESH*

Enable this option to support BLE Mesh Provisioning functionality. For BLE Mesh, this option should be always enabled.

**Default value:**

- Yes (enabled) if *CONFIG\_BLE\_MESH*

### CONFIG\_BLE\_MESH\_PROV\_EPA

BLE Mesh enhanced provisioning authentication

*Found in:* *Component config* > *CONFIG\_BLE\_MESH* > *CONFIG\_BLE\_MESH\_PROV*

Enable this option to support BLE Mesh enhanced provisioning authentication functionality. This option can increase the security level of provisioning. It is recommended to enable this option.

**Default value:**

- Yes (enabled) if *CONFIG\_BLE\_MESH\_PROV* && *CONFIG\_BLE\_MESH*

### CONFIG\_BLE\_MESH\_CERT\_BASED\_PROV

Support Certificate-based provisioning

*Found in:* *Component config* > *CONFIG\_BLE\_MESH* > *CONFIG\_BLE\_MESH\_PROV*

Enable this option to support BLE Mesh Certificate-Based Provisioning.

**Default value:**

- No (disabled) if *CONFIG\_BLE\_MESH\_PROV* && *CONFIG\_BLE\_MESH*

### CONFIG\_BLE\_MESH\_RECORD\_FRAG\_MAX\_SIZE

Maximum size of the provisioning record fragment that Provisioner can receive

*Found in:* `Component config > CONFIG_BLE_MESH > CONFIG_BLE_MESH_PROV > CONFIG_BLE_MESH_CERT_BASED_PROV`

This option sets the maximum size of the provisioning record fragment that the Provisioner can receive. The range depends on provisioning bearer.

**Range:**

- from 1 to 57 if `CONFIG_BLE_MESH_CERT_BASED_PROV` && `CONFIG_BLE_MESH`

**Default value:**

- 56 if `CONFIG_BLE_MESH_CERT_BASED_PROV` && `CONFIG_BLE_MESH`

### CONFIG\_BLE\_MESH\_PB\_ADV

Provisioning support using the advertising bearer (PB-ADV)

*Found in:* `Component config > CONFIG_BLE_MESH`

Enable this option to allow the device to be provisioned over the advertising bearer. This option should be enabled if PB-ADV is going to be used during provisioning procedure.

**Default value:**

- Yes (enabled) if `CONFIG_BLE_MESH`

### CONFIG\_BLE\_MESH\_UNPROVISIONED\_BEACON\_INTERVAL

Interval between two consecutive Unprovisioned Device Beacon

*Found in:* `Component config > CONFIG_BLE_MESH > CONFIG_BLE_MESH_PB_ADV`

This option specifies the interval of sending two consecutive unprovisioned device beacon, users can use this option to change the frequency of sending unprovisioned device beacon. For example, if the value is 5, it means the unprovisioned device beacon will send every 5 seconds. When the option of `BLE_MESH_FAST_PROV` is selected, the value is better to be 3 seconds, or less.

**Range:**

- from 1 to 100 if `CONFIG_BLE_MESH_NODE` && `CONFIG_BLE_MESH_PB_ADV` && `CONFIG_BLE_MESH`

**Default value:**

- 5 if `CONFIG_BLE_MESH_NODE` && `CONFIG_BLE_MESH_PB_ADV` && `CONFIG_BLE_MESH`
- 3 if `CONFIG_BLE_MESH_FAST_PROV` && `CONFIG_BLE_MESH_NODE` && `CONFIG_BLE_MESH_PB_ADV` && `CONFIG_BLE_MESH`

### CONFIG\_BLE\_MESH\_PB\_GATT

Provisioning support using GATT (PB-GATT)

*Found in:* `Component config > CONFIG_BLE_MESH`

Enable this option to allow the device to be provisioned over GATT. This option should be enabled if PB-GATT is going to be used during provisioning procedure.

# Virtual option enabled whenever any Proxy protocol is needed

### CONFIG\_BLE\_MESH\_PROXY

BLE Mesh Proxy protocol support

*Found in:* `Component config > CONFIG_BLE_MESH`



Enable this option to support BLE Mesh Proxy protocol used by PB-GATT and other proxy pdu transmission.

**Default value:**

- Yes (enabled) if `CONFIG_BLE_MESH`

### CONFIG\_BLE\_MESH\_GATT\_PROXY\_SERVER

BLE Mesh GATT Proxy Server

*Found in:* `Component config > CONFIG_BLE_MESH`

This option enables support for Mesh GATT Proxy Service, i.e. the ability to act as a proxy between a Mesh GATT Client and a Mesh network. This option should be enabled if a node is going to be a Proxy Server.

**Default value:**

- Yes (enabled) if `CONFIG_BLE_MESH_NODE` && `CONFIG_BLE_MESH`

### CONFIG\_BLE\_MESH\_NODE\_ID\_TIMEOUT

Node Identity advertising timeout

*Found in:* `Component config > CONFIG_BLE_MESH > CONFIG_BLE_MESH_GATT_PROXY_SERVER`

This option determines for how long the local node advertises using Node Identity. The given value is in seconds. The specification limits this to 60 seconds and lists it as the recommended value as well. So leaving the default value is the safest option. When an unprovisioned device is provisioned successfully and becomes a node, it will start to advertise using Node Identity during the time set by this option. And after that, Network ID will be advertised.

**Range:**

- from 1 to 60 if `CONFIG_BLE_MESH_GATT_PROXY_SERVER` && `CONFIG_BLE_MESH`

**Default value:**

- 60 if `CONFIG_BLE_MESH_GATT_PROXY_SERVER` && `CONFIG_BLE_MESH`

### CONFIG\_BLE\_MESH\_PROXY\_FILTER\_SIZE

Maximum number of filter entries per Proxy Client

*Found in:* `Component config > CONFIG_BLE_MESH > CONFIG_BLE_MESH_GATT_PROXY_SERVER`

This option specifies how many Proxy Filter entries the local node supports. The entries of Proxy filter (whitelist or blacklist) are used to store a list of addresses which can be used to decide which messages will be forwarded to the Proxy Client by the Proxy Server.

**Range:**

- from 1 to 32767 if `CONFIG_BLE_MESH_GATT_PROXY_SERVER` && `CONFIG_BLE_MESH`

**Default value:**

- 4 if `CONFIG_BLE_MESH_GATT_PROXY_SERVER` && `CONFIG_BLE_MESH`

### CONFIG\_BLE\_MESH\_PROXY\_PRIVACY

Support Proxy Privacy

*Found in:* `Component config > CONFIG_BLE_MESH > CONFIG_BLE_MESH_GATT_PROXY_SERVER`

The Proxy Privacy parameter controls the privacy of the Proxy Server over the connection. The value of the Proxy Privacy parameter is controlled by the type of proxy connection, which is dependent on the bearer used by the proxy connection.

**Default value:**



- Yes (enabled) if `CONFIG_BLE_MESH_PRB_SRV` && `CONFIG_BLE_MESH_GATT_PROXY_SERVER` && `CONFIG_BLE_MESH`

### CONFIG\_BLE\_MESH\_PROXY\_SOLIC\_PDU\_RX

Support receiving Proxy Solicitation PDU

*Found in:* `Component config` > `CONFIG_BLE_MESH` > `CONFIG_BLE_MESH_GATT_PROXY_SERVER`

Enable this option to support receiving Proxy Solicitation PDU.

### CONFIG\_BLE\_MESH\_PROXY\_SOLIC\_RX\_CRPL

Maximum capacity of solicitation replay protection list

*Found in:* `Component config` > `CONFIG_BLE_MESH` > `CONFIG_BLE_MESH_GATT_PROXY_SERVER` > `CONFIG_BLE_MESH_PROXY_SOLIC_PDU_RX`

This option specifies the maximum capacity of the solicitation replay protection list. The solicitation replay protection list is used to reject Solicitation PDUs that were already processed by a node, which will store the solicitation src and solicitation sequence number of the received Solicitation PDU message.

**Range:**

- from 1 to 255 if `CONFIG_BLE_MESH_PROXY_SOLIC_PDU_RX` && `CONFIG_BLE_MESH`

**Default value:**

- 2 if `CONFIG_BLE_MESH_PROXY_SOLIC_PDU_RX` && `CONFIG_BLE_MESH`

### CONFIG\_BLE\_MESH\_GATT\_PROXY\_CLIENT

BLE Mesh GATT Proxy Client

*Found in:* `Component config` > `CONFIG_BLE_MESH`

This option enables support for Mesh GATT Proxy Client. The Proxy Client can use the GATT bearer to send mesh messages to a node that supports the advertising bearer.

**Default value:**

- No (disabled) if `CONFIG_BLE_MESH`

### CONFIG\_BLE\_MESH\_PROXY\_SOLIC\_PDU\_TX

Support sending Proxy Solicitation PDU

*Found in:* `Component config` > `CONFIG_BLE_MESH` > `CONFIG_BLE_MESH_GATT_PROXY_CLIENT`

Enable this option to support sending Proxy Solicitation PDU.

### CONFIG\_BLE\_MESH\_PROXY\_SOLIC\_TX\_SRC\_COUNT

Maximum number of SSRC that can be used by Proxy Client

*Found in:* `Component config` > `CONFIG_BLE_MESH` > `CONFIG_BLE_MESH_GATT_PROXY_CLIENT` > `CONFIG_BLE_MESH_PROXY_SOLIC_PDU_TX`

This option specifies the maximum number of Solicitation Source (SSRC) that can be used by Proxy Client for sending a Solicitation PDU. A Proxy Client may use the primary address or any of the secondary addresses as the SSRC for a Solicitation PDU. So for a Proxy Client, it's better to choose the value based on its own element count.

**Range:**

- from 1 to 16 if `CONFIG_BLE_MESH_PROXY_SOLIC_PDU_TX` && `CONFIG_BLE_MESH`

**Default value:**

- 2 if `CONFIG_BLE_MESH_PROXY_SOLIC_PDU_TX` && `CONFIG_BLE_MESH`

## CONFIG\_BLE\_MESH\_SETTINGS

Store BLE Mesh configuration persistently

*Found in:* [Component config](#) > [CONFIG\\_BLE\\_MESH](#)

When selected, the BLE Mesh stack will take care of storing/restoring the BLE Mesh configuration persistently in flash. If the device is a BLE Mesh node, when this option is enabled, the configuration of the device will be stored persistently, including unicast address, NetKey, AppKey, etc. And if the device is a BLE Mesh Provisioner, the information of the device will be stored persistently, including the information of provisioned nodes, NetKey, AppKey, etc.

**Default value:**

- No (disabled) if [CONFIG\\_BLE\\_MESH](#)

## CONFIG\_BLE\_MESH\_STORE\_TIMEOUT

Delay (in seconds) before storing anything persistently

*Found in:* [Component config](#) > [CONFIG\\_BLE\\_MESH](#) > [CONFIG\\_BLE\\_MESH\\_SETTINGS](#)

This value defines in seconds how soon any pending changes are actually written into persistent storage (flash) after a change occurs. The option allows nodes to delay a certain period of time to save proper information to flash. The default value is 0, which means information will be stored immediately once there are updates.

**Range:**

- from 0 to 1000000 if [CONFIG\\_BLE\\_MESH\\_SETTINGS](#) && [CONFIG\\_BLE\\_MESH](#)

**Default value:**

- 0 if [CONFIG\\_BLE\\_MESH\\_SETTINGS](#) && [CONFIG\\_BLE\\_MESH](#)

## CONFIG\_BLE\_MESH\_SEQ\_STORE\_RATE

How often the sequence number gets updated in storage

*Found in:* [Component config](#) > [CONFIG\\_BLE\\_MESH](#) > [CONFIG\\_BLE\\_MESH\\_SETTINGS](#)

This value defines how often the local sequence number gets updated in persistent storage (i.e. flash). e.g. a value of 100 means that the sequence number will be stored to flash on every 100th increment. If the node sends messages very frequently a higher value makes more sense, whereas if the node sends infrequently a value as low as 0 (update storage for every increment) can make sense. When the stack gets initialized it will add sequence number to the last stored one, so that it starts off with a value that's guaranteed to be larger than the last one used before power off.

**Range:**

- from 0 to 1000000 if [CONFIG\\_BLE\\_MESH\\_SETTINGS](#) && [CONFIG\\_BLE\\_MESH](#)

**Default value:**

- 0 if [CONFIG\\_BLE\\_MESH\\_SETTINGS](#) && [CONFIG\\_BLE\\_MESH](#)

## CONFIG\_BLE\_MESH\_RPL\_STORE\_TIMEOUT

Minimum frequency that the RPL gets updated in storage

*Found in:* [Component config](#) > [CONFIG\\_BLE\\_MESH](#) > [CONFIG\\_BLE\\_MESH\\_SETTINGS](#)

This value defines in seconds how soon the RPL (Replay Protection List) gets written to persistent storage after a change occurs. If the node receives messages frequently, then a large value is recommended. If the node receives messages rarely, then the value can be as low as 0 (which means the RPL is written into the storage immediately). Note that if the node operates in a security-sensitive case, and there is a risk of sudden power-off, then a value of 0 is strongly recommended. Otherwise, a power loss before RPL being written into the storage may introduce message replay attacks and system security will be in a vulnerable state.

**Range:**

- from 0 to 1000000 if `CONFIG_BLE_MESH_SETTINGS` && `CONFIG_BLE_MESH`

**Default value:**

- 0 if `CONFIG_BLE_MESH_SETTINGS` && `CONFIG_BLE_MESH`

**CONFIG\_BLE\_MESH\_SETTINGS\_BACKWARD\_COMPATIBILITY**

A specific option for settings backward compatibility

*Found in:* `Component config > CONFIG_BLE_MESH > CONFIG_BLE_MESH_SETTINGS`

This option is created to solve the issue of failure in recovering node information after mesh stack updates. In the old version mesh stack, there is no key of "mesh/role" in nvs. In the new version mesh stack, key of "mesh/role" is added in nvs, recovering node information needs to check "mesh/role" key in nvs and implements selective recovery of mesh node information. Therefore, there may be failure in recovering node information during node restarting after OTA.

The new version mesh stack adds the option of "mesh/role" because we have added the support of storing Provisioner information, while the old version only supports storing node information.

If users are updating their nodes from old version to new version, we recommend enabling this option, so that system could set the flag in advance before recovering node information and make sure the node information recovering could work as expected.

**Default value:**

- No (disabled) if `CONFIG_BLE_MESH_NODE` && `CONFIG_BLE_MESH_SETTINGS` && `CONFIG_BLE_MESH`

**CONFIG\_BLE\_MESH\_SPECIFIC\_PARTITION**

Use a specific NVS partition for BLE Mesh

*Found in:* `Component config > CONFIG_BLE_MESH > CONFIG_BLE_MESH_SETTINGS`

When selected, the mesh stack will use a specified NVS partition instead of default NVS partition. Note that the specified partition must be registered with NVS using `nvs_flash_init_partition()` API, and the partition must exist in the csv file. When Provisioner needs to store a large amount of nodes' information in the flash (e.g. more than 20), this option is recommended to be enabled.

**Default value:**

- No (disabled) if `CONFIG_BLE_MESH_SETTINGS` && `CONFIG_BLE_MESH`

**CONFIG\_BLE\_MESH\_PARTITION\_NAME**

Name of the NVS partition for BLE Mesh

*Found in:* `Component config > CONFIG_BLE_MESH > CONFIG_BLE_MESH_SETTINGS > CONFIG_BLE_MESH_SPECIFIC_PARTITION`

This value defines the name of the specified NVS partition used by the mesh stack.

**Default value:**

- "ble\_mesh" if `CONFIG_BLE_MESH_SPECIFIC_PARTITION` && `CONFIG_BLE_MESH_SETTINGS` && `CONFIG_BLE_MESH`

**CONFIG\_BLE\_MESH\_USE\_MULTIPLE\_NAMESPACE**

Support using multiple NVS namespaces by Provisioner

*Found in:* `Component config > CONFIG_BLE_MESH > CONFIG_BLE_MESH_SETTINGS`

When selected, Provisioner can use different NVS namespaces to store different instances of mesh information. For example, if in the first room, Provisioner uses NetKey A, AppKey A and provisions three devices, these information will be treated as mesh information instance A. When the Provisioner

moves to the second room, it uses NetKey B, AppKey B and provisions two devices, then the information will be treated as mesh information instance B. Here instance A and instance B will be stored in different namespaces. With this option enabled, Provisioner needs to use specific functions to open the corresponding NVS namespace, restore the mesh information, release the mesh information or erase the mesh information.

**Default value:**

- No (disabled) if `CONFIG_BLE_MESH_PROVISIONER` && `CONFIG_BLE_MESH_SETTINGS` && `CONFIG_BLE_MESH`

**CONFIG\_BLE\_MESH\_MAX\_NVS\_NAMESPACE**

Maximum number of NVS namespaces

*Found in:* `Component config > CONFIG_BLE_MESH > CONFIG_BLE_MESH_SETTINGS > CONFIG_BLE_MESH_USE_MULTIPLE_NAMESPACE`

This option specifies the maximum NVS namespaces supported by Provisioner.

**Range:**

- from 1 to 255 if `CONFIG_BLE_MESH_USE_MULTIPLE_NAMESPACE` && `CONFIG_BLE_MESH_SETTINGS` && `CONFIG_BLE_MESH`

**Default value:**

- 2 if `CONFIG_BLE_MESH_USE_MULTIPLE_NAMESPACE` && `CONFIG_BLE_MESH_SETTINGS` && `CONFIG_BLE_MESH`

**CONFIG\_BLE\_MESH\_SUBNET\_COUNT**

Maximum number of mesh subnets per network

*Found in:* `Component config > CONFIG_BLE_MESH`

This option specifies how many subnets a Mesh network can have at the same time. Indeed, this value decides the number of the network keys which can be owned by a node.

**Range:**

- from 1 to 4096 if `CONFIG_BLE_MESH`

**Default value:**

- 3 if `CONFIG_BLE_MESH`

**CONFIG\_BLE\_MESH\_APP\_KEY\_COUNT**

Maximum number of application keys per network

*Found in:* `Component config > CONFIG_BLE_MESH`

This option specifies how many application keys the device can store per network. Indeed, this value decides the number of the application keys which can be owned by a node.

**Range:**

- from 1 to 4096 if `CONFIG_BLE_MESH`

**Default value:**

- 3 if `CONFIG_BLE_MESH`

**CONFIG\_BLE\_MESH\_MODEL\_KEY\_COUNT**

Maximum number of application keys per model

*Found in:* `Component config > CONFIG_BLE_MESH`

This option specifies the maximum number of application keys to which each model can be bound.

**Range:**

- from 1 to 4096 if `CONFIG_BLE_MESH`

**Default value:**

- 3 if `CONFIG_BLE_MESH`

**CONFIG\_BLE\_MESH\_MODEL\_GROUP\_COUNT**

Maximum number of group address subscriptions per model

*Found in: `Component config` > `CONFIG_BLE_MESH`*

This option specifies the maximum number of addresses to which each model can be subscribed.

**Range:**

- from 1 to 4096 if `CONFIG_BLE_MESH`

**Default value:**

- 3 if `CONFIG_BLE_MESH`

**CONFIG\_BLE\_MESH\_LABEL\_COUNT**

Maximum number of Label UUIDs used for Virtual Addresses

*Found in: `Component config` > `CONFIG_BLE_MESH`*

This option specifies how many Label UUIDs can be stored. Indeed, this value decides the number of the Virtual Addresses can be supported by a node.

**Range:**

- from 0 to 4096 if `CONFIG_BLE_MESH`

**Default value:**

- 3 if `CONFIG_BLE_MESH`

**CONFIG\_BLE\_MESH\_CRPL**

Maximum capacity of the replay protection list

*Found in: `Component config` > `CONFIG_BLE_MESH`*

This option specifies the maximum capacity of the replay protection list. It is similar to Network message cache size, but has a different purpose. The replay protection list is used to prevent a node from replay attack, which will store the source address and sequence number of the received mesh messages. For Provisioner, the replay protection list size should not be smaller than the maximum number of nodes whose information can be stored. And the element number of each node should also be taken into consideration. For example, if Provisioner can provision up to 20 nodes and each node contains two elements, then the replay protection list size of Provisioner should be at least 40.

**Range:**

- from 2 to 65535 if `CONFIG_BLE_MESH`

**Default value:**

- 10 if `CONFIG_BLE_MESH`

**CONFIG\_BLE\_MESH\_NOT\_RELAY\_REPLAY\_MSG**

Not relay replayed messages in a mesh network

*Found in: `Component config` > `CONFIG_BLE_MESH`*

There may be many expired messages in a complex mesh network that would be considered replayed messages. Enable this option will refuse to relay such messages, which could help to reduce invalid packets in the mesh network. However, it should be noted that enabling this option may result in packet loss in certain environments. Therefore, users need to decide whether to enable this option according to the actual usage situation.

**Default value:**

- No (disabled) if `CONFIG_BLE_MESH_EXPERIMENTAL` && `CONFIG_BLE_MESH`

### CONFIG\_BLE\_MESH\_MSG\_CACHE\_SIZE

Network message cache size

*Found in: [Component config](#) > [CONFIG\\_BLE\\_MESH](#)*

Number of messages that are cached for the network. This helps prevent unnecessary decryption operations and unnecessary relays. This option is similar to Replay protection list, but has a different purpose. A node is not required to cache the entire Network PDU and may cache only part of it for tracking, such as values for SRC/SEQ or others.

**Range:**

- from 2 to 65535 if [CONFIG\\_BLE\\_MESH](#)

**Default value:**

- 10 if [CONFIG\\_BLE\\_MESH](#)

### CONFIG\_BLE\_MESH\_ADV\_BUF\_COUNT

Number of advertising buffers

*Found in: [Component config](#) > [CONFIG\\_BLE\\_MESH](#)*

Number of advertising buffers available. The transport layer reserves ADV\_BUF\_COUNT - 3 buffers for outgoing segments. The maximum outgoing SDU size is 12 times this value (out of which 4 or 8 bytes are used for the Transport Layer MIC). For example, 5 segments means the maximum SDU size is 60 bytes, which leaves 56 bytes for application layer data using a 4-byte MIC, or 52 bytes using an 8-byte MIC.

**Range:**

- from 6 to 256 if [CONFIG\\_BLE\\_MESH](#)

**Default value:**

- 60 if [CONFIG\\_BLE\\_MESH](#)

### CONFIG\_BLE\_MESH\_IVU\_DIVIDER

Divider for IV Update state refresh timer

*Found in: [Component config](#) > [CONFIG\\_BLE\\_MESH](#)*

When the IV Update state enters Normal operation or IV Update in Progress, we need to keep track of how many hours has passed in the state, since the specification requires us to remain in the state at least for 96 hours (Update in Progress has an additional upper limit of 144 hours).

In order to fulfill the above requirement, even if the node might be powered off once in a while, we need to store persistently how many hours the node has been in the state. This doesn't necessarily need to happen every hour (thanks to the flexible duration range). The exact cadence will depend a lot on the ways that the node will be used and what kind of power source it has.

Since there is no single optimal answer, this configuration option allows specifying a divider, i.e. how many intervals the 96 hour minimum gets split into. After each interval the duration that the node has been in the current state gets stored to flash. E.g. the default value of 4 means that the state is saved every 24 hours (96 / 4).

**Range:**

- from 2 to 96 if [CONFIG\\_BLE\\_MESH](#)

**Default value:**

- 4 if [CONFIG\\_BLE\\_MESH](#)

### CONFIG\_BLE\_MESH\_IVU\_RECOVERY\_IVI

Recovery the IV index when the latest whole IV update procedure is missed

*Found in: [Component config](#) > [CONFIG\\_BLE\\_MESH](#)*

According to Section 3.10.5 of Mesh Specification v1.0.1. If a node in Normal Operation receives a Secure Network beacon with an IV index equal to the last known IV index+1 and the IV Update Flag set to 0, the node may update its IV without going to the IV Update in Progress state, or it may initiate an IV Index Recovery procedure (Section 3.10.6), or it may ignore the Secure Network beacon. The node makes the choice depending on the time since last IV update and the likelihood that the node has missed the Secure Network beacons with the IV update Flag. When the above situation is encountered, this option can be used to decide whether to perform the IV index recovery procedure.

**Default value:**

- No (disabled) if `CONFIG_BLE_MESH`

**CONFIG\_BLE\_MESH\_SAR\_ENHANCEMENT**

Segmentation and reassembly enhancement

*Found in:* `Component config > CONFIG_BLE_MESH`

Enable this option to use the enhanced segmentation and reassembly mechanism introduced in Bluetooth Mesh Protocol 1.1.

**Default value:**

- No (disabled) if `CONFIG_BLE_MESH`

**CONFIG\_BLE\_MESH\_TX\_SEG\_MSG\_COUNT**

Maximum number of simultaneous outgoing segmented messages

*Found in:* `Component config > CONFIG_BLE_MESH`

Maximum number of simultaneous outgoing multi-segment and/or reliable messages. The default value is 1, which means the device can only send one segmented message at a time. And if another segmented message is going to be sent, it should wait for the completion of the previous one. If users are going to send multiple segmented messages at the same time, this value should be configured properly.

**Range:**

- from 1 to if `CONFIG_BLE_MESH`

**Default value:**

- 1 if `CONFIG_BLE_MESH`

**CONFIG\_BLE\_MESH\_RX\_SEG\_MSG\_COUNT**

Maximum number of simultaneous incoming segmented messages

*Found in:* `Component config > CONFIG_BLE_MESH`

Maximum number of simultaneous incoming multi-segment and/or reliable messages. The default value is 1, which means the device can only receive one segmented message at a time. And if another segmented message is going to be received, it should wait for the completion of the previous one. If users are going to receive multiple segmented messages at the same time, this value should be configured properly.

**Range:**

- from 1 to 255 if `CONFIG_BLE_MESH`

**Default value:**

- 1 if `CONFIG_BLE_MESH`

**CONFIG\_BLE\_MESH\_RX\_SDU\_MAX**

Maximum incoming Upper Transport Access PDU length

*Found in:* `Component config > CONFIG_BLE_MESH`



Maximum incoming Upper Transport Access PDU length. Leave this to the default value, unless you really need to optimize memory usage.

**Range:**

- from 36 to 384 if *CONFIG\_BLE\_MESH*

**Default value:**

- 384 if *CONFIG\_BLE\_MESH*

### CONFIG\_BLE\_MESH\_TX\_SEG\_MAX

Maximum number of segments in outgoing messages

*Found in: Component config > CONFIG\_BLE\_MESH*

Maximum number of segments supported for outgoing messages. This value should typically be fine-tuned based on what models the local node supports, i.e. what's the largest message payload that the node needs to be able to send. This value affects memory and call stack consumption, which is why the default is lower than the maximum that the specification would allow (32 segments).

The maximum outgoing SDU size is 12 times this number (out of which 4 or 8 bytes is used for the Transport Layer MIC). For example, 5 segments means the maximum SDU size is 60 bytes, which leaves 56 bytes for application layer data using a 4-byte MIC and 52 bytes using an 8-byte MIC.

Be sure to specify a sufficient number of advertising buffers when setting this option to a higher value. There must be at least three more advertising buffers (*BLE\_MESH\_ADV\_BUF\_COUNT*) as there are outgoing segments.

**Range:**

- from 2 to 32 if *CONFIG\_BLE\_MESH*

**Default value:**

- 32 if *CONFIG\_BLE\_MESH*

### CONFIG\_BLE\_MESH\_RELAY

Relay support

*Found in: Component config > CONFIG\_BLE\_MESH*

Support for acting as a Mesh Relay Node. Enabling this option will allow a node to support the Relay feature, and the Relay feature can still be enabled or disabled by proper configuration messages. Disabling this option will let a node not support the Relay feature.

**Default value:**

- Yes (enabled) if *CONFIG\_BLE\_MESH\_NODE* && *CONFIG\_BLE\_MESH*

### CONFIG\_BLE\_MESH\_RELAY\_ADV\_BUF

Use separate advertising buffers for relay packets

*Found in: Component config > CONFIG\_BLE\_MESH > CONFIG\_BLE\_MESH\_RELAY*

When selected, self-send packets will be put in a high-priority queue and relay packets will be put in a low-priority queue.

**Default value:**

- No (disabled) if *CONFIG\_BLE\_MESH\_RELAY* && *CONFIG\_BLE\_MESH*

### CONFIG\_BLE\_MESH\_RELAY\_ADV\_BUF\_COUNT

Number of advertising buffers for relay packets

*Found in: Component config > CONFIG\_BLE\_MESH > CONFIG\_BLE\_MESH\_RELAY > CONFIG\_BLE\_MESH\_RELAY\_ADV\_BUF*



Number of advertising buffers for relay packets available.

**Range:**

- from 6 to 256 if `CONFIG_BLE_MESH_RELAY_ADV_BUF` && `CONFIG_BLE_MESH_RELAY` && `CONFIG_BLE_MESH`

**Default value:**

- 60 if `CONFIG_BLE_MESH_RELAY_ADV_BUF` && `CONFIG_BLE_MESH_RELAY` && `CONFIG_BLE_MESH`

## CONFIG\_BLE\_MESH\_LOW\_POWER

Support for Low Power features

*Found in:* `Component config` > `CONFIG_BLE_MESH`

Enable this option to operate as a Low Power Node. If low power consumption is required by a node, this option should be enabled. And once the node enters the mesh network, it will try to find a Friend node and establish a friendship.

## CONFIG\_BLE\_MESH\_LPN\_ESTABLISHMENT

Perform Friendship establishment using low power

*Found in:* `Component config` > `CONFIG_BLE_MESH` > `CONFIG_BLE_MESH_LOW_POWER`

Perform the Friendship establishment using low power with the help of a reduced scan duty cycle. The downside of this is that the node may miss out on messages intended for it until it has successfully set up Friendship with a Friend node. When this option is enabled, the node will stop scanning for a period of time after a Friend Request or Friend Poll is sent, so as to reduce more power consumption.

**Default value:**

- No (disabled) if `CONFIG_BLE_MESH_LOW_POWER` && `CONFIG_BLE_MESH`

## CONFIG\_BLE\_MESH\_LPN\_AUTO

Automatically start looking for Friend nodes once provisioned

*Found in:* `Component config` > `CONFIG_BLE_MESH` > `CONFIG_BLE_MESH_LOW_POWER`

Once provisioned, automatically enable LPN functionality and start looking for Friend nodes. If this option is disabled LPN mode needs to be manually enabled by calling `bt_mesh_lpn_set(true)`. When an unprovisioned device is provisioned successfully and becomes a node, enabling this option will trigger the node starts to send Friend Request at a certain period until it finds a proper Friend node.

**Default value:**

- No (disabled) if `CONFIG_BLE_MESH_LOW_POWER` && `CONFIG_BLE_MESH`

## CONFIG\_BLE\_MESH\_LPN\_AUTO\_TIMEOUT

Time from last received message before going to LPN mode

*Found in:* `Component config` > `CONFIG_BLE_MESH` > `CONFIG_BLE_MESH_LOW_POWER` > `CONFIG_BLE_MESH_LPN_AUTO`

Time in seconds from the last received message, that the node waits out before starting to look for Friend nodes.

**Range:**

- from 0 to 3600 if `CONFIG_BLE_MESH_LPN_AUTO` && `CONFIG_BLE_MESH_LOW_POWER` && `CONFIG_BLE_MESH`

**Default value:**

- 15 if `CONFIG_BLE_MESH_LPN_AUTO` && `CONFIG_BLE_MESH_LOW_POWER` && `CONFIG_BLE_MESH`

### CONFIG\_BLE\_MESH\_LPN\_RETRY\_TIMEOUT

Retry timeout for Friend requests

*Found in: Component config > CONFIG\_BLE\_MESH > CONFIG\_BLE\_MESH\_LOW\_POWER*

Time in seconds between Friend Requests, if a previous Friend Request did not yield any acceptable Friend Offers.

**Range:**

- from 1 to 3600 if *CONFIG\_BLE\_MESH\_LOW\_POWER* && *CONFIG\_BLE\_MESH*

**Default value:**

- 6 if *CONFIG\_BLE\_MESH\_LOW\_POWER* && *CONFIG\_BLE\_MESH*

### CONFIG\_BLE\_MESH\_LPN\_RSSI\_FACTOR

RSSIFactor, used in Friend Offer Delay calculation

*Found in: Component config > CONFIG\_BLE\_MESH > CONFIG\_BLE\_MESH\_LOW\_POWER*

The contribution of the RSSI, measured by the Friend node, used in Friend Offer Delay calculations. 0 = 1, 1 = 1.5, 2 = 2, 3 = 2.5. RSSIFactor, one of the parameters carried by Friend Request sent by Low Power node, which is used to calculate the Friend Offer Delay.

**Range:**

- from 0 to 3 if *CONFIG\_BLE\_MESH\_LOW\_POWER* && *CONFIG\_BLE\_MESH*

**Default value:**

- 0 if *CONFIG\_BLE\_MESH\_LOW\_POWER* && *CONFIG\_BLE\_MESH*

### CONFIG\_BLE\_MESH\_LPN\_RECV\_WIN\_FACTOR

ReceiveWindowFactor, used in Friend Offer Delay calculation

*Found in: Component config > CONFIG\_BLE\_MESH > CONFIG\_BLE\_MESH\_LOW\_POWER*

The contribution of the supported Receive Window used in Friend Offer Delay calculations. 0 = 1, 1 = 1.5, 2 = 2, 3 = 2.5. ReceiveWindowFactor, one of the parameters carried by Friend Request sent by Low Power node, which is used to calculate the Friend Offer Delay.

**Range:**

- from 0 to 3 if *CONFIG\_BLE\_MESH\_LOW\_POWER* && *CONFIG\_BLE\_MESH*

**Default value:**

- 0 if *CONFIG\_BLE\_MESH\_LOW\_POWER* && *CONFIG\_BLE\_MESH*

### CONFIG\_BLE\_MESH\_LPN\_MIN\_QUEUE\_SIZE

Minimum size of the acceptable friend queue (MinQueueSizeLog)

*Found in: Component config > CONFIG\_BLE\_MESH > CONFIG\_BLE\_MESH\_LOW\_POWER*

The MinQueueSizeLog field is defined as  $\log_2(N)$ , where N is the minimum number of maximum size Lower Transport PDUs that the Friend node can store in its Friend Queue. As an example, MinQueueSizeLog value 1 gives N = 2, and value 7 gives N = 128.

**Range:**

- from 1 to 7 if *CONFIG\_BLE\_MESH\_LOW\_POWER* && *CONFIG\_BLE\_MESH*

**Default value:**

- 1 if *CONFIG\_BLE\_MESH\_LOW\_POWER* && *CONFIG\_BLE\_MESH*

### CONFIG\_BLE\_MESH\_LPN\_RECV\_DELAY

Receive delay requested by the local node

*Found in: Component config > CONFIG\_BLE\_MESH > CONFIG\_BLE\_MESH\_LOW\_POWER*

The ReceiveDelay is the time between the Low Power node sending a request and listening for a response. This delay allows the Friend node time to prepare the response. The value is in units of milliseconds.

**Range:**

- from 10 to 255 if *CONFIG\_BLE\_MESH\_LOW\_POWER* && *CONFIG\_BLE\_MESH*

**Default value:**

- 100 if *CONFIG\_BLE\_MESH\_LOW\_POWER* && *CONFIG\_BLE\_MESH*

### CONFIG\_BLE\_MESH\_LPN\_POLL\_TIMEOUT

The value of the PollTimeout timer

*Found in: Component config > CONFIG\_BLE\_MESH > CONFIG\_BLE\_MESH\_LOW\_POWER*

PollTimeout timer is used to measure time between two consecutive requests sent by a Low Power node. If no requests are received the Friend node before the PollTimeout timer expires, then the friendship is considered terminated. The value is in units of 100 milliseconds, so e.g. a value of 300 means 30 seconds. The smaller the value, the faster the Low Power node tries to get messages from corresponding Friend node and vice versa.

**Range:**

- from 10 to 244735 if *CONFIG\_BLE\_MESH\_LOW\_POWER* && *CONFIG\_BLE\_MESH*

**Default value:**

- 300 if *CONFIG\_BLE\_MESH\_LOW\_POWER* && *CONFIG\_BLE\_MESH*

### CONFIG\_BLE\_MESH\_LPN\_INIT\_POLL\_TIMEOUT

The starting value of the PollTimeout timer

*Found in: Component config > CONFIG\_BLE\_MESH > CONFIG\_BLE\_MESH\_LOW\_POWER*

The initial value of the PollTimeout timer when Friendship is to be established for the first time. After this, the timeout gradually grows toward the actual PollTimeout, doubling in value for each iteration. The value is in units of 100 milliseconds, so e.g. a value of 300 means 30 seconds.

**Range:**

- from 10 to if *CONFIG\_BLE\_MESH\_LOW\_POWER* && *CONFIG\_BLE\_MESH*

**Default value:**

- if *CONFIG\_BLE\_MESH\_LOW\_POWER* && *CONFIG\_BLE\_MESH*

### CONFIG\_BLE\_MESH\_LPN\_SCAN\_LATENCY

Latency for enabling scanning

*Found in: Component config > CONFIG\_BLE\_MESH > CONFIG\_BLE\_MESH\_LOW\_POWER*

Latency (in milliseconds) is the time it takes to enable scanning. In practice, it means how much time in advance of the Receive Window, the request to enable scanning is made.

**Range:**

- from 0 to 50 if *CONFIG\_BLE\_MESH\_LOW\_POWER* && *CONFIG\_BLE\_MESH*

**Default value:**

- 10 if *CONFIG\_BLE\_MESH\_LOW\_POWER* && *CONFIG\_BLE\_MESH*

### CONFIG\_BLE\_MESH\_LPN\_GROUPS

Number of groups the LPN can subscribe to

*Found in: Component config > CONFIG\_BLE\_MESH > CONFIG\_BLE\_MESH\_LOW\_POWER*

Maximum number of groups to which the LPN can subscribe.

**Range:**

- from 0 to 16384 if `CONFIG_BLE_MESH_LOW_POWER` && `CONFIG_BLE_MESH`

**Default value:**

- 8 if `CONFIG_BLE_MESH_LOW_POWER` && `CONFIG_BLE_MESH`

### **CONFIG\_BLE\_MESH\_LPN\_SUB\_ALL\_NODES\_ADDR**

Automatically subscribe all nodes address

*Found in: Component config > CONFIG\_BLE\_MESH > CONFIG\_BLE\_MESH\_LOW\_POWER*

Automatically subscribe all nodes address when friendship established.

**Default value:**

- No (disabled) if `CONFIG_BLE_MESH_LOW_POWER` && `CONFIG_BLE_MESH`

### **CONFIG\_BLE\_MESH\_FRIEND**

Support for Friend feature

*Found in: Component config > CONFIG\_BLE\_MESH*

Enable this option to be able to act as a Friend Node.

### **CONFIG\_BLE\_MESH\_FRIEND\_RECV\_WIN**

Friend Receive Window

*Found in: Component config > CONFIG\_BLE\_MESH > CONFIG\_BLE\_MESH\_FRIEND*

Receive Window in milliseconds supported by the Friend node.

**Range:**

- from 1 to 255 if `CONFIG_BLE_MESH_FRIEND` && `CONFIG_BLE_MESH`

**Default value:**

- 255 if `CONFIG_BLE_MESH_FRIEND` && `CONFIG_BLE_MESH`

### **CONFIG\_BLE\_MESH\_FRIEND\_QUEUE\_SIZE**

Minimum number of buffers supported per Friend Queue

*Found in: Component config > CONFIG\_BLE\_MESH > CONFIG\_BLE\_MESH\_FRIEND*

Minimum number of buffers available to be stored for each local Friend Queue. This option decides the size of each buffer which can be used by a Friend node to store messages for each Low Power node.

**Range:**

- from 2 to 65536 if `CONFIG_BLE_MESH_FRIEND` && `CONFIG_BLE_MESH`

**Default value:**

- 16 if `CONFIG_BLE_MESH_FRIEND` && `CONFIG_BLE_MESH`

### **CONFIG\_BLE\_MESH\_FRIEND\_SUB\_LIST\_SIZE**

Friend Subscription List Size

*Found in: Component config > CONFIG\_BLE\_MESH > CONFIG\_BLE\_MESH\_FRIEND*

Size of the Subscription List that can be supported by a Friend node for a Low Power node. And Low Power node can send Friend Subscription List Add or Friend Subscription List Remove messages to the Friend node to add or remove subscription addresses.

**Range:**

- from 0 to 1023 if `CONFIG_BLE_MESH_FRIEND` && `CONFIG_BLE_MESH`

**Default value:**

- 3 if `CONFIG_BLE_MESH_FRIEND` && `CONFIG_BLE_MESH`

**CONFIG\_BLE\_MESH\_FRIEND\_LPN\_COUNT**

Number of supported LPN nodes

*Found in: Component config > CONFIG\_BLE\_MESH > CONFIG\_BLE\_MESH\_FRIEND*

Number of Low Power Nodes with which a Friend can have Friendship simultaneously. A Friend node can have friendship with multiple Low Power nodes at the same time, while a Low Power node can only establish friendship with only one Friend node at the same time.

**Range:**

- from 1 to 1000 if `CONFIG_BLE_MESH_FRIEND` && `CONFIG_BLE_MESH`

**Default value:**

- 2 if `CONFIG_BLE_MESH_FRIEND` && `CONFIG_BLE_MESH`

**CONFIG\_BLE\_MESH\_FRIEND\_SEG\_RX**

Number of incomplete segment lists per LPN

*Found in: Component config > CONFIG\_BLE\_MESH > CONFIG\_BLE\_MESH\_FRIEND*

Number of incomplete segment lists tracked for each Friends' LPN. In other words, this determines from how many elements can segmented messages destined for the Friend queue be received simultaneously.

**Range:**

- from 1 to 1000 if `CONFIG_BLE_MESH_FRIEND` && `CONFIG_BLE_MESH`

**Default value:**

- 1 if `CONFIG_BLE_MESH_FRIEND` && `CONFIG_BLE_MESH`

**CONFIG\_BLE\_MESH\_NO\_LOG**

Disable BLE Mesh debug logs (minimize bin size)

*Found in: Component config > CONFIG\_BLE\_MESH*

Select this to save the BLE Mesh related rodata code size. Enabling this option will disable the output of BLE Mesh debug log.

**Default value:**

- No (disabled) if `CONFIG_BLE_MESH` && `CONFIG_BLE_MESH`

**BLE Mesh STACK DEBUG LOG LEVEL** Contains:

- `CONFIG_BLE_MESH_STACK_TRACE_LEVEL`

**CONFIG\_BLE\_MESH\_STACK\_TRACE\_LEVEL**

BLE\_MESH\_STACK

*Found in: Component config > CONFIG\_BLE\_MESH > BLE Mesh STACK DEBUG LOG LEVEL*

Define BLE Mesh trace level for BLE Mesh stack.

Available options:

- NONE (`CONFIG_BLE_MESH_TRACE_LEVEL_NONE`)
- ERROR (`CONFIG_BLE_MESH_TRACE_LEVEL_ERROR`)
- WARNING (`CONFIG_BLE_MESH_TRACE_LEVEL_WARNING`)
- INFO (`CONFIG_BLE_MESH_TRACE_LEVEL_INFO`)

- DEBUG (CONFIG\_BLE\_MESH\_TRACE\_LEVEL\_DEBUG)
- VERBOSE (CONFIG\_BLE\_MESH\_TRACE\_LEVEL\_VERBOSE)

**BLE Mesh NET BUF DEBUG LOG LEVEL** Contains:

- [CONFIG\\_BLE\\_MESH\\_NET\\_BUF\\_TRACE\\_LEVEL](#)

### **CONFIG\_BLE\_MESH\_NET\_BUF\_TRACE\_LEVEL**

BLE\_MESH\_NET\_BUF

*Found in: Component config > CONFIG\_BLE\_MESH > BLE Mesh NET BUF DEBUG LOG LEVEL*

Define BLE Mesh trace level for BLE Mesh net buffer.

Available options:

- NONE (CONFIG\_BLE\_MESH\_NET\_BUF\_TRACE\_LEVEL\_NONE)
- ERROR (CONFIG\_BLE\_MESH\_NET\_BUF\_TRACE\_LEVEL\_ERROR)
- WARNING (CONFIG\_BLE\_MESH\_NET\_BUF\_TRACE\_LEVEL\_WARNING)
- INFO (CONFIG\_BLE\_MESH\_NET\_BUF\_TRACE\_LEVEL\_INFO)
- DEBUG (CONFIG\_BLE\_MESH\_NET\_BUF\_TRACE\_LEVEL\_DEBUG)
- VERBOSE (CONFIG\_BLE\_MESH\_NET\_BUF\_TRACE\_LEVEL\_VERBOSE)

### **CONFIG\_BLE\_MESH\_CLIENT\_MSG\_TIMEOUT**

Timeout(ms) for client message response

*Found in: Component config > CONFIG\_BLE\_MESH*

Timeout value used by the node to get response of the acknowledged message which is sent by the client model. This value indicates the maximum time that a client model waits for the response of the sent acknowledged messages. If a client model uses 0 as the timeout value when sending acknowledged messages, then the default value will be used which is four seconds.

**Range:**

- from 100 to 1200000 if [CONFIG\\_BLE\\_MESH](#)

**Default value:**

- 4000 if [CONFIG\\_BLE\\_MESH](#)

**Support for BLE Mesh Foundation models** Contains:

- [CONFIG\\_BLE\\_MESH\\_BRC\\_CLI](#)
- [CONFIG\\_BLE\\_MESH\\_BRC\\_SRV](#)
- [CONFIG\\_BLE\\_MESH\\_CFG\\_CLI](#)
- [CONFIG\\_BLE\\_MESH\\_DF\\_CLI](#)
- [CONFIG\\_BLE\\_MESH\\_DF\\_SRV](#)
- [CONFIG\\_BLE\\_MESH\\_HEALTH\\_CLI](#)
- [CONFIG\\_BLE\\_MESH\\_HEALTH\\_SRV](#)
- [CONFIG\\_BLE\\_MESH\\_LCD\\_CLI](#)
- [CONFIG\\_BLE\\_MESH\\_LCD\\_SRV](#)
- [CONFIG\\_BLE\\_MESH\\_PRB\\_CLI](#)
- [CONFIG\\_BLE\\_MESH\\_PRB\\_SRV](#)
- [CONFIG\\_BLE\\_MESH\\_ODP\\_CLI](#)
- [CONFIG\\_BLE\\_MESH\\_ODP\\_SRV](#)
- [CONFIG\\_BLE\\_MESH\\_AGG\\_CLI](#)
- [CONFIG\\_BLE\\_MESH\\_AGG\\_SRV](#)
- [CONFIG\\_BLE\\_MESH\\_RPR\\_CLI](#)
- [CONFIG\\_BLE\\_MESH\\_RPR\\_SRV](#)

- [CONFIG\\_BLE\\_MESH\\_SAR\\_CLI](#)
- [CONFIG\\_BLE\\_MESH\\_SAR\\_SRV](#)
- [CONFIG\\_BLE\\_MESH\\_SRPL\\_CLI](#)
- [CONFIG\\_BLE\\_MESH\\_SRPL\\_SRV](#)
- [CONFIG\\_BLE\\_MESH\\_COMP\\_DATA\\_1](#)
- [CONFIG\\_BLE\\_MESH\\_COMP\\_DATA\\_128](#)
- [CONFIG\\_BLE\\_MESH\\_MODELS\\_METADATA\\_0](#)

### **CONFIG\_BLE\_MESH\_CFG\_CLI**

Configuration Client model

*Found in: Component config > CONFIG\_BLE\_MESH > Support for BLE Mesh Foundation models*

Enable support for Configuration Client model.

### **CONFIG\_BLE\_MESH\_HEALTH\_CLI**

Health Client model

*Found in: Component config > CONFIG\_BLE\_MESH > Support for BLE Mesh Foundation models*

Enable support for Health Client model.

### **CONFIG\_BLE\_MESH\_HEALTH\_SRV**

Health Server model

*Found in: Component config > CONFIG\_BLE\_MESH > Support for BLE Mesh Foundation models*

Enable support for Health Server model.

**Default value:**

- Yes (enabled) if [CONFIG\\_BLE\\_MESH](#)

### **CONFIG\_BLE\_MESH\_BRC\_CLI**

Bridge Configuration Client model

*Found in: Component config > CONFIG\_BLE\_MESH > Support for BLE Mesh Foundation models*

Enable support for Bridge Configuration Client model.

### **CONFIG\_BLE\_MESH\_BRC\_SRV**

Bridge Configuration Server model

*Found in: Component config > CONFIG\_BLE\_MESH > Support for BLE Mesh Foundation models*

Enable support for Bridge Configuration Server model.

**Default value:**

- No (disabled) if [CONFIG\\_BLE\\_MESH](#)

### **CONFIG\_BLE\_MESH\_MAX\_BRIDGING\_TABLE\_ENTRY\_COUNT**

Maximum number of Bridging Table entries

*Found in: Component config > CONFIG\_BLE\_MESH > Support for BLE Mesh Foundation models > CONFIG\_BLE\_MESH\_BRC\_SRV*

Maximum number of Bridging Table entries that the Bridge Configuration Server can support.

**Range:**



- from 16 to 65535 if `CONFIG_BLE_MESH_BRC_SRV` && `CONFIG_BLE_MESH`

**Default value:**

- 16 if `CONFIG_BLE_MESH_BRC_SRV` && `CONFIG_BLE_MESH`

**CONFIG\_BLE\_MESH\_BRIDGE\_CRPL**

Maximum capacity of bridge replay protection list

*Found in: Component config > CONFIG\_BLE\_MESH > Support for BLE Mesh Foundation models > CONFIG\_BLE\_MESH\_BRC\_SRV*

This option specifies the maximum capacity of the bridge replay protection list. The bridge replay protection list is used to prevent a bridged subnet from replay attack, which will store the source address and sequence number of the received bridge messages.

**Range:**

- from 1 to 255 if `CONFIG_BLE_MESH_BRC_SRV` && `CONFIG_BLE_MESH`

**Default value:**

- 5 if `CONFIG_BLE_MESH_BRC_SRV` && `CONFIG_BLE_MESH`

**CONFIG\_BLE\_MESH\_PRB\_CLI**

Mesh Private Beacon Client model

*Found in: Component config > CONFIG\_BLE\_MESH > Support for BLE Mesh Foundation models*

Enable support for Mesh Private Beacon Client model.

**CONFIG\_BLE\_MESH\_PRB\_SRV**

Mesh Private Beacon Server model

*Found in: Component config > CONFIG\_BLE\_MESH > Support for BLE Mesh Foundation models*

Enable support for Mesh Private Beacon Server model.

**CONFIG\_BLE\_MESH\_ODP\_CLI**

On-Demand Private Proxy Client model

*Found in: Component config > CONFIG\_BLE\_MESH > Support for BLE Mesh Foundation models*

Enable support for On-Demand Private Proxy Client model.

**CONFIG\_BLE\_MESH\_ODP\_SRV**

On-Demand Private Proxy Server model

*Found in: Component config > CONFIG\_BLE\_MESH > Support for BLE Mesh Foundation models*

Enable support for On-Demand Private Proxy Server model.

**CONFIG\_BLE\_MESH\_SRPL\_CLI**

Solicitation PDU RPL Configuration Client model

*Found in: Component config > CONFIG\_BLE\_MESH > Support for BLE Mesh Foundation models*

Enable support for Solicitation PDU RPL Configuration Client model.



### **CONFIG\_BLE\_MESH\_SRPL\_SRV**

Solicitation PDU RPL Configuration Server model

*Found in: Component config > CONFIG\_BLE\_MESH > Support for BLE Mesh Foundation models*

Enable support for Solicitation PDU RPL Configuration Server model. Note: This option depends on the functionality of receiving Solicitation PDU. If the device doesn't support receiving Solicitation PDU, then there is no need to enable this server model.

### **CONFIG\_BLE\_MESH\_AGG\_CLI**

Opcodes Aggregator Client model

*Found in: Component config > CONFIG\_BLE\_MESH > Support for BLE Mesh Foundation models*

Enable support for Opcodes Aggregator Client model.

### **CONFIG\_BLE\_MESH\_AGG\_SRV**

Opcodes Aggregator Server model

*Found in: Component config > CONFIG\_BLE\_MESH > Support for BLE Mesh Foundation models*

Enable support for Opcodes Aggregator Server model.

### **CONFIG\_BLE\_MESH\_SAR\_CLI**

SAR Configuration Client model

*Found in: Component config > CONFIG\_BLE\_MESH > Support for BLE Mesh Foundation models*

Enable support for SAR Configuration Client model.

### **CONFIG\_BLE\_MESH\_SAR\_SRV**

SAR Configuration Server model

*Found in: Component config > CONFIG\_BLE\_MESH > Support for BLE Mesh Foundation models*

Enable support for SAR Configuration Server model.

### **CONFIG\_BLE\_MESH\_COMP\_DATA\_1**

Support Composition Data Page 1

*Found in: Component config > CONFIG\_BLE\_MESH > Support for BLE Mesh Foundation models*

Composition Data Page 1 contains information about the relationships among models. Each model either can be a root model or can extend other models.

### **CONFIG\_BLE\_MESH\_COMP\_DATA\_128**

Support Composition Data Page 128

*Found in: Component config > CONFIG\_BLE\_MESH > Support for BLE Mesh Foundation models*

Composition Data Page 128 is used to indicate the structure of elements, features, and models of a node after the successful execution of the Node Address Refresh procedure or the Node Composition Refresh procedure, or after the execution of the Node Removal procedure followed by the provisioning process. Composition Data Page 128 shall be present if the node supports the Remote Provisioning Server model; otherwise it is optional.

### CONFIG\_BLE\_MESH\_MODELS\_METADATA\_0

Support Models Metadata Page 0

*Found in: Component config > CONFIG\_BLE\_MESH > Support for BLE Mesh Foundation models*

The Models Metadata state contains metadata of a node's models. The Models Metadata state is composed of a number of pages of information. Models Metadata Page 0 shall be present if the node supports the Large Composition Data Server model.

### CONFIG\_BLE\_MESH\_MODELS\_METADATA\_128

Support Models Metadata Page 128

*Found in: Component config > CONFIG\_BLE\_MESH > Support for BLE Mesh Foundation models > CONFIG\_BLE\_MESH\_MODELS\_METADATA\_0*

The Models Metadata state contains metadata of a node's models. The Models Metadata state is composed of a number of pages of information. Models Metadata Page 128 contains metadata for the node's models after the successful execution of the Node Address Refresh procedure or the Node Composition Refresh procedure, or after the execution of the Node Removal procedure followed by the provisioning process. Models Metadata Page 128 shall be present if the node supports the Remote Provisioning Server model and the node supports the Large Composition Data Server model.

### CONFIG\_BLE\_MESH\_LCD\_CLI

Large Composition Data Client model

*Found in: Component config > CONFIG\_BLE\_MESH > Support for BLE Mesh Foundation models*

Enable support for Large Composition Data Client model.

### CONFIG\_BLE\_MESH\_LCD\_SRV

Large Composition Data Server model

*Found in: Component config > CONFIG\_BLE\_MESH > Support for BLE Mesh Foundation models*

Enable support for Large Composition Data Server model.

### CONFIG\_BLE\_MESH\_RPR\_CLI

Remote Provisioning Client model

*Found in: Component config > CONFIG\_BLE\_MESH > Support for BLE Mesh Foundation models*

Enable support for Remote Provisioning Client model

### CONFIG\_BLE\_MESH\_RPR\_CLI\_PROV\_SAME\_TIME

Maximum number of PB-Remote running at the same time by Provisioner

*Found in: Component config > CONFIG\_BLE\_MESH > Support for BLE Mesh Foundation models > CONFIG\_BLE\_MESH\_RPR\_CLI*

This option specifies how many devices can be provisioned at the same time using PB-REMOTE. For example, if the value is 2, it means a Provisioner can provision two unprovisioned devices with PB-REMOTE at the same time.

**Range:**

- from 1 to 5 if *CONFIG\_BLE\_MESH\_RPR\_CLI* && *CONFIG\_BLE\_MESH*

**Default value:**

- 2 if *CONFIG\_BLE\_MESH\_RPR\_CLI* && *CONFIG\_BLE\_MESH*

### CONFIG\_BLE\_MESH\_RPR\_SRV

Remote Provisioning Server model

*Found in: Component config > CONFIG\_BLE\_MESH > Support for BLE Mesh Foundation models*

Enable support for Remote Provisioning Server model

### CONFIG\_BLE\_MESH\_RPR\_SRV\_MAX\_SCANNED\_ITEMS

Maximum number of device information can be scanned

*Found in: Component config > CONFIG\_BLE\_MESH > Support for BLE Mesh Foundation models > CONFIG\_BLE\_MESH\_RPR\_SRV*

This option specifies how many device information can a Remote Provisioning Server store each time while scanning.

**Range:**

- from 4 to 255 if *CONFIG\_BLE\_MESH\_RPR\_SRV* && *CONFIG\_BLE\_MESH*

**Default value:**

- 10 if *CONFIG\_BLE\_MESH\_RPR\_SRV* && *CONFIG\_BLE\_MESH*

### CONFIG\_BLE\_MESH\_RPR\_SRV\_ACTIVE\_SCAN

Support Active Scan for remote provisioning

*Found in: Component config > CONFIG\_BLE\_MESH > Support for BLE Mesh Foundation models > CONFIG\_BLE\_MESH\_RPR\_SRV*

Enable this option to support Active Scan for remote provisioning.

### CONFIG\_BLE\_MESH\_RPR\_SRV\_MAX\_EXT\_SCAN

Maximum number of extended scan procedures

*Found in: Component config > CONFIG\_BLE\_MESH > Support for BLE Mesh Foundation models > CONFIG\_BLE\_MESH\_RPR\_SRV*

This option specifies how many extended scan procedures can be started by the Remote Provisioning Server.

**Range:**

- from 1 to 10 if *CONFIG\_BLE\_MESH\_RPR\_SRV* && *CONFIG\_BLE\_MESH*

**Default value:**

- 1 if *CONFIG\_BLE\_MESH\_RPR\_SRV* && *CONFIG\_BLE\_MESH*

### CONFIG\_BLE\_MESH\_DF\_CLI

Directed Forwarding Configuration Client model

*Found in: Component config > CONFIG\_BLE\_MESH > Support for BLE Mesh Foundation models*

Enable support for Directed Forwarding Configuration Client model.

### CONFIG\_BLE\_MESH\_DF\_SRV

Directed Forwarding Configuration Server model

*Found in: Component config > CONFIG\_BLE\_MESH > Support for BLE Mesh Foundation models*

Enable support for Directed Forwarding Configuration Server model.

**CONFIG\_BLE\_MESH\_MAX\_DISC\_TABLE\_ENTRY\_COUNT**

Maximum number of discovery table entries in a given subnet

*Found in:* [Component config](#) > [CONFIG\\_BLE\\_MESH](#) > [Support for BLE Mesh Foundation models](#) > [CONFIG\\_BLE\\_MESH\\_DF\\_SRV](#)

Maximum number of Discovery Table entries supported by the node in a given subnet.

**Range:**

- from 2 to 255 if [CONFIG\\_BLE\\_MESH\\_DF\\_SRV](#) && [CONFIG\\_BLE\\_MESH](#)

**Default value:**

- 2 if [CONFIG\\_BLE\\_MESH\\_DF\\_SRV](#) && [CONFIG\\_BLE\\_MESH](#)

**CONFIG\_BLE\_MESH\_MAX\_FORWARD\_TABLE\_ENTRY\_COUNT**

Maximum number of forward table entries in a given subnet

*Found in:* [Component config](#) > [CONFIG\\_BLE\\_MESH](#) > [Support for BLE Mesh Foundation models](#) > [CONFIG\\_BLE\\_MESH\\_DF\\_SRV](#)

Maximum number of Forward Table entries supported by the node in a given subnet.

**Range:**

- from 2 to 64 if [CONFIG\\_BLE\\_MESH\\_DF\\_SRV](#) && [CONFIG\\_BLE\\_MESH](#)

**Default value:**

- 2 if [CONFIG\\_BLE\\_MESH\\_DF\\_SRV](#) && [CONFIG\\_BLE\\_MESH](#)

**CONFIG\_BLE\_MESH\_MAX\_DEPS\_NODES\_PER\_PATH**

Maximum number of dependent nodes per path

*Found in:* [Component config](#) > [CONFIG\\_BLE\\_MESH](#) > [Support for BLE Mesh Foundation models](#) > [CONFIG\\_BLE\\_MESH\\_DF\\_SRV](#)

Maximum size of dependent nodes list supported by each forward table entry.

**Range:**

- from 2 to 64 if [CONFIG\\_BLE\\_MESH\\_DF\\_SRV](#) && [CONFIG\\_BLE\\_MESH](#)

**Default value:**

- 2 if [CONFIG\\_BLE\\_MESH\\_DF\\_SRV](#) && [CONFIG\\_BLE\\_MESH](#)

**CONFIG\_BLE\_MESH\_PATH\_MONITOR\_TEST**

Enable Path Monitoring test mode

*Found in:* [Component config](#) > [CONFIG\\_BLE\\_MESH](#) > [Support for BLE Mesh Foundation models](#) > [CONFIG\\_BLE\\_MESH\\_DF\\_SRV](#)

The option only removes the Path Use timer; all other behavior of the device is not changed. If Path Monitoring test mode is going to be used, this option should be enabled.

**Default value:**

- No (disabled) if [CONFIG\\_BLE\\_MESH\\_DF\\_SRV](#) && [CONFIG\\_BLE\\_MESH](#)

**CONFIG\_BLE\_MESH\_SUPPORT\_DIRECTED\_PROXY**

Enable Directed Proxy functionality

*Found in:* [Component config](#) > [CONFIG\\_BLE\\_MESH](#) > [Support for BLE Mesh Foundation models](#) > [CONFIG\\_BLE\\_MESH\\_DF\\_SRV](#)

Support Directed Proxy functionality.

**Default value:**

- Yes (enabled) if `CONFIG_BLE_MESH_GATT_PROXY_SERVER` && `CONFIG_BLE_MESH_DF_SRV` && `CONFIG_BLE_MESH`

**Support for BLE Mesh Client/Server models** Contains:

- `CONFIG_BLE_MESH_MBT_CLI`
- `CONFIG_BLE_MESH_MBT_SRV`
- `CONFIG_BLE_MESH_GENERIC_BATTERY_CLI`
- `CONFIG_BLE_MESH_GENERIC_DEF_TRANS_TIME_CLI`
- `CONFIG_BLE_MESH_GENERIC_LEVEL_CLI`
- `CONFIG_BLE_MESH_GENERIC_LOCATION_CLI`
- `CONFIG_BLE_MESH_GENERIC_ONOFF_CLI`
- `CONFIG_BLE_MESH_GENERIC_POWER_LEVEL_CLI`
- `CONFIG_BLE_MESH_GENERIC_POWER_ONOFF_CLI`
- `CONFIG_BLE_MESH_GENERIC_PROPERTY_CLI`
- `CONFIG_BLE_MESH_GENERIC_SERVER`
- `CONFIG_BLE_MESH_LIGHT_CTL_CLI`
- `CONFIG_BLE_MESH_LIGHT_HSL_CLI`
- `CONFIG_BLE_MESH_LIGHT_LC_CLI`
- `CONFIG_BLE_MESH_LIGHT_LIGHTNESS_CLI`
- `CONFIG_BLE_MESH_LIGHT_XYL_CLI`
- `CONFIG_BLE_MESH_LIGHTING_SERVER`
- `CONFIG_BLE_MESH_SCENE_CLI`
- `CONFIG_BLE_MESH_SCHEDULER_CLI`
- `CONFIG_BLE_MESH_SENSOR_CLI`
- `CONFIG_BLE_MESH_SENSOR_SERVER`
- `CONFIG_BLE_MESH_TIME_SCENE_SERVER`
- `CONFIG_BLE_MESH_TIME_CLI`

**CONFIG\_BLE\_MESH\_GENERIC\_ONOFF\_CLI**

Generic OnOff Client model

*Found in: Component config > CONFIG\_BLE\_MESH > Support for BLE Mesh Client/Server models*

Enable support for Generic OnOff Client model.

**CONFIG\_BLE\_MESH\_GENERIC\_LEVEL\_CLI**

Generic Level Client model

*Found in: Component config > CONFIG\_BLE\_MESH > Support for BLE Mesh Client/Server models*

Enable support for Generic Level Client model.

**CONFIG\_BLE\_MESH\_GENERIC\_DEF\_TRANS\_TIME\_CLI**

Generic Default Transition Time Client model

*Found in: Component config > CONFIG\_BLE\_MESH > Support for BLE Mesh Client/Server models*

Enable support for Generic Default Transition Time Client model.

**CONFIG\_BLE\_MESH\_GENERIC\_POWER\_ONOFF\_CLI**

Generic Power OnOff Client model

*Found in: Component config > CONFIG\_BLE\_MESH > Support for BLE Mesh Client/Server models*

Enable support for Generic Power OnOff Client model.

### **CONFIG\_BLE\_MESH\_GENERIC\_POWER\_LEVEL\_CLI**

Generic Power Level Client model

*Found in: Component config > CONFIG\_BLE\_MESH > Support for BLE Mesh Client/Server models*

Enable support for Generic Power Level Client model.

### **CONFIG\_BLE\_MESH\_GENERIC\_BATTERY\_CLI**

Generic Battery Client model

*Found in: Component config > CONFIG\_BLE\_MESH > Support for BLE Mesh Client/Server models*

Enable support for Generic Battery Client model.

### **CONFIG\_BLE\_MESH\_GENERIC\_LOCATION\_CLI**

Generic Location Client model

*Found in: Component config > CONFIG\_BLE\_MESH > Support for BLE Mesh Client/Server models*

Enable support for Generic Location Client model.

### **CONFIG\_BLE\_MESH\_GENERIC\_PROPERTY\_CLI**

Generic Property Client model

*Found in: Component config > CONFIG\_BLE\_MESH > Support for BLE Mesh Client/Server models*

Enable support for Generic Property Client model.

### **CONFIG\_BLE\_MESH\_SENSOR\_CLI**

Sensor Client model

*Found in: Component config > CONFIG\_BLE\_MESH > Support for BLE Mesh Client/Server models*

Enable support for Sensor Client model.

### **CONFIG\_BLE\_MESH\_TIME\_CLI**

Time Client model

*Found in: Component config > CONFIG\_BLE\_MESH > Support for BLE Mesh Client/Server models*

Enable support for Time Client model.

### **CONFIG\_BLE\_MESH\_SCENE\_CLI**

Scene Client model

*Found in: Component config > CONFIG\_BLE\_MESH > Support for BLE Mesh Client/Server models*

Enable support for Scene Client model.

### **CONFIG\_BLE\_MESH\_SCHEDULER\_CLI**

Scheduler Client model

*Found in: Component config > CONFIG\_BLE\_MESH > Support for BLE Mesh Client/Server models*

Enable support for Scheduler Client model.

### **CONFIG\_BLE\_MESH\_LIGHT\_LIGHTNESS\_CLI**

Light Lightness Client model

*Found in: [Component config](#) > [CONFIG\\_BLE\\_MESH](#) > [Support for BLE Mesh Client/Server models](#)*

Enable support for Light Lightness Client model.

### **CONFIG\_BLE\_MESH\_LIGHT\_CTL\_CLI**

Light CTL Client model

*Found in: [Component config](#) > [CONFIG\\_BLE\\_MESH](#) > [Support for BLE Mesh Client/Server models](#)*

Enable support for Light CTL Client model.

### **CONFIG\_BLE\_MESH\_LIGHT\_HSL\_CLI**

Light HSL Client model

*Found in: [Component config](#) > [CONFIG\\_BLE\\_MESH](#) > [Support for BLE Mesh Client/Server models](#)*

Enable support for Light HSL Client model.

### **CONFIG\_BLE\_MESH\_LIGHT\_XYL\_CLI**

Light XYL Client model

*Found in: [Component config](#) > [CONFIG\\_BLE\\_MESH](#) > [Support for BLE Mesh Client/Server models](#)*

Enable support for Light XYL Client model.

### **CONFIG\_BLE\_MESH\_LIGHT\_LC\_CLI**

Light LC Client model

*Found in: [Component config](#) > [CONFIG\\_BLE\\_MESH](#) > [Support for BLE Mesh Client/Server models](#)*

Enable support for Light LC Client model.

### **CONFIG\_BLE\_MESH\_GENERIC\_SERVER**

Generic server models

*Found in: [Component config](#) > [CONFIG\\_BLE\\_MESH](#) > [Support for BLE Mesh Client/Server models](#)*

Enable support for Generic server models.

**Default value:**

- Yes (enabled) if [CONFIG\\_BLE\\_MESH](#)

### **CONFIG\_BLE\_MESH\_SENSOR\_SERVER**

Sensor server models

*Found in: [Component config](#) > [CONFIG\\_BLE\\_MESH](#) > [Support for BLE Mesh Client/Server models](#)*

Enable support for Sensor server models.

**Default value:**

- Yes (enabled) if [CONFIG\\_BLE\\_MESH](#)

### CONFIG\_BLE\_MESH\_TIME\_SCENE\_SERVER

Time and Scenes server models

*Found in: Component config > CONFIG\_BLE\_MESH > Support for BLE Mesh Client/Server models*

Enable support for Time and Scenes server models.

**Default value:**

- Yes (enabled) if *CONFIG\_BLE\_MESH*

### CONFIG\_BLE\_MESH\_LIGHTING\_SERVER

Lighting server models

*Found in: Component config > CONFIG\_BLE\_MESH > Support for BLE Mesh Client/Server models*

Enable support for Lighting server models.

**Default value:**

- Yes (enabled) if *CONFIG\_BLE\_MESH*

### CONFIG\_BLE\_MESH\_MBT\_CLI

BLOB Transfer Client model

*Found in: Component config > CONFIG\_BLE\_MESH > Support for BLE Mesh Client/Server models*

Enable support for BLOB Transfer Client model.

**Default value:**

- No (disabled) if *CONFIG\_BLE\_MESH*

### CONFIG\_BLE\_MESH\_MAX\_BLOB\_RECEIVERS

Maximum number of simultaneous blob receivers

*Found in: Component config > CONFIG\_BLE\_MESH > Support for BLE Mesh Client/Server models > CONFIG\_BLE\_MESH\_MBT\_CLI*

Maximum number of BLOB Transfer Server models that can participating in the BLOB transfer with a BLOB Transfer Client model.

**Range:**

- from 1 to 255 if *CONFIG\_BLE\_MESH\_MBT\_CLI* && *CONFIG\_BLE\_MESH*

**Default value:**

- 2 if *CONFIG\_BLE\_MESH\_MBT\_CLI* && *CONFIG\_BLE\_MESH*

### CONFIG\_BLE\_MESH\_MBT\_SRV

BLOB Transfer Server model

*Found in: Component config > CONFIG\_BLE\_MESH > Support for BLE Mesh Client/Server models*

Enable support for BLOB Transfer Server model.

**Default value:**

- No (disabled) if *CONFIG\_BLE\_MESH*



### CONFIG\_BLE\_MESH\_IV\_UPDATE\_TEST

Test the IV Update Procedure

Found in: *Component config* > *CONFIG\_BLE\_MESH*

This option removes the 96 hour limit of the IV Update Procedure and lets the state to be changed at any time. If IV Update test mode is going to be used, this option should be enabled.

**Default value:**

- No (disabled) if *CONFIG\_BLE\_MESH*

### BLE Mesh specific test option

 Contains:

- *CONFIG\_BLE\_MESH\_DEBUG*
- *CONFIG\_BLE\_MESH\_SHELL*
- *CONFIG\_BLE\_MESH\_BQB\_TEST*
- *CONFIG\_BLE\_MESH\_SELF\_TEST*
- *CONFIG\_BLE\_MESH\_TEST\_AUTO\_ENTER\_NETWORK*
- *CONFIG\_BLE\_MESH\_TEST\_USE\_WHITE\_LIST*

### CONFIG\_BLE\_MESH\_SELF\_TEST

Perform BLE Mesh self-tests

Found in: *Component config* > *CONFIG\_BLE\_MESH* > *BLE Mesh specific test option*

This option adds extra self-tests which are run every time BLE Mesh networking is initialized.

**Default value:**

- No (disabled) if *CONFIG\_BLE\_MESH*

### CONFIG\_BLE\_MESH\_BQB\_TEST

Enable BLE Mesh specific internal test

Found in: *Component config* > *CONFIG\_BLE\_MESH* > *BLE Mesh specific test option*

This option is used to enable some internal functions for auto-pts test.

**Default value:**

- No (disabled) if *CONFIG\_BLE\_MESH*

### CONFIG\_BLE\_MESH\_TEST\_AUTO\_ENTER\_NETWORK

Unprovisioned device enters mesh network automatically

Found in: *Component config* > *CONFIG\_BLE\_MESH* > *BLE Mesh specific test option*

With this option enabled, an unprovisioned device can automatically enters mesh network using a specific test function without the provisioning procedure. And on the Provisioner side, a test function needs to be invoked to add the node information into the mesh stack.

**Default value:**

- Yes (enabled) if *CONFIG\_BLE\_MESH\_SELF\_TEST* && *CONFIG\_BLE\_MESH*

### CONFIG\_BLE\_MESH\_TEST\_USE\_WHITE\_LIST

Use white list to filter mesh advertising packets

Found in: *Component config* > *CONFIG\_BLE\_MESH* > *BLE Mesh specific test option*

With this option enabled, users can use white list to filter mesh advertising packets while scanning.

**Default value:**

- No (disabled) if `CONFIG_BLE_MESH_SELF_TEST` && `CONFIG_BLE_MESH`

### **CONFIG\_BLE\_MESH\_SHELL**

Enable BLE Mesh shell

*Found in: Component config > CONFIG\_BLE\_MESH > BLE Mesh specific test option*

Activate shell module that provides BLE Mesh commands to the console.

**Default value:**

- No (disabled) if `CONFIG_BLE_MESH`

### **CONFIG\_BLE\_MESH\_DEBUG**

Enable BLE Mesh debug logs

*Found in: Component config > CONFIG\_BLE\_MESH > BLE Mesh specific test option*

Enable debug logs for the BLE Mesh functionality.

**Default value:**

- No (disabled) if `CONFIG_BLE_MESH`

### **CONFIG\_BLE\_MESH\_DEBUG\_NET**

Network layer debug

*Found in: Component config > CONFIG\_BLE\_MESH > BLE Mesh specific test option > CONFIG\_BLE\_MESH\_DEBUG*

Enable Network layer debug logs for the BLE Mesh functionality.

### **CONFIG\_BLE\_MESH\_DEBUG\_TRANS**

Transport layer debug

*Found in: Component config > CONFIG\_BLE\_MESH > BLE Mesh specific test option > CONFIG\_BLE\_MESH\_DEBUG*

Enable Transport layer debug logs for the BLE Mesh functionality.

### **CONFIG\_BLE\_MESH\_DEBUG\_BEACON**

Beacon debug

*Found in: Component config > CONFIG\_BLE\_MESH > BLE Mesh specific test option > CONFIG\_BLE\_MESH\_DEBUG*

Enable Beacon-related debug logs for the BLE Mesh functionality.

### **CONFIG\_BLE\_MESH\_DEBUG\_CRYPTO**

Crypto debug

*Found in: Component config > CONFIG\_BLE\_MESH > BLE Mesh specific test option > CONFIG\_BLE\_MESH\_DEBUG*

Enable cryptographic debug logs for the BLE Mesh functionality.

### **CONFIG\_BLE\_MESH\_DEBUG\_PROV**

Provisioning debug

*Found in: Component config > CONFIG\_BLE\_MESH > BLE Mesh specific test option > CONFIG\_BLE\_MESH\_DEBUG*

Enable Provisioning debug logs for the BLE Mesh functionality.

### **CONFIG\_BLE\_MESH\_DEBUG\_ACCESS**

Access layer debug

*Found in: Component config > CONFIG\_BLE\_MESH > BLE Mesh specific test option > CONFIG\_BLE\_MESH\_DEBUG*

Enable Access layer debug logs for the BLE Mesh functionality.

### **CONFIG\_BLE\_MESH\_DEBUG\_MODEL**

Foundation model debug

*Found in: Component config > CONFIG\_BLE\_MESH > BLE Mesh specific test option > CONFIG\_BLE\_MESH\_DEBUG*

Enable Foundation Models debug logs for the BLE Mesh functionality.

### **CONFIG\_BLE\_MESH\_DEBUG\_ADV**

Advertising debug

*Found in: Component config > CONFIG\_BLE\_MESH > BLE Mesh specific test option > CONFIG\_BLE\_MESH\_DEBUG*

Enable advertising debug logs for the BLE Mesh functionality.

### **CONFIG\_BLE\_MESH\_DEBUG\_LOW\_POWER**

Low Power debug

*Found in: Component config > CONFIG\_BLE\_MESH > BLE Mesh specific test option > CONFIG\_BLE\_MESH\_DEBUG*

Enable Low Power debug logs for the BLE Mesh functionality.

### **CONFIG\_BLE\_MESH\_DEBUG\_FRIEND**

Friend debug

*Found in: Component config > CONFIG\_BLE\_MESH > BLE Mesh specific test option > CONFIG\_BLE\_MESH\_DEBUG*

Enable Friend debug logs for the BLE Mesh functionality.

### **CONFIG\_BLE\_MESH\_DEBUG\_PROXY**

Proxy debug

*Found in: Component config > CONFIG\_BLE\_MESH > BLE Mesh specific test option > CONFIG\_BLE\_MESH\_DEBUG*

Enable Proxy protocol debug logs for the BLE Mesh functionality.

## CONFIG\_BLE\_MESH\_EXPERIMENTAL

Make BLE Mesh experimental features visible

*Found in: Component config > CONFIG\_BLE\_MESH*

Make BLE Mesh Experimental features visible. Experimental features list: - CONFIG\_BLE\_MESH\_NOT\_RELAY\_REPLAY\_MSG

**Default value:**

- No (disabled) if *CONFIG\_BLE\_MESH*

**Console Library** Contains:

- *CONFIG\_CONSOLE\_SORTED\_HELP*

## CONFIG\_CONSOLE\_SORTED\_HELP

Enable sorted help

*Found in: Component config > Console Library*

Instead of listing the commands in the order of registration, the help command lists the available commands in sorted order, if this option is enabled.

**Default value:**

- No (disabled)

**Driver Configurations** Contains:

- *Legacy ADC Driver Configuration*
- *Legacy DAC Driver Configurations*
- *Legacy I2S Driver Configurations*
- *Legacy MCPWM Driver Configurations*
- *Legacy PCNT Driver Configurations*
- *Legacy RMT Driver Configurations*
- *Legacy SDM Driver Configurations*
- *Legacy Temperature Sensor Driver Configurations*
- *Legacy Timer Group Driver Configurations*
- *TWAI Configuration*

**TWAI Configuration** Contains:

- *CONFIG\_TWAI\_ISR\_IN\_IRAM*

## CONFIG\_TWAI\_ISR\_IN\_IRAM

Place TWAI ISR function into IRAM

*Found in: Component config > Driver Configurations > TWAI Configuration*

Place the TWAI ISR in to IRAM. This will allow the ISR to avoid cache misses, and also be able to run whilst the cache is disabled (such as when writing to SPI Flash). Note that if this option is enabled: - Users should also set the ESP\_INTR\_FLAG\_IRAM in the driver configuration structure when installing the driver (see docs for specifics). - Alert logging (i.e., setting of the TWAI\_ALERT\_AND\_LOG flag) will have no effect.

**Default value:**

- No (disabled)

**Legacy ADC Driver Configuration** Contains:

- [CONFIG\\_ADC\\_DISABLE\\_DAC](#)
- [Legacy ADC Calibration Configuration](#)
- [CONFIG\\_ADC\\_SUPPRESS\\_DEPRECATED\\_WARN](#)

**CONFIG\_ADC\_DISABLE\_DAC**

Disable DAC when ADC2 is used on GPIO 25 and 26

*Found in: [Component config](#) > [Driver Configurations](#) > [Legacy ADC Driver Configuration](#)*

If this is set, the ADC2 driver will disable the output of the DAC corresponding to the specified channel. This is the default value.

For testing, disable this option so that we can measure the output of DAC by internal ADC.

**Default value:**

- Yes (enabled) if SOC\_DAC\_SUPPORTED

**CONFIG\_ADC\_SUPPRESS\_DEPRECATED\_WARN**

Suppress legacy driver deprecated warning

*Found in: [Component config](#) > [Driver Configurations](#) > [Legacy ADC Driver Configuration](#)*

Whether to suppress the deprecation warnings when using legacy adc driver (driver/adc.h). If you want to continue using the legacy driver, and don't want to see related deprecation warnings, you can enable this option.

**Default value:**

- No (disabled)

**Legacy ADC Calibration Configuration** Contains:

- [CONFIG\\_ADC\\_CALI\\_SUPPRESS\\_DEPRECATED\\_WARN](#)

**CONFIG\_ADC\_CALI\_SUPPRESS\_DEPRECATED\_WARN**

Suppress legacy driver deprecated warning

*Found in: [Component config](#) > [Driver Configurations](#) > [Legacy ADC Driver Configuration](#) > [Legacy ADC Calibration Configuration](#)*

Whether to suppress the deprecation warnings when using legacy adc calibration driver (esp\_adc\_cal.h). If you want to continue using the legacy driver, and don't want to see related deprecation warnings, you can enable this option.

**Default value:**

- No (disabled)

**Legacy DAC Driver Configurations** Contains:

- [CONFIG\\_DAC\\_SUPPRESS\\_DEPRECATED\\_WARN](#)

**CONFIG\_DAC\_SUPPRESS\_DEPRECATED\_WARN**

Suppress legacy driver deprecated warning

*Found in: [Component config](#) > [Driver Configurations](#) > [Legacy DAC Driver Configurations](#)*

Whether to suppress the deprecation warnings when using legacy dac driver (driver/dac.h). If you want to continue using the legacy driver, and don't want to see related deprecation warnings, you can enable this option.

**Default value:**

- No (disabled) if SOC\_DAC\_SUPPORTED

**Legacy MCPWM Driver Configurations** Contains:

- [CONFIG\\_MCPWM\\_SUPPRESS\\_DEPRECATED\\_WARN](#)

**CONFIG\_MCPWM\_SUPPRESS\_DEPRECATED\_WARN**

Suppress legacy driver deprecated warning

*Found in: [Component config](#) > [Driver Configurations](#) > [Legacy MCPWM Driver Configurations](#)*

Whether to suppress the deprecation warnings when using legacy MCPWM driver (driver/mcpwm.h). If you want to continue using the legacy driver, and don't want to see related deprecation warnings, you can enable this option.

**Default value:**

- No (disabled)

**Legacy Timer Group Driver Configurations** Contains:

- [CONFIG\\_GPTIMER\\_SUPPRESS\\_DEPRECATED\\_WARN](#)

**CONFIG\_GPTIMER\_SUPPRESS\_DEPRECATED\_WARN**

Suppress legacy driver deprecated warning

*Found in: [Component config](#) > [Driver Configurations](#) > [Legacy Timer Group Driver Configurations](#)*

Whether to suppress the deprecation warnings when using legacy timer group driver (driver/timer.h). If you want to continue using the legacy driver, and don't want to see related deprecation warnings, you can enable this option.

**Default value:**

- No (disabled)

**Legacy RMT Driver Configurations** Contains:

- [CONFIG\\_RMT\\_SUPPRESS\\_DEPRECATED\\_WARN](#)

**CONFIG\_RMT\_SUPPRESS\_DEPRECATED\_WARN**

Suppress legacy driver deprecated warning

*Found in: [Component config](#) > [Driver Configurations](#) > [Legacy RMT Driver Configurations](#)*

Whether to suppress the deprecation warnings when using legacy rmt driver (driver/rmt.h). If you want to continue using the legacy driver, and don't want to see related deprecation warnings, you can enable this option.

**Default value:**

- No (disabled)

**Legacy I2S Driver Configurations** Contains:

- [CONFIG\\_I2S\\_SUPPRESS\\_DEPRECATED\\_WARN](#)

### CONFIG\_I2S\_SUPPRESS\_DEPRECATE\_WARN

Suppress legacy driver deprecated warning

*Found in: [Component config](#) > [Driver Configurations](#) > [Legacy I2S Driver Configurations](#)*

Whether to suppress the deprecation warnings when using legacy i2s driver (driver/i2s.h). If you want to continue using the legacy driver, and don't want to see related deprecation warnings, you can enable this option.

**Default value:**

- No (disabled)

### Legacy PCNT Driver Configurations

 Contains:

- [CONFIG\\_PCNT\\_SUPPRESS\\_DEPRECATE\\_WARN](#)

### CONFIG\_PCNT\_SUPPRESS\_DEPRECATE\_WARN

Suppress legacy driver deprecated warning

*Found in: [Component config](#) > [Driver Configurations](#) > [Legacy PCNT Driver Configurations](#)*

whether to suppress the deprecation warnings when using legacy PCNT driver (driver/pcnt.h). If you want to continue using the legacy driver, and don't want to see related deprecation warnings, you can enable this option.

**Default value:**

- No (disabled)

### Legacy SDM Driver Configurations

 Contains:

- [CONFIG\\_SDM\\_SUPPRESS\\_DEPRECATE\\_WARN](#)

### CONFIG\_SDM\_SUPPRESS\_DEPRECATE\_WARN

Suppress legacy driver deprecated warning

*Found in: [Component config](#) > [Driver Configurations](#) > [Legacy SDM Driver Configurations](#)*

whether to suppress the deprecation warnings when using legacy SDM driver (driver/sigmadelta.h). If you want to continue using the legacy driver, and don't want to see related deprecation warnings, you can enable this option.

**Default value:**

- No (disabled)

### Legacy Temperature Sensor Driver Configurations

 Contains:

- [CONFIG\\_TEMP\\_SENSOR\\_SUPPRESS\\_DEPRECATE\\_WARN](#)

### CONFIG\_TEMP\_SENSOR\_SUPPRESS\_DEPRECATE\_WARN

Suppress legacy driver deprecated warning

*Found in: [Component config](#) > [Driver Configurations](#) > [Legacy Temperature Sensor Driver Configurations](#)*

whether to suppress the deprecation warnings when using legacy temperature sensor driver (driver/temp\_sensor.h). If you want to continue using the legacy driver, and don't want to see related deprecation warnings, you can enable this option.

**Default value:**

- No (disabled)

**eFuse Bit Manager** Contains:

- [CONFIG\\_EFUSE\\_VIRTUAL](#)
- [CONFIG\\_EFUSE\\_CUSTOM\\_TABLE](#)

### **CONFIG\_EFUSE\_CUSTOM\_TABLE**

Use custom eFuse table

*Found in:* [Component config](#) > [eFuse Bit Manager](#)

Allows to generate a structure for eFuse from the CSV file.

**Default value:**

- No (disabled)

### **CONFIG\_EFUSE\_CUSTOM\_TABLE\_FILENAME**

Custom eFuse CSV file

*Found in:* [Component config](#) > [eFuse Bit Manager](#) > [CONFIG\\_EFUSE\\_CUSTOM\\_TABLE](#)

Name of the custom eFuse CSV filename. This path is evaluated relative to the project root directory.

**Default value:**

- "main/esp\_efuse\_custom\_table.csv" if [CONFIG\\_EFUSE\\_CUSTOM\\_TABLE](#)

### **CONFIG\_EFUSE\_VIRTUAL**

Simulate eFuse operations in RAM

*Found in:* [Component config](#) > [eFuse Bit Manager](#)

If "n" - No virtual mode. All eFuse operations are real and use eFuse registers. If "y" - The virtual mode is enabled and all eFuse operations (read and write) are redirected to RAM instead of eFuse registers, all permanent changes (via eFuse) are disabled. Log output will state changes that would be applied, but they will not be.

If it is "y", then SECURE\_FLASH\_ENCRYPTION\_MODE\_RELEASE cannot be used. Because the EFUSE VIRT mode is for testing only.

During startup, the eFuses are copied into RAM. This mode is useful for fast tests.

**Default value:**

- No (disabled)

### **CONFIG\_EFUSE\_VIRTUAL\_KEEP\_IN\_FLASH**

Keep eFuses in flash

*Found in:* [Component config](#) > [eFuse Bit Manager](#) > [CONFIG\\_EFUSE\\_VIRTUAL](#)

In addition to the "Simulate eFuse operations in RAM" option, this option just adds a feature to keep eFuses after reboots in flash memory. To use this mode the partition\_table should have the *efuse* partition. partition.csv: "efuse\_em, data, efuse, , 0x2000,"

During startup, the eFuses are copied from flash or, in case if flash is empty, from real eFuse to RAM and then update flash. This mode is useful when need to keep changes after reboot (testing secure\_boot and flash\_encryption).



## CONFIG\_EFUSE\_VIRTUAL\_LOG\_ALL\_WRITES

Log all virtual writes

*Found in:* [Component config](#) > [eFuse Bit Manager](#) > [CONFIG\\_EFUSE\\_VIRTUAL](#)

If enabled, log efuse burns. This shows changes that would be made.

## ESP-TLS Contains:

- [CONFIG\\_ESP\\_TLS\\_INSECURE](#)
- [CONFIG\\_ESP\\_TLS\\_SERVER\\_CERT\\_SELECT\\_HOOK](#)
- [CONFIG\\_ESP\\_TLS\\_LIBRARY\\_CHOOSE](#)
- [CONFIG\\_ESP\\_TLS\\_CLIENT\\_SESSION\\_TICKETS](#)
- [CONFIG\\_ESP\\_DEBUG\\_WOLFSSL](#)
- [CONFIG\\_ESP\\_TLS\\_PSK\\_VERIFICATION](#)
- [CONFIG\\_ESP\\_TLS\\_SERVER\\_SESSION\\_TICKETS](#)
- [CONFIG\\_ESP\\_WOLFSSL\\_SMALL\\_CERT\\_VERIFY](#)
- [CONFIG\\_ESP\\_TLS\\_SERVER\\_MIN\\_AUTH\\_MODE\\_OPTIONAL](#)
- [CONFIG\\_ESP\\_TLS\\_USE\\_DS\\_PERIPHERAL](#)

## CONFIG\_ESP\_TLS\_LIBRARY\_CHOOSE

Choose SSL/TLS library for ESP-TLS (See help for more Info)

*Found in:* [Component config](#) > [ESP-TLS](#)

The ESP-TLS APIs support multiple backend TLS libraries. Currently mbedTLS and WolfSSL are supported. Different TLS libraries may support different features and have different resource usage. Consult the ESP-TLS documentation in ESP-IDF Programming guide for more details.

Available options:

- mbedTLS (CONFIG\_ESP\_TLS\_USING\_MBEDTLS)
- wolfSSL (License info in wolfSSL directory README) (CONFIG\_ESP\_TLS\_USING\_WOLFSSL)

## CONFIG\_ESP\_TLS\_USE\_DS\_PERIPHERAL

Use Digital Signature (DS) Peripheral with ESP-TLS

*Found in:* [Component config](#) > [ESP-TLS](#)

Enable use of the Digital Signature Peripheral for ESP-TLS. The DS peripheral can only be used when it is appropriately configured for TLS. Consult the ESP-TLS documentation in ESP-IDF Programming Guide for more details.

### Default value:

- Yes (enabled)

## CONFIG\_ESP\_TLS\_CLIENT\_SESSION\_TICKETS

Enable client session tickets

*Found in:* [Component config](#) > [ESP-TLS](#)

Enable session ticket support as specified in RFC5077.

### CONFIG\_ESP\_TLS\_SERVER\_SESSION\_TICKETS

Enable server session tickets

*Found in:* [Component config](#) > [ESP-TLS](#)

Enable session ticket support as specified in RFC5077

### CONFIG\_ESP\_TLS\_SERVER\_SESSION\_TICKET\_TIMEOUT

Server session ticket timeout in seconds

*Found in:* [Component config](#) > [ESP-TLS](#) > [CONFIG\\_ESP\\_TLS\\_SERVER\\_SESSION\\_TICKETS](#)

Sets the session ticket timeout used in the tls server.

**Default value:**

- 86400 if [CONFIG\\_ESP\\_TLS\\_SERVER\\_SESSION\\_TICKETS](#)

### CONFIG\_ESP\_TLS\_SERVER\_CERT\_SELECT\_HOOK

Certificate selection hook

*Found in:* [Component config](#) > [ESP-TLS](#)

Ability to configure and use a certificate selection callback during server handshake, to select a certificate to present to the client based on the TLS extensions supplied in the client hello (alpn, sni, etc).

### CONFIG\_ESP\_TLS\_SERVER\_MIN\_AUTH\_MODE\_OPTIONAL

ESP-TLS Server: Set minimum Certificate Verification mode to Optional

*Found in:* [Component config](#) > [ESP-TLS](#)

When this option is enabled, the peer (here, the client) certificate is checked by the server, however the handshake continues even if verification failed. By default, the peer certificate is not checked and ignored by the server.

`mbedtls_ssl_get_verify_result()` can be called after the handshake is complete to retrieve status of verification.

### CONFIG\_ESP\_TLS\_PSK\_VERIFICATION

Enable PSK verification

*Found in:* [Component config](#) > [ESP-TLS](#)

Enable support for pre shared key ciphers, supported for both mbedtls as well as wolfSSL TLS library.

### CONFIG\_ESP\_TLS\_INSECURE

Allow potentially insecure options

*Found in:* [Component config](#) > [ESP-TLS](#)

You can enable some potentially insecure options. These options should only be used for testing purposes. Only enable these options if you are very sure.

### CONFIG\_ESP\_TLS\_SKIP\_SERVER\_CERT\_VERIFY

Skip server certificate verification by default (WARNING: ONLY FOR TESTING PURPOSE, READ HELP)

Found in: *Component config > ESP-TLS > CONFIG\_ESP\_TLS\_INSECURE*

After enabling this option the esp-tls client will skip the server certificate verification by default. Note that this option will only modify the default behaviour of esp-tls client regarding server cert verification. The default behaviour should only be applicable when no other option regarding the server cert verification is opted in the esp-tls config (e.g. `cert_bundle_attach`, `use_global_ca_store` etc.). WARNING : Enabling this option comes with a potential risk of establishing a TLS connection with a server which has a fake identity, provided that the server certificate is not provided either through API or other mechanism like `ca_store` etc.

### CONFIG\_ESP\_WOLFSSL\_SMALL\_CERT\_VERIFY

Enable SMALL\_CERT\_VERIFY

Found in: *Component config > ESP-TLS*

Enables server verification with Intermediate CA cert, does not authenticate full chain of trust upto the root CA cert (After Enabling this option client only needs to have Intermediate CA certificate of the server to authenticate server, root CA cert is not necessary).

**Default value:**

- Yes (enabled) if *CONFIG\_ESP\_TLS\_USING\_WOLFSSL*

### CONFIG\_ESP\_DEBUG\_WOLFSSL

Enable debug logs for wolfSSL

Found in: *Component config > ESP-TLS*

Enable detailed debug prints for wolfSSL SSL library.

### ADC and ADC Calibration Contains:

- *ADC Calibration Configurations*
- *CONFIG\_ADC\_CONTINUOUS\_ISR\_IRAM\_SAFE*
- *CONFIG\_ADC\_DISABLE\_DAC\_OUTPUT*
- *CONFIG\_ADC\_ENABLE\_DEBUG\_LOG*
- *CONFIG\_ADC\_ONESHOT\_CTRL\_FUNC\_IN\_IRAM*

### CONFIG\_ADC\_ONESHOT\_CTRL\_FUNC\_IN\_IRAM

Place ISR version ADC oneshot mode read function into IRAM

Found in: *Component config > ADC and ADC Calibration*

Place ISR version ADC oneshot mode read function into IRAM.

**Default value:**

- No (disabled)

### CONFIG\_ADC\_CONTINUOUS\_ISR\_IRAM\_SAFE

ADC continuous mode driver ISR IRAM-Safe

Found in: *Component config > ADC and ADC Calibration*

Ensure the ADC continuous mode ISR is IRAM-Safe. When enabled, the ISR handler will be available when the cache is disabled.

**Default value:**

- No (disabled)

**ADC Calibration Configurations****CONFIG\_ADC\_DISABLE\_DAC\_OUTPUT**

Disable DAC when ADC2 is in use

*Found in: [Component config](#) > [ADC and ADC Calibration](#)*

By default, this is set. The ADC oneshot driver will disable the output of the corresponding DAC channels: ESP32: IO25 and IO26 ESP32S2: IO17 and IO18

Disable this option so as to measure the output of DAC by internal ADC, for test usage.

**Default value:**

- Yes (enabled) if SOC\_DAC\_SUPPORTED

**CONFIG\_ADC\_ENABLE\_DEBUG\_LOG**

Enable ADC debug log

*Found in: [Component config](#) > [ADC and ADC Calibration](#)*

whether to enable the debug log message for ADC driver. Note that this option only controls the ADC driver log, will not affect other drivers.

note: This cannot be used in the ADC legacy driver.

**Default value:**

- No (disabled)

**Wireless Coexistence** Contains:

- [CONFIG\\_ESP\\_COEX\\_EXTERNAL\\_COEXIST\\_ENABLE](#)
- [CONFIG\\_ESP\\_COEX\\_SW\\_COEXIST\\_ENABLE](#)
- [CONFIG\\_ESP\\_COEX\\_POWER\\_MANAGEMENT](#)

**CONFIG\_ESP\_COEX\_SW\_COEXIST\_ENABLE**

Software controls WiFi/Bluetooth coexistence

*Found in: [Component config](#) > [Wireless Coexistence](#)*

If enabled, WiFi & Bluetooth coexistence is controlled by software rather than hardware. Recommended for heavy traffic scenarios. Both coexistence configuration options are automatically managed, no user intervention is required. If only Bluetooth is used, it is recommended to disable this option to reduce binary file size.

**Default value:**

- Yes (enabled) if [CONFIG\\_IEEE802154\\_ENABLED](#) && [CONFIG\\_BT\\_ENABLED](#)

**CONFIG\_ESP\_COEX\_EXTERNAL\_COEXIST\_ENABLE**

External Coexistence

*Found in: [Component config](#) > [Wireless Coexistence](#)*

If enabled, HW External coexistence arbitration is managed by GPIO pins. It can support three types of wired combinations so far which are 1-wired/2-wired/3-wired. User can select GPIO pins in application code with configure interfaces.

This function depends on BT-off because currently we do not support external coex and internal coex simultaneously.

### CONFIG\_ESP\_COEX\_POWER\_MANAGEMENT

Support power management under coexistence

*Found in: Component config > Wireless Coexistence*

If enabled, coexist power management will be enabled.

**Default value:**

- No (disabled) if *CONFIG\_ESP\_COEX\_SW\_COEXIST\_ENABLE*

### Common ESP-related Contains:

- *CONFIG\_ESP\_ERR\_TO\_NAME\_LOOKUP*

### CONFIG\_ESP\_ERR\_TO\_NAME\_LOOKUP

Enable lookup of error code strings

*Found in: Component config > Common ESP-related*

Functions `esp_err_to_name()` and `esp_err_to_name_r()` return string representations of error codes from a pre-generated lookup table. This option can be used to turn off the use of the look-up table in order to save memory but this comes at the price of sacrificing distinguishable (meaningful) output string representations.

**Default value:**

- Yes (enabled)

### ESP-Driver:Analog Comparator Configurations Contains:

- *CONFIG\_ANA\_CMPR\_ISR\_IRAM\_SAFE*
- *CONFIG\_ANA\_CMPR\_ENABLE\_DEBUG\_LOG*
- *CONFIG\_ANA\_CMPR\_CTRL\_FUNC\_IN\_IRAM*

### CONFIG\_ANA\_CMPR\_ISR\_IRAM\_SAFE

Analog comparator ISR IRAM-Safe

*Found in: Component config > ESP-Driver:Analog Comparator Configurations*

Ensure the Analog Comparator interrupt is IRAM-Safe by allowing the interrupt handler to be executable when the cache is disabled (e.g. SPI Flash write).

**Default value:**

- No (disabled)

### CONFIG\_ANA\_CMPR\_CTRL\_FUNC\_IN\_IRAM

Place Analog Comparator control functions into IRAM

*Found in: Component config > ESP-Driver:Analog Comparator Configurations*

Place Analog Comparator control functions (like `ana_cmpr_set_internal_reference`) into IRAM, so that these functions can be IRAM-safe and able to be called in an IRAM interrupt context. Enabling this option can improve driver performance as well.

**Default value:**

- No (disabled)

**CONFIG\_ANA\_CMPR\_ENABLE\_DEBUG\_LOG**

Enable debug log

Found in: *Component config > ESP-Driver:Analog Comparator Configurations*

whether to enable the debug log message for Analog Comparator driver. Note that, this option only controls the Analog Comparator driver log, won't affect other drivers.

**Default value:**

- No (disabled)

**ESP-Driver:Camera Controller Configurations** Contains:

- *CONFIG\_CAM\_CTLR\_MIPI\_CSI\_ISR\_IRAM\_SAFE*
- *CONFIG\_CAM\_CTLR\_DVP\_CAM\_ISR\_IRAM\_SAFE*
- *CONFIG\_CAM\_CTLR\_ISP\_DVP\_ISR\_IRAM\_SAFE*

**CONFIG\_CAM\_CTLR\_MIPI\_CSI\_ISR\_IRAM\_SAFE**

CSI ISR IRAM-Safe

Found in: *Component config > ESP-Driver:Camera Controller Configurations*

Ensure the CSI driver ISR is IRAM-Safe. When enabled, the ISR handler will be available when the cache is disabled.

**Default value:**

- No (disabled) if `SOC_MIPI_CSI_SUPPORTED && (SOC_MIPI_CSI_SUPPORTED || SOC_LCDCAM_CAM_SUPPORTED)`

**CONFIG\_CAM\_CTLR\_ISP\_DVP\_ISR\_IRAM\_SAFE**

ISP\_DVP ISR IRAM-Safe

Found in: *Component config > ESP-Driver:Camera Controller Configurations*

Ensure the ISP\_DVP driver ISR is IRAM-Safe. When enabled, the ISR handler will be available when the cache is disabled.

**Default value:**

- No (disabled) if `SOC_MIPI_CSI_SUPPORTED || SOC_LCDCAM_CAM_SUPPORTED`

**CONFIG\_CAM\_CTLR\_DVP\_CAM\_ISR\_IRAM\_SAFE**

DVP ISR IRAM-Safe

Found in: *Component config > ESP-Driver:Camera Controller Configurations*

Ensure the DVP driver ISR is IRAM-Safe. When enabled, the ISR handler will be available when the cache is disabled.

**Default value:**

- No (disabled) if `SOC_LCDCAM_CAM_SUPPORTED && (SOC_MIPI_CSI_SUPPORTED || SOC_LCDCAM_CAM_SUPPORTED)`

**ESP-Driver:DAC Configurations** Contains:

- *CONFIG\_DAC\_DMA\_AUTO\_16BIT\_ALIGN*
- *CONFIG\_DAC\_ISR\_IRAM\_SAFE*
- *CONFIG\_DAC\_ENABLE\_DEBUG\_LOG*
- *CONFIG\_DAC\_CTRL\_FUNC\_IN\_IRAM*

### CONFIG\_DAC\_CTRL\_FUNC\_IN\_IRAM

Place DAC control functions into IRAM

*Found in: [Component config](#) > [ESP-Driver:DAC Configurations](#)*

Place DAC control functions (e.g. 'dac\_one\_shot\_output\_voltage') into IRAM, so that this function can be IRAM-safe and able to be called in the other IRAM interrupt context. Enabling this option can improve driver performance as well.

**Default value:**

- No (disabled) if SOC\_DAC\_SUPPORTED

### CONFIG\_DAC\_ISR\_IRAM\_SAFE

DAC ISR IRAM-Safe

*Found in: [Component config](#) > [ESP-Driver:DAC Configurations](#)*

Ensure the DAC interrupt is IRAM-Safe by allowing the interrupt handler to be executable when the cache is disabled (e.g. SPI Flash write).

**Default value:**

- No (disabled) if SOC\_DAC\_SUPPORTED

### CONFIG\_DAC\_ENABLE\_DEBUG\_LOG

Enable debug log

*Found in: [Component config](#) > [ESP-Driver:DAC Configurations](#)*

whether to enable the debug log message for DAC driver. Note that, this option only controls the DAC driver log, won't affect other drivers.

**Default value:**

- No (disabled) if SOC\_DAC\_SUPPORTED

### CONFIG\_DAC\_DMA\_AUTO\_16BIT\_ALIGN

Align the continuous data to 16 bit automatically

*Found in: [Component config](#) > [ESP-Driver:DAC Configurations](#)*

Whether to left shift the continuous data to align every bytes to 16 bits in the driver. On ESP32, although the DAC resolution is only 8 bits, the hardware requires 16 bits data in continuous mode. By enabling this option, the driver will left shift 8 bits for the input data automatically. Only disable this option when you decide to do this step by yourself. Note that the driver will allocate a new piece of memory to save the converted data.

**Default value:**

- Yes (enabled) if SOC\_DAC\_DMA\_16BIT\_ALIGN && SOC\_DAC\_SUPPORTED

### ESP-Driver:GPIO Configurations

 Contains:

- [CONFIG\\_GPIO\\_CTRL\\_FUNC\\_IN\\_IRAM](#)

### CONFIG\_GPIO\_CTRL\_FUNC\_IN\_IRAM

Place GPIO control functions into IRAM

*Found in: [Component config](#) > [ESP-Driver:GPIO Configurations](#)*

Place GPIO control functions (like intr\_disable/set\_level) into IRAM, so that these functions can be IRAM-safe and able to be called in the other IRAM interrupt context.

**Default value:**

- No (disabled)

**ESP-Driver:GPTimer Configurations** Contains:

- [CONFIG\\_GPTIMER\\_ENABLE\\_DEBUG\\_LOG](#)
- [CONFIG\\_GPTIMER\\_ISR\\_IRAM\\_SAFE](#)
- [CONFIG\\_GPTIMER\\_CTRL\\_FUNC\\_IN\\_IRAM](#)
- [CONFIG\\_GPTIMER\\_ISR\\_HANDLER\\_IN\\_IRAM](#)

**CONFIG\_GPTIMER\_ISR\_HANDLER\_IN\_IRAM**

Place GPTimer ISR handler into IRAM

*Found in: [Component config](#) > [ESP-Driver:GPTimer Configurations](#)*

Place GPTimer ISR handler into IRAM for better performance and fewer cache misses.

**Default value:**

- Yes (enabled)

**CONFIG\_GPTIMER\_CTRL\_FUNC\_IN\_IRAM**

Place GPTimer control functions into IRAM

*Found in: [Component config](#) > [ESP-Driver:GPTimer Configurations](#)*

Place GPTimer control functions (like start/stop) into IRAM, so that these functions can be IRAM-safe and able to be called in the other IRAM interrupt context. Enabling this option can improve driver performance as well.

**Default value:**

- No (disabled)

**CONFIG\_GPTIMER\_ISR\_IRAM\_SAFE**

GPTimer ISR IRAM-Safe

*Found in: [Component config](#) > [ESP-Driver:GPTimer Configurations](#)*

Ensure the GPTimer interrupt is IRAM-Safe by allowing the interrupt handler to be executable when the cache is disabled (e.g. SPI Flash write).

**Default value:**

- No (disabled)

**CONFIG\_GPTIMER\_ENABLE\_DEBUG\_LOG**

Enable debug log

*Found in: [Component config](#) > [ESP-Driver:GPTimer Configurations](#)*

whether to enable the debug log message for GPTimer driver. Note that, this option only controls the GPTimer driver log, won't affect other drivers.

**Default value:**

- No (disabled)

**ESP-Driver:I2C Configurations** Contains:

- [CONFIG\\_I2C\\_ENABLE\\_DEBUG\\_LOG](#)
- [CONFIG\\_I2C\\_ISR\\_IRAM\\_SAFE](#)



### CONFIG\_I2C\_ISR\_IRAM\_SAFE

I2C ISR IRAM-Safe

*Found in: Component config > ESP-Driver:I2C Configurations*

Ensure the I2C interrupt is IRAM-Safe by allowing the interrupt handler to be executable when the cache is disabled (e.g. SPI Flash write). note: This cannot be used in the I2C legacy driver.

**Default value:**

- No (disabled)

### CONFIG\_I2C\_ENABLE\_DEBUG\_LOG

Enable I2C debug log

*Found in: Component config > ESP-Driver:I2C Configurations*

whether to enable the debug log message for I2C driver. Note that this option only controls the I2C driver log, will not affect other drivers.

note: This cannot be used in the I2C legacy driver.

**Default value:**

- No (disabled)

**ESP-Driver:I2S Configurations** Contains:

- [CONFIG\\_I2S\\_ENABLE\\_DEBUG\\_LOG](#)
- [CONFIG\\_I2S\\_ISR\\_IRAM\\_SAFE](#)

### CONFIG\_I2S\_ISR\_IRAM\_SAFE

I2S ISR IRAM-Safe

*Found in: Component config > ESP-Driver:I2S Configurations*

Ensure the I2S interrupt is IRAM-Safe by allowing the interrupt handler to be executable when the cache is disabled (e.g. SPI Flash write).

**Default value:**

- No (disabled)

### CONFIG\_I2S\_ENABLE\_DEBUG\_LOG

Enable I2S debug log

*Found in: Component config > ESP-Driver:I2S Configurations*

whether to enable the debug log message for I2S driver. Note that, this option only controls the I2S driver log, will not affect other drivers.

**Default value:**

- No (disabled)

**ESP-Driver:ISP Configurations** Contains:

- [CONFIG\\_ISP\\_ISR\\_IRAM\\_SAFE](#)

### CONFIG\_ISP\_ISR\_IRAM\_SAFE

ISP driver ISR IRAM-Safe

*Found in: Component config > ESP-Driver:ISP Configurations*

Ensure the ISP driver ISR is IRAM-Safe. When enabled, the ISR handler will be available when the cache is disabled.

**Default value:**

- No (disabled) if SOC\_ISP\_SUPPORTED

### ESP-Driver:JPEG-Codec Configurations

 Contains:

- [CONFIG\\_JPEG\\_ENABLE\\_DEBUG\\_LOG](#)

### CONFIG\_JPEG\_ENABLE\_DEBUG\_LOG

Enable debug log

*Found in: Component config > ESP-Driver:JPEG-Codec Configurations*

whether to enable the debug log message for JPEG driver. Note that, this option only controls the JPEG driver log, won't affect other drivers. Please also note, enable this option will make jpeg codec process speed much slower.

**Default value:**

- No (disabled) if SOC\_JPEG\_CODEC\_SUPPORTED

### ESP-Driver:LEDC Configurations

 Contains:

- [CONFIG\\_LEDC\\_CTRL\\_FUNC\\_IN\\_IRAM](#)

### CONFIG\_LEDC\_CTRL\_FUNC\_IN\_IRAM

Place LEDC control functions into IRAM

*Found in: Component config > ESP-Driver:LEDC Configurations*

Place LEDC control functions (ledc\_update\_duty and ledc\_stop) into IRAM, so that these functions can be IRAM-safe and able to be called in an IRAM context. Enabling this option can improve driver performance as well.

**Default value:**

- No (disabled)

### ESP-Driver:MCPWM Configurations

 Contains:

- [CONFIG\\_MCPWM\\_ENABLE\\_DEBUG\\_LOG](#)
- [CONFIG\\_MCPWM\\_CTRL\\_FUNC\\_IN\\_IRAM](#)
- [CONFIG\\_MCPWM\\_ISR\\_IRAM\\_SAFE](#)

### CONFIG\_MCPWM\_ISR\_IRAM\_SAFE

Place MCPWM ISR function into IRAM

*Found in: Component config > ESP-Driver:MCPWM Configurations*

This will ensure the MCPWM interrupt handle is IRAM-Safe, allow to avoid flash cache misses, and also be able to run whilst the cache is disabled. (e.g. SPI Flash write)

**Default value:**

- No (disabled)

### CONFIG\_MCPWM\_CTRL\_FUNC\_IN\_IRAM

Place MCPWM control functions into IRAM

*Found in: Component config > ESP-Driver:MCPWM Configurations*

Place MCPWM control functions (like `set_compare_value`) into IRAM, so that these functions can be IRAM-safe and able to be called in the other IRAM interrupt context. Enabling this option can improve driver performance as well.

**Default value:**

- No (disabled)

### CONFIG\_MCPWM\_ENABLE\_DEBUG\_LOG

Enable debug log

*Found in: Component config > ESP-Driver:MCPWM Configurations*

whether to enable the debug log message for MCPWM driver. Note that, this option only controls the MCPWM driver log, won't affect other drivers.

**Default value:**

- No (disabled)

### ESP-Driver:Parallel IO Configurations

 Contains:

- [CONFIG\\_PARLIO\\_ENABLE\\_DEBUG\\_LOG](#)
- [CONFIG\\_PARLIO\\_ISR\\_IRAM\\_SAFE](#)

### CONFIG\_PARLIO\_ENABLE\_DEBUG\_LOG

Enable debug log

*Found in: Component config > ESP-Driver:Parallel IO Configurations*

whether to enable the debug log message for parallel IO driver. Note that, this option only controls the parallel IO driver log, won't affect other drivers.

**Default value:**

- No (disabled)

### CONFIG\_PARLIO\_ISR\_IRAM\_SAFE

Parallel IO ISR IRAM-Safe

*Found in: Component config > ESP-Driver:Parallel IO Configurations*

Ensure the Parallel IO interrupt is IRAM-Safe by allowing the interrupt handler to be executable when the cache is disabled (e.g. SPI Flash write).

**Default value:**

- No (disabled)

### ESP-Driver:PCNT Configurations

 Contains:

- [CONFIG\\_PCNT\\_ENABLE\\_DEBUG\\_LOG](#)
- [CONFIG\\_PCNT\\_ISR\\_IRAM\\_SAFE](#)
- [CONFIG\\_PCNT\\_CTRL\\_FUNC\\_IN\\_IRAM](#)

### CONFIG\_PCNT\_CTRL\_FUNC\_IN\_IRAM

Place PCNT control functions into IRAM

*Found in: [Component config](#) > [ESP-Driver:PCNT Configurations](#)*

Place PCNT control functions (like start/stop) into IRAM, so that these functions can be IRAM-safe and able to be called in the other IRAM interrupt context. Enabling this option can improve driver performance as well.

**Default value:**

- No (disabled)

### CONFIG\_PCNT\_ISR\_IRAM\_SAFE

PCNT ISR IRAM-Safe

*Found in: [Component config](#) > [ESP-Driver:PCNT Configurations](#)*

Ensure the PCNT interrupt is IRAM-Safe by allowing the interrupt handler to be executable when the cache is disabled (e.g. SPI Flash write).

**Default value:**

- No (disabled)

### CONFIG\_PCNT\_ENABLE\_DEBUG\_LOG

Enable debug log

*Found in: [Component config](#) > [ESP-Driver:PCNT Configurations](#)*

whether to enable the debug log message for PCNT driver. Note that, this option only controls the PCNT driver log, won't affect other drivers.

**Default value:**

- No (disabled)

### ESP-Driver:RMT Configurations

 Contains:

- [CONFIG\\_RMT\\_ENABLE\\_DEBUG\\_LOG](#)
- [CONFIG\\_RMT\\_RECV\\_FUNC\\_IN\\_IRAM](#)
- [CONFIG\\_RMT\\_ISR\\_IRAM\\_SAFE](#)

### CONFIG\_RMT\_ISR\_IRAM\_SAFE

RMT ISR IRAM-Safe

*Found in: [Component config](#) > [ESP-Driver:RMT Configurations](#)*

Ensure the RMT interrupt is IRAM-Safe by allowing the interrupt handler to be executable when the cache is disabled (e.g. SPI Flash write).

**Default value:**

- No (disabled)

### CONFIG\_RMT\_RECV\_FUNC\_IN\_IRAM

Place RMT receive function into IRAM

*Found in: [Component config](#) > [ESP-Driver:RMT Configurations](#)*

Place RMT receive function into IRAM, so that the receive function can be IRAM-safe and able to be called when the flash cache is disabled. Enabling this option can improve driver performance as well.

**Default value:**

- No (disabled)

### CONFIG\_RMT\_ENABLE\_DEBUG\_LOG

Enable debug log

*Found in: Component config > ESP-Driver:RMT Configurations*

whether to enable the debug log message for RMT driver. Note that, this option only controls the RMT driver log, won't affect other drivers.

**Default value:**

- No (disabled)

### ESP-Driver:Sigma Delta Modulator Configurations

 Contains:

- [CONFIG\\_SDM\\_ENABLE\\_DEBUG\\_LOG](#)
- [CONFIG\\_SDM\\_CTRL\\_FUNC\\_IN\\_IRAM](#)

### CONFIG\_SDM\_CTRL\_FUNC\_IN\_IRAM

Place SDM control functions into IRAM

*Found in: Component config > ESP-Driver:Sigma Delta Modulator Configurations*

Place SDM control functions (like `set_duty`) into IRAM, so that these functions can be IRAM-safe and able to be called in the other IRAM interrupt context. Enabling this option can improve driver performance as well.

**Default value:**

- No (disabled)

### CONFIG\_SDM\_ENABLE\_DEBUG\_LOG

Enable debug log

*Found in: Component config > ESP-Driver:Sigma Delta Modulator Configurations*

whether to enable the debug log message for SDM driver. Note that, this option only controls the SDM driver log, won't affect other drivers.

**Default value:**

- No (disabled)

### ESP-Driver:SPI Configurations

 Contains:

- [CONFIG\\_SPI\\_MASTER\\_ISR\\_IN\\_IRAM](#)
- [CONFIG\\_SPI\\_SLAVE\\_ISR\\_IN\\_IRAM](#)
- [CONFIG\\_SPI\\_MASTER\\_IN\\_IRAM](#)
- [CONFIG\\_SPI\\_SLAVE\\_IN\\_IRAM](#)

### CONFIG\_SPI\_MASTER\_IN\_IRAM

Place transmitting functions of SPI master into IRAM

*Found in: Component config > ESP-Driver:SPI Configurations*

Normally only the ISR of SPI master is placed in the IRAM, so that it can work without the flash when interrupt is triggered. For other functions, there's some possibility that the flash cache miss when running inside and out of SPI functions, which may increase the interval of SPI transactions. Enable this to put `queue\_trans`, `get\_trans\_result` and `transmit` functions into the IRAM to avoid possible cache miss.

This configuration won't be available if `CONFIG_FREERTOS_PLACE_FUNCTIONS_INTO_FLASH` is enabled.

During unit test, this is enabled to measure the ideal case of api.

### **CONFIG\_SPI\_MASTER\_ISR\_IN\_IRAM**

Place SPI master ISR function into IRAM

*Found in: Component config > ESP-Driver:SPI Configurations*

Place the SPI master ISR in to IRAM to avoid possible cache miss.

Enabling this configuration is possible only when `HEAP_PLACE_FUNCTION_INTO_FLASH` is disabled since the spi master uses can allocate transactions buffers into DMA memory section using the heap component API that ipso facto has to be placed in IRAM.

Also you can forbid the ISR being disabled during flash writing access, by add `ESP_INTR_FLAG_IRAM` when initializing the driver.

### **CONFIG\_SPI\_SLAVE\_IN\_IRAM**

Place transmitting functions of SPI slave into IRAM

*Found in: Component config > ESP-Driver:SPI Configurations*

Normally only the ISR of SPI slave is placed in the IRAM, so that it can work without the flash when interrupt is triggered. For other functions, there's some possibility that the flash cache miss when running inside and out of SPI functions, which may increase the interval of SPI transactions. Enable this to put `queue\_trans`, `get\_trans\_result` and `transmit` functions into the IRAM to avoid possible cache miss.

**Default value:**

- No (disabled)

### **CONFIG\_SPI\_SLAVE\_ISR\_IN\_IRAM**

Place SPI slave ISR function into IRAM

*Found in: Component config > ESP-Driver:SPI Configurations*

Place the SPI slave ISR in to IRAM to avoid possible cache miss.

Also you can forbid the ISR being disabled during flash writing access, by add `ESP_INTR_FLAG_IRAM` when initializing the driver.

**Default value:**

- Yes (enabled)

**ESP-Driver:Touch Sensor Configurations** Contains:

- [`CONFIG\_TOUCH\_ENABLE\_DEBUG\_LOG`](#)
- [`CONFIG\_TOUCH\_CTRL\_FUNC\_IN\_IRAM`](#)
- [`CONFIG\_TOUCH\_ISR\_IRAM\_SAFE`](#)

### **CONFIG\_TOUCH\_CTRL\_FUNC\_IN\_IRAM**

Place touch sensor control functions into IRAM

*Found in: Component config > ESP-Driver:Touch Sensor Configurations*

Place touch sensor oneshot scanning and continuous scanning functions into IRAM, so that these function can be IRAM-safe and able to be called when the flash cache is disabled. Enabling this option can improve driver performance as well.

**Default value:**

- No (disabled) if SOC\_TOUCH\_SENSOR\_SUPPORTED

**CONFIG\_TOUCH\_ISR\_IRAM\_SAFE**

Touch sensor ISR IRAM-Safe

*Found in: [Component config](#) > [ESP-Driver:Touch Sensor Configurations](#)*

Ensure the touch sensor interrupt is IRAM-Safe by allowing the interrupt handler to be executable when the cache is disabled (e.g. SPI Flash write).

**Default value:**

- No (disabled) if SOC\_TOUCH\_SENSOR\_SUPPORTED

**CONFIG\_TOUCH\_ENABLE\_DEBUG\_LOG**

Enable debug log

*Found in: [Component config](#) > [ESP-Driver:Touch Sensor Configurations](#)*

Whether to enable the debug log message for touch driver. Note that, this option only controls the touch driver log, won't affect other drivers.

**Default value:**

- No (disabled) if SOC\_TOUCH\_SENSOR\_SUPPORTED

**ESP-Driver:Temperature Sensor Configurations** Contains:

- [CONFIG\\_TEMP\\_SENSOR\\_ENABLE\\_DEBUG\\_LOG](#)
- [CONFIG\\_TEMP\\_SENSOR\\_ISR\\_IRAM\\_SAFE](#)

**CONFIG\_TEMP\_SENSOR\_ENABLE\_DEBUG\_LOG**

Enable debug log

*Found in: [Component config](#) > [ESP-Driver:Temperature Sensor Configurations](#)*

whether to enable the debug log message for temperature sensor driver. Note that, this option only controls the temperature sensor driver log, won't affect other drivers.

**Default value:**

- No (disabled)

**CONFIG\_TEMP\_SENSOR\_ISR\_IRAM\_SAFE**

Temperature sensor ISR IRAM-Safe

*Found in: [Component config](#) > [ESP-Driver:Temperature Sensor Configurations](#)*

Ensure the Temperature Sensor interrupt is IRAM-Safe by allowing the interrupt handler to be executable when the cache is disabled (e.g. SPI Flash write).

**Default value:**

- No (disabled)

**ESP-Driver:UART Configurations** Contains:

- [CONFIG\\_UART\\_ISR\\_IN\\_IRAM](#)

### CONFIG\_UART\_ISR\_IN\_IRAM

Place UART ISR function into IRAM

*Found in: [Component config](#) > [ESP-Driver:UART Configurations](#)*

If this option is not selected, UART interrupt will be disabled for a long time and may cause data lost when doing spi flash operation.

### ESP-Driver:USB Serial/JTAG Configuration

 Contains:

- [CONFIG\\_USJ\\_ENABLE\\_USB\\_SERIAL\\_JTAG](#)

### CONFIG\_USJ\_ENABLE\_USB\_SERIAL\_JTAG

Enable USB-Serial-JTAG Module

*Found in: [Component config](#) > [ESP-Driver:USB Serial/JTAG Configuration](#)*

The USB-Serial-JTAG module on ESP chips is turned on by default after power-on. If your application does not need it and not rely on it to be used as system console or use the built-in JTAG for debugging, you can disable this option, then the clock of this module will be disabled at startup, which will save some power consumption.

#### Default value:

- Yes (enabled)

### CONFIG\_USJ\_NO\_AUTO\_LS\_ON\_CONNECTION

Don't enter the automatic light sleep when USB Serial/JTAG port is connected

*Found in: [Component config](#) > [ESP-Driver:USB Serial/JTAG Configuration](#) > [CONFIG\\_USJ\\_ENABLE\\_USB\\_SERIAL\\_JTAG](#)*

If enabled, the chip will constantly monitor the connection status of the USB Serial/JTAG port. As long as the USB Serial/JTAG is connected, a ESP\_PM\_NO\_LIGHT\_SLEEP power management lock will be acquired to prevent the system from entering light sleep. This option can be useful if serial monitoring is needed via USB Serial/JTAG while power management is enabled, as the USB Serial/JTAG cannot work under light sleep and after waking up from light sleep. Note. This option can only control the automatic Light-Sleep behavior. If `esp_light_sleep_start()` is called manually from the program, enabling this option will not prevent light sleep entry even if the USB Serial/JTAG is in use.

### Ethernet

 Contains:

- [CONFIG\\_ETH\\_TRANSMIT\\_MUTEX](#)
- [CONFIG\\_ETH\\_USE\\_ESP32\\_EMAC](#)
- [CONFIG\\_ETH\\_USE\\_OPENETH](#)
- [CONFIG\\_ETH\\_USE\\_SPI\\_ETHERNET](#)

### CONFIG\_ETH\_USE\_ESP32\_EMAC

Support ESP32 internal EMAC controller

*Found in: [Component config](#) > [Ethernet](#)*

ESP32 integrates a 10/100M Ethernet MAC controller.

#### Default value:

- Yes (enabled) if SOC\_EMAC\_SUPPORTED

Contains:

- [CONFIG\\_ETH\\_DMA\\_RX\\_BUFFER\\_NUM](#)
- [CONFIG\\_ETH\\_DMA\\_TX\\_BUFFER\\_NUM](#)



- [CONFIG\\_ETH\\_IRAM\\_OPTIMIZATION](#)
- [CONFIG\\_ETH\\_SOFT\\_FLOW\\_CONTROL](#)
- [CONFIG\\_ETH\\_DMA\\_BUFFER\\_SIZE](#)
- [CONFIG\\_ETH\\_PHY\\_INTERFACE](#)

### CONFIG\_ETH\_PHY\_INTERFACE

PHY interface

*Found in:* [Component config](#) > [Ethernet](#) > [CONFIG\\_ETH\\_USE\\_ESP32\\_EMAC](#)

Select the communication interface between MAC and PHY chip.

Available options:

- Reduced Media Independent Interface (RMII) ([CONFIG\\_ETH\\_PHY\\_INTERFACE\\_RMII](#))

### CONFIG\_ETH\_DMA\_BUFFER\_SIZE

Ethernet DMA buffer size (Byte)

*Found in:* [Component config](#) > [Ethernet](#) > [CONFIG\\_ETH\\_USE\\_ESP32\\_EMAC](#)

Set the size of each buffer used by Ethernet MAC DMA. !! Important !! Make sure it is 64B aligned for ESP32P4!

**Range:**

- from 256 to 1600 if [CONFIG\\_ETH\\_USE\\_ESP32\\_EMAC](#)

**Default value:**

- 512 if [CONFIG\\_ETH\\_USE\\_ESP32\\_EMAC](#)

### CONFIG\_ETH\_DMA\_RX\_BUFFER\_NUM

Amount of Ethernet DMA Rx buffers

*Found in:* [Component config](#) > [Ethernet](#) > [CONFIG\\_ETH\\_USE\\_ESP32\\_EMAC](#)

Number of DMA receive buffers. Each buffer's size is [ETH\\_DMA\\_BUFFER\\_SIZE](#). Larger number of buffers could increase throughput somehow.

**Range:**

- from 3 to 30 if [CONFIG\\_ETH\\_USE\\_ESP32\\_EMAC](#)

### CONFIG\_ETH\_DMA\_TX\_BUFFER\_NUM

Amount of Ethernet DMA Tx buffers

*Found in:* [Component config](#) > [Ethernet](#) > [CONFIG\\_ETH\\_USE\\_ESP32\\_EMAC](#)

Number of DMA transmit buffers. Each buffer's size is [ETH\\_DMA\\_BUFFER\\_SIZE](#). Larger number of buffers could increase throughput somehow.

**Range:**

- from 3 to 30 if [CONFIG\\_ETH\\_USE\\_ESP32\\_EMAC](#)

**Default value:**

- 10 if [CONFIG\\_ETH\\_USE\\_ESP32\\_EMAC](#)

## CONFIG\_ETH\_SOFT\_FLOW\_CONTROL

Enable software flow control

*Found in: Component config > Ethernet > CONFIG\_ETH\_USE\_ESP32\_EMAC*

Ethernet MAC engine on ESP32 doesn't feature a flow control logic. The MAC driver can perform a software flow control if you enable this option. Note that, if the RX buffer number is small, enabling software flow control will cause obvious performance loss.

**Default value:**

- No (disabled) if `CONFIG_ETH_DMA_RX_BUFFER_NUM > 15` && `CONFIG_ETH_USE_ESP32_EMAC`

## CONFIG\_ETH\_IRAM\_OPTIMIZATION

Enable IRAM optimization

*Found in: Component config > Ethernet > CONFIG\_ETH\_USE\_ESP32\_EMAC*

If enabled, functions related to RX/TX are placed into IRAM. It can improve Ethernet throughput. If disabled, all functions are placed into FLASH.

**Default value:**

- No (disabled) if `CONFIG_ETH_USE_ESP32_EMAC`

## CONFIG\_ETH\_USE\_SPI\_ETHERNET

Support SPI to Ethernet Module

*Found in: Component config > Ethernet*

ESP-IDF can also support some SPI-Ethernet modules.

**Default value:**

- Yes (enabled)

Contains:

- `CONFIG_ETH_SPI_ETHERNET_DM9051`
- `CONFIG_ETH_SPI_ETHERNET_KSZ8851SNL`
- `CONFIG_ETH_SPI_ETHERNET_W5500`

## CONFIG\_ETH\_SPI\_ETHERNET\_DM9051

Use DM9051

*Found in: Component config > Ethernet > CONFIG\_ETH\_USE\_SPI\_ETHERNET*

DM9051 is a fast Ethernet controller with an SPI interface. It's also integrated with a 10/100M PHY and MAC. Select this to enable DM9051 driver.

## CONFIG\_ETH\_SPI\_ETHERNET\_W5500

Use W5500 (MAC RAW)

*Found in: Component config > Ethernet > CONFIG\_ETH\_USE\_SPI\_ETHERNET*

W5500 is a HW TCP/IP embedded Ethernet controller. TCP/IP stack, 10/100 Ethernet MAC and PHY are embedded in a single chip. However the driver in ESP-IDF only enables the RAW MAC mode, making it compatible with the software TCP/IP stack. Say yes to enable W5500 driver.

### CONFIG\_ETH\_SPI\_ETHERNET\_KSZ8851SNL

Use KSZ8851SNL

*Found in: Component config > Ethernet > CONFIG\_ETH\_USE\_SPI\_ETHERNET*

The KSZ8851SNL is a single-chip Fast Ethernet controller consisting of a 10/100 physical layer transceiver (PHY), a MAC, and a Serial Peripheral Interface (SPI). Select this to enable KSZ8851SNL driver.

### CONFIG\_ETH\_USE\_OPENETH

Support OpenCores Ethernet MAC (for use with QEMU)

*Found in: Component config > Ethernet*

OpenCores Ethernet MAC driver can be used when an ESP-IDF application is executed in QEMU. This driver is not supported when running on a real chip.

**Default value:**

- No (disabled)

Contains:

- [CONFIG\\_ETH\\_OPENETH\\_DMA\\_RX\\_BUFFER\\_NUM](#)
- [CONFIG\\_ETH\\_OPENETH\\_DMA\\_TX\\_BUFFER\\_NUM](#)

### CONFIG\_ETH\_OPENETH\_DMA\_RX\_BUFFER\_NUM

Number of Ethernet DMA Rx buffers

*Found in: Component config > Ethernet > CONFIG\_ETH\_USE\_OPENETH*

Number of DMA receive buffers, each buffer is 1600 bytes.

**Range:**

- from 1 to 64 if [CONFIG\\_ETH\\_USE\\_OPENETH](#)

**Default value:**

- 4 if [CONFIG\\_ETH\\_USE\\_OPENETH](#)

### CONFIG\_ETH\_OPENETH\_DMA\_TX\_BUFFER\_NUM

Number of Ethernet DMA Tx buffers

*Found in: Component config > Ethernet > CONFIG\_ETH\_USE\_OPENETH*

Number of DMA transmit buffers, each buffer is 1600 bytes.

**Range:**

- from 1 to 64 if [CONFIG\\_ETH\\_USE\\_OPENETH](#)

**Default value:**

- 1 if [CONFIG\\_ETH\\_USE\\_OPENETH](#)

### CONFIG\_ETH\_TRANSMIT\_MUTEX

Enable Transmit Mutex

*Found in: Component config > Ethernet*

Prevents multiple accesses when Ethernet interface is used as shared resource and multiple functionalities might try to access it at a time.

**Default value:**

- No (disabled)

**Event Loop Library** Contains:

- [CONFIG\\_ESP\\_EVENT\\_LOOP\\_PROFILING](#)
- [CONFIG\\_ESP\\_EVENT\\_POST\\_FROM\\_ISR](#)

### **CONFIG\_ESP\_EVENT\_LOOP\_PROFILING**

Enable event loop profiling

*Found in: [Component config](#) > [Event Loop Library](#)*

Enables collections of statistics in the event loop library such as the number of events posted to/received by an event loop, number of callbacks involved, number of events dropped to a full event loop queue, run time of event handlers, and number of times/run time of each event handler.

**Default value:**

- No (disabled)

### **CONFIG\_ESP\_EVENT\_POST\_FROM\_ISR**

Support posting events from ISRs

*Found in: [Component config](#) > [Event Loop Library](#)*

Enable posting events from interrupt handlers.

**Default value:**

- Yes (enabled)

### **CONFIG\_ESP\_EVENT\_POST\_FROM\_IRAM\_ISR**

Support posting events from ISRs placed in IRAM

*Found in: [Component config](#) > [Event Loop Library](#) > [CONFIG\\_ESP\\_EVENT\\_POST\\_FROM\\_ISR](#)*

Enable posting events from interrupt handlers placed in IRAM. Enabling this option places API functions `esp_event_post` and `esp_event_post_to` in IRAM.

**Default value:**

- Yes (enabled)

**GDB Stub** Contains:

- [CONFIG\\_ESP\\_GDBSTUB\\_SUPPORT\\_TASKS](#)
- [CONFIG\\_ESP\\_SYSTEM\\_GDBSTUB\\_RUNTIME](#)

### **CONFIG\_ESP\_SYSTEM\_GDBSTUB\_RUNTIME**

GDBStub at runtime

*Found in: [Component config](#) > [GDB Stub](#)*

Enable builtin GDBStub. This allows to debug the target device using serial port: - Run 'idf.py monitor'. - Wait for the device to initialize. - Press Ctrl+C to interrupt the execution and enter GDB attached to your device for debugging. NOTE: all UART input will be handled by GDBStub.

### **CONFIG\_ESP\_GDBSTUB\_SUPPORT\_TASKS**

Enable listing FreeRTOS tasks through GDB Stub

*Found in: [Component config](#) > [GDB Stub](#)*

If enabled, GDBStub can supply the list of FreeRTOS tasks to GDB. Thread list can be queried from GDB using 'info threads' command. Note that if GDB task lists were corrupted, this feature may not work. If GDBStub fails, try disabling this feature.

**Default value:**

- Yes (enabled)

**CONFIG\_ESP\_GDBSTUB\_MAX\_TASKS**

Maximum number of tasks supported by GDB Stub

*Found in: Component config > GDB Stub > CONFIG\_ESP\_GDBSTUB\_SUPPORT\_TASKS*

Set the number of tasks which GDB Stub will support.

**Default value:**

- 32

**ESP HTTP client** Contains:

- [CONFIG\\_ESP\\_HTTP\\_CLIENT\\_ENABLE\\_CUSTOM\\_TRANSPORT](#)
- [CONFIG\\_ESP\\_HTTP\\_CLIENT\\_ENABLE\\_BASIC\\_AUTH](#)
- [CONFIG\\_ESP\\_HTTP\\_CLIENT\\_ENABLE\\_DIGEST\\_AUTH](#)
- [CONFIG\\_ESP\\_HTTP\\_CLIENT\\_ENABLE\\_HTTPS](#)

**CONFIG\_ESP\_HTTP\_CLIENT\_ENABLE\_HTTPS**

Enable https

*Found in: Component config > ESP HTTP client*

This option will enable https protocol by linking esp-tls library and initializing SSL transport

**Default value:**

- Yes (enabled)

**CONFIG\_ESP\_HTTP\_CLIENT\_ENABLE\_BASIC\_AUTH**

Enable HTTP Basic Authentication

*Found in: Component config > ESP HTTP client*

This option will enable HTTP Basic Authentication. It is disabled by default as Basic auth uses unencrypted encoding, so it introduces a vulnerability when not using TLS

**Default value:**

- No (disabled)

**CONFIG\_ESP\_HTTP\_CLIENT\_ENABLE\_DIGEST\_AUTH**

Enable HTTP Digest Authentication

*Found in: Component config > ESP HTTP client*

This option will enable HTTP Digest Authentication. It is enabled by default, but use of this configuration is not recommended as the password can be derived from the exchange, so it introduces a vulnerability when not using TLS

**Default value:**

- No (disabled)

## CONFIG\_ESP\_HTTP\_CLIENT\_ENABLE\_CUSTOM\_TRANSPORT

Enable custom transport

*Found in: [Component config](#) > [ESP HTTP client](#)*

This option will enable injection of a custom tcp\_transport handle, so the http operation will be performed on top of the user defined transport abstraction (if configured)

**Default value:**

- No (disabled)

## HTTP Server Contains:

- [CONFIG\\_HTTPD\\_QUEUE\\_WORK\\_BLOCKING](#)
- [CONFIG\\_HTTPD\\_PURGE\\_BUF\\_LEN](#)
- [CONFIG\\_HTTPD\\_LOG\\_PURGE\\_DATA](#)
- [CONFIG\\_HTTPD\\_MAX\\_REQ\\_HDR\\_LEN](#)
- [CONFIG\\_HTTPD\\_MAX\\_URI\\_LEN](#)
- [CONFIG\\_HTTPD\\_ERR\\_RESP\\_NO\\_DELAY](#)
- [CONFIG\\_HTTPD\\_WS\\_SUPPORT](#)

## CONFIG\_HTTPD\_MAX\_REQ\_HDR\_LEN

Max HTTP Request Header Length

*Found in: [Component config](#) > [HTTP Server](#)*

This sets the maximum supported size of headers section in HTTP request packet to be processed by the server

**Default value:**

- 512

## CONFIG\_HTTPD\_MAX\_URI\_LEN

Max HTTP URI Length

*Found in: [Component config](#) > [HTTP Server](#)*

This sets the maximum supported size of HTTP request URI to be processed by the server

**Default value:**

- 512

## CONFIG\_HTTPD\_ERR\_RESP\_NO\_DELAY

Use TCP\_NODELAY socket option when sending HTTP error responses

*Found in: [Component config](#) > [HTTP Server](#)*

Using TCP\_NODELAY socket option ensures that HTTP error response reaches the client before the underlying socket is closed. Please note that turning this off may cause multiple test failures

**Default value:**

- Yes (enabled)

## CONFIG\_HTTPD\_PURGE\_BUF\_LEN

Length of temporary buffer for purging data

*Found in: [Component config](#) > [HTTP Server](#)*

This sets the size of the temporary buffer used to receive and discard any remaining data that is received from the HTTP client in the request, but not processed as part of the server HTTP request handler.

If the remaining data is larger than the available buffer size, the buffer will be filled in multiple iterations. The buffer should be small enough to fit on the stack, but large enough to avoid excessive iterations.

**Default value:**

- 32

**CONFIG\_HTTPD\_LOG\_PURGE\_DATA**

Log purged content data at Debug level

*Found in: [Component config](#) > [HTTP Server](#)*

Enabling this will log discarded binary HTTP request data at Debug level. For large content data this may not be desirable as it will clutter the log.

**Default value:**

- No (disabled)

**CONFIG\_HTTPD\_WS\_SUPPORT**

WebSocket server support

*Found in: [Component config](#) > [HTTP Server](#)*

This sets the WebSocket server support.

**Default value:**

- No (disabled)

**CONFIG\_HTTPD\_QUEUE\_WORK\_BLOCKING**

httpd\_queue\_work as blocking API

*Found in: [Component config](#) > [HTTP Server](#)*

This makes httpd\_queue\_work() API to wait until a message space is available on UDP control socket. It internally uses a counting semaphore with count set to `LWIP_UDP_RECVMBOX_SIZE` to achieve this. This config will slightly change API behavior to block until message gets delivered on control socket.

**ESP HTTPS OTA** Contains:

- [CONFIG\\_ESP\\_HTTPS\\_OTA\\_ALLOW\\_HTTP](#)
- [CONFIG\\_ESP\\_HTTPS\\_OTA\\_DECRYPT\\_CB](#)

**CONFIG\_ESP\_HTTPS\_OTA\_DECRYPT\_CB**

Provide decryption callback

*Found in: [Component config](#) > [ESP HTTPS OTA](#)*

Exposes an additional callback whereby firmware data could be decrypted before being processed by OTA update component. This can help to integrate external encryption related format and removal of such encapsulation layer from firmware image.

**Default value:**

- No (disabled)

## CONFIG\_ESP\_HTTPS\_OTA\_ALLOW\_HTTP

Allow HTTP for OTA (WARNING: ONLY FOR TESTING PURPOSE, READ HELP)

Found in: *Component config > ESP HTTPS OTA*

It is highly recommended to keep HTTPS (along with server certificate validation) enabled. Enabling this option comes with potential risk of: - Non-encrypted communication channel with server - Accepting firmware upgrade image from server with fake identity

### Default value:

- No (disabled)

## ESP HTTPS server Contains:

- *CONFIG\_ESP\_HTTPS\_SERVER\_ENABLE*

## CONFIG\_ESP\_HTTPS\_SERVER\_ENABLE

Enable ESP\_HTTPS\_SERVER component

Found in: *Component config > ESP HTTPS server*

Enable ESP HTTPS server component

## Hardware Settings Contains:

- *2D-DMA Configurations*
- *Chip revision*
- *Crypto DPA Protection*
- *DW\_GDMA Configurations*
- *ETM Configuration*
- *GDMA Configurations*
- *MAC Config*
- *Main XTAL Config*
- *Peripheral Control*
- *RTC Clock Config*
- *Sleep Config*

## Chip revision Contains:

- *CONFIG\_ESP\_REV\_NEW\_CHIP\_TEST*
- *CONFIG\_ESP32H2\_REV\_MIN*

## CONFIG\_ESP32H2\_REV\_MIN

Minimum Supported ESP32-H2 Revision

Found in: *Component config > Hardware Settings > Chip revision*

Required minimum chip revision. ESP-IDF will check for it and reject to boot if the chip revision fails the check. This ensures the chip used will have some modifications (features, or bugfixes).

The compiled binary will only support chips above this revision, this will also help to reduce binary size.

Available options:

- Rev v0.0 (CONFIG\_ESP32H2\_REV\_MIN\_0)
- Rev v0.1 (ECO1) (CONFIG\_ESP32H2\_REV\_MIN\_1)
- Rev v0.2 (ECO2) (CONFIG\_ESP32H2\_REV\_MIN\_2)



## CONFIG\_ESP\_REV\_NEW\_CHIP\_TEST

Internal test mode

*Found in: Component config > Hardware Settings > Chip revision*

For internal chip testing, a small number of new versions chips didn't update the version field in eFuse, you can enable this option to force the software recognize the chip version based on the rev selected in menuconfig.

**Default value:**

- No (disabled)

## MAC Config Contains:

- [CONFIG\\_ESP\\_MAC\\_USE\\_CUSTOM\\_MAC\\_AS\\_BASE\\_MAC](#)
- [CONFIG\\_ESP32H2\\_UNIVERSAL\\_MAC\\_ADDRESSES](#)

## CONFIG\_ESP32H2\_UNIVERSAL\_MAC\_ADDRESSES

Number of universally administered (by IEEE) MAC address

*Found in: Component config > Hardware Settings > MAC Config*

Configure the number of universally administered (by IEEE) MAC addresses. During initialization, MAC addresses for each network interface are generated or derived from a single base MAC address.

Available options:

- Two (CONFIG\_ESP32H2\_UNIVERSAL\_MAC\_ADDRESSES\_TWO)

## CONFIG\_ESP\_MAC\_USE\_CUSTOM\_MAC\_AS\_BASE\_MAC

Enable using custom mac as base mac

*Found in: Component config > Hardware Settings > MAC Config*

When this configuration is enabled, the user can invoke `esp_read_mac` to obtain the desired type of MAC using a custom MAC as the base MAC.

**Default value:**

- No (disabled)

## Sleep Config Contains:

- [CONFIG\\_ESP\\_SLEEP\\_GPIO\\_ENABLE\\_INTERNAL\\_RESISTORS](#)
- [CONFIG\\_ESP\\_SLEEP\\_CACHE\\_SAFE\\_ASSERTION](#)
- [CONFIG\\_ESP\\_SLEEP\\_EVENT\\_CALLBACKS](#)
- [CONFIG\\_ESP\\_SLEEP\\_DEBUG](#)
- [CONFIG\\_ESP\\_SLEEP\\_WAIT\\_FLASH\\_READY\\_EXTRA\\_DELAY](#)
- [CONFIG\\_ESP\\_SLEEP\\_GPIO\\_RESET\\_WORKAROUND](#)
- [CONFIG\\_ESP\\_SLEEP\\_POWER\\_DOWN\\_FLASH](#)
- [CONFIG\\_ESP\\_SLEEP\\_MSPI\\_NEED\\_ALL\\_IO\\_PU](#)
- [CONFIG\\_ESP\\_SLEEP\\_FLASH\\_LEAKAGE\\_WORKAROUND](#)
- [CONFIG\\_ESP\\_SLEEP\\_PSRAM\\_LEAKAGE\\_WORKAROUND](#)

### CONFIG\_ESP\_SLEEP\_POWER\_DOWN\_FLASH

Power down flash in light sleep when there is no SPIRAM

*Found in: [Component config](#) > [Hardware Settings](#) > [Sleep Config](#)*

If enabled, chip will try to power down flash as part of `esp_light_sleep_start()`, which costs more time when chip wakes up. Can only be enabled if there is no SPIRAM configured.

This option will power down flash under a strict but relatively safe condition. Also, it is possible to power down flash under a relaxed condition by using `esp_sleep_pd_config()` to set `ESP_PD_DOMAIN_VDDSDIO` to `ESP_PD_OPTION_OFF`. It should be noted that there is a risk in powering down flash, you can refer *ESP-IDF Programming Guide/API Reference/System API/Sleep Modes/Power-down of Flash* for more details.

### CONFIG\_ESP\_SLEEP\_FLASH\_LEAKAGE\_WORKAROUND

Pull-up Flash CS pin in light sleep

*Found in: [Component config](#) > [Hardware Settings](#) > [Sleep Config](#)*

All IOs will be set to isolate(floating) state by default during sleep. Since the power supply of SPI Flash is not lost during lightsleep, if its CS pin is recognized as low level(selected state) in the floating state, there will be a large current leakage, and the data in Flash may be corrupted by random signals on other SPI pins. Select this option will set the CS pin of Flash to PULL-UP state during sleep, but this will increase the sleep current about 10 uA. If you are developing with esp32xx modules, you must select this option, but if you are developing with chips, you can also pull up the CS pin of SPI Flash in the external circuit to save power consumption caused by internal pull-up during sleep. (!!! Don't deselect this option if you don't have external SPI Flash CS pin pullups.)

### CONFIG\_ESP\_SLEEP\_PSRAM\_LEAKAGE\_WORKAROUND

Pull-up PSRAM CS pin in light sleep

*Found in: [Component config](#) > [Hardware Settings](#) > [Sleep Config](#)*

All IOs will be set to isolate(floating) state by default during sleep. Since the power supply of PSRAM is not lost during lightsleep, if its CS pin is recognized as low level(selected state) in the floating state, there will be a large current leakage, and the data in PSRAM may be corrupted by random signals on other SPI pins. Select this option will set the CS pin of PSRAM to PULL-UP state during sleep, but this will increase the sleep current about 10 uA. If you are developing with esp32xx modules, you must select this option, but if you are developing with chips, you can also pull up the CS pin of PSRAM in the external circuit to save power consumption caused by internal pull-up during sleep. (!!! Don't deselect this option if you don't have external PSRAM CS pin pullups.)

**Default value:**

- Yes (enabled) if SPIRAM

### CONFIG\_ESP\_SLEEP\_MSPI\_NEED\_ALL\_IO\_PU

Pull-up all SPI pins in light sleep

*Found in: [Component config](#) > [Hardware Settings](#) > [Sleep Config](#)*

To reduce leakage current, some types of SPI Flash/RAM only need to pull up the CS pin during light sleep. But there are also some kinds of SPI Flash/RAM that need to pull up all pins. It depends on the SPI Flash/RAM chip used.

### CONFIG\_ESP\_SLEEP\_GPIO\_RESET\_WORKAROUND

light sleep GPIO reset workaround

*Found in: [Component config](#) > [Hardware Settings](#) > [Sleep Config](#)*

esp32c2, esp32c3, esp32s3, esp32c6 and esp32h2 will reset at wake-up if GPIO is received a small electrostatic pulse during light sleep, with specific condition

- GPIO needs to be configured as input-mode only
- The pin receives a small electrostatic pulse, and reset occurs when the pulse voltage is higher than 6 V

For GPIO set to input mode only, it is not a good practice to leave it open/floating, The hardware design needs to controlled it with determined supply or ground voltage is necessary.

This option provides a software workaround for this issue. Configure to isolate all GPIO pins in sleep state.

**Default value:**

- Yes (enabled)

### **CONFIG\_ESP\_SLEEP\_WAIT\_FLASH\_READY\_EXTRA\_DELAY**

Extra delay (in us) after flash powerdown sleep wakeup to wait flash ready

*Found in: [Component config](#) > [Hardware Settings](#) > [Sleep Config](#)*

When the chip exits sleep, the CPU and the flash chip are powered on at the same time. CPU will run rom code (deepsleep) or ram code (lightsleep) first, and then load or execute code from flash.

Some flash chips need sufficient time to pass between power on and first read operation. By default, without any extra delay, this time is approximately 900us, although some flash chip types need more than that.

(!!! Please adjust this value according to the Data Sheet of SPI Flash used in your project.) In Flash Data Sheet, the parameters that define the Flash ready timing after power-up (minimum time from Vcc(min) to CS active) usually named tVSL in ELECTRICAL CHARACTERISTICS chapter, and the configuration value here should be: ESP\_SLEEP\_WAIT\_FLASH\_READY\_EXTRA\_DELAY = tVSL - 900

For esp32 and esp32s3, the default extra delay is set to 2000us. When optimizing startup time for applications which require it, this value may be reduced.

If you are seeing "flash read err, 1000" message printed to the console after deep sleep reset on esp32, or triggered RTC\_WDT/LP\_WDT after lightsleep wakeup, try increasing this value. (For esp32, the delay will be executed in both deep sleep and light sleep wake up flow. For chips after esp32, the delay will be executed only in light sleep flow, the delay controlled by the EFUSE\_FLASH\_TPUW in ROM will be executed in deepsleep wake up flow.)

**Range:**

- from 0 to 5000

**Default value:**

- 0

### **CONFIG\_ESP\_SLEEP\_CACHE\_SAFE\_ASSERTION**

Check the cache safety of the sleep wakeup code in sleep process

*Found in: [Component config](#) > [Hardware Settings](#) > [Sleep Config](#)*

Enabling it will check the cache safety of the code before the flash power is ready after light sleep wakeup, and check PM\_SLP\_IRAM\_OPT related code cache safety. This option is only for code quality inspection. Enabling it will increase the time overhead of entering and exiting sleep. It is not recommended to enable it in the release version.

**Default value:**

- No (disabled)

### CONFIG\_ESP\_SLEEP\_DEBUG

esp sleep debug

*Found in: [Component config](#) > [Hardware Settings](#) > [Sleep Config](#)*

Enable esp sleep debug.

**Default value:**

- No (disabled)

### CONFIG\_ESP\_SLEEP\_GPIO\_ENABLE\_INTERNAL\_RESISTORS

Allow to enable internal pull-up/downs for the Deep-Sleep wakeup IOs

*Found in: [Component config](#) > [Hardware Settings](#) > [Sleep Config](#)*

When using rtc gpio wakeup source during deepsleep without external pull-up/downs, you may want to make use of the internal ones.

**Default value:**

- Yes (enabled)

### CONFIG\_ESP\_SLEEP\_EVENT\_CALLBACKS

Enable registration of sleep event callbacks

*Found in: [Component config](#) > [Hardware Settings](#) > [Sleep Config](#)*

If enabled, it allows user to register sleep event callbacks. It is primarily designed for internal developers and customers can use PM\_LIGHT\_SLEEP\_CALLBACKS as an alternative.

NOTE: These callbacks are executed from the IDLE task context hence you cannot have any blocking calls in your callbacks.

NOTE: Enabling these callbacks may change sleep duration calculations based on time spent in callback and hence it is highly recommended to keep them as short as possible.

**Default value:**

- No (disabled) if [CONFIG\\_FREERTOS\\_USE\\_TICKLESS\\_IDLE](#)

**RTC Clock Config** Contains:

- [CONFIG\\_RTC\\_CLK\\_CAL\\_CYCLES](#)
- [CONFIG\\_RTC\\_CLK\\_SRC](#)

### CONFIG\_RTC\_CLK\_SRC

RTC clock source

*Found in: [Component config](#) > [Hardware Settings](#) > [RTC Clock Config](#)*

Choose which clock is used as RTC clock source.

Available options:

- Internal 150 kHz RC oscillator ([CONFIG\\_RTC\\_CLK\\_SRC\\_INT\\_RC](#))
- External 32kHz crystal ([CONFIG\\_RTC\\_CLK\\_SRC\\_EXT\\_CRYS](#))
- External 32kHz oscillator at 32K\_XP pin ([CONFIG\\_RTC\\_CLK\\_SRC\\_EXT\\_OSC](#))
- Internal 32kHz RC oscillator ([CONFIG\\_RTC\\_CLK\\_SRC\\_INT\\_RC32K](#))

## CONFIG\_RTC\_CLK\_CAL\_CYCLES

Number of cycles for RTC\_SLOW\_CLK calibration

*Found in: [Component config](#) > [Hardware Settings](#) > [RTC Clock Config](#)*

When the startup code initializes RTC\_SLOW\_CLK, it can perform calibration by comparing the RTC\_SLOW\_CLK frequency with main XTAL frequency. This option sets the number of RTC\_SLOW\_CLK cycles measured by the calibration routine. Higher numbers increase calibration precision, which may be important for applications which spend a lot of time in deep sleep. Lower numbers reduce startup time.

When this option is set to 0, clock calibration will not be performed at startup, and approximate clock frequencies will be assumed:

- 136000 Hz if internal RC oscillator is used as clock source. For this use value 1024.
- **32768 Hz if the 32k crystal oscillator is used. For this use value 3000 or more.** In case more value will help improve the definition of the launch of the crystal. If the crystal could not start, it will be switched to internal RC.

**Range:**

- from 0 to 8190 if `CONFIG_RTC_CLK_SRC_EXT_CRY` || `CONFIG_RTC_CLK_SRC_EXT_OSC` || `CONFIG_RTC_CLK_SRC_INT_RC32K`
- from 0 to 32766

**Default value:**

- 3000 if `CONFIG_RTC_CLK_SRC_EXT_CRY` || `CONFIG_RTC_CLK_SRC_EXT_OSC` || `CONFIG_RTC_CLK_SRC_INT_RC32K`
- 1024

**Peripheral Control** Contains:

- [CONFIG\\_PERIPH\\_CTRL\\_FUNC\\_IN\\_IRAM](#)

## CONFIG\_PERIPH\_CTRL\_FUNC\_IN\_IRAM

Place peripheral control functions into IRAM

*Found in: [Component config](#) > [Hardware Settings](#) > [Peripheral Control](#)*

Place peripheral control functions (e.g. `periph_module_reset`) into IRAM, so that these functions can be IRAM-safe and able to be called in the other IRAM interrupt context.

**Default value:**

- No (disabled)

**ETM Configuration** Contains:

- [CONFIG\\_ETM\\_ENABLE\\_DEBUG\\_LOG](#)

## CONFIG\_ETM\_ENABLE\_DEBUG\_LOG

Enable debug log

*Found in: [Component config](#) > [Hardware Settings](#) > [ETM Configuration](#)*

whether to enable the debug log message for ETM core driver. Note that, this option only controls the ETM related driver log, won't affect other drivers.

**Default value:**

- No (disabled)

**GDMA Configurations** Contains:

- [CONFIG\\_GDMA\\_ENABLE\\_DEBUG\\_LOG](#)
- [CONFIG\\_GDMA\\_ISR\\_IRAM\\_SAFE](#)
- [CONFIG\\_GDMA\\_CTRL\\_FUNC\\_IN\\_IRAM](#)

**CONFIG\_GDMA\_CTRL\_FUNC\_IN\_IRAM**

Place GDMA control functions in IRAM

*Found in: Component config > Hardware Settings > GDMA Configurations*

Place GDMA control functions (like start/stop/append/reset) into IRAM, so that these functions can be IRAM-safe and able to be called in the other IRAM interrupt context.

**Default value:**

- No (disabled)

**CONFIG\_GDMA\_ISR\_IRAM\_SAFE**

GDMA ISR IRAM-Safe

*Found in: Component config > Hardware Settings > GDMA Configurations*

This will ensure the GDMA interrupt handler is IRAM-Safe, allow to avoid flash cache misses, and also be able to run whilst the cache is disabled. (e.g. SPI Flash write).

**Default value:**

- No (disabled)

**CONFIG\_GDMA\_ENABLE\_DEBUG\_LOG**

Enable debug log

*Found in: Component config > Hardware Settings > GDMA Configurations*

Whether to enable the debug log message for GDMA driver. Note that, this option only controls the GDMA driver log, won't affect other drivers.

**Default value:**

- No (disabled)

**DW\_GDMA Configurations** Contains:

- [CONFIG\\_DW\\_GDMA\\_ENABLE\\_DEBUG\\_LOG](#)

**CONFIG\_DW\_GDMA\_ENABLE\_DEBUG\_LOG**

Enable debug log

*Found in: Component config > Hardware Settings > DW\_GDMA Configurations*

Whether to enable the debug log message for DW\_GDMA driver. Note that, this option only controls the DW\_GDMA driver log, won't affect other drivers.

**Default value:**

- No (disabled) if SOC\_DW\_GDMA\_SUPPORTED

**2D-DMA Configurations** Contains:

- [CONFIG\\_DMA2D\\_ISR\\_IRAM\\_SAFE](#)
- [CONFIG\\_DMA2D\\_OPERATION\\_FUNC\\_IN\\_IRAM](#)

## CONFIG\_DMA2D\_OPERATION\_FUNC\_IN\_IRAM

Place 2D-DMA operation functions into IRAM

*Found in: [Component config](#) > [Hardware Settings](#) > [2D-DMA Configurations](#)*

Place 2D-DMA all operation functions, including control functions (e.g. start/stop/append/reset) and setter functions (e.g. connect/strategy/callback registration) into IRAM, so that these functions can be IRAM-safe and able to be called in the other IRAM interrupt context. It also helps optimizing the performance.

**Default value:**

- No (disabled) if SOC\_DMA2D\_SUPPORTED

## CONFIG\_DMA2D\_ISR\_IRAM\_SAFE

2D-DMA ISR IRAM-Safe

*Found in: [Component config](#) > [Hardware Settings](#) > [2D-DMA Configurations](#)*

This will ensure the 2D-DMA interrupt handler is IRAM-Safe, allow to avoid flash cache misses, and also be able to run whilst the cache is disabled. (e.g. SPI Flash write).

**Default value:**

- No (disabled) if SOC\_DMA2D\_SUPPORTED

**Main XTAL Config** Contains:

- [CONFIG\\_XTAL\\_FREQ\\_SEL](#)

## CONFIG\_XTAL\_FREQ\_SEL

Main XTAL frequency

*Found in: [Component config](#) > [Hardware Settings](#) > [Main XTAL Config](#)*

This option selects the operating frequency of the XTAL (crystal) clock used to drive the ESP target. The selected value MUST reflect the frequency of the given hardware.

Note: The XTAL\_FREQ\_AUTO option allows the ESP target to automatically estimating XTAL clock's operating frequency. However, this feature is only supported on the ESP32. The ESP32 uses the internal 8MHZ as a reference when estimating. Due to the internal oscillator's frequency being temperature dependent, usage of the XTAL\_FREQ\_AUTO is not recommended in applications that operate in high ambient temperatures or use high-temperature qualified chips and modules.

Available options:

- 24 MHz (CONFIG\_XTAL\_FREQ\_24)
- 26 MHz (CONFIG\_XTAL\_FREQ\_26)
- 32 MHz (CONFIG\_XTAL\_FREQ\_32)
- 40 MHz (CONFIG\_XTAL\_FREQ\_40)
- 48 MHz (CONFIG\_XTAL\_FREQ\_48)
- Autodetect (CONFIG\_XTAL\_FREQ\_AUTO)

**Crypto DPA Protection** Contains:

- [CONFIG\\_ESP\\_CRYPT\\_DPA\\_PROTECTION\\_AT\\_STARTUP](#)

## CONFIG\_ESP\_CRYPTDPA\_PROTECTION\_AT\_STARTUP

Enable crypto DPA protection at startup

*Found in: [Component config](#) > [Hardware Settings](#) > [Crypto DPA Protection](#)*

This config controls the DPA (Differential Power Analysis) protection knob for the crypto peripherals. DPA protection dynamically adjusts the clock frequency of the crypto peripheral. DPA protection helps to make it difficult to perform SCA attacks on the crypto peripherals. However, there is also associated performance impact based on the security level set. Please refer to the TRM for more details.

**Default value:**

- Yes (enabled)

## CONFIG\_ESP\_CRYPTDPA\_PROTECTION\_LEVEL

DPA protection level

*Found in: [Component config](#) > [Hardware Settings](#) > [Crypto DPA Protection](#) > [CONFIG\\_ESP\\_CRYPTDPA\\_PROTECTION\\_AT\\_STARTUP](#)*

Configure the DPA protection security level

Available options:

- Security level low (CONFIG\_ESP\_CRYPTDPA\_PROTECTION\_LEVEL\_LOW)
- Security level medium (CONFIG\_ESP\_CRYPTDPA\_PROTECTION\_LEVEL\_MEDIUM)
- Security level high (CONFIG\_ESP\_CRYPTDPA\_PROTECTION\_LEVEL\_HIGH)

**LCD and Touch Panel** Contains:

- [LCD Peripheral Configuration](#)

**LCD Peripheral Configuration** Contains:

- [CONFIG\\_LCD\\_DSI\\_ISR\\_IRAM\\_SAFE](#)
- [CONFIG\\_LCD\\_ENABLE\\_DEBUG\\_LOG](#)
- [CONFIG\\_LCD\\_PANEL\\_IO\\_FORMAT\\_BUF\\_SIZE](#)
- [CONFIG\\_LCD\\_RGB\\_RESTART\\_IN\\_VSYNC](#)
- [CONFIG\\_LCD\\_RGB\\_ISR\\_IRAM\\_SAFE](#)

## CONFIG\_LCD\_PANEL\_IO\_FORMAT\_BUF\_SIZE

LCD panel io format buffer size

*Found in: [Component config](#) > [LCD and Touch Panel](#) > [LCD Peripheral Configuration](#)*

LCD driver allocates an internal buffer to transform the data into a proper format, because of the endian order mismatch. This option is to set the size of the buffer, in bytes.

**Default value:**

- 32 if SOC\_LCD\_I80\_SUPPORTED

## CONFIG\_LCD\_ENABLE\_DEBUG\_LOG

Enable debug log

*Found in: [Component config](#) > [LCD and Touch Panel](#) > [LCD Peripheral Configuration](#)*

whether to enable the debug log message for LCD driver. Note that, this option only controls the LCD driver log, won't affect other drivers.

**Default value:**



- No (disabled)

### CONFIG\_LCD\_RGB\_ISR\_IRAM\_SAFE

RGB LCD ISR IRAM-Safe

*Found in: Component config > LCD and Touch Panel > LCD Peripheral Configuration*

Ensure the LCD interrupt is IRAM-Safe by allowing the interrupt handler to be executable when the cache is disabled (e.g. SPI Flash write). If you want the LCD driver to keep flushing the screen even when cache ops disabled, you can enable this option. Note, this will also increase the IRAM usage.

**Default value:**

- No (disabled) if SOC\_LCD\_RGB\_SUPPORTED

### CONFIG\_LCD\_RGB\_RESTART\_IN\_VSYNC

Restart transmission in VSYNC

*Found in: Component config > LCD and Touch Panel > LCD Peripheral Configuration*

Reset the GDMA channel every VBlank to stop permanent desyncs from happening. Only need to enable it when in your application, the DMA can't deliver data as fast as the LCD consumes it.

**Default value:**

- No (disabled) if SOC\_LCD\_RGB\_SUPPORTED

### CONFIG\_LCD\_DSI\_ISR\_IRAM\_SAFE

DSI LCD ISR IRAM-Safe

*Found in: Component config > LCD and Touch Panel > LCD Peripheral Configuration*

Ensure the LCD interrupt is IRAM-Safe by allowing the interrupt handler to be executable when the cache is disabled (e.g. SPI Flash write). If you want the LCD driver to keep flushing the screen even when cache ops disabled, you can enable this option. Note, this will also increase the IRAM usage.

**Default value:**

- No (disabled) if SOC\_MIPI\_DSI\_SUPPORTED

### ESP NETIF Adapter Contains:

- [CONFIG\\_ESP\\_NETIF\\_BRIDGE\\_EN](#)
- [CONFIG\\_ESP\\_NETIF\\_L2\\_TAP](#)
- [CONFIG\\_ESP\\_NETIF\\_IP\\_LOST\\_TIMER\\_INTERVAL](#)
- [CONFIG\\_ESP\\_NETIF\\_USE\\_TCPIP\\_STACK\\_LIB](#)
- [CONFIG\\_ESP\\_NETIF\\_RECEIVE\\_REPORT\\_ERRORS](#)

### CONFIG\_ESP\_NETIF\_IP\_LOST\_TIMER\_INTERVAL

IP Address lost timer interval (seconds)

*Found in: Component config > ESP NETIF Adapter*

The value of 0 indicates the IP lost timer is disabled, otherwise the timer is enabled.

The IP address may be lost because of some reasons, e.g. when the station disconnects from soft-AP, or when DHCP IP renew fails etc. If the IP lost timer is enabled, it will be started everytime the IP is lost. Event SYSTEM\_EVENT\_STA\_LOST\_IP will be raised if the timer expires. The IP lost timer is stopped if the station get the IP again before the timer expires.

**Range:**

- from 0 to 65535

**Default value:**

- 120

### CONFIG\_ESP\_NETIF\_USE\_TCPIP\_STACK\_LIB

TCP/IP Stack Library

*Found in: Component config > ESP NETIF Adapter*

Choose the TCP/IP Stack to work, for example, LwIP, uIP, etc.

Available options:

- LwIP (CONFIG\_ESP\_NETIF\_TCPIP\_LWIP)  
lwIP is a small independent implementation of the TCP/IP protocol suite.
- Loopback (CONFIG\_ESP\_NETIF\_LOOPBACK)  
Dummy implementation of esp-netif functionality which connects driver transmit to receive function. This option is for testing purpose only

### CONFIG\_ESP\_NETIF\_RECEIVE\_REPORT\_ERRORS

Use esp\_err\_t to report errors from esp\_netif\_receive

*Found in: Component config > ESP NETIF Adapter*

Enable if esp\_netif\_receive() should return error code. This is useful to inform upper layers that packet input to TCP/IP stack failed, so the upper layers could implement flow control. This option is disabled by default due to backward compatibility and will be enabled in v6.0 (IDF-7194)

**Default value:**

- No (disabled)

### CONFIG\_ESP\_NETIF\_L2\_TAP

Enable netif L2 TAP support

*Found in: Component config > ESP NETIF Adapter*

A user program can read/write link layer (L2) frames from/to ESP TAP device. The ESP TAP device can be currently associated only with Ethernet physical interfaces.

### CONFIG\_ESP\_NETIF\_L2\_TAP\_MAX\_FDS

Maximum number of opened L2 TAP File descriptors

*Found in: Component config > ESP NETIF Adapter > CONFIG\_ESP\_NETIF\_L2\_TAP*

Maximum number of opened File descriptors (FD's) associated with ESP TAP device. ESP TAP FD's take up a certain amount of memory, and allowing fewer FD's to be opened at the same time conserves memory.

**Range:**

- from 1 to 10 if *CONFIG\_ESP\_NETIF\_L2\_TAP*

**Default value:**

- 5 if *CONFIG\_ESP\_NETIF\_L2\_TAP*

### CONFIG\_ESP\_NETIF\_L2\_TAP\_RX\_QUEUE\_SIZE

Size of L2 TAP Rx queue

*Found in: Component config > ESP NETIF Adapter > CONFIG\_ESP\_NETIF\_L2\_TAP*

Maximum number of frames queued in opened File descriptor. Once the queue is full, the newly arriving frames are dropped until the queue has enough room to accept incoming traffic (Tail Drop queue management).

**Range:**

- from 1 to 100 if `CONFIG_ESP_NETIF_L2_TAP`

**Default value:**

- 20 if `CONFIG_ESP_NETIF_L2_TAP`

### **CONFIG\_ESP\_NETIF\_BRIDGE\_EN**

Enable LwIP IEEE 802.1D bridge

*Found in: [Component config](#) > [ESP NETIF Adapter](#)*

Enable LwIP IEEE 802.1D bridge support in ESP-NETIF. Note that "Number of clients store data in netif" (LWIP\_NUM\_NETIF\_CLIENT\_DATA) option needs to be properly configured to be LwIP bridge available!

**Default value:**

- No (disabled)

### **Partition API Configuration**

**PHY** Contains:

- `CONFIG_ESP_PHY_CALIBRATION_MODE`
- `CONFIG_ESP_PHY_PLL_TRACK_DEBUG`
- `CONFIG_ESP_PHY_IMPROVE_RX_11B`
- `CONFIG_ESP_PHY_ENABLE_USB`
- `CONFIG_ESP_PHY_MAX_WIFI_TX_POWER`
- `CONFIG_ESP_PHY_MAC_BB_PD`
- `CONFIG_ESP_PHY_REDUCE_TX_POWER`
- `CONFIG_ESP_PHY_CALIBRATION_AND_DATA_STORAGE`
- `CONFIG_ESP_PHY_INIT_DATA_IN_PARTITION`

### **CONFIG\_ESP\_PHY\_CALIBRATION\_AND\_DATA\_STORAGE**

Store phy calibration data in NVS

*Found in: [Component config](#) > [PHY](#)*

If this option is enabled, NVS will be initialized and calibration data will be loaded from there. PHY calibration will be skipped on deep sleep wakeup. If calibration data is not found, full calibration will be performed and stored in NVS. Normally, only partial calibration will be performed. If this option is disabled, full calibration will be performed.

If it's easy that your board calibrate bad data, choose 'n'. Two cases for example, you should choose 'n': 1.If your board is easy to be booted up with antenna disconnected. 2.Because of your board design, each time when you do calibration, the result are too unstable. If unsure, choose 'y'.

**Default value:**

- Yes (enabled)

### **CONFIG\_ESP\_PHY\_INIT\_DATA\_IN\_PARTITION**

Use a partition to store PHY init data

*Found in: [Component config](#) > [PHY](#)*

If enabled, PHY init data will be loaded from a partition. When using a custom partition table, make sure that PHY data partition is included (type: 'data', subtype: 'phy'). With default partition tables, this is

done automatically. If PHY init data is stored in a partition, it has to be flashed there, otherwise runtime error will occur.

If this option is not enabled, PHY init data will be embedded into the application binary.

If unsure, choose 'n'.

**Default value:**

- No (disabled) if SOC\_WIFI\_SUPPORTED

Contains:

- [CONFIG\\_ESP\\_PHY\\_DEFAULT\\_INIT\\_IF\\_INVALID](#)
- [CONFIG\\_ESP\\_PHY\\_MULTIPLE\\_INIT\\_DATA\\_BIN](#)

### CONFIG\_ESP\_PHY\_DEFAULT\_INIT\_IF\_INVALID

Reset default PHY init data if invalid

*Found in:* [Component config](#) > [PHY](#) > [CONFIG\\_ESP\\_PHY\\_INIT\\_DATA\\_IN\\_PARTITION](#)

If enabled, PHY init data will be restored to default if it cannot be verified successfully to avoid endless bootloops.

If unsure, choose 'n'.

**Default value:**

- No (disabled) if [CONFIG\\_ESP\\_PHY\\_INIT\\_DATA\\_IN\\_PARTITION](#)

### CONFIG\_ESP\_PHY\_MULTIPLE\_INIT\_DATA\_BIN

Support multiple PHY init data bin

*Found in:* [Component config](#) > [PHY](#) > [CONFIG\\_ESP\\_PHY\\_INIT\\_DATA\\_IN\\_PARTITION](#)

If enabled, the corresponding PHY init data type can be automatically switched according to the country code. China's PHY init data bin is used by default. Can be modified by country information in API `esp_wifi_set_country()`. The priority of switching the PHY init data type is: 1. Country configured by API `esp_wifi_set_country()` and the parameter policy is `WIFI_COUNTRY_POLICY_MANUAL`. 2. Country notified by the connected AP. 3. Country configured by API `esp_wifi_set_country()` and the parameter policy is `WIFI_COUNTRY_POLICY_AUTO`.

**Default value:**

- No (disabled) if [CONFIG\\_ESP\\_PHY\\_INIT\\_DATA\\_IN\\_PARTITION](#) && [CONFIG\\_ESP\\_PHY\\_INIT\\_DATA\\_IN\\_PARTITION](#)

### CONFIG\_ESP\_PHY\_MULTIPLE\_INIT\_DATA\_BIN\_EMBED

Support embedded multiple phy init data bin to app bin

*Found in:* [Component config](#) > [PHY](#) > [CONFIG\\_ESP\\_PHY\\_INIT\\_DATA\\_IN\\_PARTITION](#) > [CONFIG\\_ESP\\_PHY\\_MULTIPLE\\_INIT\\_DATA\\_BIN](#)

If enabled, multiple phy init data bin will embedded into app bin If not enabled, multiple phy init data bin will still leave alone, and need to be flashed by users.

**Default value:**

- No (disabled) if [CONFIG\\_ESP\\_PHY\\_MULTIPLE\\_INIT\\_DATA\\_BIN](#) && [CONFIG\\_ESP\\_PHY\\_INIT\\_DATA\\_IN\\_PARTITION](#)

### CONFIG\_ESP\_PHY\_INIT\_DATA\_ERROR

Terminate operation when PHY init data error

*Found in:* *Component config > PHY > CONFIG\_ESP\_PHY\_INIT\_DATA\_IN\_PARTITION > CONFIG\_ESP\_PHY\_MULTIPLE\_INIT\_DATA\_BIN*

If enabled, when an error occurs while the PHY init data is updated, the program will terminate and restart. If not enabled, the PHY init data will not be updated when an error occurs.

**Default value:**

- No (disabled) if *CONFIG\_ESP\_PHY\_MULTIPLE\_INIT\_DATA\_BIN* && *CONFIG\_ESP\_PHY\_INIT\_DATA\_IN\_PARTITION*

### CONFIG\_ESP\_PHY\_MAX\_WIFI\_TX\_POWER

Max WiFi TX power (dBm)

*Found in:* *Component config > PHY*

Set maximum transmit power for WiFi radio. Actual transmit power for high data rates may be lower than this setting.

**Range:**

- from 10 to 20

**Default value:**

- 20

### CONFIG\_ESP\_PHY\_MAC\_BB\_PD

Power down MAC and baseband of Wi-Fi and Bluetooth when PHY is disabled

*Found in:* *Component config > PHY*

If enabled, the MAC and baseband of Wi-Fi and Bluetooth will be powered down when PHY is disabled. Enabling this setting reduces power consumption by a small amount but increases RAM use by approximately 4 KB(Wi-Fi only), 2 KB(Bluetooth only) or 5.3 KB(Wi-Fi + Bluetooth).

**Default value:**

- No (disabled) if *SOC\_PM\_SUPPORT\_MAC\_BB\_PD* && *CONFIG\_FREERTOS\_USE\_TICKLESS\_IDLE*

### CONFIG\_ESP\_PHY\_REDUCE\_TX\_POWER

Reduce PHY TX power when brownout reset

*Found in:* *Component config > PHY*

When brownout reset occurs, reduce PHY TX power to keep the code running.

**Default value:**

- No (disabled)

### CONFIG\_ESP\_PHY\_ENABLE\_USB

Keep the USB PHY enabled when initializing WiFi

*Found in:* *Component config > PHY*

On some ESP targets, the USB PHY can interfere with WiFi thus lowering WiFi performance. As a result, on those affected ESP targets, the ESP PHY library's initialization will automatically disable the USB PHY to get best WiFi performance. This option controls whether or not the ESP PHY library will keep the USB PHY enabled on initialization.

Note: This option can be disabled to increase WiFi performance. However, disabling this option will also mean that the USB PHY cannot be used while WiFi is enabled.

**Default value:**

- Yes (enabled) if `(CONFIG_ESP_CONSOLE_USB_SERIAL_JTAG || CONFIG_ESP_CONSOLE_SECONDARY_USB_SERIAL_JTAG) && SOC_WIFI_PHY_NEEDS_USB_WORKAROUND`
- No (disabled) if `SOC_WIFI_PHY_NEEDS_USB_WORKAROUND`

## CONFIG\_ESP\_PHY\_CALIBRATION\_MODE

Calibration mode

Found in: [Component config](#) > [PHY](#)

Select PHY calibration mode. During RF initialization, the partial calibration method is used by default for RF calibration. Full calibration takes about 100ms more than partial calibration. If boot duration is not critical, it is suggested to use the full calibration method. No calibration method is only used when the device wakes up from deep sleep.

Available options:

- Calibration partial (`CONFIG_ESP_PHY_RF_CAL_PARTIAL`)
- Calibration none (`CONFIG_ESP_PHY_RF_CAL_NONE`)
- Calibration full (`CONFIG_ESP_PHY_RF_CAL_FULL`)

## CONFIG\_ESP\_PHY\_IMPROVE\_RX\_11B

Improve Wi-Fi receive 11b pkts

Found in: [Component config](#) > [PHY](#)

This is a workaround to improve Wi-Fi receive 11b pkts for some modules using AC-DC power supply with high interference, enable this option will sacrifice Wi-Fi OFDM receive performance. But to guarantee 11b receive performance serves as a bottom line in this case.

**Default value:**

- No (disabled) if `SOC_PHY_IMPROVE_RX_11B`

## CONFIG\_ESP\_PHY\_PLL\_TRACK\_DEBUG

Enable pll track logging

Found in: [Component config](#) > [PHY](#)

If enabled, there will be some logs while pll tracking

**Default value:**

- No (disabled)

## Power Management

Contains:

- [CONFIG\\_PM\\_LIGHTSLEEP\\_RTC\\_OSC\\_CAL\\_INTERVAL](#)
- [CONFIG\\_PM\\_SLP\\_DISABLE\\_GPIO](#)
- [CONFIG\\_PM\\_LIGHT\\_SLEEP\\_CALLBACKS](#)
- [CONFIG\\_PM\\_POWER\\_DOWN\\_CPU\\_IN\\_LIGHT\\_SLEEP](#)
- [CONFIG\\_PM\\_POWER\\_DOWN\\_PERIPHERAL\\_IN\\_LIGHT\\_SLEEP](#)
- [CONFIG\\_PM\\_SLP\\_IRAM\\_OPT](#)
- [CONFIG\\_PM\\_RTOS\\_IDLE\\_OPT](#)
- [CONFIG\\_PM\\_ENABLE](#)

## CONFIG\_PM\_ENABLE

Support for power management

*Found in: [Component config](#) > [Power Management](#)*

If enabled, application is compiled with support for power management. This option has run-time overhead (increased interrupt latency, longer time to enter idle state), and it also reduces accuracy of RTOS ticks and timers used for timekeeping. Enable this option if application uses power management APIs.

**Default value:**

- No (disabled) if `__DOXYGEN__`

## CONFIG\_PM\_DFS\_INIT\_AUTO

Enable dynamic frequency scaling (DFS) at startup

*Found in: [Component config](#) > [Power Management](#) > [CONFIG\\_PM\\_ENABLE](#)*

If enabled, startup code configures dynamic frequency scaling. Max CPU frequency is set to `DEFAULT_CPU_FREQ_MHZ` setting, min frequency is set to XTAL frequency. If disabled, DFS will not be active until the application configures it using `esp_pm_configure` function.

**Default value:**

- No (disabled) if [CONFIG\\_PM\\_ENABLE](#)

## CONFIG\_PM\_PROFILING

Enable profiling counters for PM locks

*Found in: [Component config](#) > [Power Management](#) > [CONFIG\\_PM\\_ENABLE](#)*

If enabled, `esp_pm_*` functions will keep track of the amount of time each of the power management locks has been held, and `esp_pm_dump_locks` function will print this information. This feature can be used to analyze which locks are preventing the chip from going into a lower power state, and see what time the chip spends in each power saving mode. This feature does incur some run-time overhead, so should typically be disabled in production builds.

**Default value:**

- No (disabled) if [CONFIG\\_PM\\_ENABLE](#)

## CONFIG\_PM\_TRACE

Enable debug tracing of PM using GPIOs

*Found in: [Component config](#) > [Power Management](#) > [CONFIG\\_PM\\_ENABLE](#)*

If enabled, some GPIOs will be used to signal events such as RTOS ticks, frequency switching, entry/exit from idle state. Refer to `pm_trace.c` file for the list of GPIOs. This feature is intended to be used when analyzing/debugging behavior of power management implementation, and should be kept disabled in applications.

**Default value:**

- No (disabled) if [CONFIG\\_PM\\_ENABLE](#)

## CONFIG\_PM\_SLP\_IRAM\_OPT

Put lightsleep related codes in internal RAM

*Found in: [Component config](#) > [Power Management](#)*

If enabled, about 2.1KB of lightsleep related source code would be in IRAM and chip would sleep longer for 310us at 160MHz CPU frequency most each time. This feature is intended to be used when lower power consumption is needed while there is enough place in IRAM to place source code.

### CONFIG\_PM\_RTOS\_IDLE\_OPT

Put RTOS IDLE related codes in internal RAM

*Found in: [Component config](#) > [Power Management](#)*

If enabled, about 180Bytes of RTOS\_IDLE related source code would be in IRAM and chip would sleep longer for 20us at 160MHz CPU frequency most each time. This feature is intended to be used when lower power consumption is needed while there is enough place in IRAM to place source code.

### CONFIG\_PM\_SLP\_DISABLE\_GPIO

Disable all GPIO when chip at sleep

*Found in: [Component config](#) > [Power Management](#)*

This feature is intended to disable all GPIO pins at automatic sleep to get a lower power mode. If enabled, chips will disable all GPIO pins at automatic sleep to reduce about 200~300 uA current. If you want to specifically use some pins normally as chip wakes when chip sleeps, you can call 'gpio\_sleep\_sel\_dis' to disable this feature on those pins. You can also keep this feature on and call 'gpio\_sleep\_set\_direction' and 'gpio\_sleep\_set\_pull\_mode' to have a different GPIO configuration at sleep. Warning: If you want to enable this option on ESP32, you should enable `GPIO_ESP32_SUPPORT_SWITCH_SLP_PULL` at first, otherwise you will not be able to switch pullup/pulldown mode.

### CONFIG\_PM\_LIGHTSLEEP\_RTC\_OSC\_CAL\_INTERVAL

Calibrate the RTC\_FAST/SLOW clock every N times of light sleep

*Found in: [Component config](#) > [Power Management](#)*

The value of this option determines the calibration interval of the RTC\_FAST/SLOW clock during sleep when power management is enabled. When it is configured as N, the RTC\_FAST/SLOW clock will be calibrated every N times of lightsleep. Decreasing this value will increase the time the chip is in the active state, thereby increasing the average power consumption of the chip. Increasing this value can reduce the average power consumption, but when the external environment changes drastically and the chip RTC\_FAST/SLOW oscillator frequency drifts, it may cause system instability.

**Range:**

- from 1 to 128 if `CONFIG_PM_ENABLE`

**Default value:**

- 1 if `CONFIG_PM_ENABLE`

### CONFIG\_PM\_POWER\_DOWN\_CPU\_IN\_LIGHT\_SLEEP

Power down CPU in light sleep

*Found in: [Component config](#) > [Power Management](#)*

If enabled, the CPU will be powered down in light sleep, ESP chips supports saving and restoring CPU's running context before and after light sleep, the feature provides applications with seamless CPU powerdowned lightsleep without user awareness. But this will takes up some internal memory. On esp32c3 soc, enabling this option will consume 1.68 KB of internal RAM and will reduce sleep current consumption by about 100 uA. On esp32s3 soc, enabling this option will consume 8.58 KB of internal RAM and will reduce sleep current consumption by about 650 uA.

**Default value:**

- Yes (enabled)



## CONFIG\_PM\_POWER\_DOWN\_PERIPHERAL\_IN\_LIGHT\_SLEEP

Power down Digital Peripheral in light sleep (EXPERIMENTAL)

*Found in: [Component config](#) > [Power Management](#)*

If enabled, digital peripherals will be powered down in light sleep, it will reduce sleep current consumption by about 100 uA. Chip will save/restore register context at sleep/wake time to keep the system running. Enabling this option will increase static RAM and heap usage, the actual cost depends on the peripherals you have initialized. In order to save/restore the context of the necessary hardware for FreeRTOS to run, it will need at least 4.55 KB free heap at sleep time. Otherwise sleep will not power down the peripherals.

Note1: Please use this option with caution, the current IDF does not support the retention of all peripherals. When the digital peripherals are powered off and a sleep and wake-up is completed, the peripherals that have not saved the running context are equivalent to performing a reset. !!! Please confirm the peripherals used in your application and their sleep retention support status before enabling this option, peripherals sleep retention driver support status is tracked in power\_management.rst

Note2: When this option is enabled simultaneously with FREERTOS\_USE\_TICKLESS\_IDLE, since the UART will be powered down, the uart FIFO will be flushed before sleep to avoid data loss, however, this has the potential to block the sleep process and cause the wakeup time to be skipped, which will cause the tick of freertos to not be compensated correctly when returning from sleep and cause the system to crash. To avoid this, you can increase FREERTOS\_IDLE\_TIME\_BEFORE\_SLEEP threshold in menuconfig.

**Default value:**

- No (disabled)

## CONFIG\_PM\_LIGHT\_SLEEP\_CALLBACKS

Enable registration of pm light sleep callbacks

*Found in: [Component config](#) > [Power Management](#)*

If enabled, it allows user to register entry and exit callbacks which are called before and after entering auto light sleep.

NOTE: These callbacks are executed from the IDLE task context hence you cannot have any blocking calls in your callbacks.

NOTE: Enabling these callbacks may change sleep duration calculations based on time spent in callback and hence it is highly recommended to keep them as short as possible

**Default value:**

- No (disabled) if [CONFIG\\_FREERTOS\\_USE\\_TICKLESS\\_IDLE](#)

## ESP PSRAM

**ESP Ringbuf** Contains:

- [CONFIG\\_RINGBUF\\_PLACE\\_FUNCTIONS\\_INTO\\_FLASH](#)

## CONFIG\_RINGBUF\_PLACE\_FUNCTIONS\_INTO\_FLASH

Place non-ISR ringbuf functions into flash

*Found in: [Component config](#) > [ESP Ringbuf](#)*

Place non-ISR ringbuf functions (like xRingbufferCreate/xRingbufferSend) into flash. This frees up IRAM, but the functions can no longer be called when the cache is disabled.

**Default value:**

- No (disabled)

**CONFIG\_RINGBUF\_PLACE\_ISR\_FUNCTIONS\_INTO\_FLASH**

Place ISR ringbuf functions into flash

*Found in: Component config > ESP Ringbuf > CONFIG\_RINGBUF\_PLACE\_FUNCTIONS\_INTO\_FLASH*

Place ISR ringbuf functions (like xRingbufferSendFromISR/xRingbufferReceiveFromISR) into flash. This frees up IRAM, but the functions can no longer be called when the cache is disabled or from an IRAM interrupt context.

This option is not compatible with ESP-IDF drivers which are configured to run the ISR from an IRAM context, e.g. CONFIG\_UART\_ISR\_IN\_IRAM.

**Default value:**

- No (disabled) if *CONFIG\_RINGBUF\_PLACE\_FUNCTIONS\_INTO\_FLASH*

**ESP System Settings** Contains:

- *CONFIG\_ESP\_SYSTEM\_RTC\_EXT\_XTAL\_BOOTSTRAP\_CYCLES*
- *Brownout Detector*
- *CONFIG\_ESP\_CONSOLE\_UART*
- *CONFIG\_ESP\_CONSOLE\_SECONDARY*
- *CONFIG\_ESP\_DEFAULT\_CPU\_FREQ\_MHZ*
- *CONFIG\_ESP\_SYSTEM\_ALLOW\_RTC\_FAST\_MEM\_AS\_HEAP*
- *CONFIG\_ESP\_TASK\_WDT\_EN*
- *CONFIG\_ESP\_SYSTEM\_EVENT\_TASK\_STACK\_SIZE*
- *CONFIG\_ESP\_SYSTEM\_USE\_EH\_FRAME*
- *CONFIG\_ESP\_SYSTEM\_HW\_PC\_RECORD*
- *CONFIG\_ESP\_SYSTEM\_HW\_STACK\_GUARD*
- *CONFIG\_ESP\_XT\_WDT*
- *CONFIG\_ESP\_SYSTEM\_CHECK\_INT\_LEVEL*
- *CONFIG\_ESP\_INT\_WDT*
- *CONFIG\_ESP\_MAIN\_TASK\_AFFINITY*
- *CONFIG\_ESP\_MAIN\_TASK\_STACK\_SIZE*
- *CONFIG\_ESP\_DEBUG\_OCDAWARE*
- *Memory protection*
- *CONFIG\_ESP\_MINIMAL\_SHARED\_STACK\_SIZE*
- *CONFIG\_ESP\_DEBUG\_STUBS\_ENABLE*
- *CONFIG\_ESP\_SYSTEM\_PANIC*
- *CONFIG\_ESP\_SYSTEM\_PANIC\_REBOOT\_DELAY\_SECONDS*
- *CONFIG\_ESP\_PANIC\_HANDLER\_IRAM*
- *CONFIG\_ESP\_SYSTEM\_BBPLL\_RECALIB*
- *CONFIG\_ESP\_SYSTEM\_EVENT\_QUEUE\_SIZE*
- *CONFIG\_ESP\_CONSOLE\_UART\_BAUDRATE*
- *CONFIG\_ESP\_CONSOLE\_UART\_NUM*
- *CONFIG\_ESP\_CONSOLE\_UART\_RX\_GPIO*
- *CONFIG\_ESP\_CONSOLE\_UART\_TX\_GPIO*

**CONFIG\_ESP\_DEFAULT\_CPU\_FREQ\_MHZ**

CPU frequency

*Found in: Component config > ESP System Settings*

CPU frequency to be set on application startup.

Available options:

- 16 MHz (CONFIG\_ESP\_DEFAULT\_CPU\_FREQ\_MHZ\_16)
- 32 MHz (CONFIG\_ESP\_DEFAULT\_CPU\_FREQ\_MHZ\_32)
- 48 MHz (CONFIG\_ESP\_DEFAULT\_CPU\_FREQ\_MHZ\_48)

- 64 MHz (CONFIG\_ESP\_DEFAULT\_CPU\_FREQ\_MHZ\_64)
- 96 MHz (CONFIG\_ESP\_DEFAULT\_CPU\_FREQ\_MHZ\_96)

### CONFIG\_ESP\_SYSTEM\_PANIC

Panic handler behaviour

*Found in: Component config > ESP System Settings*

If FreeRTOS detects unexpected behaviour or an unhandled exception, the panic handler is invoked. Configure the panic handler's action here.

Available options:

- Print registers and halt (CONFIG\_ESP\_SYSTEM\_PANIC\_PRINT\_HALT)  
Outputs the relevant registers over the serial port and halt the processor. Needs a manual reset to restart.
- Print registers and reboot (CONFIG\_ESP\_SYSTEM\_PANIC\_PRINT\_REBOOT)  
Outputs the relevant registers over the serial port and immediately reset the processor.
- Silent reboot (CONFIG\_ESP\_SYSTEM\_PANIC\_SILENT\_REBOOT)  
Just resets the processor without outputting anything
- GDBStub on panic (CONFIG\_ESP\_SYSTEM\_PANIC\_GDBSTUB)  
Invoke gdbstub on the serial port, allowing for gdb to attach to it to do a postmortem of the crash.

### CONFIG\_ESP\_SYSTEM\_PANIC\_REBOOT\_DELAY\_SECONDS

Panic reboot delay (Seconds)

*Found in: Component config > ESP System Settings*

After the panic handler executes, you can specify a number of seconds to wait before the device reboots.

**Range:**

- from 0 to 99

**Default value:**

- 0

### CONFIG\_ESP\_SYSTEM\_RTC\_EXT\_XTAL\_BOOTSTRAP\_CYCLES

Bootstrap cycles for external 32kHz crystal

*Found in: Component config > ESP System Settings*

To reduce the startup time of an external RTC crystal, we bootstrap it with a 32kHz square wave for a fixed number of cycles. Setting 0 will disable bootstrapping (if disabled, the crystal may take longer to start up or fail to oscillate under some conditions).

If this value is too high, a faulty crystal may initially start and then fail. If this value is too low, an otherwise good crystal may not start.

To accurately determine if the crystal has started, set a larger "Number of cycles for RTC\_SLOW\_CLK calibration" (about 3000).

### CONFIG\_ESP\_SYSTEM\_ALLOW\_RTC\_FAST\_MEM\_AS\_HEAP

Enable RTC fast memory for dynamic allocations

*Found in: Component config > ESP System Settings*

This config option allows to add RTC fast memory region to system heap with capability similar to that of DRAM region but without DMA. This memory will be consumed first per heap initialization order

by early startup services and scheduler related code. Speed wise RTC fast memory operates on APB clock and hence does not have much performance impact.

### **CONFIG\_ESP\_SYSTEM\_USE\_EH\_FRAME**

Generate and use eh\_frame for backtracing

*Found in: Component config > ESP System Settings*

Generate DWARF information for each function of the project. These information will be parsed and used to perform backtracing when panics occur. Activating this option will activate asynchronous frame unwinding and generation of both .eh\_frame and .eh\_frame\_hdr sections, resulting in a bigger binary size (20% to 100% larger). The main purpose of this option is to be able to have a backtrace parsed and printed by the program itself, regardless of the serial monitor used. This option shall NOT be used for production.

**Default value:**

- No (disabled)

### **Memory protection** Contains:

- [CONFIG\\_ESP\\_SYSTEM\\_PMP\\_IDRAM\\_SPLIT](#)
- [CONFIG\\_ESP\\_SYSTEM\\_MEMPROT\\_FEATURE](#)

### **CONFIG\_ESP\_SYSTEM\_PMP\_IDRAM\_SPLIT**

Enable IRAM/DRAM split protection

*Found in: Component config > ESP System Settings > Memory protection*

If enabled, the CPU watches all the memory access and raises an exception in case of any memory violation. This feature automatically splits the SRAM memory, using PMP, into data and instruction segments and sets Read/Execute permissions for the instruction part (below given splitting address) and Read/Write permissions for the data part (above the splitting address). The memory protection is effective on all access through the IRAM0 and DRAM0 buses.

**Default value:**

- Yes (enabled)

### **CONFIG\_ESP\_SYSTEM\_MEMPROT\_FEATURE**

Enable memory protection

*Found in: Component config > ESP System Settings > Memory protection*

If enabled, the permission control module watches all the memory access and fires the panic handler if a permission violation is detected. This feature automatically splits the SRAM memory into data and instruction segments and sets Read/Execute permissions for the instruction part (below given splitting address) and Read/Write permissions for the data part (above the splitting address). The memory protection is effective on all access through the IRAM0 and DRAM0 buses.

**Default value:**

- Yes (enabled) if SOC\_MEMPROT\_SUPPORTED

### **CONFIG\_ESP\_SYSTEM\_MEMPROT\_FEATURE\_LOCK**

Lock memory protection settings

*Found in: Component config > ESP System Settings > Memory protection > CONFIG\_ESP\_SYSTEM\_MEMPROT\_FEATURE*

Once locked, memory protection settings cannot be changed anymore. The lock is reset only on the chip startup.

**Default value:**

- Yes (enabled) if `CONFIG_ESP_SYSTEM_MEMPROT_FEATURE`

**CONFIG\_ESP\_SYSTEM\_EVENT\_QUEUE\_SIZE**

System event queue size

*Found in: Component config > ESP System Settings*

Config system event queue size in different application.

**Default value:**

- 32

**CONFIG\_ESP\_SYSTEM\_EVENT\_TASK\_STACK\_SIZE**

Event loop task stack size

*Found in: Component config > ESP System Settings*

Config system event task stack size in different application.

**Default value:**

- 2304

**CONFIG\_ESP\_MAIN\_TASK\_STACK\_SIZE**

Main task stack size

*Found in: Component config > ESP System Settings*

Configure the "main task" stack size. This is the stack of the task which calls `app_main()`. If `app_main()` returns then this task is deleted and its stack memory is freed.

**Default value:**

- 3584

**CONFIG\_ESP\_MAIN\_TASK\_AFFINITY**

Main task core affinity

*Found in: Component config > ESP System Settings*

Configure the "main task" core affinity. This is the used core of the task which calls `app_main()`. If `app_main()` returns then this task is deleted.

Available options:

- CPU0 (`CONFIG_ESP_MAIN_TASK_AFFINITY_CPU0`)
- CPU1 (`CONFIG_ESP_MAIN_TASK_AFFINITY_CPU1`)
- No affinity (`CONFIG_ESP_MAIN_TASK_AFFINITY_NO_AFFINITY`)

**CONFIG\_ESP\_MINIMAL\_SHARED\_STACK\_SIZE**

Minimal allowed size for shared stack

*Found in: Component config > ESP System Settings*

Minimal value of size, in bytes, accepted to execute a expression with shared stack.

**Default value:**

- 2048

## CONFIG\_ESP\_CONSOLE\_UART

Channel for console output

*Found in: [Component config](#) > [ESP System Settings](#)*

Select where to send console output (through stdout and stderr).

- Default is to use UART0 on pre-defined GPIOs.
- If "Custom" is selected, UART0 or UART1 can be chosen, and any pins can be selected.
- If "None" is selected, there will be no console output on any UART, except for initial output from ROM bootloader. This ROM output can be suppressed by GPIO strapping or EFUSE, refer to chip datasheet for details.
- On chips with USB OTG peripheral, "USB CDC" option redirects output to the CDC port. This option uses the CDC driver in the chip ROM. This option is incompatible with TinyUSB stack.
- On chips with an USB serial/JTAG debug controller, selecting the option for that redirects output to the CDC/ACM (serial port emulation) component of that device.

Available options:

- Default: UART0 (CONFIG\_ESP\_CONSOLE\_UART\_DEFAULT)
- USB CDC (CONFIG\_ESP\_CONSOLE\_USB\_CDC)
- USB Serial/JTAG Controller (CONFIG\_ESP\_CONSOLE\_USB\_SERIAL\_JTAG)
- Custom UART (CONFIG\_ESP\_CONSOLE\_UART\_CUSTOM)
- None (CONFIG\_ESP\_CONSOLE\_NONE)

## CONFIG\_ESP\_CONSOLE\_SECONDARY

Channel for console secondary output

*Found in: [Component config](#) > [ESP System Settings](#)*

This secondary option supports output through other specific port like USB\_SERIAL\_JTAG when UART0 port as a primary is selected but not connected. This secondary output currently only supports non-blocking mode without using REPL. If you want to output in blocking mode with REPL or input through this secondary port, please change the primary config to this port in *Channel for console output* menu.

Available options:

- No secondary console (CONFIG\_ESP\_CONSOLE\_SECONDARY\_NONE)
- USB\_SERIAL\_JTAG PORT (CONFIG\_ESP\_CONSOLE\_SECONDARY\_USB\_SERIAL\_JTAG)  
This option supports output through USB\_SERIAL\_JTAG port when the UART0 port is not connected. The output currently only supports non-blocking mode without using the console. If you want to output in blocking mode with REPL or input through USB\_SERIAL\_JTAG port, please change the primary config to ESP\_CONSOLE\_USB\_SERIAL\_JTAG above.

## CONFIG\_ESP\_CONSOLE\_UART\_NUM

UART peripheral to use for console output (0-1)

*Found in: [Component config](#) > [ESP System Settings](#)*

This UART peripheral is used for console output from the ESP-IDF Bootloader and the app.

If the configuration is different in the Bootloader binary compared to the app binary, UART is reconfigured after the bootloader exits and the app starts.

Due to an ESP32 ROM bug, UART2 is not supported for console output via `esp_rom_printf`.

Available options:

- UART0 (CONFIG\_ESP\_CONSOLE\_UART\_CUSTOM\_NUM\_0)
- UART1 (CONFIG\_ESP\_CONSOLE\_UART\_CUSTOM\_NUM\_1)

### CONFIG\_ESP\_CONSOLE\_UART\_TX\_GPIO

UART TX on GPIO#

*Found in: Component config > ESP System Settings*

This GPIO is used for console UART TX output in the ESP-IDF Bootloader and the app (including boot log output and default standard output and standard error of the app).

If the configuration is different in the Bootloader binary compared to the app binary, UART is reconfigured after the bootloader exits and the app starts.

**Range:**

- from 0 to 27 if *CONFIG\_ESP\_CONSOLE\_UART\_CUSTOM*

**Default value:**

- 24 if *CONFIG\_ESP\_CONSOLE\_UART\_CUSTOM*
- 43 if *CONFIG\_ESP\_CONSOLE\_UART\_CUSTOM*

### CONFIG\_ESP\_CONSOLE\_UART\_RX\_GPIO

UART RX on GPIO#

*Found in: Component config > ESP System Settings*

This GPIO is used for UART RX input in the ESP-IDF Bootloader and the app (including default default standard input of the app).

Note: The default ESP-IDF Bootloader configures this pin but doesn't read anything from the UART.

If the configuration is different in the Bootloader binary compared to the app binary, UART is reconfigured after the bootloader exits and the app starts.

**Range:**

- from 0 to 27 if *CONFIG\_ESP\_CONSOLE\_UART\_CUSTOM*

**Default value:**

- 23 if *CONFIG\_ESP\_CONSOLE\_UART\_CUSTOM*
- 44 if *CONFIG\_ESP\_CONSOLE\_UART\_CUSTOM*

### CONFIG\_ESP\_CONSOLE\_UART\_BAUDRATE

UART console baud rate

*Found in: Component config > ESP System Settings*

This baud rate is used by both the ESP-IDF Bootloader and the app (including boot log output and default standard input/output/error of the app).

The app's maximum baud rate depends on the UART clock source. If Power Management is disabled, the UART clock source is the APB clock and all baud rates in the available range will be sufficiently accurate. If Power Management is enabled, REF\_TICK clock source is used so the baud rate is divided from 1MHz. Baud rates above 1Mbps are not possible and values between 500Kbps and 1Mbps may not be accurate.

If the configuration is different in the Bootloader binary compared to the app binary, UART is reconfigured after the bootloader exits and the app starts.

**Range:**

- from 1200 to 1000000 if *CONFIG\_PM\_ENABLE*

**Default value:**

- 115200

### CONFIG\_ESP\_INT\_WDT

Interrupt watchdog

*Found in: [Component config](#) > [ESP System Settings](#)*

This watchdog timer can detect if the FreeRTOS tick interrupt has not been called for a certain time, either because a task turned off interrupts and did not turn them on for a long time, or because an interrupt handler did not return. It will try to invoke the panic handler first and failing that reset the SoC.

**Default value:**

- Yes (enabled)

### CONFIG\_ESP\_INT\_WDT\_TIMEOUT\_MS

Interrupt watchdog timeout (ms)

*Found in: [Component config](#) > [ESP System Settings](#) > [CONFIG\\_ESP\\_INT\\_WDT](#)*

The timeout of the watchdog, in milliseconds. Make this higher than the FreeRTOS tick rate.

**Range:**

- from 10 to 10000

**Default value:**

- 300

### CONFIG\_ESP\_INT\_WDT\_CHECK\_CPU1

Also watch CPU1 tick interrupt

*Found in: [Component config](#) > [ESP System Settings](#) > [CONFIG\\_ESP\\_INT\\_WDT](#)*

Also detect if interrupts on CPU 1 are disabled for too long.

### CONFIG\_ESP\_TASK\_WDT\_EN

Enable Task Watchdog Timer

*Found in: [Component config](#) > [ESP System Settings](#)*

The Task Watchdog Timer can be used to make sure individual tasks are still running. Enabling this option will enable the Task Watchdog Timer. It can be either initialized automatically at startup or initialized after startup (see Task Watchdog Timer API Reference)

**Default value:**

- Yes (enabled)

### CONFIG\_ESP\_TASK\_WDT\_INIT

Initialize Task Watchdog Timer on startup

*Found in: [Component config](#) > [ESP System Settings](#) > [CONFIG\\_ESP\\_TASK\\_WDT\\_EN](#)*

Enabling this option will cause the Task Watchdog Timer to be initialized automatically at startup.

**Default value:**

- Yes (enabled)

### CONFIG\_ESP\_TASK\_WDT\_PANIC

Invoke panic handler on Task Watchdog timeout

*Found in: [Component config](#) > [ESP System Settings](#) > [CONFIG\\_ESP\\_TASK\\_WDT\\_EN](#) > [CONFIG\\_ESP\\_TASK\\_WDT\\_INIT](#)*



If this option is enabled, the Task Watchdog Timer will be configured to trigger the panic handler when it times out. This can also be configured at run time (see Task Watchdog Timer API Reference)

**Default value:**

- No (disabled)

**CONFIG\_ESP\_TASK\_WDT\_TIMEOUT\_S**

Task Watchdog timeout period (seconds)

*Found in: Component config > ESP System Settings > CONFIG\_ESP\_TASK\_WDT\_EN > CONFIG\_ESP\_TASK\_WDT\_INIT*

Timeout period configuration for the Task Watchdog Timer in seconds. This is also configurable at run time (see Task Watchdog Timer API Reference)

**Range:**

- from 1 to 60

**Default value:**

- 5

**CONFIG\_ESP\_TASK\_WDT\_CHECK\_IDLE\_TASK\_CPU0**

Watch CPU0 Idle Task

*Found in: Component config > ESP System Settings > CONFIG\_ESP\_TASK\_WDT\_EN > CONFIG\_ESP\_TASK\_WDT\_INIT*

If this option is enabled, the Task Watchdog Timer will watch the CPU0 Idle Task. Having the Task Watchdog watch the Idle Task allows for detection of CPU starvation as the Idle Task not being called is usually a symptom of CPU starvation. Starvation of the Idle Task is detrimental as FreeRTOS household tasks depend on the Idle Task getting some runtime every now and then.

**Default value:**

- Yes (enabled)

**CONFIG\_ESP\_TASK\_WDT\_CHECK\_IDLE\_TASK\_CPU1**

Watch CPU1 Idle Task

*Found in: Component config > ESP System Settings > CONFIG\_ESP\_TASK\_WDT\_EN > CONFIG\_ESP\_TASK\_WDT\_INIT*

If this option is enabled, the Task Watchdog Timer will watch the CPU1 Idle Task.

**CONFIG\_ESP\_XT\_WDT**

Initialize XTAL32K watchdog timer on startup

*Found in: Component config > ESP System Settings*

This watchdog timer can detect oscillation failure of the XTAL32K\_CLK. When such a failure is detected the hardware can be set up to automatically switch to BACKUP32K\_CLK and generate an interrupt.

**CONFIG\_ESP\_XT\_WDT\_TIMEOUT**

XTAL32K watchdog timeout period

*Found in: Component config > ESP System Settings > CONFIG\_ESP\_XT\_WDT*

Timeout period configuration for the XTAL32K watchdog timer based on RTC\_CLK.

**Range:**

- from 1 to 255 if `CONFIG_ESP_XT_WDT`

**Default value:**

- 200 if `CONFIG_ESP_XT_WDT`

### **CONFIG\_ESP\_XT\_WDT\_BACKUP\_CLK\_ENABLE**

Automatically switch to `BACKUP32K_CLK` when timer expires

*Found in: [Component config](#) > [ESP System Settings](#) > [CONFIG\\_ESP\\_XT\\_WDT](#)*

Enable this to automatically switch to `BACKUP32K_CLK` as the source of `RTC_SLOW_CLK` when the watchdog timer expires.

**Default value:**

- Yes (enabled) if `CONFIG_ESP_XT_WDT`

### **CONFIG\_ESP\_PANIC\_HANDLER\_IRAM**

Place panic handler code in IRAM

*Found in: [Component config](#) > [ESP System Settings](#)*

If this option is disabled (default), the panic handler code is placed in flash not IRAM. This means that if ESP-IDF crashes while flash cache is disabled, the panic handler will automatically re-enable flash cache before running GDB Stub or Core Dump. This adds some minor risk, if the flash cache status is also corrupted during the crash.

If this option is enabled, the panic handler code (including required UART functions) is placed in IRAM. This may be necessary to debug some complex issues with crashes while flash cache is disabled (for example, when writing to SPI flash) or when flash cache is corrupted when an exception is triggered.

**Default value:**

- No (disabled)

### **CONFIG\_ESP\_DEBUG\_STUBS\_ENABLE**

OpenOCD debug stubs

*Found in: [Component config](#) > [ESP System Settings](#)*

Debug stubs are used by OpenOCD to execute pre-compiled onboard code which does some useful debugging stuff, e.g. GCOV data dump.

### **CONFIG\_ESP\_DEBUG\_OCDAWARE**

Make exception and panic handlers JTAG/OCD aware

*Found in: [Component config](#) > [ESP System Settings](#)*

The FreeRTOS panic and unhandled exception handlers can detect a JTAG OCD debugger and instead of panicking, have the debugger stop on the offending instruction.

**Default value:**

- Yes (enabled)

### **CONFIG\_ESP\_SYSTEM\_CHECK\_INT\_LEVEL**

Interrupt level to use for Interrupt Watchdog and other system checks

*Found in: [Component config](#) > [ESP System Settings](#)*

Interrupt level to use for Interrupt Watchdog, `IPC_ISR` and other system checks.

Available options:

- Level 5 interrupt (CONFIG\_ESP\_SYSTEM\_CHECK\_INT\_LEVEL\_5)  
Using level 5 interrupt for Interrupt Watchdog, IPC\_ISR and other system checks.
- Level 4 interrupt (CONFIG\_ESP\_SYSTEM\_CHECK\_INT\_LEVEL\_4)  
Using level 4 interrupt for Interrupt Watchdog, IPC\_ISR and other system checks.

**Brownout Detector** Contains:

- *CONFIG\_ESP\_BROWNOUT\_DET*

### CONFIG\_ESP\_BROWNOUT\_DET

Hardware brownout detect & reset

*Found in: Component config > ESP System Settings > Brownout Detector*

The ESP32-H2 has a built-in brownout detector which can detect if the voltage is lower than a specific value. If this happens, it will reset the chip in order to prevent unintended behaviour.

**Default value:**

- Yes (enabled)

### CONFIG\_ESP\_BROWNOUT\_DET\_LVL\_SEL

Brownout voltage level

*Found in: Component config > ESP System Settings > Brownout Detector > CONFIG\_ESP\_BROWNOUT\_DET*

The brownout detector will reset the chip when the supply voltage is approximately below this level. Note that there may be some variation of brownout voltage level between each chip.

#The voltage levels here are estimates, more work needs to be done to figure out the exact voltages #of the brownout threshold levels.

Available options:

- 2.94V (CONFIG\_ESP\_BROWNOUT\_DET\_LVL\_SEL\_7)
- 2.88V (CONFIG\_ESP\_BROWNOUT\_DET\_LVL\_SEL\_6)
- 2.83V (CONFIG\_ESP\_BROWNOUT\_DET\_LVL\_SEL\_5)
- 2.78V (CONFIG\_ESP\_BROWNOUT\_DET\_LVL\_SEL\_4)
- 2.73V (CONFIG\_ESP\_BROWNOUT\_DET\_LVL\_SEL\_3)
- 2.67V (CONFIG\_ESP\_BROWNOUT\_DET\_LVL\_SEL\_2)
- 2.62V (CONFIG\_ESP\_BROWNOUT\_DET\_LVL\_SEL\_1)
- 2.57V (CONFIG\_ESP\_BROWNOUT\_DET\_LVL\_SEL\_0)

### CONFIG\_ESP\_SYSTEM\_HW\_STACK\_GUARD

Hardware stack guard

*Found in: Component config > ESP System Settings*

This config allows to trigger a panic interrupt when Stack Pointer register goes out of allocated stack memory bounds.

**Default value:**

- Yes (enabled)

### CONFIG\_ESP\_SYSTEM\_BBPLL\_RECALIB

Re-calibration BBPLL at startup

*Found in: Component config > ESP System Settings*

This configuration helps to address an BBPLL inaccurate issue when boot from certain bootloader version, which may increase about the boot-up time by about 200 us. Disable this when your bootloader is built with ESP-IDF version v5.2 and above.

**Default value:**

- Yes (enabled)

### CONFIG\_ESP\_SYSTEM\_HW\_PC\_RECORD

Hardware PC recording

*Found in: Component config > ESP System Settings*

This option will enable the PC recording function of assist\_debug module. The PC value of the CPU will be recorded to PC record register in assist\_debug module in real time. When an exception occurs and the CPU is reset, this register will be kept, then we can use the recorded PC to debug the causes of the reset.

**Default value:**

- Yes (enabled)

**IPC (Inter-Processor Call)** Contains:

- [CONFIG\\_ESP\\_IPC\\_TASK\\_STACK\\_SIZE](#)
- [CONFIG\\_ESP\\_IPC\\_USES\\_CALLERS\\_PRIORITY](#)

### CONFIG\_ESP\_IPC\_TASK\_STACK\_SIZE

Inter-Processor Call (IPC) task stack size

*Found in: Component config > IPC (Inter-Processor Call)*

Configure the IPC tasks stack size. An IPC task runs on each core (in dual core mode), and allows for cross-core function calls. See IPC documentation for more details. The default IPC stack size should be enough for most common simple use cases. However, users can increase/decrease the stack size to their needs.

**Range:**

- from 512 to 65536

**Default value:**

- 1024

### CONFIG\_ESP\_IPC\_USES\_CALLERS\_PRIORITY

IPC runs at caller's priority

*Found in: Component config > IPC (Inter-Processor Call)*

If this option is not enabled then the IPC task will keep behavior same as prior to that of ESP-IDF v4.0, hence IPC task will run at (configMAX\_PRIORITIES - 1) priority.

**ESP Timer (High Resolution Timer)** Contains:

- [CONFIG\\_ESP\\_TIMER\\_PROFILING](#)
- [CONFIG\\_ESP\\_TIMER\\_TASK\\_AFFINITY](#)
- [CONFIG\\_ESP\\_TIMER\\_TASK\\_STACK\\_SIZE](#)
- [CONFIG\\_ESP\\_TIMER\\_INTERRUPT\\_LEVEL](#)

- `CONFIG_ESP_TIMER_SHOW_EXPERIMENTAL`
- `CONFIG_ESP_TIMER_SUPPORTS_ISR_DISPATCH_METHOD`
- `CONFIG_ESP_TIMER_ISR_AFFINITY`

### **CONFIG\_ESP\_TIMER\_PROFILING**

Enable esp\_timer profiling features

*Found in: Component config > ESP Timer (High Resolution Timer)*

If enabled, esp\_timer\_dump will dump information such as number of times the timer was started, number of times the timer has triggered, and the total time it took for the callback to run. This option has some effect on timer performance and the amount of memory used for timer storage, and should only be used for debugging/testing purposes.

**Default value:**

- No (disabled)

### **CONFIG\_ESP\_TIMER\_TASK\_STACK\_SIZE**

High-resolution timer task stack size

*Found in: Component config > ESP Timer (High Resolution Timer)*

Configure the stack size of "timer\_task" task. This task is used to dispatch callbacks of timers created using ets\_timer and esp\_timer APIs. If you are seeing stack overflow errors in timer task, increase this value.

Note that this is not the same as FreeRTOS timer task. To configure FreeRTOS timer task size, see "FreeRTOS timer task stack size" option in "FreeRTOS".

**Range:**

- from 2048 to 65536

**Default value:**

- 3584

### **CONFIG\_ESP\_TIMER\_INTERRUPT\_LEVEL**

Interrupt level

*Found in: Component config > ESP Timer (High Resolution Timer)*

This sets the interrupt priority level for esp\_timer ISR. A higher value reduces interrupt latency by minimizing the timer processing delay.

**Range:**

- from 1 to 1

**Default value:**

- 1

### **CONFIG\_ESP\_TIMER\_SHOW\_EXPERIMENTAL**

show esp\_timer's experimental features

*Found in: Component config > ESP Timer (High Resolution Timer)*

This shows some hidden features of esp\_timer. Note that they may break other features, use them with care.

## CONFIG\_ESP\_TIMER\_TASK\_AFFINITY

esp\_timer task core affinity

*Found in: Component config > ESP Timer (High Resolution Timer)*

The default settings: timer TASK on CPU0 and timer ISR on CPU0. Other settings may help in certain cases, but note that they may break other features, use them with care. - "CPU0": (default) esp\_timer task is processed by CPU0. - "CPU1": esp\_timer task is processed by CPU1. - "No affinity": esp\_timer task can be processed by any CPU.

Available options:

- CPU0 (CONFIG\_ESP\_TIMER\_TASK\_AFFINITY\_CPU0)
- CPU1 (CONFIG\_ESP\_TIMER\_TASK\_AFFINITY\_CPU1)
- No affinity (CONFIG\_ESP\_TIMER\_TASK\_AFFINITY\_NO\_AFFINITY)

## CONFIG\_ESP\_TIMER\_ISR\_AFFINITY

timer interrupt core affinity

*Found in: Component config > ESP Timer (High Resolution Timer)*

The default settings: timer TASK on CPU0 and timer ISR on CPU0. Other settings may help in certain cases, but note that they may break other features, use them with care. - "CPU0": (default) timer interrupt is processed by CPU0. - "CPU1": timer interrupt is processed by CPU1. - "No affinity": timer interrupt can be processed by any CPU. It helps to reduce latency but there is a disadvantage it leads to the timer ISR running on every core. It increases the CPU time usage for timer ISRs by N on an N-core system.

Available options:

- CPU0 (CONFIG\_ESP\_TIMER\_ISR\_AFFINITY\_CPU0)
- CPU1 (CONFIG\_ESP\_TIMER\_ISR\_AFFINITY\_CPU1)
- No affinity (CONFIG\_ESP\_TIMER\_ISR\_AFFINITY\_NO\_AFFINITY)

## CONFIG\_ESP\_TIMER\_SUPPORTS\_ISR\_DISPATCH\_METHOD

Support ISR dispatch method

*Found in: Component config > ESP Timer (High Resolution Timer)*

Allows using ESP\_TIMER\_ISR dispatch method (ESP\_TIMER\_TASK dispatch method is also available). - ESP\_TIMER\_TASK - Timer callbacks are dispatched from a high-priority esp\_timer task. - ESP\_TIMER\_ISR - Timer callbacks are dispatched directly from the timer interrupt handler. The ISR dispatch can be used, in some cases, when a callback is very simple or need a lower-latency.

**Default value:**

- No (disabled)

**Wi-Fi** Contains:

- [CONFIG\\_ESP\\_WIFI\\_TESTING\\_OPTIONS](#)
- [CONFIG\\_ESP\\_WIFI\\_WPS\\_SOFTAP\\_REGISTRAR](#)
- [CONFIG\\_ESP\\_WIFI\\_ENABLE\\_ROAMING\\_APP](#)
- [CONFIG\\_ESP\\_WIFI\\_11KV\\_SUPPORT](#)
- [CONFIG\\_ESP\\_WIFI\\_11R\\_SUPPORT](#)
- [CONFIG\\_ESP\\_WIFI\\_DPP\\_SUPPORT](#)
- [CONFIG\\_ESP\\_WIFI\\_ENTERPRISE\\_SUPPORT](#)
- [CONFIG\\_ESP\\_WIFI\\_MBO\\_SUPPORT](#)

- `CONFIG_ESP_WIFI_SUITE_B_192`
- `CONFIG_ESP_WIFI_ENABLE_WPA3_OWE_STA`
- `CONFIG_ESP_WIFI_WAPI_PSK`
- `CONFIG_ESP_WIFI_ENABLE_DUMP_CTRL_BFRP`
- `CONFIG_ESP_WIFI_ENABLE_DUMP_HESIGB`
- `CONFIG_ESP_WIFI_ENABLE_DUMP_MU_CFO`
- `CONFIG_ESP_WIFI_ENABLE_DUMP_CTRL_NDPA`
- `CONFIG_ESP_WIFI_ENABLE_WIFI_RX_STATS`
- `CONFIG_ESP_WIFI_ENABLE_WIFI_TX_STATS`
- `CONFIG_ESP_WIFI_ENABLE_WPA3_SAE`
- `CONFIG_ESP_HOST_WIFI_ENABLED`
- `CONFIG_ESP_WIFI_SOFTAP_BEACON_MAX_LEN`
- `CONFIG_ESP_WIFI_CACHE_TX_BUFFER_NUM`
- `CONFIG_ESP_WIFI_DYNAMIC_RX_BUFFER_NUM`
- `CONFIG_ESP_WIFI_DYNAMIC_TX_BUFFER_NUM`
- `CONFIG_ESP_WIFI_RX_MGMT_BUF_NUM_DEF`
- `CONFIG_ESP_WIFI_STATIC_RX_BUFFER_NUM`
- `CONFIG_ESP_WIFI_STATIC_TX_BUFFER_NUM`
- `CONFIG_ESP_WIFI_ESPNOW_MAX_ENCRYPT_NUM`
- `CONFIG_ESP_WIFI_SLP_DEFAULT_MAX_ACTIVE_TIME`
- `CONFIG_ESP_WIFI_SLP_DEFAULT_MIN_ACTIVE_TIME`
- `CONFIG_ESP_WIFI_SLP_DEFAULT_WAIT_BROADCAST_DATA_TIME`
- `CONFIG_ESP_WIFI_STA_DISCONNECTED_PM_ENABLE`
- `CONFIG_ESP_WIFI_DEBUG_PRINT`
- `CONFIG_ESP_WIFI_MGMT_RX_BUFFER`
- `CONFIG_ESP_WIFI_TX_BUFFER`
- `CONFIG_ESP_WIFI_MBEDTLS_CRYPT`
- `CONFIG_ESP_WIFI_AMPDU_RX_ENABLED`
- `CONFIG_ESP_WIFI_AMPDU_TX_ENABLED`
- `CONFIG_ESP_WIFI_AMSDU_TX_ENABLED`
- `CONFIG_ESP_WIFI_NAN_ENABLE`
- `CONFIG_ESP_WIFI_CSI_ENABLED`
- `CONFIG_ESP_WIFI_EXTRA_IRAM_OPT`
- `CONFIG_ESP_WIFI_FTM_ENABLE`
- `CONFIG_ESP_WIFI_GCMP_SUPPORT`
- `CONFIG_ESP_WIFI_GMAC_SUPPORT`
- `CONFIG_ESP_WIFI_IRAM_OPT`
- `CONFIG_ESP_WIFI_MGMT_SBUF_NUM`
- `CONFIG_ESP_WIFI_ENHANCED_LIGHT_SLEEP`
- `CONFIG_ESP_WIFI_NVS_ENABLED`
- `CONFIG_ESP_WIFI_RX_IRAM_OPT`
- `CONFIG_ESP_WIFI_SLP_BEACON_LOST_OPT`
- `CONFIG_ESP_WIFI_SLP_IRAM_OPT`
- `CONFIG_ESP_WIFI_SOFTAP_SUPPORT`
- `CONFIG_ESP_WIFI_TASK_CORE_ID`
- `CONFIG_ESP_WIFI_TX_HETB_QUEUE_NUM`
- *WPS Configuration Options*

### **CONFIG\_ESP\_HOST\_WIFI\_ENABLED**

Host WiFi Enable

*Found in: Component config > Wi-Fi*

**Default value:**

- No (disabled) if `SOC_WIRELESS_HOST_SUPPORTED`

### **CONFIG\_ESP\_WIFI\_STATIC\_RX\_BUFFER\_NUM**

Max number of WiFi static RX buffers

*Found in: [Component config](#) > [Wi-Fi](#)*

Set the number of WiFi static RX buffers. Each buffer takes approximately 1.6KB of RAM. The static rx buffers are allocated when `esp_wifi_init` is called, they are not freed until `esp_wifi_deinit` is called.

WiFi hardware use these buffers to receive all 802.11 frames. A higher number may allow higher throughput but increases memory use. If `ESP_WIFI_AMPDU_RX_ENABLED` is enabled, this value is recommended to set equal or bigger than `ESP_WIFI_RX_BA_WIN` in order to achieve better throughput and compatibility with both stations and APs.

**Range:**

- from 2 to 128 if `SOC_WIFI_HE_SUPPORT` && `CONFIG_ESP_HOST_WIFI_ENABLED`

**Default value:**

- 16 if `SPIRAM_TRY_ALLOCATE_WIFI_LWIP` && `CONFIG_ESP_HOST_WIFI_ENABLED`

## CONFIG\_ESP\_WIFI\_DYNAMIC\_RX\_BUFFER\_NUM

Max number of WiFi dynamic RX buffers

*Found in: [Component config](#) > [Wi-Fi](#)*

Set the number of WiFi dynamic RX buffers, 0 means unlimited RX buffers will be allocated (provided sufficient free RAM). The size of each dynamic RX buffer depends on the size of the received data frame.

For each received data frame, the WiFi driver makes a copy to an RX buffer and then delivers it to the high layer TCP/IP stack. The dynamic RX buffer is freed after the higher layer has successfully received the data frame.

For some applications, WiFi data frames may be received faster than the application can process them. In these cases we may run out of memory if RX buffer number is unlimited (0).

If a dynamic RX buffer limit is set, it should be at least the number of static RX buffers.

**Range:**

- from 0 to 1024 if `CONFIG_LWIP_WND_SCALE` && `CONFIG_ESP_HOST_WIFI_ENABLED`

**Default value:**

- 32 if `CONFIG_ESP_HOST_WIFI_ENABLED`

## CONFIG\_ESP\_WIFI\_TX\_BUFFER

Type of WiFi TX buffers

*Found in: [Component config](#) > [Wi-Fi](#)*

Select type of WiFi TX buffers:

If "Static" is selected, WiFi TX buffers are allocated when WiFi is initialized and released when WiFi is de-initialized. The size of each static TX buffer is fixed to about 1.6KB.

If "Dynamic" is selected, each WiFi TX buffer is allocated as needed when a data frame is delivered to the Wifi driver from the TCP/IP stack. The buffer is freed after the data frame has been sent by the WiFi driver. The size of each dynamic TX buffer depends on the length of each data frame sent by the TCP/IP layer.

If PSRAM is enabled, "Static" should be selected to guarantee enough WiFi TX buffers. If PSRAM is disabled, "Dynamic" should be selected to improve the utilization of RAM.

Available options:

- Static (`CONFIG_ESP_WIFI_STATIC_TX_BUFFER`)
- Dynamic (`CONFIG_ESP_WIFI_DYNAMIC_TX_BUFFER`)



## CONFIG\_ESP\_WIFI\_STATIC\_TX\_BUFFER\_NUM

Max number of WiFi static TX buffers

Found in: *Component config > Wi-Fi*

Set the number of WiFi static TX buffers. Each buffer takes approximately 1.6KB of RAM. The static RX buffers are allocated when `esp_wifi_init()` is called, they are not released until `esp_wifi_deinit()` is called.

For each transmitted data frame from the higher layer TCP/IP stack, the WiFi driver makes a copy of it in a TX buffer. For some applications especially UDP applications, the upper layer can deliver frames faster than WiFi layer can transmit. In these cases, we may run out of TX buffers.

**Range:**

- from 1 to 64 if `CONFIG_ESP_WIFI_STATIC_TX_BUFFER` && `CONFIG_ESP_HOST_WIFI_ENABLED`

**Default value:**

- 16 if `CONFIG_ESP_WIFI_STATIC_TX_BUFFER` && `CONFIG_ESP_HOST_WIFI_ENABLED`

## CONFIG\_ESP\_WIFI\_CACHE\_TX\_BUFFER\_NUM

Max number of WiFi cache TX buffers

Found in: *Component config > Wi-Fi*

Set the number of WiFi cache TX buffer number.

For each TX packet from uplayer, such as LWIP etc, WiFi driver needs to allocate a static TX buffer and makes a copy of uplayer packet. If WiFi driver fails to allocate the static TX buffer, it caches the uplayer packets to a dedicated buffer queue, this option is used to configure the size of the cached TX queue.

**Range:**

- from 16 to 128 if SPIRAM && `CONFIG_ESP_HOST_WIFI_ENABLED`

**Default value:**

- 32 if SPIRAM && `CONFIG_ESP_HOST_WIFI_ENABLED`

## CONFIG\_ESP\_WIFI\_DYNAMIC\_TX\_BUFFER\_NUM

Max number of WiFi dynamic TX buffers

Found in: *Component config > Wi-Fi*

Set the number of WiFi dynamic TX buffers. The size of each dynamic TX buffer is not fixed, it depends on the size of each transmitted data frame.

For each transmitted frame from the higher layer TCP/IP stack, the WiFi driver makes a copy of it in a TX buffer. For some applications, especially UDP applications, the upper layer can deliver frames faster than WiFi layer can transmit. In these cases, we may run out of TX buffers.

**Range:**

- from 1 to 128 if `CONFIG_ESP_WIFI_DYNAMIC_TX_BUFFER` && `CONFIG_ESP_HOST_WIFI_ENABLED`

**Default value:**

- 32 if `CONFIG_ESP_WIFI_DYNAMIC_TX_BUFFER` && `CONFIG_ESP_HOST_WIFI_ENABLED`

## CONFIG\_ESP\_WIFI\_MGMT\_RX\_BUFFER

Type of WiFi RX MGMT buffers

Found in: *Component config > Wi-Fi*

Select type of WiFi RX MGMT buffers:

If "Static" is selected, WiFi RX MGMT buffers are allocated when WiFi is initialized and released when WiFi is de-initialized. The size of each static RX MGMT buffer is fixed to about 500 Bytes.

If "Dynamic" is selected, each WiFi RX MGMT buffer is allocated as needed when a MGMT data frame is received. The MGMT buffer is freed after the MGMT data frame has been processed by the WiFi driver.

Available options:

- Static (CONFIG\_ESP\_WIFI\_STATIC\_RX\_MGMT\_BUFFER)
- Dynamic (CONFIG\_ESP\_WIFI\_DYNAMIC\_RX\_MGMT\_BUFFER)

### CONFIG\_ESP\_WIFI\_RX\_MGMT\_BUF\_NUM\_DEF

Max number of WiFi RX MGMT buffers

*Found in: [Component config](#) > [Wi-Fi](#)*

Set the number of WiFi RX\_MGMT buffers.

For Management buffers, the number of dynamic and static management buffers is the same. In order to prevent memory fragmentation, the management buffer type should be set to static first.

**Range:**

- from 1 to 10 if [CONFIG\\_ESP\\_HOST\\_WIFI\\_ENABLED](#)

**Default value:**

- 5 if [CONFIG\\_ESP\\_HOST\\_WIFI\\_ENABLED](#)

### CONFIG\_ESP\_WIFI\_CSI\_ENABLED

WiFi CSI(Channel State Information)

*Found in: [Component config](#) > [Wi-Fi](#)*

Select this option to enable CSI(Channel State Information) feature. CSI takes about CONFIG\_ESP\_WIFI\_STATIC\_RX\_BUFFER\_NUM KB of RAM. If CSI is not used, it is better to disable this feature in order to save memory.

**Default value:**

- No (disabled) if SOC\_WIFI\_CSI\_SUPPORT && [CONFIG\\_ESP\\_HOST\\_WIFI\\_ENABLED](#)

### CONFIG\_ESP\_WIFI\_AMPDU\_TX\_ENABLED

WiFi AMPDU TX

*Found in: [Component config](#) > [Wi-Fi](#)*

Select this option to enable AMPDU TX feature

**Default value:**

- Yes (enabled) if [CONFIG\\_ESP\\_HOST\\_WIFI\\_ENABLED](#)

### CONFIG\_ESP\_WIFI\_TX\_BA\_WIN

WiFi AMPDU TX BA window size

*Found in: [Component config](#) > [Wi-Fi](#) > [CONFIG\\_ESP\\_WIFI\\_AMPDU\\_TX\\_ENABLED](#)*

Set the size of WiFi Block Ack TX window. Generally a bigger value means higher throughput but more memory. Most of time we should NOT change the default value unless special reason, e.g. test the maximum UDP TX throughput with iperf etc. For iperf test in shieldbox, the recommended value is 9~12.

**Range:**

- from 2 to 64 if `SOC_WIFI_HE_SUPPORT` && `CONFIG_ESP_WIFI_AMPDU_TX_ENABLED` && `CONFIG_ESP_HOST_WIFI_ENABLED`

**Default value:**

- 6 if `CONFIG_ESP_WIFI_AMPDU_TX_ENABLED` && `CONFIG_ESP_HOST_WIFI_ENABLED`

**CONFIG\_ESP\_WIFI\_AMPDU\_RX\_ENABLED**

WiFi AMPDU RX

*Found in: Component config > Wi-Fi*

Select this option to enable AMPDU RX feature

**Default value:**

- Yes (enabled) if `CONFIG_ESP_HOST_WIFI_ENABLED`

**CONFIG\_ESP\_WIFI\_RX\_BA\_WIN**

WiFi AMPDU RX BA window size

*Found in: Component config > Wi-Fi > CONFIG\_ESP\_WIFI\_AMPDU\_RX\_ENABLED*

Set the size of WiFi Block Ack RX window. Generally a bigger value means higher throughput and better compatibility but more memory. Most of time we should NOT change the default value unless special reason, e.g. test the maximum UDP RX throughput with iperf etc. For iperf test in shieldbox, the recommended value is 9~12. If PSRAM is used and WiFi memory is preferred to allocate in PSRAM first, the default and minimum value should be 16 to achieve better throughput and compatibility with both stations and APs.

**Range:**

- from 2 to 64 if `SOC_WIFI_HE_SUPPORT` && `CONFIG_ESP_WIFI_AMPDU_RX_ENABLED` && `CONFIG_ESP_HOST_WIFI_ENABLED`

**Default value:**

- 16 if `SPIRAM_TRY_ALLOCATE_WIFI_LWIP` && `CONFIG_ESP_WIFI_AMPDU_RX_ENABLED` && `CONFIG_ESP_HOST_WIFI_ENABLED`

**CONFIG\_ESP\_WIFI\_AMSDU\_TX\_ENABLED**

WiFi AMSDU TX

*Found in: Component config > Wi-Fi*

Select this option to enable AMSDU TX feature

**Default value:**

- No (disabled) if `SPIRAM` && `CONFIG_ESP_HOST_WIFI_ENABLED`

**CONFIG\_ESP\_WIFI\_NVS\_ENABLED**

WiFi NVS flash

*Found in: Component config > Wi-Fi*

Select this option to enable WiFi NVS flash

**Default value:**

- Yes (enabled) if `CONFIG_ESP_HOST_WIFI_ENABLED`

### CONFIG\_ESP\_WIFI\_TASK\_CORE\_ID

WiFi Task Core ID

Found in: [Component config](#) > [Wi-Fi](#)

Pinned WiFi task to core 0 or core 1.

Available options:

- Core 0 (`CONFIG_ESP_WIFI_TASK_PINNED_TO_CORE_0`)
- Core 1 (`CONFIG_ESP_WIFI_TASK_PINNED_TO_CORE_1`)

### CONFIG\_ESP\_WIFI\_SOFTAP\_BEACON\_MAX\_LEN

Max length of WiFi SoftAP Beacon

Found in: [Component config](#) > [Wi-Fi](#)

ESP-MESH utilizes beacon frames to detect and resolve root node conflicts (see documentation). However the default length of a beacon frame can simultaneously hold only five root node identifier structures, meaning that a root node conflict of up to five nodes can be detected at one time. In the occurrence of more root nodes conflict involving more than five root nodes, the conflict resolution process will detect five of the root nodes, resolve the conflict, and re-detect more root nodes. This process will repeat until all root node conflicts are resolved. However this process can generally take a very long time.

To counter this situation, the beacon frame length can be increased such that more root nodes can be detected simultaneously. Each additional root node will require 36 bytes and should be added on top of the default beacon frame length of 752 bytes. For example, if you want to detect 10 root nodes simultaneously, you need to set the beacon frame length as 932 ( $752+36*5$ ).

Setting a longer beacon length also assists with debugging as the conflicting root nodes can be identified more quickly.

**Range:**

- from 752 to 1256 if `CONFIG_ESP_HOST_WIFI_ENABLED`

**Default value:**

- 752 if `CONFIG_ESP_HOST_WIFI_ENABLED`

### CONFIG\_ESP\_WIFI\_MGMT\_SBUF\_NUM

WiFi mgmt short buffer number

Found in: [Component config](#) > [Wi-Fi](#)

Set the number of WiFi management short buffer.

**Range:**

- from 6 to 32 if `CONFIG_ESP_HOST_WIFI_ENABLED`

**Default value:**

- 32 if `CONFIG_ESP_HOST_WIFI_ENABLED`

### CONFIG\_ESP\_WIFI\_IRAM\_OPT

WiFi IRAM speed optimization

Found in: [Component config](#) > [Wi-Fi](#)

Select this option to place frequently called Wi-Fi library functions in IRAM. When this option is disabled, more than 10Kbytes of IRAM memory will be saved but Wi-Fi throughput will be reduced.

**Default value:**

- Yes (enabled) if `CONFIG_ESP_HOST_WIFI_ENABLED`

**CONFIG\_ESP\_WIFI\_EXTRA\_IRAM\_OPT**

WiFi EXTRA IRAM speed optimization

Found in: *Component config* > *Wi-Fi*

Select this option to place additional frequently called Wi-Fi library functions in IRAM. When this option is disabled, more than 5Kbytes of IRAM memory will be saved but Wi-Fi throughput will be reduced.

**Default value:**

- Yes (enabled) if `SOC_WIFI_HE_SUPPORT` && `CONFIG_ESP_HOST_WIFI_ENABLED`
- No (disabled) if `CONFIG_ESP_HOST_WIFI_ENABLED`

**CONFIG\_ESP\_WIFI\_RX\_IRAM\_OPT**

WiFi RX IRAM speed optimization

Found in: *Component config* > *Wi-Fi*

Select this option to place frequently called Wi-Fi library RX functions in IRAM. When this option is disabled, more than 17Kbytes of IRAM memory will be saved but Wi-Fi performance will be reduced.

**Default value:**

- Yes (enabled) if `CONFIG_ESP_HOST_WIFI_ENABLED`

**CONFIG\_ESP\_WIFI\_ENABLE\_WPA3\_SAE**

Enable WPA3-Personal

Found in: *Component config* > *Wi-Fi*

Select this option to allow the device to establish a WPA3-Personal connection with eligible AP's. PMF (Protected Management Frames) is a prerequisite feature for a WPA3 connection, it needs to be explicitly configured before attempting connection. Please refer to the Wi-Fi Driver API Guide for details.

**Default value:**

- Yes (enabled) if `CONFIG_ESP_HOST_WIFI_ENABLED`

**CONFIG\_ESP\_WIFI\_ENABLE\_SAE\_PK**

Enable SAE-PK

Found in: *Component config* > *Wi-Fi* > `CONFIG_ESP_WIFI_ENABLE_WPA3_SAE`

Select this option to enable SAE-PK

**Default value:**

- Yes (enabled) if `CONFIG_ESP_WIFI_ENABLE_WPA3_SAE` && `CONFIG_ESP_HOST_WIFI_ENABLED`

**CONFIG\_ESP\_WIFI\_SOFTAP\_SAE\_SUPPORT**

Enable WPA3 Personal(SAE) SoftAP

Found in: *Component config* > *Wi-Fi* > `CONFIG_ESP_WIFI_ENABLE_WPA3_SAE`

Select this option to enable SAE support in softAP mode.

**Default value:**

- Yes (enabled) if `CONFIG_ESP_WIFI_ENABLE_WPA3_SAE` && `CONFIG_ESP_WIFI_SOFTAP_SUPPORT` && `CONFIG_ESP_HOST_WIFI_ENABLED`

### CONFIG\_ESP\_WIFI\_ENABLE\_WPA3\_OWE\_STA

Enable OWE STA

Found in: *Component config > Wi-Fi*

Select this option to allow the device to establish OWE connection with eligible AP's. PMF (Protected Management Frames) is a prerequisite feature for a WPA3 connection, it needs to be explicitly configured before attempting connection. Please refer to the Wi-Fi Driver API Guide for details.

**Default value:**

- Yes (enabled) if *CONFIG\_ESP\_HOST\_WIFI\_ENABLED*

### CONFIG\_ESP\_WIFI\_SLP\_IRAM\_OPT

WiFi SLP IRAM speed optimization

Found in: *Component config > Wi-Fi*

Select this option to place called Wi-Fi library TBTT process and receive beacon functions in IRAM. Some functions can be put in IRAM either by ESP\_WIFI\_IRAM\_OPT and ESP\_WIFI\_RX\_IRAM\_OPT, or this one. If already enabled ESP\_WIFI\_IRAM\_OPT, the other 7.3KB IRAM memory would be taken by this option. If already enabled ESP\_WIFI\_RX\_IRAM\_OPT, the other 1.3KB IRAM memory would be taken by this option. If neither of them are enabled, the other 7.4KB IRAM memory would be taken by this option. Wi-Fi power-save mode average current would be reduced if this option is enabled.

**Default value:**

- Yes (enabled) if SOC\_WIFI\_HE\_SUPPORT && *CONFIG\_ESP\_HOST\_WIFI\_ENABLED*

### CONFIG\_ESP\_WIFI\_SLP\_DEFAULT\_MIN\_ACTIVE\_TIME

Minimum active time

Found in: *Component config > Wi-Fi*

Only for station in WIFI\_PS\_MIN\_MODEM or WIFI\_PS\_MAX\_MODEM. When the station enters the active state, it will work for at least ESP\_WIFI\_SLP\_DEFAULT\_MIN\_ACTIVE\_TIME. If a data packet is received or sent during this period, the time will be refreshed. If the time is up, but the station still has packets to receive or send, the time will also be refreshed. unit: milliseconds.

**Range:**

- from 8 to 60 if *CONFIG\_ESP\_HOST\_WIFI\_ENABLED*

**Default value:**

- 50 if *CONFIG\_ESP\_HOST\_WIFI\_ENABLED*

### CONFIG\_ESP\_WIFI\_SLP\_DEFAULT\_MAX\_ACTIVE\_TIME

Maximum keep alive time

Found in: *Component config > Wi-Fi*

Only for station in WIFI\_PS\_MIN\_MODEM or WIFI\_PS\_MAX\_MODEM. If no packet has been sent within ESP\_WIFI\_SLP\_DEFAULT\_MAX\_ACTIVE\_TIME, a null data packet will be sent to maintain the connection with the AP. unit: seconds.

**Range:**

- from 10 to 60 if *CONFIG\_ESP\_HOST\_WIFI\_ENABLED*

**Default value:**

- 10 if *CONFIG\_ESP\_HOST\_WIFI\_ENABLED*

### CONFIG\_ESP\_WIFI\_SLP\_DEFAULT\_WAIT\_BROADCAST\_DATA\_TIME

Minimum wait broadcast data time

Found in: *Component config* > *Wi-Fi*

Only for station in WIFI\_PS\_MIN\_MODEM or WIFI\_PS\_MAX\_MODEM. When the station knows through the beacon that AP will send broadcast packet, it will wait for ESP\_WIFI\_SLP\_DEFAULT\_WAIT\_BROADCAST\_DATA\_TIME before entering the sleep process. If a broadcast packet is received with more data bits, the time will refreshed. unit: milliseconds.

**Range:**

- from 10 to 30 if *CONFIG\_ESP\_HOST\_WIFI\_ENABLED*

**Default value:**

- 15 if *CONFIG\_ESP\_HOST\_WIFI\_ENABLED*

### CONFIG\_ESP\_WIFI\_FTM\_ENABLE

WiFi FTM

Found in: *Component config* > *Wi-Fi*

Enable feature Fine Timing Measurement for calculating WiFi Round-Trip-Time (RTT).

**Default value:**

- No (disabled) if *SOC\_WIFI\_FTM\_SUPPORT* && *CONFIG\_ESP\_HOST\_WIFI\_ENABLED*

### CONFIG\_ESP\_WIFI\_FTM\_INITIATOR\_SUPPORT

FTM Initiator support

Found in: *Component config* > *Wi-Fi* > *CONFIG\_ESP\_WIFI\_FTM\_ENABLE*

**Default value:**

- Yes (enabled) if *CONFIG\_ESP\_WIFI\_FTM\_ENABLE* && *CONFIG\_ESP\_HOST\_WIFI\_ENABLED*

### CONFIG\_ESP\_WIFI\_FTM\_RESPONDER\_SUPPORT

FTM Responder support

Found in: *Component config* > *Wi-Fi* > *CONFIG\_ESP\_WIFI\_FTM\_ENABLE*

**Default value:**

- Yes (enabled) if *CONFIG\_ESP\_WIFI\_FTM\_ENABLE* && *CONFIG\_ESP\_HOST\_WIFI\_ENABLED*

### CONFIG\_ESP\_WIFI\_STA\_DISCONNECTED\_PM\_ENABLE

Power Management for station at disconnected

Found in: *Component config* > *Wi-Fi*

Select this option to enable power\_management for station when disconnected. Chip will do modem-sleep when rf module is not in use any more.

**Default value:**

- Yes (enabled) if *CONFIG\_ESP\_HOST\_WIFI\_ENABLED*

**CONFIG\_ESP\_WIFI\_GCMP\_SUPPORT**

WiFi GCMP Support(GCMP128 and GCMP256)

Found in: *Component config > Wi-Fi*

Select this option to enable GCMP support. GCMP support is compulsory for WiFi Suite-B support.

**Default value:**

- No (disabled) if `SOC_WIFI_GCMP_SUPPORT` && `CONFIG_ESP_HOST_WIFI_ENABLED`

**CONFIG\_ESP\_WIFI\_GMAC\_SUPPORT**

WiFi GMAC Support(GMAC128 and GMAC256)

Found in: *Component config > Wi-Fi*

Select this option to enable GMAC support. GMAC support is compulsory for WiFi 192 bit certification.

**Default value:**

- Yes (enabled) if `CONFIG_ESP_HOST_WIFI_ENABLED`

**CONFIG\_ESP\_WIFI\_SOFTAP\_SUPPORT**

WiFi SoftAP Support

Found in: *Component config > Wi-Fi*

WiFi module can be compiled without SoftAP to save code size.

**Default value:**

- Yes (enabled) if `CONFIG_ESP_HOST_WIFI_ENABLED`

**CONFIG\_ESP\_WIFI\_ENHANCED\_LIGHT\_SLEEP**

WiFi modem automatically receives the beacon

Found in: *Component config > Wi-Fi*

The wifi modem automatically receives the beacon frame during light sleep.

**Default value:**

- No (disabled) if `CONFIG_ESP_PHY_MAC_BB_PD` && `SOC_PM_SUPPORT_BEACON_WAKEUP` && `CONFIG_ESP_HOST_WIFI_ENABLED`

**CONFIG\_ESP\_WIFI\_SLP\_BEACON\_LOST\_OPT**

Wifi sleep optimize when beacon lost

Found in: *Component config > Wi-Fi*

Enable wifi sleep optimization when beacon loss occurs and immediately enter sleep mode when the WiFi module detects beacon loss.

**CONFIG\_ESP\_WIFI\_SLP\_BEACON\_LOST\_TIMEOUT**

Beacon loss timeout

Found in: *Component config > Wi-Fi > CONFIG\_ESP\_WIFI\_SLP\_BEACON\_LOST\_OPT*

Timeout time for close rf phy when beacon loss occurs, Unit: 1024 microsecond.

**Range:**

- from 5 to 100 if `CONFIG_ESP_WIFI_SLP_BEACON_LOST_OPT` && `CONFIG_ESP_HOST_WIFI_ENABLED`



**Default value:**

- 10 if `CONFIG_ESP_WIFI_SLP_BEACON_LOST_OPT` && `CONFIG_ESP_HOST_WIFI_ENABLED`

**CONFIG\_ESP\_WIFI\_SLP\_BEACON\_LOST\_THRESHOLD**

Maximum number of consecutive lost beacons allowed

*Found in: Component config > Wi-Fi > CONFIG\_ESP\_WIFI\_SLP\_BEACON\_LOST\_OPT*

Maximum number of consecutive lost beacons allowed, WiFi keeps Rx state when the number of consecutive beacons lost is greater than the given threshold.

**Range:**

- from 0 to 8 if `CONFIG_ESP_WIFI_SLP_BEACON_LOST_OPT` && `CONFIG_ESP_HOST_WIFI_ENABLED`

**Default value:**

- 3 if `CONFIG_ESP_WIFI_SLP_BEACON_LOST_OPT` && `CONFIG_ESP_HOST_WIFI_ENABLED`

**CONFIG\_ESP\_WIFI\_SLP\_PHY\_ON\_DELTA\_EARLY\_TIME**

Delta early time for RF PHY on

*Found in: Component config > Wi-Fi > CONFIG\_ESP\_WIFI\_SLP\_BEACON\_LOST\_OPT*

Delta early time for rf phy on, When the beacon is lost, the next rf phy on will be earlier the time specified by the configuration item, Unit: 32 microsecond.

**Range:**

- from 0 to 100 if `CONFIG_ESP_WIFI_SLP_BEACON_LOST_OPT` && `SOC_WIFI_SUPPORT_VARIABLE_BEACON_WINDOW` && `CONFIG_ESP_HOST_WIFI_ENABLED`

**Default value:**

- 2 if `CONFIG_ESP_WIFI_SLP_BEACON_LOST_OPT` && `SOC_WIFI_SUPPORT_VARIABLE_BEACON_WINDOW` && `CONFIG_ESP_HOST_WIFI_ENABLED`

**CONFIG\_ESP\_WIFI\_SLP\_PHY\_OFF\_DELTA\_TIMEOUT\_TIME**

Delta timeout time for RF PHY off

*Found in: Component config > Wi-Fi > CONFIG\_ESP\_WIFI\_SLP\_BEACON\_LOST\_OPT*

Delta timeout time for rf phy off, When the beacon is lost, the next rf phy off will be delayed for the time specified by the configuration item. Unit: 1024 microsecond.

**Range:**

- from 0 to 8 if `CONFIG_ESP_WIFI_SLP_BEACON_LOST_OPT` && `SOC_WIFI_SUPPORT_VARIABLE_BEACON_WINDOW` && `CONFIG_ESP_HOST_WIFI_ENABLED`

**Default value:**

- 2 if `CONFIG_ESP_WIFI_SLP_BEACON_LOST_OPT` && `SOC_WIFI_SUPPORT_VARIABLE_BEACON_WINDOW` && `CONFIG_ESP_HOST_WIFI_ENABLED`

**CONFIG\_ESP\_WIFI\_ESPNOW\_MAX\_ENCRYPT\_NUM**

Maximum espnow encrypt peers number

*Found in: Component config > Wi-Fi*

Maximum number of encrypted peers supported by espnow. The number of hardware keys for encryption is fixed. And the espnow and SoftAP share the same hardware keys. So this configuration will affect the maximum connection number of SoftAP. Maximum espnow encrypted peers number + maximum number of connections of SoftAP = Max hardware keys number. When using ESP mesh, this value should be set to a maximum of 6.

**Range:**

- from 0 to 17 if `CONFIG_ESP_HOST_WIFI_ENABLED`

**Default value:**

- 7 if `CONFIG_ESP_HOST_WIFI_ENABLED`

### CONFIG\_ESP\_WIFI\_NAN\_ENABLE

WiFi Aware

*Found in:* [Component config > Wi-Fi](#)

Enable WiFi Aware (NAN) feature.

**Default value:**

- No (disabled) if `SOC_WIFI_NAN_SUPPORT` && `CONFIG_ESP_HOST_WIFI_ENABLED`

### CONFIG\_ESP\_WIFI\_MBEDTLS\_CRYPTO

Use MbedTLS crypto APIs

*Found in:* [Component config > Wi-Fi](#)

Select this option to enable the use of MbedTLS crypto APIs. The internal crypto support within the supplicant is limited and may not suffice for all new security features, including WPA3.

It is recommended to always keep this option enabled. Additionally, note that MbedTLS can leverage hardware acceleration if available, resulting in significantly faster cryptographic operations.

**Default value:**

- Yes (enabled) if `CONFIG_ESP_HOST_WIFI_ENABLED`

### CONFIG\_ESP\_WIFI\_MBEDTLS\_TLS\_CLIENT

Use MbedTLS TLS client for WiFi Enterprise connection

*Found in:* [Component config > Wi-Fi > CONFIG\\_ESP\\_WIFI\\_MBEDTLS\\_CRYPTO](#)

Select this option to use MbedTLS TLS client for WPA2 enterprise connection. Please note that from MbedTLS-3.0 onwards, MbedTLS does not support SSL-3.0 TLS-v1.0, TLS-v1.1 versions. In case your server is using one of these version, it is advisable to update your server. Please disable this option for compatibility with older TLS versions.

**Default value:**

- Yes (enabled) if `CONFIG_ESP_WIFI_ENTERPRISE_SUPPORT` && `CONFIG_ESP_WIFI_MBEDTLS_CRYPTO` && `CONFIG_ESP_HOST_WIFI_ENABLED`

### CONFIG\_ESP\_WIFI\_EAP\_TLS1\_3

Enable EAP-TLS v1.3 Support for WiFi Enterprise connection

*Found in:* [Component config > Wi-Fi > CONFIG\\_ESP\\_WIFI\\_MBEDTLS\\_CRYPTO > CONFIG\\_ESP\\_WIFI\\_MBEDTLS\\_TLS\\_CLIENT](#)

Select this option to support EAP with TLS v1.3. This configuration still supports compatibility with EAP-TLS v1.2. Please note that enabling this configuration will cause every application which uses TLS go for TLS1.3 if server supports that. TLS1.3 is still in development in mbedtls and there may be interoperability issues with this. Please modify your application to set max version as TLS1.2 if you want to enable TLS1.3 only for WiFi connection.

**Default value:**

- No (disabled) if `CONFIG_ESP_WIFI_MBEDTLS_TLS_CLIENT` && `CONFIG_IDF_EXPERIMENTAL_FEATURES` && `CONFIG_ESP_WIFI_MBEDTLS_CRYPT` && `CONFIG_ESP_HOST_WIFI_ENABLED`

**CONFIG\_ESP\_WIFI\_WAPI\_PSK**

Enable WAPI PSK support

*Found in:* [Component config > Wi-Fi](#)

Select this option to enable WAPI-PSK which is a Chinese National Standard Encryption for Wireless LANs (GB 15629.11-2003).

**Default value:**

- No (disabled) if `SOC_WIFI_WAPI_SUPPORT` && `CONFIG_ESP_HOST_WIFI_ENABLED`

**CONFIG\_ESP\_WIFI\_SUITE\_B\_192**

Enable NSA suite B support with 192 bit key

*Found in:* [Component config > Wi-Fi](#)

Select this option to enable 192 bit NSA suite-B. This is necessary to support WPA3 192 bit security.

**Default value:**

- No (disabled) if `SOC_WIFI_GCMP_SUPPORT` && `CONFIG_ESP_HOST_WIFI_ENABLED`

**CONFIG\_ESP\_WIFI\_11KV\_SUPPORT**

Enable 802.11k, 802.11v APIs Support

*Found in:* [Component config > Wi-Fi](#)

Select this option to enable 802.11k 802.11v APIs(RRM and BTM support). Only APIs which are helpful for network assisted roaming are supported for now. Enable this option with BTM and RRM enabled in sta config to make device ready for network assisted roaming. BTM: BSS transition management enables an AP to request a station to transition to a specific AP, or to indicate to a station a set of preferred APs. RRM: Radio measurements enable STAs to understand the radio environment, it enables STAs to observe and gather data on radio link performance and on the radio environment. Current implementation adds beacon report, link measurement, neighbor report.

**Default value:**

- No (disabled) if `CONFIG_ESP_HOST_WIFI_ENABLED`

**CONFIG\_ESP\_WIFI\_SCAN\_CACHE**

Keep scan results in cache

*Found in:* [Component config > Wi-Fi > CONFIG\\_ESP\\_WIFI\\_11KV\\_SUPPORT](#)

Keep scan results in cache, if not enabled, those will be flushed immediately.

**Default value:**

- No (disabled) if `CONFIG_ESP_WIFI_11KV_SUPPORT` && `CONFIG_ESP_HOST_WIFI_ENABLED`

## CONFIG\_ESP\_WIFI\_MBO\_SUPPORT

Enable Multi Band Operation Certification Support

*Found in:* [Component config > Wi-Fi](#)

Select this option to enable WiFi Multiband operation certification support.

**Default value:**

- No (disabled) if [CONFIG\\_ESP\\_HOST\\_WIFI\\_ENABLED](#)

## CONFIG\_ESP\_WIFI\_ENABLE\_ROAMING\_APP

Advanced support for Wi-Fi Roaming (Experimental)

*Found in:* [Component config > Wi-Fi](#)

Enable Espressif's roaming app to allow for efficient Wi-Fi roaming. This includes configurable periodic environment scans, maintaining a cache of the best APs, handling low rssi events etc.

Risk Warning Please note that this feature is still experimental and enabling this potentially can lead to unpredictable scanning, connection and roaming attempts. We are still working on tuning and optimising this feature to ensure reliable and stable use.

**Default value:**

- No (disabled) if [CONFIG\\_IDF\\_EXPERIMENTAL\\_FEATURES](#) && [CONFIG\\_ESP\\_HOST\\_WIFI\\_ENABLED](#)

**Configure roaming App** Contains:

- [CONFIG\\_ESP\\_WIFI\\_ROAMING\\_BACKOFF\\_TIME](#)
- [Roaming Methods](#)
- [Roaming triggers](#)
- [Scan Configuration](#)
- [CONFIG\\_ESP\\_WIFI\\_ROAMING\\_PERIODIC\\_RRM\\_MONITORING](#)

**Roaming triggers** Contains:

- [CONFIG\\_ESP\\_WIFI\\_ROAMING\\_PERIODIC\\_SCAN\\_MONITOR](#)
- [CONFIG\\_ESP\\_WIFI\\_ROAMING\\_LOW\\_RSSI\\_ROAMING](#)

## CONFIG\_ESP\_WIFI\_ROAMING\_LOW\_RSSI\_ROAMING

Use Low RSSI to trigger roaming.

*Found in:* [Component config > Wi-Fi > CONFIG\\_ESP\\_WIFI\\_ENABLE\\_ROAMING\\_APP > Configure roaming App > Roaming triggers](#)

Enable to use a RSSI threshold to trigger roaming.

**Default value:**

- Yes (enabled) if [CONFIG\\_ESP\\_WIFI\\_ENABLE\\_ROAMING\\_APP](#) && [CONFIG\\_ESP\\_HOST\\_WIFI\\_ENABLED](#)

## CONFIG\_ESP\_WIFI\_ROAMING\_LOW\_RSSI\_THRESHOLD

WiFi RSSI threshold to trigger roaming

*Found in:* [Component config > Wi-Fi > CONFIG\\_ESP\\_WIFI\\_ENABLE\\_ROAMING\\_APP > Configure roaming App > Roaming triggers > CONFIG\\_ESP\\_WIFI\\_ROAMING\\_LOW\\_RSSI\\_ROAMING](#)

WiFi RSSI threshold to trigger roaming value in dBm (-99 to -1). Values under -30 dbm might lead to a flood of low rssi events. This interferes with normal functioning and TX/Rx performance.

**Range:**

- from -99 to -30 if `CONFIG_ESP_WIFI_ROAMING_LOW_RSSI_ROAMING` && `CONFIG_ESP_WIFI_ENABLE_ROAMING_APP` && `CONFIG_ESP_HOST_WIFI_ENABLED`

**Default value:**

- "-60" if `CONFIG_ESP_WIFI_ROAMING_LOW_RSSI_ROAMING` && `CONFIG_ESP_WIFI_ENABLE_ROAMING_APP` && `CONFIG_ESP_HOST_WIFI_ENABLED`

**CONFIG\_ESP\_WIFI\_ROAMING\_LOW\_RSSI\_OFFSET**

Offset by which to reset the RSSI Threshold after attempt to roam.

*Found in: Component config > Wi-Fi > CONFIG\_ESP\_WIFI\_ENABLE\_ROAMING\_APP > Configure roaming App > Roaming triggers > CONFIG\_ESP\_WIFI\_ROAMING\_LOW\_RSSI\_ROAMING*

Decide the offset by which to decrease the Low RSSI threshold set by `ESP_WIFI_ROAMING_LOW_RSSI_THRESHOLD` after each failed attempt to roam. This allows for the station to keep scanning for better AP's after the Low RSSI threshold is reached in a stepped manner, rather than only attempting to roam the first time the current AP's RSSI breaches the set RSSI threshold. Setting 0 here may cause station to be flooded with low rssi events, therefore that's not recommended to be kept.

**Range:**

- from 0 to 99 if `CONFIG_ESP_WIFI_ROAMING_LOW_RSSI_ROAMING` && `CONFIG_ESP_WIFI_ENABLE_ROAMING_APP` && `CONFIG_ESP_HOST_WIFI_ENABLED`

**Default value:**

- 5 if `CONFIG_ESP_WIFI_ROAMING_LOW_RSSI_ROAMING` && `CONFIG_ESP_WIFI_ENABLE_ROAMING_APP` && `CONFIG_ESP_HOST_WIFI_ENABLED`

**CONFIG\_ESP\_WIFI\_ROAMING\_PERIODIC\_SCAN\_MONITOR**

Conduct periodic scans to check if a better AP is available

*Found in: Component config > Wi-Fi > CONFIG\_ESP\_WIFI\_ENABLE\_ROAMING\_APP > Configure roaming App > Roaming triggers*

Conduct periodic scans periodically to check if a better AP is available.

**Default value:**

- Yes (enabled) if `CONFIG_ESP_WIFI_ENABLE_ROAMING_APP` && `CONFIG_ESP_HOST_WIFI_ENABLED`

**CONFIG\_ESP\_WIFI\_ROAMING\_PERIODIC\_SCAN\_THRESHOLD**

Threshold at which to begin periodic scanning for a better AP.

*Found in: Component config > Wi-Fi > CONFIG\_ESP\_WIFI\_ENABLE\_ROAMING\_APP > Configure roaming App > Roaming triggers > CONFIG\_ESP\_WIFI\_ROAMING\_PERIODIC\_SCAN\_MONITOR*

Threshold at which the station will begin scanning to find an AP with better RSSI.

**Range:**

- from -99 to -1 if `CONFIG_ESP_WIFI_ROAMING_PERIODIC_SCAN_MONITOR` && `CONFIG_ESP_WIFI_ENABLE_ROAMING_APP` && `CONFIG_ESP_HOST_WIFI_ENABLED`

**Default value:**

- "-50" if `CONFIG_ESP_WIFI_ROAMING_PERIODIC_SCAN_MONITOR` && `CONFIG_ESP_WIFI_ENABLE_ROAMING_APP` && `CONFIG_ESP_HOST_WIFI_ENABLED`

**CONFIG\_ESP\_WIFI\_ROAMING\_SCAN\_MONITOR\_INTERVAL**

Time intervals (in seconds) at which station will initiate a scan

*Found in: Component config > Wi-Fi > CONFIG\_ESP\_WIFI\_ENABLE\_ROAMING\_APP > Configure roaming App > Roaming triggers > CONFIG\_ESP\_WIFI\_ROAMING\_PERIODIC\_SCAN\_MONITOR*

Intervals at which station will periodically scan to check if better AP is available

**Range:**

- from 1 to 1500 if `CONFIG_ESP_WIFI_ROAMING_PERIODIC_SCAN_MONITOR` && `CONFIG_ESP_WIFI_ENABLE_ROAMING_APP` && `CONFIG_ESP_HOST_WIFI_ENABLED`

**Default value:**

- 30 if `CONFIG_ESP_WIFI_ROAMING_PERIODIC_SCAN_MONITOR` && `CONFIG_ESP_WIFI_ENABLE_ROAMING_APP` && `CONFIG_ESP_HOST_WIFI_ENABLED`

### CONFIG\_ESP\_WIFI\_ROAMING\_SCAN\_ROAM\_RSSI\_DIFF

RSSI difference b/w current AP and candidate AP to initiate connection

*Found in: Component config > Wi-Fi > CONFIG\_ESP\_WIFI\_ENABLE\_ROAMING\_APP > Configure roaming App > Roaming triggers > CONFIG\_ESP\_WIFI\_ROAMING\_PERIODIC\_SCAN\_MONITOR*

Minimum RSSI difference b/w current AP and a potential roaming candidate AP to trigger a roaming attempt.

**Range:**

- from 0 to 99 if `CONFIG_ESP_WIFI_ROAMING_PERIODIC_SCAN_MONITOR` && `CONFIG_ESP_WIFI_ENABLE_ROAMING_APP` && `CONFIG_ESP_HOST_WIFI_ENABLED`

**Default value:**

- 15 if `CONFIG_ESP_WIFI_ROAMING_PERIODIC_SCAN_MONITOR` && `CONFIG_ESP_WIFI_ENABLE_ROAMING_APP` && `CONFIG_ESP_HOST_WIFI_ENABLED`

### Roaming Methods Contains:

- `CONFIG_ESP_WIFI_ROAMING_LEGACY_ROAMING`
- `CONFIG_ESP_WIFI_ROAMING_NETWORK_ASSISTED_ROAM`

### CONFIG\_ESP\_WIFI\_ROAMING\_LEGACY\_ROAMING

Support Legacy roaming approach

*Found in: Component config > Wi-Fi > CONFIG\_ESP\_WIFI\_ENABLE\_ROAMING\_APP > Configure roaming App > Roaming Methods*

Roaming between APs that do not support 802.11kv. This will allow station to roam even when connection is not BTM supported, by forcefully disconnecting from current AP and connecting to better AP.

**Default value:**

- Yes (enabled) if `CONFIG_ESP_WIFI_ENABLE_ROAMING_APP` && `CONFIG_ESP_HOST_WIFI_ENABLED`

### CONFIG\_ESP\_WIFI\_ROAMING\_NETWORK\_ASSISTED\_ROAM

Support Network Assisted roaming using 802.11kv

*Found in: Component config > Wi-Fi > CONFIG\_ESP\_WIFI\_ENABLE\_ROAMING\_APP > Configure roaming App > Roaming Methods*

Roaming between APs using network assisted Roaming. This involves BSS Transition Management mechanisms outlined in 802.11v. Note that this moves the responsibility to the AP's network, and hence isn't guaranteed to cause the station to attempt to roam each time.

**Default value:**

- Yes (enabled) if `CONFIG_ESP_WIFI_11KV_SUPPORT` && `CONFIG_ESP_WIFI_ENABLE_ROAMING_APP` && `CONFIG_ESP_HOST_WIFI_ENABLED`

**CONFIG\_ESP\_WIFI\_NETWORK\_ASSISTED\_ROAMING\_RETRY\_COUNT**

Retry count after which to switch to legacy roaming

*Found in: Component config > Wi-Fi > CONFIG\_ESP\_WIFI\_ENABLE\_ROAMING\_APP > Configure roaming App > Roaming Methods > CONFIG\_ESP\_WIFI\_ROAMING\_NETWORK\_ASSISTED\_ROAM*

Retry threshold after which the station should stop using Network Assisted roaming methods and start using legacy roaming instead.

**Range:**

- from 1 to 5 if `CONFIG_ESP_WIFI_ROAMING_NETWORK_ASSISTED_ROAM` && `CONFIG_ESP_WIFI_ROAMING_LEGACY_ROAMING` && `CONFIG_ESP_WIFI_ENABLE_ROAMING_APP` && `CONFIG_ESP_HOST_WIFI_ENABLED`

**Default value:**

- 2 if `CONFIG_ESP_WIFI_ROAMING_NETWORK_ASSISTED_ROAM` && `CONFIG_ESP_WIFI_ROAMING_LEGACY_ROAMING` && `CONFIG_ESP_WIFI_ENABLE_ROAMING_APP` && `CONFIG_ESP_HOST_WIFI_ENABLED`

**Scan Configuration** Contains:

- `CONFIG_ESP_WIFI_ROAMING_HOME_CHANNEL_DWELL_TIME`
- `CONFIG_ESP_WIFI_ROAMING_MAX_CANDIDATES`
- `CONFIG_ESP_WIFI_ROAMING_SCAN_MAX_SCAN_TIME`
- `CONFIG_ESP_WIFI_ROAMING_SCAN_MIN_SCAN_TIME`
- `CONFIG_ESP_WIFI_ROAMING_SCAN_CHAN_LIST`
- `CONFIG_ESP_WIFI_ROAMING_SCAN_EXPIRY_WINDOW`

**CONFIG\_ESP\_WIFI\_ROAMING\_SCAN\_MIN\_SCAN\_TIME**

Minimum duration (in milliseconds) of station's per channel active scan

*Found in: Component config > Wi-Fi > CONFIG\_ESP\_WIFI\_ENABLE\_ROAMING\_APP > Configure roaming App > Scan Configuration*

Minimum duration of active scanning per channel in milliseconds.

**Range:**

- from 0 to 120 if `CONFIG_ESP_WIFI_ENABLE_ROAMING_APP` && `CONFIG_ESP_HOST_WIFI_ENABLED`

**Default value:**

- 10 if `CONFIG_ESP_WIFI_ENABLE_ROAMING_APP` && `CONFIG_ESP_HOST_WIFI_ENABLED`

**CONFIG\_ESP\_WIFI\_ROAMING\_SCAN\_MAX\_SCAN\_TIME**

Maximum duration (in milliseconds) of station's per channel active scan time

*Found in: Component config > Wi-Fi > CONFIG\_ESP\_WIFI\_ENABLE\_ROAMING\_APP > Configure roaming App > Scan Configuration*

Maximum duration of active scanning per channel in milliseconds.

**Range:**

- from 30 to 120 if `CONFIG_ESP_WIFI_ENABLE_ROAMING_APP` && `CONFIG_ESP_HOST_WIFI_ENABLED`

**Default value:**

- 70 if `CONFIG_ESP_WIFI_ENABLE_ROAMING_APP` && `CONFIG_ESP_HOST_WIFI_ENABLED`



**CONFIG\_ESP\_WIFI\_ROAMING\_HOME\_CHANNEL\_DWELL\_TIME**

Home channel dwell time scanning between consecutive channels

*Found in: Component config > Wi-Fi > CONFIG\_ESP\_WIFI\_ENABLE\_ROAMING\_APP > Configure roaming App > Scan Configuration*

If connected, duration for which the station will return to its home channel for Tx/Rx of frames stored in buffers between scanning on consecutive channels.

**Range:**

- from 30 to 150 if `CONFIG_ESP_WIFI_ENABLE_ROAMING_APP` && `CONFIG_ESP_HOST_WIFI_ENABLED`

**Default value:**

- 30 if `CONFIG_ESP_WIFI_ENABLE_ROAMING_APP` && `CONFIG_ESP_HOST_WIFI_ENABLED`

**CONFIG\_ESP\_WIFI\_ROAMING\_SCAN\_CHAN\_LIST**

Preferred channel list for scanning

*Found in: Component config > Wi-Fi > CONFIG\_ESP\_WIFI\_ENABLE\_ROAMING\_APP > Configure roaming App > Scan Configuration*

Channels your wireless network operates on to allow for faster scanning. Specify the channels (between 1-14) in a comma separated manner.

**Default value:**

- "None" if `CONFIG_ESP_WIFI_ENABLE_ROAMING_APP` && `CONFIG_ESP_HOST_WIFI_ENABLED`

**CONFIG\_ESP\_WIFI\_ROAMING\_SCAN\_EXPIRY\_WINDOW**

Scan results expiry window (in seconds)

*Found in: Component config > Wi-Fi > CONFIG\_ESP\_WIFI\_ENABLE\_ROAMING\_APP > Configure roaming App > Scan Configuration*

Duration for which the results from the most recent scans can be used by the roaming app for determining the roaming candidates.

**Range:**

- from 5 to 20 if `CONFIG_ESP_WIFI_ENABLE_ROAMING_APP` && `CONFIG_ESP_HOST_WIFI_ENABLED`

**Default value:**

- 10 if `CONFIG_ESP_WIFI_ENABLE_ROAMING_APP` && `CONFIG_ESP_HOST_WIFI_ENABLED`

**CONFIG\_ESP\_WIFI\_ROAMING\_MAX\_CANDIDATES**

Max Candidates in the network

*Found in: Component config > Wi-Fi > CONFIG\_ESP\_WIFI\_ENABLE\_ROAMING\_APP > Configure roaming App > Scan Configuration*

Max candidates that can be considered while scanning as a part of the network at one time.

**Range:**

- from 3 to 20 if `CONFIG_ESP_WIFI_ENABLE_ROAMING_APP` && `CONFIG_ESP_HOST_WIFI_ENABLED`

**Default value:**

- 3 if `CONFIG_ESP_WIFI_ENABLE_ROAMING_APP` && `CONFIG_ESP_HOST_WIFI_ENABLED`



**CONFIG\_ESP\_WIFI\_ROAMING\_BACKOFF\_TIME**

Default time to wait between subsequent roaming attempts.

*Found in:* *Component config > Wi-Fi > CONFIG\_ESP\_WIFI\_ENABLE\_ROAMING\_APP > Configure roaming App*

Time to wait (in seconds) by station before registering for the RSSI event again or start continuous monitoring to find better AP.

**Range:**

- from 0 to 120 if `CONFIG_ESP_WIFI_ENABLE_ROAMING_APP` && `CONFIG_ESP_HOST_WIFI_ENABLED`

**Default value:**

- 15 if `CONFIG_ESP_WIFI_ENABLE_ROAMING_APP` && `CONFIG_ESP_HOST_WIFI_ENABLED`

**CONFIG\_ESP\_WIFI\_ROAMING\_PERIODIC\_RRM\_MONITORING**

Send periodic neighbor report request to AP for internal list update

*Found in:* *Component config > Wi-Fi > CONFIG\_ESP\_WIFI\_ENABLE\_ROAMING\_APP > Configure roaming App*

This option will enable station to keep sending RRM neighbor list request to AP and update its internal list.

**Default value:**

- Yes (enabled) if `CONFIG_ESP_WIFI_11KV_SUPPORT` && `CONFIG_ESP_WIFI_ENABLE_ROAMING_APP` && `CONFIG_ESP_HOST_WIFI_ENABLED`

**CONFIG\_ESP\_WIFI\_ROAMING\_RRM\_MONITOR\_TIME**

Time interval (in seconds) between neighbor report requests to an AP

*Found in:* *Component config > Wi-Fi > CONFIG\_ESP\_WIFI\_ENABLE\_ROAMING\_APP > Configure roaming App > CONFIG\_ESP\_WIFI\_ROAMING\_PERIODIC\_RRM\_MONITORING*

Enable this to send periodic neighbor report requests to the AP. These neighbor report requests provide information about other APs in the same managed network. This information is used for more intelligent roaming.

**Range:**

- from 0 to 1500 if `CONFIG_ESP_WIFI_ROAMING_PERIODIC_RRM_MONITORING` && `CONFIG_ESP_WIFI_ENABLE_ROAMING_APP` && `CONFIG_ESP_HOST_WIFI_ENABLED`

**Default value:**

- 60 if `CONFIG_ESP_WIFI_ROAMING_PERIODIC_RRM_MONITORING` && `CONFIG_ESP_WIFI_ENABLE_ROAMING_APP` && `CONFIG_ESP_HOST_WIFI_ENABLED`

**CONFIG\_ESP\_WIFI\_ROAMING\_RRM\_MONITOR\_THRESHOLD**

Threshold for sending periodic neighbor report requests

*Found in:* *Component config > Wi-Fi > CONFIG\_ESP\_WIFI\_ENABLE\_ROAMING\_APP > Configure roaming App > CONFIG\_ESP\_WIFI\_ROAMING\_PERIODIC\_RRM\_MONITORING*

The RSSI threshold beyond which we start sending periodic neighbor report requests.

**Range:**

- from -99 to 0 if `CONFIG_ESP_WIFI_ROAMING_PERIODIC_RRM_MONITORING` && `CONFIG_ESP_WIFI_ENABLE_ROAMING_APP` && `CONFIG_ESP_HOST_WIFI_ENABLED`

**Default value:**

- "-20" if `CONFIG_ESP_WIFI_ROAMING_PERIODIC_RRM_MONITORING` && `CONFIG_ESP_WIFI_ENABLE_ROAMING_APP` && `CONFIG_ESP_HOST_WIFI_ENABLED`

### **CONFIG\_ESP\_WIFI\_DPP\_SUPPORT**

Enable DPP support

*Found in:* `Component config` > `Wi-Fi`

Select this option to enable WiFi Easy Connect Support.

**Default value:**

- No (disabled) if `CONFIG_ESP_HOST_WIFI_ENABLED`

### **CONFIG\_ESP\_WIFI\_11R\_SUPPORT**

Enable 802.11R (Fast Transition) Support

*Found in:* `Component config` > `Wi-Fi`

Select this option to enable WiFi Fast Transition Support.

**Default value:**

- No (disabled) if `CONFIG_ESP_HOST_WIFI_ENABLED`

### **CONFIG\_ESP\_WIFI\_WPS\_SOFTAP\_REGISTRAR**

Add WPS Registrar support in SoftAP mode

*Found in:* `Component config` > `Wi-Fi`

Select this option to enable WPS registrar support in softAP mode.

**Default value:**

- No (disabled) if `CONFIG_ESP_WIFI_SOFTAP_SUPPORT` && `CONFIG_ESP_HOST_WIFI_ENABLED`

### **CONFIG\_ESP\_WIFI\_ENABLE\_WIFI\_TX\_STATS**

Enable Wi-Fi transmission statistics

*Found in:* `Component config` > `Wi-Fi`

Enable Wi-Fi transmission statistics. Total support 4 access category. Each access category will use 346 bytes memory.

**Default value:**

- No (disabled) if `SOC_WIFI_HE_SUPPORT` && `CONFIG_ESP_HOST_WIFI_ENABLED`

### **CONFIG\_ESP\_WIFI\_ENABLE\_WIFI\_RX\_STATS**

Enable Wi-Fi reception statistics

*Found in:* `Component config` > `Wi-Fi`

Enable Wi-Fi reception statistics. Total support 2 access category. Each access category will use 190 bytes memory.

**Default value:**

- No (disabled) if `SOC_WIFI_HE_SUPPORT` && `CONFIG_ESP_HOST_WIFI_ENABLED`

**CONFIG\_ESP\_WIFI\_ENABLE\_WIFI\_RX\_MU\_STATS**

Enable Wi-Fi DL MU-MIMO and DL OFDMA reception statistics

*Found in:* [Component config](#) > [Wi-Fi](#) > [CONFIG\\_ESP\\_WIFI\\_ENABLE\\_WIFI\\_RX\\_STATS](#)

Enable Wi-Fi DL MU-MIMO and DL OFDMA reception statistics. Will use 10932 bytes memory.

**Default value:**

- No (disabled) if [CONFIG\\_ESP\\_WIFI\\_ENABLE\\_WIFI\\_RX\\_STATS](#) && [CONFIG\\_ESP\\_HOST\\_WIFI\\_ENABLED](#)

**CONFIG\_ESP\_WIFI\_TX\_HETB\_QUEUE\_NUM**

WiFi TX HE TB QUEUE number for STA HE TB PPDU transmission

*Found in:* [Component config](#) > [Wi-Fi](#)

Set the maximum number of queue that can be aggregated by the STA in the A-MPDU carried in the HE TB PPDU.

**Range:**

- from 1 to 4 if [SOC\\_WIFI\\_HE\\_SUPPORT](#) && [CONFIG\\_ESP\\_HOST\\_WIFI\\_ENABLED](#)

**Default value:**

- 3 if [SOC\\_WIFI\\_HE\\_SUPPORT](#) && [CONFIG\\_ESP\\_HOST\\_WIFI\\_ENABLED](#)

**CONFIG\_ESP\_WIFI\_ENABLE\_DUMP\_HESIGB**

Enable Wi-Fi dump HE-SIGB which is contained in DL HE MU PPDU

*Found in:* [Component config](#) > [Wi-Fi](#)

Enable Wi-Fi dump HE-SIGB which is contained in DL HE MU PPDU.

**Default value:**

- No (disabled) if [SOC\\_WIFI\\_HE\\_SUPPORT\\_5G](#) && [CONFIG\\_ESP\\_HOST\\_WIFI\\_ENABLED](#)

**CONFIG\_ESP\_WIFI\_ENABLE\_DUMP\_MU\_CFO**

Enable Wi-Fi dump MU CFO

*Found in:* [Component config](#) > [Wi-Fi](#)

Enable Wi-Fi dump MU CFO.

**Default value:**

- No (disabled) if [SOC\\_WIFI\\_HE\\_SUPPORT\\_5G](#) && [CONFIG\\_ESP\\_HOST\\_WIFI\\_ENABLED](#)

**CONFIG\_ESP\_WIFI\_ENABLE\_DUMP\_CTRL\_NDPA**

Enable Wi-Fi dump NDPA frames

*Found in:* [Component config](#) > [Wi-Fi](#)

Enable Wi-Fi dump NDPA frames.

**Default value:**

- No (disabled) if [SOC\\_WIFI\\_HE\\_SUPPORT\\_5G](#) && [CONFIG\\_ESP\\_HOST\\_WIFI\\_ENABLED](#)

### CONFIG\_ESP\_WIFI\_ENABLE\_DUMP\_CTRL\_BFRP

Enable Wi-Fi dump BFRP frames

*Found in:* [Component config > Wi-Fi](#)

Enable Wi-Fi dump BFRP frames.

**Default value:**

- No (disabled) if `SOC_WIFI_HE_SUPPORT_5G` && `CONFIG_ESP_HOST_WIFI_ENABLED`

### WPS Configuration Options Contains:

- [CONFIG\\_ESP\\_WIFI\\_WPS\\_PASSPHRASE](#)
- [CONFIG\\_ESP\\_WIFI\\_WPS\\_STRICT](#)

### CONFIG\_ESP\_WIFI\_WPS\_STRICT

Strictly validate all WPS attributes

*Found in:* [Component config > Wi-Fi > WPS Configuration Options](#)

Select this option to enable validate each WPS attribute rigorously. Disabling this add the workarounds with various APs. Enabling this may cause inter operability issues with some APs.

**Default value:**

- No (disabled) if `CONFIG_ESP_HOST_WIFI_ENABLED`

### CONFIG\_ESP\_WIFI\_WPS\_PASSPHRASE

Get WPA2 passphrase in WPS config

*Found in:* [Component config > Wi-Fi > WPS Configuration Options](#)

Select this option to get passphrase during WPS configuration. This option fakes the virtual display capabilities to get the configuration in passphrase mode. Not recommended to be used since WPS credentials should not be shared to other devices, making it in readable format increases that risk, also passphrase requires pbkdf2 to convert in psk.

**Default value:**

- No (disabled) if `CONFIG_ESP_HOST_WIFI_ENABLED`

### CONFIG\_ESP\_WIFI\_DEBUG\_PRINT

Print debug messages from WPA Supplicant

*Found in:* [Component config > Wi-Fi](#)

Select this option to print logging information from WPA supplicant, this includes handshake information and key hex dumps depending on the project logging level.

Enabling this could increase the build size ~60kb depending on the project logging level.

**Default value:**

- No (disabled) if `CONFIG_ESP_HOST_WIFI_ENABLED`

### CONFIG\_ESP\_WIFI\_TESTING\_OPTIONS

Add DPP testing code

*Found in:* [Component config > Wi-Fi](#)

Select this to enable unity test for DPP.

**Default value:**

- No (disabled) if `CONFIG_ESP_HOST_WIFI_ENABLED`

### CONFIG\_ESP\_WIFI\_ENTERPRISE\_SUPPORT

Enable enterprise option

*Found in:* [Component config > Wi-Fi](#)

Select this to enable/disable enterprise connection support.

disabling this will reduce binary size. disabling this will disable the use of any `esp_wifi_sta_wpa2_ent_*` (as APIs will be meaningless)

Note that when using bigger certificates on low-power chips without crypto hardware acceleration, it is recommended to adjust the task watchdog timer (TWDT) if it is enabled. For precise information on timing requirements, you can check performance numbers at <https://github.com/espressif/mbdttl/wiki/Performance-Numbers>.

#### Default value:

- Yes (enabled) if `CONFIG_ESP_HOST_WIFI_ENABLED`

### CONFIG\_ESP\_WIFI\_ENT\_FREE\_DYNAMIC\_BUFFER

Free dynamic buffers during WiFi enterprise connection

*Found in:* [Component config > Wi-Fi > CONFIG\\_ESP\\_WIFI\\_ENTERPRISE\\_SUPPORT](#)

Select this configuration to free dynamic buffers during WiFi enterprise connection. This will enable chip to reduce heap consumption during WiFi enterprise connection.

#### Default value:

- No (disabled) if `CONFIG_ESP_WIFI_ENTERPRISE_SUPPORT && CONFIG_ESP_HOST_WIFI_ENABLED`

**Core dump** Contains:

- `CONFIG_ESP_COREDUMP_CHECK_BOOT`
- `CONFIG_ESP_COREDUMP_DATA_FORMAT`
- `CONFIG_ESP_COREDUMP_CHECKSUM`
- `CONFIG_ESP_COREDUMP_TO_FLASH_OR_UART`
- `CONFIG_ESP_COREDUMP_UART_DELAY`
- `CONFIG_ESP_COREDUMP_FLASH_NO_OVERWRITE`
- `CONFIG_ESP_COREDUMP_LOGS`
- `CONFIG_ESP_COREDUMP_DECODE`
- `CONFIG_ESP_COREDUMP_CAPTURE_DRAM`
- `CONFIG_ESP_COREDUMP_MAX_TASKS_NUM`
- `CONFIG_ESP_COREDUMP_STACK_SIZE`
- `CONFIG_ESP_COREDUMP_SUMMARY_STACKDUMP_SIZE`

### CONFIG\_ESP\_COREDUMP\_TO\_FLASH\_OR\_UART

Data destination

*Found in:* [Component config > Core dump](#)

Select place to store core dump: flash, uart or none (to disable core dumps generation).

Core dumps to Flash are not available if PSRAM is used for task stacks.

If core dump is configured to be stored in flash and custom partition table is used add corresponding entry to your CSV. For examples, please see predefined partition table CSV descriptions in the `components/partition_table` directory.

Available options:

- Flash (CONFIG\_ESP\_COREDUMP\_ENABLE\_TO\_FLASH)
- UART (CONFIG\_ESP\_COREDUMP\_ENABLE\_TO\_UART)
- None (CONFIG\_ESP\_COREDUMP\_ENABLE\_TO\_NONE)

### CONFIG\_ESP\_COREDUMP\_DATA\_FORMAT

Core dump data format

*Found in: [Component config](#) > [Core dump](#)*

Select the data format for core dump.

Available options:

- Binary format (CONFIG\_ESP\_COREDUMP\_DATA\_FORMAT\_BIN)
- ELF format (CONFIG\_ESP\_COREDUMP\_DATA\_FORMAT\_ELF)

### CONFIG\_ESP\_COREDUMP\_CHECKSUM

Core dump data integrity check

*Found in: [Component config](#) > [Core dump](#)*

Select the integrity check for the core dump.

Available options:

- Use CRC32 for integrity verification (CONFIG\_ESP\_COREDUMP\_CHECKSUM\_CRC32)
- Use SHA256 for integrity verification (CONFIG\_ESP\_COREDUMP\_CHECKSUM\_SHA256)

### CONFIG\_ESP\_COREDUMP\_CAPTURE\_DRAM

Include whole .bss and .data sections and heap data into core dump file

*Found in: [Component config](#) > [Core dump](#)*

Storing these sections can help with easier debugging and troubleshooting. However, additional storage space will be required in the core dump partition. At least 128KB should be reserved, but the actual amount required may vary based on the application's DRAM usage. Note that sections located in external RAM will not be stored.

**Default value:**

- No (disabled) if [CONFIG\\_ESP\\_COREDUMP\\_DATA\\_FORMAT\\_ELF](#)

### CONFIG\_ESP\_COREDUMP\_CHECK\_BOOT

Check core dump data integrity on boot

*Found in: [Component config](#) > [Core dump](#)*

When enabled, if any data are found on the flash core dump partition, they will be checked by calculating their checksum.

**Default value:**

- Yes (enabled) if [CONFIG\\_ESP\\_COREDUMP\\_ENABLE\\_TO\\_FLASH](#)

### CONFIG\_ESP\_COREDUMP\_LOGS

Enable coredump logs for debugging

Found in: *Component config > Core dump*

Enable/disable coredump logs. Logs strings from `espcoredump` component are placed in DRAM. Disabling these helps to save ~5KB of internal memory.

### CONFIG\_ESP\_COREDUMP\_MAX\_TASKS\_NUM

Maximum number of tasks

Found in: *Component config > Core dump*

Maximum number of tasks snapshots in core dump.

### CONFIG\_ESP\_COREDUMP\_UART\_DELAY

Delay before print to UART

Found in: *Component config > Core dump*

Config delay (in ms) before printing core dump to UART. Delay can be interrupted by pressing Enter key.

**Default value:**

- 0 if `CONFIG_ESP_COREDUMP_ENABLE_TO_UART`

### CONFIG\_ESP\_COREDUMP\_FLASH\_NO\_OVERWRITE

Don't overwrite existing core dump

Found in: *Component config > Core dump*

Don't overwrite an existing core dump already present in flash. Enable this option to only keep the first of multiple core dumps.

If enabled, the core dump partition must be erased before the first core dump can be written.

**Default value:**

- No (disabled) if `CONFIG_ESP_COREDUMP_ENABLE_TO_FLASH`

### CONFIG\_ESP\_COREDUMP\_STACK\_SIZE

Reserved stack size

Found in: *Component config > Core dump*

Size of the memory to be reserved for core dump stack. If 0 core dump process will run on the stack of crashed task/ISR, otherwise special stack will be allocated. To ensure that core dump itself will not overflow task/ISR stack set this to the value around 1300-1800 depending on the chosen checksum calculation method. SHA256 method needs more stack space than CRC32. NOTE: It eats DRAM.

### CONFIG\_ESP\_COREDUMP\_SUMMARY\_STACKDUMP\_SIZE

Size of the stack dump buffer

Found in: *Component config > Core dump*

Size of the buffer that would be reserved for extracting backtrace info summary. This buffer will contain the stack dump of the crashed task. This dump is useful in generating backtrace

**Range:**

- from 512 to 4096 if `CONFIG_ESP_COREDUMP_DATA_FORMAT_ELF` && `CONFIG_ESP_COREDUMP_ENABLE_TO_FLASH`

**Default value:**

- 1024 if `CONFIG_ESP_COREDUMP_DATA_FORMAT_ELF` && `CONFIG_ESP_COREDUMP_ENABLE_TO_FLASH`

**CONFIG\_ESP\_COREDUMP\_DECODE**

Handling of UART core dumps in IDF Monitor

*Found in: Component config > Core dump*

Available options:

- Decode and show summary (info\_corefile) (CONFIG\_ESP\_COREDUMP\_DECODE\_INFO)
- Don't decode (CONFIG\_ESP\_COREDUMP\_DECODE\_DISABLE)

**FAT Filesystem support** Contains:

- `CONFIG_FATFS_API_ENCODING`
- `CONFIG_FATFS_VFS_FSTAT_BLKSIZE`
- `CONFIG_FATFS_IMMEDIATE_FSYNC`
- `CONFIG_FATFS_USE_FASTSEEK`
- `CONFIG_FATFS_LONG_FILENAMES`
- `CONFIG_FATFS_MAX_LFN`
- `CONFIG_FATFS_FS_LOCK`
- `CONFIG_FATFS_VOLUME_COUNT`
- `CONFIG_FATFS_CHOOSE_CODEPAGE`
- `CONFIG_FATFS_LINK_LOCK`
- `CONFIG_FATFS_ALLOC_PREFER_EXTRAM`
- `CONFIG_FATFS_SECTOR_SIZE`
- `CONFIG_FATFS_TIMEOUT_MS`
- `CONFIG_FATFS_USE_DYN_BUFFERS`
- `CONFIG_FATFS_USE_LABEL`
- `CONFIG_FATFS_PER_FILE_CACHE`

**CONFIG\_FATFS\_VOLUME\_COUNT**

Number of volumes

*Found in: Component config > FAT Filesystem support*

Number of volumes (logical drives) to use.

**Range:**

- from 1 to 10

**Default value:**

- 2

**CONFIG\_FATFS\_LONG\_FILENAMES**

Long filename support

*Found in: Component config > FAT Filesystem support*

Support long filenames in FAT. Long filename data increases memory usage. FATFS can be configured to store the buffer for long filename data in stack or heap.

Available options:



- No long filenames (CONFIG\_FATFS\_LFN\_NONE)
- Long filename buffer in heap (CONFIG\_FATFS\_LFN\_HEAP)
- Long filename buffer on stack (CONFIG\_FATFS\_LFN\_STACK)

### CONFIG\_FATFS\_SECTOR\_SIZE

Sector size

*Found in: [Component config > FAT Filesystem support](#)*

Specify the size of the sector in bytes for FATFS partition generator.

Available options:

- 512 (CONFIG\_FATFS\_SECTOR\_512)
- 4096 (CONFIG\_FATFS\_SECTOR\_4096)

### CONFIG\_FATFS\_CHOOSE\_CODEPAGE

OEM Code Page

*Found in: [Component config > FAT Filesystem support](#)*

OEM code page used for file name encodings.

If "Dynamic" is selected, code page can be chosen at runtime using `f_setcp` function. Note that choosing this option will increase application size by ~480kB.

Available options:

- Dynamic (all code pages supported) (CONFIG\_FATFS\_CODEPAGE\_DYNAMIC)
- US (CP437) (CONFIG\_FATFS\_CODEPAGE\_437)
- Arabic (CP720) (CONFIG\_FATFS\_CODEPAGE\_720)
- Greek (CP737) (CONFIG\_FATFS\_CODEPAGE\_737)
- KBL (CP771) (CONFIG\_FATFS\_CODEPAGE\_771)
- Baltic (CP775) (CONFIG\_FATFS\_CODEPAGE\_775)
- Latin 1 (CP850) (CONFIG\_FATFS\_CODEPAGE\_850)
- Latin 2 (CP852) (CONFIG\_FATFS\_CODEPAGE\_852)
- Cyrillic (CP855) (CONFIG\_FATFS\_CODEPAGE\_855)
- Turkish (CP857) (CONFIG\_FATFS\_CODEPAGE\_857)
- Portuguese (CP860) (CONFIG\_FATFS\_CODEPAGE\_860)
- Icelandic (CP861) (CONFIG\_FATFS\_CODEPAGE\_861)
- Hebrew (CP862) (CONFIG\_FATFS\_CODEPAGE\_862)
- Canadian French (CP863) (CONFIG\_FATFS\_CODEPAGE\_863)
- Arabic (CP864) (CONFIG\_FATFS\_CODEPAGE\_864)
- Nordic (CP865) (CONFIG\_FATFS\_CODEPAGE\_865)
- Russian (CP866) (CONFIG\_FATFS\_CODEPAGE\_866)
- Greek 2 (CP869) (CONFIG\_FATFS\_CODEPAGE\_869)
- Japanese (DBCS) (CP932) (CONFIG\_FATFS\_CODEPAGE\_932)
- Simplified Chinese (DBCS) (CP936) (CONFIG\_FATFS\_CODEPAGE\_936)
- Korean (DBCS) (CP949) (CONFIG\_FATFS\_CODEPAGE\_949)
- Traditional Chinese (DBCS) (CP950) (CONFIG\_FATFS\_CODEPAGE\_950)

### CONFIG\_FATFS\_MAX\_LFN

Max long filename length

*Found in: [Component config > FAT Filesystem support](#)*

Maximum long filename length. Can be reduced to save RAM.

## CONFIG\_FATFS\_API\_ENCODING

API character encoding

*Found in: [Component config](#) > [FAT Filesystem support](#)*

Choose encoding for character and string arguments/returns when using FATFS APIs. The encoding of arguments will usually depend on text editor settings.

Available options:

- API uses ANSI/OEM encoding (CONFIG\_FATFS\_API\_ENCODING\_ANSI\_OEM)
- API uses UTF-8 encoding (CONFIG\_FATFS\_API\_ENCODING\_UTF\_8)

## CONFIG\_FATFS\_FS\_LOCK

Number of simultaneously open files protected by lock function

*Found in: [Component config](#) > [FAT Filesystem support](#)*

This option sets the FATFS configuration value `_FS_LOCK`. The option `_FS_LOCK` switches file lock function to control duplicated file open and illegal operation to open objects.

\* 0: Disable file lock function. To avoid volume corruption, application should avoid illegal open, remove and rename to the open objects.

\* >0: Enable file lock function. The value defines how many files/sub-directories can be opened simultaneously under file lock control.

Note that the file lock control is independent of re-entrancy.

**Range:**

- from 0 to 65535

**Default value:**

- 0

## CONFIG\_FATFS\_TIMEOUT\_MS

Timeout for acquiring a file lock, ms

*Found in: [Component config](#) > [FAT Filesystem support](#)*

This option sets FATFS configuration value `_FS_TIMEOUT`, scaled to milliseconds. Sets the number of milliseconds FATFS will wait to acquire a mutex when operating on an open file. For example, if one task is performing a lengthy operation, another task will wait for the first task to release the lock, and time out after amount of time set by this option.

**Default value:**

- 10000

## CONFIG\_FATFS\_PER\_FILE\_CACHE

Use separate cache for each file

*Found in: [Component config](#) > [FAT Filesystem support](#)*

This option affects FATFS configuration value `_FS_TINY`.

If this option is set, `_FS_TINY` is 0, and each open file has its own cache, size of the cache is equal to the `_MAX_SS` variable (512 or 4096 bytes). This option uses more RAM if more than 1 file is open, but needs less reads and writes to the storage for some operations.

If this option is not set, `_FS_TINY` is 1, and single cache is used for all open files, size is also equal to `_MAX_SS` variable. This reduces the amount of heap used when multiple files are open, but increases the number of read and write operations which FATFS needs to make.

**Default value:**

- Yes (enabled)

**CONFIG\_FATFS\_ALLOC\_PREFER\_EXTRAM**

Prefer external RAM when allocating FATFS buffers

*Found in: [Component config](#) > [FAT Filesystem support](#)*

When the option is enabled, internal buffers used by FATFS will be allocated from external RAM. If the allocation from external RAM fails, the buffer will be allocated from the internal RAM. Disable this option if optimizing for performance. Enable this option if optimizing for internal memory size.

**Default value:**

- Yes (enabled) if SPIRAM\_USE\_CAPS\_ALLOC || SPIRAM\_USE\_MALLOC

**CONFIG\_FATFS\_USE\_FASTSEEK**

Enable fast seek algorithm when using lseek function through VFS FAT

*Found in: [Component config](#) > [FAT Filesystem support](#)*

The fast seek feature enables fast backward/long seek operations without FAT access by using an in-memory CLMT (cluster link map table). Please note, fast-seek is only allowed for read-mode files, if a file is opened in write-mode, the seek mechanism will automatically fallback to the default implementation.

**Default value:**

- No (disabled)

**CONFIG\_FATFS\_FAST\_SEEK\_BUFFER\_SIZE**

Fast seek CLMT buffer size

*Found in: [Component config](#) > [FAT Filesystem support](#) > [CONFIG\\_FATFS\\_USE\\_FASTSEEK](#)*

If fast seek algorithm is enabled, this defines the size of CLMT buffer used by this algorithm in 32-bit word units. This value should be chosen based on prior knowledge of maximum elements of each file entry would store.

**Default value:**

- 64 if [CONFIG\\_FATFS\\_USE\\_FASTSEEK](#)

**CONFIG\_FATFS\_VFS\_FSTAT\_BLKSIZE**

Default block size

*Found in: [Component config](#) > [FAT Filesystem support](#)*

If set to 0, the 'newlib' library's default size (BLKSIZ) is used (128 B). If set to a non-zero value, the value is used as the block size. Default file buffer size is set to this value and the buffer is allocated when first attempt of reading/writing to a file is made. Increasing this value improves fread() speed, however the heap usage is increased as well.

NOTE: The block size value is shared by all the filesystem functions accessing target media for given file descriptor! See 'Improving I/O performance' section of 'Maximizing Execution Speed' documentation page for more details.

**Default value:**

- 0

### CONFIG\_FATFS\_IMMEDIATE\_FSYNC

Enable automatic `f_sync`

*Found in: [Component config](#) > [FAT Filesystem support](#)*

Enables automatic calling of `f_sync()` to flush recent file changes after each call of `vfs_fat_write()`, `vfs_fat_pwrite()`, `vfs_fat_link()`, `vfs_fat_truncate()` and `vfs_fat_ftruncate()` functions. This feature improves file-consistency and size reporting accuracy for the FatFS, at a price on decreased performance due to frequent disk operations

**Default value:**

- No (disabled)

### CONFIG\_FATFS\_USE\_LABEL

Use FATFS volume label

*Found in: [Component config](#) > [FAT Filesystem support](#)*

Allows FATFS volume label to be specified using `f_setlabel`

**Default value:**

- No (disabled)

### CONFIG\_FATFS\_LINK\_LOCK

Perform the whole link operation under lock

*Found in: [Component config](#) > [FAT Filesystem support](#)*

If enabled, the whole link operation (including file copying) is performed under lock. This ensures that the link operation is atomic, but may cause performance for large files. It may create less fragmented file copy.

**Default value:**

- Yes (enabled)

### CONFIG\_FATFS\_USE\_DYN\_BUFFERS

Use dynamic buffers

*Found in: [Component config](#) > [FAT Filesystem support](#)*

If enabled, the buffers used by FATFS will be allocated separately from the rest of the structure. This option is useful when using multiple FATFS instances with different sector sizes, as the buffers will be allocated according to the sector size. If disabled, the greatest sector size will be used for all FATFS instances. (In most cases, this would be the sector size of Wear Levelling library) This might cause more memory to be used than necessary.

**Default value:**

- Yes (enabled) if `CONFIG_WL_SECTOR_SIZE_4096`

**FreeRTOS** Contains:

- [Kernel](#)
- [Port](#)

**Kernel** Contains:

- [CONFIG\\_FREERTOS\\_CHECK\\_STACKOVERFLOW](#)
- [CONFIG\\_FREERTOS\\_ENABLE\\_BACKWARD\\_COMPATIBILITY](#)
- [CONFIG\\_FREERTOS\\_GENERATE\\_RUN\\_TIME\\_STATS](#)
- [CONFIG\\_FREERTOS\\_MAX\\_TASK\\_NAME\\_LEN](#)

- `CONFIG_FREERTOS_IDLE_TASK_STACKSIZE`
- `CONFIG_FREERTOS_THREAD_LOCAL_STORAGE_POINTERS`
- `CONFIG_FREERTOS_QUEUE_REGISTRY_SIZE`
- `CONFIG_FREERTOS_TASK_NOTIFICATION_ARRAY_ENTRIES`
- `CONFIG_FREERTOS_HZ`
- `CONFIG_FREERTOS_TIMER_QUEUE_LENGTH`
- `CONFIG_FREERTOS_TIMER_SERVICE_TASK_CORE_AFFINITY`
- `CONFIG_FREERTOS_TIMER_SERVICE_TASK_NAME`
- `CONFIG_FREERTOS_TIMER_TASK_PRIORITY`
- `CONFIG_FREERTOS_TIMER_TASK_STACK_DEPTH`
- `CONFIG_FREERTOS_USE_APPLICATION_TASK_TAG`
- `CONFIG_FREERTOS_USE_IDLE_HOOK`
- `CONFIG_FREERTOS_USE_LIST_DATA_INTEGRITY_CHECK_BYTES`
- `CONFIG_FREERTOS_OPTIMIZED_SCHEDULER`
- `CONFIG_FREERTOS_USE_TICK_HOOK`
- `CONFIG_FREERTOS_USE_TICKLESS_IDLE`
- `CONFIG_FREERTOS_USE_TRACE_FACILITY`
- `CONFIG_FREERTOS_VTASKLIST_INCLUDE_COREID`
- `CONFIG_FREERTOS_UNICORE`
- `CONFIG_FREERTOS_SMP`
- `CONFIG_FREERTOS_USE_PASSIVE_IDLE_HOOK`

### CONFIG\_FREERTOS\_SMP

Run the Amazon SMP FreeRTOS kernel instead (FEATURE UNDER DEVELOPMENT)

*Found in:* [Component config > FreeRTOS > Kernel](#)

Amazon has released an SMP version of the FreeRTOS Kernel which can be found via the following link: <https://github.com/FreeRTOS/FreeRTOS-Kernel/tree/smp>

IDF has added an experimental port of this SMP kernel located in `components/freertos/FreeRTOS-Kernel-SMP`. Enabling this option will cause IDF to use the Amazon SMP kernel. Note that THIS FEATURE IS UNDER ACTIVE DEVELOPMENT, users use this at their own risk.

Leaving this option disabled will mean the IDF FreeRTOS kernel is used instead, which is located in: `components/freertos/FreeRTOS-Kernel`. Both kernel versions are SMP capable, but differ in their implementation and features.

**Default value:**

- No (disabled)

### CONFIG\_FREERTOS\_UNICORE

Run FreeRTOS only on first core

*Found in:* [Component config > FreeRTOS > Kernel](#)

This version of FreeRTOS normally takes control of all cores of the CPU. Select this if you only want to start it on the first core. This is needed when e.g. another process needs complete control over the second core.

### CONFIG\_FREERTOS\_HZ

`configTICK_RATE_HZ`

*Found in:* [Component config > FreeRTOS > Kernel](#)

Sets the FreeRTOS tick interrupt frequency in Hz (see `configTICK_RATE_HZ` documentation for more details).

**Range:**

- from 1 to 1000

**Default value:**

- 100

### CONFIG\_FREERTOS\_OPTIMIZED\_SCHEDULER

configUSE\_PORT\_OPTIMISED\_TASK\_SELECTION

*Found in: [Component config](#) > [FreeRTOS](#) > [Kernel](#)*

Enables port specific task selection method. This option can speed up the search of ready tasks when scheduling (see configUSE\_PORT\_OPTIMISED\_TASK\_SELECTION documentation for more details).

### CONFIG\_FREERTOS\_CHECK\_STACKOVERFLOW

configCHECK\_FOR\_STACK\_OVERFLOW

*Found in: [Component config](#) > [FreeRTOS](#) > [Kernel](#)*

Enables FreeRTOS to check for stack overflows (see configCHECK\_FOR\_STACK\_OVERFLOW documentation for more details).

Note: If users do not provide their own `vApplicationStackOverflowHook()` function, a default function will be provided by ESP-IDF.

Available options:

- No checking (CONFIG\_FREERTOS\_CHECK\_STACKOVERFLOW\_NONE)  
Do not check for stack overflows (configCHECK\_FOR\_STACK\_OVERFLOW = 0)
- Check by stack pointer value (Method 1) (CONFIG\_FREERTOS\_CHECK\_STACKOVERFLOW\_PTRVAL)  
Check for stack overflows on each context switch by checking if the stack pointer is in a valid range. Quick but does not detect stack overflows that happened between context switches (configCHECK\_FOR\_STACK\_OVERFLOW = 1)
- Check using canary bytes (Method 2) (CONFIG\_FREERTOS\_CHECK\_STACKOVERFLOW\_CANARY)  
Places some magic bytes at the end of the stack area and on each context switch, check if these bytes are still intact. More thorough than just checking the pointer, but also slightly slower. (configCHECK\_FOR\_STACK\_OVERFLOW = 2)

### CONFIG\_FREERTOS\_THREAD\_LOCAL\_STORAGE\_POINTERS

configNUM\_THREAD\_LOCAL\_STORAGE\_POINTERS

*Found in: [Component config](#) > [FreeRTOS](#) > [Kernel](#)*

Set the number of thread local storage pointers in each task (see configNUM\_THREAD\_LOCAL\_STORAGE\_POINTERS documentation for more details).

Note: In ESP-IDF, this value must be at least 1. Index 0 is reserved for use by the pthreads API thread-local-storage. Other indexes can be used for any desired purpose.

**Range:**

- from 1 to 256

**Default value:**

- 1

### CONFIG\_FREERTOS\_IDLE\_TASK\_STACKSIZE

configMINIMAL\_STACK\_SIZE (Idle task stack size)

Found in: [Component config](#) > [FreeRTOS](#) > [Kernel](#)

Sets the idle task stack size in bytes (see configMINIMAL\_STACK\_SIZE documentation for more details).

Note:

- ESP-IDF specifies stack sizes in bytes instead of words.
- The default size is enough for most use cases.
- The stack size may need to be increased above the default if the app installs idle or thread local storage cleanup hooks that use a lot of stack memory.
- Conversely, the stack size can be reduced to the minimum if non of the idle features are used.

**Range:**

- from 768 to 32768

**Default value:**

- 1536

### CONFIG\_FREERTOS\_USE\_IDLE\_HOOK

configUSE\_IDLE\_HOOK

Found in: [Component config](#) > [FreeRTOS](#) > [Kernel](#)

Enables the idle task application hook (see configUSE\_IDLE\_HOOK documentation for more details).

Note:

- The application must provide the hook function `void vApplicationIdleHook( void );`
- `vApplicationIdleHook()` is called from FreeRTOS idle task(s)
- The FreeRTOS idle hook is NOT the same as the ESP-IDF Idle Hook, but both can be enabled simultaneously.

**Default value:**

- No (disabled)

### CONFIG\_FREERTOS\_USE\_PASSIVE\_IDLE\_HOOK

Use FreeRTOS minimal idle hook

Found in: [Component config](#) > [FreeRTOS](#) > [Kernel](#)

Enables the minimal idle task application hook (see configUSE\_IDLE\_HOOK documentation for more details).

Note:

- The application must provide the hook function `void vApplicationPassiveIdleHook( void );`
- `vApplicationPassiveIdleHook()` is called from FreeRTOS minimal idle task(s)

**Default value:**

- No (disabled) if [CONFIG\\_FREERTOS\\_SMP](#)

### CONFIG\_FREERTOS\_USE\_TICK\_HOOK

configUSE\_TICK\_HOOK

Found in: [Component config](#) > [FreeRTOS](#) > [Kernel](#)

Enables the tick hook (see configUSE\_TICK\_HOOK documentation for more details).

Note:

- The application must provide the hook function `void vApplicationTickHook( void ) ;`
- `vApplicationTickHook()` is called from FreeRTOS's tick handling function `xTaskIncrementTick()`
- The FreeRTOS tick hook is NOT the same as the ESP-IDF Tick Interrupt Hook, but both can be enabled simultaneously.

**Default value:**

- No (disabled)

### **CONFIG\_FREERTOS\_MAX\_TASK\_NAME\_LEN**

`configMAX_TASK_NAME_LEN`

*Found in: [Component config](#) > [FreeRTOS](#) > [Kernel](#)*

Sets the maximum number of characters for task names (see `configMAX_TASK_NAME_LEN` documentation for more details).

Note: For most uses, the default of 16 characters is sufficient.

**Range:**

- from 1 to 256

**Default value:**

- 16

### **CONFIG\_FREERTOS\_ENABLE\_BACKWARD\_COMPATIBILITY**

`configENABLE_BACKWARD_COMPATIBILITY`

*Found in: [Component config](#) > [FreeRTOS](#) > [Kernel](#)*

Enable backward compatibility with APIs prior to FreeRTOS v8.0.0. (see `configENABLE_BACKWARD_COMPATIBILITY` documentation for more details).

**Default value:**

- No (disabled)

### **CONFIG\_FREERTOS\_TIMER\_SERVICE\_TASK\_NAME**

`configTIMER_SERVICE_TASK_NAME`

*Found in: [Component config](#) > [FreeRTOS](#) > [Kernel](#)*

Sets the timer task's name (see `configTIMER_SERVICE_TASK_NAME` documentation for more details).

**Default value:**

- "Tmr Svc"

### **CONFIG\_FREERTOS\_TIMER\_SERVICE\_TASK\_CORE\_AFFINITY**

`configTIMER_SERVICE_TASK_CORE_AFFINITY`

*Found in: [Component config](#) > [FreeRTOS](#) > [Kernel](#)*

Sets the timer task's core affinity (see `configTIMER_SERVICE_TASK_CORE_AFFINITY` documentation for more details).

Available options:

- CPU0 (`CONFIG_FREERTOS_TIMER_TASK_AFFINITY_CPU0`)



- CPU1 (CONFIG\_FREERTOS\_TIMER\_TASK\_AFFINITY\_CPU1)
- No affinity (CONFIG\_FREERTOS\_TIMER\_TASK\_NO\_AFFINITY)

### CONFIG\_FREERTOS\_TIMER\_TASK\_PRIORITY

configTIMER\_TASK\_PRIORITY

*Found in: [Component config](#) > [FreeRTOS](#) > [Kernel](#)*

Sets the timer task's priority (see configTIMER\_TASK\_PRIORITY documentation for more details).

**Range:**

- from 1 to 25

**Default value:**

- 1

### CONFIG\_FREERTOS\_TIMER\_TASK\_STACK\_DEPTH

configTIMER\_TASK\_STACK\_DEPTH

*Found in: [Component config](#) > [FreeRTOS](#) > [Kernel](#)*

Set the timer task's stack size (see configTIMER\_TASK\_STACK\_DEPTH documentation for more details).

**Range:**

- from 1536 to 32768

**Default value:**

- 2048

### CONFIG\_FREERTOS\_TIMER\_QUEUE\_LENGTH

configTIMER\_QUEUE\_LENGTH

*Found in: [Component config](#) > [FreeRTOS](#) > [Kernel](#)*

Set the timer task's command queue length (see configTIMER\_QUEUE\_LENGTH documentation for more details).

**Range:**

- from 5 to 20

**Default value:**

- 10

### CONFIG\_FREERTOS\_QUEUE\_REGISTRY\_SIZE

configQUEUE\_REGISTRY\_SIZE

*Found in: [Component config](#) > [FreeRTOS](#) > [Kernel](#)*

Set the size of the queue registry (see configQUEUE\_REGISTRY\_SIZE documentation for more details).

Note: A value of 0 will disable queue registry functionality

**Range:**

- from 0 to 20

**Default value:**

- 0

### CONFIG\_FREERTOS\_TASK\_NOTIFICATION\_ARRAY\_ENTRIES

configTASK\_NOTIFICATION\_ARRAY\_ENTRIES

*Found in: [Component config](#) > [FreeRTOS](#) > [Kernel](#)*

Set the size of the task notification array of each task. When increasing this value, keep in mind that this means additional memory for each and every task on the system. However, task notifications in general are more light weight compared to alternatives such as semaphores.

**Range:**

- from 1 to 32

**Default value:**

- 1

### CONFIG\_FREERTOS\_USE\_TRACE\_FACILITY

configUSE\_TRACE\_FACILITY

*Found in: [Component config](#) > [FreeRTOS](#) > [Kernel](#)*

Enables additional structure members and functions to assist with execution visualization and tracing (see configUSE\_TRACE\_FACILITY documentation for more details).

**Default value:**

- No (disabled)

### CONFIG\_FREERTOS\_USE\_STATS\_FORMATTING\_FUNCTIONS

configUSE\_STATS\_FORMATTING\_FUNCTIONS

*Found in: [Component config](#) > [FreeRTOS](#) > [Kernel](#) > [CONFIG\\_FREERTOS\\_USE\\_TRACE\\_FACILITY](#)*

Set configUSE\_TRACE\_FACILITY and configUSE\_STATS\_FORMATTING\_FUNCTIONS to 1 to include the vTaskList() and vTaskGetRunTimeStats() functions in the build (see configUSE\_STATS\_FORMATTING\_FUNCTIONS documentation for more details).

**Default value:**

- No (disabled) if [CONFIG\\_FREERTOS\\_USE\\_TRACE\\_FACILITY](#)

### CONFIG\_FREERTOS\_USE\_LIST\_DATA\_INTEGRITY\_CHECK\_BYTES

configUSE\_LIST\_DATA\_INTEGRITY\_CHECK\_BYTES

*Found in: [Component config](#) > [FreeRTOS](#) > [Kernel](#)*

Enable list integrity checker (see configUSE\_LIST\_DATA\_INTEGRITY\_CHECK\_BYTES documentation for more details).

**Default value:**

- No (disabled)

### CONFIG\_FREERTOS\_VTASKLIST\_INCLUDE\_COREID

Enable display of xCoreID in vTaskList

*Found in: [Component config](#) > [FreeRTOS](#) > [Kernel](#)*

If enabled, this will include an extra column when vTaskList is called to display the CoreID the task is pinned to (0,1) or -1 if not pinned.

## CONFIG\_FREERTOS\_GENERATE\_RUN\_TIME\_STATS

configGENERATE\_RUN\_TIME\_STATS

Found in: [Component config](#) > [FreeRTOS](#) > [Kernel](#)

Enables collection of run time statistics for each task (see configGENERATE\_RUN\_TIME\_STATS documentation for more details).

Note: The clock used for run time statistics can be configured in FREERTOS\_RUN\_TIME\_STATS\_CLK.

**Default value:**

- No (disabled)

## CONFIG\_FREERTOS\_RUN\_TIME\_COUNTER\_TYPE

configRUN\_TIME\_COUNTER\_TYPE

Found in: [Component config](#) > [FreeRTOS](#) > [Kernel](#) > [CONFIG\\_FREERTOS\\_GENERATE\\_RUN\\_TIME\\_STATS](#)

Sets the data type used for the FreeRTOS run time stats. A larger data type can be used to reduce the frequency of the counter overflowing.

Available options:

- uint32\_t (CONFIG\_FREERTOS\_RUN\_TIME\_COUNTER\_TYPE\_U32)  
configRUN\_TIME\_COUNTER\_TYPE is set to uint32\_t
- uint64\_t (CONFIG\_FREERTOS\_RUN\_TIME\_COUNTER\_TYPE\_U64)  
configRUN\_TIME\_COUNTER\_TYPE is set to uint64\_t

## CONFIG\_FREERTOS\_USE\_TICKLESS\_IDLE

configUSE\_TICKLESS\_IDLE

Found in: [Component config](#) > [FreeRTOS](#) > [Kernel](#)

If power management support is enabled, FreeRTOS will be able to put the system into light sleep mode when no tasks need to run for a number of ticks. This number can be set using FREERTOS\_IDLE\_TIME\_BEFORE\_SLEEP option. This feature is also known as "automatic light sleep".

Note that timers created using esp\_timer APIs may prevent the system from entering sleep mode, even when no tasks need to run. To skip unnecessary wake-up initialize a timer with the "skip\_unhandled\_events" option as true.

If disabled, automatic light sleep support will be disabled.

**Default value:**

- No (disabled) if [CONFIG\\_PM\\_ENABLE](#)

## CONFIG\_FREERTOS\_IDLE\_TIME\_BEFORE\_SLEEP

configEXPECTED\_IDLE\_TIME\_BEFORE\_SLEEP

Found in: [Component config](#) > [FreeRTOS](#) > [Kernel](#) > [CONFIG\\_FREERTOS\\_USE\\_TICKLESS\\_IDLE](#)

FreeRTOS will enter light sleep mode if no tasks need to run for this number of ticks. You can enable PM\_PROFILING feature in esp\_pm components and dump the sleep status with esp\_pm\_dump\_locks, if the proportion of rejected sleeps is too high, please increase this value to improve scheduling efficiency

**Range:**

- from 2 to 4294967295 if [CONFIG\\_FREERTOS\\_USE\\_TICKLESS\\_IDLE](#)

**Default value:**

- 3 if [CONFIG\\_FREERTOS\\_USE\\_TICKLESS\\_IDLE](#)

## CONFIG\_FREERTOS\_USE\_APPLICATION\_TASK\_TAG

configUSE\_APPLICATION\_TASK\_TAG

Found in: *Component config > FreeRTOS > Kernel*

Enables task tagging functionality and its associated API (see configUSE\_APPLICATION\_TASK\_TAG documentation for more details).

**Default value:**

- No (disabled)

**Port** Contains:

- *CONFIG\_FREERTOS\_CHECK\_MUTEX\_GIVEN\_BY\_OWNER*
- *CONFIG\_FREERTOS\_RUN\_TIME\_STATS\_CLK*
- *CONFIG\_FREERTOS\_INTERRUPT\_BACKTRACE*
- *CONFIG\_FREERTOS\_WATCHPOINT\_END\_OF\_STACK*
- *CONFIG\_FREERTOS\_ENABLE\_STATIC\_TASK\_CLEAN\_UP*
- *CONFIG\_FREERTOS\_TASK\_PRE\_DELETION\_HOOK*
- *CONFIG\_FREERTOS\_TLSP\_DELETION\_CALLBACKS*
- *CONFIG\_FREERTOS\_ISR\_STACKSIZE*
- *CONFIG\_FREERTOS\_PLACE\_FUNCTIONS\_INTO\_FLASH*
- *CONFIG\_FREERTOS\_CHECK\_PORT\_CRITICAL\_COMPLIANCE*
- *CONFIG\_FREERTOS\_CORETIMER*
- *CONFIG\_FREERTOS\_TASK\_FUNCTION\_WRAPPER*

## CONFIG\_FREERTOS\_TASK\_FUNCTION\_WRAPPER

Wrap task functions

Found in: *Component config > FreeRTOS > Port*

If enabled, all FreeRTOS task functions will be enclosed in a wrapper function. If a task function mistakenly returns (i.e. does not delete), the call flow will return to the wrapper function. The wrapper function will then log an error and abort the application. This option is also required for GDB backtraces and C++ exceptions to work correctly inside top-level task functions.

**Default value:**

- Yes (enabled)

## CONFIG\_FREERTOS\_WATCHPOINT\_END\_OF\_STACK

Enable stack overflow debug watchpoint

Found in: *Component config > FreeRTOS > Port*

FreeRTOS can check if a stack has overflowed its bounds by checking either the value of the stack pointer or by checking the integrity of canary bytes. (See FREERTOS\_CHECK\_STACKOVERFLOW for more information.) These checks only happen on a context switch, and the situation that caused the stack overflow may already be long gone by then. This option will use the last debug memory watchpoint to allow breaking into the debugger (or panicking) as soon as any of the last 32 bytes on the stack of a task are overwritten. The side effect is that using gdb, you effectively have one hardware watchpoint less because the last one is overwritten as soon as a task switch happens.

Another consequence is that due to alignment requirements of the watchpoint, the usable stack size decreases by up to 60 bytes. This is because the watchpoint region has to be aligned to its size and the size for the stack watchpoint in IDF is 32 bytes.

This check only triggers if the stack overflow writes within 32 bytes near the end of the stack, rather than overshooting further, so it is worth combining this approach with one of the other stack overflow check methods.

When this watchpoint is hit, gdb will stop with a SIGTRAP message. When no JTAG OCD is attached, esp-idf will panic on an unhandled debug exception.

**Default value:**

- No (disabled)

### CONFIG\_FREERTOS\_TLSP\_DELETION\_CALLBACKS

Enable thread local storage pointers deletion callbacks

*Found in: [Component config](#) > [FreeRTOS](#) > [Port](#)*

ESP-IDF provides users with the ability to free TLSP memory by registering TLSP deletion callbacks. These callbacks are automatically called by FreeRTOS when a task is deleted. When this option is turned on, the memory reserved for TLSPs in the TCB is doubled to make space for storing the deletion callbacks. If the user does not wish to use TLSP deletion callbacks then this option could be turned off to save space in the TCB memory.

**Default value:**

- Yes (enabled)

### CONFIG\_FREERTOS\_TASK\_PRE\_DELETION\_HOOK

Enable task pre-deletion hook

*Found in: [Component config](#) > [FreeRTOS](#) > [Port](#)*

Enable this option to make FreeRTOS call a user provided hook function right before it deletes a task (i.e., frees/releases a dynamically/statically allocated task's memory). This is useful if users want to know when a task is actually deleted (in case the task's deletion is delegated to the IDLE task).

If this config option is enabled, users must define a `void vTaskPreDeletionHook( void \* pxtcb )` hook function in their application.

### CONFIG\_FREERTOS\_ENABLE\_STATIC\_TASK\_CLEAN\_UP

Enable static task clean up hook (DEPRECATED)

*Found in: [Component config](#) > [FreeRTOS](#) > [Port](#)*

THIS OPTION IS DEPRECATED. Use FREERTOS\_TASK\_PRE\_DELETION\_HOOK instead.

Enable this option to make FreeRTOS call the static task clean up hook when a task is deleted.

Note: Users will need to provide a `void vPortCleanUpTCB ( void \*pxTCB )` callback

**Default value:**

- No (disabled)

### CONFIG\_FREERTOS\_CHECK\_MUTEX\_GIVEN\_BY\_OWNER

Check that mutex semaphore is given by owner task

*Found in: [Component config](#) > [FreeRTOS](#) > [Port](#)*

If enabled, assert that when a mutex semaphore is given, the task giving the semaphore is the task which is currently holding the mutex.

### CONFIG\_FREERTOS\_ISR\_STACKSIZE

ISR stack size

*Found in: [Component config](#) > [FreeRTOS](#) > [Port](#)*

The interrupt handlers have their own stack. The size of the stack can be defined here. Each processor has its own stack, so the total size occupied will be twice this.

**Range:**

- from 2096 to 32768 if `CONFIG_ESP_COREDUMP_DATA_FORMAT_ELF`
- from 1536 to 32768

**Default value:**

- 2096 if `CONFIG_ESP_COREDUMP_DATA_FORMAT_ELF`
- 1536

## CONFIG\_FREERTOS\_INTERRUPT\_BACKTRACE

Enable backtrace from interrupt to task context

*Found in: [Component config](#) > [FreeRTOS](#) > [Port](#)*

If this option is enabled, interrupt stack frame will be modified to point to the code of the interrupted task as its return address. This helps the debugger (or the panic handler) show a backtrace from the interrupt to the task which was interrupted. This also works for nested interrupts: higher level interrupt stack can be traced back to the lower level interrupt. This option adds 4 instructions to the interrupt dispatching code.

**Default value:**

- Yes (enabled)

## CONFIG\_FREERTOS\_CORETIMER

Tick timer source (Xtensa Only)

*Found in: [Component config](#) > [FreeRTOS](#) > [Port](#)*

FreeRTOS needs a timer with an associated interrupt to use as the main tick source to increase counters, run timers and do pre-emptive multitasking with. There are multiple timers available to do this, with different interrupt priorities.

Available options:

- Timer 0 (int 6, level 1) (`CONFIG_FREERTOS_CORETIMER_0`)  
Select this to use timer 0
- Timer 1 (int 15, level 3) (`CONFIG_FREERTOS_CORETIMER_1`)  
Select this to use timer 1
- SYSTIMER 0 (level 1) (`CONFIG_FREERTOS_CORETIMER_SYSTIMER_LVL1`)  
Select this to use systimer with the 1 interrupt priority.
- SYSTIMER 0 (level 3) (`CONFIG_FREERTOS_CORETIMER_SYSTIMER_LVL3`)  
Select this to use systimer with the 3 interrupt priority.

## CONFIG\_FREERTOS\_RUN\_TIME\_STATS\_CLK

Choose the clock source for run time stats

*Found in: [Component config](#) > [FreeRTOS](#) > [Port](#)*

Choose the clock source for FreeRTOS run time stats. Options are CPU0's CPU Clock or the ESP Timer. Both clock sources are 32 bits. The CPU Clock can run at a higher frequency hence provide a finer resolution but will overflow much quicker. Note that run time stats are only valid until the clock source overflows.

Available options:

- Use ESP TIMER for run time stats (CONFIG\_FREERTOS\_RUN\_TIME\_STATS\_USING\_ESP\_TIMER)  
ESP Timer will be used as the clock source for FreeRTOS run time stats. The ESP Timer runs at a frequency of 1MHz regardless of Dynamic Frequency Scaling. Therefore the ESP Timer will overflow in approximately 4290 seconds.
- Use CPU Clock for run time stats (CONFIG\_FREERTOS\_RUN\_TIME\_STATS\_USING\_CPU\_CLK)  
CPU Clock will be used as the clock source for the generation of run time stats. The CPU Clock has a frequency dependent on ESP\_DEFAULT\_CPU\_FREQ\_MHZ and Dynamic Frequency Scaling (DFS). Therefore the CPU Clock frequency can fluctuate between 80 to 240MHz. Run time stats generated using the CPU Clock represents the number of CPU cycles each task is allocated and DOES NOT reflect the amount of time each task runs for (as CPU clock frequency can change). If the CPU clock consistently runs at the maximum frequency of 240MHz, it will overflow in approximately 17 seconds.

### CONFIG\_FREERTOS\_PLACE\_FUNCTIONS\_INTO\_FLASH

Place FreeRTOS functions into Flash

*Found in: Component config > FreeRTOS > Port*

When enabled the selected Non-ISR FreeRTOS functions will be placed into Flash memory instead of IRAM. This saves up to 8KB of IRAM depending on which functions are used.

**Default value:**

- No (disabled)

### CONFIG\_FREERTOS\_CHECK\_PORT\_CRITICAL\_COMPLIANCE

Tests compliance with Vanilla FreeRTOS port\*\_CRITICAL calls

*Found in: Component config > FreeRTOS > Port*

If enabled, context of port\*\_CRITICAL calls (ISR or Non-ISR) would be checked to be in compliance with Vanilla FreeRTOS. e.g Calling port\*\_CRITICAL from ISR context would cause assert failure

**Default value:**

- No (disabled)

**Hardware Abstraction Layer (HAL) and Low Level (LL)** Contains:

- [CONFIG\\_HAL\\_DEFAULT\\_ASSERTION\\_LEVEL](#)
- [CONFIG\\_HAL\\_LOG\\_LEVEL](#)
- [CONFIG\\_HAL\\_SYSTIMER\\_USE\\_ROM\\_IMPL](#)
- [CONFIG\\_HAL\\_WDT\\_USE\\_ROM\\_IMPL](#)

### CONFIG\_HAL\_DEFAULT\_ASSERTION\_LEVEL

Default HAL assertion level

*Found in: Component config > Hardware Abstraction Layer (HAL) and Low Level (LL)*

Set the assert behavior / level for HAL component. HAL component assert level can be set separately, but the level can't exceed the system assertion level. e.g. If the system assertion is disabled, then the HAL assertion can't be enabled either. If the system assertion is enable, then the HAL assertion can still be disabled by this Kconfig option.

Available options:

- Same as system assertion level (CONFIG\_HAL\_ASSERTION\_EQUALS\_SYSTEM)
- Disabled (CONFIG\_HAL\_ASSERTION\_DISABLE)
- Silent (CONFIG\_HAL\_ASSERTION\_SILENT)

- Enabled (CONFIG\_HAL\_ASSERTION\_ENABLE)

### CONFIG\_HAL\_LOG\_LEVEL

HAL layer log verbosity

*Found in: Component config > Hardware Abstraction Layer (HAL) and Low Level (LL)*

Specify how much output to see in HAL logs.

Available options:

- No output (CONFIG\_HAL\_LOG\_LEVEL\_NONE)
- Error (CONFIG\_HAL\_LOG\_LEVEL\_ERROR)
- Warning (CONFIG\_HAL\_LOG\_LEVEL\_WARN)
- Info (CONFIG\_HAL\_LOG\_LEVEL\_INFO)
- Debug (CONFIG\_HAL\_LOG\_LEVEL\_DEBUG)
- Verbose (CONFIG\_HAL\_LOG\_LEVEL\_VERBOSE)

### CONFIG\_HAL\_SYSTIMER\_USE\_ROM\_IMPL

Use ROM implementation of SysTimer HAL driver

*Found in: Component config > Hardware Abstraction Layer (HAL) and Low Level (LL)*

Enable this flag to use HAL functions from ROM instead of ESP-IDF.

If keeping this as "n" in your project, you will have less free IRAM. If making this as "y" in your project, you will increase free IRAM, but you will lose the possibility to debug this module, and some new features will be added and bugs will be fixed in the IDF source but cannot be synced to ROM.

**Default value:**

- Yes (enabled)

### CONFIG\_HAL\_WDT\_USE\_ROM\_IMPL

Use ROM implementation of WDT HAL driver

*Found in: Component config > Hardware Abstraction Layer (HAL) and Low Level (LL)*

Enable this flag to use HAL functions from ROM instead of ESP-IDF.

If keeping this as "n" in your project, you will have less free IRAM. If making this as "y" in your project, you will increase free IRAM, but you will lose the possibility to debug this module, and some new features will be added and bugs will be fixed in the IDF source but cannot be synced to ROM.

**Default value:**

- Yes (enabled)

**Heap memory debugging** Contains:

- *CONFIG\_HEAP\_ABORT\_WHEN\_ALLOCATION\_FAILS*
- *CONFIG\_HEAP\_TASK\_TRACKING*
- *CONFIG\_HEAP\_PLACE\_FUNCTION\_INTO\_FLASH*
- *CONFIG\_HEAP\_CORRUPTION\_DETECTION*
- *CONFIG\_HEAP\_TRACING\_DEST*
- *CONFIG\_HEAP\_TRACING\_STACK\_DEPTH*
- *CONFIG\_HEAP\_USE\_HOOKS*
- *CONFIG\_HEAP\_TRACE\_HASH\_MAP*
- *CONFIG\_HEAP\_TLSF\_USE\_ROM\_IMPL*



## CONFIG\_HEAP\_CORRUPTION\_DETECTION

Heap corruption detection

*Found in: [Component config](#) > [Heap memory debugging](#)*

Enable heap poisoning features to detect heap corruption caused by out-of-bounds access to heap memory.

See the "Heap Memory Debugging" page of the IDF documentation for a description of each level of heap corruption detection.

Available options:

- Basic (no poisoning) (CONFIG\_HEAP\_POISONING\_DISABLED)
- Light impact (CONFIG\_HEAP\_POISONING\_LIGHT)
- Comprehensive (CONFIG\_HEAP\_POISONING\_COMPREHENSIVE)

## CONFIG\_HEAP\_TRACING\_DEST

Heap tracing

*Found in: [Component config](#) > [Heap memory debugging](#)*

Enables the heap tracing API defined in esp\_heap\_trace.h.

This function causes a moderate increase in IRAM code size and a minor increase in heap function (malloc/free/realloc) CPU overhead, even when the tracing feature is not used. So it's best to keep it disabled unless tracing is being used.

Available options:

- Disabled (CONFIG\_HEAP\_TRACING\_OFF)
- Standalone (CONFIG\_HEAP\_TRACING\_STANDALONE)
- Host-based (CONFIG\_HEAP\_TRACING\_TOHOST)

## CONFIG\_HEAP\_TRACING\_STACK\_DEPTH

Heap tracing stack depth

*Found in: [Component config](#) > [Heap memory debugging](#)*

Number of stack frames to save when tracing heap operation callers.

More stack frames uses more memory in the heap trace buffer (and slows down allocation), but can provide useful information.

## CONFIG\_HEAP\_USE\_HOOKS

Use allocation and free hooks

*Found in: [Component config](#) > [Heap memory debugging](#)*

Enable the user to implement function hooks triggered for each successful allocation and free.

## CONFIG\_HEAP\_TASK\_TRACKING

Enable heap task tracking

*Found in: [Component config](#) > [Heap memory debugging](#)*

Enables tracking the task responsible for each heap allocation.

This function depends on heap poisoning being enabled and adds four more bytes of overhead for each block allocated.

### **CONFIG\_HEAP\_TRACE\_HASH\_MAP**

Use hash map mechanism to access heap trace records

*Found in: [Component config](#) > [Heap memory debugging](#)*

Enable this flag to use a hash map to increase performance in handling heap trace records.

Heap trace standalone supports storing records as a list, or a list + hash map.

Using only a list takes less memory, but calls to 'free' will get slower as the list grows. This is particularly affected when using HEAP\_TRACE\_ALL mode.

By using a list + hash map, calls to 'free' remain fast, at the cost of additional memory to store the hash map.

**Default value:**

- No (disabled) if [CONFIG\\_HEAP\\_TRACING\\_STANDALONE](#)

### **CONFIG\_HEAP\_TRACE\_HASH\_MAP\_IN\_EXT\_RAM**

Place hash map in external RAM

*Found in: [Component config](#) > [Heap memory debugging](#) > [CONFIG\\_HEAP\\_TRACE\\_HASH\\_MAP](#)*

When enabled this configuration forces the hash map to be placed in external RAM.

**Default value:**

- No (disabled) if [CONFIG\\_HEAP\\_TRACE\\_HASH\\_MAP](#)

### **CONFIG\_HEAP\_TRACE\_HASH\_MAP\_SIZE**

The number of entries in the hash map

*Found in: [Component config](#) > [Heap memory debugging](#) > [CONFIG\\_HEAP\\_TRACE\\_HASH\\_MAP](#)*

Defines the number of entries in the heap trace hashmap. Each entry takes 8 bytes. The bigger this number is, the better the performance. Recommended range: 200 - 2000.

**Default value:**

- 512 if [CONFIG\\_HEAP\\_TRACE\\_HASH\\_MAP](#)

### **CONFIG\_HEAP\_ABORT\_WHEN\_ALLOCATION\_FAILS**

Abort if memory allocation fails

*Found in: [Component config](#) > [Heap memory debugging](#)*

When enabled, if a memory allocation operation fails it will cause a system abort.

**Default value:**

- No (disabled)

### **CONFIG\_HEAP\_TLSF\_USE\_ROM\_IMPL**

Use ROM implementation of heap tlsf library

*Found in: [Component config](#) > [Heap memory debugging](#)*

Enable this flag to use heap functions from ROM instead of ESP-IDF.

If keeping this as "n" in your project, you will have less free IRAM. If making this as "y" in your project, you will increase free IRAM, but you will lose the possibility to debug this module, and some new features will be added and bugs will be fixed in the IDF source but cannot be synced to ROM.

**Default value:**

- Yes (enabled)

**CONFIG\_HEAP\_PLACE\_FUNCTION\_INTO\_FLASH**

Force the entire heap component to be placed in flash memory

*Found in: [Component config](#) > [Heap memory debugging](#)*

Enable this flag to save up RAM space by placing the heap component in the flash memory

Note that it is only safe to enable this configuration if no functions from `esp_heap_caps.h` or `esp_heap_trace.h` are called from ISR.

**IEEE 802.15.4** Contains:

- [CONFIG\\_IEEE802154\\_ENABLED](#)

**CONFIG\_IEEE802154\_ENABLED**

IEEE802154 Enable

*Found in: [Component config](#) > [IEEE 802.15.4](#)*

**Default value:**

- Yes (enabled)

**CONFIG\_IEEE802154\_RX\_BUFFER\_SIZE**

The number of 802.15.4 receive buffers

*Found in: [Component config](#) > [IEEE 802.15.4](#) > [CONFIG\\_IEEE802154\\_ENABLED](#)*

The number of 802.15.4 receive buffers

**Range:**

- from 2 to 100

**Default value:**

- 20

**CONFIG\_IEEE802154\_CCA\_MODE**

Clear Channel Assessment (CCA) mode

*Found in: [Component config](#) > [IEEE 802.15.4](#) > [CONFIG\\_IEEE802154\\_ENABLED](#)*

configure the CCA mode

Available options:

- Carrier sense only ([CONFIG\\_IEEE802154\\_CCA\\_CARRIER](#))  
configure the CCA mode to Energy above threshold
- Energy above threshold ([CONFIG\\_IEEE802154\\_CCA\\_ED](#))  
configure the CCA mode to Energy above threshold
- Carrier sense OR energy above threshold ([CONFIG\\_IEEE802154\\_CCA\\_CARRIER\\_OR\\_ED](#))  
configure the CCA mode to Carrier sense OR energy above threshold

- Carrier sense AND energy above threshold (CONFIG\_IEEE802154\_CCA\_CARRIER\_AND\_ED)  
configure the CCA mode to Carrier sense AND energy above threshold

### CONFIG\_IEEE802154\_CCA\_THRESHOLD

CCA detection threshold

*Found in: Component config > IEEE 802.15.4 > CONFIG\_IEEE802154\_ENABLED*

set the CCA threshold, in dB

**Range:**

- from -120 to 0

**Default value:**

- "-60"

### CONFIG\_IEEE802154\_PENDING\_TABLE\_SIZE

Pending table size

*Found in: Component config > IEEE 802.15.4 > CONFIG\_IEEE802154\_ENABLED*

set the pending table size

**Range:**

- from 1 to 100

**Default value:**

- 20

### CONFIG\_IEEE802154\_MULTI\_PAN\_ENABLE

Enable multi-pan feature for frame filter

*Found in: Component config > IEEE 802.15.4 > CONFIG\_IEEE802154\_ENABLED*

Enable IEEE802154 multi-pan

**Default value:**

- No (disabled)

### CONFIG\_IEEE802154\_TIMING\_OPTIMIZATION

Enable throughput optimization

*Found in: Component config > IEEE 802.15.4 > CONFIG\_IEEE802154\_ENABLED*

Enabling this option increases throughput by ~5% at the expense of ~2.1k IRAM code size increase.

**Default value:**

- No (disabled)

### CONFIG\_IEEE802154\_SLEEP\_ENABLE

Enable IEEE802154 light sleep

*Found in: Component config > IEEE 802.15.4 > CONFIG\_IEEE802154\_ENABLED*

Enabling this option allows the IEEE802.15.4 module to be powered down during automatic light sleep, which reduces current consumption.

**Default value:**

- No (disabled) if *CONFIG\_PM\_ENABLE* && *CONFIG\_IEEE802154\_ENABLED*

### CONFIG\_IEEE802154\_DEBUG

Enable IEEE802154 Debug

*Found in: Component config > IEEE 802.15.4 > CONFIG\_IEEE802154\_ENABLED*

Enabling this option allows different kinds of IEEE802154 debug output. All IEEE802154 debug features increase the size of the final binary.

**Default value:**

- No (disabled)

Contains:

- *CONFIG\_IEEE802154\_RECORD\_ABORT*
- *CONFIG\_IEEE802154\_RECORD\_CMD*
- *CONFIG\_IEEE802154\_RECORD\_EVENT*
- *CONFIG\_IEEE802154\_RECORD\_STATE*
- *CONFIG\_IEEE802154\_TXRX\_STATISTIC*
- *CONFIG\_IEEE802154\_ASSERT*

### CONFIG\_IEEE802154\_ASSERT

Enrich the assert information with IEEE802154 state and event

*Found in: Component config > IEEE 802.15.4 > CONFIG\_IEEE802154\_ENABLED > CONFIG\_IEEE802154\_DEBUG*

Enabling this option to add some probe codes in the driver, and these informations will be printed when assert.

**Default value:**

- No (disabled) if *CONFIG\_IEEE802154\_DEBUG*

### CONFIG\_IEEE802154\_RECORD\_EVENT

Enable record event information for debugging

*Found in: Component config > IEEE 802.15.4 > CONFIG\_IEEE802154\_ENABLED > CONFIG\_IEEE802154\_DEBUG*

Enabling this option to record event, when assert, the recorded event will be printed.

**Default value:**

- No (disabled) if *CONFIG\_IEEE802154\_DEBUG*

### CONFIG\_IEEE802154\_RECORD\_EVENT\_SIZE

Record event table size

*Found in: Component config > IEEE 802.15.4 > CONFIG\_IEEE802154\_ENABLED > CONFIG\_IEEE802154\_DEBUG > CONFIG\_IEEE802154\_RECORD\_EVENT*

set the record event table size

**Range:**

- from 1 to 50 if *CONFIG\_IEEE802154\_RECORD\_EVENT*

**Default value:**

- 30 if *CONFIG\_IEEE802154\_RECORD\_EVENT*

### CONFIG\_IEEE802154\_RECORD\_STATE

Enable record state information for debugging

*Found in:* `Component config > IEEE 802.15.4 > CONFIG_IEEE802154_ENABLED > CONFIG_IEEE802154_DEBUG`

Enabling this option to record state, when assert, the recorded state will be printed.

**Default value:**

- No (disabled) if `CONFIG_IEEE802154_DEBUG`

### CONFIG\_IEEE802154\_RECORD\_STATE\_SIZE

Record state table size

*Found in:* `Component config > IEEE 802.15.4 > CONFIG_IEEE802154_ENABLED > CONFIG_IEEE802154_DEBUG > CONFIG_IEEE802154_RECORD_STATE`

set the record state table size

**Range:**

- from 1 to 50 if `CONFIG_IEEE802154_RECORD_STATE`

**Default value:**

- 10 if `CONFIG_IEEE802154_RECORD_STATE`

### CONFIG\_IEEE802154\_RECORD\_CMD

Enable record command information for debugging

*Found in:* `Component config > IEEE 802.15.4 > CONFIG_IEEE802154_ENABLED > CONFIG_IEEE802154_DEBUG`

Enabling this option to record the command, when assert, the recorded command will be printed.

**Default value:**

- No (disabled) if `CONFIG_IEEE802154_DEBUG`

### CONFIG\_IEEE802154\_RECORD\_CMD\_SIZE

Record command table size

*Found in:* `Component config > IEEE 802.15.4 > CONFIG_IEEE802154_ENABLED > CONFIG_IEEE802154_DEBUG > CONFIG_IEEE802154_RECORD_CMD`

set the record command table size

**Range:**

- from 1 to 50 if `CONFIG_IEEE802154_RECORD_CMD`

**Default value:**

- 10 if `CONFIG_IEEE802154_RECORD_CMD`

### CONFIG\_IEEE802154\_RECORD\_ABORT

Enable record abort information for debugging

*Found in:* `Component config > IEEE 802.15.4 > CONFIG_IEEE802154_ENABLED > CONFIG_IEEE802154_DEBUG`

Enabling this option to record the abort, when assert, the recorded abort will be printed.

**Default value:**

- No (disabled) if `CONFIG_IEEE802154_DEBUG`

### CONFIG\_IEEE802154\_RECORD\_ABORT\_SIZE

Record abort table size

*Found in:* *Component config > IEEE 802.15.4 > CONFIG\_IEEE802154\_ENABLED > CONFIG\_IEEE802154\_DEBUG > CONFIG\_IEEE802154\_RECORD\_ABORT*

set the record abort table size

**Range:**

- from 1 to 50 if *CONFIG\_IEEE802154\_RECORD\_ABORT*

**Default value:**

- 10 if *CONFIG\_IEEE802154\_RECORD\_ABORT*

### CONFIG\_IEEE802154\_TXRX\_STATISTIC

Enable record tx/rx packets information for debugging

*Found in:* *Component config > IEEE 802.15.4 > CONFIG\_IEEE802154\_ENABLED > CONFIG\_IEEE802154\_DEBUG*

Enabling this option to record the tx and rx

**Default value:**

- No (disabled) if *CONFIG\_IEEE802154\_DEBUG*

**Log output** Contains:

- *CONFIG\_LOG\_DEFAULT\_LEVEL*
- *CONFIG\_LOG\_MASTER\_LEVEL*
- *CONFIG\_LOG\_TIMESTAMP\_SOURCE*
- *CONFIG\_LOG\_MAXIMUM\_LEVEL*
- *CONFIG\_LOG\_COLORS*

### CONFIG\_LOG\_DEFAULT\_LEVEL

Default log verbosity

*Found in:* *Component config > Log output*

Specify how much output to see in logs by default. You can set lower verbosity level at runtime using *esp\_log\_level\_set* function.

By default, this setting limits which log statements are compiled into the program. For example, selecting "Warning" would mean that changing log level to "Debug" at runtime will not be possible. To allow increasing log level above the default at runtime, see the next option.

Available options:

- No output (*CONFIG\_LOG\_DEFAULT\_LEVEL\_NONE*)
- Error (*CONFIG\_LOG\_DEFAULT\_LEVEL\_ERROR*)
- Warning (*CONFIG\_LOG\_DEFAULT\_LEVEL\_WARN*)
- Info (*CONFIG\_LOG\_DEFAULT\_LEVEL\_INFO*)
- Debug (*CONFIG\_LOG\_DEFAULT\_LEVEL\_DEBUG*)
- Verbose (*CONFIG\_LOG\_DEFAULT\_LEVEL\_VERBOSE*)

### CONFIG\_LOG\_MAXIMUM\_LEVEL

Maximum log verbosity

*Found in:* *Component config > Log output*

This config option sets the highest log verbosity that it's possible to select at runtime by calling `esp_log_level_set()`. This level may be higher than the default verbosity level which is set when the app starts up.

This can be used enable debugging output only at a critical point, for a particular tag, or to minimize startup time but then enable more logs once the firmware has loaded.

Note that increasing the maximum available log level will increase the firmware binary size.

This option only applies to logging from the app, the bootloader log level is fixed at compile time to the separate "Bootloader log verbosity" setting.

Available options:

- Same as default (`CONFIG_LOG_MAXIMUM_EQUALS_DEFAULT`)
- Error (`CONFIG_LOG_MAXIMUM_LEVEL_ERROR`)
- Warning (`CONFIG_LOG_MAXIMUM_LEVEL_WARN`)
- Info (`CONFIG_LOG_MAXIMUM_LEVEL_INFO`)
- Debug (`CONFIG_LOG_MAXIMUM_LEVEL_DEBUG`)
- Verbose (`CONFIG_LOG_MAXIMUM_LEVEL_VERBOSE`)

### CONFIG\_LOG\_MASTER\_LEVEL

Enable global master log level

*Found in: [Component config > Log output](#)*

Enables an additional global "master" log level check that occurs before a log tag cache lookup. This is useful if you want to compile in a lot of logs that are selectable at runtime, but avoid the performance hit during periods where you don't want log output. Examples include remote log forwarding, or disabling logs during a time-critical or CPU-intensive section and re-enabling them later. Results in larger program size depending on number of logs compiled in.

If enabled, defaults to `LOG_DEFAULT_LEVEL` and can be set using `esp_log_set_level_master()`. This check takes precedence over `ESP_LOG_LEVEL_LOCAL`.

**Default value:**

- No (disabled)

### CONFIG\_LOG\_COLORS

Use ANSI terminal colors in log output

*Found in: [Component config > Log output](#)*

Enable ANSI terminal color codes in bootloader output.

In order to view these, your terminal program must support ANSI color codes.

**Default value:**

- Yes (enabled)

### CONFIG\_LOG\_TIMESTAMP\_SOURCE

Log Timestamps

*Found in: [Component config > Log output](#)*

Choose what sort of timestamp is displayed in the log output:

- Milliseconds since boot is calculated from the RTOS tick count multiplied by the tick period. This time will reset after a software reboot. e.g. (90000)



- System time is taken from POSIX time functions which use the chip's RTC and high resolution timers to maintain an accurate time. The system time is initialized to 0 on startup, it can be set with an SNTP sync, or with POSIX time functions. This time will not reset after a software reboot. e.g. (00:01:30.000)
- NOTE: Currently this will not get used in logging from binary blobs (i.e WiFi & Bluetooth libraries), these will always print milliseconds since boot.

Available options:

- Milliseconds Since Boot (CONFIG\_LOG\_TIMESTAMP\_SOURCE\_RTOS)
- System Time (CONFIG\_LOG\_TIMESTAMP\_SOURCE\_SYSTEM)

**LWIP** Contains:

- *CONFIG\_LWIP\_CHECK\_THREAD\_SAFETY*
- *Checksums*
- *CONFIG\_LWIP\_DHCP\_COARSE\_TIMER\_SECS*
- *DHCP server*
- *CONFIG\_LWIP\_DHCP\_OPTIONS\_LEN*
- *CONFIG\_LWIP\_DHCP\_DISABLE\_CLIENT\_ID*
- *CONFIG\_LWIP\_DHCP\_DISABLE\_VENDOR\_CLASS\_ID*
- *CONFIG\_LWIP\_DHCP\_DOES\_ARP\_CHECK*
- *CONFIG\_LWIP\_DHCP\_RESTORE\_LAST\_IP*
- *DNS*
- *CONFIG\_LWIP\_PPP\_CHAP\_SUPPORT*
- *CONFIG\_LWIP\_L2\_TO\_L3\_COPY*
- *CONFIG\_LWIP\_IPV6\_DHCP6*
- *CONFIG\_LWIP\_IP4\_FRAG*
- *CONFIG\_LWIP\_IP6\_FRAG*
- *CONFIG\_LWIP\_IP\_FORWARD*
- *CONFIG\_LWIP\_NETBUF\_RECVINFO*
- *CONFIG\_LWIP\_IPV4*
- *CONFIG\_LWIP\_AUTOIP*
- *CONFIG\_LWIP\_IPV6*
- *CONFIG\_LWIP\_ENABLE\_LCP\_ECHO*
- *CONFIG\_LWIP\_ESP\_LWIP\_ASSERT*
- *CONFIG\_LWIP\_DEBUG*
- *CONFIG\_LWIP\_IRAM\_OPTIMIZATION*
- *CONFIG\_LWIP\_EXTRA\_IRAM\_OPTIMIZATION*
- *CONFIG\_LWIP\_ENABLE*
- *CONFIG\_LWIP\_STATS*
- *CONFIG\_LWIP\_TIMERS\_ONDEMAND*
- *CONFIG\_LWIP\_DNS\_SUPPORT\_MDNS\_QUERIES*
- *CONFIG\_LWIP\_PPP\_MPPE\_SUPPORT*
- *CONFIG\_LWIP\_PPP\_MSCHAP\_SUPPORT*
- *CONFIG\_LWIP\_PPP\_NOTIFY\_PHASE\_SUPPORT*
- *CONFIG\_LWIP\_PPP\_PAP\_SUPPORT*
- *CONFIG\_LWIP\_PPP\_DEBUG\_ON*
- *CONFIG\_LWIP\_PPP\_SERVER\_SUPPORT*
- *CONFIG\_LWIP\_PPP\_SUPPORT*
- *CONFIG\_LWIP\_IP4\_REASSEMBLY*
- *CONFIG\_LWIP\_IP6\_REASSEMBLY*
- *CONFIG\_LWIP\_SLIP\_SUPPORT*
- *CONFIG\_LWIP\_SO\_LINGER*
- *CONFIG\_LWIP\_SO\_RCVBUF*
- *CONFIG\_LWIP\_SO\_REUSE*
- *CONFIG\_LWIP\_NETIF\_STATUS\_CALLBACK*

- `CONFIG_LWIP_TCPIP_CORE_LOCKING`
- `CONFIG_LWIP_NETIF_API`
- `CONFIG_LWIP_PPP_VJ_HEADER_COMPRESSION`
- `Hooks`
- `ICMP`
- `CONFIG_LWIP_LOCAL_HOSTNAME`
- `CONFIG_LWIP_ND6`
- `LWIP RAW API`
- `CONFIG_LWIP_TCPIP_TASK_PRIO`
- `CONFIG_LWIP_IPV6_ND6_NUM_NEIGHBORS`
- `CONFIG_LWIP_IPV6_MEMP_NUM_ND6_QUEUE`
- `CONFIG_LWIP_MAX_SOCKETS`
- `CONFIG_LWIP_BRIDGEIF_MAX_PORTS`
- `CONFIG_LWIP_NUM_NETIF_CLIENT_DATA`
- `CONFIG_LWIP_ESP_GRATUITOUS_ARP`
- `CONFIG_LWIP_ESP_MLDV6_REPORT`
- `SNTP`
- `CONFIG_LWIP_USE_ONLY_LWIP_SELECT`
- `CONFIG_LWIP_NETIF_LOOPBACK`
- `TCP`
- `CONFIG_LWIP_TCPIP_TASK_AFFINITY`
- `CONFIG_LWIP_TCPIP_TASK_STACK_SIZE`
- `CONFIG_LWIP_TCPIP_RECVMBOX_SIZE`
- `CONFIG_LWIP_IP_REASS_MAX_PBUFS`
- `CONFIG_LWIP_IP_DEFAULT_TTL`
- `UDP`
- `CONFIG_LWIP_IPV6_RDNSS_MAX_DNS_SERVERS`

### **CONFIG\_LWIP\_ENABLE**

Enable LwIP stack

*Found in: [Component config > LWIP](#)*

Builds normally if selected. Excludes LwIP from build if unselected, even if it is a dependency of a component or application. Some applications can switch their IP stacks, e.g., when switching between chip and Linux targets (LwIP stack vs. Linux IP stack). Since the LwIP dependency cannot easily be excluded based on a Kconfig option, it has to be a dependency in all cases. This switch allows the LwIP stack to be built selectively, even if it is a dependency.

**Default value:**

- Yes (enabled)

### **CONFIG\_LWIP\_LOCAL\_HOSTNAME**

Local netif hostname

*Found in: [Component config > LWIP](#)*

The default name this device will report to other devices on the network. Could be updated at runtime with `esp_netif_set_hostname()`

**Default value:**

- "espressif"

### **CONFIG\_LWIP\_NETIF\_API**

Enable usage of standard POSIX APIs in LWIP

*Found in: [Component config > LWIP](#)*

If this feature is enabled, standard POSIX APIs: `if_indextoname()`, `if_nametoindex()` could be used to convert network interface index to name instead of IDF specific esp-netif APIs (such as `esp_netif_get_netif_impl_name()`)

**Default value:**

- No (disabled)

### CONFIG\_LWIP\_TCPIP\_TASK\_PRIO

LWIP TCP/IP Task Priority

*Found in: [Component config](#) > [LWIP](#)*

LWIP tcpip task priority. In case of high throughput, this parameter could be changed up to (`config-MAX_PRIORITIES-1`).

**Range:**

- from 1 to 24

**Default value:**

- 18

### CONFIG\_LWIP\_TCPIP\_CORE\_LOCKING

Enable tcpip core locking

*Found in: [Component config](#) > [LWIP](#)*

If Enable tcpip core locking,Creates a global mutex that is held during TCPIP thread operations.Can be locked by client code to perform lwIP operations without changing into TCPIP thread using callbacks. See `LOCK_TCPIP_CORE()` and `UNLOCK_TCPIP_CORE()`.

If disable tcpip core locking,TCP IP will perform tasks through context switching

**Default value:**

- No (disabled)

### CONFIG\_LWIP\_TCPIP\_CORE\_LOCKING\_INPUT

Enable tcpip core locking input

*Found in: [Component config](#) > [LWIP](#) > [CONFIG\\_LWIP\\_TCPIP\\_CORE\\_LOCKING](#)*

when `LWIP_TCPIP_CORE_LOCKING` is enabled, this lets `tcpip_input()` grab the mutex for input packets as well, instead of allocating a message and passing it to `tcpip_thread`.

**Default value:**

- No (disabled) if [CONFIG\\_LWIP\\_TCPIP\\_CORE\\_LOCKING](#)

### CONFIG\_LWIP\_CHECK\_THREAD\_SAFETY

Checks that lwip API runs in expected context

*Found in: [Component config](#) > [LWIP](#)*

Enable to check that the project does not violate lwip thread safety. If enabled, all lwip functions that require thread awareness run an assertion to verify that the TCP/IP core functionality is either locked or accessed from the correct thread.

**Default value:**

- No (disabled)

### CONFIG\_LWIP\_DNS\_SUPPORT\_MDNS\_QUERIES

Enable mDNS queries in resolving host name

*Found in: [Component config](#) > [LWIP](#)*

If this feature is enabled, standard API such as `gethostbyname` support `.local` addresses by sending one shot multicast mDNS query

**Default value:**

- Yes (enabled)

### CONFIG\_LWIP\_L2\_TO\_L3\_COPY

Enable copy between Layer2 and Layer3 packets

*Found in: [Component config](#) > [LWIP](#)*

If this feature is enabled, all traffic from layer2(WIFI Driver) will be copied to a new buffer before sending it to layer3(LWIP stack), freeing the layer2 buffer. Please be notified that the total layer2 receiving buffer is fixed and ESP32 currently supports 25 layer2 receiving buffer, when layer2 buffer runs out of memory, then the incoming packets will be dropped in hardware. The layer3 buffer is allocated from the heap, so the total layer3 receiving buffer depends on the available heap size, when heap runs out of memory, no copy will be sent to layer3 and packet will be dropped in layer2. Please make sure you fully understand the impact of this feature before enabling it.

**Default value:**

- No (disabled)

### CONFIG\_LWIP\_IRAM\_OPTIMIZATION

Enable LWIP IRAM optimization

*Found in: [Component config](#) > [LWIP](#)*

If this feature is enabled, some functions relating to RX/TX in LWIP will be put into IRAM, it can improve UDP/TCP throughput by >10% for single core mode, it doesn't help too much for dual core mode. On the other hand, it needs about 10KB IRAM for these optimizations.

If this feature is disabled, all lwip functions will be put into FLASH.

**Default value:**

- No (disabled)

### CONFIG\_LWIP\_EXTRA\_IRAM\_OPTIMIZATION

Enable LWIP IRAM optimization for TCP part

*Found in: [Component config](#) > [LWIP](#)*

If this feature is enabled, some tcp part functions relating to RX/TX in LWIP will be put into IRAM, it can improve TCP throughput. On the other hand, it needs about 17KB IRAM for these optimizations.

**Default value:**

- No (disabled)

### CONFIG\_LWIP\_TIMERS\_ONDEMAND

Enable LWIP Timers on demand

*Found in: [Component config](#) > [LWIP](#)*

If this feature is enabled, IGMP and MLD6 timers will be activated only when joining groups or receiving QUERY packets.

This feature will reduce the power consumption for applications which do not use IGMP and MLD6.

**Default value:**

- Yes (enabled)

**CONFIG\_LWIP\_ND6**

LWIP NDP6 Enable/Disable

*Found in: [Component config](#) > [LWIP](#)*

This option is used to disable the Network Discovery Protocol (NDP) if it is not required. Please use this option with caution, as the NDP is essential for IPv6 functionality within a local network.

**Default value:**

- Yes (enabled)

**CONFIG\_LWIP\_FORCE\_ROUTER\_FORWARDING**

LWIP Force Router Forwarding Enable/Disable

*Found in: [Component config](#) > [LWIP](#) > [CONFIG\\_LWIP\\_ND6](#)*

This option is used to set the the router flag for the NA packets. When enabled, the router flag in NA packet will always set to 1, otherwise, never set router flag for NA packets.

**Default value:**

- No (disabled)

**CONFIG\_LWIP\_MAX\_SOCKETS**

Max number of open sockets

*Found in: [Component config](#) > [LWIP](#)*

Sockets take up a certain amount of memory, and allowing fewer sockets to be open at the same time conserves memory. Specify the maximum amount of sockets here. The valid value is from 1 to 16.

**Range:**

- from 1 to 16

**Default value:**

- 10

**CONFIG\_LWIP\_USE\_ONLY\_LWIP\_SELECT**

Support LWIP socket select() only (DEPRECATED)

*Found in: [Component config](#) > [LWIP](#)*

This option is deprecated. Do not use this option, use VFS\_SUPPORT\_SELECT instead.

**Default value:**

- No (disabled)

**CONFIG\_LWIP\_SO\_LINGER**

Enable SO\_LINGER processing

*Found in: [Component config](#) > [LWIP](#)*

Enabling this option allows SO\_LINGER processing. `l_onoff = 1, l_linger` can set the timeout.

If `l_linger=0`, When a connection is closed, TCP will terminate the connection. This means that TCP will discard any data packets stored in the socket send buffer and send an RST to the peer.

If `l_linger!=0`, Then `closesocket()` calls to block the process until the remaining data packets has been sent or timed out.

**Default value:**

- No (disabled)

**CONFIG\_LWIP\_SO\_REUSE**

Enable SO\_REUSEADDR option

*Found in: [Component config](#) > [LWIP](#)*

Enabling this option allows binding to a port which remains in TIME\_WAIT.

**Default value:**

- Yes (enabled)

**CONFIG\_LWIP\_SO\_REUSE\_RXTOALL**

SO\_REUSEADDR copies broadcast/multicast to all matches

*Found in: [Component config](#) > [LWIP](#) > [CONFIG\\_LWIP\\_SO\\_REUSE](#)*

Enabling this option means that any incoming broadcast or multicast packet will be copied to all of the local sockets that it matches (may be more than one if SO\_REUSEADDR is set on the socket.)

This increases memory overhead as the packets need to be copied, however they are only copied per matching socket. You can safely disable it if you don't plan to receive broadcast or multicast traffic on more than one socket at a time.

**Default value:**

- Yes (enabled)

**CONFIG\_LWIP\_SO\_RCVBUF**

Enable SO\_RCVBUF option

*Found in: [Component config](#) > [LWIP](#)*

Enabling this option allows checking for available data on a netconn.

**Default value:**

- No (disabled)

**CONFIG\_LWIP\_NETBUF\_RECVINFO**

Enable IP\_PKTINFO option

*Found in: [Component config](#) > [LWIP](#)*

Enabling this option allows checking for the destination address of a received IPv4 Packet.

**Default value:**

- No (disabled)

**CONFIG\_LWIP\_IP\_DEFAULT\_TTL**

The value for Time-To-Live used by transport layers

*Found in: [Component config](#) > [LWIP](#)*

Set value for Time-To-Live used by transport layers.

**Range:**

- from 1 to 255

**Default value:**

- 64

### CONFIG\_LWIP\_IP4\_FRAG

Enable fragment outgoing IP4 packets

*Found in: [Component config](#) > [LWIP](#)*

Enabling this option allows fragmenting outgoing IP4 packets if their size exceeds MTU.

**Default value:**

- Yes (enabled)

### CONFIG\_LWIP\_IP6\_FRAG

Enable fragment outgoing IP6 packets

*Found in: [Component config](#) > [LWIP](#)*

Enabling this option allows fragmenting outgoing IP6 packets if their size exceeds MTU.

**Default value:**

- Yes (enabled)

### CONFIG\_LWIP\_IP4\_REASSEMBLY

Enable reassembly incoming fragmented IP4 packets

*Found in: [Component config](#) > [LWIP](#)*

Enabling this option allows reassembling incoming fragmented IP4 packets.

**Default value:**

- No (disabled)

### CONFIG\_LWIP\_IP6\_REASSEMBLY

Enable reassembly incoming fragmented IP6 packets

*Found in: [Component config](#) > [LWIP](#)*

Enabling this option allows reassembling incoming fragmented IP6 packets.

**Default value:**

- No (disabled)

### CONFIG\_LWIP\_IP\_REASS\_MAX\_PBUFS

The maximum amount of pbufs waiting to be reassembled

*Found in: [Component config](#) > [LWIP](#)*

Set the maximum amount of pbufs waiting to be reassembled.

**Range:**

- from 10 to 100

**Default value:**

- 10

### CONFIG\_LWIP\_IP\_FORWARD

Enable IP forwarding

*Found in: [Component config](#) > [LWIP](#)*

Enabling this option allows packets forwarding across multiple interfaces.

**Default value:**

- No (disabled)

### CONFIG\_LWIP\_IPV4\_NAPT

Enable NAT

*Found in: Component config > LWIP > CONFIG\_LWIP\_IP\_FORWARD*

Enabling this option allows Network Address and Port Translation.

**Default value:**

- No (disabled) if *CONFIG\_LWIP\_IP\_FORWARD*

### CONFIG\_LWIP\_IPV4\_NAPT\_PORTMAP

Enable NAT Port Mapping

*Found in: Component config > LWIP > CONFIG\_LWIP\_IP\_FORWARD > CONFIG\_LWIP\_IPV4\_NAPT*

Enabling this option allows Port Forwarding or Port mapping.

**Default value:**

- Yes (enabled) if *CONFIG\_LWIP\_IPV4\_NAPT*

### CONFIG\_LWIP\_STATS

Enable LWIP statistics

*Found in: Component config > LWIP*

Enabling this option allows LWIP statistics

**Default value:**

- No (disabled)

### CONFIG\_LWIP\_ESP\_GRATUITOUS\_ARP

Send gratuitous ARP periodically

*Found in: Component config > LWIP*

Enable this option allows to send gratuitous ARP periodically.

This option solve the compatibility issues.If the ARP table of the AP is old, and the AP doesn't send ARP request to update it's ARP table, this will lead to the STA sending IP packet fail. Thus we send gratuitous ARP periodically to let AP update it's ARP table.

**Default value:**

- Yes (enabled)

### CONFIG\_LWIP\_GARP\_TMR\_INTERVAL

GARP timer interval(seconds)

*Found in: Component config > LWIP > CONFIG\_LWIP\_ESP\_GRATUITOUS\_ARP*

Set the timer interval for gratuitous ARP. The default value is 60s

**Default value:**

- 60



### CONFIG\_LWIP\_ESP\_MLDV6\_REPORT

Send mldv6 report periodically

*Found in: [Component config](#) > [LWIP](#)*

Enable this option allows to send mldv6 report periodically.

This option solve the issue that failed to receive multicast data. Some routers fail to forward multicast packets. To solve this problem, send multicast mldv6 report to routers regularly.

**Default value:**

- Yes (enabled)

### CONFIG\_LWIP\_MLDV6\_TMR\_INTERVAL

mldv6 report timer interval(seconds)

*Found in: [Component config](#) > [LWIP](#) > [CONFIG\\_LWIP\\_ESP\\_MLDV6\\_REPORT](#)*

Set the timer interval for mldv6 report. The default value is 30s

**Default value:**

- 40

### CONFIG\_LWIP\_TCPIP\_RECVMBOX\_SIZE

TCPIP task receive mail box size

*Found in: [Component config](#) > [LWIP](#)*

Set TCPIP task receive mail box size. Generally bigger value means higher throughput but more memory. The value should be bigger than UDP/TCP mail box size.

**Range:**

- from 6 to 1024 if [CONFIG\\_LWIP\\_WND\\_SCALE](#)

**Default value:**

- 32

### CONFIG\_LWIP\_DHCP\_DOES\_ARP\_CHECK

DHCP: Perform ARP check on any offered address

*Found in: [Component config](#) > [LWIP](#)*

Enabling this option performs a check (via ARP request) if the offered IP address is not already in use by another host on the network.

**Default value:**

- Yes (enabled)

### CONFIG\_LWIP\_DHCP\_DISABLE\_CLIENT\_ID

DHCP: Disable Use of HW address as client identification

*Found in: [Component config](#) > [LWIP](#)*

This option could be used to disable DHCP client identification with its MAC address. (Client id is used by DHCP servers to uniquely identify clients and are included in the DHCP packets as an option 61) Set this option to "y" in order to exclude option 61 from DHCP packets.

**Default value:**

- No (disabled)

### CONFIG\_LWIP\_DHCP\_DISABLE\_VENDOR\_CLASS\_ID

DHCP: Disable Use of vendor class identification

Found in: *Component config > LWIP*

This option could be used to disable DHCP client vendor class identification. Set this option to "y" in order to exclude option 60 from DHCP packets.

**Default value:**

- Yes (enabled)

### CONFIG\_LWIP\_DHCP\_RESTORE\_LAST\_IP

DHCP: Restore last IP obtained from DHCP server

Found in: *Component config > LWIP*

When this option is enabled, DHCP client tries to re-obtain last valid IP address obtained from DHCP server. Last valid DHCP configuration is stored in nvs and restored after reset/power-up. If IP is still available, there is no need for sending discovery message to DHCP server and save some time.

**Default value:**

- No (disabled)

### CONFIG\_LWIP\_DHCP\_OPTIONS\_LEN

DHCP total option length

Found in: *Component config > LWIP*

Set total length of outgoing DHCP option msg. Generally bigger value means it can carry more options and values. If your code meets LWIP\_ASSERT due to option value is too long. Please increase the LWIP\_DHCP\_OPTIONS\_LEN value.

**Range:**

- from 68 to 255

**Default value:**

- 68

### CONFIG\_LWIP\_NUM\_NETIF\_CLIENT\_DATA

Number of clients store data in netif

Found in: *Component config > LWIP*

Number of clients that may store data in client\_data member array of struct netif.

**Range:**

- from 0 to 256

**Default value:**

- 0

### CONFIG\_LWIP\_DHCP\_COARSE\_TIMER\_SECS

DHCP coarse timer interval(s)

Found in: *Component config > LWIP*

Set DHCP coarse interval in seconds. A higher value will be less precise but cost less power consumption.

**Range:**

- from 1 to 10

**Default value:**

- 1

**DHCP server** Contains:

- [CONFIG\\_LWIP\\_DHCPS](#)

### CONFIG\_LWIP\_DHCPS

DHCPS: Enable IPv4 Dynamic Host Configuration Protocol Server (DHCPS)

*Found in:* [Component config](#) > [LWIP](#) > [DHCP server](#)

Enabling this option allows the device to run the DHCP server (to dynamically assign IPv4 addresses to clients).

**Default value:**

- Yes (enabled)

### CONFIG\_LWIP\_DHCPS\_LEASE\_UNIT

Multiplier for lease time, in seconds

*Found in:* [Component config](#) > [LWIP](#) > [DHCP server](#) > [CONFIG\\_LWIP\\_DHCPS](#)

The DHCP server is calculating lease time multiplying the sent and received times by this number of seconds per unit. The default is 60, that equals one minute.

**Range:**

- from 1 to 3600

**Default value:**

- 60

### CONFIG\_LWIP\_DHCPS\_MAX\_STATION\_NUM

Maximum number of stations

*Found in:* [Component config](#) > [LWIP](#) > [DHCP server](#) > [CONFIG\\_LWIP\\_DHCPS](#)

The maximum number of DHCP clients that are connected to the server. After this number is exceeded, DHCP server removes of the oldest device from its address pool, without notification.

**Range:**

- from 1 to 64

**Default value:**

- 8

### CONFIG\_LWIP\_DHCPS\_STATIC\_ENTRIES

Enable ARP static entries

*Found in:* [Component config](#) > [LWIP](#) > [DHCP server](#) > [CONFIG\\_LWIP\\_DHCPS](#)

Enabling this option allows DHCP server to support temporary static ARP entries for DHCP Client. This will help the DHCP server to send the DHCP OFFER and DHCP ACK using IP unicast.

**Default value:**

- Yes (enabled)

### CONFIG\_LWIP\_AUTOIP

Enable IPV4 Link-Local Addressing (AUTOIP)

*Found in:* [Component config](#) > [LWIP](#)

Enabling this option allows the device to self-assign an address in the 169.256/16 range if none is assigned statically or via DHCP.

See RFC 3927.

**Default value:**

- No (disabled)

Contains:

- [CONFIG\\_LWIP\\_AUTOIP\\_TRIES](#)
- [CONFIG\\_LWIP\\_AUTOIP\\_MAX\\_CONFLICTS](#)
- [CONFIG\\_LWIP\\_AUTOIP\\_RATE\\_LIMIT\\_INTERVAL](#)

### CONFIG\_LWIP\_AUTOIP\_TRIES

DHCP Probes before self-assigning IPv4 LL address

*Found in:* [Component config](#) > [LWIP](#) > [CONFIG\\_LWIP\\_AUTOIP](#)

DHCP client will send this many probes before self-assigning a link local address.

From LWIP help: "This can be set as low as 1 to get an AutoIP address very quickly, but you should be prepared to handle a changing IP address when DHCP overrides AutoIP." (In the case of ESP-IDF, this means multiple SYSTEM\_EVENT\_STA\_GOT\_IP events.)

**Range:**

- from 1 to 100 if [CONFIG\\_LWIP\\_AUTOIP](#)

**Default value:**

- 2 if [CONFIG\\_LWIP\\_AUTOIP](#)

### CONFIG\_LWIP\_AUTOIP\_MAX\_CONFLICTS

Max IP conflicts before rate limiting

*Found in:* [Component config](#) > [LWIP](#) > [CONFIG\\_LWIP\\_AUTOIP](#)

If the AUTOIP functionality detects this many IP conflicts while self-assigning an address, it will go into a rate limited mode.

**Range:**

- from 1 to 100 if [CONFIG\\_LWIP\\_AUTOIP](#)

**Default value:**

- 9 if [CONFIG\\_LWIP\\_AUTOIP](#)

### CONFIG\_LWIP\_AUTOIP\_RATE\_LIMIT\_INTERVAL

Rate limited interval (seconds)

*Found in:* [Component config](#) > [LWIP](#) > [CONFIG\\_LWIP\\_AUTOIP](#)

If rate limiting self-assignment requests, wait this long between each request.

**Range:**

- from 5 to 120 if [CONFIG\\_LWIP\\_AUTOIP](#)

**Default value:**

- 20 if [CONFIG\\_LWIP\\_AUTOIP](#)

### CONFIG\_LWIP\_IPV4

Enable IPv4

*Found in:* [Component config](#) > [LWIP](#)

Enable IPv4 stack. If you want to use IPv6 only TCP/IP stack, disable this.

**Default value:**

- Yes (enabled)

### CONFIG\_LWIP\_IPV6

Enable IPv6

*Found in:* [Component config > LWIP](#)

Enable IPv6 function. If not use IPv6 function, set this option to n. If disabling LWIP\_IPV6 then some other components (asio) will no longer be available.

**Default value:**

- Yes (enabled)

### CONFIG\_LWIP\_IPV6\_AUTOCONFIG

Enable IPV6 stateless address autoconfiguration (SLAAC)

*Found in:* [Component config > LWIP > CONFIG\\_LWIP\\_IPV6](#)

Enabling this option allows the devices to IPV6 stateless address autoconfiguration (SLAAC).

See RFC 4862.

**Default value:**

- No (disabled)

### CONFIG\_LWIP\_IPV6\_NUM\_ADDRESSES

Number of IPv6 addresses on each network interface

*Found in:* [Component config > LWIP > CONFIG\\_LWIP\\_IPV6](#)

The maximum number of IPv6 addresses on each interface. Any additional addresses will be discarded.

**Default value:**

- 3

### CONFIG\_LWIP\_IPV6\_FORWARD

Enable IPv6 forwarding between interfaces

*Found in:* [Component config > LWIP > CONFIG\\_LWIP\\_IPV6](#)

Forwarding IPv6 packets between interfaces is only required when acting as a router.

**Default value:**

- No (disabled)

### CONFIG\_LWIP\_IPV6\_RDNSS\_MAX\_DNS\_SERVERS

Use IPv6 Router Advertisement Recursive DNS Server Option

*Found in:* [Component config > LWIP](#)

Use IPv6 Router Advertisement Recursive DNS Server Option (as per RFC 6106) to copy a defined maximum number of DNS servers to the DNS module. Set this option to a number of desired DNS servers advertised in the RA protocol. This feature is disabled when set to 0.

**Default value:**

- 0 if [CONFIG\\_LWIP\\_IPV6\\_AUTOCONFIG](#)

### CONFIG\_LWIP\_IPV6\_DHCP6

Enable DHCPv6 stateless address autoconfiguration

Found in: *Component config > LWIP*

Enable DHCPv6 for IPv6 stateless address autoconfiguration. Note that the dhcpv6 client has to be started using `dhcp6_enable_stateless(netif)`; Note that the stateful address autoconfiguration is not supported.

**Default value:**

- No (disabled) if *CONFIG\_LWIP\_IPV6\_AUTOCONFIG*

### CONFIG\_LWIP\_NETIF\_STATUS\_CALLBACK

Enable status callback for network interfaces

Found in: *Component config > LWIP*

Enable callbacks when the network interface is up/down and addresses are changed.

**Default value:**

- No (disabled)

### CONFIG\_LWIP\_NETIF\_LOOPBACK

Support per-interface loopback

Found in: *Component config > LWIP*

Enabling this option means that if a packet is sent with a destination address equal to the interface's own IP address, it will "loop back" and be received by this interface. Disabling this option disables support of loopback interface in lwIP

**Default value:**

- Yes (enabled)

Contains:

- *CONFIG\_LWIP\_LOOPBACK\_MAX\_PBUFS*

### CONFIG\_LWIP\_LOOPBACK\_MAX\_PBUFS

Max queued loopback packets per interface

Found in: *Component config > LWIP > CONFIG\_LWIP\_NETIF\_LOOPBACK*

Configure the maximum number of packets which can be queued for loopback on a given interface. Reducing this number may cause packets to be dropped, but will avoid filling memory with queued packet data.

**Range:**

- from 0 to 16

**Default value:**

- 8

**TCP** Contains:

- *CONFIG\_LWIP\_TCP\_WND\_DEFAULT*
- *CONFIG\_LWIP\_TCP\_SND\_BUF\_DEFAULT*
- *CONFIG\_LWIP\_TCP\_ACCEPTMBOX\_SIZE*
- *CONFIG\_LWIP\_TCP\_RECVMBOX\_SIZE*
- *CONFIG\_LWIP\_TCP\_RTO\_TIME*
- *CONFIG\_LWIP\_MAX\_ACTIVE\_TCP*
- *CONFIG\_LWIP\_TCP\_FIN\_WAIT\_TIMEOUT*

- [CONFIG\\_LWIP\\_MAX\\_LISTENING\\_TCP](#)
- [CONFIG\\_LWIP\\_TCP\\_MAXRTX](#)
- [CONFIG\\_LWIP\\_TCP\\_SYNMAXRTX](#)
- [CONFIG\\_LWIP\\_TCP\\_MSL](#)
- [CONFIG\\_LWIP\\_TCP\\_MSS](#)
- [CONFIG\\_LWIP\\_TCP\\_OVERSIZE](#)
- [CONFIG\\_LWIP\\_TCP\\_QUEUE\\_OOSEQ](#)
- [CONFIG\\_LWIP\\_WND\\_SCALE](#)
- [CONFIG\\_LWIP\\_TCP\\_HIGH\\_SPEED\\_RETRANSMISSION](#)
- [CONFIG\\_LWIP\\_TCP\\_TMR\\_INTERVAL](#)

### CONFIG\_LWIP\_MAX\_ACTIVE\_TCP

Maximum active TCP Connections

*Found in: [Component config](#) > [LWIP](#) > [TCP](#)*

The maximum number of simultaneously active TCP connections. The practical maximum limit is determined by available heap memory at runtime.

Changing this value by itself does not substantially change the memory usage of LWIP, except for preventing new TCP connections after the limit is reached.

**Range:**

- from 1 to 1024

**Default value:**

- 16

### CONFIG\_LWIP\_MAX\_LISTENING\_TCP

Maximum listening TCP Connections

*Found in: [Component config](#) > [LWIP](#) > [TCP](#)*

The maximum number of simultaneously listening TCP connections. The practical maximum limit is determined by available heap memory at runtime.

Changing this value by itself does not substantially change the memory usage of LWIP, except for preventing new listening TCP connections after the limit is reached.

**Range:**

- from 1 to 1024

**Default value:**

- 16

### CONFIG\_LWIP\_TCP\_HIGH\_SPEED\_RETRANSMISSION

TCP high speed retransmissions

*Found in: [Component config](#) > [LWIP](#) > [TCP](#)*

Speed up the TCP retransmission interval. If disabled, it is recommended to change the number of SYN retransmissions to 6, and TCP initial rto time to 3000.

**Default value:**

- Yes (enabled)

### CONFIG\_LWIP\_TCP\_MAXRTX

Maximum number of retransmissions of data segments

*Found in: [Component config](#) > [LWIP](#) > [TCP](#)*

Set maximum number of retransmissions of data segments.

**Range:**

- from 3 to 12

**Default value:**

- 12

**CONFIG\_LWIP\_TCP\_SYNMAXRTX**

Maximum number of retransmissions of SYN segments

*Found in: [Component config](#) > [LWIP](#) > [TCP](#)*

Set maximum number of retransmissions of SYN segments.

**Range:**

- from 3 to 12

**Default value:**

- 12

**CONFIG\_LWIP\_TCP\_MSS**

Maximum Segment Size (MSS)

*Found in: [Component config](#) > [LWIP](#) > [TCP](#)*

Set maximum segment size for TCP transmission.

Can be set lower to save RAM, the default value 1460(ipv4)/1440(ipv6) will give best throughput. IPv4 TCP\_MSS Range: 576 <= TCP\_MSS <= 1460 IPv6 TCP\_MSS Range: 1220<= TCP\_MSS <= 1440

**Range:**

- from 536 to 1460

**Default value:**

- 1440

**CONFIG\_LWIP\_TCP\_TMR\_INTERVAL**

TCP timer interval(ms)

*Found in: [Component config](#) > [LWIP](#) > [TCP](#)*

Set TCP timer interval in milliseconds.

Can be used to speed connections on bad networks. A lower value will redeliver unacked packets faster.

**Default value:**

- 250

**CONFIG\_LWIP\_TCP\_MSL**

Maximum segment lifetime (MSL)

*Found in: [Component config](#) > [LWIP](#) > [TCP](#)*

Set maximum segment lifetime in milliseconds.

**Default value:**

- 60000

**CONFIG\_LWIP\_TCP\_FIN\_WAIT\_TIMEOUT**

Maximum FIN segment lifetime

*Found in: [Component config](#) > [LWIP](#) > [TCP](#)*

Set maximum segment lifetime in milliseconds.



**Default value:**

- 20000

**CONFIG\_LWIP\_TCP\_SND\_BUF\_DEFAULT**

Default send buffer size

*Found in: [Component config](#) > [LWIP](#) > [TCP](#)*

Set default send buffer size for new TCP sockets.

Per-socket send buffer size can be changed at runtime with `lwip_setsockopt(s, TCP_SNDBUF, ...)`.

This value must be at least 2x the MSS size, and the default is 4x the default MSS size.

Setting a smaller default SNDBUF size can save some RAM, but will decrease performance.

**Range:**

- from 2440 to 1024000 if [CONFIG\\_LWIP\\_WND\\_SCALE](#)

**Default value:**

- 5760

**CONFIG\_LWIP\_TCP\_WND\_DEFAULT**

Default receive window size

*Found in: [Component config](#) > [LWIP](#) > [TCP](#)*

Set default TCP receive window size for new TCP sockets.

Per-socket receive window size can be changed at runtime with `lwip_setsockopt(s, TCP_WINDOW, ...)`.

Setting a smaller default receive window size can save some RAM, but will significantly decrease performance.

**Range:**

- from 2440 to 1024000 if [CONFIG\\_LWIP\\_WND\\_SCALE](#)

**Default value:**

- 5760

**CONFIG\_LWIP\_TCP\_RECVMBOX\_SIZE**

Default TCP receive mail box size

*Found in: [Component config](#) > [LWIP](#) > [TCP](#)*

Set TCP receive mail box size. Generally bigger value means higher throughput but more memory. The recommended value is:  $LWIP\_TCP\_WND\_DEFAULT/TCP\_MSS + 2$ , e.g. if  $LWIP\_TCP\_WND\_DEFAULT=14360$ ,  $TCP\_MSS=1436$ , then the recommended receive mail box size is  $(14360/1436 + 2) = 12$ .

TCP receive mail box is a per socket mail box, when the application receives packets from TCP socket, LWIP core firstly posts the packets to TCP receive mail box and the application then fetches the packets from mail box. It means LWIP can cache maximum `LWIP_TCP_RECCVMBOX_SIZE` packets for each TCP socket, so the maximum possible cached TCP packets for all TCP sockets is `LWIP_TCP_RECCVMBOX_SIZE` multiplies the maximum TCP socket number. In other words, the bigger `LWIP_TCP_RECVMBOX_SIZE` means more memory. On the other hand, if the receive mail box is too small, the mail box may be full. If the mail box is full, the LWIP drops the packets. So generally we need to make sure the TCP receive mail box is big enough to avoid packet drop between LWIP core and application.

**Range:**

- from 6 to 1024 if [CONFIG\\_LWIP\\_WND\\_SCALE](#)

**Default value:**

- 6

### CONFIG\_LWIP\_TCP\_ACCEPTMBOX\_SIZE

Default TCP accept mail box size

*Found in:* [Component config](#) > [LWIP](#) > [TCP](#)

Set TCP accept mail box size. Generally bigger value means supporting larger backlogs but more memory. The recommended value is 6, but applications can set it to a lower value if listening servers are meant to have a smaller backlog.

TCP accept mail box is a per socket mail box, when the application listens for connections with a given listening TCP socket. If the mailbox is full, LWIP will send a RST packet and the client will fail to connect.

**Range:**

- from 1 to 255 if [CONFIG\\_LWIP\\_WND\\_SCALE](#)

**Default value:**

- 6

### CONFIG\_LWIP\_TCP\_QUEUE\_OOSEQ

Queue incoming out-of-order segments

*Found in:* [Component config](#) > [LWIP](#) > [TCP](#)

Queue incoming out-of-order segments for later use.

Disable this option to save some RAM during TCP sessions, at the expense of increased retransmissions if segments arrive out of order.

**Default value:**

- Yes (enabled)

### CONFIG\_LWIP\_TCP\_OOSEQ\_TIMEOUT

Timeout for each pbuf queued in TCP OOSEQ, in RTOs.

*Found in:* [Component config](#) > [LWIP](#) > [TCP](#) > [CONFIG\\_LWIP\\_TCP\\_QUEUE\\_OOSEQ](#)

The timeout value is `TCP_OOSEQ_TIMEOUT * RTO`.

**Range:**

- from 1 to 30

**Default value:**

- 6

### CONFIG\_LWIP\_TCP\_OOSEQ\_MAX\_PBUFS

The maximum number of pbufs queued on OOSEQ per pcb

*Found in:* [Component config](#) > [LWIP](#) > [TCP](#) > [CONFIG\\_LWIP\\_TCP\\_QUEUE\\_OOSEQ](#)

If `LWIP_TCP_OOSEQ_MAX_PBUFS = 0`, TCP will not control the number of OOSEQ pbufs.

In a poor network environment, many out-of-order tcp pbufs will be received. These out-of-order pbufs will be cached in the TCP out-of-order queue which will cause Wi-Fi/Ethernet fail to release RX buffer in time. It is possible that all RX buffers for MAC layer are used by OOSEQ.

Control the number of out-of-order pbufs to ensure that the MAC layer has enough RX buffer to receive packets.

In the Wi-Fi scenario, recommended OOSEQ PBUFS Range:  $0 \leq \text{TCP\_OOSEQ\_MAX\_PBUFS} \leq \text{CONFIG\_ESP\_WIFI\_DYNAMIC\_RX\_BUFFER\_NUM}/(\text{MAX\_TCP\_NUMBER} + 1)$

In the Ethernet scenario, recommended Ethernet OOSEQ PBUFS Range:  $0 \leq \text{TCP\_OOSEQ\_MAX\_PBUFS} \leq \text{CONFIG\_ETH\_DMA\_RX\_BUFFER\_NUM}/(\text{MAX\_TCP\_NUMBER} + 1)$

Within the recommended value range, the larger the value, the better the performance.

MAX\_TCP\_NUMBER represent Maximum number of TCP connections in Wi-Fi(STA+SoftAP) and Ethernet scenario.

**Range:**

- from 0 to 12

**Default value:**

- 0 if SPIRAM\_TRY\_ALLOCATE\_WIFI\_LWIP && [CONFIG\\_LWIP\\_TCP\\_QUEUE\\_OOSEQ](#)

### CONFIG\_LWIP\_TCP\_SACK\_OUT

Support sending selective acknowledgements

*Found in:* [Component config](#) > [LWIP](#) > [TCP](#) > [CONFIG\\_LWIP\\_TCP\\_QUEUE\\_OOSEQ](#)

TCP will support sending selective acknowledgements (SACKs).

**Default value:**

- No (disabled)

### CONFIG\_LWIP\_TCP\_OVERSIZE

Pre-allocate transmit PBUF size

*Found in:* [Component config](#) > [LWIP](#) > [TCP](#)

Allows enabling "oversize" allocation of TCP transmission pbufs ahead of time, which can reduce the length of pbuf chains used for transmission.

This will not make a difference to sockets where Nagle's algorithm is disabled.

Default value of MSS is fine for most applications, 25% MSS may save some RAM when only transmitting small amounts of data. Disabled will have worst performance and fragmentation characteristics, but uses least RAM overall.

Available options:

- MSS (CONFIG\_LWIP\_TCP\_OVERSIZE\_MSS)
- 25% MSS (CONFIG\_LWIP\_TCP\_OVERSIZE\_QUARTER\_MSS)
- Disabled (CONFIG\_LWIP\_TCP\_OVERSIZE\_DISABLE)

### CONFIG\_LWIP\_WND\_SCALE

Support TCP window scale

*Found in:* [Component config](#) > [LWIP](#) > [TCP](#)

Enable this feature to support TCP window scaling.

**Default value:**

- No (disabled) if SPIRAM\_TRY\_ALLOCATE\_WIFI\_LWIP

### CONFIG\_LWIP\_TCP\_RCV\_SCALE

Set TCP receiving window scaling factor

*Found in:* [Component config](#) > [LWIP](#) > [TCP](#) > [CONFIG\\_LWIP\\_WND\\_SCALE](#)

Enable this feature to support TCP window scaling.

**Range:**

- from 0 to 14 if [CONFIG\\_LWIP\\_WND\\_SCALE](#)

**Default value:**

- 0 if [CONFIG\\_LWIP\\_WND\\_SCALE](#)

**CONFIG\_LWIP\_TCP\_RTO\_TIME**

Default TCP rto time

*Found in:* [Component config](#) > [LWIP](#) > [TCP](#)

Set default TCP rto time for a reasonable initial rto. In bad network environment, recommend set value of rto time to 1500.

**Default value:**

- 1500

**UDP** Contains:

- [CONFIG\\_LWIP\\_UDP\\_RECVMBOX\\_SIZE](#)
- [CONFIG\\_LWIP\\_MAX\\_UDP\\_PCBS](#)

**CONFIG\_LWIP\_MAX\_UDP\_PCBS**

Maximum active UDP control blocks

*Found in:* [Component config](#) > [LWIP](#) > [UDP](#)

The maximum number of active UDP "connections" (ie UDP sockets sending/receiving data). The practical maximum limit is determined by available heap memory at runtime.

**Range:**

- from 1 to 1024

**Default value:**

- 16

**CONFIG\_LWIP\_UDP\_RECVMBOX\_SIZE**

Default UDP receive mail box size

*Found in:* [Component config](#) > [LWIP](#) > [UDP](#)

Set UDP receive mail box size. The recommended value is 6.

UDP receive mail box is a per socket mail box, when the application receives packets from UDP socket, LWIP core firstly posts the packets to UDP receive mail box and the application then fetches the packets from mail box. It means LWIP can caches maximum [UDP\\_RECVMBOX\\_SIZE](#) packets for each UDP socket, so the maximum possible cached UDP packets for all UDP sockets is [UDP\\_RECVMBOX\\_SIZE](#) multiplies the maximum UDP socket number. In other words, the bigger [UDP\\_RECVMBOX\\_SIZE](#) means more memory. On the other hand, if the receive mail box is too small, the mail box may be full. If the mail box is full, the LWIP drops the packets. So generally we need to make sure the UDP receive mail box is big enough to avoid packet drop between LWIP core and application.

**Range:**

- from 6 to 64

**Default value:**

- 6

**Checksums** Contains:

- [CONFIG\\_LWIP\\_CHECKSUM\\_CHECK\\_ICMP](#)
- [CONFIG\\_LWIP\\_CHECKSUM\\_CHECK\\_IP](#)
- [CONFIG\\_LWIP\\_CHECKSUM\\_CHECK\\_UDP](#)

### **CONFIG\_LWIP\_CHECKSUM\_CHECK\_IP**

Enable LWIP IP checksums

*Found in: [Component config](#) > [LWIP](#) > [Checksums](#)*

Enable checksum checking for received IP messages

**Default value:**

- No (disabled)

### **CONFIG\_LWIP\_CHECKSUM\_CHECK\_UDP**

Enable LWIP UDP checksums

*Found in: [Component config](#) > [LWIP](#) > [Checksums](#)*

Enable checksum checking for received UDP messages

**Default value:**

- No (disabled)

### **CONFIG\_LWIP\_CHECKSUM\_CHECK\_ICMP**

Enable LWIP ICMP checksums

*Found in: [Component config](#) > [LWIP](#) > [Checksums](#)*

Enable checksum checking for received ICMP messages

**Default value:**

- Yes (enabled)

### **CONFIG\_LWIP\_TCPIP\_TASK\_STACK\_SIZE**

TCP/IP Task Stack Size

*Found in: [Component config](#) > [LWIP](#)*

Configure TCP/IP task stack size, used by LWIP to process multi-threaded TCP/IP operations. Setting this stack too small will result in stack overflow crashes.

**Range:**

- from 2048 to 65536

**Default value:**

- 3072

### **CONFIG\_LWIP\_TCPIP\_TASK\_AFFINITY**

TCP/IP task affinity

*Found in: [Component config](#) > [LWIP](#)*

Allows setting LwIP tasks affinity, i.e. whether the task is pinned to CPU0, pinned to CPU1, or allowed to run on any CPU. Currently this applies to "TCP/IP" task and "Ping" task.

Available options:

- No affinity (CONFIG\_LWIP\_TCPIP\_TASK\_AFFINITY\_NO\_AFFINITY)
- CPU0 (CONFIG\_LWIP\_TCPIP\_TASK\_AFFINITY\_CPU0)
- CPU1 (CONFIG\_LWIP\_TCPIP\_TASK\_AFFINITY\_CPU1)

### CONFIG\_LWIP\_PPP\_SUPPORT

Enable PPP support

*Found in: [Component config](#) > [LWIP](#)*

Enable PPP stack. Now only PPP over serial is possible.

**Default value:**

- No (disabled)

Contains:

- [CONFIG\\_LWIP\\_PPP\\_ENABLE\\_IPV6](#)

### CONFIG\_LWIP\_PPP\_ENABLE\_IPV6

Enable IPV6 support for PPP connections (IPV6CP)

*Found in: [Component config](#) > [LWIP](#) > [CONFIG\\_LWIP\\_PPP\\_SUPPORT](#)*

Enable IPV6 support in PPP for the local link between the DTE (processor) and DCE (modem). There are some modems which do not support the IPV6 addressing in the local link. If they are requested for IPV6CP negotiation, they may time out. This would in turn fail the configuration for the whole link. If your modem is not responding correctly to PPP Phase Network, try to disable IPV6 support.

**Default value:**

- Yes (enabled) if [CONFIG\\_LWIP\\_PPP\\_SUPPORT](#) && [CONFIG\\_LWIP\\_IPV6](#)

### CONFIG\_LWIP\_IPV6\_MEMP\_NUM\_ND6\_QUEUE

Max number of IPv6 packets to queue during MAC resolution

*Found in: [Component config](#) > [LWIP](#)*

Config max number of IPv6 packets to queue during MAC resolution.

**Range:**

- from 3 to 20

**Default value:**

- 3

### CONFIG\_LWIP\_IPV6\_ND6\_NUM\_NEIGHBORS

Max number of entries in IPv6 neighbor cache

*Found in: [Component config](#) > [LWIP](#)*

Config max number of entries in IPv6 neighbor cache

**Range:**

- from 3 to 10

**Default value:**

- 5

### CONFIG\_LWIP\_PPP\_NOTIFY\_PHASE\_SUPPORT

Enable Notify Phase Callback

*Found in: [Component config](#) > [LWIP](#)*

Enable to set a callback which is called on change of the internal PPP state machine.

**Default value:**

- No (disabled) if [CONFIG\\_LWIP\\_PPP\\_SUPPORT](#)

### CONFIG\_LWIP\_PPP\_PAP\_SUPPORT

Enable PAP support

*Found in: [Component config](#) > [LWIP](#)*

Enable Password Authentication Protocol (PAP) support

**Default value:**

- No (disabled) if [CONFIG\\_LWIP\\_PPP\\_SUPPORT](#)

### CONFIG\_LWIP\_PPP\_CHAP\_SUPPORT

Enable CHAP support

*Found in: [Component config](#) > [LWIP](#)*

Enable Challenge Handshake Authentication Protocol (CHAP) support

**Default value:**

- No (disabled) if [CONFIG\\_LWIP\\_PPP\\_SUPPORT](#)

### CONFIG\_LWIP\_PPP\_MSCHAP\_SUPPORT

Enable MSCHAP support

*Found in: [Component config](#) > [LWIP](#)*

Enable Microsoft version of the Challenge-Handshake Authentication Protocol (MSCHAP) support

**Default value:**

- No (disabled) if [CONFIG\\_LWIP\\_PPP\\_SUPPORT](#)

### CONFIG\_LWIP\_PPP\_MPPE\_SUPPORT

Enable MPPE support

*Found in: [Component config](#) > [LWIP](#)*

Enable Microsoft Point-to-Point Encryption (MPPE) support

**Default value:**

- No (disabled) if [CONFIG\\_LWIP\\_PPP\\_SUPPORT](#)

### CONFIG\_LWIP\_PPP\_SERVER\_SUPPORT

Enable PPP server support

*Found in: [Component config](#) > [LWIP](#)*

Enable to use PPP server

**Default value:**

- No (disabled) if [CONFIG\\_LWIP\\_PPP\\_SUPPORT](#)

### CONFIG\_LWIP\_PPP\_VJ\_HEADER\_COMPRESSION

Enable VJ IP Header compression

*Found in:* *Component config > LWIP*

Enable support for VJ header compression. Please disable this if you're using NAT on PPP interface, since the compressed IP header might not be correctly interpreted in NAT causing the compressed packet to be dropped.

**Default value:**

- Yes (enabled) if *CONFIG\_LWIP\_PPP\_SUPPORT*

### CONFIG\_LWIP\_ENABLE\_LCP\_ECHO

Enable LCP ECHO

*Found in:* *Component config > LWIP*

Enable LCP echo keepalive requests

**Default value:**

- No (disabled) if *CONFIG\_LWIP\_PPP\_SUPPORT*

### CONFIG\_LWIP\_LCP\_ECHOINTERVAL

Echo interval (s)

*Found in:* *Component config > LWIP > CONFIG\_LWIP\_ENABLE\_LCP\_ECHO*

Interval in seconds between keepalive LCP echo requests, 0 to disable.

**Range:**

- from 0 to 1000000 if *CONFIG\_LWIP\_ENABLE\_LCP\_ECHO*

**Default value:**

- 3 if *CONFIG\_LWIP\_ENABLE\_LCP\_ECHO*

### CONFIG\_LWIP\_LCP\_MAXECHOFAILS

Maximum echo failures

*Found in:* *Component config > LWIP > CONFIG\_LWIP\_ENABLE\_LCP\_ECHO*

Number of consecutive unanswered echo requests before failure is indicated.

**Range:**

- from 0 to 100000 if *CONFIG\_LWIP\_ENABLE\_LCP\_ECHO*

**Default value:**

- 3 if *CONFIG\_LWIP\_ENABLE\_LCP\_ECHO*

### CONFIG\_LWIP\_PPP\_DEBUG\_ON

Enable PPP debug log output

*Found in:* *Component config > LWIP*

Enable PPP debug log output

**Default value:**

- No (disabled) if *CONFIG\_LWIP\_PPP\_SUPPORT*



### CONFIG\_LWIP\_SLIP\_SUPPORT

Enable SLIP support (new/experimental)

*Found in: Component config > LWIP*

Enable SLIP stack. Now only SLIP over serial is possible.

SLIP over serial support is experimental and unsupported.

**Default value:**

- No (disabled)

Contains:

- *CONFIG\_LWIP\_SLIP\_DEBUG\_ON*

### CONFIG\_LWIP\_SLIP\_DEBUG\_ON

Enable SLIP debug log output

*Found in: Component config > LWIP > CONFIG\_LWIP\_SLIP\_SUPPORT*

Enable SLIP debug log output

**Default value:**

- No (disabled) if *CONFIG\_LWIP\_SLIP\_SUPPORT*

**ICMP** Contains:

- *CONFIG\_LWIP\_ICMP*
- *CONFIG\_LWIP\_BROADCAST\_PING*
- *CONFIG\_LWIP\_MULTICAST\_PING*

### CONFIG\_LWIP\_ICMP

ICMP: Enable ICMP

*Found in: Component config > LWIP > ICMP*

Enable ICMP module for check network stability

**Default value:**

- Yes (enabled)

### CONFIG\_LWIP\_MULTICAST\_PING

Respond to multicast pings

*Found in: Component config > LWIP > ICMP*

**Default value:**

- No (disabled)

### CONFIG\_LWIP\_BROADCAST\_PING

Respond to broadcast pings

*Found in: Component config > LWIP > ICMP*

**Default value:**

- No (disabled)

**LWIP RAW API** Contains:

- [CONFIG\\_LWIP\\_MAX\\_RAW\\_PCBS](#)

### **CONFIG\_LWIP\_MAX\_RAW\_PCBS**

Maximum LWIP RAW PCBs

*Found in:* [Component config](#) > [LWIP](#) > [LWIP RAW API](#)

The maximum number of simultaneously active LWIP RAW protocol control blocks. The practical maximum limit is determined by available heap memory at runtime.

**Range:**

- from 1 to 1024

**Default value:**

- 16

**SNTP** Contains:

- [CONFIG\\_LWIP\\_SNTP\\_STARTUP\\_DELAY](#)
- [CONFIG\\_LWIP\\_SNTP\\_MAX\\_SERVERS](#)
- [CONFIG\\_LWIP\\_SNTP\\_UPDATE\\_DELAY](#)
- [CONFIG\\_LWIP\\_DHCP\\_GET\\_NTP\\_SRV](#)

### **CONFIG\_LWIP\_SNTP\_MAX\_SERVERS**

Maximum number of NTP servers

*Found in:* [Component config](#) > [LWIP](#) > [SNTP](#)

Set maximum number of NTP servers used by LwIP SNTP module. First argument of `sntp_setserver/sntp_setservername` functions is limited to this value.

**Range:**

- from 1 to 16

**Default value:**

- 1

### **CONFIG\_LWIP\_DHCP\_GET\_NTP\_SRV**

Request NTP servers from DHCP

*Found in:* [Component config](#) > [LWIP](#) > [SNTP](#)

If enabled, LWIP will add 'NTP' to Parameter-Request Option sent via DHCP-request. DHCP server might reply with an NTP server address in option 42. SNTP callback for such replies should be set accordingly (see `sntp_servermode_dhcp()` func.)

**Default value:**

- No (disabled)

### **CONFIG\_LWIP\_DHCP\_MAX\_NTP\_SERVERS**

Maximum number of NTP servers acquired via DHCP

*Found in:* [Component config](#) > [LWIP](#) > [SNTP](#) > [CONFIG\\_LWIP\\_DHCP\\_GET\\_NTP\\_SRV](#)

Set maximum number of NTP servers acquired via DHCP-offer. Should be less or equal to "Maximum number of NTP servers", any extra servers would be just ignored.

**Range:**

- from 1 to 16 if [CONFIG\\_LWIP\\_DHCP\\_GET\\_NTP\\_SRV](#)

**Default value:**

- 1 if `CONFIG_LWIP_DHCP_GET_NTP_SRV`

### **CONFIG\_LWIP\_SNTP\_UPDATE\_DELAY**

Request interval to update time (ms)

*Found in: [Component config](#) > [LWIP](#) > [SNTP](#)*

This option allows you to set the time update period via SNTP. Default is 1 hour. Must not be below 15 seconds by specification. (SNTPv4 RFC 4330 enforces a minimum update time of 15 seconds).

**Range:**

- from 15000 to 4294967295

**Default value:**

- 3600000

### **CONFIG\_LWIP\_SNTP\_STARTUP\_DELAY**

Enable SNTP startup delay

*Found in: [Component config](#) > [LWIP](#) > [SNTP](#)*

It is recommended (RFC 4330) to delay the initial request after by a random timeout from 1 to 5 minutes to reduce potential load of NTP servers after simultaneous power-up of many devices. This option disables this initial delay. Please use this option with care, it could improve a single device responsiveness but might cause peaks on the network after reset. Another option to address responsiveness of devices while using the initial random delay is to adjust `LWIP_SNTP_MAXIMUM_STARTUP_DELAY`.

**Default value:**

- Yes (enabled)

### **CONFIG\_LWIP\_SNTP\_MAXIMUM\_STARTUP\_DELAY**

Maximum startup delay (ms)

*Found in: [Component config](#) > [LWIP](#) > [SNTP](#) > [CONFIG\\_LWIP\\_SNTP\\_STARTUP\\_DELAY](#)*

RFC 4330 recommends a startup delay before sending the initial request. LWIP calculates this delay to a random number of milliseconds between 0 and this value.

**Range:**

- from 100 to 300000

**Default value:**

- 5000

**DNS** Contains:

- `CONFIG_LWIP_FALLBACK_DNS_SERVER_SUPPORT`
- `CONFIG_LWIP_DNS_MAX_SERVERS`

### **CONFIG\_LWIP\_DNS\_MAX\_SERVERS**

Maximum number of DNS servers

*Found in: [Component config](#) > [LWIP](#) > [DNS](#)*

Set maximum number of DNS servers. If fallback DNS servers are supported, the number of DNS servers needs to be greater than or equal to 3.

**Range:**

- from 1 to 4

**Default value:**

- 3

### CONFIG\_LWIP\_FALLBACK\_DNS\_SERVER\_SUPPORT

Enable DNS fallback server support

*Found in: Component config > LWIP > DNS*

Enable this feature to support DNS fallback server.

**Default value:**

- No (disabled)

### CONFIG\_LWIP\_FALLBACK\_DNS\_SERVER\_ADDRESS

DNS fallback server address

*Found in: Component config > LWIP > DNS > CONFIG\_LWIP\_FALLBACK\_DNS\_SERVER\_SUPPORT*

This option allows you to config dns fallback server address.

**Default value:**

- "114.114.114.114" if *CONFIG\_LWIP\_FALLBACK\_DNS\_SERVER\_SUPPORT*

### CONFIG\_LWIP\_BRIDGEIF\_MAX\_PORTS

Maximum number of bridge ports

*Found in: Component config > LWIP*

Set maximum number of ports a bridge can consists of.

**Range:**

- from 1 to 63

**Default value:**

- 7

### CONFIG\_LWIP\_ESP\_LWIP\_ASSERT

Enable LWIP ASSERT checks

*Found in: Component config > LWIP*

Enable this option keeps LWIP assertion checks enabled. It is recommended to keep this option enabled.

If asserts are disabled for the entire project, they are also disabled for LWIP and this option is ignored.

**Hooks** Contains:

- *CONFIG\_LWIP\_HOOK\_ND6\_GET\_GW*
- *CONFIG\_LWIP\_HOOK\_IP6\_INPUT*
- *CONFIG\_LWIP\_HOOK\_IP6\_ROUTE*
- *CONFIG\_LWIP\_HOOK\_IP6\_SELECT\_SRC\_ADDR*
- *CONFIG\_LWIP\_HOOK\_NETCONN\_EXTERNAL\_RESOLVE*
- *CONFIG\_LWIP\_HOOK\_TCP\_ISN*

### CONFIG\_LWIP\_HOOK\_TCP\_ISN

TCP ISN Hook

*Found in: Component config > LWIP > Hooks*

Enables to define a TCP ISN hook to randomize initial sequence number in TCP connection. The default TCP ISN algorithm used in IDF (standardized in RFC 6528) produces ISN by combining an MD5 of the new TCP id and a stable secret with the current time. This is because the lwIP implementation (*tcp\_next\_isn*) is not very strong, as it does not take into consideration any platform specific entropy source.

Set to `LWIP_HOOK_TCP_ISN_CUSTOM` to provide custom implementation. Set to `LWIP_HOOK_TCP_ISN_NONE` to use lwIP implementation.

Available options:

- No hook declared (`CONFIG_LWIP_HOOK_TCP_ISN_NONE`)
- Default implementation (`CONFIG_LWIP_HOOK_TCP_ISN_DEFAULT`)
- Custom implementation (`CONFIG_LWIP_HOOK_TCP_ISN_CUSTOM`)

## **CONFIG\_LWIP\_HOOK\_IP6\_ROUTE**

IPv6 route Hook

*Found in: [Component config](#) > [LWIP](#) > [Hooks](#)*

Enables custom IPv6 route hook. Setting this to "default" provides weak implementation stub that could be overwritten in application code. Setting this to "custom" provides hook's declaration only and expects the application to implement it.

Available options:

- No hook declared (`CONFIG_LWIP_HOOK_IP6_ROUTE_NONE`)
- Default (weak) implementation (`CONFIG_LWIP_HOOK_IP6_ROUTE_DEFAULT`)
- Custom implementation (`CONFIG_LWIP_HOOK_IP6_ROUTE_CUSTOM`)

## **CONFIG\_LWIP\_HOOK\_ND6\_GET\_GW**

IPv6 get gateway Hook

*Found in: [Component config](#) > [LWIP](#) > [Hooks](#)*

Enables custom IPv6 route hook. Setting this to "default" provides weak implementation stub that could be overwritten in application code. Setting this to "custom" provides hook's declaration only and expects the application to implement it.

Available options:

- No hook declared (`CONFIG_LWIP_HOOK_ND6_GET_GW_NONE`)
- Default (weak) implementation (`CONFIG_LWIP_HOOK_ND6_GET_GW_DEFAULT`)
- Custom implementation (`CONFIG_LWIP_HOOK_ND6_GET_GW_CUSTOM`)

## **CONFIG\_LWIP\_HOOK\_IP6\_SELECT\_SRC\_ADDR**

IPv6 source address selection Hook

*Found in: [Component config](#) > [LWIP](#) > [Hooks](#)*

Enables custom IPv6 source address selection. Setting this to "default" provides weak implementation stub that could be overwritten in application code. Setting this to "custom" provides hook's declaration only and expects the application to implement it.

Available options:

- No hook declared (`CONFIG_LWIP_HOOK_IP6_SELECT_SRC_ADDR_NONE`)
- Default (weak) implementation (`CONFIG_LWIP_HOOK_IP6_SELECT_SRC_ADDR_DEFAULT`)
- Custom implementation (`CONFIG_LWIP_HOOK_IP6_SELECT_SRC_ADDR_CUSTOM`)

## CONFIG\_LWIP\_HOOK\_NETCONN\_EXTERNAL\_RESOLVE

Netconn external resolve Hook

*Found in: [Component config](#) > [LWIP](#) > [Hooks](#)*

Enables custom DNS resolve hook. Setting this to "default" provides weak implementation stub that could be overwritten in application code. Setting this to "custom" provides hook's declaration only and expects the application to implement it.

Available options:

- No hook declared (CONFIG\_LWIP\_HOOK\_NETCONN\_EXT\_RESOLVE\_NONE)
- Default (weak) implementation (CONFIG\_LWIP\_HOOK\_NETCONN\_EXT\_RESOLVE\_DEFAULT)
- Custom implementation (CONFIG\_LWIP\_HOOK\_NETCONN\_EXT\_RESOLVE\_CUSTOM)

## CONFIG\_LWIP\_HOOK\_IP6\_INPUT

IPv6 packet input

*Found in: [Component config](#) > [LWIP](#) > [Hooks](#)*

Enables custom IPv6 packet input. Setting this to "default" provides weak implementation stub that could be overwritten in application code. Setting this to "custom" provides hook's declaration only and expects the application to implement it.

Available options:

- No hook declared (CONFIG\_LWIP\_HOOK\_IP6\_INPUT\_NONE)
- Default (weak) implementation (CONFIG\_LWIP\_HOOK\_IP6\_INPUT\_DEFAULT)
- Custom implementation (CONFIG\_LWIP\_HOOK\_IP6\_INPUT\_CUSTOM)

## CONFIG\_LWIP\_DEBUG

Enable LWIP Debug

*Found in: [Component config](#) > [LWIP](#)*

Enabling this option allows different kinds of lwIP debug output.

All lwIP debug features increase the size of the final binary.

**Default value:**

- No (disabled)

Contains:

- [CONFIG\\_LWIP\\_API\\_LIB\\_DEBUG](#)
- [CONFIG\\_LWIP\\_BRIDGEIF\\_FDB\\_DEBUG](#)
- [CONFIG\\_LWIP\\_BRIDGEIF\\_FW\\_DEBUG](#)
- [CONFIG\\_LWIP\\_BRIDGEIF\\_DEBUG](#)
- [CONFIG\\_LWIP\\_DHCP\\_DEBUG](#)
- [CONFIG\\_LWIP\\_DHCP\\_STATE\\_DEBUG](#)
- [CONFIG\\_LWIP\\_DNS\\_DEBUG](#)
- [CONFIG\\_LWIP\\_ETHARP\\_DEBUG](#)
- [CONFIG\\_LWIP\\_ICMP\\_DEBUG](#)
- [CONFIG\\_LWIP\\_ICMP6\\_DEBUG](#)
- [CONFIG\\_LWIP\\_IP\\_DEBUG](#)
- [CONFIG\\_LWIP\\_IP6\\_DEBUG](#)
- [CONFIG\\_LWIP\\_NAPT\\_DEBUG](#)
- [CONFIG\\_LWIP\\_NETIF\\_DEBUG](#)
- [CONFIG\\_LWIP\\_PBUF\\_DEBUG](#)

- [CONFIG\\_LWIP\\_SNTP\\_DEBUG](#)
- [CONFIG\\_LWIP\\_SOCKETS\\_DEBUG](#)
- [CONFIG\\_LWIP\\_TCP\\_DEBUG](#)
- [CONFIG\\_LWIP\\_UDP\\_DEBUG](#)
- [CONFIG\\_LWIP\\_DEBUG\\_ESP\\_LOG](#)

### **CONFIG\_LWIP\_DEBUG\_ESP\_LOG**

Route LWIP debugs through ESP\_LOG interface

*Found in: Component config > LWIP > CONFIG\_LWIP\_DEBUG*

Enabling this option routes all enabled LWIP debugs through ESP\_LOGD.

**Default value:**

- No (disabled) if [CONFIG\\_LWIP\\_DEBUG](#)

### **CONFIG\_LWIP\_NETIF\_DEBUG**

Enable netif debug messages

*Found in: Component config > LWIP > CONFIG\_LWIP\_DEBUG*

**Default value:**

- No (disabled) if [CONFIG\\_LWIP\\_DEBUG](#)

### **CONFIG\_LWIP\_PBUF\_DEBUG**

Enable pbuf debug messages

*Found in: Component config > LWIP > CONFIG\_LWIP\_DEBUG*

**Default value:**

- No (disabled) if [CONFIG\\_LWIP\\_DEBUG](#)

### **CONFIG\_LWIP\_ETHARP\_DEBUG**

Enable etharp debug messages

*Found in: Component config > LWIP > CONFIG\_LWIP\_DEBUG*

**Default value:**

- No (disabled) if [CONFIG\\_LWIP\\_DEBUG](#)

### **CONFIG\_LWIP\_API\_LIB\_DEBUG**

Enable api lib debug messages

*Found in: Component config > LWIP > CONFIG\_LWIP\_DEBUG*

**Default value:**

- No (disabled) if [CONFIG\\_LWIP\\_DEBUG](#)

### **CONFIG\_LWIP\_SOCKETS\_DEBUG**

Enable socket debug messages

*Found in: Component config > LWIP > CONFIG\_LWIP\_DEBUG*

**Default value:**

- No (disabled) if [CONFIG\\_LWIP\\_DEBUG](#)

### CONFIG\_LWIP\_IP\_DEBUG

Enable IP debug messages

*Found in: Component config > LWIP > CONFIG\_LWIP\_DEBUG*

**Default value:**

- No (disabled) if *CONFIG\_LWIP\_DEBUG*

### CONFIG\_LWIP\_ICMP\_DEBUG

Enable ICMP debug messages

*Found in: Component config > LWIP > CONFIG\_LWIP\_DEBUG*

**Default value:**

- No (disabled) if *CONFIG\_LWIP\_DEBUG* && *CONFIG\_LWIP\_ICMP*

### CONFIG\_LWIP\_DHCP\_STATE\_DEBUG

Enable DHCP state tracking

*Found in: Component config > LWIP > CONFIG\_LWIP\_DEBUG*

**Default value:**

- No (disabled) if *CONFIG\_LWIP\_DEBUG*

### CONFIG\_LWIP\_DHCP\_DEBUG

Enable DHCP debug messages

*Found in: Component config > LWIP > CONFIG\_LWIP\_DEBUG*

**Default value:**

- No (disabled) if *CONFIG\_LWIP\_DEBUG*

### CONFIG\_LWIP\_IP6\_DEBUG

Enable IP6 debug messages

*Found in: Component config > LWIP > CONFIG\_LWIP\_DEBUG*

**Default value:**

- No (disabled) if *CONFIG\_LWIP\_DEBUG*

### CONFIG\_LWIP\_ICMP6\_DEBUG

Enable ICMP6 debug messages

*Found in: Component config > LWIP > CONFIG\_LWIP\_DEBUG*

**Default value:**

- No (disabled) if *CONFIG\_LWIP\_DEBUG*

### CONFIG\_LWIP\_TCP\_DEBUG

Enable TCP debug messages

*Found in: Component config > LWIP > CONFIG\_LWIP\_DEBUG*

**Default value:**

- No (disabled) if *CONFIG\_LWIP\_DEBUG*



### CONFIG\_LWIP\_UDP\_DEBUG

Enable UDP debug messages

*Found in: Component config > LWIP > CONFIG\_LWIP\_DEBUG*

**Default value:**

- No (disabled) if *CONFIG\_LWIP\_DEBUG*

### CONFIG\_LWIP\_SNTP\_DEBUG

Enable SNTP debug messages

*Found in: Component config > LWIP > CONFIG\_LWIP\_DEBUG*

**Default value:**

- No (disabled) if *CONFIG\_LWIP\_DEBUG*

### CONFIG\_LWIP\_DNS\_DEBUG

Enable DNS debug messages

*Found in: Component config > LWIP > CONFIG\_LWIP\_DEBUG*

**Default value:**

- No (disabled) if *CONFIG\_LWIP\_DEBUG*

### CONFIG\_LWIP\_NAPT\_DEBUG

Enable NAPT debug messages

*Found in: Component config > LWIP > CONFIG\_LWIP\_DEBUG*

**Default value:**

- No (disabled) if *CONFIG\_LWIP\_DEBUG* && *CONFIG\_LWIP\_IPV4\_NAPT*

### CONFIG\_LWIP\_BRIDGEIF\_DEBUG

Enable bridge generic debug messages

*Found in: Component config > LWIP > CONFIG\_LWIP\_DEBUG*

**Default value:**

- No (disabled) if *CONFIG\_LWIP\_DEBUG*

### CONFIG\_LWIP\_BRIDGEIF\_FDB\_DEBUG

Enable bridge FDB debug messages

*Found in: Component config > LWIP > CONFIG\_LWIP\_DEBUG*

**Default value:**

- No (disabled) if *CONFIG\_LWIP\_DEBUG*

### CONFIG\_LWIP\_BRIDGEIF\_FW\_DEBUG

Enable bridge forwarding debug messages

*Found in: Component config > LWIP > CONFIG\_LWIP\_DEBUG*

**Default value:**

- No (disabled) if *CONFIG\_LWIP\_DEBUG*

**MBEDTLS** Contains:

- `CONFIG_MBEDTLS_ASYMMETRIC_CONTENT_LEN`
- *Certificate Bundle*
- *Certificates*
- `CONFIG_MBEDTLS_CHACHA20_C`
- `CONFIG_MBEDTLS_DHM_C`
- `CONFIG_MBEDTLS_ECP_C`
- `CONFIG_MBEDTLS_ECDH_C`
- `CONFIG_MBEDTLS_ECJPAKE_C`
- `CONFIG_MBEDTLS_ECP_DP_BP256R1_ENABLED`
- `CONFIG_MBEDTLS_ECP_DP_BP384R1_ENABLED`
- `CONFIG_MBEDTLS_ECP_DP_BP512R1_ENABLED`
- `CONFIG_MBEDTLS_CMAC_C`
- `CONFIG_MBEDTLS_ECP_DP_CURVE25519_ENABLED`
- `CONFIG_MBEDTLS_ECDSA_DETERMINISTIC`
- `CONFIG_MBEDTLS_HARDWARE_ECDSA_VERIFY`
- `CONFIG_MBEDTLS_HARDWARE_ECDSA_SIGN`
- `CONFIG_MBEDTLS_ERROR_STRINGS`
- `CONFIG_MBEDTLS_ECP_FIXED_POINT_OPTIM`
- `CONFIG_MBEDTLS_HARDWARE_AES`
- `CONFIG_MBEDTLS_HARDWARE_ECC`
- `CONFIG_MBEDTLS_ATCA_HW_ECDSA_SIGN`
- `CONFIG_MBEDTLS_ATCA_HW_ECDSA_VERIFY`
- `CONFIG_MBEDTLS_HARDWARE_MPI`
- `CONFIG_MBEDTLS_HARDWARE_SHA`
- `CONFIG_MBEDTLS_DEBUG`
- `CONFIG_MBEDTLS_ECP_RESTARTABLE`
- `CONFIG_MBEDTLS_HAVE_TIME`
- `CONFIG_MBEDTLS_RIPEMD160_C`
- `CONFIG_MBEDTLS_ECP_DP_SECP192K1_ENABLED`
- `CONFIG_MBEDTLS_ECP_DP_SECP192R1_ENABLED`
- `CONFIG_MBEDTLS_ECP_DP_SECP224K1_ENABLED`
- `CONFIG_MBEDTLS_ECP_DP_SECP224R1_ENABLED`
- `CONFIG_MBEDTLS_ECP_DP_SECP256K1_ENABLED`
- `CONFIG_MBEDTLS_ECP_DP_SECP256R1_ENABLED`
- `CONFIG_MBEDTLS_ECP_DP_SECP384R1_ENABLED`
- `CONFIG_MBEDTLS_ECP_DP_SECP521R1_ENABLED`
- `CONFIG_MBEDTLS_SHA512_C`
- `CONFIG_MBEDTLS_THREADING_C`
- `CONFIG_MBEDTLS_HKDF_C`
- *MBEDTLS v3.x related*
- `CONFIG_MBEDTLS_MEM_ALLOC_MODE`
- `CONFIG_MBEDTLS_ECP_NIST_OPTIM`
- `CONFIG_MBEDTLS_POLY1305_C`
- `CONFIG_MBEDTLS_SSL_ALPN`
- `CONFIG_MBEDTLS_SSL_PROTO_DTLS`
- `CONFIG_MBEDTLS_SSL_PROTO_GMTSSL1_1`
- `CONFIG_MBEDTLS_SSL_PROTO_TLS1_2`
- `CONFIG_MBEDTLS_SSL_RENEGOTIATION`
- *Symmetric Ciphers*
- *TLS Key Exchange Methods*
- `CONFIG_MBEDTLS_SSL_MAX_CONTENT_LEN`
- `CONFIG_MBEDTLS_TLS_MODE`
- `CONFIG_MBEDTLS_CLIENT_SSL_SESSION_TICKETS`
- `CONFIG_MBEDTLS_SERVER_SSL_SESSION_TICKETS`
- `CONFIG_MBEDTLS_ROM_MD5`
- `CONFIG_MBEDTLS_USE_CRYPTO_ROM_IMPL`
- `CONFIG_MBEDTLS_DYNAMIC_BUFFER`

## CONFIG\_MBEDTLS\_MEM\_ALLOC\_MODE

Memory allocation strategy

Found in: *Component config > mbedTLS*

Allocation strategy for mbedTLS, essentially provides ability to allocate all required dynamic allocations from,

- Internal DRAM memory only
- External SPIRAM memory only
- Either internal or external memory based on default malloc() behavior in ESP-IDF
- Custom allocation mode, by overwriting calloc()/free() using mbedtls\_platform\_set\_calloc\_free() function
- Internal IRAM memory wherever applicable else internal DRAM

Recommended mode here is always internal (\*), since that is most preferred from security perspective. But if application requirement does not allow sufficient free internal memory then alternate mode can be selected.

(\*) In case of ESP32-S2/ESP32-S3, hardware allows encryption of external SPIRAM contents provided hardware flash encryption feature is enabled. In that case, using external SPIRAM allocation strategy is also safe choice from security perspective.

Available options:

- Internal memory (CONFIG\_MBEDTLS\_INTERNAL\_MEM\_ALLOC)
- External SPIRAM (CONFIG\_MBEDTLS\_EXTERNAL\_MEM\_ALLOC)
- Default alloc mode (CONFIG\_MBEDTLS\_DEFAULT\_MEM\_ALLOC)
- Custom alloc mode (CONFIG\_MBEDTLS\_CUSTOM\_MEM\_ALLOC)
- Internal IRAM (CONFIG\_MBEDTLS\_IRAM\_8BIT\_MEM\_ALLOC)

Allows to use IRAM memory region as 8bit accessible region.

TLS input and output buffers will be allocated in IRAM section which is 32bit aligned memory. Every unaligned (8bit or 16bit) access will result in an exception and incur penalty of certain clock cycles per unaligned read/write.

## CONFIG\_MBEDTLS\_SSL\_MAX\_CONTENT\_LEN

TLS maximum message content length

Found in: *Component config > mbedTLS*

Maximum TLS message length (in bytes) supported by mbedTLS.

16384 is the default and this value is required to comply fully with TLS standards.

However you can set a lower value in order to save RAM. This is safe if the other end of the connection supports Maximum Fragment Length Negotiation Extension (max\_fragment\_length, see RFC6066) or you know for certain that it will never send a message longer than a certain number of bytes.

If the value is set too low, symptoms are a failed TLS handshake or a return value of MBEDTLS\_ERR\_SSL\_INVALID\_RECORD (-0x7200).

## CONFIG\_MBEDTLS\_ASYMMETRIC\_CONTENT\_LEN

Asymmetric in/out fragment length

Found in: *Component config > mbedTLS*

If enabled, this option allows customizing TLS in/out fragment length in asymmetric way. Please note that enabling this with default values saves 12KB of dynamic memory per TLS connection.

**Default value:**

- Yes (enabled)

### CONFIG\_MBEDTLS\_SSL\_IN\_CONTENT\_LEN

TLS maximum incoming fragment length

Found in: *Component config* > *mbedtls* > *CONFIG\_MBEDTLS\_ASYMMETRIC\_CONTENT\_LEN*

This defines maximum incoming fragment length, overriding default maximum content length (MBEDTLS\_SSL\_MAX\_CONTENT\_LEN).

**Range:**

- from 512 to 16384

**Default value:**

- 16384

### CONFIG\_MBEDTLS\_SSL\_OUT\_CONTENT\_LEN

TLS maximum outgoing fragment length

Found in: *Component config* > *mbedtls* > *CONFIG\_MBEDTLS\_ASYMMETRIC\_CONTENT\_LEN*

This defines maximum outgoing fragment length, overriding default maximum content length (MBEDTLS\_SSL\_MAX\_CONTENT\_LEN).

**Range:**

- from 512 to 16384

**Default value:**

- 4096

### CONFIG\_MBEDTLS\_DYNAMIC\_BUFFER

Using dynamic TX/RX buffer

Found in: *Component config* > *mbedtls*

Using dynamic TX/RX buffer. After enabling this option, mbedtls will allocate TX buffer when need to send data and then free it if all data is sent, allocate RX buffer when need to receive data and then free it when all data is used or read by upper layer.

By default, when SSL is initialized, mbedtls also allocate TX and RX buffer with the default value of "MBEDTLS\_SSL\_OUT\_CONTENT\_LEN" or "MBEDTLS\_SSL\_IN\_CONTENT\_LEN", so to save more heap, users can set the options to be an appropriate value.

### CONFIG\_MBEDTLS\_DYNAMIC\_FREE\_CONFIG\_DATA

Free private key and DHM data after its usage

Found in: *Component config* > *mbedtls* > *CONFIG\_MBEDTLS\_DYNAMIC\_BUFFER*

Free private key and DHM data after its usage in handshake process.

The option will decrease heap cost when handshake, but also lead to problem:

Because all certificate, private key and DHM data are freed so users should register certificate and private key to ssl config object again.

**Default value:**

- No (disabled) if *CONFIG\_MBEDTLS\_DYNAMIC\_BUFFER*

### CONFIG\_MBEDTLS\_DYNAMIC\_FREE\_CA\_CERT

Free SSL CA certificate after its usage

Found in: *Component config* > *mbedtls* > *CONFIG\_MBEDTLS\_DYNAMIC\_BUFFER* > *CONFIG\_MBEDTLS\_DYNAMIC\_FREE\_CONFIG\_DATA*

Free CA certificate after its usage in the handshake process. This option will decrease the heap footprint for the TLS handshake, but may lead to a problem: If the respective ssl object needs to perform the TLS handshake again, the CA certificate should once again be registered to the ssl object.

**Default value:**

- Yes (enabled) if `CONFIG_MBEDTLS_DYNAMIC_FREE_CONFIG_DATA`

**CONFIG\_MBEDTLS\_DEBUG**

Enable mbedTLS debugging

*Found in: Component config > mbedTLS*

Enable mbedTLS debugging functions at compile time.

If this option is enabled, you can include "mbedtls/esp\_debug.h" and call `mbedtls_esp_enable_debug_log()` at runtime in order to enable mbedTLS debug output via the ESP log mechanism.

**Default value:**

- No (disabled)

**CONFIG\_MBEDTLS\_DEBUG\_LEVEL**

Set mbedTLS debugging level

*Found in: Component config > mbedTLS > CONFIG\_MBEDTLS\_DEBUG*

Set mbedTLS debugging level

Available options:

- Warning (`CONFIG_MBEDTLS_DEBUG_LEVEL_WARN`)
- Info (`CONFIG_MBEDTLS_DEBUG_LEVEL_INFO`)
- Debug (`CONFIG_MBEDTLS_DEBUG_LEVEL_DEBUG`)
- Verbose (`CONFIG_MBEDTLS_DEBUG_LEVEL_VERBOSE`)

**mbedTLS v3.x related** Contains:

- *DTLS-based configurations*
- `CONFIG_MBEDTLS_PKCS7_C`
- `CONFIG_MBEDTLS_SSL_CONTEXT_SERIALIZATION`
- `CONFIG_MBEDTLS_X509_TRUSTED_CERT_CALLBACK`
- `CONFIG_MBEDTLS_SSL_KEEP_PEER_CERTIFICATE`
- `CONFIG_MBEDTLS_SSL_CID_PADDING_GRANULARITY`
- `CONFIG_MBEDTLS_SSL_PROTO_TLS1_3`
- `CONFIG_MBEDTLS_ECDH_LEGACY_CONTEXT`
- `CONFIG_MBEDTLS_SSL_VARIABLE_BUFFER_LENGTH`

**CONFIG\_MBEDTLS\_SSL\_PROTO\_TLS1\_3**

Support TLS 1.3 protocol

*Found in: Component config > mbedTLS > mbedTLS v3.x related*

**TLS 1.3 related configurations** Contains:

- `CONFIG_MBEDTLS_SSL_TLS1_3_KEXM_EPHEMERAL`
- `CONFIG_MBEDTLS_SSL_TLS1_3_COMPATIBILITY_MODE`
- `CONFIG_MBEDTLS_SSL_TLS1_3_KEXM_PSK_EPHEMERAL`
- `CONFIG_MBEDTLS_SSL_TLS1_3_KEXM_PSK`

### CONFIG\_MBEDTLS\_SSL\_TLS1\_3\_COMPATIBILITY\_MODE

TLS 1.3 middlebox compatibility mode

*Found in:* [Component config](#) > [mbedtls](#) > [mbedtls v3.x related](#) > [CONFIG\\_MBEDTLS\\_SSL\\_PROTO\\_TLS1\\_3](#) > [TLS 1.3 related configurations](#)

**Default value:**

- Yes (enabled) if [CONFIG\\_MBEDTLS\\_SSL\\_PROTO\\_TLS1\\_3](#)

### CONFIG\_MBEDTLS\_SSL\_TLS1\_3\_KEXM\_PSK

TLS 1.3 PSK key exchange mode

*Found in:* [Component config](#) > [mbedtls](#) > [mbedtls v3.x related](#) > [CONFIG\\_MBEDTLS\\_SSL\\_PROTO\\_TLS1\\_3](#) > [TLS 1.3 related configurations](#)

**Default value:**

- Yes (enabled) if [CONFIG\\_MBEDTLS\\_SSL\\_PROTO\\_TLS1\\_3](#)

### CONFIG\_MBEDTLS\_SSL\_TLS1\_3\_KEXM\_EPHEMERAL

TLS 1.3 ephemeral key exchange mode

*Found in:* [Component config](#) > [mbedtls](#) > [mbedtls v3.x related](#) > [CONFIG\\_MBEDTLS\\_SSL\\_PROTO\\_TLS1\\_3](#) > [TLS 1.3 related configurations](#)

**Default value:**

- Yes (enabled) if [CONFIG\\_MBEDTLS\\_SSL\\_PROTO\\_TLS1\\_3](#)

### CONFIG\_MBEDTLS\_SSL\_TLS1\_3\_KEXM\_PSK\_EPHEMERAL

TLS 1.3 PSK ephemeral key exchange mode

*Found in:* [Component config](#) > [mbedtls](#) > [mbedtls v3.x related](#) > [CONFIG\\_MBEDTLS\\_SSL\\_PROTO\\_TLS1\\_3](#) > [TLS 1.3 related configurations](#)

**Default value:**

- Yes (enabled) if [CONFIG\\_MBEDTLS\\_SSL\\_PROTO\\_TLS1\\_3](#)

### CONFIG\_MBEDTLS\_SSL\_VARIABLE\_BUFFER\_LENGTH

Variable SSL buffer length

*Found in:* [Component config](#) > [mbedtls](#) > [mbedtls v3.x related](#)

This enables the SSL buffer to be resized automatically based on the negotiated maximum fragment length in each direction.

**Default value:**

- No (disabled)

### CONFIG\_MBEDTLS\_ECDH\_LEGACY\_CONTEXT

Use a backward compatible ECDH context (Experimental)

*Found in:* [Component config](#) > [mbedtls](#) > [mbedtls v3.x related](#)

Use the legacy ECDH context format. Define this option only if you enable [MBEDTLS\\_ECP\\_RESTARTABLE](#) or if you want to access ECDH context fields directly.

**Default value:**

- No (disabled) if [CONFIG\\_MBEDTLS\\_ECDH\\_C](#) && [CONFIG\\_MBEDTLS\\_ECP\\_RESTARTABLE](#)

### CONFIG\_MBEDTLS\_X509\_TRUSTED\_CERT\_CALLBACK

Enable trusted certificate callbacks

*Found in: [Component config](#) > [mbedtls](#) > [mbedtls v3.x related](#)*

Enables users to configure the set of trusted certificates through a callback instead of a linked list.

See mbedtls documentation for required API and more details.

**Default value:**

- No (disabled)

### CONFIG\_MBEDTLS\_SSL\_CONTEXT\_SERIALIZATION

Enable serialization of the TLS context structures

*Found in: [Component config](#) > [mbedtls](#) > [mbedtls v3.x related](#)*

Enable serialization of the TLS context structures This is a local optimization in handling a single, potentially long-lived connection.

See mbedtls documentation for required API and more details. Disabling this option will save some code size.

**Default value:**

- No (disabled)

### CONFIG\_MBEDTLS\_SSL\_KEEP\_PEER\_CERTIFICATE

Keep peer certificate after handshake completion

*Found in: [Component config](#) > [mbedtls](#) > [mbedtls v3.x related](#)*

Keep the peer's certificate after completion of the handshake. Disabling this option will save about 4kB of heap and some code size.

See mbedtls documentation for required API and more details.

**Default value:**

- Yes (enabled)

### CONFIG\_MBEDTLS\_PKCS7\_C

Enable PKCS #7

*Found in: [Component config](#) > [mbedtls](#) > [mbedtls v3.x related](#)*

Enable PKCS #7 core for using PKCS #7-formatted signatures.

**Default value:**

- Yes (enabled)

### CONFIG\_MBEDTLS\_SSL\_CID\_PADDING\_GRANULARITY

Record plaintext padding

*Found in: [Component config](#) > [mbedtls](#) > [mbedtls v3.x related](#)*

Controls the use of record plaintext padding in TLS 1.3 and when using the Connection ID extension in DTLS 1.2.

The padding will always be chosen so that the length of the padded plaintext is a multiple of the value of this option.

**Notes:** A value of 1 means that no padding will be used for outgoing records. On systems lacking division instructions, a power of two should be preferred.

**Range:**

- from 0 to 32 if `CONFIG_MBEDTLS_SSL_PROTO_TLS1_3` || `CONFIG_MBEDTLS_SSL_DTLS_CONNECTION_ID`

**Default value:**

- 16 if `CONFIG_MBEDTLS_SSL_PROTO_TLS1_3` || `CONFIG_MBEDTLS_SSL_DTLS_CONNECTION_ID`

**DTLS-based configurations** Contains:

- `CONFIG_MBEDTLS_SSL_DTLS_SRTP`
- `CONFIG_MBEDTLS_SSL_DTLS_CONNECTION_ID`

**CONFIG\_MBEDTLS\_SSL\_DTLS\_CONNECTION\_ID**

Support for the DTLS Connection ID extension

*Found in: Component config > mbedTLS > mbedTLS v3.x related > DTLS-based configurations*

Enable support for the DTLS Connection ID extension which allows to identify DTLS connections across changes in the underlying transport.

**Default value:**

- No (disabled) if `CONFIG_MBEDTLS_SSL_PROTO_DTLS`

**CONFIG\_MBEDTLS\_SSL\_CID\_IN\_LEN\_MAX**

Maximum length of CIDs used for incoming DTLS messages

*Found in: Component config > mbedTLS > mbedTLS v3.x related > DTLS-based configurations > CONFIG\_MBEDTLS\_SSL\_DTLS\_CONNECTION\_ID*

Maximum length of CIDs used for incoming DTLS messages

**Range:**

- from 0 to 32 if `CONFIG_MBEDTLS_SSL_DTLS_CONNECTION_ID` && `CONFIG_MBEDTLS_SSL_PROTO_DTLS`

**Default value:**

- 32 if `CONFIG_MBEDTLS_SSL_DTLS_CONNECTION_ID` && `CONFIG_MBEDTLS_SSL_PROTO_DTLS`

**CONFIG\_MBEDTLS\_SSL\_CID\_OUT\_LEN\_MAX**

Maximum length of CIDs used for outgoing DTLS messages

*Found in: Component config > mbedTLS > mbedTLS v3.x related > DTLS-based configurations > CONFIG\_MBEDTLS\_SSL\_DTLS\_CONNECTION\_ID*

Maximum length of CIDs used for outgoing DTLS messages

**Range:**

- from 0 to 32 if `CONFIG_MBEDTLS_SSL_DTLS_CONNECTION_ID` && `CONFIG_MBEDTLS_SSL_PROTO_DTLS`

**Default value:**

- 32 if `CONFIG_MBEDTLS_SSL_DTLS_CONNECTION_ID` && `CONFIG_MBEDTLS_SSL_PROTO_DTLS`

**CONFIG\_MBEDTLS\_SSL\_DTLS\_SRTP**

Enable support for negotiation of DTLS-SRTP (RFC 5764)

*Found in: Component config > mbedTLS > mbedTLS v3.x related > DTLS-based configurations*

Enable support for negotiation of DTLS-SRTP (RFC 5764) through the `use_srtp` extension.



See mbedTLS documentation for required API and more details. Disabling this option will save some code size.

**Default value:**

- No (disabled) if `CONFIG_MBEDTLS_SSL_PROTO_DTLS`

**Certificate Bundle** Contains:

- `CONFIG_MBEDTLS_CERTIFICATE_BUNDLE`

**CONFIG\_MBEDTLS\_CERTIFICATE\_BUNDLE**

Enable trusted root certificate bundle

*Found in:* [Component config](#) > [mbedTLS](#) > [Certificate Bundle](#)

Enable support for large number of default root certificates

When enabled this option allows user to store default as well as customer specific root certificates in compressed format rather than storing full certificate. For the root certificates the public key and the subject name will be stored.

**Default value:**

- Yes (enabled)

**CONFIG\_MBEDTLS\_DEFAULT\_CERTIFICATE\_BUNDLE**

Default certificate bundle options

*Found in:* [Component config](#) > [mbedTLS](#) > [Certificate Bundle](#) > [CONFIG\\_MBEDTLS\\_CERTIFICATE\\_BUNDLE](#)

Available options:

- Use the full default certificate bundle (`CONFIG_MBEDTLS_CERTIFICATE_BUNDLE_DEFAULT_FULL`)
- Use only the most common certificates from the default bundles (`CONFIG_MBEDTLS_CERTIFICATE_BUNDLE_DEFAULT_CMN`)  
Use only the most common certificates from the default bundles, reducing the size with 50%, while still having around 99% coverage.
- Do not use the default certificate bundle (`CONFIG_MBEDTLS_CERTIFICATE_BUNDLE_DEFAULT_NONE`)

**CONFIG\_MBEDTLS\_CUSTOM\_CERTIFICATE\_BUNDLE**

Add custom certificates to the default bundle

*Found in:* [Component config](#) > [mbedTLS](#) > [Certificate Bundle](#) > [CONFIG\\_MBEDTLS\\_CERTIFICATE\\_BUNDLE](#)

**Default value:**

- No (disabled)

**CONFIG\_MBEDTLS\_CUSTOM\_CERTIFICATE\_BUNDLE\_PATH**

Custom certificate bundle path

*Found in:* [Component config](#) > [mbedTLS](#) > [Certificate Bundle](#) > [CONFIG\\_MBEDTLS\\_CERTIFICATE\\_BUNDLE](#) > [CONFIG\\_MBEDTLS\\_CUSTOM\\_CERTIFICATE\\_BUNDLE](#)

Name of the custom certificate directory or file. This path is evaluated relative to the project root directory.

### CONFIG\_MBEDTLS\_CERTIFICATE\_BUNDLE\_DEPRECATED\_LIST

Add deprecated root certificates

*Found in:* [Component config](#) > [mbedtls](#) > [Certificate Bundle](#) > [CONFIG\\_MBEDTLS\\_CERTIFICATE\\_BUNDLE](#)

Include the deprecated list of root certificates in the bundle. This list gets updated when a certificate is removed from the Mozilla's NSS root certificate store. This config can be enabled if you would like to ensure that none of the certificates that were deployed in the product are affected because of the update to bundle. In turn, enabling this config keeps expired, retracted certificates in the bundle and it may pose a security risk.

- Deprecated cert list may grow based based on sync with upstream bundle
- Deprecated certs would be removed in ESP-IDF (next) major release

### CONFIG\_MBEDTLS\_CERTIFICATE\_BUNDLE\_MAX\_CERTS

Maximum no of certificates allowed in certificate bundle

*Found in:* [Component config](#) > [mbedtls](#) > [Certificate Bundle](#) > [CONFIG\\_MBEDTLS\\_CERTIFICATE\\_BUNDLE](#)

**Default value:**

- 200

### CONFIG\_MBEDTLS\_ECP\_RESTARTABLE

Enable mbedtls ecp restartable

*Found in:* [Component config](#) > [mbedtls](#)

Enable "non-blocking" ECC operations that can return early and be resumed.

**Default value:**

- No (disabled)

### CONFIG\_MBEDTLS\_CMAC\_C

Enable CMAC mode for block ciphers

*Found in:* [Component config](#) > [mbedtls](#)

Enable the CMAC (Cipher-based Message Authentication Code) mode for block ciphers.

**Default value:**

- No (disabled)

### CONFIG\_MBEDTLS\_HARDWARE\_AES

Enable hardware AES acceleration

*Found in:* [Component config](#) > [mbedtls](#)

Enable hardware accelerated AES encryption & decryption.

Note that if the ESP32 CPU is running at 240MHz, hardware AES does not offer any speed boost over software AES.

### CONFIG\_MBEDTLS\_AES\_USE\_INTERRUPT

Use interrupt for long AES operations

*Found in:* [Component config](#) > [mbedtls](#) > [CONFIG\\_MBEDTLS\\_HARDWARE\\_AES](#)

Use an interrupt to coordinate long AES operations.

This allows other code to run on the CPU while an AES operation is pending. Otherwise the CPU busy-waits.

**Default value:**

- Yes (enabled)

### CONFIG\_MBEDTLS\_AES\_INTERRUPT\_LEVEL

AES hardware interrupt level

*Found in:* [Component config](#) > [mbedtls](#) > [CONFIG\\_MBEDTLS\\_HARDWARE\\_AES](#) > [CONFIG\\_MBEDTLS\\_AES\\_USE\\_INTERRUPT](#)

This config helps to set the interrupt priority level for the AES peripheral. Value 0 (default) means that there is no preference regarding the interrupt priority level and any level from 1 to 3 can be selected (based on the availability). Note: Higher value indicates high interrupt priority.

**Range:**

- from 0 to 3

**Default value:**

- 0

### CONFIG\_MBEDTLS\_HARDWARE\_GCM

Enable partially hardware accelerated GCM

*Found in:* [Component config](#) > [mbedtls](#) > [CONFIG\\_MBEDTLS\\_HARDWARE\\_AES](#)

Enable partially hardware accelerated GCM. GHASH calculation is still done in software.

If MBEDTLS\_HARDWARE\_GCM is disabled and MBEDTLS\_HARDWARE\_AES is enabled then mbedtls will still use the hardware accelerated AES block operation, but on a single block at a time.

**Default value:**

- Yes (enabled) if SOC\_AES\_SUPPORT\_GCM && [CONFIG\\_MBEDTLS\\_HARDWARE\\_AES](#)

### CONFIG\_MBEDTLS\_GCM\_SUPPORT\_NON\_AES\_CIPHER

Enable support for non-AES ciphers in GCM operation

*Found in:* [Component config](#) > [mbedtls](#) > [CONFIG\\_MBEDTLS\\_HARDWARE\\_AES](#)

Enable this config to support fallback to software definitions for a non-AES cipher GCM operation as we support hardware acceleration only for AES cipher. Some of the non-AES ciphers used in a GCM operation are DES, ARIA, CAMELLIA, CHACHA20, BLOWFISH.

If this config is disabled, performing a non-AES cipher GCM operation with the config MBEDTLS\_HARDWARE\_AES enabled will result in calculation of an AES-GCM operation instead for the given input values and thus could lead to failure in certificate validation which would ultimately lead to a SSL handshake failure.

This config being by-default enabled leads to an increase in binary size footprint of ~2.5KB. In case you are sure that your use case (for example, client and server configurations in case of a TLS handshake) would not involve any GCM operations using a non-AES cipher, you can safely disable this config, leading to reduction in binary size footprint.

**Default value:**

- Yes (enabled)

### CONFIG\_MBEDTLS\_HARDWARE\_MPI

Enable hardware MPI (bignum) acceleration

*Found in:* [Component config](#) > [mbedtls](#)

Enable hardware accelerated multiple precision integer operations.

Hardware accelerated multiplication, modulo multiplication, and modular exponentiation for up to SOC\_RSA\_MAX\_BIT\_LEN bit results.

These operations are used by RSA.

### CONFIG\_MBEDTLS\_LARGE\_KEY\_SOFTWARE\_MPI

Fallback to software implementation for larger MPI values

*Found in:* [Component config](#) > [mbedtls](#) > [CONFIG\\_MBEDTLS\\_HARDWARE\\_MPI](#)

Fallback to software implementation for RSA key lengths larger than SOC\_RSA\_MAX\_BIT\_LEN. If this is not active then the ESP will be unable to process keys greater than SOC\_RSA\_MAX\_BIT\_LEN.

**Default value:**

- Yes (enabled)
- No (disabled)

### CONFIG\_MBEDTLS\_MPI\_USE\_INTERRUPT

Use interrupt for MPI exp-mod operations

*Found in:* [Component config](#) > [mbedtls](#) > [CONFIG\\_MBEDTLS\\_HARDWARE\\_MPI](#)

Use an interrupt to coordinate long MPI operations.

This allows other code to run on the CPU while an MPI operation is pending. Otherwise the CPU busy-waits.

**Default value:**

- Yes (enabled)

### CONFIG\_MBEDTLS\_MPI\_INTERRUPT\_LEVEL

MPI hardware interrupt level

*Found in:* [Component config](#) > [mbedtls](#) > [CONFIG\\_MBEDTLS\\_HARDWARE\\_MPI](#) > [CONFIG\\_MBEDTLS\\_MPI\\_USE\\_INTERRUPT](#)

This config helps to set the interrupt priority level for the MPI peripheral. Value 0 (default) means that there is no preference regarding the interrupt priority level and any level from 1 to 3 can be selected (based on the availability). Note: Higher value indicates high interrupt priority.

**Range:**

- from 0 to 3

**Default value:**

- 0

### CONFIG\_MBEDTLS\_HARDWARE\_SHA

Enable hardware SHA acceleration

*Found in:* [Component config](#) > [mbedtls](#)

Enable hardware accelerated SHA1, SHA256, SHA384 & SHA512 in mbedtls.

Due to a hardware limitation, on the ESP32 hardware acceleration is only guaranteed if SHA digests are calculated one at a time. If more than one SHA digest is calculated at the same time, one will be

calculated fully in hardware and the rest will be calculated (at least partially calculated) in software. This happens automatically.

SHA hardware acceleration is faster than software in some situations but slower in others. You should benchmark to find the best setting for you.

### **CONFIG\_MBEDTLS\_HARDWARE\_ECC**

Enable hardware ECC acceleration

*Found in: [Component config](#) > [mbedtls](#)*

Enable hardware accelerated ECC point multiplication and point verification for points on curve SECP192R1 and SECP256R1 in mbedtls

**Default value:**

- Yes (enabled)

### **CONFIG\_MBEDTLS\_ECC\_OTHER\_CURVES\_SOFT\_FALLBACK**

Fallback to software implementation for curves not supported in hardware

*Found in: [Component config](#) > [mbedtls](#) > [CONFIG\\_MBEDTLS\\_HARDWARE\\_ECC](#)*

Fallback to software implementation of ECC point multiplication and point verification for curves not supported in hardware.

**Default value:**

- Yes (enabled)

### **CONFIG\_MBEDTLS\_ROM\_MD5**

Use MD5 implementation in ROM

*Found in: [Component config](#) > [mbedtls](#)*

Use ROM MD5 in mbedtls.

**Default value:**

- Yes (enabled)

### **CONFIG\_MBEDTLS\_HARDWARE\_ECDSA\_SIGN**

Enable ECDSA signing using on-chip ECDSA peripheral

*Found in: [Component config](#) > [mbedtls](#)*

Enable hardware accelerated ECDSA peripheral to sign data on curve SECP192R1 and SECP256R1 in mbedtls.

Note that for signing, the private key has to be burnt in an efuse key block with key purpose set to ECDSA\_KEY. If no key is burnt, it will report an error

The key should be burnt in little endian format. `espefuse.py` utility handles it internally but care needs to be taken while burning using `esp_efuse` APIs

**Default value:**

- No (disabled)

### CONFIG\_MBEDTLS\_HARDWARE\_ECDSA\_VERIFY

Enable ECDSA signature verification using on-chip ECDSA peripheral

*Found in: [Component config](#) > [mbedtls](#)*

Enable hardware accelerated ECDSA peripheral to verify signature on curve SECP192R1 and SECP256R1 in mbedtls.

**Default value:**

- Yes (enabled)

### CONFIG\_MBEDTLS\_ATCA\_HW\_ECDSA\_SIGN

Enable hardware ECDSA sign acceleration when using ATECC608A

*Found in: [Component config](#) > [mbedtls](#)*

This option enables hardware acceleration for ECDSA sign function, only when using ATECC608A cryptoauth chip.

**Default value:**

- No (disabled)

### CONFIG\_MBEDTLS\_ATCA\_HW\_ECDSA\_VERIFY

Enable hardware ECDSA verify acceleration when using ATECC608A

*Found in: [Component config](#) > [mbedtls](#)*

This option enables hardware acceleration for ECDSA sign function, only when using ATECC608A cryptoauth chip.

**Default value:**

- No (disabled)

### CONFIG\_MBEDTLS\_HAVE\_TIME

Enable mbedtls time support

*Found in: [Component config](#) > [mbedtls](#)*

Enable use of time.h functions (time() and gmtime()) by mbedtls.

This option doesn't require the system time to be correct, but enables functionality that requires relative timekeeping - for example periodic expiry of TLS session tickets or session cache entries.

Disabling this option will save some firmware size, particularly if the rest of the firmware doesn't call any standard timekeeping functions.

**Default value:**

- Yes (enabled)

### CONFIG\_MBEDTLS\_PLATFORM\_TIME\_ALT

Enable mbedtls time support: platform-specific

*Found in: [Component config](#) > [mbedtls](#) > [CONFIG\\_MBEDTLS\\_HAVE\\_TIME](#)*

Enabling this config will provide users with a function "mbedtls\_platform\_set\_time()" that allows to set an alternative time function pointer.

**Default value:**

- No (disabled)

### CONFIG\_MBEDTLS\_HAVE\_TIME\_DATE

Enable mbedtls certificate expiry check

*Found in: [Component config](#) > [mbedtls](#) > [CONFIG\\_MBEDTLS\\_HAVE\\_TIME](#)*

Enables X.509 certificate expiry checks in mbedtls.

If this option is disabled (default) then X.509 certificate "valid from" and "valid to" timestamp fields are ignored.

If this option is enabled, these fields are compared with the current system date and time. The time is retrieved using the standard `time()` and `gmtime()` functions. If the certificate is not valid for the current system time then verification will fail with code `MBEDTLS_X509_BADCERT_FUTURE` or `MBEDTLS_X509_BADCERT_EXPIRED`.

Enabling this option requires adding functionality in the firmware to set the system clock to a valid timestamp before using TLS. The recommended way to do this is via ESP-IDF's SNTP functionality, but any method can be used.

In the case where only a small number of certificates are trusted by the device, please carefully consider the tradeoffs of enabling this option. There may be undesired consequences, for example if all trusted certificates expire while the device is offline and a TLS connection is required to update. Or if an issue with the SNTP server means that the system time is invalid for an extended period after a reset.

**Default value:**

- No (disabled)

### CONFIG\_MBEDTLS\_ECDSA\_DETERMINISTIC

Enable deterministic ECDSA

*Found in: [Component config](#) > [mbedtls](#)*

Standard ECDSA is "fragile" in the sense that lack of entropy when signing may result in a compromise of the long-term signing key.

**Default value:**

- Yes (enabled)

### CONFIG\_MBEDTLS\_SHA512\_C

Enable the SHA-384 and SHA-512 cryptographic hash algorithms

*Found in: [Component config](#) > [mbedtls](#)*

Enable `MBEDTLS_SHA512_C` adds support for SHA-384 and SHA-512.

**Default value:**

- Yes (enabled)

### CONFIG\_MBEDTLS\_TLS\_MODE

TLS Protocol Role

*Found in: [Component config](#) > [mbedtls](#)*

mbedtls can be compiled with protocol support for the TLS server, TLS client, or both server and client.

Reducing the number of TLS roles supported saves code size.

Available options:

- Server & Client (`CONFIG_MBEDTLS_TLS_SERVER_AND_CLIENT`)

- Server (CONFIG\_MBEDTLS\_TLS\_SERVER\_ONLY)
- Client (CONFIG\_MBEDTLS\_TLS\_CLIENT\_ONLY)
- None (CONFIG\_MBEDTLS\_TLS\_DISABLED)

**TLS Key Exchange Methods** Contains:

- [CONFIG\\_MBEDTLS\\_KEY\\_EXCHANGE\\_DHE\\_RSA](#)
- [CONFIG\\_MBEDTLS\\_KEY\\_EXCHANGE\\_ECJPAKE](#)
- [CONFIG\\_MBEDTLS\\_PSK\\_MODES](#)
- [CONFIG\\_MBEDTLS\\_KEY\\_EXCHANGE\\_RSA](#)
- [CONFIG\\_MBEDTLS\\_KEY\\_EXCHANGE\\_ELLIPTIC\\_CURVE](#)

### CONFIG\_MBEDTLS\_PSK\_MODES

Enable pre-shared-key ciphersuites

*Found in:* [Component config](#) > [mbedtls](#) > [TLS Key Exchange Methods](#)

Enable to show configuration for different types of pre-shared-key TLS authentication methods.

Leaving this options disabled will save code size if they are not used.

**Default value:**

- No (disabled)

### CONFIG\_MBEDTLS\_KEY\_EXCHANGE\_PSK

Enable PSK based ciphersuite modes

*Found in:* [Component config](#) > [mbedtls](#) > [TLS Key Exchange Methods](#) > [CONFIG\\_MBEDTLS\\_PSK\\_MODES](#)

Enable to support symmetric key PSK (pre-shared-key) TLS key exchange modes.

**Default value:**

- No (disabled) if [CONFIG\\_MBEDTLS\\_PSK\\_MODES](#)

### CONFIG\_MBEDTLS\_KEY\_EXCHANGE\_DHE\_PSK

Enable DHE-PSK based ciphersuite modes

*Found in:* [Component config](#) > [mbedtls](#) > [TLS Key Exchange Methods](#) > [CONFIG\\_MBEDTLS\\_PSK\\_MODES](#)

Enable to support Diffie-Hellman PSK (pre-shared-key) TLS authentication modes.

**Default value:**

- Yes (enabled) if [CONFIG\\_MBEDTLS\\_PSK\\_MODES](#) && [CONFIG\\_MBEDTLS\\_DHM\\_C](#)

### CONFIG\_MBEDTLS\_KEY\_EXCHANGE\_ECDHE\_PSK

Enable ECDHE-PSK based ciphersuite modes

*Found in:* [Component config](#) > [mbedtls](#) > [TLS Key Exchange Methods](#) > [CONFIG\\_MBEDTLS\\_PSK\\_MODES](#)

Enable to support Elliptic-Curve-Diffie-Hellman PSK (pre-shared-key) TLS authentication modes.

**Default value:**

- Yes (enabled) if [CONFIG\\_MBEDTLS\\_PSK\\_MODES](#) && [CONFIG\\_MBEDTLS\\_ECDH\\_C](#)



### CONFIG\_MBEDTLS\_KEY\_EXCHANGE\_RSA\_PSK

Enable RSA-PSK based ciphersuite modes

*Found in:* [Component config](#) > [mbedtls](#) > [TLS Key Exchange Methods](#) > [CONFIG\\_MBEDTLS\\_PSK\\_MODES](#)

Enable to support RSA PSK (pre-shared-key) TLS authentication modes.

**Default value:**

- Yes (enabled) if [CONFIG\\_MBEDTLS\\_PSK\\_MODES](#)

### CONFIG\_MBEDTLS\_KEY\_EXCHANGE\_RSA

Enable RSA-only based ciphersuite modes

*Found in:* [Component config](#) > [mbedtls](#) > [TLS Key Exchange Methods](#)

Enable to support ciphersuites with prefix TLS-RSA-WITH-

**Default value:**

- Yes (enabled)

### CONFIG\_MBEDTLS\_KEY\_EXCHANGE\_DHE\_RSA

Enable DHE-RSA based ciphersuite modes

*Found in:* [Component config](#) > [mbedtls](#) > [TLS Key Exchange Methods](#)

Enable to support ciphersuites with prefix TLS-DHE-RSA-WITH-

**Default value:**

- Yes (enabled) if [CONFIG\\_MBEDTLS\\_DHM\\_C](#)

### CONFIG\_MBEDTLS\_KEY\_EXCHANGE\_ELLIPTIC\_CURVE

Support Elliptic Curve based ciphersuites

*Found in:* [Component config](#) > [mbedtls](#) > [TLS Key Exchange Methods](#)

Enable to show Elliptic Curve based ciphersuite mode options.

Disabling all Elliptic Curve ciphersuites saves code size and can give slightly faster TLS handshakes, provided the server supports RSA-only ciphersuite modes.

**Default value:**

- Yes (enabled)

### CONFIG\_MBEDTLS\_KEY\_EXCHANGE\_ECDHE\_RSA

Enable ECDHE-RSA based ciphersuite modes

*Found in:* [Component config](#) > [mbedtls](#) > [TLS Key Exchange Methods](#) > [CONFIG\\_MBEDTLS\\_KEY\\_EXCHANGE\\_ELLIPTIC\\_CURVE](#)

Enable to support ciphersuites with prefix TLS-ECDHE-RSA-WITH-

**Default value:**

- Yes (enabled)

### CONFIG\_MBEDTLS\_KEY\_EXCHANGE\_ECDHE\_ECDSA

Enable ECDHE-ECDSA based ciphersuite modes

*Found in:* [Component config > mbedTLS > TLS Key Exchange Methods > CONFIG\\_MBEDTLS\\_KEY\\_EXCHANGE\\_ELLIPTIC\\_CURVE](#)

Enable to support ciphersuites with prefix TLS-ECDHE-RSA-WITH-

**Default value:**

- Yes (enabled)

### CONFIG\_MBEDTLS\_KEY\_EXCHANGE\_ECDH\_ECDSA

Enable ECDH-ECDSA based ciphersuite modes

*Found in:* [Component config > mbedTLS > TLS Key Exchange Methods > CONFIG\\_MBEDTLS\\_KEY\\_EXCHANGE\\_ELLIPTIC\\_CURVE](#)

Enable to support ciphersuites with prefix TLS-ECDHE-RSA-WITH-

**Default value:**

- Yes (enabled)

### CONFIG\_MBEDTLS\_KEY\_EXCHANGE\_ECDH\_RSA

Enable ECDH-RSA based ciphersuite modes

*Found in:* [Component config > mbedTLS > TLS Key Exchange Methods > CONFIG\\_MBEDTLS\\_KEY\\_EXCHANGE\\_ELLIPTIC\\_CURVE](#)

Enable to support ciphersuites with prefix TLS-ECDHE-RSA-WITH-

**Default value:**

- Yes (enabled)

### CONFIG\_MBEDTLS\_KEY\_EXCHANGE\_ECJPAKE

Enable ECJPAKE based ciphersuite modes

*Found in:* [Component config > mbedTLS > TLS Key Exchange Methods](#)

Enable to support ciphersuites with prefix TLS-ECJPAKE-WITH-

**Default value:**

- No (disabled) if [CONFIG\\_MBEDTLS\\_ECJPAKE\\_C](#) && [CONFIG\\_MBEDTLS\\_ECP\\_DP\\_SECP256R1\\_ENABLED](#)

### CONFIG\_MBEDTLS\_SSL\_RENEGOTIATION

Support TLS renegotiation

*Found in:* [Component config > mbedTLS](#)

The two main uses of renegotiation are (1) refresh keys on long-lived connections and (2) client authentication after the initial handshake. If you don't need renegotiation, disabling it will save code size and reduce the possibility of abuse/vulnerability.

**Default value:**

- Yes (enabled)

### CONFIG\_MBEDTLS\_SSL\_PROTO\_TLS1\_2

Support TLS 1.2 protocol

*Found in: [Component config](#) > [mbedtls](#)*

**Default value:**

- Yes (enabled)

### CONFIG\_MBEDTLS\_SSL\_PROTO\_GMTSSL1\_1

Support GM/T SSL 1.1 protocol

*Found in: [Component config](#) > [mbedtls](#)*

Provisions for GM/T SSL 1.1 support

**Default value:**

- No (disabled)

### CONFIG\_MBEDTLS\_SSL\_PROTO\_DTLS

Support DTLS protocol (all versions)

*Found in: [Component config](#) > [mbedtls](#)*

Requires TLS 1.2 to be enabled for DTLS 1.2

**Default value:**

- No (disabled)

### CONFIG\_MBEDTLS\_SSL\_ALPN

Support ALPN (Application Layer Protocol Negotiation)

*Found in: [Component config](#) > [mbedtls](#)*

Disabling this option will save some code size if it is not needed.

**Default value:**

- Yes (enabled)

### CONFIG\_MBEDTLS\_CLIENT\_SSL\_SESSION\_TICKETS

TLS: Client Support for RFC 5077 SSL session tickets

*Found in: [Component config](#) > [mbedtls](#)*

Client support for RFC 5077 session tickets. See mbedtls documentation for more details. Disabling this option will save some code size.

**Default value:**

- Yes (enabled)

### CONFIG\_MBEDTLS\_SERVER\_SSL\_SESSION\_TICKETS

TLS: Server Support for RFC 5077 SSL session tickets

*Found in: [Component config](#) > [mbedtls](#)*

Server support for RFC 5077 session tickets. See mbedtls documentation for more details. Disabling this option will save some code size.

**Default value:**

- Yes (enabled)

**Symmetric Ciphers** Contains:

- [CONFIG\\_MBEDTLS\\_AES\\_C](#)
- [CONFIG\\_MBEDTLS\\_BLOWFISH\\_C](#)
- [CONFIG\\_MBEDTLS\\_CAMELLIA\\_C](#)
- [CONFIG\\_MBEDTLS\\_CCM\\_C](#)
- [CONFIG\\_MBEDTLS\\_DES\\_C](#)
- [CONFIG\\_MBEDTLS\\_GCM\\_C](#)
- [CONFIG\\_MBEDTLS\\_NIST\\_KW\\_C](#)
- [CONFIG\\_MBEDTLS\\_XTEA\\_C](#)

**CONFIG\_MBEDTLS\_AES\_C**

AES block cipher

*Found in: [Component config](#) > [mbedtls](#) > [Symmetric Ciphers](#)*

**Default value:**

- Yes (enabled)

**CONFIG\_MBEDTLS\_CAMELLIA\_C**

Camellia block cipher

*Found in: [Component config](#) > [mbedtls](#) > [Symmetric Ciphers](#)*

**Default value:**

- No (disabled)

**CONFIG\_MBEDTLS\_DES\_C**

DES block cipher (legacy, insecure)

*Found in: [Component config](#) > [mbedtls](#) > [Symmetric Ciphers](#)*

Enables the DES block cipher to support 3DES-based TLS ciphersuites.

3DES is vulnerable to the Sweet32 attack and should only be enabled if absolutely necessary.

**Default value:**

- No (disabled)

**CONFIG\_MBEDTLS\_BLOWFISH\_C**

Blowfish block cipher (read help)

*Found in: [Component config](#) > [mbedtls](#) > [Symmetric Ciphers](#)*

Enables the Blowfish block cipher (not used for TLS sessions.)

The Blowfish cipher is not used for mbedtls TLS sessions but can be used for other purposes. Read up on the limitations of Blowfish (including Sweet32) before enabling.

**Default value:**

- No (disabled)

**CONFIG\_MBEDTLS\_XTEA\_C**

XTEA block cipher

*Found in: [Component config](#) > [mbedtls](#) > [Symmetric Ciphers](#)*

Enables the XTEA block cipher.

**Default value:**

- No (disabled)

### CONFIG\_MBEDTLS\_CCM\_C

CCM (Counter with CBC-MAC) block cipher modes

*Found in: [Component config](#) > [mbedtls](#) > [Symmetric Ciphers](#)*

Enable Counter with CBC-MAC (CCM) modes for AES and/or Camellia ciphers.

Disabling this option saves some code size.

**Default value:**

- Yes (enabled)

### CONFIG\_MBEDTLS\_GCM\_C

GCM (Galois/Counter) block cipher modes

*Found in: [Component config](#) > [mbedtls](#) > [Symmetric Ciphers](#)*

Enable Galois/Counter Mode for AES and/or Camellia ciphers.

This option is generally faster than CCM.

**Default value:**

- Yes (enabled)

### CONFIG\_MBEDTLS\_NIST\_KW\_C

NIST key wrapping (KW) and KW padding (KWP)

*Found in: [Component config](#) > [mbedtls](#) > [Symmetric Ciphers](#)*

Enable NIST key wrapping and key wrapping padding.

**Default value:**

- No (disabled)

### CONFIG\_MBEDTLS\_RIPEMD160\_C

Enable RIPEMD-160 hash algorithm

*Found in: [Component config](#) > [mbedtls](#)*

Enable the RIPEMD-160 hash algorithm.

**Default value:**

- No (disabled)

**Certificates** Contains:

- [CONFIG\\_MBEDTLS\\_PEM\\_PARSE\\_C](#)
- [CONFIG\\_MBEDTLS\\_PEM\\_WRITE\\_C](#)
- [CONFIG\\_MBEDTLS\\_X509\\_CRL\\_PARSE\\_C](#)
- [CONFIG\\_MBEDTLS\\_X509\\_CSR\\_PARSE\\_C](#)

### CONFIG\_MBEDTLS\_PEM\_PARSE\_C

Read & Parse PEM formatted certificates

*Found in: [Component config](#) > [mbedtls](#) > [Certificates](#)*

Enable decoding/parsing of PEM formatted certificates.

If your certificates are all in the simpler DER format, disabling this option will save some code size.

**Default value:**

- Yes (enabled)

### **CONFIG\_MBEDTLS\_PEM\_WRITE\_C**

Write PEM formatted certificates

*Found in: [Component config](#) > [mbedtls](#) > [Certificates](#)*

Enable writing of PEM formatted certificates.

If writing certificate data only in DER format, disabling this option will save some code size.

**Default value:**

- Yes (enabled)

### **CONFIG\_MBEDTLS\_X509\_CRL\_PARSE\_C**

X.509 CRL parsing

*Found in: [Component config](#) > [mbedtls](#) > [Certificates](#)*

Support for parsing X.509 Certificate Revocation Lists.

**Default value:**

- Yes (enabled)

### **CONFIG\_MBEDTLS\_X509\_CSR\_PARSE\_C**

X.509 CSR parsing

*Found in: [Component config](#) > [mbedtls](#) > [Certificates](#)*

Support for parsing X.509 Certificate Signing Requests

**Default value:**

- Yes (enabled)

### **CONFIG\_MBEDTLS\_ECP\_C**

Elliptic Curve Ciphers

*Found in: [Component config](#) > [mbedtls](#)*

**Default value:**

- Yes (enabled)

### **CONFIG\_MBEDTLS\_DHM\_C**

Diffie-Hellman-Merkle key exchange (DHM)

*Found in: [Component config](#) > [mbedtls](#)*

Enable DHM. Needed to use DHE-xxx TLS ciphersuites.

Note that the security of Diffie-Hellman key exchanges depends on a suitable prime being used for the exchange. Please see detailed warning text about this in file *mbedtls/dhm.h* file.

**Default value:**

- No (disabled)

### CONFIG\_MBEDTLS\_ECDH\_C

Elliptic Curve Diffie-Hellman (ECDH)

*Found in:* [Component config > mbedTLS](#)

Enable ECDH. Needed to use ECDHE-xxx TLS ciphersuites.

**Default value:**

- Yes (enabled)

### CONFIG\_MBEDTLS\_ECDSA\_C

Elliptic Curve DSA

*Found in:* [Component config > mbedTLS > CONFIG\\_MBEDTLS\\_ECDH\\_C](#)

Enable ECDSA. Needed to use ECDSA-xxx TLS ciphersuites.

**Default value:**

- Yes (enabled)

### CONFIG\_MBEDTLS\_ECJPAKE\_C

Elliptic curve J-PAKE

*Found in:* [Component config > mbedTLS](#)

Enable ECJPAKE. Needed to use ECJPAKE-xxx TLS ciphersuites.

**Default value:**

- No (disabled)

### CONFIG\_MBEDTLS\_ECP\_DP\_SECP192R1\_ENABLED

Enable SECP192R1 curve

*Found in:* [Component config > mbedTLS](#)

Enable support for SECP192R1 Elliptic Curve.

### CONFIG\_MBEDTLS\_ECP\_DP\_SECP224R1\_ENABLED

Enable SECP224R1 curve

*Found in:* [Component config > mbedTLS](#)

Enable support for SECP224R1 Elliptic Curve.

### CONFIG\_MBEDTLS\_ECP\_DP\_SECP256R1\_ENABLED

Enable SECP256R1 curve

*Found in:* [Component config > mbedTLS](#)

Enable support for SECP256R1 Elliptic Curve.

**Default value:**

- Yes (enabled)

### **CONFIG\_MBEDTLS\_ECP\_DP\_SECP384R1\_ENABLED**

Enable SECP384R1 curve

*Found in: [Component config](#) > [mbedtls](#)*

Enable support for SECP384R1 Elliptic Curve.

### **CONFIG\_MBEDTLS\_ECP\_DP\_SECP521R1\_ENABLED**

Enable SECP521R1 curve

*Found in: [Component config](#) > [mbedtls](#)*

Enable support for SECP521R1 Elliptic Curve.

### **CONFIG\_MBEDTLS\_ECP\_DP\_SECP192K1\_ENABLED**

Enable SECP192K1 curve

*Found in: [Component config](#) > [mbedtls](#)*

Enable support for SECP192K1 Elliptic Curve.

### **CONFIG\_MBEDTLS\_ECP\_DP\_SECP224K1\_ENABLED**

Enable SECP224K1 curve

*Found in: [Component config](#) > [mbedtls](#)*

Enable support for SECP224K1 Elliptic Curve.

### **CONFIG\_MBEDTLS\_ECP\_DP\_SECP256K1\_ENABLED**

Enable SECP256K1 curve

*Found in: [Component config](#) > [mbedtls](#)*

Enable support for SECP256K1 Elliptic Curve.

### **CONFIG\_MBEDTLS\_ECP\_DP\_BP256R1\_ENABLED**

Enable BP256R1 curve

*Found in: [Component config](#) > [mbedtls](#)*

support for DP Elliptic Curve.

### **CONFIG\_MBEDTLS\_ECP\_DP\_BP384R1\_ENABLED**

Enable BP384R1 curve

*Found in: [Component config](#) > [mbedtls](#)*

support for DP Elliptic Curve.

### **CONFIG\_MBEDTLS\_ECP\_DP\_BP512R1\_ENABLED**

Enable BP512R1 curve

*Found in: [Component config](#) > [mbedtls](#)*

support for DP Elliptic Curve.



### CONFIG\_MBEDTLS\_ECP\_DP\_CURVE25519\_ENABLED

Enable CURVE25519 curve

*Found in: [Component config](#) > [mbedtls](#)*

Enable support for CURVE25519 Elliptic Curve.

### CONFIG\_MBEDTLS\_ECP\_NIST\_OPTIM

NIST 'modulo p' optimisations

*Found in: [Component config](#) > [mbedtls](#)*

NIST 'modulo p' optimisations increase Elliptic Curve operation performance.

Disabling this option saves some code size.

**Default value:**

- Yes (enabled)

### CONFIG\_MBEDTLS\_ECP\_FIXED\_POINT\_OPTIM

Enable fixed-point multiplication optimisations

*Found in: [Component config](#) > [mbedtls](#)*

This configuration option enables optimizations to speedup (about 3 ~ 4 times) the ECP fixed point multiplication using pre-computed tables in the flash memory. Disabling this configuration option saves flash footprint (about 29KB if all Elliptic Curve selected) in the application binary.

# end of Elliptic Curve options

**Default value:**

- Yes (enabled)

### CONFIG\_MBEDTLS\_POLY1305\_C

Poly1305 MAC algorithm

*Found in: [Component config](#) > [mbedtls](#)*

Enable support for Poly1305 MAC algorithm.

**Default value:**

- No (disabled)

### CONFIG\_MBEDTLS\_CHACHA20\_C

Chacha20 stream cipher

*Found in: [Component config](#) > [mbedtls](#)*

Enable support for Chacha20 stream cipher.

**Default value:**

- No (disabled)

### CONFIG\_MBEDTLS\_CHACHAPOLY\_C

ChaCha20-Poly1305 AEAD algorithm

*Found in: [Component config](#) > [mbedtls](#) > [CONFIG\\_MBEDTLS\\_CHACHA20\\_C](#)*

Enable support for ChaCha20-Poly1305 AEAD algorithm.

**Default value:**

- No (disabled) if `CONFIG_MBEDTLS_CHACHA20_C` && `CONFIG_MBEDTLS_POLY1305_C`

### CONFIG\_MBEDTLS\_HKDF\_C

HKDF algorithm (RFC 5869)

*Found in:* [Component config > mbedTLS](#)

Enable support for the Hashed Message Authentication Code (HMAC)-based key derivation function (HKDF).

**Default value:**

- No (disabled)

### CONFIG\_MBEDTLS\_THREADING\_C

Enable the threading abstraction layer

*Found in:* [Component config > mbedTLS](#)

If you do intend to use contexts between threads, you will need to enable this layer to prevent race conditions.

**Default value:**

- No (disabled)

### CONFIG\_MBEDTLS\_THREADING\_ALT

Enable threading alternate implementation

*Found in:* [Component config > mbedTLS > CONFIG\\_MBEDTLS\\_THREADING\\_C](#)

Enable threading alt to allow your own alternate threading implementation.

**Default value:**

- Yes (enabled) if `CONFIG_MBEDTLS_THREADING_C`

### CONFIG\_MBEDTLS\_THREADING\_PTHREAD

Enable threading pthread implementation

*Found in:* [Component config > mbedTLS > CONFIG\\_MBEDTLS\\_THREADING\\_C](#)

Enable the pthread wrapper layer for the threading layer.

**Default value:**

- No (disabled) if `CONFIG_MBEDTLS_THREADING_C`

### CONFIG\_MBEDTLS\_ERROR\_STRINGS

Enable error code to error string conversion

*Found in:* [Component config > mbedTLS](#)

Enables `mbedtls_strerror()` for converting error codes to error strings. Disabling this config can save some code/rodata size as the error string conversion implementation is replaced with an empty stub.

**Default value:**

- Yes (enabled)

## CONFIG\_MBEDTLS\_USE\_CRYPTO\_ROM\_IMPL

Use ROM implementation of the crypto algorithm

*Found in: Component config > mbedTLS*

Enable this flag to use mbedtls crypto algorithm from ROM instead of ESP-IDF.

This configuration option saves flash footprint in the application binary. Note that the version of mbedtls crypto algorithm library in ROM is v2.16.12. We have done the security analysis of the mbedtls revision in ROM (v2.16.12) and ensured that affected symbols have been patched (removed). If in the future mbedtls revisions there are security issues that also affects the version in ROM (v2.16.12) then we shall patch the relevant symbols. This would increase the flash footprint and hence care must be taken to keep some reserved space for the application binary in flash layout.

### Default value:

- No (disabled) if `ESP_ROM_HAS_MBEDTLS_CRYPTO_LIB` && `CONFIG_IDF_EXPERIMENTAL_FEATURES`

## ESP-MQTT Configurations Contains:

- `CONFIG_MQTT_CUSTOM_OUTBOX`
- `CONFIG_MQTT_TRANSPORT_SSL`
- `CONFIG_MQTT_TRANSPORT_WEBSOCKET`
- `CONFIG_MQTT_PROTOCOL_311`
- `CONFIG_MQTT_PROTOCOL_5`
- `CONFIG_MQTT_TASK_CORE_SELECTION_ENABLED`
- `CONFIG_MQTT_USE_CUSTOM_CONFIG`
- `CONFIG_MQTT_OUTBOX_EXPIRED_TIMEOUT_MS`
- `CONFIG_MQTT_REPORT_DELETED_MESSAGES`
- `CONFIG_MQTT_SKIP_PUBLISH_IF_DISCONNECTED`
- `CONFIG_MQTT_OUTBOX_DATA_ON_EXTERNAL_MEMORY`
- `CONFIG_MQTT_MSG_ID_INCREMENTAL`

## CONFIG\_MQTT\_PROTOCOL\_311

Enable MQTT protocol 3.1.1

*Found in: Component config > ESP-MQTT Configurations*

If not, this library will use MQTT protocol 3.1

### Default value:

- Yes (enabled)

## CONFIG\_MQTT\_PROTOCOL\_5

Enable MQTT protocol 5.0

*Found in: Component config > ESP-MQTT Configurations*

If not, this library will not support MQTT 5.0

### Default value:

- No (disabled)

## CONFIG\_MQTT\_TRANSPORT\_SSL

Enable MQTT over SSL

*Found in: Component config > ESP-MQTT Configurations*

Enable MQTT transport over SSL with mbedtls

**Default value:**

- Yes (enabled)

**CONFIG\_MQTT\_TRANSPORT\_WEBSOCKET**

Enable MQTT over Websocket

*Found in: [Component config](#) > [ESP-MQTT Configurations](#)*

Enable MQTT transport over Websocket.

**Default value:**

- Yes (enabled)

**CONFIG\_MQTT\_TRANSPORT\_WEBSOCKET\_SECURE**

Enable MQTT over Websocket Secure

*Found in: [Component config](#) > [ESP-MQTT Configurations](#) > [CONFIG\\_MQTT\\_TRANSPORT\\_WEBSOCKET\\_SECURE](#)*

Enable MQTT transport over Websocket Secure.

**Default value:**

- Yes (enabled)

**CONFIG\_MQTT\_MSG\_ID\_INCREMENTAL**

Use Incremental Message Id

*Found in: [Component config](#) > [ESP-MQTT Configurations](#)*

Set this to true for the message id (2.3.1 Packet Identifier) to be generated as an incremental number rather than a random value (used by default)

**Default value:**

- No (disabled)

**CONFIG\_MQTT\_SKIP\_PUBLISH\_IF\_DISCONNECTED**

Skip publish if disconnected

*Found in: [Component config](#) > [ESP-MQTT Configurations](#)*

Set this to true to avoid publishing (enqueueing messages) if the client is disconnected. The MQTT client tries to publish all messages by default, even in the disconnected state (where the qos1 and qos2 packets are stored in the internal outbox to be published later) The MQTT\_SKIP\_PUBLISH\_IF\_DISCONNECTED option allows applications to override this behaviour and not enqueue publish packets in the disconnected state.

**Default value:**

- No (disabled)

**CONFIG\_MQTT\_REPORT\_DELETED\_MESSAGES**

Report deleted messages

*Found in: [Component config](#) > [ESP-MQTT Configurations](#)*

Set this to true to post events for all messages which were deleted from the outbox before being correctly sent and confirmed.

**Default value:**

- No (disabled)

### CONFIG\_MQTT\_USE\_CUSTOM\_CONFIG

MQTT Using custom configurations

*Found in: [Component config](#) > [ESP-MQTT Configurations](#)*

Custom MQTT configurations.

**Default value:**

- No (disabled)

### CONFIG\_MQTT\_TCP\_DEFAULT\_PORT

Default MQTT over TCP port

*Found in: [Component config](#) > [ESP-MQTT Configurations](#) > [CONFIG\\_MQTT\\_USE\\_CUSTOM\\_CONFIG](#)*

Default MQTT over TCP port

**Default value:**

- 1883 if [CONFIG\\_MQTT\\_USE\\_CUSTOM\\_CONFIG](#)

### CONFIG\_MQTT\_SSL\_DEFAULT\_PORT

Default MQTT over SSL port

*Found in: [Component config](#) > [ESP-MQTT Configurations](#) > [CONFIG\\_MQTT\\_USE\\_CUSTOM\\_CONFIG](#)*

Default MQTT over SSL port

**Default value:**

- 8883 if [CONFIG\\_MQTT\\_USE\\_CUSTOM\\_CONFIG](#) && [CONFIG\\_MQTT\\_TRANSPORT\\_SSL](#)

### CONFIG\_MQTT\_WS\_DEFAULT\_PORT

Default MQTT over Websocket port

*Found in: [Component config](#) > [ESP-MQTT Configurations](#) > [CONFIG\\_MQTT\\_USE\\_CUSTOM\\_CONFIG](#)*

Default MQTT over Websocket port

**Default value:**

- 80 if [CONFIG\\_MQTT\\_USE\\_CUSTOM\\_CONFIG](#) && [CONFIG\\_MQTT\\_TRANSPORT\\_WEBSOCKET](#)

### CONFIG\_MQTT\_WSS\_DEFAULT\_PORT

Default MQTT over Websocket Secure port

*Found in: [Component config](#) > [ESP-MQTT Configurations](#) > [CONFIG\\_MQTT\\_USE\\_CUSTOM\\_CONFIG](#)*

Default MQTT over Websocket Secure port

**Default value:**

- 443 if [CONFIG\\_MQTT\\_USE\\_CUSTOM\\_CONFIG](#) && [CONFIG\\_MQTT\\_TRANSPORT\\_WEBSOCKET](#) && [CONFIG\\_MQTT\\_TRANSPORT\\_WEBSOCKET\\_SECURE](#)

### CONFIG\_MQTT\_BUFFER\_SIZE

Default MQTT Buffer Size

*Found in: [Component config](#) > [ESP-MQTT Configurations](#) > [CONFIG\\_MQTT\\_USE\\_CUSTOM\\_CONFIG](#)*

This buffer size using for both transmit and receive

**Default value:**

- 1024 if [CONFIG\\_MQTT\\_USE\\_CUSTOM\\_CONFIG](#)

### CONFIG\_MQTT\_TASK\_STACK\_SIZE

MQTT task stack size

*Found in: Component config > ESP-MQTT Configurations > CONFIG\_MQTT\_USE\_CUSTOM\_CONFIG*

MQTT task stack size

**Default value:**

- 6144 if *CONFIG\_MQTT\_USE\_CUSTOM\_CONFIG*

### CONFIG\_MQTT\_DISABLE\_API\_LOCKS

Disable API locks

*Found in: Component config > ESP-MQTT Configurations > CONFIG\_MQTT\_USE\_CUSTOM\_CONFIG*

Default config employs API locks to protect internal structures. It is possible to disable these locks if the user code doesn't access MQTT API from multiple concurrent tasks

**Default value:**

- No (disabled) if *CONFIG\_MQTT\_USE\_CUSTOM\_CONFIG*

### CONFIG\_MQTT\_TASK\_PRIORITY

MQTT task priority

*Found in: Component config > ESP-MQTT Configurations > CONFIG\_MQTT\_USE\_CUSTOM\_CONFIG*

MQTT task priority. Higher number denotes higher priority.

**Default value:**

- 5 if *CONFIG\_MQTT\_USE\_CUSTOM\_CONFIG*

### CONFIG\_MQTT\_POLL\_READ\_TIMEOUT\_MS

MQTT transport poll read timeout

*Found in: Component config > ESP-MQTT Configurations > CONFIG\_MQTT\_USE\_CUSTOM\_CONFIG*

Timeout when polling underlying transport for read.

**Default value:**

- 1000 if *CONFIG\_MQTT\_USE\_CUSTOM\_CONFIG*

### CONFIG\_MQTT\_EVENT\_QUEUE\_SIZE

Number of queued events.

*Found in: Component config > ESP-MQTT Configurations > CONFIG\_MQTT\_USE\_CUSTOM\_CONFIG*

A value higher than 1 enables multiple queued events.

**Default value:**

- 1 if *CONFIG\_MQTT\_USE\_CUSTOM\_CONFIG*

### CONFIG\_MQTT\_TASK\_CORE\_SELECTION\_ENABLED

Enable MQTT task core selection

*Found in: Component config > ESP-MQTT Configurations*

This will enable core selection

## CONFIG\_MQTT\_TASK\_CORE\_SELECTION

Core to use ?

*Found in:* *Component config* > *ESP-MQTT Configurations* > *CONFIG\_MQTT\_TASK\_CORE\_SELECTION\_ENABLED*

Available options:

- Core 0 (CONFIG\_MQTT\_USE\_CORE\_0)
- Core 1 (CONFIG\_MQTT\_USE\_CORE\_1)

## CONFIG\_MQTT\_OUTBOX\_DATA\_ON\_EXTERNAL\_MEMORY

Use external memory for outbox data

*Found in:* *Component config* > *ESP-MQTT Configurations*

Set to true to use external memory for outbox data.

**Default value:**

- No (disabled) if *CONFIG\_MQTT\_USE\_CUSTOM\_CONFIG*

## CONFIG\_MQTT\_CUSTOM\_OUTBOX

Enable custom outbox implementation

*Found in:* *Component config* > *ESP-MQTT Configurations*

Set to true if a specific implementation of message outbox is needed (e.g. persistent outbox in NVM or similar). Note: Implementation of the custom outbox must be added to the mqtt component. These CMake commands could be used to append the custom implementation to lib-mqtt sources: `idf_component_get_property(mqtt mqtt COMPONENT_LIB) set_property(TARGET ${mqtt} PROPERTY SOURCES ${PROJECT_DIR}/custom_outbox.c APPEND)`

**Default value:**

- No (disabled)

## CONFIG\_MQTT\_OUTBOX\_EXPIRED\_TIMEOUT\_MS

Outbox message expired timeout[ms]

*Found in:* *Component config* > *ESP-MQTT Configurations*

Messages which stays in the outbox longer than this value before being published will be discarded.

**Default value:**

- 30000 if *CONFIG\_MQTT\_USE\_CUSTOM\_CONFIG*

**Newlib** Contains:

- *CONFIG\_NEWLIB\_NANO\_FORMAT*
- *CONFIG\_NEWLIB\_STDIN\_LINE\_ENDING*
- *CONFIG\_NEWLIB\_STDOUT\_LINE\_ENDING*
- *CONFIG\_NEWLIB\_TIME\_SYSCALL*

## CONFIG\_NEWLIB\_STDOUT\_LINE\_ENDING

Line ending for UART output

*Found in:* *Component config* > *Newlib*

This option allows configuring the desired line endings sent to UART when a newline ('n', LF) appears on stdout. Three options are possible:

CRLF: whenever LF is encountered, prepend it with CR

LF: no modification is applied, stdout is sent as is

CR: each occurrence of LF is replaced with CR

This option doesn't affect behavior of the UART driver (drivers/uart.h).

Available options:

- CRLF (CONFIG\_NEWLIB\_STDOUT\_LINE\_ENDING\_CRLF)
- LF (CONFIG\_NEWLIB\_STDOUT\_LINE\_ENDING\_LF)
- CR (CONFIG\_NEWLIB\_STDOUT\_LINE\_ENDING\_CR)

### CONFIG\_NEWLIB\_STDIN\_LINE\_ENDING

Line ending for UART input

*Found in: [Component config](#) > [Newlib](#)*

This option allows configuring which input sequence on UART produces a newline ('n', LF) on stdin. Three options are possible:

CRLF: CRLF is converted to LF

LF: no modification is applied, input is sent to stdin as is

CR: each occurrence of CR is replaced with LF

This option doesn't affect behavior of the UART driver (drivers/uart.h).

Available options:

- CRLF (CONFIG\_NEWLIB\_STDIN\_LINE\_ENDING\_CRLF)
- LF (CONFIG\_NEWLIB\_STDIN\_LINE\_ENDING\_LF)
- CR (CONFIG\_NEWLIB\_STDIN\_LINE\_ENDING\_CR)

### CONFIG\_NEWLIB\_NANO\_FORMAT

Enable 'nano' formatting options for printf/scanf family

*Found in: [Component config](#) > [Newlib](#)*

In most chips the ROM contains parts of newlib C library, including printf/scanf family of functions. These functions have been compiled with so-called "nano" formatting option. This option doesn't support 64-bit integer formats and C99 features, such as positional arguments.

For more details about "nano" formatting option, please see newlib readme file, search for '--enable-newlib-nano-formatted-io': [https://sourceware.org/git/?p=newlib-cygwin.git;a=blob\\_plain;f=newlib/README;hb=HEAD](https://sourceware.org/git/?p=newlib-cygwin.git;a=blob_plain;f=newlib/README;hb=HEAD)

If this option is enabled and the ROM contains functions from newlib-nano, the build system will use functions available in ROM, reducing the application binary size. Functions available in ROM run faster than functions which run from flash. Functions available in ROM can also run when flash instruction cache is disabled.

Some chips (e.g. ESP32-C6) has the full formatting versions of printf/scanf in ROM instead of the nano versions and in this building with newlib nano might actually increase the size of the binary. Which functions are present in ROM can be seen from ROM caps: ESP\_ROM\_HAS\_NEWLIB\_NANO\_FORMAT and ESP\_ROM\_HAS\_NEWLIB\_NORMAL\_FORMAT.



If you need 64-bit integer formatting support or C99 features, keep this option disabled.

### CONFIG\_NEWLIB\_TIME\_SYSCALL

Timers used for gettimeofday function

Found in: [Component config](#) > [Newlib](#)

This setting defines which hardware timers are used to implement 'gettimeofday' and 'time' functions in C library.

- **If both high-resolution (systimer for all targets except ESP32) and RTC timers are used,** timekeeping will continue in deep sleep. Time will be reported at 1 microsecond resolution. This is the default, and the recommended option.
- **If only high-resolution timer (systimer) is used, gettimeofday will** provide time at microsecond resolution. Time will not be preserved when going into deep sleep mode.
- **If only RTC timer is used, timekeeping will continue in** deep sleep, but time will be measured at 6.(6) microsecond resolution. Also the gettimeofday function itself may take longer to run.
- **If no timers are used, gettimeofday and time functions** return -1 and set errno to ENOSYS; they are defined as weak, so they could be overridden. If you want to customize gettimeofday() and other time functions, please choose this option and refer to the 'time.c' source file for the exact prototypes of these functions.
- **When RTC is used for timekeeping, two RTC\_STORE registers are** used to keep time in deep sleep mode.

Available options:

- RTC and high-resolution timer (CONFIG\_NEWLIB\_TIME\_SYSCALL\_USE\_RTC\_HRT)
- RTC (CONFIG\_NEWLIB\_TIME\_SYSCALL\_USE\_RTC)
- High-resolution timer (CONFIG\_NEWLIB\_TIME\_SYSCALL\_USE\_HRT)
- None (CONFIG\_NEWLIB\_TIME\_SYSCALL\_USE\_NONE)

**NVS** Contains:

- [CONFIG\\_NVS\\_LEGACY\\_DUP\\_KEYS\\_COMPATIBILITY](#)
- [CONFIG\\_NVS\\_ENCRYPTION](#)
- [CONFIG\\_NVS\\_COMPATIBLE\\_PRE\\_V4\\_3\\_ENCRYPTION\\_FLAG](#)
- [CONFIG\\_NVS\\_ASSERT\\_ERROR\\_CHECK](#)

### CONFIG\_NVS\_ENCRYPTION

Enable NVS encryption

Found in: [Component config](#) > [NVS](#)

This option enables encryption for NVS. When enabled, XTS-AES is used to encrypt the complete NVS data, except the page headers. It requires XTS encryption keys to be stored in an encrypted partition (enabling flash encryption is mandatory here) or to be derived from an HMAC key burnt in eFuse.

**Default value:**

- Yes (enabled) if [CONFIG\\_SECURE\\_FLASH\\_ENC\\_ENABLED](#)

### CONFIG\_NVS\_COMPATIBLE\_PRE\_V4\_3\_ENCRYPTION\_FLAG

NVS partition encrypted flag compatible with ESP-IDF before v4.3

Found in: [Component config](#) > [NVS](#)

Enabling this will ignore "encrypted" flag for NVS partitions. NVS encryption scheme is different than hardware flash encryption and hence it is not recommended to have "encrypted" flag for NVS partitions.

This was not being checked in pre v4.3 IDF. Hence, if you have any devices where this flag is kept enabled in partition table then enabling this config will allow to have same behavior as pre v4.3 IDF.

### **CONFIG\_NVS\_ASSERT\_ERROR\_CHECK**

Use assertions for error checking

*Found in: [Component config](#) > [NVS](#)*

This option switches error checking type between assertions (y) or return codes (n).

#### **Default value:**

- No (disabled)

### **CONFIG\_NVS\_LEGACY\_DUP\_KEYS\_COMPATIBILITY**

Enable legacy nvs\_set function behavior when same key is reused with different data types

*Found in: [Component config](#) > [NVS](#)*

Enabling this option will switch the nvs\_set() family of functions to the legacy mode: when called repeatedly with the same key but different data type, the existing value in the NVS remains active and the new value is just stored, actually not accessible through corresponding nvs\_get() call for the key given. Use this option only when your application relies on such NVS API behaviour.

#### **Default value:**

- No (disabled)

### **NVS Security Provider** Contains:

- [CONFIG\\_NVS\\_SEC\\_HMAC\\_EFUSE\\_KEY\\_ID](#)
- [CONFIG\\_NVS\\_SEC\\_KEY\\_PROTECTION\\_SCHEME](#)

### **CONFIG\_NVS\_SEC\_KEY\_PROTECTION\_SCHEME**

NVS Encryption: Key Protection Scheme

*Found in: [Component config](#) > [NVS Security Provider](#)*

This choice defines the default NVS encryption keys protection scheme; which will be used for the default NVS partition. Users can use the corresponding scheme registration APIs to register other schemes for the default as well as other NVS partitions.

Available options:

- Using Flash Encryption ([CONFIG\\_NVS\\_SEC\\_KEY\\_PROTECT\\_USING\\_FLASH\\_ENC](#))  
Protect the NVS Encryption Keys using Flash Encryption Requires a separate 'nvs\_keys' partition (which will be encrypted by flash encryption) for storing the NVS encryption keys
- Using HMAC peripheral ([CONFIG\\_NVS\\_SEC\\_KEY\\_PROTECT\\_USING\\_HMAC](#))  
Derive and protect the NVS Encryption Keys using the HMAC peripheral Requires the specified eFuse block ([NVS\\_SEC\\_HMAC\\_EFUSE\\_KEY\\_ID](#) or the v2 API argument) to be empty or pre-written with a key with the purpose [ESP\\_EFUSE\\_KEY\\_PURPOSE\\_HMAC\\_UP](#)

### **CONFIG\_NVS\_SEC\_HMAC\_EFUSE\_KEY\_ID**

eFuse key ID storing the HMAC key

*Found in: [Component config](#) > [NVS Security Provider](#)*

eFuse block key ID storing the HMAC key for deriving the NVS encryption keys

Note: The eFuse block key ID required by the HMAC scheme (`CONFIG_NVS_SEC_KEY_PROTECT_USING_HMAC`) is set using this config when the default NVS partition is initialized with `nvs_flash_init()`. The eFuse block key ID can also be set at runtime by passing the appropriate value to the NVS security scheme registration APIs.

**Range:**

- from 0 to 6 if `CONFIG_NVS_SEC_KEY_PROTECT_USING_HMAC`

**Default value:**

- 6 if `CONFIG_NVS_SEC_KEY_PROTECT_USING_HMAC`

**OpenThread** Contains:

- `CONFIG_OPENTHREAD_PLATFORM_MSGPOOL_MANAGEMENT`
- `CONFIG_OPENTHREAD_DEVICE_TYPE`
- `CONFIG_OPENTHREAD_RADIO_TYPE`
- `CONFIG_OPENTHREAD_BORDER_ROUTER`
- `CONFIG_OPENTHREAD_COMMISSIONER`
- `CONFIG_OPENTHREAD_CSL_DEBUG_ENABLE`
- `CONFIG_OPENTHREAD_CSL_ENABLE`
- `CONFIG_OPENTHREAD_DIAG`
- `CONFIG_OPENTHREAD_DNS_CLIENT`
- `CONFIG_OPENTHREAD_DUA_ENABLE`
- `CONFIG_OPENTHREAD_JOINER`
- `CONFIG_OPENTHREAD_LINK_METRICS`
- `CONFIG_OPENTHREAD_MACFILTER_ENABLE`
- `CONFIG_OPENTHREAD_CLI`
- `CONFIG_OPENTHREAD_SPINEL_ONLY`
- `CONFIG_OPENTHREAD_RX_ON_WHEN_IDLE`
- `CONFIG_OPENTHREAD_RADIO_STATS_ENABLE`
- `CONFIG_OPENTHREAD_SRP_CLIENT`
- `CONFIG_OPENTHREAD_TIME_SYNC`
- `CONFIG_OPENTHREAD_NCP_VENDOR_HOOK`
- `CONFIG_OPENTHREAD_MAC_MAX_CSMA_BACKOFFS_DIRECT`
- `CONFIG_OPENTHREAD_ENABLED`
- *OpenThread version message*
- `CONFIG_OPENTHREAD_XTAL_ACCURACY`
- `CONFIG_OPENTHREAD_CSL_UNCERTAIN`
- `CONFIG_OPENTHREAD_CSL_ACCURACY`
- `CONFIG_OPENTHREAD_NUM_MESSAGE_BUFFERS`
- `CONFIG_OPENTHREAD_RCP_TRANSPORT`
- `CONFIG_OPENTHREAD_MLE_MAX_CHILDREN`
- `CONFIG_OPENTHREAD_TMF_ADDR_CACHE_ENTRIES`
- `CONFIG_OPENTHREAD_SPINEL_RX_FRAME_BUFFER_SIZE`
- `CONFIG_OPENTHREAD_UART_BUFFER_SIZE`
- *Thread Address Query Config*
- *Thread Operational Dataset*
- `CONFIG_OPENTHREAD_DNS64_CLIENT`

**CONFIG\_OPENTHREAD\_ENABLED**

OpenThread

*Found in: Component config > OpenThread*

Select this option to enable OpenThread and show the submenu with OpenThread configuration choices.

**Default value:**

- No (disabled)

### CONFIG\_OPENTHREAD\_LOG\_LEVEL\_DYNAMIC

Enable dynamic log level control

*Found in:* [Component config](#) > [OpenThread](#) > [CONFIG\\_OPENTHREAD\\_ENABLED](#)

Select this option to enable dynamic log level control for OpenThread

**Default value:**

- Yes (enabled) if [CONFIG\\_OPENTHREAD\\_ENABLED](#)

### CONFIG\_OPENTHREAD\_CONSOLE\_TYPE

OpenThread console type

*Found in:* [Component config](#) > [OpenThread](#) > [CONFIG\\_OPENTHREAD\\_ENABLED](#)

Select OpenThread console type

Available options:

- OpenThread console type UART ([CONFIG\\_OPENTHREAD\\_CONSOLE\\_TYPE\\_UART](#))
- OpenThread console type USB Serial/JTAG Controller ([CONFIG\\_OPENTHREAD\\_CONSOLE\\_TYPE\\_USB\\_SERIAL\\_JTAG](#))

### CONFIG\_OPENTHREAD\_LOG\_LEVEL

OpenThread log verbosity

*Found in:* [Component config](#) > [OpenThread](#) > [CONFIG\\_OPENTHREAD\\_ENABLED](#)

Select OpenThread log level.

Available options:

- No logs ([CONFIG\\_OPENTHREAD\\_LOG\\_LEVEL\\_NONE](#))
- Error logs ([CONFIG\\_OPENTHREAD\\_LOG\\_LEVEL\\_CRIT](#))
- Warning logs ([CONFIG\\_OPENTHREAD\\_LOG\\_LEVEL\\_WARN](#))
- Notice logs ([CONFIG\\_OPENTHREAD\\_LOG\\_LEVEL\\_NOTE](#))
- Info logs ([CONFIG\\_OPENTHREAD\\_LOG\\_LEVEL\\_INFO](#))
- Debug logs ([CONFIG\\_OPENTHREAD\\_LOG\\_LEVEL\\_DEBG](#))

### Thread Operational Dataset

 Contains:

- [CONFIG\\_OPENTHREAD\\_NETWORK\\_EXTPANID](#)
- [CONFIG\\_OPENTHREAD\\_MESH\\_LOCAL\\_PREFIX](#)
- [CONFIG\\_OPENTHREAD\\_NETWORK\\_CHANNEL](#)
- [CONFIG\\_OPENTHREAD\\_NETWORK\\_MASTERKEY](#)
- [CONFIG\\_OPENTHREAD\\_NETWORK\\_NAME](#)
- [CONFIG\\_OPENTHREAD\\_NETWORK\\_PANID](#)
- [CONFIG\\_OPENTHREAD\\_NETWORK\\_PSKC](#)

### CONFIG\_OPENTHREAD\_NETWORK\_NAME

OpenThread network name

*Found in:* [Component config](#) > [OpenThread](#) > [Thread Operational Dataset](#)

**Default value:**

- "OpenThread-ESP"

### CONFIG\_OPENTHREAD\_MESH\_LOCAL\_PREFIX

OpenThread mesh local prefix, format <address>/<plen>

*Found in: Component config > OpenThread > Thread Operational Dataset*

A string in the format "`<address>/<plen>`", where `<address>` is an IPv6 address and `<plen>` is a prefix length. For example "fd00:db8:a0:0::/64"

**Default value:**

- "fd00:db8:a0:0::/64"

### CONFIG\_OPENTHREAD\_NETWORK\_CHANNEL

OpenThread network channel

*Found in: Component config > OpenThread > Thread Operational Dataset*

**Range:**

- from 11 to 26

**Default value:**

- 15

### CONFIG\_OPENTHREAD\_NETWORK\_PANID

OpenThread network pan id

*Found in: Component config > OpenThread > Thread Operational Dataset*

**Range:**

- from 0 to 0xFFFFE

**Default value:**

- "0x1234"

### CONFIG\_OPENTHREAD\_NETWORK\_EXTPANID

OpenThread extended pan id

*Found in: Component config > OpenThread > Thread Operational Dataset*

The OpenThread network extended pan id in hex string format

**Default value:**

- dead00beef00cafe

### CONFIG\_OPENTHREAD\_NETWORK\_MASTERKEY

OpenThread network key

*Found in: Component config > OpenThread > Thread Operational Dataset*

The OpenThread network network key in hex string format

**Default value:**

- 00112233445566778899aabbccddeeff

### CONFIG\_OPENTHREAD\_NETWORK\_PSKC

OpenThread pre-shared commissioner key

*Found in: Component config > OpenThread > Thread Operational Dataset*

The OpenThread pre-shared commissioner key in hex string format

**Default value:**

- 104810e2315100afd6bc9215a6bfac53

## CONFIG\_OPENTHREAD\_RADIO\_TYPE

Config the Thread radio type

Found in: *Component config > OpenThread*

Configure how OpenThread connects to the 15.4 radio

Available options:

- Native 15.4 radio (CONFIG\_OPENTHREAD\_RADIO\_NATIVE)  
Select this to use the native 15.4 radio.
- Connect via UART (CONFIG\_OPENTHREAD\_RADIO\_SPINEL\_UART)  
Select this to connect to a Radio Co-Processor via UART.
- Connect via SPI (CONFIG\_OPENTHREAD\_RADIO\_SPINEL\_SPI)  
Select this to connect to a Radio Co-Processor via SPI.

## CONFIG\_OPENTHREAD\_DEVICE\_TYPE

Config the Thread device type

Found in: *Component config > OpenThread*

OpenThread can be configured to different device types (FTD, MTD, Radio)

Available options:

- Full Thread Device (CONFIG\_OPENTHREAD\_FTD)  
Select this to enable Full Thread Device which can act as router and leader in a Thread network.
- Minimal Thread Device (CONFIG\_OPENTHREAD\_MTD)  
Select this to enable Minimal Thread Device which can only act as end device in a Thread network. This will reduce the code size of the OpenThread stack.
- Radio Only Device (CONFIG\_OPENTHREAD\_RADIO)  
Select this to enable Radio Only Device which can only forward 15.4 packets to the host. The OpenThread stack will be run on the host and OpenThread will have minimal footprint on the radio only device.

## CONFIG\_OPENTHREAD\_RCP\_TRANSPORT

The RCP transport type

Found in: *Component config > OpenThread*

Available options:

- UART RCP (CONFIG\_OPENTHREAD\_RCP\_UART)  
Select this to enable UART connection to host.
- SPI RCP (CONFIG\_OPENTHREAD\_RCP\_SPI)  
Select this to enable SPI connection to host.

**OpenThread version message** Contains:

- *CONFIG\_OPENTHREAD\_PACKAGE\_NAME*
- *CONFIG\_OPENTHREAD\_PLATFORM\_INFO*

### CONFIG\_OPENTHREAD\_PACKAGE\_NAME

OpenThread package name

*Found in: Component config > OpenThread > OpenThread version message*

The OpenThread package name.

**Default value:**

- "openthread-esp32" if *CONFIG\_OPENTHREAD\_ENABLED*

### CONFIG\_OPENTHREAD\_PLATFORM\_INFO

platform information

*Found in: Component config > OpenThread > OpenThread version message*

The OpenThread platform information.

**Default value:**

- "esp32h2" if *CONFIG\_OPENTHREAD\_ENABLED*

### CONFIG\_OPENTHREAD\_NCP\_VENDOR\_HOOK

Enable vendor command for RCP

*Found in: Component config > OpenThread*

Select this to enable OpenThread NCP vendor commands.

**Default value:**

- Yes (enabled) if *CONFIG\_OPENTHREAD\_RADIO*

### CONFIG\_OPENTHREAD\_CLI

Enable Openthread Command-Line Interface

*Found in: Component config > OpenThread*

Select this option to enable Command-Line Interface in OpenThread.

**Default value:**

- Yes (enabled) if *CONFIG\_OPENTHREAD\_ENABLED*

### CONFIG\_OPENTHREAD\_DIAG

Enable diag

*Found in: Component config > OpenThread*

Select this option to enable Diag in OpenThread. This will enable diag mode and a series of diag commands in the OpenThread command line. These commands allow users to manipulate low-level features of the storage and 15.4 radio.

**Default value:**

- Yes (enabled) if *CONFIG\_OPENTHREAD\_ENABLED*

### CONFIG\_OPENTHREAD\_COMMISSIONER

Enable Commissioner

*Found in: Component config > OpenThread*

Select this option to enable commissioner in OpenThread. This will enable the device to act as a commissioner in the Thread network. A commissioner checks the pre-shared key from a joining device

with the Thread commissioning protocol and shares the network parameter with the joining device upon success.

**Default value:**

- No (disabled) if *CONFIG\_OPENTHREAD\_ENABLED*

**CONFIG\_OPENTHREAD\_COMM\_MAX\_JOINER\_ENTRIES**

The size of max commissioning joiner entries

*Found in: Component config > OpenThread > CONFIG\_OPENTHREAD\_COMMISSIONER*

**Default value:**

- 2 if *CONFIG\_OPENTHREAD\_COMMISSIONER*

**CONFIG\_OPENTHREAD\_JOINER**

Enable Joiner

*Found in: Component config > OpenThread*

Select this option to enable Joiner in OpenThread. This allows a device to join the Thread network with a pre-shared key using the Thread commissioning protocol.

**Default value:**

- No (disabled) if *CONFIG\_OPENTHREAD\_ENABLED*

**CONFIG\_OPENTHREAD\_SRP\_CLIENT**

Enable SRP Client

*Found in: Component config > OpenThread*

Select this option to enable SRP Client in OpenThread. This allows a device to register SRP services to SRP Server.

**Default value:**

- Yes (enabled) if *CONFIG\_OPENTHREAD\_ENABLED*

**CONFIG\_OPENTHREAD\_SRP\_CLIENT\_MAX\_SERVICES**

Specifies number of service entries in the SRP client service pool

*Found in: Component config > OpenThread > CONFIG\_OPENTHREAD\_SRP\_CLIENT*

Set the max buffer size of service entries in the SRP client service pool.

**Default value:**

- 5 if *CONFIG\_OPENTHREAD\_SRP\_CLIENT*

**CONFIG\_OPENTHREAD\_DNS\_CLIENT**

Enable DNS Client

*Found in: Component config > OpenThread*

Select this option to enable DNS Client in OpenThread.

**Default value:**

- Yes (enabled) if *CONFIG\_OPENTHREAD\_ENABLED*



### CONFIG\_OPENTHREAD\_BORDER\_ROUTER

Enable Border Router

Found in: *Component config > OpenThread*

Select this option to enable border router features in OpenThread.

**Default value:**

- No (disabled) if `CONFIG_OPENTHREAD_ENABLED`

### CONFIG\_OPENTHREAD\_PLATFORM\_MSGPOOL\_MANAGEMENT

Allocate message pool buffer from PSRAM

Found in: *Component config > OpenThread*

If enabled, the message pool is managed by platform defined logic.

**Default value:**

- No (disabled) if `CONFIG_OPENTHREAD_ENABLED` && (`SPIRAM_USE_CAPS_ALLOC` || `SPIRAM_USE_MALLOC`)

### CONFIG\_OPENTHREAD\_NUM\_MESSAGE\_BUFFERS

The number of openthread message buffers

Found in: *Component config > OpenThread*

**Default value:**

- 65 if `CONFIG_OPENTHREAD_ENABLED`

### CONFIG\_OPENTHREAD\_SPINEL\_RX\_FRAME\_BUFFER\_SIZE

The size of openthread spinel rx frame buffer

Found in: *Component config > OpenThread*

**Default value:**

- 1024 if (`CONFIG_OPENTHREAD_MTD` || `CONFIG_OPENTHREAD_RADIO`) && (`CONFIG_OPENTHREAD_ENABLED` || `CONFIG_OPENTHREAD_SPINEL_ONLY`)
- 2048 if (`CONFIG_OPENTHREAD_FTD` || `CONFIG_OPENTHREAD_SPINEL_ONLY`) && (`CONFIG_OPENTHREAD_ENABLED` || `CONFIG_OPENTHREAD_SPINEL_ONLY`)

### CONFIG\_OPENTHREAD\_MAC\_MAX\_CSMA\_BACKOFFS\_DIRECT

Maximum backoffs times before declaring a channel access failure.

Found in: *Component config > OpenThread*

The maximum number of backoffs the CSMA-CA algorithm will attempt before declaring a channel access failure.

**Default value:**

- 4 if `CONFIG_OPENTHREAD_ENABLED` || `CONFIG_OPENTHREAD_SPINEL_ONLY`

### CONFIG\_OPENTHREAD\_MLE\_MAX\_CHILDREN

The size of max MLE children entries

Found in: *Component config > OpenThread*

**Default value:**

- 10 if `CONFIG_OPENTHREAD_ENABLED`

### **CONFIG\_OPENTHREAD\_TMF\_ADDR\_CACHE\_ENTRIES**

The size of max TMF address cache entries

*Found in: Component config > OpenThread*

**Default value:**

- 20 if *CONFIG\_OPENTHREAD\_ENABLED*

### **CONFIG\_OPENTHREAD\_DNS64\_CLIENT**

Use dns64 client

*Found in: Component config > OpenThread*

Select this option to acquire NAT64 address from dns servers.

**Default value:**

- No (disabled) if *CONFIG\_OPENTHREAD\_ENABLED* && *CONFIG\_LWIP\_IPV4*

### **CONFIG\_OPENTHREAD\_DNS\_SERVER\_ADDR**

DNS server address (IPv4)

*Found in: Component config > OpenThread > CONFIG\_OPENTHREAD\_DNS64\_CLIENT*

Set the DNS server IPv4 address.

**Default value:**

- "8.8.8.8" if *CONFIG\_OPENTHREAD\_DNS64\_CLIENT*

### **CONFIG\_OPENTHREAD\_UART\_BUFFER\_SIZE**

The uart received buffer size of openthread

*Found in: Component config > OpenThread*

Set the OpenThread UART buffer size.

**Default value:**

- 2048 if *CONFIG\_OPENTHREAD\_ENABLED*

### **CONFIG\_OPENTHREAD\_LINK\_METRICS**

Enable link metrics feature

*Found in: Component config > OpenThread*

Select this option to enable link metrics feature

**Default value:**

- No (disabled) if *CONFIG\_OPENTHREAD\_ENABLED*

### **CONFIG\_OPENTHREAD\_MACFILTER\_ENABLE**

Enable mac filter feature

*Found in: Component config > OpenThread*

Select this option to enable mac filter feature

**Default value:**

- No (disabled) if *CONFIG\_OPENTHREAD\_ENABLED*

### CONFIG\_OPENTHREAD\_CSL\_ENABLE

Enable CSL feature

*Found in: Component config > OpenThread*

Select this option to enable CSL feature

**Default value:**

- No (disabled) if *CONFIG\_OPENTHREAD\_ENABLED*

### CONFIG\_OPENTHREAD\_XTAL\_ACCURACY

The accuracy of the XTAL

*Found in: Component config > OpenThread*

The device's XTAL accuracy, in ppm.

**Default value:**

- 130

### CONFIG\_OPENTHREAD\_CSL\_ACCURACY

The current CSL rx/tx scheduling drift, in units of  $\pm$  ppm

*Found in: Component config > OpenThread*

The current accuracy of the clock used for scheduling CSL operations

**Default value:**

- 1 if *CONFIG\_OPENTHREAD\_CSL\_ENABLE*

### CONFIG\_OPENTHREAD\_CSL\_UNCERTAIN

The CSL Uncertainty in units of 10 us.

*Found in: Component config > OpenThread*

The fixed uncertainty of the Device for scheduling CSL Transmissions in units of 10 microseconds.

**Default value:**

- 1 if *CONFIG\_OPENTHREAD\_CSL\_ENABLE*

### CONFIG\_OPENTHREAD\_CSL\_DEBUG\_ENABLE

Enable CSL debug

*Found in: Component config > OpenThread*

Select this option to set rx on when sleep in CSL feature, only for debug

**Default value:**

- No (disabled) if *CONFIG\_OPENTHREAD\_CSL\_ENABLE*

### CONFIG\_OPENTHREAD\_DUA\_ENABLE

Enable Domain Unicast Address feature

*Found in: Component config > OpenThread*

Only used for Thread1.2 certification

**Default value:**

- No (disabled) if *CONFIG\_OPENTHREAD\_ENABLED*

### CONFIG\_OPENTHREAD\_TIME\_SYNC

Enable the time synchronization service feature

*Found in: [Component config](#) > [OpenThread](#)*

Select this option to enable time synchronization feature, the devices in the same Thread network could sync to the same network time.

**Default value:**

- No (disabled) if [CONFIG\\_OPENTHREAD\\_ENABLED](#)

### CONFIG\_OPENTHREAD\_RADIO\_STATS\_ENABLE

Enable Radio Statistics feature

*Found in: [Component config](#) > [OpenThread](#)*

Select this option to enable the radio statistics feature, you can use radio command to print some radio Statistics information.

**Default value:**

- No (disabled) if [CONFIG\\_OPENTHREAD\\_FTD](#) || [CONFIG\\_OPENTHREAD\\_MTD](#)

### CONFIG\_OPENTHREAD\_SPINEL\_ONLY

Enable OpenThread External Radio Spinel feature

*Found in: [Component config](#) > [OpenThread](#)*

Select this option to enable the OpenThread Radio Spinel for external protocol stack, such as Zigbee.

**Default value:**

- No (disabled)

### CONFIG\_OPENTHREAD\_RX\_ON\_WHEN\_IDLE

Enable OpenThread radio capability rx on when idle

*Found in: [Component config](#) > [OpenThread](#)*

Select this option to enable OpenThread radio capability rx on when idle. Do not support this feature when SW coexistence is enabled.

**Default value:**

- No (disabled) if [CONFIG\\_ESP\\_COEX\\_SW\\_COEXIST\\_ENABLE](#)

### Thread Address Query Config

 Contains:

- [CONFIG\\_OPENTHREAD\\_ADDRESS\\_QUERY\\_RETRY\\_DELAY](#)
- [CONFIG\\_OPENTHREAD\\_ADDRESS\\_QUERY\\_MAX\\_RETRY\\_DELAY](#)
- [CONFIG\\_OPENTHREAD\\_ADDRESS\\_QUERY\\_TIMEOUT](#)

### CONFIG\_OPENTHREAD\_ADDRESS\_QUERY\_TIMEOUT

Timeout value (in seconds) for a address notification response after sending an address query.

*Found in: [Component config](#) > [OpenThread](#) > [Thread Address Query Config](#)*

**Default value:**

- 3 if [CONFIG\\_OPENTHREAD\\_FTD](#) || [CONFIG\\_OPENTHREAD\\_MTD](#)

### CONFIG\_OPENTHREAD\_ADDRESS\_QUERY\_RETRY\_DELAY

Initial retry delay for address query (in seconds).

*Found in: Component config > OpenThread > Thread Address Query Config*

**Default value:**

- 15 if `CONFIG_OPENTHREAD_FTD` || `CONFIG_OPENTHREAD_MTD`

### CONFIG\_OPENTHREAD\_ADDRESS\_QUERY\_MAX\_RETRY\_DELAY

Maximum retry delay for address query (in seconds).

*Found in: Component config > OpenThread > Thread Address Query Config*

**Default value:**

- 120 if `CONFIG_OPENTHREAD_FTD` || `CONFIG_OPENTHREAD_MTD`

**Protocomm** Contains:

- `CONFIG_ESP_PROTOCOMM_SUPPORT_SECURITY_VERSION_0`
- `CONFIG_ESP_PROTOCOMM_SUPPORT_SECURITY_VERSION_1`
- `CONFIG_ESP_PROTOCOMM_SUPPORT_SECURITY_VERSION_2`

### CONFIG\_ESP\_PROTOCOMM\_SUPPORT\_SECURITY\_VERSION\_0

Support protocomm security version 0 (no security)

*Found in: Component config > Protocomm*

Enable support of security version 0. Disabling this option saves some code size. Consult the Enabling protocomm security version section of the Protocomm documentation in ESP-IDF Programming guide for more details.

**Default value:**

- Yes (enabled)

### CONFIG\_ESP\_PROTOCOMM\_SUPPORT\_SECURITY\_VERSION\_1

Support protocomm security version 1 (Curve25519 key exchange + AES-CTR encryption/decryption)

*Found in: Component config > Protocomm*

Enable support of security version 1. Disabling this option saves some code size. Consult the Enabling protocomm security version section of the Protocomm documentation in ESP-IDF Programming guide for more details.

**Default value:**

- Yes (enabled)

### CONFIG\_ESP\_PROTOCOMM\_SUPPORT\_SECURITY\_VERSION\_2

Support protocomm security version 2 (SRP6a-based key exchange + AES-GCM encryption/decryption)

*Found in: Component config > Protocomm*

Enable support of security version 2. Disabling this option saves some code size. Consult the Enabling protocomm security version section of the Protocomm documentation in ESP-IDF Programming guide for more details.

**Default value:**

- Yes (enabled)

**PThreads** Contains:

- [CONFIG\\_PTHREAD\\_TASK\\_NAME\\_DEFAULT](#)
- [CONFIG\\_PTHREAD\\_TASK\\_CORE\\_DEFAULT](#)
- [CONFIG\\_PTHREAD\\_TASK\\_PRIO\\_DEFAULT](#)
- [CONFIG\\_PTHREAD\\_TASK\\_STACK\\_SIZE\\_DEFAULT](#)
- [CONFIG\\_PTHREAD\\_STACK\\_MIN](#)

### **CONFIG\_PTHREAD\_TASK\_PRIO\_DEFAULT**

Default task priority

*Found in:* [Component config > PThreads](#)

Priority used to create new tasks with default pthread parameters.

**Range:**

- from 0 to 255

**Default value:**

- 5

### **CONFIG\_PTHREAD\_TASK\_STACK\_SIZE\_DEFAULT**

Default task stack size

*Found in:* [Component config > PThreads](#)

Stack size used to create new tasks with default pthread parameters.

**Default value:**

- 3072

### **CONFIG\_PTHREAD\_STACK\_MIN**

Minimum allowed pthread stack size

*Found in:* [Component config > PThreads](#)

Minimum allowed pthread stack size set in attributes passed to pthread\_create

**Default value:**

- 768

### **CONFIG\_PTHREAD\_TASK\_CORE\_DEFAULT**

Default pthread core affinity

*Found in:* [Component config > PThreads](#)

The default core to which pthreads are pinned.

Available options:

- No affinity ([CONFIG\\_PTHREAD\\_DEFAULT\\_CORE\\_NO\\_AFFINITY](#))
- Core 0 ([CONFIG\\_PTHREAD\\_DEFAULT\\_CORE\\_0](#))
- Core 1 ([CONFIG\\_PTHREAD\\_DEFAULT\\_CORE\\_1](#))

## CONFIG\_PTHREAD\_TASK\_NAME\_DEFAULT

Default name of pthreads

Found in: *Component config > PThreads*

The default name of pthreads.

### Default value:

- "pthread"

**SoC Settings** Contains:

- *MMU Config*

## MMU Config

**Main Flash configuration** Contains:

- *Optional and Experimental Features (READ DOCS FIRST)*
- *SPI Flash behavior when brownout*

**SPI Flash behavior when brownout** Contains:

- *CONFIG\_SPI\_FLASH\_BROWNOUT\_RESET\_XMC*

## CONFIG\_SPI\_FLASH\_BROWNOUT\_RESET\_XMC

Enable sending reset when brownout for XMC flash chips

Found in: *Component config > Main Flash configuration > SPI Flash behavior when brownout*

When this option is selected, the patch will be enabled for XMC. Follow the recommended flow by XMC for better stability.

DO NOT DISABLE UNLESS YOU KNOW WHAT YOU ARE DOING.

**Optional and Experimental Features (READ DOCS FIRST)** Contains:

- *CONFIG\_SPI\_FLASH\_AUTO\_SUSPEND*
- *CONFIG\_SPI\_FLASH\_SUSPEND\_TSUS\_VAL\_US*
- *CONFIG\_SPI\_FLASH\_HPM\_DC*

## CONFIG\_SPI\_FLASH\_HPM\_DC

Support HPM using DC (READ DOCS FIRST)

Found in: *Component config > Main Flash configuration > Optional and Experimental Features (READ DOCS FIRST)*

This feature needs your bootloader to be compiled DC-aware (BOOT-LOADER\_FLASH\_DC\_AWARE=y). Otherwise the chip will not be able to boot after a reset.

Available options:

- Auto (Enable when bootloader support enabled (BOOT-LOADER\_FLASH\_DC\_AWARE)) (CONFIG\_SPI\_FLASH\_HPM\_DC\_AUTO)
- Disable (READ DOCS FIRST) (CONFIG\_SPI\_FLASH\_HPM\_DC\_DISABLE)

### CONFIG\_SPI\_FLASH\_AUTO\_SUSPEND

Auto suspend long erase/write operations (READ DOCS FIRST)

*Found in: Component config > Main Flash configuration > Optional and Experimental Features (READ DOCS FIRST)*

This option is disabled by default because it is supported only for specific flash chips and for specific Espressif chips. To evaluate if you can use this feature refer to *Optional Features for Flash > Auto Suspend & Resume* of the *ESP-IDF Programming Guide*.

CAUTION: If you want to OTA to an app with this feature turned on, please make sure the bootloader has the support for it. (later than IDF v4.3)

If you are using an official Espressif module, please contact Espressif Business support to check if the module has the flash that support this feature installed. Also refer to *Concurrency Constraints for Flash on SPII > Flash Auto Suspend Feature* before enabling this option.

### CONFIG\_SPI\_FLASH\_SUSPEND\_TSUS\_VAL\_US

SPI flash tSUS value (refer to chapter AC CHARACTERISTICS)

*Found in: Component config > Main Flash configuration > Optional and Experimental Features (READ DOCS FIRST)*

This config is used for setting Tsus parameter. Tsus means CS# high to next command after suspend. You can refer to the chapter of AC CHARACTERISTICS of flash datasheet.

**SPI Flash driver** Contains:

- *Auto-detect flash chips*
- *CONFIG\_SPI\_FLASH\_BYPASS\_BLOCK\_ERASE*
- *CONFIG\_SPI\_FLASH\_ENABLE\_ENCRYPTED\_READ\_WRITE*
- *CONFIG\_SPI\_FLASH\_ENABLE\_COUNTERS*
- *CONFIG\_SPI\_FLASH\_ROM\_DRIVER\_PATCH*
- *CONFIG\_SPI\_FLASH\_YIELD\_DURING\_ERASE*
- *CONFIG\_SPI\_FLASH\_CHECK\_ERASE\_TIMEOUT\_DISABLED*
- *CONFIG\_SPI\_FLASH\_WRITE\_CHUNK\_SIZE*
- *CONFIG\_SPI\_FLASH\_OVERRIDE\_CHIP\_DRIVER\_LIST*
- *CONFIG\_SPI\_FLASH\_SIZE\_OVERRIDE*
- *CONFIG\_SPI\_FLASH\_ROM\_IMPL*
- *CONFIG\_SPI\_FLASH\_VERIFY\_WRITE*
- *CONFIG\_SPI\_FLASH\_DANGEROUS\_WRITE*

### CONFIG\_SPI\_FLASH\_VERIFY\_WRITE

Verify SPI flash writes

*Found in: Component config > SPI Flash driver*

If this option is enabled, any time SPI flash is written then the data will be read back and verified. This can catch hardware problems with SPI flash, or flash which was not erased before verification.

### CONFIG\_SPI\_FLASH\_LOG\_FAILED\_WRITE

Log errors if verification fails

*Found in: Component config > SPI Flash driver > CONFIG\_SPI\_FLASH\_VERIFY\_WRITE*

If this option is enabled, if SPI flash write verification fails then a log error line will be written with the address, expected & actual values. This can be useful when debugging hardware SPI flash problems.



### CONFIG\_SPI\_FLASH\_WARN\_SETTING\_ZERO\_TO\_ONE

Log warning if writing zero bits to ones

*Found in: Component config > SPI Flash driver > CONFIG\_SPI\_FLASH\_VERIFY\_WRITE*

If this option is enabled, any SPI flash write which tries to set zero bits in the flash to ones will log a warning. Such writes will not result in the requested data appearing identically in flash once written, as SPI NOR flash can only set bits to one when an entire sector is erased. After erasing, individual bits can only be written from one to zero.

Note that some software (such as SPIFFS) which is aware of SPI NOR flash may write one bits as an optimisation, relying on the data in flash becoming a bitwise AND of the new data and any existing data. Such software will log spurious warnings if this option is enabled.

### CONFIG\_SPI\_FLASH\_ENABLE\_COUNTERS

Enable operation counters

*Found in: Component config > SPI Flash driver*

This option enables the following APIs:

- esp\_flash\_reset\_counters
- esp\_flash\_dump\_counters
- esp\_flash\_get\_counters

These APIs may be used to collect performance data for spi\_flash APIs and to help understand behaviour of libraries which use SPI flash.

### CONFIG\_SPI\_FLASH\_ROM\_DRIVER\_PATCH

Enable SPI flash ROM driver patched functions

*Found in: Component config > SPI Flash driver*

Enable this flag to use patched versions of SPI flash ROM driver functions. This option should be enabled, if any one of the following is true: (1) need to write to flash on ESP32-D2WD; (2) main SPI flash is connected to non-default pins; (3) main SPI flash chip is manufactured by ISSI.

### CONFIG\_SPI\_FLASH\_ROM\_IMPL

Use esp\_flash implementation in ROM

*Found in: Component config > SPI Flash driver*

Enable this flag to use new SPI flash driver functions from ROM instead of ESP-IDF.

If keeping this as "n" in your project, you will have less free IRAM. But you can use all of our flash features.

If making this as "y" in your project, you will increase free IRAM. But you may miss out on some flash features and support for new flash chips.

Currently the ROM cannot support the following features:

- SPI\_FLASH\_AUTO\_SUSPEND (C3, S3)

### CONFIG\_SPI\_FLASH\_DANGEROUS\_WRITE

Writing to dangerous flash regions

*Found in: Component config > SPI Flash driver*

SPI flash APIs can optionally abort or return a failure code if erasing or writing addresses that fall at the beginning of flash (covering the bootloader and partition table) or that overlap the app partition that contains the running app.

It is not recommended to ever write to these regions from an IDF app, and this check prevents logic errors or corrupted firmware memory from damaging these regions.

Note that this feature *\*does not\** check calls to the `esp_rom_XXX` SPI flash ROM functions. These functions should not be called directly from IDF applications.

Available options:

- Aborts (`CONFIG_SPI_FLASH_DANGEROUS_WRITE_ABORTS`)
- Fails (`CONFIG_SPI_FLASH_DANGEROUS_WRITE_FAILS`)
- Allowed (`CONFIG_SPI_FLASH_DANGEROUS_WRITE_ALLOWED`)

### **CONFIG\_SPI\_FLASH\_BYPASS\_BLOCK\_ERASE**

Bypass a block erase and always do sector erase

*Found in: [Component config](#) > [SPI Flash driver](#)*

Some flash chips can have very high "max" erase times, especially for block erase (32KB or 64KB). This option allows to bypass "block erase" and always do sector erase commands. This will be much slower overall in most cases, but improves latency for other code to run.

### **CONFIG\_SPI\_FLASH\_YIELD\_DURING\_ERASE**

Enables yield operation during flash erase

*Found in: [Component config](#) > [SPI Flash driver](#)*

This allows to yield the CPUs between erase commands. Prevents starvation of other tasks. Please use this configuration together with `SPI\_FLASH\_ERASE\_YIELD\_DURATION\_MS` and `SPI\_FLASH\_ERASE\_YIELD\_TICKS` after carefully checking flash datasheet to avoid a watchdog timeout. For more information, please check *SPI Flash API* reference documentation under section *OS Function*.

### **CONFIG\_SPI\_FLASH\_ERASE\_YIELD\_DURATION\_MS**

Duration of erasing to yield CPUs (ms)

*Found in: [Component config](#) > [SPI Flash driver](#) > [CONFIG\\_SPI\\_FLASH\\_YIELD\\_DURING\\_ERASE](#)*

If a duration of one erase command is large then it will yield CPUs after finishing a current command.

### **CONFIG\_SPI\_FLASH\_ERASE\_YIELD\_TICKS**

CPU release time (tick) for an erase operation

*Found in: [Component config](#) > [SPI Flash driver](#) > [CONFIG\\_SPI\\_FLASH\\_YIELD\\_DURING\\_ERASE](#)*

Defines how many ticks will be before returning to continue a erasing.

### **CONFIG\_SPI\_FLASH\_WRITE\_CHUNK\_SIZE**

Flash write chunk size

*Found in: [Component config](#) > [SPI Flash driver](#)*

Flash write is broken down in terms of multiple (smaller) write operations. This configuration options helps to set individual write chunk size, smaller value here ensures that cache (and non-IRAM resident interrupts) remains disabled for shorter duration.

### CONFIG\_SPI\_FLASH\_SIZE\_OVERRIDE

Override flash size in bootloader header by ESPTOOLPY\_FLASHSIZE

*Found in: Component config > SPI Flash driver*

SPI Flash driver uses the flash size configured in bootloader header by default. Enable this option to override flash size with latest ESPTOOLPY\_FLASHSIZE value from the app header if the size in the bootloader header is incorrect.

### CONFIG\_SPI\_FLASH\_CHECK\_ERASE\_TIMEOUT\_DISABLED

Flash timeout checkout disabled

*Found in: Component config > SPI Flash driver*

This option is helpful if you are using a flash chip whose timeout is quite large or unpredictable.

### CONFIG\_SPI\_FLASH\_OVERRIDE\_CHIP\_DRIVER\_LIST

Override default chip driver list

*Found in: Component config > SPI Flash driver*

This option allows the chip driver list to be customized, instead of using the default list provided by ESP-IDF.

When this option is enabled, the default list is no longer compiled or linked. Instead, the *default\_registered\_chips* structure must be provided by the user.

See example: `custom_chip_driver` under `examples/storage` for more details.

**Auto-detect flash chips** Contains:

- [CONFIG\\_SPI\\_FLASH\\_SUPPORT\\_BOYA\\_CHIP](#)
- [CONFIG\\_SPI\\_FLASH\\_SUPPORT\\_GD\\_CHIP](#)
- [CONFIG\\_SPI\\_FLASH\\_SUPPORT\\_ISSI\\_CHIP](#)
- [CONFIG\\_SPI\\_FLASH\\_SUPPORT\\_MXIC\\_CHIP](#)
- [CONFIG\\_SPI\\_FLASH\\_SUPPORT\\_TH\\_CHIP](#)
- [CONFIG\\_SPI\\_FLASH\\_SUPPORT\\_WINBOND\\_CHIP](#)

### CONFIG\_SPI\_FLASH\_SUPPORT\_ISSI\_CHIP

ISSI

*Found in: Component config > SPI Flash driver > Auto-detect flash chips*

Enable this to support auto detection of ISSI chips if chip vendor not directly given by `chip\_drv` member of the chip struct. This adds support for variant chips, however will extend detecting time.

### CONFIG\_SPI\_FLASH\_SUPPORT\_MXIC\_CHIP

MXIC

*Found in: Component config > SPI Flash driver > Auto-detect flash chips*

Enable this to support auto detection of MXIC chips if chip vendor not directly given by `chip\_drv` member of the chip struct. This adds support for variant chips, however will extend detecting time.

### CONFIG\_SPI\_FLASH\_SUPPORT\_GD\_CHIP

GigaDevice

*Found in: Component config > SPI Flash driver > Auto-detect flash chips*

Enable this to support auto detection of GD (GigaDevice) chips if chip vendor not directly given by `chip\_drv` member of the chip struct. If you are using Wrover modules, please don't disable this, otherwise your flash may not work in 4-bit mode.

This adds support for variant chips, however will extend detecting time and image size. Note that the default chip driver supports the GD chips with product ID 60H.

### CONFIG\_SPI\_FLASH\_SUPPORT\_WINBOND\_CHIP

Winbond

*Found in: Component config > SPI Flash driver > Auto-detect flash chips*

Enable this to support auto detection of Winbond chips if chip vendor not directly given by `chip\_drv` member of the chip struct. This adds support for variant chips, however will extend detecting time.

### CONFIG\_SPI\_FLASH\_SUPPORT\_BOYA\_CHIP

BOYA

*Found in: Component config > SPI Flash driver > Auto-detect flash chips*

Enable this to support auto detection of BOYA chips if chip vendor not directly given by `chip\_drv` member of the chip struct. This adds support for variant chips, however will extend detecting time.

### CONFIG\_SPI\_FLASH\_SUPPORT\_TH\_CHIP

TH

*Found in: Component config > SPI Flash driver > Auto-detect flash chips*

Enable this to support auto detection of TH chips if chip vendor not directly given by `chip\_drv` member of the chip struct. This adds support for variant chips, however will extend detecting time.

### CONFIG\_SPI\_FLASH\_ENABLE\_ENCRYPTED\_READ\_WRITE

Enable encrypted partition read/write operations

*Found in: Component config > SPI Flash driver*

This option enables flash read/write operations to encrypted partition/s. This option is kept enabled irrespective of state of flash encryption feature. However, in case application is not using flash encryption feature and is in need of some additional memory from IRAM region (~1KB) then this config can be disabled.

### SPIFFS Configuration Contains:

- *Debug Configuration*
- *CONFIG\_SPIFFS\_USE\_MAGIC*
- *CONFIG\_SPIFFS\_GC\_STATS*
- *CONFIG\_SPIFFS\_PAGE\_CHECK*
- *CONFIG\_SPIFFS\_FOLLOW\_SYMLINKS*
- *CONFIG\_SPIFFS\_MAX\_PARTITIONS*
- *CONFIG\_SPIFFS\_USE\_MTIME*
- *CONFIG\_SPIFFS\_GC\_MAX\_RUNS*
- *CONFIG\_SPIFFS\_OBJ\_NAME\_LEN*
- *CONFIG\_SPIFFS\_META\_LENGTH*

- [SPIFFS Cache Configuration](#)
- [CONFIG\\_SPIFFS\\_PAGE\\_SIZE](#)
- [CONFIG\\_SPIFFS\\_MTIME\\_WIDE\\_64\\_BITS](#)

### CONFIG\_SPIFFS\_MAX\_PARTITIONS

Maximum Number of Partitions

*Found in: Component config > SPIFFS Configuration*

Define maximum number of partitions that can be mounted.

**Range:**

- from 1 to 10

**Default value:**

- 3

**SPIFFS Cache Configuration** Contains:

- [CONFIG\\_SPIFFS\\_CACHE](#)

### CONFIG\_SPIFFS\_CACHE

Enable SPIFFS Cache

*Found in: Component config > SPIFFS Configuration > SPIFFS Cache Configuration*

Enables/disable memory read caching of nucleus file system operations.

**Default value:**

- Yes (enabled)

### CONFIG\_SPIFFS\_CACHE\_WR

Enable SPIFFS Write Caching

*Found in: Component config > SPIFFS Configuration > SPIFFS Cache Configuration > CONFIG\_SPIFFS\_CACHE*

Enables memory write caching for file descriptors in hydrogen.

**Default value:**

- Yes (enabled)

### CONFIG\_SPIFFS\_CACHE\_STATS

Enable SPIFFS Cache Statistics

*Found in: Component config > SPIFFS Configuration > SPIFFS Cache Configuration > CONFIG\_SPIFFS\_CACHE*

Enable/disable statistics on caching. Debug/test purpose only.

**Default value:**

- No (disabled)

### CONFIG\_SPIFFS\_PAGE\_CHECK

Enable SPIFFS Page Check

*Found in: Component config > SPIFFS Configuration*

Always check header of each accessed page to ensure consistent state. If enabled it will increase number of reads from flash, especially if cache is disabled.

**Default value:**

- Yes (enabled)

### CONFIG\_SPIFFS\_GC\_MAX\_RUNS

Set Maximum GC Runs

*Found in: [Component config](#) > [SPIFFS Configuration](#)*

Define maximum number of GC runs to perform to reach desired free pages.

**Range:**

- from 1 to 10000

**Default value:**

- 10

### CONFIG\_SPIFFS\_GC\_STATS

Enable SPIFFS GC Statistics

*Found in: [Component config](#) > [SPIFFS Configuration](#)*

Enable/disable statistics on gc. Debug/test purpose only.

**Default value:**

- No (disabled)

### CONFIG\_SPIFFS\_PAGE\_SIZE

SPIFFS logical page size

*Found in: [Component config](#) > [SPIFFS Configuration](#)*

Logical page size of SPIFFS partition, in bytes. Must be multiple of flash page size (which is usually 256 bytes). Larger page sizes reduce overhead when storing large files, and improve filesystem performance when reading large files. Smaller page sizes reduce overhead when storing small (< page size) files.

**Range:**

- from 256 to 1024

**Default value:**

- 256

### CONFIG\_SPIFFS\_OBJ\_NAME\_LEN

Set SPIFFS Maximum Name Length

*Found in: [Component config](#) > [SPIFFS Configuration](#)*

Object name maximum length. Note that this length include the zero-termination character, meaning maximum string of characters can at most be SPIFFS\_OBJ\_NAME\_LEN - 1.

SPIFFS\_OBJ\_NAME\_LEN + SPIFFS\_META\_LENGTH should not exceed SPIFFS\_PAGE\_SIZE - 64.

**Range:**

- from 1 to 256

**Default value:**

- 32

### CONFIG\_SPIFFS\_FOLLOW\_SYMLINKS

Enable symbolic links for image creation

*Found in: [Component config](#) > [SPIFFS Configuration](#)*

If this option is enabled, symbolic links are taken into account during partition image creation.

**Default value:**

- No (disabled)

### CONFIG\_SPIFFS\_USE\_MAGIC

Enable SPIFFS Filesystem Magic

*Found in: [Component config](#) > [SPIFFS Configuration](#)*

Enable this to have an identifiable spiffs filesystem. This will look for a magic in all sectors to determine if this is a valid spiffs system or not at mount time.

**Default value:**

- Yes (enabled)

### CONFIG\_SPIFFS\_USE\_MAGIC\_LENGTH

Enable SPIFFS Filesystem Length Magic

*Found in: [Component config](#) > [SPIFFS Configuration](#) > [CONFIG\\_SPIFFS\\_USE\\_MAGIC](#)*

If this option is enabled, the magic will also be dependent on the length of the filesystem. For example, a filesystem configured and formatted for 4 megabytes will not be accepted for mounting with a configuration defining the filesystem as 2 megabytes.

**Default value:**

- Yes (enabled)

### CONFIG\_SPIFFS\_META\_LENGTH

Size of per-file metadata field

*Found in: [Component config](#) > [SPIFFS Configuration](#)*

This option sets the number of extra bytes stored in the file header. These bytes can be used in an application-specific manner. Set this to at least 4 bytes to enable support for saving file modification time.

$SPIFFS\_OBJ\_NAME\_LEN + SPIFFS\_META\_LENGTH$  should not exceed  $SPIFFS\_PAGE\_SIZE - 64$ .

**Default value:**

- 4

### CONFIG\_SPIFFS\_USE\_MTIME

Save file modification time

*Found in: [Component config](#) > [SPIFFS Configuration](#)*

If enabled, then the first 4 bytes of per-file metadata will be used to store file modification time (mtime), accessible through stat/fstat functions. Modification time is updated when the file is opened.

**Default value:**

- Yes (enabled)

### CONFIG\_SPIFFS\_MTIME\_WIDE\_64\_BITS

The time field occupies 64 bits in the image instead of 32 bits

*Found in: [Component config](#) > [SPIFFS Configuration](#)*

If this option is not set, the time field is 32 bits (up to 2106 year), otherwise it is 64 bits and make sure it matches SPIFFS\_META\_LENGTH. If the chip already has the spiffs image with the time field = 32 bits then this option cannot be applied in this case. Erase it first before using this option. To resolve the Y2K38 problem for the spiffs, use a toolchain with 64-bit time\_t support.

**Default value:**

- No (disabled) if [CONFIG\\_SPIFFS\\_META\\_LENGTH](#) >= 8

### Debug Configuration

 Contains:

- [CONFIG\\_SPIFFS\\_DBG](#)
- [CONFIG\\_SPIFFS\\_API\\_DBG](#)
- [CONFIG\\_SPIFFS\\_CACHE\\_DBG](#)
- [CONFIG\\_SPIFFS\\_CHECK\\_DBG](#)
- [CONFIG\\_SPIFFS\\_TEST\\_VISUALISATION](#)
- [CONFIG\\_SPIFFS\\_GC\\_DBG](#)

### CONFIG\_SPIFFS\_DBG

Enable general SPIFFS debug

*Found in: [Component config](#) > [SPIFFS Configuration](#) > [Debug Configuration](#)*

Enabling this option will print general debug messages to the console.

**Default value:**

- No (disabled)

### CONFIG\_SPIFFS\_API\_DBG

Enable SPIFFS API debug

*Found in: [Component config](#) > [SPIFFS Configuration](#) > [Debug Configuration](#)*

Enabling this option will print API debug messages to the console.

**Default value:**

- No (disabled)

### CONFIG\_SPIFFS\_GC\_DBG

Enable SPIFFS Garbage Cleaner debug

*Found in: [Component config](#) > [SPIFFS Configuration](#) > [Debug Configuration](#)*

Enabling this option will print GC debug messages to the console.

**Default value:**

- No (disabled)

### CONFIG\_SPIFFS\_CACHE\_DBG

Enable SPIFFS Cache debug

*Found in: [Component config](#) > [SPIFFS Configuration](#) > [Debug Configuration](#)*

Enabling this option will print cache debug messages to the console.

**Default value:**



- No (disabled)

### **CONFIG\_SPIFFS\_CHECK\_DBG**

Enable SPIFFS Filesystem Check debug

*Found in: [Component config](#) > [SPIFFS Configuration](#) > [Debug Configuration](#)*

Enabling this option will print Filesystem Check debug messages to the console.

**Default value:**

- No (disabled)

### **CONFIG\_SPIFFS\_TEST\_VISUALISATION**

Enable SPIFFS Filesystem Visualization

*Found in: [Component config](#) > [SPIFFS Configuration](#) > [Debug Configuration](#)*

Enable this option to enable SPIFFS\_vis function in the API.

**Default value:**

- No (disabled)

**TCP Transport** Contains:

- [Websocket](#)

**Websocket** Contains:

- [CONFIG\\_WS\\_TRANSPORT](#)

### **CONFIG\_WS\_TRANSPORT**

Enable Websocket Transport

*Found in: [Component config](#) > [TCP Transport](#) > [Websocket](#)*

Enable support for creating websocket transport.

**Default value:**

- Yes (enabled)

### **CONFIG\_WS\_BUFFER\_SIZE**

Websocket transport buffer size

*Found in: [Component config](#) > [TCP Transport](#) > [Websocket](#) > [CONFIG\\_WS\\_TRANSPORT](#)*

Size of the buffer used for constructing the HTTP Upgrade request during connect

**Default value:**

- 1024

### **CONFIG\_WS\_DYNAMIC\_BUFFER**

Using dynamic websocket transport buffer

*Found in: [Component config](#) > [TCP Transport](#) > [Websocket](#) > [CONFIG\\_WS\\_TRANSPORT](#)*

If enable this option, websocket transport buffer will be freed after connection succeed to save more heap.

**Default value:**

- No (disabled)

**Ultra Low Power (ULP) Co-processor** Contains:

- [CONFIG\\_ULP\\_ROM\\_PRINT\\_ENABLE](#)
- [CONFIG\\_ULP\\_COPROC\\_ENABLED](#)
- [ULP Debugging Options](#)
- [ULP RISC-V Settings](#)

### **CONFIG\_ULP\_COPROC\_ENABLED**

Enable Ultra Low Power (ULP) Co-processor

*Found in:* [Component config > Ultra Low Power \(ULP\) Co-processor](#)

Enable this feature if you plan to use the ULP Co-processor. Once this option is enabled, further ULP co-processor configuration will appear in the menu.

**Default value:**

- No (disabled) if `SOC_ULP_SUPPORTED || SOC_RISCV_COPROC_SUPPORTED || SOC_LP_CORE_SUPPORTED`

### **CONFIG\_ULP\_COPROC\_TYPE**

ULP Co-processor type

*Found in:* [Component config > Ultra Low Power \(ULP\) Co-processor > CONFIG\\_ULP\\_COPROC\\_ENABLED](#)

Choose the ULP Coprocessor type: ULP FSM (Finite State Machine) or ULP RISC-V.

Available options:

- ULP FSM (Finite State Machine) (`CONFIG_ULP_COPROC_TYPE_FSM`)
- ULP RISC-V (`CONFIG_ULP_COPROC_TYPE_RISCV`)
- LP core RISC-V (`CONFIG_ULP_COPROC_TYPE_LP_CORE`)

### **CONFIG\_ULP\_COPROC\_RESERVE\_MEM**

RTC slow memory reserved for coprocessor

*Found in:* [Component config > Ultra Low Power \(ULP\) Co-processor > CONFIG\\_ULP\\_COPROC\\_ENABLED](#)

Bytes of memory to reserve for ULP Co-processor firmware & data. Data is reserved at the beginning of RTC slow memory.

**Default value:**

- 4096 if `CONFIG_ULP_COPROC_ENABLED && (SOC_ULP_SUPPORTED || SOC_RISCV_COPROC_SUPPORTED || SOC_LP_CORE_SUPPORTED)`

**ULP RISC-V Settings** Contains:

- [CONFIG\\_ULP\\_RISCV\\_UART\\_BAUDRATE](#)
- [CONFIG\\_ULP\\_RISCV\\_INTERRUPT\\_ENABLE](#)
- [CONFIG\\_ULP\\_RISCV\\_I2C\\_RW\\_TIMEOUT](#)

**CONFIG\_ULP\_RISCV\_INTERRUPT\_ENABLE**

Enable ULP RISC-V interrupts

*Found in: Component config > Ultra Low Power (ULP) Co-processor > ULP RISC-V Settings*

Turn on this setting to enabled interrupts on the ULP RISC-V core.

**Default value:**

- No (disabled) if `CONFIG_ULP_COPROC_TYPE_RISCV` && (SOC\_ULP\_SUPPORTED || SOC\_RISCV\_COPROC\_SUPPORTED || SOC\_LP\_CORE\_SUPPORTED)

**CONFIG\_ULP\_RISCV\_UART\_BAUDRATE**

Baudrate used by the bitbanged ULP RISC-V UART driver

*Found in: Component config > Ultra Low Power (ULP) Co-processor > ULP RISC-V Settings*

The accuracy of the bitbanged UART driver is limited, it is not recommend to increase the value above 19200.

**Default value:**

- 9600 if `CONFIG_ULP_COPROC_TYPE_RISCV` && (SOC\_ULP\_SUPPORTED || SOC\_RISCV\_COPROC\_SUPPORTED || SOC\_LP\_CORE\_SUPPORTED)

**CONFIG\_ULP\_RISCV\_I2C\_RW\_TIMEOUT**

Set timeout for ULP RISC-V I2C transaction timeout in ticks.

*Found in: Component config > Ultra Low Power (ULP) Co-processor > ULP RISC-V Settings*

Set the ULP RISC-V I2C read/write timeout. Set this value to -1 if the ULP RISC-V I2C read and write APIs should wait forever. Please note that the tick rate of the ULP co-processor would be different than the OS tick rate of the main core and therefore can have different timeout value depending on which core the API is invoked on.

**Range:**

- from -1 to 4294967295 if `CONFIG_ULP_COPROC_TYPE_RISCV` && (SOC\_ULP\_SUPPORTED || SOC\_RISCV\_COPROC\_SUPPORTED || SOC\_LP\_CORE\_SUPPORTED)

**Default value:**

- 500 if `CONFIG_ULP_COPROC_TYPE_RISCV` && (SOC\_ULP\_SUPPORTED || SOC\_RISCV\_COPROC\_SUPPORTED || SOC\_LP\_CORE\_SUPPORTED)

**CONFIG\_ULP\_ROM\_PRINT\_ENABLE**

Enable print utilities from LP ROM

*Found in: Component config > Ultra Low Power (ULP) Co-processor*

Set this option to enable printf functionality from LP ROM. This option can help reduce the LP core binary size by not linking printf functionality from RAM code. Note: For LP ROM prints to work properly, make sure that the LP core boots from the LP ROM.

**Default value:**

- Yes (enabled) if `CONFIG_ULP_COPROC_TYPE_LP_CORE` && ESP\_ROM\_HAS\_LP\_ROM && (SOC\_ULP\_SUPPORTED || SOC\_RISCV\_COPROC\_SUPPORTED || SOC\_LP\_CORE\_SUPPORTED)

**ULP Debugging Options** Contains:

- `CONFIG_ULP_PANIC_OUTPUT_ENABLE`
- `CONFIG_ULP_HP_UART_CONSOLE_PRINT`

### CONFIG\_ULP\_PANIC\_OUTPUT\_ENABLE

Enable panic handler which outputs over LP UART

*Found in: Component config > Ultra Low Power (ULP) Co-processor > ULP Debugging Options*

Set this option to enable panic handler functionality. If this option is enabled then the LP Core will output a panic dump over LP UART, similar to what the main core does. Output depends on LP UART already being initialized and configured. Disabling this option will reduce the LP core binary size by not linking in panic handler functionality.

### CONFIG\_ULP\_HP\_UART\_CONSOLE\_PRINT

Route lp\_core\_printf to the console HP-UART

*Found in: Component config > Ultra Low Power (ULP) Co-processor > ULP Debugging Options*

Set this option to route lp\_core\_printf to the console HP-UART. This allows you to easily view print outputs from the LP core, without having to connect to the LP-UART. This option comes with the following limitations:

1. There is no mutual exclusion between the HP-Core and the LP-Core accessing the HP-UART, which means that if both cores are logging heavily the output strings might get mangled together. 2. The HP-UART can only work while the HP-Core is running, which means that if the HP-Core is in deep sleep, the LP-Core will not be able to print to the console HP-UART.

Due to these limitations it is only recommended to use this option for easy debugging. For more serious use-cases you should use the LP-UART.

**Unity unit testing library** Contains:

- *CONFIG\_UNITY\_ENABLE\_COLOR*
- *CONFIG\_UNITY\_ENABLE\_IDF\_TEST\_RUNNER*
- *CONFIG\_UNITY\_ENABLE\_FIXTURE*
- *CONFIG\_UNITY\_ENABLE\_BACKTRACE\_ON\_FAIL*
- *CONFIG\_UNITY\_ENABLE\_64BIT*
- *CONFIG\_UNITY\_ENABLE\_DOUBLE*
- *CONFIG\_UNITY\_ENABLE\_FLOAT*

### CONFIG\_UNITY\_ENABLE\_FLOAT

Support for float type

*Found in: Component config > Unity unit testing library*

If not set, assertions on float arguments will not be available.

**Default value:**

- Yes (enabled)

### CONFIG\_UNITY\_ENABLE\_DOUBLE

Support for double type

*Found in: Component config > Unity unit testing library*

If not set, assertions on double arguments will not be available.

**Default value:**

- Yes (enabled)

### CONFIG\_UNITY\_ENABLE\_64BIT

Support for 64-bit integer types

*Found in: [Component config](#) > [Unity unit testing library](#)*

If not set, assertions on 64-bit integer types will always fail. If this feature is enabled, take care not to pass pointers (which are 32 bit) to UNITY\_ASSERT\_EQUAL, as that will cause pointer-to-int-cast warnings.

**Default value:**

- No (disabled)

### CONFIG\_UNITY\_ENABLE\_COLOR

Colorize test output

*Found in: [Component config](#) > [Unity unit testing library](#)*

If set, Unity will colorize test results using console escape sequences.

**Default value:**

- No (disabled)

### CONFIG\_UNITY\_ENABLE\_IDF\_TEST\_RUNNER

Include ESP-IDF test registration/running helpers

*Found in: [Component config](#) > [Unity unit testing library](#)*

If set, then the following features will be available:

- TEST\_CASE macro which performs automatic registration of test functions
- Functions to run registered test functions: `unity_run_all_tests`, `unity_run_tests_with_filter`, `unity_run_single_test_by_name`.
- Interactive menu which lists test cases and allows choosing the tests to be run, available via `unity_run_menu` function.

Disable if a different test registration mechanism is used.

**Default value:**

- Yes (enabled)

### CONFIG\_UNITY\_ENABLE\_FIXTURE

Include Unity test fixture

*Found in: [Component config](#) > [Unity unit testing library](#)*

If set, `unity_fixture.h` header file and associated source files are part of the build. These provide an optional set of macros and functions to implement test groups.

**Default value:**

- No (disabled)

### CONFIG\_UNITY\_ENABLE\_BACKTRACE\_ON\_FAIL

Print a backtrace when a unit test fails

*Found in: [Component config](#) > [Unity unit testing library](#)*

If set, the unity framework will print the backtrace information before jumping back to the test menu. The jumping is usually occurs in assert functions such as `TEST_ASSERT`, `TEST_FAIL` etc.

**Default value:**

- No (disabled)

**USB-OTG** Contains:

- [CONFIG\\_USB\\_HOST\\_ENABLE\\_ENUM\\_FILTER\\_CALLBACK](#)
- [CONFIG\\_USB\\_HOST\\_HW\\_BUFFER\\_BIAS](#)
- [CONFIG\\_USB\\_HOST\\_CONTROL\\_TRANSFER\\_MAX\\_SIZE](#)
- *Root Hub configuration*
- [CONFIG\\_USB\\_HOST\\_EXT\\_HUB\\_SUPPORT](#)

**CONFIG\_USB\_HOST\_CONTROL\_TRANSFER\_MAX\_SIZE**

Largest size (in bytes) of transfers to/from default endpoints

*Found in: Component config > USB-OTG*

Each USB device attached is allocated a dedicated buffer for its OUT/IN transfers to/from the device's control endpoint. The maximum size of that buffer is determined by this option. The limited size of the transfer buffer have the following implications: - The maximum length of control transfers is limited - Device's with configuration descriptors larger than this limit cannot be supported

**Default value:**

- 256 if SOC\_USB\_OTG\_SUPPORTED

**CONFIG\_USB\_HOST\_HW\_BUFFER\_BIAS**

Hardware FIFO size biasing

*Found in: Component config > USB-OTG*

The underlying hardware has size adjustable FIFOs to cache USB packets on reception (IN) or for transmission (OUT). The size of these FIFOs will affect the largest MPS (maximum packet size) and the maximum number of packets that can be cached at any one time. The hardware contains the following FIFOs: RX (for all IN packets), Non-periodic TX (for Bulk and Control OUT packets), and Periodic TX (for Interrupt and Isochronous OUT packets). This configuration option allows biasing the FIFO sizes towards a particular use case, which may be necessary for devices that have endpoints with large MPS. The MPS limits for each biasing are listed below:

Balanced: - IN (all transfer types), 408 bytes - OUT non-periodic (Bulk/Control), 192 bytes (i.e., 3 x 64 byte packets) - OUT periodic (Interrupt/Isochronous), 192 bytes

Bias IN: - IN (all transfer types), 600 bytes - OUT non-periodic (Bulk/Control), 64 bytes (i.e., 1 x 64 byte packets) - OUT periodic (Interrupt/Isochronous), 128 bytes

Bias Periodic OUT: - IN (all transfer types), 128 bytes - OUT non-periodic (Bulk/Control), 64 bytes (i.e., 1 x 64 byte packets) - OUT periodic (Interrupt/Isochronous), 600 bytes

Available options:

- Balanced (CONFIG\_USB\_HOST\_HW\_BUFFER\_BIAS\_BALANCED)
- Bias IN (CONFIG\_USB\_HOST\_HW\_BUFFER\_BIAS\_IN)
- Periodic OUT (CONFIG\_USB\_HOST\_HW\_BUFFER\_BIAS\_PERIODIC\_OUT)

**Root Hub configuration** Contains:

- [CONFIG\\_USB\\_HOST\\_DEBOUNCE\\_DELAY\\_MS](#)
- [CONFIG\\_USB\\_HOST\\_RESET\\_HOLD\\_MS](#)
- [CONFIG\\_USB\\_HOST\\_RESET\\_RECOVERY\\_MS](#)
- [CONFIG\\_USB\\_HOST\\_SET\\_ADDR\\_RECOVERY\\_MS](#)

### CONFIG\_USB\_HOST\_DEBOUNCE\_DELAY\_MS

Debounce delay in ms

*Found in: [Component config](#) > [USB-OTG](#) > [Root Hub configuration](#)*

On connection of a USB device, the USB 2.0 specification requires a "debounce interval with a minimum duration of 100ms" to allow the connection to stabilize (see USB 2.0 chapter 7.1.7.3 for more details). During the debounce interval, no new connection/disconnection events are registered.

The default value is set to 250 ms to be safe.

**Default value:**

- 250 if SOC\_USB\_OTG\_SUPPORTED

### CONFIG\_USB\_HOST\_RESET\_HOLD\_MS

Reset hold in ms

*Found in: [Component config](#) > [USB-OTG](#) > [Root Hub configuration](#)*

The reset signaling can be generated on any Hub or Host Controller port by request from the USB System Software. The USB 2.0 specification requires that "the reset signaling must be driven for a minimum of 10ms" (see USB 2.0 chapter 7.1.7.5 for more details). After the reset, the hub port will transition to the Enabled state (refer to Section 11.5).

The default value is set to 30 ms to be safe.

**Default value:**

- 30 if SOC\_USB\_OTG\_SUPPORTED

### CONFIG\_USB\_HOST\_RESET\_RECOVERY\_MS

Reset recovery delay in ms

*Found in: [Component config](#) > [USB-OTG](#) > [Root Hub configuration](#)*

After a port stops driving the reset signal, the USB 2.0 specification requires that the "USB System Software guarantees a minimum of 10 ms for reset recovery" before the attached device is expected to respond to data transfers (see USB 2.0 chapter 7.1.7.3 for more details). The device may ignore any data transfers during the recovery interval.

The default value is set to 30 ms to be safe.

**Default value:**

- 30 if SOC\_USB\_OTG\_SUPPORTED

### CONFIG\_USB\_HOST\_SET\_ADDR\_RECOVERY\_MS

SetAddress() recovery time in ms

*Found in: [Component config](#) > [USB-OTG](#) > [Root Hub configuration](#)*

"After successful completion of the Status stage, the device is allowed a SetAddress() recovery interval of 2 ms. At the end of this interval, the device must be able to accept Setup packets addressed to the new address. Also, at the end of the recovery interval, the device must not respond to tokens sent to the old address (unless, of course, the old and new address is the same)." See USB 2.0 chapter 9.2.6.3 for more details.

The default value is set to 10 ms to be safe.

**Default value:**

- 10 if SOC\_USB\_OTG\_SUPPORTED

## CONFIG\_USB\_HOST\_ENABLE\_ENUM\_FILTER\_CALLBACK

Enable enumeration filter callback

*Found in:* [Component config](#) > [USB-OTG](#)

The enumeration filter callback is called before enumeration of each newly attached device. This callback allows users to control whether a device should be enumerated, and what configuration number to use when enumerating a device.

If enabled, the enumeration filter callback can be set via 'usb\_host\_config\_t' when calling 'usb\_host\_install()'.

### Default value:

- No (disabled) if SOC\_USB\_OTG\_SUPPORTED

## CONFIG\_USB\_HOST\_EXT\_HUB\_SUPPORT

Support USB HUB (Experimental)

*Found in:* [Component config](#) > [USB-OTG](#)

Feature is under development.

### Default value:

- No (disabled) if [CONFIG\\_IDF\\_EXPERIMENTAL\\_FEATURES](#) &&  
SOC\_USB\_OTG\_SUPPORTED

**Virtual file system** Contains:

- [CONFIG\\_VFS\\_SUPPORT\\_IO](#)

## CONFIG\_VFS\_SUPPORT\_IO

Provide basic I/O functions

*Found in:* [Component config](#) > [Virtual file system](#)

If enabled, the following functions are provided by the VFS component.

open, close, read, write, pread, pwrite, lseek, fstat, fsync, ioctl, fcntl

Filesystem drivers can then be registered to handle these functions for specific paths.

Disabling this option can save memory when the support for these functions is not required.

Note that the following functions can still be used with socket file descriptors when this option is disabled:

close, read, write, ioctl, fcntl.

### Default value:

- Yes (enabled)

## CONFIG\_VFS\_SUPPORT\_DIR

Provide directory related functions

*Found in:* [Component config](#) > [Virtual file system](#) > [CONFIG\\_VFS\\_SUPPORT\\_IO](#)

If enabled, the following functions are provided by the VFS component.

stat, link, unlink, rename, utime, access, truncate, rmdir, mkdir, opendir, closedir, readdir, readdir\_r, seekdir, telldir, rewinddir

Filesystem drivers can then be registered to handle these functions for specific paths.

Disabling this option can save memory when the support for these functions is not required.



**Default value:**

- Yes (enabled)

**CONFIG\_VFS\_SUPPORT\_SELECT**

Provide select function

*Found in: [Component config](#) > [Virtual file system](#) > [CONFIG\\_VFS\\_SUPPORT\\_IO](#)*

If enabled, select function is provided by the VFS component, and can be used on peripheral file descriptors (such as UART) and sockets at the same time.

If disabled, the default select implementation will be provided by LWIP for sockets only.

Disabling this option can reduce code size if support for "select" on UART file descriptors is not required.

**CONFIG\_VFS\_SUPPRESS\_SELECT\_DEBUG\_OUTPUT**

Suppress select() related debug outputs

*Found in: [Component config](#) > [Virtual file system](#) > [CONFIG\\_VFS\\_SUPPORT\\_IO](#) > [CONFIG\\_VFS\\_SUPPORT\\_SELECT](#)*

Select() related functions might produce an inconveniently lot of debug outputs when one sets the default log level to DEBUG or higher. It is possible to suppress these debug outputs by enabling this option.

**Default value:**

- Yes (enabled)

**CONFIG\_VFS\_SELECT\_IN\_RAM**

Make VFS driver select() callbacks IRAM-safe

*Found in: [Component config](#) > [Virtual file system](#) > [CONFIG\\_VFS\\_SUPPORT\\_IO](#) > [CONFIG\\_VFS\\_SUPPORT\\_SELECT](#)*

If enabled, VFS driver select() callback function will be placed in IRAM.

**Default value:**

- No (disabled)

**CONFIG\_VFS\_SUPPORT\_TERMIOS**

Provide termios.h functions

*Found in: [Component config](#) > [Virtual file system](#) > [CONFIG\\_VFS\\_SUPPORT\\_IO](#)*

Disabling this option can save memory when the support for termios.h is not required.

**Default value:**

- Yes (enabled)

**CONFIG\_VFS\_MAX\_COUNT**

Maximum Number of Virtual Filesystems

*Found in: [Component config](#) > [Virtual file system](#) > [CONFIG\\_VFS\\_SUPPORT\\_IO](#)*

Define maximum number of virtual filesystems that can be registered.

**Range:**

- from 1 to 20

**Default value:**

- 8

**Host File System I/O (Semihosting)** Contains:

- [CONFIG\\_VFS\\_SEMIHOSTFS\\_MAX\\_MOUNT\\_POINTS](#)

### **CONFIG\_VFS\_SEMIHOSTFS\_MAX\_MOUNT\_POINTS**

Host FS: Maximum number of the host filesystem mount points

*Found in: Component config > Virtual file system > CONFIG\_VFS\_SUPPORT\_IO > Host File System I/O (Semihosting)*

Define maximum number of host filesystem mount points.

**Default value:**

- 1

**Wear Levelling** Contains:

- [CONFIG\\_WL\\_SECTOR\\_MODE](#)
- [CONFIG\\_WL\\_SECTOR\\_SIZE](#)

### **CONFIG\_WL\_SECTOR\_SIZE**

Wear Levelling library sector size

*Found in: Component config > Wear Levelling*

Sector size used by wear levelling library. You can set default sector size or size that will fit to the flash device sector size.

With sector size set to 4096 bytes, wear levelling library is more efficient. However if FAT filesystem is used on top of wear levelling library, it will need more temporary storage: 4096 bytes for each mounted filesystem and 4096 bytes for each opened file.

With sector size set to 512 bytes, wear levelling library will perform more operations with flash memory, but less RAM will be used by FAT filesystem library (512 bytes for the filesystem and 512 bytes for each file opened).

Available options:

- 512 (CONFIG\_WL\_SECTOR\_SIZE\_512)
- 4096 (CONFIG\_WL\_SECTOR\_SIZE\_4096)

### **CONFIG\_WL\_SECTOR\_MODE**

Sector store mode

*Found in: Component config > Wear Levelling*

Specify the mode to store data into flash:

- In Performance mode a data will be stored to the RAM and then stored back to the flash. Compared to the Safety mode, this operation is faster, but if power will be lost when erase sector operation is in progress, then the data from complete flash device sector will be lost.
- In Safety mode data from complete flash device sector will be read from flash, modified, and then stored back to flash. Compared to the Performance mode, this operation is slower, but if power is lost during erase sector operation, then the data from full flash device sector will not be lost.

Available options:

- Performance (CONFIG\_WL\_SECTOR\_MODE\_PERF)
- Safety (CONFIG\_WL\_SECTOR\_MODE\_SAFE)

**Wi-Fi Provisioning Manager** Contains:

- `CONFIG_WIFI_PROV_BLE_BONDING`
- `CONFIG_WIFI_PROV_BLE_SEC_CONN`
- `CONFIG_WIFI_PROV_BLE_FORCE_ENCRYPTION`
- `CONFIG_WIFI_PROV_KEEP_BLE_ON_AFTER_PROV`
- `CONFIG_WIFI_PROV_SCAN_MAX_ENTRIES`
- `CONFIG_WIFI_PROV_AUTOSTOP_TIMEOUT`
- `CONFIG_WIFI_PROV_STA_SCAN_METHOD`

**CONFIG\_WIFI\_PROV\_SCAN\_MAX\_ENTRIES**

Max Wi-Fi Scan Result Entries

*Found in: Component config > Wi-Fi Provisioning Manager*

This sets the maximum number of entries of Wi-Fi scan results that will be kept by the provisioning manager

**Range:**

- from 1 to 255

**Default value:**

- 16

**CONFIG\_WIFI\_PROV\_AUTOSTOP\_TIMEOUT**

Provisioning auto-stop timeout

*Found in: Component config > Wi-Fi Provisioning Manager*

Time (in seconds) after which the Wi-Fi provisioning manager will auto-stop after connecting to a Wi-Fi network successfully.

**Range:**

- from 5 to 600

**Default value:**

- 30

**CONFIG\_WIFI\_PROV\_BLE\_BONDING**

Enable BLE bonding

*Found in: Component config > Wi-Fi Provisioning Manager*

This option is applicable only when provisioning transport is BLE.

**CONFIG\_WIFI\_PROV\_BLE\_SEC\_CONN**

Enable BLE Secure connection flag

*Found in: Component config > Wi-Fi Provisioning Manager*

Used to enable Secure connection support when provisioning transport is BLE.

**Default value:**

- Yes (enabled) if `CONFIG_BT_NIMBLE_ENABLED`

**CONFIG\_WIFI\_PROV\_BLE\_FORCE\_ENCRYPTION**

Force Link Encryption during characteristic Read / Write

*Found in: Component config > Wi-Fi Provisioning Manager*

Used to enforce link encryption when attempting to read / write characteristic

### CONFIG\_WIFI\_PROV\_KEEP\_BLE\_ON\_AFTER\_PROV

Keep BT on after provisioning is done

Found in: *Component config > Wi-Fi Provisioning Manager*

### CONFIG\_WIFI\_PROV\_DISCONNECT\_AFTER\_PROV

Terminate connection after provisioning is done

Found in: *Component config > Wi-Fi Provisioning Manager > CONFIG\_WIFI\_PROV\_KEEP\_BLE\_ON\_AFTER\_PROV*

**Default value:**

- Yes (enabled) if *CONFIG\_WIFI\_PROV\_KEEP\_BLE\_ON\_AFTER\_PROV*

### CONFIG\_WIFI\_PROV\_STA\_SCAN\_METHOD

Wifi Provisioning Scan Method

Found in: *Component config > Wi-Fi Provisioning Manager*

Available options:

- All Channel Scan (*CONFIG\_WIFI\_PROV\_STA\_ALL\_CHANNEL\_SCAN*)  
Scan will end after scanning the entire channel. This option is useful in Mesh WiFi Systems.
- Fast Scan (*CONFIG\_WIFI\_PROV\_STA\_FAST\_SCAN*)  
Scan will end after an AP matching with the SSID has been detected.

### CONFIG\_IDF\_EXPERIMENTAL\_FEATURES

Make experimental features visible

Found in:

By enabling this option, ESP-IDF experimental feature options will be visible.

Note you should still enable a certain experimental feature option to use it, and you should read the corresponding risk warning and known issue list carefully.

Current experimental feature list:

- *CONFIG\_ESPTOOLPY\_FLASHFREQ\_120M* && *CONFIG\_ESPTOOLPY\_FLASH\_SAMPLE\_MODE\_DTR*
- *CONFIG\_SPIRAM\_SPEED\_120M* && *CONFIG\_SPIRAM\_MODE\_OCT*
- *CONFIG\_BOOTLOADER\_CACHE\_32BIT\_ADDR\_QUAD\_FLASH*
- *CONFIG\_MBEDTLS\_USE\_CRYPTOROM\_IMPL*
- *CONFIG\_ESP\_WIFI\_EAP\_TLS1\_3*
- *CONFIG\_ESP\_WIFI\_ENABLE\_ROAMING\_APP*

**Default value:**

- No (disabled)

### Deprecated options and their replacements

- *CONFIG\_A2DP\_ENABLE* (*CONFIG\_BT\_A2DP\_ENABLE*)
- *CONFIG\_A2D\_INITIAL\_TRACE\_LEVEL* (*CONFIG\_BT\_LOG\_A2D\_TRACE\_LEVEL*)
  - *CONFIG\_A2D\_TRACE\_LEVEL\_NONE*
  - *CONFIG\_A2D\_TRACE\_LEVEL\_ERROR*
  - *CONFIG\_A2D\_TRACE\_LEVEL\_WARNING*
  - *CONFIG\_A2D\_TRACE\_LEVEL\_API*

- CONFIG\_A2D\_TRACE\_LEVEL\_EVENT
- CONFIG\_A2D\_TRACE\_LEVEL\_DEBUG
- CONFIG\_A2D\_TRACE\_LEVEL\_VERBOSE
- CONFIG\_ADC2\_DISABLE\_DAC ([CONFIG\\_ADC\\_DISABLE\\_DAC](#))
- **CONFIG\_APPL\_INITIAL\_TRACE\_LEVEL** ([CONFIG\\_BT\\_LOG\\_APPL\\_TRACE\\_LEVEL](#))
  - CONFIG\_APPL\_TRACE\_LEVEL\_NONE
  - CONFIG\_APPL\_TRACE\_LEVEL\_ERROR
  - CONFIG\_APPL\_TRACE\_LEVEL\_WARNING
  - CONFIG\_APPL\_TRACE\_LEVEL\_API
  - CONFIG\_APPL\_TRACE\_LEVEL\_EVENT
  - CONFIG\_APPL\_TRACE\_LEVEL\_DEBUG
  - CONFIG\_APPL\_TRACE\_LEVEL\_VERBOSE
- CONFIG\_APP\_ANTI\_ROLLBACK ([CONFIG\\_BOOTLOADER\\_APP\\_ANTI\\_ROLLBACK](#))
- CONFIG\_APP\_ROLLBACK\_ENABLE ([CONFIG\\_BOOTLOADER\\_APP\\_ROLLBACK\\_ENABLE](#))
- CONFIG\_APP\_SECURE\_VERSION ([CONFIG\\_BOOTLOADER\\_APP\\_SECURE\\_VERSION](#))
- CONFIG\_APP\_SECURE\_VERSION\_SIZE\_EFUSE\_FIELD ([CONFIG\\_BOOTLOADER\\_APP\\_SEC\\_VER\\_SIZE\\_EFUSE\\_FIELD](#))
- **CONFIG\_AVCT\_INITIAL\_TRACE\_LEVEL** ([CONFIG\\_BT\\_LOG\\_AVCT\\_TRACE\\_LEVEL](#))
  - CONFIG\_AVCT\_TRACE\_LEVEL\_NONE
  - CONFIG\_AVCT\_TRACE\_LEVEL\_ERROR
  - CONFIG\_AVCT\_TRACE\_LEVEL\_WARNING
  - CONFIG\_AVCT\_TRACE\_LEVEL\_API
  - CONFIG\_AVCT\_TRACE\_LEVEL\_EVENT
  - CONFIG\_AVCT\_TRACE\_LEVEL\_DEBUG
  - CONFIG\_AVCT\_TRACE\_LEVEL\_VERBOSE
- **CONFIG\_AVDT\_INITIAL\_TRACE\_LEVEL** ([CONFIG\\_BT\\_LOG\\_AVDT\\_TRACE\\_LEVEL](#))
  - CONFIG\_AVDT\_TRACE\_LEVEL\_NONE
  - CONFIG\_AVDT\_TRACE\_LEVEL\_ERROR
  - CONFIG\_AVDT\_TRACE\_LEVEL\_WARNING
  - CONFIG\_AVDT\_TRACE\_LEVEL\_API
  - CONFIG\_AVDT\_TRACE\_LEVEL\_EVENT
  - CONFIG\_AVDT\_TRACE\_LEVEL\_DEBUG
  - CONFIG\_AVDT\_TRACE\_LEVEL\_VERBOSE
- **CONFIG\_AVRC\_INITIAL\_TRACE\_LEVEL** ([CONFIG\\_BT\\_LOG\\_AVRC\\_TRACE\\_LEVEL](#))
  - CONFIG\_AVRC\_TRACE\_LEVEL\_NONE
  - CONFIG\_AVRC\_TRACE\_LEVEL\_ERROR
  - CONFIG\_AVRC\_TRACE\_LEVEL\_WARNING
  - CONFIG\_AVRC\_TRACE\_LEVEL\_API
  - CONFIG\_AVRC\_TRACE\_LEVEL\_EVENT
  - CONFIG\_AVRC\_TRACE\_LEVEL\_DEBUG
  - CONFIG\_AVRC\_TRACE\_LEVEL\_VERBOSE
- CONFIG\_BLE\_ACTIVE\_SCAN\_REPORT\_ADV\_SCAN\_RSP\_INDIVIDUALLY ([CONFIG\\_BT\\_BLE\\_ACT\\_SCAN\\_REP\\_ADV\\_SCAN](#))
- CONFIG\_BLE\_ESTABLISH\_LINK\_CONNECTION\_TIMEOUT ([CONFIG\\_BT\\_BLE\\_ESTAB\\_LINK\\_CONN\\_TOUT](#))
- CONFIG\_BLE\_HOST\_QUEUE\_CONGESTION\_CHECK ([CONFIG\\_BT\\_BLE\\_HOST\\_QUEUE\\_CONG\\_CHECK](#))
- CONFIG\_BLE\_MESH\_GATT\_PROXY ([CONFIG\\_BLE\\_MESH\\_GATT\\_PROXY\\_SERVER](#))
- CONFIG\_BLE\_SMP\_ENABLE ([CONFIG\\_BT\\_BLE\\_SMP\\_ENABLE](#))
- CONFIG\_BLUEDROID\_MEM\_DEBUG ([CONFIG\\_BT\\_BLUEDROID\\_MEM\\_DEBUG](#))
- **CONFIG\_BLUEDROID\_PINNED\_TO\_CORE\_CHOICE** ([CONFIG\\_BT\\_BLUEDROID\\_PINNED\\_TO\\_CORE\\_CHOICE](#))
  - CONFIG\_BLUEDROID\_PINNED\_TO\_CORE\_0
  - CONFIG\_BLUEDROID\_PINNED\_TO\_CORE\_1
- **CONFIG\_BLUFI\_INITIAL\_TRACE\_LEVEL** ([CONFIG\\_BT\\_LOG\\_BLUFI\\_TRACE\\_LEVEL](#))
  - CONFIG\_BLUFI\_TRACE\_LEVEL\_NONE
  - CONFIG\_BLUFI\_TRACE\_LEVEL\_ERROR
  - CONFIG\_BLUFI\_TRACE\_LEVEL\_WARNING
  - CONFIG\_BLUFI\_TRACE\_LEVEL\_API
  - CONFIG\_BLUFI\_TRACE\_LEVEL\_EVENT

- CONFIG\_BLUFI\_TRACE\_LEVEL\_DEBUG
- CONFIG\_BLUFI\_TRACE\_LEVEL\_VERBOSE
- CONFIG\_BNEP\_INITIAL\_TRACE\_LEVEL (*CONFIG\_BT\_LOG\_BNEP\_TRACE\_LEVEL*)
- CONFIG\_BROWNOUT\_DET (*CONFIG\_ESP\_BROWNOUT\_DET*)
- **CONFIG\_BROWNOUT\_DET\_LVL\_SEL** (*CONFIG\_ESP\_BROWNOUT\_DET\_LVL\_SEL*)
  - CONFIG\_BROWNOUT\_DET\_LVL\_SEL\_7
  - CONFIG\_BROWNOUT\_DET\_LVL\_SEL\_6
  - CONFIG\_BROWNOUT\_DET\_LVL\_SEL\_5
  - CONFIG\_BROWNOUT\_DET\_LVL\_SEL\_4
  - CONFIG\_BROWNOUT\_DET\_LVL\_SEL\_3
  - CONFIG\_BROWNOUT\_DET\_LVL\_SEL\_2
  - CONFIG\_BROWNOUT\_DET\_LVL\_SEL\_1
  - CONFIG\_BROWNOUT\_DET\_LVL\_SEL\_0
- **CONFIG\_BTC\_INITIAL\_TRACE\_LEVEL** (*CONFIG\_BT\_LOG\_BTC\_TRACE\_LEVEL*)
  - CONFIG\_BTC\_TRACE\_LEVEL\_NONE
  - CONFIG\_BTC\_TRACE\_LEVEL\_ERROR
  - CONFIG\_BTC\_TRACE\_LEVEL\_WARNING
  - CONFIG\_BTC\_TRACE\_LEVEL\_API
  - CONFIG\_BTC\_TRACE\_LEVEL\_EVENT
  - CONFIG\_BTC\_TRACE\_LEVEL\_DEBUG
  - CONFIG\_BTC\_TRACE\_LEVEL\_VERBOSE
- CONFIG\_BTC\_TASK\_STACK\_SIZE (*CONFIG\_BT\_BTC\_TASK\_STACK\_SIZE*)
- **CONFIG\_BTH\_LOG\_SDP\_INITIAL\_TRACE\_LEVEL** (*CONFIG\_BT\_LOG\_SDP\_TRACE\_LEVEL*)
  - CONFIG\_SDP\_TRACE\_LEVEL\_NONE
  - CONFIG\_SDP\_TRACE\_LEVEL\_ERROR
  - CONFIG\_SDP\_TRACE\_LEVEL\_WARNING
  - CONFIG\_SDP\_TRACE\_LEVEL\_API
  - CONFIG\_SDP\_TRACE\_LEVEL\_EVENT
  - CONFIG\_SDP\_TRACE\_LEVEL\_DEBUG
  - CONFIG\_SDP\_TRACE\_LEVEL\_VERBOSE
- **CONFIG\_BTIF\_INITIAL\_TRACE\_LEVEL** (*CONFIG\_BT\_LOG\_BTIF\_TRACE\_LEVEL*)
  - CONFIG\_BTIF\_TRACE\_LEVEL\_NONE
  - CONFIG\_BTIF\_TRACE\_LEVEL\_ERROR
  - CONFIG\_BTIF\_TRACE\_LEVEL\_WARNING
  - CONFIG\_BTIF\_TRACE\_LEVEL\_API
  - CONFIG\_BTIF\_TRACE\_LEVEL\_EVENT
  - CONFIG\_BTIF\_TRACE\_LEVEL\_DEBUG
  - CONFIG\_BTIF\_TRACE\_LEVEL\_VERBOSE
- **CONFIG\_BTM\_INITIAL\_TRACE\_LEVEL** (*CONFIG\_BT\_LOG\_BTM\_TRACE\_LEVEL*)
  - CONFIG\_BTM\_TRACE\_LEVEL\_NONE
  - CONFIG\_BTM\_TRACE\_LEVEL\_ERROR
  - CONFIG\_BTM\_TRACE\_LEVEL\_WARNING
  - CONFIG\_BTM\_TRACE\_LEVEL\_API
  - CONFIG\_BTM\_TRACE\_LEVEL\_EVENT
  - CONFIG\_BTM\_TRACE\_LEVEL\_DEBUG
  - CONFIG\_BTM\_TRACE\_LEVEL\_VERBOSE
- CONFIG\_BTU\_TASK\_STACK\_SIZE (*CONFIG\_BT\_BTU\_TASK\_STACK\_SIZE*)
- CONFIG\_BT\_NIMBLE\_ACL\_BUF\_COUNT (*CONFIG\_BT\_NIMBLE\_TRANSPORT\_ACL\_FROM\_LL\_COUNT*)
- CONFIG\_BT\_NIMBLE\_ACL\_BUF\_SIZE (*CONFIG\_BT\_NIMBLE\_TRANSPORT\_ACL\_SIZE*)
- CONFIG\_BT\_NIMBLE\_HCI\_EVT\_BUF\_SIZE (*CONFIG\_BT\_NIMBLE\_TRANSPORT\_EVT\_SIZE*)
- CONFIG\_BT\_NIMBLE\_HCI\_EVT\_HI\_BUF\_COUNT (*CONFIG\_BT\_NIMBLE\_TRANSPORT\_EVT\_COUNT*)
- CONFIG\_BT\_NIMBLE\_HCI\_EVT\_LO\_BUF\_COUNT (*CONFIG\_BT\_NIMBLE\_TRANSPORT\_EVT\_DISCARD\_COUNT*)
- CONFIG\_BT\_NIMBLE\_MSYS1\_BLOCK\_COUNT (*CONFIG\_BT\_NIMBLE\_MSYS\_1\_BLOCK\_COUNT*)
- CONFIG\_BT\_NIMBLE\_SM\_SC\_LVL (*CONFIG\_BT\_NIMBLE\_SM\_LVL*)
- CONFIG\_BT\_NIMBLE\_TASK\_STACK\_SIZE (*CONFIG\_BT\_NIMBLE\_HOST\_TASK\_STACK\_SIZE*)
- CONFIG\_CLASSIC\_BT\_ENABLED (*CONFIG\_BT\_CLASSIC\_ENABLED*)
- **CONFIG\_CONSOLE\_UART** (*CONFIG\_ESP\_CONSOLE\_UART*)
  - CONFIG\_CONSOLE\_UART\_DEFAULT



- CONFIG\_CONSOLE\_UART\_CUSTOM
- CONFIG\_CONSOLE\_UART\_NONE, CONFIG\_ESP\_CONSOLE\_UART\_NONE
- CONFIG\_CONSOLE\_UART\_BAUDRATE ([CONFIG\\_ESP\\_CONSOLE\\_UART\\_BAUDRATE](#))
- **CONFIG\_CONSOLE\_UART\_NUM** ([CONFIG\\_ESP\\_CONSOLE\\_UART\\_NUM](#))
  - CONFIG\_CONSOLE\_UART\_CUSTOM\_NUM\_0
  - CONFIG\_CONSOLE\_UART\_CUSTOM\_NUM\_1
- CONFIG\_CONSOLE\_UART\_RX\_GPIO ([CONFIG\\_ESP\\_CONSOLE\\_UART\\_RX\\_GPIO](#))
- CONFIG\_CONSOLE\_UART\_TX\_GPIO ([CONFIG\\_ESP\\_CONSOLE\\_UART\\_TX\\_GPIO](#))
- CONFIG\_CXX\_EXCEPTIONS ([CONFIG\\_COMPILER\\_CXX\\_EXCEPTIONS](#))
- CONFIG\_CXX\_EXCEPTIONS\_EMG\_POOL\_SIZE ([CONFIG\\_COMPILER\\_CXX\\_EXCEPTIONS\\_EMG\\_POOL\\_SIZE](#))
- CONFIG\_EFUSE\_SECURE\_VERSION\_EMULATE ([CONFIG\\_BOOTLOADER\\_EFUSE\\_SECURE\\_VERSION\\_EMULATE](#))
- CONFIG\_ENABLE\_STATIC\_TASK\_CLEAN\_UP\_HOOK ([CONFIG\\_FREERTOS\\_ENABLE\\_STATIC\\_TASK\\_CLEAN\\_UP](#))
- CONFIG\_ESP32\_APPTRACE\_ONPANIC\_HOST\_FLUSH\_TMO ([CONFIG\\_APPTRACE\\_ONPANIC\\_HOST\\_FLUSH\\_TMO](#))
- CONFIG\_ESP32\_APPTRACE\_PENDING\_DATA\_SIZE\_MAX ([CONFIG\\_APPTRACE\\_PENDING\\_DATA\\_SIZE\\_MAX](#))
- CONFIG\_ESP32\_APPTRACE\_POSTMORTEM\_FLUSH\_TRAX\_THRESH ([CONFIG\\_APPTRACE\\_POSTMORTEM\\_FLUSH\\_THRESH](#))
- **CONFIG\_ESP32\_CORE\_DUMP\_DECODE** ([CONFIG\\_ESP\\_COREDUMP\\_DECODE](#))
  - CONFIG\_ESP32\_CORE\_DUMP\_DECODE\_INFO
  - CONFIG\_ESP32\_CORE\_DUMP\_DECODE\_DISABLE
- CONFIG\_ESP32\_CORE\_DUMP\_MAX\_TASKS\_NUM ([CONFIG\\_ESP\\_COREDUMP\\_MAX\\_TASKS\\_NUM](#))
- CONFIG\_ESP32\_CORE\_DUMP\_STACK\_SIZE ([CONFIG\\_ESP\\_COREDUMP\\_STACK\\_SIZE](#))
- CONFIG\_ESP32\_CORE\_DUMP\_UART\_DELAY ([CONFIG\\_ESP\\_COREDUMP\\_UART\\_DELAY](#))
- CONFIG\_ESP32\_DEBUG\_STUBS\_ENABLE ([CONFIG\\_ESP\\_DEBUG\\_STUBS\\_ENABLE](#))
- CONFIG\_ESP32\_GCOV\_ENABLE ([CONFIG\\_APPTRACE\\_GCOV\\_ENABLE](#))
- CONFIG\_ESP32\_PHY\_CALIBRATION\_AND\_DATA\_STORAGE ([CONFIG\\_ESP\\_PHY\\_CALIBRATION\\_AND\\_DATA\\_STORAGE](#))
- CONFIG\_ESP32\_PHY\_DEFAULT\_INIT\_IF\_INVALID ([CONFIG\\_ESP\\_PHY\\_DEFAULT\\_INIT\\_IF\\_INVALID](#))
- CONFIG\_ESP32\_PHY\_INIT\_DATA\_ERROR ([CONFIG\\_ESP\\_PHY\\_INIT\\_DATA\\_ERROR](#))
- CONFIG\_ESP32\_PHY\_INIT\_DATA\_IN\_PARTITION ([CONFIG\\_ESP\\_PHY\\_INIT\\_DATA\\_IN\\_PARTITION](#))
- CONFIG\_ESP32\_PHY\_MAC\_BB\_PD ([CONFIG\\_ESP\\_PHY\\_MAC\\_BB\\_PD](#))
- CONFIG\_ESP32\_PHY\_MAX\_WIFI\_TX\_POWER ([CONFIG\\_ESP\\_PHY\\_MAX\\_WIFI\\_TX\\_POWER](#))
- CONFIG\_ESP32\_PTHREAD\_STACK\_MIN ([CONFIG\\_PTHREAD\\_STACK\\_MIN](#))
- **CONFIG\_ESP32\_PTHREAD\_TASK\_CORE\_DEFAULT** ([CONFIG\\_PTHREAD\\_TASK\\_CORE\\_DEFAULT](#))
  - CONFIG\_ESP32\_DEFAULT\_PTHREAD\_CORE\_NO\_AFFINITY
  - CONFIG\_ESP32\_DEFAULT\_PTHREAD\_CORE\_0
  - CONFIG\_ESP32\_DEFAULT\_PTHREAD\_CORE\_1
- CONFIG\_ESP32\_PTHREAD\_TASK\_NAME\_DEFAULT ([CONFIG\\_PTHREAD\\_TASK\\_NAME\\_DEFAULT](#))
- CONFIG\_ESP32\_PTHREAD\_TASK\_PRIO\_DEFAULT ([CONFIG\\_PTHREAD\\_TASK\\_PRIO\\_DEFAULT](#))
- CONFIG\_ESP32\_PTHREAD\_TASK\_STACK\_SIZE\_DEFAULT ([CONFIG\\_PTHREAD\\_TASK\\_STACK\\_SIZE\\_DEFAULT](#))
- CONFIG\_ESP32\_REDUCE\_PHY\_TX\_POWER ([CONFIG\\_ESP\\_PHY\\_REDUCE\\_TX\\_POWER](#))
- CONFIG\_ESP32\_RTC\_XTAL\_BOOTSTRAP\_CYCLES ([CONFIG\\_ESP\\_SYSTEM\\_RTC\\_EXT\\_XTAL\\_BOOTSTRAP\\_CYCLES](#))
- CONFIG\_ESP32\_SUPPORT\_MULTIPLE\_PHY\_INIT\_DATA\_BIN ([CONFIG\\_ESP\\_PHY\\_MULTIPLE\\_INIT\\_DATA\\_BIN](#))
- CONFIG\_ESP32\_WIFI\_AMPDU\_RX\_ENABLED ([CONFIG\\_ESP\\_WIFI\\_AMPDU\\_RX\\_ENABLED](#))
- CONFIG\_ESP32\_WIFI\_AMPDU\_TX\_ENABLED ([CONFIG\\_ESP\\_WIFI\\_AMPDU\\_TX\\_ENABLED](#))
- CONFIG\_ESP32\_WIFI\_AMSDU\_TX\_ENABLED ([CONFIG\\_ESP\\_WIFI\\_AMSDU\\_TX\\_ENABLED](#))
- CONFIG\_ESP32\_WIFI\_CACHE\_TX\_BUFFER\_NUM ([CONFIG\\_ESP\\_WIFI\\_CACHE\\_TX\\_BUFFER\\_NUM](#))
- CONFIG\_ESP32\_WIFI\_CSI\_ENABLED ([CONFIG\\_ESP\\_WIFI\\_CSI\\_ENABLED](#))
- CONFIG\_ESP32\_WIFI\_DYNAMIC\_RX\_BUFFER\_NUM ([CONFIG\\_ESP\\_WIFI\\_DYNAMIC\\_RX\\_BUFFER\\_NUM](#))
- CONFIG\_ESP32\_WIFI\_DYNAMIC\_TX\_BUFFER\_NUM ([CONFIG\\_ESP\\_WIFI\\_DYNAMIC\\_TX\\_BUFFER\\_NUM](#))
- CONFIG\_ESP32\_WIFI\_ENABLE\_WPA3\_OWE\_STA ([CONFIG\\_ESP\\_WIFI\\_ENABLE\\_WPA3\\_OWE\\_STA](#))
- CONFIG\_ESP32\_WIFI\_ENABLE\_WPA3\_SAE ([CONFIG\\_ESP\\_WIFI\\_ENABLE\\_WPA3\\_SAE](#))
- CONFIG\_ESP32\_WIFI\_IRAM\_OPT ([CONFIG\\_ESP\\_WIFI\\_IRAM\\_OPT](#))
- CONFIG\_ESP32\_WIFI\_MGMT\_SBUF\_NUM ([CONFIG\\_ESP\\_WIFI\\_MGMT\\_SBUF\\_NUM](#))
- CONFIG\_ESP32\_WIFI\_NVS\_ENABLED ([CONFIG\\_ESP\\_WIFI\\_NVS\\_ENABLED](#))
- CONFIG\_ESP32\_WIFI\_RX\_BA\_WIN ([CONFIG\\_ESP\\_WIFI\\_RX\\_BA\\_WIN](#))

- `CONFIG_ESP32_WIFI_RX_IRAM_OPT` ([CONFIG\\_ESP\\_WIFI\\_RX\\_IRAM\\_OPT](#))
- `CONFIG_ESP32_WIFI_SOFTAP_BEACON_MAX_LEN` ([CONFIG\\_ESP\\_WIFI\\_SOFTAP\\_BEACON\\_MAX\\_LEN](#))
- `CONFIG_ESP32_WIFI_STATIC_RX_BUFFER_NUM` ([CONFIG\\_ESP\\_WIFI\\_STATIC\\_RX\\_BUFFER\\_NUM](#))
- `CONFIG_ESP32_WIFI_STATIC_TX_BUFFER_NUM` ([CONFIG\\_ESP\\_WIFI\\_STATIC\\_TX\\_BUFFER\\_NUM](#))
- `CONFIG_ESP32_WIFI_SW_COEXIST_ENABLE` ([CONFIG\\_ESP\\_COEX\\_SW\\_COEXIST\\_ENABLE](#))
- **`CONFIG_ESP32_WIFI_TASK_CORE_ID`** ([CONFIG\\_ESP\\_WIFI\\_TASK\\_CORE\\_ID](#))
  - `CONFIG_ESP32_WIFI_TASK_PINNED_TO_CORE_0`
  - `CONFIG_ESP32_WIFI_TASK_PINNED_TO_CORE_1`
- `CONFIG_ESP32_WIFI_TX_BA_WIN` ([CONFIG\\_ESP\\_WIFI\\_TX\\_BA\\_WIN](#))
- **`CONFIG_ESP32_WIFI_TX_BUFFER`** ([CONFIG\\_ESP\\_WIFI\\_TX\\_BUFFER](#))
  - `CONFIG_ESP32_WIFI_STATIC_TX_BUFFER`
  - `CONFIG_ESP32_WIFI_DYNAMIC_TX_BUFFER`
- `CONFIG_ESP_GRATUITOUS_ARP` ([CONFIG\\_LWIP\\_ESP\\_GRATUITOUS\\_ARP](#))
- `CONFIG_ESP_SYSTEM_PD_FLASH` ([CONFIG\\_ESP\\_SLEEP\\_POWER\\_DOWN\\_FLASH](#))
- `CONFIG_ESP_SYSTEM_PM_POWER_DOWN_CPU` ([CONFIG\\_PM\\_POWER\\_DOWN\\_CPU\\_IN\\_LIGHT\\_SLEEP](#))
- `CONFIG_ESP_TASK_WDT` ([CONFIG\\_ESP\\_TASK\\_WDT\\_INIT](#))
- `CONFIG_ESP_WIFI_EXTERNAL_COEXIST_ENABLE` ([CONFIG\\_ESP\\_COEX\\_EXTERNAL\\_COEXIST\\_ENABLE](#))
- `CONFIG_ESP_WIFI_SW_COEXIST_ENABLE` ([CONFIG\\_ESP\\_COEX\\_SW\\_COEXIST\\_ENABLE](#))
- `CONFIG_EVENT_LOOP_PROFILING` ([CONFIG\\_ESP\\_EVENT\\_LOOP\\_PROFILING](#))
- `CONFIG_EXTERNAL_COEX_ENABLE` ([CONFIG\\_ESP\\_COEX\\_EXTERNAL\\_COEXIST\\_ENABLE](#))
- `CONFIG_FLASH_ENCRYPTION_ENABLED` ([CONFIG\\_SECURE\\_FLASH\\_ENC\\_ENABLED](#))
- `CONFIG_FLASH_ENCRYPTION_UART_BOOTLOADER_ALLOW_CACHE` ([CONFIG\\_SECURE\\_FLASH\\_UART\\_BOOTLOADER\\_ALLOW\\_CACHE](#))
- `CONFIG_FLASH_ENCRYPTION_UART_BOOTLOADER_ALLOW_ENCRYPT` ([CONFIG\\_SECURE\\_FLASH\\_UART\\_BOOTLOADER\\_ALLOW\\_ENC](#))
- **`CONFIG_GAP_INITIAL_TRACE_LEVEL`** ([CONFIG\\_BT\\_LOG\\_GAP\\_TRACE\\_LEVEL](#))
  - `CONFIG_GAP_TRACE_LEVEL_NONE`
  - `CONFIG_GAP_TRACE_LEVEL_ERROR`
  - `CONFIG_GAP_TRACE_LEVEL_WARNING`
  - `CONFIG_GAP_TRACE_LEVEL_API`
  - `CONFIG_GAP_TRACE_LEVEL_EVENT`
  - `CONFIG_GAP_TRACE_LEVEL_DEBUG`
  - `CONFIG_GAP_TRACE_LEVEL_VERBOSE`
- `CONFIG_GARP_TMR_INTERVAL` ([CONFIG\\_LWIP\\_GARP\\_TMR\\_INTERVAL](#))
- `CONFIG_GATTC_CACHE_NVS_FLASH` ([CONFIG\\_BT\\_GATTC\\_CACHE\\_NVS\\_FLASH](#))
- `CONFIG_GATTC_ENABLE` ([CONFIG\\_BT\\_GATTC\\_ENABLE](#))
- `CONFIG_GATTS_ENABLE` ([CONFIG\\_BT\\_GATTS\\_ENABLE](#))
- **`CONFIG_GATTS_SEND_SERVICE_CHANGE_MODE`** ([CONFIG\\_BT\\_GATTS\\_SEND\\_SERVICE\\_CHANGE\\_MODE](#))
  - `CONFIG_GATTS_SEND_SERVICE_CHANGE_MANUAL`
  - `CONFIG_GATTS_SEND_SERVICE_CHANGE_AUTO`
- **`CONFIG_GATT_INITIAL_TRACE_LEVEL`** ([CONFIG\\_BT\\_LOG\\_GATT\\_TRACE\\_LEVEL](#))
  - `CONFIG_GATT_TRACE_LEVEL_NONE`
  - `CONFIG_GATT_TRACE_LEVEL_ERROR`
  - `CONFIG_GATT_TRACE_LEVEL_WARNING`
  - `CONFIG_GATT_TRACE_LEVEL_API`
  - `CONFIG_GATT_TRACE_LEVEL_EVENT`
  - `CONFIG_GATT_TRACE_LEVEL_DEBUG`
  - `CONFIG_GATT_TRACE_LEVEL_VERBOSE`
- `CONFIG_GDBSTUB_MAX_TASKS` ([CONFIG\\_ESP\\_GDBSTUB\\_MAX\\_TASKS](#))
- `CONFIG_GDBSTUB_SUPPORT_TASKS` ([CONFIG\\_ESP\\_GDBSTUB\\_SUPPORT\\_TASKS](#))
- **`CONFIG_HCI_INITIAL_TRACE_LEVEL`** ([CONFIG\\_BT\\_LOG\\_HCI\\_TRACE\\_LEVEL](#))
  - `CONFIG_HCI_TRACE_LEVEL_NONE`
  - `CONFIG_HCI_TRACE_LEVEL_ERROR`
  - `CONFIG_HCI_TRACE_LEVEL_WARNING`
  - `CONFIG_HCI_TRACE_LEVEL_API`
  - `CONFIG_HCI_TRACE_LEVEL_EVENT`
  - `CONFIG_HCI_TRACE_LEVEL_DEBUG`



- CONFIG\_HCI\_TRACE\_LEVEL\_VERBOSE
- CONFIG\_HFP\_AG\_ENABLE ([CONFIG\\_BT\\_HFP\\_AG\\_ENABLE](#))
- **CONFIG\_HFP\_AUDIO\_DATA\_PATH** ([CONFIG\\_BT\\_HFP\\_AUDIO\\_DATA\\_PATH](#))
  - CONFIG\_HFP\_AUDIO\_DATA\_PATH\_PCM
  - CONFIG\_HFP\_AUDIO\_DATA\_PATH\_HCI
- CONFIG\_HFP\_CLIENT\_ENABLE ([CONFIG\\_BT\\_HFP\\_CLIENT\\_ENABLE](#))
- CONFIG\_HFP\_ENABLE ([CONFIG\\_BT\\_HFP\\_ENABLE](#))
- **CONFIG\_HID\_INITIAL\_TRACE\_LEVEL** ([CONFIG\\_BT\\_LOG\\_HID\\_TRACE\\_LEVEL](#))
  - CONFIG\_HID\_TRACE\_LEVEL\_NONE
  - CONFIG\_HID\_TRACE\_LEVEL\_ERROR
  - CONFIG\_HID\_TRACE\_LEVEL\_WARNING
  - CONFIG\_HID\_TRACE\_LEVEL\_API
  - CONFIG\_HID\_TRACE\_LEVEL\_EVENT
  - CONFIG\_HID\_TRACE\_LEVEL\_DEBUG
  - CONFIG\_HID\_TRACE\_LEVEL\_VERBOSE
- CONFIG\_INT\_WDT ([CONFIG\\_ESP\\_INT\\_WDT](#))
- CONFIG\_INT\_WDT\_CHECK\_CPU1 ([CONFIG\\_ESP\\_INT\\_WDT\\_CHECK\\_CPU1](#))
- CONFIG\_INT\_WDT\_TIMEOUT\_MS ([CONFIG\\_ESP\\_INT\\_WDT\\_TIMEOUT\\_MS](#))
- CONFIG\_IPC\_TASK\_STACK\_SIZE ([CONFIG\\_ESP\\_IPC\\_TASK\\_STACK\\_SIZE](#))
- **CONFIG\_L2CAP\_INITIAL\_TRACE\_LEVEL** ([CONFIG\\_BT\\_LOG\\_L2CAP\\_TRACE\\_LEVEL](#))
  - CONFIG\_L2CAP\_TRACE\_LEVEL\_NONE
  - CONFIG\_L2CAP\_TRACE\_LEVEL\_ERROR
  - CONFIG\_L2CAP\_TRACE\_LEVEL\_WARNING
  - CONFIG\_L2CAP\_TRACE\_LEVEL\_API
  - CONFIG\_L2CAP\_TRACE\_LEVEL\_EVENT
  - CONFIG\_L2CAP\_TRACE\_LEVEL\_DEBUG
  - CONFIG\_L2CAP\_TRACE\_LEVEL\_VERBOSE
- CONFIG\_L2\_TO\_L3\_COPY ([CONFIG\\_LWIP\\_L2\\_TO\\_L3\\_COPY](#))
- **CONFIG\_LOG\_BOOTLOADER\_LEVEL** ([CONFIG\\_BOOTLOADER\\_LOG\\_LEVEL](#))
  - CONFIG\_LOG\_BOOTLOADER\_LEVEL\_NONE
  - CONFIG\_LOG\_BOOTLOADER\_LEVEL\_ERROR
  - CONFIG\_LOG\_BOOTLOADER\_LEVEL\_WARN
  - CONFIG\_LOG\_BOOTLOADER\_LEVEL\_INFO
  - CONFIG\_LOG\_BOOTLOADER\_LEVEL\_DEBUG
  - CONFIG\_LOG\_BOOTLOADER\_LEVEL\_VERBOSE
- CONFIG\_MAC\_BB\_PD ([CONFIG\\_ESP\\_PHY\\_MAC\\_BB\\_PD](#))
- CONFIG\_MAIN\_TASK\_STACK\_SIZE ([CONFIG\\_ESP\\_MAIN\\_TASK\\_STACK\\_SIZE](#))
- **CONFIG\_MCA\_INITIAL\_TRACE\_LEVEL** ([CONFIG\\_BT\\_LOG\\_MCA\\_TRACE\\_LEVEL](#))
  - CONFIG\_MCA\_TRACE\_LEVEL\_NONE
  - CONFIG\_MCA\_TRACE\_LEVEL\_ERROR
  - CONFIG\_MCA\_TRACE\_LEVEL\_WARNING
  - CONFIG\_MCA\_TRACE\_LEVEL\_API
  - CONFIG\_MCA\_TRACE\_LEVEL\_EVENT
  - CONFIG\_MCA\_TRACE\_LEVEL\_DEBUG
  - CONFIG\_MCA\_TRACE\_LEVEL\_VERBOSE
- CONFIG\_MCPWM\_ISR\_IN\_IRAM ([CONFIG\\_MCPWM\\_ISR\\_IRAM\\_SAFE](#))
- CONFIG\_NIMBLE\_ATT\_PREFERRED\_MTU ([CONFIG\\_BT\\_NIMBLE\\_ATT\\_PREFERRED\\_MTU](#))
- CONFIG\_NIMBLE\_CRYPTOSTACK\_MBEDTLS ([CONFIG\\_BT\\_NIMBLE\\_CRYPTOSTACK\\_MBEDTLS](#))
- CONFIG\_NIMBLE\_DEBUG ([CONFIG\\_BT\\_NIMBLE\\_DEBUG](#))
- CONFIG\_NIMBLE\_GAP\_DEVICE\_NAME\_MAX\_LEN ([CONFIG\\_BT\\_NIMBLE\\_GAP\\_DEVICE\\_NAME\\_MAX\\_LEN](#))
- CONFIG\_NIMBLE\_HS\_FLOW\_CTRL ([CONFIG\\_BT\\_NIMBLE\\_HS\\_FLOW\\_CTRL](#))
- CONFIG\_NIMBLE\_HS\_FLOW\_CTRL\_ITVL ([CONFIG\\_BT\\_NIMBLE\\_HS\\_FLOW\\_CTRL\\_ITVL](#))
- CONFIG\_NIMBLE\_HS\_FLOW\_CTRL\_THRESH ([CONFIG\\_BT\\_NIMBLE\\_HS\\_FLOW\\_CTRL\\_THRESH](#))
- CONFIG\_NIMBLE\_HS\_FLOW\_CTRL\_TX\_ON\_DISCONNECT ([CONFIG\\_BT\\_NIMBLE\\_HS\\_FLOW\\_CTRL\\_TX\\_ON\\_DISCONNECT](#))
- CONFIG\_NIMBLE\_L2CAP\_COC\_MAX\_NUM ([CONFIG\\_BT\\_NIMBLE\\_L2CAP\\_COC\\_MAX\\_NUM](#))
- CONFIG\_NIMBLE\_MAX\_BONDS ([CONFIG\\_BT\\_NIMBLE\\_MAX\\_BONDS](#))
- CONFIG\_NIMBLE\_MAX\_CCCDS ([CONFIG\\_BT\\_NIMBLE\\_MAX\\_CCCDS](#))

- CONFIG\_NIMBLE\_MAX\_CONNECTIONS (*CONFIG\_BT\_NIMBLE\_MAX\_CONNECTIONS*)
- **CONFIG\_NIMBLE\_MEM\_ALLOC\_MODE** (*CONFIG\_BT\_NIMBLE\_MEM\_ALLOC\_MODE*)
  - CONFIG\_NIMBLE\_MEM\_ALLOC\_MODE\_INTERNAL
  - CONFIG\_NIMBLE\_MEM\_ALLOC\_MODE\_EXTERNAL
  - CONFIG\_NIMBLE\_MEM\_ALLOC\_MODE\_DEFAULT
- CONFIG\_NIMBLE\_MESH (*CONFIG\_BT\_NIMBLE\_MESH*)
- CONFIG\_NIMBLE\_MESH\_DEVICE\_NAME (*CONFIG\_BT\_NIMBLE\_MESH\_DEVICE\_NAME*)
- CONFIG\_NIMBLE\_MESH\_FRIEND (*CONFIG\_BT\_NIMBLE\_MESH\_FRIEND*)
- CONFIG\_NIMBLE\_MESH\_GATT\_PROXY (*CONFIG\_BT\_NIMBLE\_MESH\_GATT\_PROXY*)
- CONFIG\_NIMBLE\_MESH\_LOW\_POWER (*CONFIG\_BT\_NIMBLE\_MESH\_LOW\_POWER*)
- CONFIG\_NIMBLE\_MESH\_PB\_ADV (*CONFIG\_BT\_NIMBLE\_MESH\_PB\_ADV*)
- CONFIG\_NIMBLE\_MESH\_PB\_GATT (*CONFIG\_BT\_NIMBLE\_MESH\_PB\_GATT*)
- CONFIG\_NIMBLE\_MESH\_PROV (*CONFIG\_BT\_NIMBLE\_MESH\_PROV*)
- CONFIG\_NIMBLE\_MESH\_PROXY (*CONFIG\_BT\_NIMBLE\_MESH\_PROXY*)
- CONFIG\_NIMBLE\_MESH\_RELAY (*CONFIG\_BT\_NIMBLE\_MESH\_RELAY*)
- CONFIG\_NIMBLE\_NVS\_PERSIST (*CONFIG\_BT\_NIMBLE\_NVS\_PERSIST*)
- **CONFIG\_NIMBLE\_PINNED\_TO\_CORE\_CHOICE** (*CONFIG\_BT\_NIMBLE\_PINNED\_TO\_CORE\_CHOICE*)
  - CONFIG\_NIMBLE\_PINNED\_TO\_CORE\_0
  - CONFIG\_NIMBLE\_PINNED\_TO\_CORE\_1
- CONFIG\_NIMBLE\_ROLE\_BROADCASTER (*CONFIG\_BT\_NIMBLE\_ROLE\_BROADCASTER*)
- CONFIG\_NIMBLE\_ROLE\_CENTRAL (*CONFIG\_BT\_NIMBLE\_ROLE\_CENTRAL*)
- CONFIG\_NIMBLE\_ROLE\_OBSERVER (*CONFIG\_BT\_NIMBLE\_ROLE\_OBSERVER*)
- CONFIG\_NIMBLE\_ROLE\_PERIPHERAL (*CONFIG\_BT\_NIMBLE\_ROLE\_PERIPHERAL*)
- CONFIG\_NIMBLE\_RPA\_TIMEOUT (*CONFIG\_BT\_NIMBLE\_RPA\_TIMEOUT*)
- CONFIG\_NIMBLE\_SM\_LEGACY (*CONFIG\_BT\_NIMBLE\_SM\_LEGACY*)
- CONFIG\_NIMBLE\_SM\_SC (*CONFIG\_BT\_NIMBLE\_SM\_SC*)
- CONFIG\_NIMBLE\_SM\_SC\_DEBUG\_KEYS (*CONFIG\_BT\_NIMBLE\_SM\_SC\_DEBUG\_KEYS*)
- CONFIG\_NIMBLE\_SVC\_GAP\_APPEARANCE (*CONFIG\_BT\_NIMBLE\_SVC\_GAP\_APPEARANCE*)
- CONFIG\_NIMBLE\_SVC\_GAP\_DEVICE\_NAME (*CONFIG\_BT\_NIMBLE\_SVC\_GAP\_DEVICE\_NAME*)
- CONFIG\_NIMBLE\_TASK\_STACK\_SIZE (*CONFIG\_BT\_NIMBLE\_HOST\_TASK\_STACK\_SIZE*)
- CONFIG\_NO\_BLOBS (*CONFIG\_APP\_NO\_BLOBS*)
- **CONFIG\_OPTIMIZATION\_ASSERTION\_LEVEL** (*CONFIG\_COMPILER\_OPTIMIZATION\_ASSERTION\_LEVEL*)
  - CONFIG\_OPTIMIZATION\_ASSERTIONS\_ENABLED
  - CONFIG\_OPTIMIZATION\_ASSERTIONS\_SILENT
  - CONFIG\_OPTIMIZATION\_ASSERTIONS\_DISABLED
- **CONFIG\_OPTIMIZATION\_COMPILER** (*CONFIG\_COMPILER\_OPTIMIZATION*)
  - CONFIG\_OPTIMIZATION\_LEVEL\_DEBUG, CONFIG\_COMPILER\_OPTIMIZATION\_LEVEL\_DEBUG, CONFIG\_COMPILER\_OPTIMIZATION\_DEFAULT
  - CONFIG\_OPTIMIZATION\_LEVEL\_RELEASE, CONFIG\_COMPILER\_OPTIMIZATION\_LEVEL\_RELEASE
- **CONFIG\_OSI\_INITIAL\_TRACE\_LEVEL** (*CONFIG\_BT\_LOG\_OSI\_TRACE\_LEVEL*)
  - CONFIG\_OSI\_TRACE\_LEVEL\_NONE
  - CONFIG\_OSI\_TRACE\_LEVEL\_ERROR
  - CONFIG\_OSI\_TRACE\_LEVEL\_WARNING
  - CONFIG\_OSI\_TRACE\_LEVEL\_API
  - CONFIG\_OSI\_TRACE\_LEVEL\_EVENT
  - CONFIG\_OSI\_TRACE\_LEVEL\_DEBUG
  - CONFIG\_OSI\_TRACE\_LEVEL\_VERBOSE
- CONFIG\_OTA\_ALLOW\_HTTP (*CONFIG\_ESP\_HTTPS\_OTA\_ALLOW\_HTTP*)
- **CONFIG\_PAN\_INITIAL\_TRACE\_LEVEL** (*CONFIG\_BT\_LOG\_PAN\_TRACE\_LEVEL*)
  - CONFIG\_PAN\_TRACE\_LEVEL\_NONE
  - CONFIG\_PAN\_TRACE\_LEVEL\_ERROR
  - CONFIG\_PAN\_TRACE\_LEVEL\_WARNING
  - CONFIG\_PAN\_TRACE\_LEVEL\_API
  - CONFIG\_PAN\_TRACE\_LEVEL\_EVENT
  - CONFIG\_PAN\_TRACE\_LEVEL\_DEBUG
  - CONFIG\_PAN\_TRACE\_LEVEL\_VERBOSE

- CONFIG\_POST\_EVENTS\_FROM\_IRAM\_ISR (*CONFIG\_ESP\_EVENT\_POST\_FROM\_IRAM\_ISR*)
- CONFIG\_POST\_EVENTS\_FROM\_ISR (*CONFIG\_ESP\_EVENT\_POST\_FROM\_ISR*)
- CONFIG\_PPP\_CHAP\_SUPPORT (*CONFIG\_LWIP\_PPP\_CHAP\_SUPPORT*)
- CONFIG\_PPP\_DEBUG\_ON (*CONFIG\_LWIP\_PPP\_DEBUG\_ON*)
- CONFIG\_PPP\_MPPE\_SUPPORT (*CONFIG\_LWIP\_PPP\_MPPE\_SUPPORT*)
- CONFIG\_PPP\_MSCHAP\_SUPPORT (*CONFIG\_LWIP\_PPP\_MSCHAP\_SUPPORT*)
- CONFIG\_PPP\_NOTIFY\_PHASE\_SUPPORT (*CONFIG\_LWIP\_PPP\_NOTIFY\_PHASE\_SUPPORT*)
- CONFIG\_PPP\_PAP\_SUPPORT (*CONFIG\_LWIP\_PPP\_PAP\_SUPPORT*)
- CONFIG\_PPP\_SUPPORT (*CONFIG\_LWIP\_PPP\_SUPPORT*)
- CONFIG\_REDUCE\_PHY\_TX\_POWER (*CONFIG\_ESP\_PHY\_REDUCE\_TX\_POWER*)
- **CONFIG\_RFCOMM\_INITIAL\_TRACE\_LEVEL (*CONFIG\_BT\_LOG\_RFCOMM\_TRACE\_LEVEL*)**
  - CONFIG\_RFCOMM\_TRACE\_LEVEL\_NONE
  - CONFIG\_RFCOMM\_TRACE\_LEVEL\_ERROR
  - CONFIG\_RFCOMM\_TRACE\_LEVEL\_WARNING
  - CONFIG\_RFCOMM\_TRACE\_LEVEL\_API
  - CONFIG\_RFCOMM\_TRACE\_LEVEL\_EVENT
  - CONFIG\_RFCOMM\_TRACE\_LEVEL\_DEBUG
  - CONFIG\_RFCOMM\_TRACE\_LEVEL\_VERBOSE
- CONFIG\_SEMIHOSTFS\_MAX\_MOUNT\_POINTS (*CONFIG\_VFS\_SEMIHOSTFS\_MAX\_MOUNT\_POINTS*)
- **CONFIG\_SMP\_INITIAL\_TRACE\_LEVEL (*CONFIG\_BT\_LOG\_SMP\_TRACE\_LEVEL*)**
  - CONFIG\_SMP\_TRACE\_LEVEL\_NONE
  - CONFIG\_SMP\_TRACE\_LEVEL\_ERROR
  - CONFIG\_SMP\_TRACE\_LEVEL\_WARNING
  - CONFIG\_SMP\_TRACE\_LEVEL\_API
  - CONFIG\_SMP\_TRACE\_LEVEL\_EVENT
  - CONFIG\_SMP\_TRACE\_LEVEL\_DEBUG
  - CONFIG\_SMP\_TRACE\_LEVEL\_VERBOSE
- CONFIG\_SMP\_SLAVE\_CON\_PARAMS\_UPD\_ENABLE (*CONFIG\_BT\_SMP\_SLAVE\_CON\_PARAMS\_UPD\_ENABLE*)
- **CONFIG\_SPI\_FLASH\_WRITING\_DANGEROUS\_REGIONS (*CONFIG\_SPI\_FLASH\_DANGEROUS\_WRITE*)**
  - CONFIG\_SPI\_FLASH\_WRITING\_DANGEROUS\_REGIONS\_ABORTS
  - CONFIG\_SPI\_FLASH\_WRITING\_DANGEROUS\_REGIONS\_FAILS
  - CONFIG\_SPI\_FLASH\_WRITING\_DANGEROUS\_REGIONS\_ALLOWED
- **CONFIG\_STACK\_CHECK\_MODE (*CONFIG\_COMPILER\_STACK\_CHECK\_MODE*)**
  - CONFIG\_STACK\_CHECK\_NONE
  - CONFIG\_STACK\_CHECK\_NORM
  - CONFIG\_STACK\_CHECK\_STRONG
  - CONFIG\_STACK\_CHECK\_ALL
- CONFIG\_SUPPORT\_TERMIOS (*CONFIG\_VFS\_SUPPORT\_TERMIOS*)
- CONFIG\_SUPPRESS\_SELECT\_DEBUG\_OUTPUT (*CONFIG\_VFS\_SUPPRESS\_SELECT\_DEBUG\_OUTPUT*)
- CONFIG\_SW\_COEXIST\_ENABLE (*CONFIG\_ESP\_COEX\_SW\_COEXIST\_ENABLE*)
- CONFIG\_SYSTEM\_EVENT\_QUEUE\_SIZE (*CONFIG\_ESP\_SYSTEM\_EVENT\_QUEUE\_SIZE*)
- CONFIG\_SYSTEM\_EVENT\_TASK\_STACK\_SIZE (*CONFIG\_ESP\_SYSTEM\_EVENT\_TASK\_STACK\_SIZE*)
- CONFIG\_SYSVIEW\_BUF\_WAIT\_TMO (*CONFIG\_APPTRACE\_SV\_BUF\_WAIT\_TMO*)
- CONFIG\_SYSVIEW\_ENABLE (*CONFIG\_APPTRACE\_SV\_ENABLE*)
- CONFIG\_SYSVIEW\_EVT\_IDLE\_ENABLE (*CONFIG\_APPTRACE\_SV\_EVT\_IDLE\_ENABLE*)
- CONFIG\_SYSVIEW\_EVT\_ISR\_ENTER\_ENABLE (*CONFIG\_APPTRACE\_SV\_EVT\_ISR\_ENTER\_ENABLE*)
- CONFIG\_SYSVIEW\_EVT\_ISR\_EXIT\_ENABLE (*CONFIG\_APPTRACE\_SV\_EVT\_ISR\_EXIT\_ENABLE*)
- CONFIG\_SYSVIEW\_EVT\_ISR\_TO\_SCHEDULER\_ENABLE (*CONFIG\_APPTRACE\_SV\_EVT\_ISR\_TO\_SCHED\_ENABLE*)
- CONFIG\_SYSVIEW\_EVT\_OVERFLOW\_ENABLE (*CONFIG\_APPTRACE\_SV\_EVT\_OVERFLOW\_ENABLE*)
- CONFIG\_SYSVIEW\_EVT\_TASK\_CREATE\_ENABLE (*CONFIG\_APPTRACE\_SV\_EVT\_TASK\_CREATE\_ENABLE*)
- CONFIG\_SYSVIEW\_EVT\_TASK\_START\_EXEC\_ENABLE (*CONFIG\_APPTRACE\_SV\_EVT\_TASK\_START\_EXEC\_ENABLE*)
- CONFIG\_SYSVIEW\_EVT\_TASK\_START\_READY\_ENABLE (*CONFIG\_APPTRACE\_SV\_EVT\_TASK\_START\_READY\_ENABLE*)
- CONFIG\_SYSVIEW\_EVT\_TASK\_STOP\_EXEC\_ENABLE (*CONFIG\_APPTRACE\_SV\_EVT\_TASK\_STOP\_EXEC\_ENABLE*)
- CONFIG\_SYSVIEW\_EVT\_TASK\_STOP\_READY\_ENABLE (*CONFIG\_APPTRACE\_SV\_EVT\_TASK\_STOP\_READY\_ENABLE*)
- CONFIG\_SYSVIEW\_EVT\_TASK\_TERMINATE\_ENABLE (*CONFIG\_APPTRACE\_SV\_EVT\_TASK\_TERMINATE\_ENABLE*)
- CONFIG\_SYSVIEW\_EVT\_TIMER\_ENTER\_ENABLE (*CONFIG\_APPTRACE\_SV\_EVT\_TIMER\_ENTER\_ENABLE*)
- CONFIG\_SYSVIEW\_EVT\_TIMER\_EXIT\_ENABLE (*CONFIG\_APPTRACE\_SV\_EVT\_TIMER\_EXIT\_ENABLE*)

- CONFIG\_SYSVIEW\_MAX\_TASKS (*CONFIG\_APPTTRACE\_SV\_MAX\_TASKS*)
- **CONFIG\_SYSVIEW\_TS\_SOURCE** (*CONFIG\_APPTTRACE\_SV\_TS\_SOURCE*)
  - CONFIG\_SYSVIEW\_TS\_SOURCE\_CCOUNT
  - CONFIG\_SYSVIEW\_TS\_SOURCE\_ESP\_TIMER
- CONFIG\_TASK\_WDT (*CONFIG\_ESP\_TASK\_WDT\_INIT*)
- CONFIG\_TASK\_WDT\_CHECK\_IDLE\_TASK\_CPU0 (*CONFIG\_ESP\_TASK\_WDT\_CHECK\_IDLE\_TASK\_CPU0*)
- CONFIG\_TASK\_WDT\_CHECK\_IDLE\_TASK\_CPU1 (*CONFIG\_ESP\_TASK\_WDT\_CHECK\_IDLE\_TASK\_CPU1*)
- CONFIG\_TASK\_WDT\_PANIC (*CONFIG\_ESP\_TASK\_WDT\_PANIC*)
- CONFIG\_TASK\_WDT\_TIMEOUT\_S (*CONFIG\_ESP\_TASK\_WDT\_TIMEOUT\_S*)
- CONFIG\_TCPIP\_RECVMBOX\_SIZE (*CONFIG\_LWIP\_TCPIP\_RECVMBOX\_SIZE*)
- **CONFIG\_TCPIP\_TASK\_AFFINITY** (*CONFIG\_LWIP\_TCPIP\_TASK\_AFFINITY*)
  - CONFIG\_TCPIP\_TASK\_AFFINITY\_NO\_AFFINITY
  - CONFIG\_TCPIP\_TASK\_AFFINITY\_CPU0
  - CONFIG\_TCPIP\_TASK\_AFFINITY\_CPU1
- CONFIG\_TCPIP\_TASK\_STACK\_SIZE (*CONFIG\_LWIP\_TCPIP\_TASK\_STACK\_SIZE*)
- CONFIG\_TCP\_MAXRTX (*CONFIG\_LWIP\_TCP\_MAXRTX*)
- CONFIG\_TCP\_MSL (*CONFIG\_LWIP\_TCP\_MSL*)
- CONFIG\_TCP\_MSS (*CONFIG\_LWIP\_TCP\_MSS*)
- **CONFIG\_TCP\_OVERSIZE** (*CONFIG\_LWIP\_TCP\_OVERSIZE*)
  - CONFIG\_TCP\_OVERSIZE\_MSS
  - CONFIG\_TCP\_OVERSIZE\_QUARTER\_MSS
  - CONFIG\_TCP\_OVERSIZE\_DISABLE
- CONFIG\_TCP\_QUEUE\_OOSEQ (*CONFIG\_LWIP\_TCP\_QUEUE\_OOSEQ*)
- CONFIG\_TCP\_RECVMBOX\_SIZE (*CONFIG\_LWIP\_TCP\_RECVMBOX\_SIZE*)
- CONFIG\_TCP\_SND\_BUF\_DEFAULT (*CONFIG\_LWIP\_TCP\_SND\_BUF\_DEFAULT*)
- CONFIG\_TCP\_SYNMAXRTX (*CONFIG\_LWIP\_TCP\_SYNMAXRTX*)
- CONFIG\_TCP\_WND\_DEFAULT (*CONFIG\_LWIP\_TCP\_WND\_DEFAULT*)
- CONFIG\_TIMER\_QUEUE\_LENGTH (*CONFIG\_FREERTOS\_TIMER\_QUEUE\_LENGTH*)
- CONFIG\_TIMER\_TASK\_PRIORITY (*CONFIG\_FREERTOS\_TIMER\_TASK\_PRIORITY*)
- CONFIG\_TIMER\_TASK\_STACK\_DEPTH (*CONFIG\_FREERTOS\_TIMER\_TASK\_STACK\_DEPTH*)
- CONFIG\_TIMER\_TASK\_STACK\_SIZE (*CONFIG\_ESP\_TIMER\_TASK\_STACK\_SIZE*)
- CONFIG\_UDP\_RECVMBOX\_SIZE (*CONFIG\_LWIP\_UDP\_RECVMBOX\_SIZE*)
- CONFIG\_WARN\_WRITE\_STRINGS (*CONFIG\_COMPILER\_WARN\_WRITE\_STRINGS*)
- CONFIG\_WPA\_11KV\_SUPPORT (*CONFIG\_ESP\_WIFI\_11KV\_SUPPORT*)
- CONFIG\_WPA\_11R\_SUPPORT (*CONFIG\_ESP\_WIFI\_11R\_SUPPORT*)
- CONFIG\_WPA\_DEBUG\_PRINT (*CONFIG\_ESP\_WIFI\_DEBUG\_PRINT*)
- CONFIG\_WPA\_DPP\_SUPPORT (*CONFIG\_ESP\_WIFI\_DPP\_SUPPORT*)
- CONFIG\_WPA\_MBEDTLS\_CRYPTO (*CONFIG\_ESP\_WIFI\_MBEDTLS\_CRYPTO*)
- CONFIG\_WPA\_MBEDTLS\_TLS\_CLIENT (*CONFIG\_ESP\_WIFI\_MBEDTLS\_TLS\_CLIENT*)
- CONFIG\_WPA\_MBO\_SUPPORT (*CONFIG\_ESP\_WIFI\_MBO\_SUPPORT*)
- CONFIG\_WPA\_SCAN\_CACHE (*CONFIG\_ESP\_WIFI\_SCAN\_CACHE*)
- CONFIG\_WPA\_SUITE\_B\_192 (*CONFIG\_ESP\_WIFI\_SUITE\_B\_192*)
- CONFIG\_WPA\_TESTING\_OPTIONS (*CONFIG\_ESP\_WIFI\_TESTING\_OPTIONS*)
- CONFIG\_WPA\_WAPI\_PSK (*CONFIG\_ESP\_WIFI\_WAPI\_PSK*)
- CONFIG\_WPA\_WPS\_SOFTAP\_REGISTRAR (*CONFIG\_ESP\_WIFI\_WPS\_SOFTAP\_REGISTRAR*)
- CONFIG\_WPA\_WPS\_STRICT (*CONFIG\_ESP\_WIFI\_WPS\_STRICT*)

## 2.8 配网 API

### 2.8.1 协议通信



## 概述

协议通信 (protocomm) 组件用于管理安全会话并为多种传输提供框架。应用程序还可以直接使用 `protocomm` 层来增加特定扩展，用于配网或非配网使用场景。

以下功能可用于配网：

- 应用程序层面的通信安全
  - `protocomm_security0` (无安全功能)
  - `protocomm_security1` (Curve25519 密钥交换 + AES-CTR 加密/解密)
  - `protocomm_security2` (基于 SRP6a 的密钥交换 + AES-GCM 加密/解密)
- 所有权验证 (Proof-of-possession) (仅 `protocomm_security1` 支持该功能)
- 盐值和验证器 (Salt and Verifier) (仅 `protocomm_security2` 支持该功能)

在 `protocomm` 内部，`protobuf` (协议缓冲区) 用于建立安全会话。用户可以自行选择 (即使在不使用 `Protobuf` 的情况下) 实现安全性，也可以在没有任何安全层的情况下使用协议。

`Protocomm` 为以下各种传输提供框架：

- 低功耗蓝牙
- 控制台：使用该传输方案时，设备端会自动调用处理程序。相关代码片段，请参见下文传输示例。

请注意，对于 `protocomm_security1` 和 `protocomm_security2`，客户端仍需要执行双向握手来建立会话。

## 启用 `protocomm` 安全版本

关于启用/禁用相应的安全版本，请参阅 `protocomm` 组件的项目配置菜单。相应配置选项如下：

- 支持 `protocomm_security0`，该版本无安全功能：[CONFIG\\_ESP\\_PROTOCOMM\\_SUPPORT\\_SECURITY\\_VERSION\\_0](#)，该选项默认启用。
- 支持 `protocomm_security1`，使用 Curve25519 密钥交换和 AES-CTR 加密/解密：[CONFIG\\_ESP\\_PROTOCOMM\\_SUPPORT\\_SECURITY\\_VERSION\\_1](#)，该选项默认启用。
- 支持 `protocomm_security2`，使用基于 SRP6a 的密钥交换和 AES-GCM 加密/解密：[CONFIG\\_ESP\\_PROTOCOMM\\_SUPPORT\\_SECURITY\\_VERSION\\_2](#)。

---

**备注：** 启用多个安全版本后可以动态控制安全版本，但也会增加固件大小。

---

## 使用 `Security 0` 的低功耗蓝牙传输方案示例

示例用法请参阅 `wifi_provisioning/src/scheme_ble.c`。

```

/* 通过低功耗蓝牙启动安全 protocomm 实例的示例函数 */
protocomm_t *start_pc()
{
    protocomm_t *pc = protocomm_new();

    /* 端点 UUID */
    protocomm_ble_name_uuid_t nu_lookup_table[] = {
        {"security_endpoint", 0xFF51},
        {"echo_req_endpoint", 0xFF52}
    };

    /* 配置 protocomm_ble_start() */
    protocomm_ble_config_t config = {
        .service_uuid = {
            /* 最低有效位 <----- */
            * -----> 最高有效位 */
        }
    };
}

```

(下页继续)

```

        0xfb, 0x34, 0x9b, 0x5f, 0x80, 0x00, 0x00, 0x80,
        0x00, 0x10, 0x00, 0x00, 0xFF, 0xFF, 0x00, 0x00,
    },
    .nu_lookup_count = sizeof(nu_lookup_table)/sizeof(nu_lookup_table[0]),
    .nu_lookup = nu_lookup_table
};

/* 启动基于低功耗蓝牙的 protocomm 层 */
protocomm_ble_start(pc, &config);

/* protocomm_security0 方案不使用所有权证明，因此可以将其保持为 NULL */
protocomm_set_security(pc, "security_endpoint", &protocomm_security0, NULL);
protocomm_add_endpoint(pc, "echo_req_endpoint", echo_req_handler, NULL);
return pc;
}

/* 停止 protocomm 实例的示例函数 */
void stop_pc(protocomm_t *pc)
{
    protocomm_remove_endpoint(pc, "echo_req_endpoint");
    protocomm_unset_security(pc, "security_endpoint");

    /* 停止低功耗蓝牙 protocomm 服务 */
    protocomm_ble_stop(pc);

    protocomm_delete(pc);
}

```

## API 参考

### Header File

- `components/protocomm/include/common/protocomm.h`
- This header file can be included with:

```
#include "protocomm.h"
```

- This header file is a part of the API provided by the `protocomm` component. To declare that your component depends on `protocomm`, add the following to your `CMakeLists.txt`:

```
REQUIRES protocomm
```

or

```
PRIV_REQUIRES protocomm
```

### Functions

`protocomm_t*` **protocomm\_new** (void)

Create a new `protocomm` instance.

This API will return a new dynamically allocated `protocomm` instance with all elements of the `protocomm_t` structure initialized to `NULL`.

#### 返回

- `protocomm_t*`: On success
- `NULL`: No memory for allocating new instance

void **protocomm\_delete** (`protocomm_t*` pc)

Delete a `protocomm` instance.

This API will deallocate a `protocomm` instance that was created using `protocomm_new()`.

参数 **pc** -- **[in]** Pointer to the protocomm instance to be deleted

*esp\_err\_t* **protocomm\_add\_endpoint** (*protocomm\_t* \*pc, const char \*ep\_name, *protocomm\_req\_handler\_t* h, void \*priv\_data)

Add endpoint request handler for a protocomm instance.

This API will bind an endpoint handler function to the specified endpoint name, along with any private data that needs to be pass to the handler at the time of call.

---

**备注:**

- An endpoint must be bound to a valid protocomm instance, created using `protocomm_new()`.
  - This function internally calls the registered `add_endpoint()` function of the selected transport which is a member of the `protocomm_t` instance structure.
- 

**参数**

- **pc** -- **[in]** Pointer to the protocomm instance
- **ep\_name** -- **[in]** Endpoint identifier(name) string
- **h** -- **[in]** Endpoint handler function
- **priv\_data** -- **[in]** Pointer to private data to be passed as a parameter to the handler function on call. Pass NULL if not needed.

**返回**

- `ESP_OK` : Success
- `ESP_FAIL` : Error adding endpoint / Endpoint with this name already exists
- `ESP_ERR_NO_MEM` : Error allocating endpoint resource
- `ESP_ERR_INVALID_ARG` : Null instance/name/handler arguments

*esp\_err\_t* **protocomm\_remove\_endpoint** (*protocomm\_t* \*pc, const char \*ep\_name)

Remove endpoint request handler for a protocomm instance.

This API will remove a registered endpoint handler identified by an endpoint name.

---

**备注:**

- This function internally calls the registered `remove_endpoint()` function which is a member of the `protocomm_t` instance structure.
- 

**参数**

- **pc** -- **[in]** Pointer to the protocomm instance
- **ep\_name** -- **[in]** Endpoint identifier(name) string

**返回**

- `ESP_OK` : Success
- `ESP_ERR_NOT_FOUND` : Endpoint with specified name doesn't exist
- `ESP_ERR_INVALID_ARG` : Null instance/name arguments

*esp\_err\_t* **protocomm\_open\_session** (*protocomm\_t* \*pc, uint32\_t session\_id)

Allocates internal resources for new transport session.

---

**备注:**

- An endpoint must be bound to a valid protocomm instance, created using `protocomm_new()`.
- 

**参数**

- **pc** -- **[in]** Pointer to the protocomm instance
- **session\_id** -- **[in]** Unique ID for a communication session

**返回**

- ESP\_OK : Request handled successfully
- ESP\_ERR\_NO\_MEM : Error allocating internal resource
- ESP\_ERR\_INVALID\_ARG : Null instance/name arguments

*esp\_err\_t* **protocomm\_close\_session** (*protocomm\_t* \*pc, uint32\_t session\_id)

Frees internal resources used by a transport session.

---

**备注:**

- An endpoint must be bound to a valid *protocomm* instance, created using *protocomm\_new* ().
- 

**参数**

- **pc** -- **[in]** Pointer to the *protocomm* instance
- **session\_id** -- **[in]** Unique ID for a communication session

**返回**

- ESP\_OK : Request handled successfully
- ESP\_ERR\_INVALID\_ARG : Null instance/name arguments

*esp\_err\_t* **protocomm\_req\_handle** (*protocomm\_t* \*pc, const char \*ep\_name, uint32\_t session\_id, const uint8\_t \*inbuf, ssize\_t inlen, uint8\_t \*\*outbuf, ssize\_t \*outlen)

Calls the registered handler of an endpoint session for processing incoming data and generating the response.

---

**备注:**

- An endpoint must be bound to a valid *protocomm* instance, created using *protocomm\_new* ().
  - Resulting output buffer must be deallocated by the caller.
- 

**参数**

- **pc** -- **[in]** Pointer to the *protocomm* instance
- **ep\_name** -- **[in]** Endpoint identifier(name) string
- **session\_id** -- **[in]** Unique ID for a communication session
- **inbuf** -- **[in]** Input buffer contains input request data which is to be processed by the registered handler
- **inlen** -- **[in]** Length of the input buffer
- **outbuf** -- **[out]** Pointer to internally allocated output buffer, where the resulting response data output from the registered handler is to be stored
- **outlen** -- **[out]** Buffer length of the allocated output buffer

**返回**

- ESP\_OK : Request handled successfully
- ESP\_FAIL : Internal error in execution of registered handler
- ESP\_ERR\_NO\_MEM : Error allocating internal resource
- ESP\_ERR\_NOT\_FOUND : Endpoint with specified name doesn't exist
- ESP\_ERR\_INVALID\_ARG : Null instance/name arguments

*esp\_err\_t* **protocomm\_set\_security** (*protocomm\_t* \*pc, const char \*ep\_name, const *protocomm\_security\_t* \*sec, const void \*sec\_params)

Add endpoint security for a *protocomm* instance.

This API will bind a security session establisher to the specified endpoint name, along with any proof of possession that may be required for authenticating a session client.

---

**备注:**

- An endpoint must be bound to a valid *protocomm* instance, created using *protocomm\_new* ().



- The choice of security can be any `protocomm_security_t` instance. Choices `protocomm_security0` and `protocomm_security1` and `protocomm_security2` are readily available.

### 参数

- **pc** -- **[in]** Pointer to the `protocomm` instance
- **ep\_name** -- **[in]** Endpoint identifier(name) string
- **sec** -- **[in]** Pointer to endpoint security instance
- **sec\_params** -- **[in]** Pointer to security params (NULL if not needed) The pointer should contain the security params struct of appropriate security version. For `protocomm` security version 1 and 2 `sec_params` should contain pointer to struct of type `protocomm_security1_params_t` and `protocomm_security2_params_t` respectively. The contents of this pointer must be valid till the security session has been running and is not closed.

### 返回

- `ESP_OK` : Success
- `ESP_FAIL` : Error adding endpoint / Endpoint with this name already exists
- `ESP_ERR_INVALID_STATE` : Security endpoint already set
- `ESP_ERR_NO_MEM` : Error allocating endpoint resource
- `ESP_ERR_INVALID_ARG` : Null instance/name/handler arguments

`esp_err_t protocomm_unset_security(protocomm_t *pc, const char *ep_name)`

Remove endpoint security for a `protocomm` instance.

This API will remove a registered security endpoint identified by an endpoint name.

### 参数

- **pc** -- **[in]** Pointer to the `protocomm` instance
- **ep\_name** -- **[in]** Endpoint identifier(name) string

### 返回

- `ESP_OK` : Success
- `ESP_ERR_NOT_FOUND` : Endpoint with specified name doesn't exist
- `ESP_ERR_INVALID_ARG` : Null instance/name arguments

`esp_err_t protocomm_set_version(protocomm_t *pc, const char *ep_name, const char *version)`

Set endpoint for version verification.

This API can be used for setting an application specific protocol version which can be verified by clients through the endpoint.

### 备注:

- An endpoint must be bound to a valid `protocomm` instance, created using `protocomm_new()`.

### 参数

- **pc** -- **[in]** Pointer to the `protocomm` instance
- **ep\_name** -- **[in]** Endpoint identifier(name) string
- **version** -- **[in]** Version identifier(name) string

### 返回

- `ESP_OK` : Success
- `ESP_FAIL` : Error adding endpoint / Endpoint with this name already exists
- `ESP_ERR_INVALID_STATE` : Version endpoint already set
- `ESP_ERR_NO_MEM` : Error allocating endpoint resource
- `ESP_ERR_INVALID_ARG` : Null instance/name/handler arguments

`esp_err_t protocomm_unset_version(protocomm_t *pc, const char *ep_name)`

Remove version verification endpoint from a `protocomm` instance.

This API will remove a registered version endpoint identified by an endpoint name.

#### 参数

- **pc** -- **[in]** Pointer to the protocomm instance
- **ep\_name** -- **[in]** Endpoint identifier(name) string

#### 返回

- ESP\_OK : Success
- ESP\_ERR\_NOT\_FOUND : Endpoint with specified name doesn't exist
- ESP\_ERR\_INVALID\_ARG : Null instance/name arguments

### Type Definitions

```
typedef esp_err_t (protocomm_req_handler_t)(uint32_t session_id, const uint8_t *inbuf, ssize_t inlen,
uint8_t **outbuf, ssize_t *outlen, void *priv_data)
```

Function prototype for protocomm endpoint handler.

```
typedef struct protocomm protocomm_t
```

This structure corresponds to a unique instance of protocomm returned when the API `protocomm_new()` is called. The remaining Protocomm APIs require this object as the first parameter.

---

**备注:** Structure of the protocomm object is kept private

---

### Header File

- [components/protocomm/include/security/protocomm\\_security.h](#)
- This header file can be included with:

```
#include "protocomm_security.h"
```

- This header file is a part of the API provided by the `protocomm` component. To declare that your component depends on `protocomm`, add the following to your `CMakeLists.txt`:

```
REQUIRES protocomm
```

or

```
PRIV_REQUIRES protocomm
```

### Structures

```
struct protocomm_security1_params
```

Protocomm Security 1 parameters: Proof Of Possession.

#### Public Members

```
const uint8_t *data
```

Pointer to buffer containing the proof of possession data

```
uint16_t len
```

Length (in bytes) of the proof of possession data

```
struct protocomm_security2_params
```

Protocomm Security 2 parameters: Salt and Verifier.

## Public Members

const char \***salt**

Pointer to the buffer containing the salt

uint16\_t **salt\_len**

Length (in bytes) of the salt

const char \***verifier**

Pointer to the buffer containing the verifier

uint16\_t **verifier\_len**

Length (in bytes) of the verifier

struct **protocomm\_security**

Protocomm security object structure.

The member functions are used for implementing secure protocomm sessions.

---

**备注:** This structure should not have any dynamic members to allow re-entrancy

---

## Public Members

int **ver**

Unique version number of security implementation

*esp\_err\_t* (\***init**)(*protocomm\_security\_handle\_t* \*handle)

Function for initializing/allocating security infrastructure

*esp\_err\_t* (\***cleanup**)(*protocomm\_security\_handle\_t* handle)

Function for deallocating security infrastructure

*esp\_err\_t* (\***new\_transport\_session**)(*protocomm\_security\_handle\_t* handle, uint32\_t session\_id)

Starts new secure transport session with specified ID

*esp\_err\_t* (\***close\_transport\_session**)(*protocomm\_security\_handle\_t* handle, uint32\_t session\_id)

Closes a secure transport session with specified ID

*esp\_err\_t* (\***security\_req\_handler**)(*protocomm\_security\_handle\_t* handle, const void \*sec\_params, uint32\_t session\_id, const uint8\_t \*inbuf, ssize\_t inlen, uint8\_t \*\*outbuf, ssize\_t \*outlen, void \*priv\_data)

Handler function for authenticating connection request and establishing secure session

*esp\_err\_t* (\***encrypt**)(*protocomm\_security\_handle\_t* handle, uint32\_t session\_id, const uint8\_t \*inbuf, ssize\_t inlen, uint8\_t \*\*outbuf, ssize\_t \*outlen)

Function which implements the encryption algorithm

*esp\_err\_t* (\***decrypt**)(*protocomm\_security\_handle\_t* handle, uint32\_t session\_id, const uint8\_t \*inbuf, ssize\_t inlen, uint8\_t \*\*outbuf, ssize\_t \*outlen)

Function which implements the decryption algorithm

## Type Definitions

typedef struct *protocomm\_security1\_params* **protocomm\_security1\_params\_t**

Protocomm Security 1 parameters: Proof Of Possession.

typedef *protocomm\_security1\_params\_t* **protocomm\_security\_pop\_t**

typedef struct *protocomm\_security2\_params* **protocomm\_security2\_params\_t**

Protocomm Security 2 parameters: Salt and Verifier.

typedef void \***protocomm\_security\_handle\_t**

typedef struct *protocomm\_security* **protocomm\_security\_t**

Protocomm security object structure.

The member functions are used for implementing secure protocomm sessions.

---

**备注:** This structure should not have any dynamic members to allow re-entrancy

---

## Enumerations

enum **protocomm\_security\_session\_event\_t**

Events generated by the protocomm security layer.

These events are generated while establishing secured session.

*Values:*

enumerator **PROTOCOLM\_SECURITY\_SESSION\_SETUP\_OK**

Secured session established successfully

enumerator **PROTOCOLM\_SECURITY\_SESSION\_INVALID\_SECURITY\_PARAMS**

Received invalid (NULL) security parameters (username / client public-key)

enumerator **PROTOCOLM\_SECURITY\_SESSION\_CREDENTIALS\_MISMATCH**

Received incorrect credentials (username / PoP)

## Header File

- [components/protocomm/include/security/protocomm\\_security0.h](#)
- This header file can be included with:

```
#include "protocomm_security0.h"
```

- This header file is a part of the API provided by the `protocomm` component. To declare that your component depends on `protocomm`, add the following to your `CMakeLists.txt`:

```
REQUIRES protocomm
```

or

```
PRIV_REQUIRES protocomm
```

### Header File

- [components/protocomm/include/security/protocomm\\_security1.h](#)
- This header file can be included with:

```
#include "protocomm_security1.h"
```

- This header file is a part of the API provided by the `protocomm` component. To declare that your component depends on `protocomm`, add the following to your `CMakeLists.txt`:

```
REQUIRES protocomm
```

or

```
PRIV_REQUIRES protocomm
```

### Header File

- [components/protocomm/include/security/protocomm\\_security2.h](#)
- This header file can be included with:

```
#include "protocomm_security2.h"
```

- This header file is a part of the API provided by the `protocomm` component. To declare that your component depends on `protocomm`, add the following to your `CMakeLists.txt`:

```
REQUIRES protocomm
```

or

```
PRIV_REQUIRES protocomm
```

### Header File

- [components/protocomm/include/crypto/srp6a/esp\\_srp.h](#)
- This header file can be included with:

```
#include "esp_srp.h"
```

- This header file is a part of the API provided by the `protocomm` component. To declare that your component depends on `protocomm`, add the following to your `CMakeLists.txt`:

```
REQUIRES protocomm
```

or

```
PRIV_REQUIRES protocomm
```

### Functions

`esp_srp_handle_t *esp_srp_init (esp_ng_type_t ng)`

Initialize srp context for given NG type.

---

**备注:** the handle gets freed with `esp_srp_free`

---

**参数** `ng` -- NG type given by `esp_ng_type_t`

**返回** `esp_srp_handle_t*` srp handle

void `esp_srp_free (esp_srp_handle_t *hd)`

free `esp_srp_context`

**参数** `hd` -- handle to be free

---

```
esp_err_t esp_srp_srv_pubkey (esp_srp_handle_t *hd, const char *username, int username_len, const char
    *pass, int pass_len, int salt_len, char **bytes_B, int *len_B, char
    **bytes_salt)
```

Returns B (pub key) and salt. [Step2.b].

---

**备注:** \*bytes\_B MUST NOT BE FREED BY THE CALLER

---



---

**备注:** \*bytes\_salt MUST NOT BE FREE BY THE CALLER

---

#### 参数

- **hd** -- esp\_srp handle
- **username** -- Username not expected NULL terminated
- **username\_len** -- Username length
- **pass** -- Password not expected to be NULL terminated
- **pass\_len** -- Password length
- **salt\_len** -- Salt length
- **bytes\_B** -- Public Key returned
- **len\_B** -- Length of the public key
- **bytes\_salt** -- Salt bytes generated

**返回** *esp\_err\_t* ESP\_OK on success, appropriate error otherwise

```
esp_err_t esp_srp_gen_salt_verifier (const char *username, int username_len, const char *pass, int
    pass_len, char **bytes_salt, int salt_len, char **verifier, int
    *verifier_len)
```

Generate salt-verifier pair, given username, password and salt length.

---

**备注:** if API has returned ESP\_OK, salt and verifier generated need to be freed by caller

---



---

**备注:** Usually, username and password are not saved on the device. Rather salt and verifier are generated outside the device and are embedded. this convenience API can be used to generate salt and verifier on the fly for development use case. OR for devices which intentionally want to generate different password each time and can send it to the client securely. e.g., a device has a display and it shows the pin

---

#### 参数

- **username** -- [in] username
- **username\_len** -- [in] length of the username
- **pass** -- [in] password
- **pass\_len** -- [in] length of the password
- **bytes\_salt** -- [out] generated salt on successful generation, or NULL
- **salt\_len** -- [in] salt length
- **verifier** -- [out] generated verifier on successful generation, or NULL
- **verifier\_len** -- [out] length of the generated verifier

**返回** *esp\_err\_t* ESP\_OK on success, appropriate error otherwise

```
esp_err_t esp_srp_set_salt_verifier (esp_srp_handle_t *hd, const char *salt, int salt_len, const char
    *verifier, int verifier_len)
```

Set the Salt and Verifier pre-generated for a given password. This should be used only if the actual password is not available. The public key can then be generated using *esp\_srp\_srv\_pubkey\_from\_salt\_verifier()* and not *esp\_srp\_srv\_pubkey()*

#### 参数

- **hd** -- esp\_srp\_handle

- **salt** -- pre-generated salt bytes
- **salt\_len** -- length of the salt bytes
- **verifier** -- pre-generated verifier
- **verifier\_len** -- length of the verifier bytes

返回 esp\_err\_t ESP\_OK on success, appropriate error otherwise

*esp\_err\_t* **esp\_srp\_srv\_pubkey\_from\_salt\_verifier** (*esp\_srp\_handle\_t* \*hd, char \*\*bytes\_B, int \*len\_B)

Returns B (pub key)[Step2.b] when the salt and verifier are set using *esp\_srp\_set\_salt\_verifier()*

---

备注: \*bytes\_B MUST NOT BE FREED BY THE CALLER

---

#### 参数

- **hd** -- esp\_srp handle
- **bytes\_B** -- Key returned to the called
- **len\_B** -- Length of the key returned

返回 esp\_err\_t ESP\_OK on success, appropriate error otherwise

*esp\_err\_t* **esp\_srp\_get\_session\_key** (*esp\_srp\_handle\_t* \*hd, char \*bytes\_A, int len\_A, char \*\*bytes\_key, uint16\_t \*len\_key)

Get session key in \*bytes\_key given by len in \*len\_key. [Step2.c].

This calculated session key is used for further communication given the proofs are exchanged/authenticated with *esp\_srp\_exchange\_proofs*

---

备注: \*bytes\_key MUST NOT BE FREED BY THE CALLER

---

#### 参数

- **hd** -- esp\_srp handle
- **bytes\_A** -- Private Key
- **len\_A** -- Private Key length
- **bytes\_key** -- Key returned to the caller
- **len\_key** -- length of the key in \*bytes\_key

返回 esp\_err\_t ESP\_OK on success, appropriate error otherwise

*esp\_err\_t* **esp\_srp\_exchange\_proofs** (*esp\_srp\_handle\_t* \*hd, char \*username, uint16\_t username\_len, char \*bytes\_user\_proof, char \*bytes\_host\_proof)

Complete the authentication. If this step fails, the session\_key exchanged should not be used.

This is the final authentication step in SRP algorithm [Step4.1, Step4.b, Step4.c]

#### 参数

- **hd** -- esp\_srp handle
- **username** -- Username not expected NULL terminated
- **username\_len** -- Username length
- **bytes\_user\_proof** -- param in
- **bytes\_host\_proof** -- parameter out (should be SHA512\_DIGEST\_LENGTH) bytes in size

返回 esp\_err\_t ESP\_OK if user's proof is ok and subsequently bytes\_host\_proof is populated with our own proof.

### Type Definitions

```
typedef struct esp_srp_handle esp_srp_handle_t
    esp_srp handle as the result of esp_srp_init
```

The handle is returned by `esp_srp_init` on successful init. It is then passed for subsequent API calls as an argument. `esp_srp_free` can be used to clean up the handle. After `esp_srp_free` the handle becomes invalid.

### Enumerations

enum `esp_ng_type_t`

Large prime+generator to be used for the algorithm.

Values:

enumerator `ESP_NG_3072`

### Header File

- `components/protocomm/include/transport/protocomm_httpd.h`
- This header file can be included with:

```
#include "protocomm_httpd.h"
```

- This header file is a part of the API provided by the `protocomm` component. To declare that your component depends on `protocomm`, add the following to your `CMakeLists.txt`:

```
REQUIRES protocomm
```

or

```
PRIV_REQUIRES protocomm
```

### Functions

`esp_err_t protocomm_httpd_start(protocomm_t *pc, const protocomm_httpd_config_t *config)`

Start HTTPD protocomm transport.

This API internally creates a framework to allow endpoint registration and security configuration for the `protocomm`.

---

**备注:** This is a singleton. ie. Protocomm can have multiple instances, but only one instance can be bound to an HTTP transport layer.

---

#### 参数

- `pc` -- **[in]** Protocomm instance pointer obtained from `protocomm_new()`
- `config` -- **[in]** Pointer to config structure for initializing HTTP server

#### 返回

- `ESP_OK` : Success
- `ESP_ERR_INVALID_ARG` : Null arguments
- `ESP_ERR_NOT_SUPPORTED` : Transport layer bound to another protocomm instance
- `ESP_ERR_INVALID_STATE` : Transport layer already bound to this protocomm instance
- `ESP_ERR_NO_MEM` : Memory allocation for server resource failed
- `ESP_ERR_HTTPD_*` : HTTP server error on start

`esp_err_t protocomm_httpd_stop(protocomm_t *pc)`

Stop HTTPD protocomm transport.

This API cleans up the HTTPD transport protocomm and frees all the handlers registered with the protocomm.

参数 `pc` -- **[in]** Same protocomm instance that was passed to `protocomm_httpd_start()`

返回



- ESP\_OK : Success
- ESP\_ERR\_INVALID\_ARG : Null / incorrect protocomm instance pointer

## Unions

union **protocomm\_httpd\_config\_data\_t**

*#include <protocomm\_httpd.h>* Protocomm HTTPD Configuration Data

### Public Members

void \***handle**

HTTP Server Handle, if `ext_handle_provided` is set to true

*protocomm\_http\_server\_config\_t* **config**

HTTP Server Configuration, if a server is not already active

## Structures

struct **protocomm\_http\_server\_config\_t**

Config parameters for protocomm HTTP server.

### Public Members

uint16\_t **port**

Port on which the HTTP server will listen

size\_t **stack\_size**

Stack size of server task, adjusted depending upon stack usage of endpoint handler

unsigned **task\_priority**

Priority of server task

struct **protocomm\_httpd\_config\_t**

Config parameters for protocomm HTTP server.

### Public Members

bool **ext\_handle\_provided**

Flag to indicate of an external HTTP Server Handle has been provided. In such as case, protocomm will use the same HTTP Server and not start a new one internally.

*protocomm\_httpd\_config\_data\_t* **data**

Protocomm HTTPD Configuration Data

## Macros

**PROTOCOLM\_HTTPD\_DEFAULT\_CONFIG** ()

## Header File

- `components/protocomm/include/transport/protocomm_ble.h`
- This header file can be included with:

```
#include "protocomm_ble.h"
```

- This header file is a part of the API provided by the `protocomm` component. To declare that your component depends on `protocomm`, add the following to your `CMakeLists.txt`:

```
REQUIRES protocomm
```

or

```
PRIV_REQUIRES protocomm
```

## Functions

`esp_err_t protocomm_ble_start(protocomm_t *pc, const protocomm_ble_config_t *config)`

Start Bluetooth Low Energy based transport layer for provisioning.

Initialize and start required BLE service for provisioning. This includes the initialization for characteristics/service for BLE.

### 参数

- **pc** -- [in] Protocomm instance pointer obtained from `protocomm_new()`
- **config** -- [in] Pointer to config structure for initializing BLE

### 返回

- `ESP_OK` : Success
- `ESP_FAIL` : Simple BLE start error
- `ESP_ERR_NO_MEM` : Error allocating memory for internal resources
- `ESP_ERR_INVALID_STATE` : Error in ble config
- `ESP_ERR_INVALID_ARG` : Null arguments

`esp_err_t protocomm_ble_stop(protocomm_t *pc)`

Stop Bluetooth Low Energy based transport layer for provisioning.

Stops service/task responsible for BLE based interactions for provisioning

---

**备注:** You might want to optionally reclaim memory from Bluetooth. Refer to the documentation of `esp_bt_mem_release` in that case.

---

**参数** **pc** -- [in] Same protocomm instance that was passed to `protocomm_ble_start()`

### 返回

- `ESP_OK` : Success
- `ESP_FAIL` : Simple BLE stop error
- `ESP_ERR_INVALID_ARG` : Null / incorrect protocomm instance

## Structures

struct **name\_uuid**

This structure maps handler required by protocomm layer to UUIDs which are used to uniquely identify BLE characteristics from a smartphone or a similar client device.

## Public Members

const char \***name**

Name of the handler, which is passed to protocomm layer

uint16\_t **uuid**

UUID to be assigned to the BLE characteristic which is mapped to the handler

struct **protocomm\_ble\_event\_t**

Structure for BLE events in Protocomm.

### Public Members

uint16\_t **evt\_type**

This field indicates the type of BLE event that occurred.

uint16\_t **conn\_handle**

The handle of the relevant connection.

uint16\_t **conn\_status**

The status of the connection attempt; 0: the connection was successfully established. 0 BLE host error code: the connection attempt failed for the specified reason.

uint16\_t **disconnect\_reason**

Return code indicating the reason for the disconnect.

struct **protocomm\_ble\_config**

Config parameters for protocomm BLE service.

### Public Members

char **device\_name**[MAX\_BLE\_DEVNAME\_LEN + 1]

BLE device name being broadcast at the time of provisioning

uint8\_t **service\_uuid**[BLE\_UUID128\_VAL\_LENGTH]

128 bit UUID of the provisioning service

uint8\_t \***manufacturer\_data**

BLE device manufacturer data pointer in advertisement

ssize\_t **manufacturer\_data\_len**

BLE device manufacturer data length in advertisement

ssize\_t **nu\_lookup\_count**

Number of entries in the Name-UUID lookup table

*protocomm\_ble\_name\_uuid\_t* \***nu\_lookup**

Pointer to the Name-UUID lookup table

unsigned **ble\_bonding**

BLE bonding

unsigned **ble\_sm\_sc**

BLE security flag

unsigned **ble\_link\_encryption**

BLE security flag

uint8\_t \***ble\_addr**

BLE address

## Macros

**MAX\_BLE\_DEVNAME\_LEN**

BLE device name cannot be larger than this value 31 bytes (max scan response size) - 1 byte (length) - 1 byte (type) = 29 bytes

**BLE\_UUID128\_VAL\_LENGTH**

**MAX\_BLE\_MANUFACTURER\_DATA\_LEN**

Theoretically, the limit for max manufacturer length remains same as BLE device name i.e. 31 bytes (max scan response size) - 1 byte (length) - 1 byte (type) = 29 bytes However, manufacturer data goes along with BLE device name in scan response. So, it is important to understand the actual length should be smaller than (29 - (BLE device name length) - 2).

**BLE\_ADDR\_LEN**

## Type Definitions

typedef struct *name\_uuid* **protocomm\_ble\_name\_uuid\_t**

This structure maps handler required by protocomm layer to UUIDs which are used to uniquely identify BLE characteristics from a smartphone or a similar client device.

typedef struct *protocomm\_ble\_config* **protocomm\_ble\_config\_t**

Config parameters for protocomm BLE service.

## Enumerations

enum **protocomm\_transport\_ble\_event\_t**

Events generated by BLE transport.

These events are generated when the BLE transport is paired and disconnected.

*Values:*

enumerator **PROTOCOLM\_TRANSPORT\_BLE\_CONNECTED**

enumerator **PROTOCOLM\_TRANSPORT\_BLE\_DISCONNECTED**

## 2.9 存储 API

本节提供高层次的存储 API 的参考文档。这些 API 基于如 SPI flash、SD/MMC 等低层次驱动。

- 分区表 *API* 基于分区表，允许以块为单位访问 SPI flash。
- 非易失性存储库 (*NVS*) 在 SPI NOR flash 上实现了一个有容错性，和磨损均衡功能的键值对存储。
- 虚拟文件系统 (*VFS*) 库提供了一个用于注册文件系统驱动接口。SPIFFS、FAT 以及多种其他的文件系统库都基于 VFS。
- *SPIFFS* 是一个专为 SPI NOR flash 优化的磨损均衡的文件系统，非常适用于小分区和低吞吐率的应用。
- *FAT* 是一个可用于 SPI flash 或者 SD/MMC 存储卡的标准文件系统。
- 磨损均衡库实现了一个适用于 SPI NOR flash 的 flash 翻译层 (FTL)，用于 flash 中 FAT 分区的容器。

**备注：** 建议使用高层次的 API (`esp_partition` 或者文件系统) 而非低层次驱动 API 去访问 SPI NOR flash。

由于 NOR flash 和乐鑫硬件的一些限制，访问主 flash 会影响各个系统的性能。关于这些限制的更多信息，参见 *SPI flash API*。

## 2.9.1 FAT 文件系统

ESP-IDF 使用 *FatFs* 库来实现 FAT 文件系统。*FatFs* 库位于 `fatfs` 组件中，支持直接使用，也可以借助 C 标准库和 POSIX API 通过 VFS (虚拟文件系统) 使用 *FatFs* 库的大多数功能。

此外，我们对 *FatFs* 库进行了扩展，新增了支持可插拔磁盘 I/O 调度层，从而允许在运行时将 *FatFs* 驱动映射到物理磁盘。

### FatFs 与 VFS 配合使用

头文件 `fatfs/vfs/esp_vfs_fat.h` 定义了连接 *FatFs* 和 VFS 的函数。

函数 `esp_vfs_fat_register()` 分配一个 FATFS 结构，并在 VFS 中注册特定路径前缀。如果文件路径以此前缀开头，则对此文件的后续操作将转至 *FatFs* API。

函数 `esp_vfs_fat_unregister_path()` 删除在 VFS 中的注册，并释放 FATFS 结构。

多数应用程序在使用 `esp_vfs_fat_` 函数时，采用如下步骤：

1. 调用 `esp_vfs_fat_register()`，指定：
  - 挂载文件系统的路径前缀 (例如，`"/sdcard"` 或 `"/spiflash"`)
  - *FatFs* 驱动编号
  - 一个用于接收指向 FATFS 结构指针的变量
2. 调用 `ff_diskio_register()`，为步骤 1 中的驱动编号注册磁盘 I/O 驱动；
3. 如需使用与传递到 `esp_vfs_fat_register()` 相同的驱动编号挂载文件系统，可调用 *FatFs* 函数 `f_mount()`。如果目标逻辑驱动上不存在该文件系统，`f_mount()` 将调用失败并报告 `FR_NO_FILESYSTEM` 错误。此时，应首先调用 `f_mkfs()`，在驱动上创建新的 *FatFS* 结构体，然后重新调用 `f_mount()`。注意，应在上述步骤之前调用 `f_fdisk()` 对 SD 卡进行分区。请参考 *FatFs 文档*，查看更多信息；
4. 调用 C 标准库和 POSIX API 对路径中带有步骤 1 中所述前缀的文件 (例如，`"/sdcard/hello.txt"`) 执行打开、读取、写入、擦除、复制等操作。文件系统默认使用 *8.3 文件名* 格式 (SFN)。如需使用长文件名 (LFN)，启用 `CONFIG_FATFS_LONG_FILENAMES` 选项。请参考 *FatFs 文件系统*，查看更多信息；
5. 可以直接调用 *FatFs* 库函数，但需要使用没有 VFS 前缀的路径，如 `"/hello.txt"`；
6. 关闭所有打开的文件；
7. 调用 *FatFs* 函数 `f_mount()` 并使用 `NULL` `FATFS*` 参数，为与上述编号相同的驱动卸载文件系统；
8. 调用 *FatFs* 函数 `ff_diskio_register()` 并使用 `NULL` `ff_diskio_impl_t*` 参数和相同的驱动编号，来释放注册的磁盘 I/O 驱动；
9. 调用 `esp_vfs_fat_unregister_path()` 并使用文件系统挂载的路径将 *FatFs* 从 VFS 中移除，并释放步骤 1 中分配的 FATFS 结构。

便捷函数 `esp_vfs_fat_sdmmc_mount()`、`esp_vfs_fat_sdspi_mount()` 和 `esp_vfs_fat_sdcard_unmount()` 对上述步骤进行了封装，并加入了对 SD 卡初始化的处理。我们将在下一章节详细介绍以上函数。

---

**备注：** FAT 文件系统不支持硬链接，因此调用 `link()` 后会复制文件内容（仅适用于 FatFs 卷上的文件）。

---

### FatFs 与 VFS 和 SD 卡配合使用

头文件 `fatfs/vfs/esp_vfs_fat.h` 定义了便捷函数 `esp_vfs_fat_sdmmc_mount()`、`esp_vfs_fat_sdspi_mount()` 和 `esp_vfs_fat_sdcard_unmount()`。这些函数分别执行上一章节的步骤 1-3 和步骤 7-9，并初始化 SD 卡，但仅提供有限的错误处理功能。我们鼓励开发人员查看源代码，将更多高级功能集成到产品应用中。

便捷函数 `esp_vfs_fat_sdmmc_unmount()` 用于卸载文件系统并释放从 `esp_vfs_fat_sdmmc_mount()` 函数获取的资源。

### FatFs 与 VFS 配合使用（只读模式下）

头文件 `fatfs/vfs/esp_vfs_fat.h` 也定义了两个便捷函数 `esp_vfs_fat_spiflash_mount_ro()` 和 `esp_vfs_fat_spiflash_unmount_ro()`。上述两个函数分别对 FAT 只读分区执行步骤 1-3 和步骤 7-9。有些数据分区仅在工厂配置时写入一次，之后在整个硬件生命周期内都不会再有任何改动。利用上述两个函数处理这种数据分区非常方便。

### 配置选项

FatFs 组件有以下配置选项：

- **CONFIG\_FATFS\_USE\_FASTSEEK** - 如果启用该选项，POSIX `lseek()` 函数将以更快的速度执行。快速查找不适用于编辑模式下的文件，所以，使用快速查找时，应在只读模式下打开（或者关闭然后重新打开）文件。
- **CONFIG\_FATFS\_IMMEDIATE\_FSYNC** - 如果启用该选项，FatFs 将在每次调用 `write()`、`pwrite()`、`link()`、`truncate()` 和 `ftruncate()` 函数后，自动调用 `f_sync()` 以同步最近的文件改动。该功能可提高文件系统中文件的一致性和文件大小报告的准确性，但由于需要频繁进行磁盘操作，性能将会受到影响。
- **CONFIG\_FATFS\_LINK\_LOCK** - 如果启用该选项，可保证 API 的线程安全，但如果应用程序需要快速频繁地进行小文件操作（例如将日志记录到文件），则可能有必要禁用该选项。请注意，如果禁用该选项，调用 `link()` 后的复制操作将是非原子的，此时如果在不同任务中对同一卷上的大文件调用 `link()`，则无法确保线程安全。

### FatFs 磁盘 I/O 层

我们对 FatFs API 函数进行了扩展，实现了运行期间注册磁盘 I/O 驱动。

上述 API 为 SD/MMC 卡提供了磁盘 I/O 函数实现方式，可使用 `ff_diskio_register_sdmmc()` 函数注册指定的 FatFs 驱动编号。

```
void ff_diskio_register (BYTE pdrv, const ff_diskio_impl_t *discio_impl)
```

Register or unregister diskio driver for given drive number.

When FATFS library calls one of `disk_XXX` functions for driver number `pdrv`, corresponding function in `discio_impl` for given `pdrv` will be called.

#### 参数

- **pdrv** -- drive number
- **discio\_impl** -- pointer to `ff_diskio_impl_t` structure with diskio functions or NULL to unregister and free previously registered drive

struct **ff\_diskio\_impl\_t**

Structure of pointers to disk IO driver functions.

See FatFs documentation for details about these functions

### Public Members

DSTATUS (**\*init**)(unsigned char pdrv)

disk initialization function

DSTATUS (**\*status**)(unsigned char pdrv)

disk status check function

DRESULT (**\*read**)(unsigned char pdrv, unsigned char \*buff, uint32\_t sector, unsigned count)

sector read function

DRESULT (**\*write**)(unsigned char pdrv, const unsigned char \*buff, uint32\_t sector, unsigned count)

sector write function

DRESULT (**\*ioctl**)(unsigned char pdrv, unsigned char cmd, void \*buff)

function to get info about disk and do some misc operations

void **ff\_diskio\_register\_sdmmc** (unsigned char pdrv, sdmmc\_card\_t \*card)

Register SD/MMC diskio driver

#### 参数

- **pdrv** -- drive number
- **card** -- pointer to sdmmc\_card\_t structure describing a card; card should be initialized before calling f\_mount.

*esp\_err\_t* **ff\_diskio\_register\_wl\_partition** (unsigned char pdrv, *wl\_handle\_t* flash\_handle)

Register spi flash partition

#### 参数

- **pdrv** -- drive number
- **flash\_handle** -- handle of the wear levelling partition.

*esp\_err\_t* **ff\_diskio\_register\_raw\_partition** (unsigned char pdrv, const *esp\_partition\_t* \*part\_handle)

Register spi flash partition

#### 参数

- **pdrv** -- drive number
- **part\_handle** -- pointer to raw flash partition.

## FatFs 分区生成器

我们为 FatFs ([wl\\_fatfsngen.py](#)) 提供了分区生成器，该生成器集成在构建系统中，方便用户在自己的项目中使用。

该生成器可以在主机上创建文件系统镜像，并用指定的主机文件夹内容对其进行填充。

该脚本是建立在分区生成器的基础上 ([fatfsngen.py](#))，目前除了可以生成分区外，也可以初始化磨损均衡。

目前的最新版本支持短文件名、长文件名、FAT12 和 FAT16。长文件名的上限是 255 个字符，文件名中可以包含多个 . 字符以及其他字符，如 +、,、;、=、[ and ] 等。

如需进一步了解 FatFs 分区生成器或分区分析器，请查看 [Generating and parsing FAT partition on host](#)。



**构建系统中使用 FatFs 分区生成器** 通过调用 `fatfs_create_partition_image` 可以直接从 CMake 构建系统中调用 FatFs 分区生成器:

```
fatfs_create_spiflash_image(<partition> <base_dir> [FLASH_IN_PROJECT])
```

如果不希望在生成分区时使用磨损均衡, 可以使用 `fatfs_create_rawflash_image`:

```
fatfs_create_rawflash_image(<partition> <base_dir> [FLASH_IN_PROJECT])
```

`fatfs_create_spiflash_image` 以及 `fatfs_create_rawflash_image` 必须从项目的 `CMakeLists.txt` 中调用。

如果决定使用 `fatfs_create_rawflash_image` (不支持磨损均衡), 请注意它仅支持在设备中以只读模式安装。

该函数的参数如下:

1. `partition` - 分区的名称, 需要在分区表中定义 (如 [storage/fatfs/gen/partitions\\_example.csv](#))。
2. `base_dir` - 目录名称, 该目录会被编码为 FatFs 分区, 也可以选择将其被烧录进设备。但注意必须在分区表中指定合适的分区大小。
3. `FLASH_IN_PROJECT` 标志 - 可选参数, 用户可以通过指定 `FLASH_IN_PROJECT`, 选择在执行 `idf.py flash -p <PORT>` 时让分区镜像自动与应用程序二进制文件、分区表等一同烧录进设备。
4. `PRESERVE_TIME` 标志 - 可选参数, 用户可强制让目标镜像保留源文件夹的时间戳。如果不保留, 每个目标镜像的时间戳都将设置为 FATFS 默认初始时间 (1980 年 1 月 1 日)。
5. `ONE_FAT` 标志 - 可选参数, 支持生成仅包含单个 FAT (文件分配表) 的 FATFS 卷。与包含两个 FAT 的 FATFS 卷相比, 这样做可以拥有相对较大的可用空间 (通过 FAT 使用的扇区数 \* 扇区大小计算), 但会增加 FATFS 卷损坏的风险。

例如:

```
fatfs_create_partition_image(my_fatfs_partition my_folder FLASH_IN_PROJECT)
```

没有指定 `FLASH_IN_PROJECT` 时也可以生成分区镜像, 但是用户需要使用 `esptool.py` 或自定义的构建系统目标对其手动烧录。

相关示例请查看 [storage/fatfs/gen](#)。

## FatFs 分区分析器

我们为 FatFs 提供分区分析器 ([fatfsparse.py](#))。

该分析器为 FatFs 分区生成器 ([fatfs/gen.py](#)) 的逆向工具, 可以根据 FatFs 镜像在主机上生成文件夹结构。

可以使用:

```
./fatfsparse.py [-h] [--wl-layer {detect,enabled,disabled}] [--verbose] fatfs_
↪image.img
```

生成文件夹结构之前, 参数 `--verbose` 将根据 FatFs 镜像的引导扇区在终端打印详细信息。

## 高级 API 参考

### Header File

- [components/fatfs/vfs/esp\\_vfs\\_fat.h](#)
- This header file can be included with:

```
#include "esp_vfs_fat.h"
```

- This header file is a part of the API provided by the `fatfs` component. To declare that your component depends on `fatfs`, add the following to your `CMakeLists.txt`:



```
REQUIRES fatfs
```

or

```
PRIV_REQUIRES fatfs
```

## Functions

*esp\_err\_t* **esp\_vfs\_fat\_register\_cfg** (const *esp\_vfs\_fat\_conf\_t* \*conf, FATFS \*\*out\_fs)

Register FATFS with VFS component.

This function registers given FAT drive in VFS, at the specified base path. Input arguments are held in *esp\_vfs\_fat\_conf\_t* structure. If only one drive is used, *fat\_drive* argument can be an empty string. Refer to FATFS library documentation on how to specify FAT drive. This function also allocates FATFS structure which should be used for *f\_mount* call.

---

**备注:** This function doesn't mount the drive into FATFS, it just connects POSIX and C standard library IO function with FATFS. You need to mount desired drive into FATFS separately.

---

### 参数

- **conf** -- pointer to *esp\_vfs\_fat\_conf\_t* configuration structure
- **out\_fs** -- [out] pointer to FATFS structure which can be used for FATFS *f\_mount* call is returned via this argument.

### 返回

- ESP\_OK on success
- ESP\_ERR\_INVALID\_STATE if *esp\_vfs\_fat\_register* was already called
- ESP\_ERR\_NO\_MEM if not enough memory or too many VFSes already registered

*esp\_err\_t* **esp\_vfs\_fat\_unregister\_path** (const char \*base\_path)

Un-register FATFS from VFS.

---

**备注:** FATFS structure returned by *esp\_vfs\_fat\_register* is destroyed after this call. Make sure to call *f\_mount* function to unmount it before calling *esp\_vfs\_fat\_unregister\_path*. Difference between this function and the one above is that this one will release the correct drive, while the one above will release the last registered one

---

**参数** **base\_path** -- path prefix where FATFS is registered. This is the same used when *esp\_vfs\_fat\_register* was called

### 返回

- ESP\_OK on success
- ESP\_ERR\_INVALID\_STATE if FATFS is not registered in VFS

*esp\_err\_t* **esp\_vfs\_fat\_sdmmc\_mount** (const char \*base\_path, const *sdmmc\_host\_t* \*host\_config, const void \*slot\_config, const *esp\_vfs\_fat\_mount\_config\_t* \*mount\_config, *sdmmc\_card\_t* \*\*out\_card)

Convenience function to get FAT filesystem on SD card registered in VFS.

This is an all-in-one function which does the following:

- initializes SDMMC driver or SPI driver with configuration in *host\_config*
- initializes SD card with configuration in *slot\_config*
- mounts FAT partition on SD card using FATFS library, with configuration in *mount\_config*
- registers FATFS library with VFS, with prefix given by *base\_prefix* variable

This function is intended to make example code more compact. For real world applications, developers should implement the logic of probing SD card, locating and mounting partition, and registering FATFS in VFS, with proper error checking and handling of exceptional conditions.

---

**备注:** Use this API to mount a card through SDSPI is deprecated. Please call `esp_vfs_fat_sdspi_mount()` instead for that case.

---

### 参数

- **base\_path** -- path where partition should be registered (e.g. `"/sdcard"`)
- **host\_config** -- Pointer to structure describing SDMMC host. When using SDMMC peripheral, this structure can be initialized using `SDMMC_HOST_DEFAULT()` macro. When using SPI peripheral, this structure can be initialized using `SDSPI_HOST_DEFAULT()` macro.
- **slot\_config** -- Pointer to structure with slot configuration. For SDMMC peripheral, pass a pointer to `sdmmc_slot_config_t` structure initialized using `SDMMC_SLOT_CONFIG_DEFAULT`.
- **mount\_config** -- pointer to structure with extra parameters for mounting FATFS
- **out\_card** -- **[out]** if not NULL, pointer to the card information structure will be returned via this argument

### 返回

- ESP\_OK on success
- ESP\_ERR\_INVALID\_STATE if `esp_vfs_fat_sdmmc_mount` was already called
- ESP\_ERR\_NO\_MEM if memory can not be allocated
- ESP\_FAIL if partition can not be mounted
- other error codes from SDMMC or SPI drivers, SDMMC protocol, or FATFS drivers

`esp_err_t esp_vfs_fat_sdspi_mount` (const char \*base\_path, const sdmmc\_host\_t \*host\_config\_input, const *sdspi\_device\_config\_t* \*slot\_config, const *esp\_vfs\_fat\_mount\_config\_t* \*mount\_config, sdmmc\_card\_t \*\*out\_card)

Convenience function to get FAT filesystem on SD card registered in VFS.

This is an all-in-one function which does the following:

- initializes an SPI Master device based on the SPI Master driver with configuration in `slot_config`, and attach it to an initialized SPI bus.
- initializes SD card with configuration in `host_config_input`
- mounts FAT partition on SD card using FATFS library, with configuration in `mount_config`
- registers FATFS library with VFS, with prefix given by `base_prefix` variable

This function is intended to make example code more compact. For real world applications, developers should implement the logic of probing SD card, locating and mounting partition, and registering FATFS in VFS, with proper error checking and handling of exceptional conditions.

---

**备注:** This function try to attach the new SD SPI device to the bus specified in `host_config`. Make sure the SPI bus specified in `host_config->slot` have been initialized by `spi_bus_initialize()` before.

---

### 参数

- **base\_path** -- path where partition should be registered (e.g. `"/sdcard"`)
- **host\_config\_input** -- Pointer to structure describing SDMMC host. This structure can be initialized using `SDSPI_HOST_DEFAULT()` macro.
- **slot\_config** -- Pointer to structure with slot configuration. For SPI peripheral, pass a pointer to *sdspi\_device\_config\_t* structure initialized using `SDSPI_DEVICE_CONFIG_DEFAULT()`.
- **mount\_config** -- pointer to structure with extra parameters for mounting FATFS
- **out\_card** -- **[out]** If not NULL, pointer to the card information structure will be returned via this argument. It is suggested to hold this handle and use it to unmount the card later if needed. Otherwise it's not suggested to use more than one card at the same time and unmount one of them in your application.

### 返回

- ESP\_OK on success
- ESP\_ERR\_INVALID\_STATE if esp\_vfs\_fat\_sdmmc\_mount was already called
- ESP\_ERR\_NO\_MEM if memory can not be allocated
- ESP\_FAIL if partition can not be mounted
- other error codes from SDMMC or SPI drivers, SDMMC protocol, or FATFS drivers

*esp\_err\_t* **esp\_vfs\_fat\_sdmmc\_unmount** (void)

Unmount FAT filesystem and release resources acquired using esp\_vfs\_fat\_sdmmc\_mount.

*Deprecated:*

Use esp\_vfs\_fat\_sdcard\_unmount () instead.

返回

- ESP\_OK on success
- ESP\_ERR\_INVALID\_STATE if esp\_vfs\_fat\_sdmmc\_mount hasn't been called

*esp\_err\_t* **esp\_vfs\_fat\_sdcard\_unmount** (const char \*base\_path, sdmmc\_card\_t \*card)

Unmount an SD card from the FAT filesystem and release resources acquired using esp\_vfs\_fat\_sdmmc\_mount () or esp\_vfs\_fat\_sdspi\_mount ()

返回

- ESP\_OK on success
- ESP\_ERR\_INVALID\_ARG if the card argument is unregistered
- ESP\_ERR\_INVALID\_STATE if esp\_vfs\_fat\_sdmmc\_mount hasn't been called

*esp\_err\_t* **esp\_vfs\_fat\_sdcard\_format\_cfg** (const char \*base\_path, sdmmc\_card\_t \*card, *esp\_vfs\_fat\_mount\_config\_t* \*cfg)

Format FAT filesystem with given configuration.

---

**备注:** This API should be only called when the FAT is already mounted.

---

参数

- **base\_path** -- Path where partition should be registered (e.g. "/sdcard")
- **card** -- Pointer to the card handle, which should be initialised by calling esp\_vfs\_fat\_sdspi\_mount first
- **cfg** -- Pointer to structure with extra parameters for formatting FATFS (only relevant fields are used). If NULL, the previous configuration will be used.

返回

- ESP\_OK
- ESP\_ERR\_INVALID\_STATE: FAT partition isn't mounted, call esp\_vfs\_fat\_sdmmc\_mount or esp\_vfs\_fat\_sdspi\_mount first
- ESP\_ERR\_NO\_MEM: if memory can not be allocated
- ESP\_FAIL: fail to format it, or fail to mount back

*esp\_err\_t* **esp\_vfs\_fat\_sdcard\_format** (const char \*base\_path, sdmmc\_card\_t \*card)

Format FAT filesystem.

---

**备注:** This API should be only called when the FAT is already mounted.

---

参数

- **base\_path** -- Path where partition should be registered (e.g. "/sdcard")
- **card** -- Pointer to the card handle, which should be initialised by calling esp\_vfs\_fat\_sdspi\_mount first

返回

- ESP\_OK
- ESP\_ERR\_INVALID\_STATE: FAT partition isn't mounted, call `esp_vfs_fat_sdmmc_mount` or `esp_vfs_fat_sdspi_mount` first
- ESP\_ERR\_NO\_MEM: if memory can not be allocated
- ESP\_FAIL: fail to format it, or fail to mount back

*esp\_err\_t* `esp_vfs_fat_spiflash_mount_rw_wl` (const char \*base\_path, const char \*partition\_label, const *esp\_vfs\_fat\_mount\_config\_t* \*mount\_config, *wl\_handle\_t* \*wl\_handle)

Convenience function to initialize FAT filesystem in SPI flash and register it in VFS.

This is an all-in-one function which does the following:

- finds the partition with defined partition\_label. Partition label should be configured in the partition table.
- initializes flash wear levelling library on top of the given partition
- mounts FAT partition using FATFS library on top of flash wear levelling library
- registers FATFS library with VFS, with prefix given by base\_prefix variable

This function is intended to make example code more compact.

#### 参数

- **base\_path** -- path where FATFS partition should be mounted (e.g. `"/spiflash"`)
- **partition\_label** -- label of the partition which should be used
- **mount\_config** -- pointer to structure with extra parameters for mounting FATFS
- **wl\_handle** -- [out] wear levelling driver handle

#### 返回

- ESP\_OK on success
- ESP\_ERR\_NOT\_FOUND if the partition table does not contain FATFS partition with given label
- ESP\_ERR\_INVALID\_STATE if `esp_vfs_fat_spiflash_mount_rw_wl` was already called
- ESP\_ERR\_NO\_MEM if memory can not be allocated
- ESP\_FAIL if partition can not be mounted
- other error codes from wear levelling library, SPI flash driver, or FATFS drivers

*esp\_err\_t* `esp_vfs_fat_spiflash_unmount_rw_wl` (const char \*base\_path, *wl\_handle\_t* wl\_handle)

Unmount FAT filesystem and release resources acquired using `esp_vfs_fat_spiflash_mount_rw_wl`.

#### 参数

- **base\_path** -- path where partition should be registered (e.g. `"/spiflash"`)
- **wl\_handle** -- wear levelling driver handle returned by `esp_vfs_fat_spiflash_mount_rw_wl`

#### 返回

- ESP\_OK on success
- ESP\_ERR\_INVALID\_STATE if `esp_vfs_fat_spiflash_mount_rw_wl` hasn't been called

*esp\_err\_t* `esp_vfs_fat_spiflash_format_cfg_rw_wl` (const char \*base\_path, const char \*partition\_label, *esp\_vfs\_fat\_mount\_config\_t* \*cfg)

Format FAT filesystem with given configuration.

---

**备注:** This API can be called when the FAT is mounted / not mounted. If this API is called when the FAT isn't mounted (by calling `esp_vfs_fat_spiflash_mount_rw_wl`), this API will first mount the FAT then format it, then restore back to the original state.

---

#### 参数

- **base\_path** -- Path where partition should be registered (e.g. `"/spiflash"`)
- **partition\_label** -- Label of the partition which should be used

- **cfg** -- Pointer to structure with extra parameters for formatting FATFS (only relevant fields are used). If NULL and mounted the previous configuration will be used. If NULL and unmounted the default configuration will be used.

**返回**

- ESP\_OK
- ESP\_ERR\_NO\_MEM: if memory can not be allocated
- Other errors from esp\_vfs\_fat\_spiflash\_mount\_rw\_wl

*esp\_err\_t* **esp\_vfs\_fat\_spiflash\_format\_rw\_wl** (const char \*base\_path, const char \*partition\_label)

Format FAT filesystem.

---

**备注:** This API can be called when the FAT is mounted / not mounted. If this API is called when the FAT isn't mounted (by calling esp\_vfs\_fat\_spiflash\_mount\_rw\_wl), this API will first mount the FAT then format it, then restore back to the original state.

---

**参数**

- **base\_path** -- Path where partition should be registered (e.g. "/spiflash")
- **partition\_label** -- Label of the partition which should be used

**返回**

- ESP\_OK
- ESP\_ERR\_NO\_MEM: if memory can not be allocated
- Other errors from esp\_vfs\_fat\_spiflash\_mount\_rw\_wl

*esp\_err\_t* **esp\_vfs\_fat\_spiflash\_mount\_ro** (const char \*base\_path, const char \*partition\_label, const *esp\_vfs\_fat\_mount\_config\_t* \*mount\_config)

Convenience function to initialize read-only FAT filesystem and register it in VFS.

This is an all-in-one function which does the following:

- finds the partition with defined partition\_label. Partition label should be configured in the partition table.
- mounts FAT partition using FATFS library
- registers FATFS library with VFS, with prefix given by base\_prefix variable

---

**备注:** Wear levelling is not used when FAT is mounted in read-only mode using this function.

---

**参数**

- **base\_path** -- path where FATFS partition should be mounted (e.g. "/spiflash")
- **partition\_label** -- label of the partition which should be used
- **mount\_config** -- pointer to structure with extra parameters for mounting FATFS

**返回**

- ESP\_OK on success
- ESP\_ERR\_NOT\_FOUND if the partition table does not contain FATFS partition with given label
- ESP\_ERR\_INVALID\_STATE if esp\_vfs\_fat\_spiflash\_mount\_ro was already called for the same partition
- ESP\_ERR\_NO\_MEM if memory can not be allocated
- ESP\_FAIL if partition can not be mounted
- other error codes from SPI flash driver, or FATFS drivers

*esp\_err\_t* **esp\_vfs\_fat\_spiflash\_unmount\_ro** (const char \*base\_path, const char \*partition\_label)

Unmount FAT filesystem and release resources acquired using esp\_vfs\_fat\_spiflash\_mount\_ro.

**参数**

- **base\_path** -- path where partition should be registered (e.g. "/spiflash")

- **partition\_label** -- label of partition to be unmounted

**返回**

- ESP\_OK on success
- ESP\_ERR\_INVALID\_STATE if esp\_vfs\_fat\_spiflash\_mount\_ro hasn't been called

*esp\_err\_t* **esp\_vfs\_fat\_info** (const char \*base\_path, uint64\_t \*out\_total\_bytes, uint64\_t \*out\_free\_bytes)

Get information for FATFS partition.

**参数**

- **base\_path** -- Base path of the partition examined (e.g. "/spiflash")
- **out\_total\_bytes** -- [out] Size of the file system
- **out\_free\_bytes** -- [out] Free bytes available in the file system

**返回**

- ESP\_OK on success
- ESP\_ERR\_INVALID\_STATE if partition not found
- ESP\_FAIL if another FRESULT error (saved in errno)

*esp\_err\_t* **esp\_vfs\_fat\_create\_contiguous\_file** (const char \*base\_path, const char \*full\_path, uint64\_t size, bool alloc\_now)

Create a file with contiguous space at given path.

---

**备注:** The file cannot exist before calling this function (or the file size has to be 0) For more information see documentation for `f_expand` from FATFS library

---

**参数**

- **base\_path** -- Base path of the partition examined (e.g. "/spiflash")
- **full\_path** -- Full path of the file (e.g. "/spiflash/ABC.TXT")
- **size** -- File size expanded to, number of bytes in size to prepare or allocate for the file
- **alloc\_now** -- True == allocate space now, false == prepare to allocate –see `f_expand` from FATFS

**返回**

- ESP\_OK on success
- ESP\_ERR\_INVALID\_ARG if invalid arguments (e.g. any of arguments are NULL or size lower or equal to 0)
- ESP\_ERR\_INVALID\_STATE if partition not found
- ESP\_FAIL if another FRESULT error (saved in errno)

*esp\_err\_t* **esp\_vfs\_fat\_test\_contiguous\_file** (const char \*base\_path, const char \*full\_path, bool \*is\_contiguous)

Test if a file is contiguous in the FAT filesystem.

**参数**

- **base\_path** -- Base path of the partition examined (e.g. "/spiflash")
- **full\_path** -- Full path of the file (e.g. "/spiflash/ABC.TXT")
- **is\_contiguous** -- [out] True == allocate space now, false == prepare to allocate –see `f_expand` from FATFS

**返回**

- ESP\_OK on success
- ESP\_ERR\_INVALID\_ARG if invalid arguments (e.g. any of arguments are NULL)
- ESP\_ERR\_INVALID\_STATE if partition not found
- ESP\_FAIL if another FRESULT error (saved in errno)

**Structures**

struct **esp\_vfs\_fat\_conf\_t**

Configuration structure for esp\_vfs\_fat\_register.

### Public Members

const char \***base\_path**

Path prefix where FATFS should be registered,

const char \***fat\_drive**

FATFS drive specification; if only one drive is used, can be an empty string.

size\_t **max\_files**

Maximum number of files which can be open at the same time.

struct **esp\_vfs\_fat\_mount\_config\_t**

Configuration arguments for `esp_vfs_fat_sdmmc_mount` and `esp_vfs_fat_spiflash_mount_rw_wl` functions.

### Public Members

bool **format\_if\_mount\_failed**

If FAT partition can not be mounted, and this parameter is true, create partition table and format the filesystem.

int **max\_files**

Max number of open files.

size\_t **allocation\_unit\_size**

If `format_if_mount_failed` is set, and mount fails, format the card with given allocation unit size. Must be a power of 2, between sector size and  $128 * \text{sector size}$ . For SD cards, sector size is always 512 bytes. For wear\_leveling, sector size is determined by `CONFIG_WL_SECTOR_SIZE` option.

Using larger allocation unit size will result in higher read/write performance and higher overhead when storing small files.

Setting this field to 0 will result in allocation unit set to the sector size.

bool **disk\_status\_check\_enable**

Enables real `ff_disk_status` function implementation for SD cards (`ff_sdmmc_status`). Possibly slows down IO performance.

Try to enable if you need to handle situations when SD cards are not unmounted properly before physical removal or you are experiencing issues with SD cards.

Doesn't do anything for other memory storage media.

bool **use\_one\_fat**

Use 1 FAT (File Allocation Tables) instead of 2. This decreases reliability, but makes more space available (usually only one sector). Note that this option has effect only when the filesystem is formatted. When mounting an already-formatted partition, the actual number of FATs may be different.

### Macros

**VFS\_FAT\_MOUNT\_DEFAULT\_CONFIG()**

### Type Definitions

typedef *esp\_vfs\_fat\_mount\_config\_t* **esp\_vfs\_fat\_sdmmc\_mount\_config\_t**

## 2.9.2 量产程序

### 介绍

这一程序主要用于量产时为每一设备创建工厂 NVS（非易失性存储器）分区镜像。NVS 分区镜像由 CSV（逗号分隔值）文件生成，文件中包含了用户提供的配置项及配置值。

注意，该程序仅创建用于量产的二进制镜像，您需要使用以下工具将镜像烧录到设备上：

- [esptool.py](#)
- [Flash 下载工具](#)（仅适用于 Windows）。下载后解压，然后按照 doc 文件夹中的说明操作。
- 使用定制的生产工具直接烧录程序

### 准备工作

该程序依赖于 `esp-idf` 的 NVS 分区程序

- 操作系统要求：
  - Linux、MacOS 或 Windows（标准版）
- 安装依赖包：
  - [Python](#)

### 备注：

使用该程序之前，请确保：

- Python 路径已添加到 PATH 环境变量中；
- 已经安装 `requirement.txt` 中的软件包，`requirement.txt` 在 `esp-idf` 根目录下。

### 具体流程



### CSV 配置文件

CSV 配置文件中包含设备待烧录的配置信息，定义了待烧录的配置项。

配置文件中数据格式如下（*REPEAT* 标签可选）：

```

name1,namespace,    <-- 第一个条目应该为 "namespace" 类型
key1,type1,encoding1
key2,type2,encoding2,REPEAT
name2,namespace,
key3,type3,encoding3
key4,type4,encoding4
  
```

**备注：** 文件第一行应始终为 `namespace` 条目。



每行应包含三个参数: `key`、`type` 和 `encoding`，并以逗号分隔。如果有 `REPEAT` 标签，则主 CSV 文件中所有设备此键值均相同。

有关各个参数的详细说明，请参阅 *NVS* 分区生成程序的 *README* 文件。

CSV 配置文件示例如下:

```
app,namespace,
firmware_key,data,hex2bin
serial_no,data,string,REPEAT
device_no,data,i32
```

#### 备注:

#### 请确保:

- 逗号','前后无空格;
- CSV 文件每行末尾无空格。

### 主 CSV 文件

主 CSV 文件中包含设备待烧录的详细信息，文件中每行均对应一个设备实体。

主 CSV 文件的数据格式如下:

```
key1,key2,key3,....
value1,value2,value3,....
```

**备注:** 文件中键 (`key`) 名应始终置于文件首行。从配置文件中获取的键，在此文件中的排列顺序应与其在配置文件中的排列顺序相同。主 CSV 文件同时可以包含其它列 (键)，这些列将被视为元数据，而不会编译进最终二进制文件。

每行应包含相应键的键值 (`value`)，并用逗号隔开。如果某键带有 `REPEAT` 标签，则仅需在第二行 (即第一个条目) 输入对应的值，后面其他行为空。

参数描述如下:

#### **value** Data value

`value` 是与键对应的键值。

主 CSV 文件示例如下:

```
id,firmware_key,serial_no,device_no
1,1a2b3c4d5e6faabb,A1,101
2,1a2b3c4d5e6fccdd,,102
3,1a2b3c4d5e6feeff,,103
```

**备注:** 如果出现 *REPEAT* 标签，则会在相同目录下生成一个新的主 CSV 文件用作主输入文件，并在每行为带有 *REPEAT* 标签的键插入键值。

量产程序还会创建中间 CSV 文件，*NVS* 分区程序将使用此 CSV 文件作为输入，然后生成二进制文件。

中间 CSV 文件的格式如下:

```
key,type,encoding,value
key,namespace, ,
key1,type1,encoding1,value1
key2,type2,encoding2,value2
```

此步骤将为每一设备生成一个中间 CSV 文件。

## 运行量产程序

### 使用方法:

```
python mfg_gen.py [-h] {generate,generate-key} ...
```

### 可选参数:

序号	参数	描述
1	-h, --help	显示帮助信息并退出

### 命令:

运行 `mfg_gen.py {command} -h` 查看更多帮助信息

序号	参数	描述
1	generate	生成 NVS 分区
2	generate-key	生成加密密钥

## 为每个设备生成工厂镜像 (默认)

### 使用方法:

```
python mfg_gen.py generate [-h] [--fileid FILEID] [--version {1,2}] [--keygen]
                             [--keyfile KEYFILE] [--inputkey INPUTKEY]
                             [--outdir OUTDIR]
                             conf values prefix size
```

### 位置参数:

参数	描述
conf	待解析的 CSV 配置文件路径
values	待解析的主 CSV 文件路径
prefix	每个输出文件名前缀的唯一名称
size	NVS 分区大小 (以字节为单位, 且为 4096 的整数倍)

### 可选参数:

参数	描述
-h, --help	显示帮助信息并退出
--fileid FILEID	每个文件名后缀的唯一文件标识符 (主 CSV 文件中的任意键), 默认为数值 1、2、3...
--version {1,2}	<ul style="list-style-type: none"> <li>设置多页 Blob 版本。</li> <li>版本 1 - 禁用多页 Blob;</li> <li>版本 2 - 启用多页 Blob;</li> <li>默认版本: 版本 2</li> </ul>
--keygen	生成 NVS 分区加密密钥
--inputkey INPUTKEY	内含 NVS 分区加密密钥的文件
--outdir OUTDIR	输出目录, 用于存储创建的文件 (默认当前目录)

请运行以下命令为每个设备生成工厂镜像, 量产程序同时提供了一个 CSV 示例文件:

```
python mfg_gen.py generate samples/sample_config.csv samples/sample_values_
↳singlepage_blob.csv Sample 0x3000
```

主 CSV 文件应在 file 类型下设置一个相对路径，相对于运行该程序的当前目录。

### 为每个设备生成工厂加密镜像

运行以下命令为每一设备生成工厂加密镜像，量产程序同时提供了一个 CSV 示例文件。

- 通过量产程序生成加密密钥来进行加密：

```
python mfg_gen.py generate samples/sample_config.csv samples/sample_values_
↳singlepage_blob.csv Sample 0x3000 --keygen
```

**备注：** 创建的加密密钥格式为 <outdir>/keys/keys-<prefix>-<fileid>.bin。加密密钥存储于新建文件的 keys/ 目录下，与 NVS 密钥分区结构兼容。更多信息请参考 [NVS 密钥分区](#)。

- 提供加密密钥用作二进制输入文件来进行加密：

```
python mfg_gen.py generate samples/sample_config.csv samples/sample_values_
↳singlepage_blob.csv Sample 0x3000 --inputkey keys/sample_keys.bin
```

### 仅生成加密密钥

#### 使用方法：

```
python mfg_gen.py generate-key [-h] [--keyfile KEYFILE] [--outdir OUTDIR]
```

可选参数： +-----+ | 参数 | 描述 | +-----+  
+-----+ | -h, --help | 显示帮助信息并退出 | +-----+  
+-----+ | --keyfile KEYFILE | 加密密钥文件的输出路径 | +-----+  
+-----+ | --outdir OUTDIR | 输出目录，用于存储创建的文件（默认当前目录） | +-----+  
+-----+

运行以下命令仅生成加密密钥：

```
python mfg_gen.py generate-key
```

**备注：** 创建的加密密钥格式为 <outdir>/keys/keys-<timestamp>.bin。时间戳格式为：%m-%d\_%H-%M。如需自定义目标文件名，请使用 --keyfile 参数。

生成的加密密钥二进制文件还可以用于为每个设备的工厂镜像加密。

fileid 参数的默认值为 1、2、3...，与主 CSV 文件中的行一一对应，内含设备配置值。

运行量产程序时，将在指定的 outdir 目录下创建以下文件夹：

- bin/ 存储生成的二进制文件
- csv/ 存储生成的中间 CSV 文件
- keys/ 存储加密密钥（创建工厂加密镜像时会用到）

## 2.9.3 非易失性存储库

### 简介

非易失性存储 (NVS) 库主要用于在 flash 中存储键值格式的数据。本文档将详细介绍 NVS 常用的一些概念。

**底层存储** NVS 库通过调用 `esp_partition` API 使用主 flash 的部分空间，即类型为 `data` 且子类型为 `nvs` 的所有分区。应用程序可调用 `nvs_open()` API 选择使用带有 `nvs` 标签的分区，也可以通过调用 `nvs_open_from_partition()` API 选择使用指定名称的任意分区。

NVS 库后续版本可能会增加其他存储器后端，来将数据保存至其他 flash 芯片（SPI 或 I2C 接口）、RTC 或 FRAM 中。

---

**备注：**如果 NVS 分区被截断（例如，更改分区表布局时），则应擦除分区内容。可以使用 ESP-IDF 构建系统中的 `idf.py erase-flash` 命令擦除 flash 上的所有内容。

---

---

**备注：**NVS 最适合存储一些较小的数据，而非字符串或二进制大对象 (BLOB) 等较大的数据。如需存储较大的 BLOB 或者字符串，请考虑使用基于磨损均衡库的 FAT 文件系统。

---

**键值对** NVS 的操作对象为键值对，其中键是 ASCII 字符串，当前支持的最大键长为 15 个字符。值可以为以下几种类型：

- 整数型： `uint8_t`、`int8_t`、`uint16_t`、`int16_t`、`uint32_t`、`int32_t`、`uint64_t` 和 `int64_t`；
- 以 0 结尾的字符串；
- 可变长度的二进制数据 (BLOB)

---

**备注：**字符串值当前上限为 4000 字节，其中包括空终止符。BLOB 值上限为 508,000 字节或分区大小的 97.6% 减去 4000 字节，以较低值为准。

---

后续可能会增加对 `float` 和 `double` 等其他类型数据的支持。

键必须唯一。为现有的键写入新值时，会将旧的值及数据类型更新为写入操作指定的值和数据类型。

读取值时会执行数据类型检查。如果读取操作预期的数据类型与对应键的数据类型不匹配，则返回错误。

**命名空间** 为了减少不同组件之间键名的潜在冲突，NVS 将每个键值对分配给一个命名空间。命名空间的命名规则遵循键名的命名规则，例如，最多可占 15 个字符。此外，单个 NVS 分区最多只能容纳 254 个不同的命名空间。命名空间的名称在调用 `nvs_open()` 或 `nvs_open_from_partition` 中指定，调用后将返回一个不透明句柄，用于后续调用 `nvs_get_*`、`nvs_set_*` 和 `nvs_commit` 函数。这样，一个句柄关联一个命名空间，键名便不会与其他命名空间中相同键名冲突。请注意，不同 NVS 分区中具有相同名称的命名空间将被视为不同的命名空间。

**NVS 迭代器** 迭代器允许根据指定的分区名称、命名空间和数据类型轮询 NVS 中存储的键值对。

使用以下函数，可执行相关操作：

- `nvs_entry_find`：创建一个不透明句柄，用于后续调用 `nvs_entry_next` 和 `nvs_entry_info` 函数；
- `nvs_entry_next`：让迭代器指向下一个键值对；
- `nvs_entry_info`：返回每个键值对的信息。

总的来说，所有通过 `nvs_entry_find()` 获得的迭代器（包括 NULL 迭代器）都必须使用 `nvs_release_iterator()` 释放。

一般情况下，`nvs_entry_find()` 和 `nvs_entry_next()` 会将给定的迭代器设置为 NULL 或为一个有效的迭代器。但如果出现参数错误（如返回 `ESP_ERR_NVS_NOT_FOUND`），给定的迭代器不会被修改。因此，在调用 `nvs_entry_find()` 之前最好将迭代器初始化为 NULL，这样可以避免在释放迭代器之前进行复杂的错误检查。

**安全性、篡改性及鲁棒性** NVS 与 ESP32-H2 flash 加密系统不直接兼容。然而，如果 NVS 加密与 ESP32-H2 flash 加密或 HMAC 外设一起使用，数据仍可以加密形式存储。详情请参考 [NVS 加密](#)。

如果未启用 NVS 加密，任何对 flash 芯片有物理访问权限的用户都可以修改、擦除或添加键值对。NVS 加密启用后，如果不知道相应的 NVS 加密密钥，则无法修改或添加键值对并将其识别为有效键值对。但是，针对擦除操作没有相应的防篡改功能。

当 flash 处于不一致状态时，NVS 库会尝试恢复。在任何时间点关闭设备电源，然后重新打开电源，不会导致数据丢失；但如果关闭设备电源时正在写入新的键值对，这一键值对可能会丢失。该库还应该能够在 flash 中存在任何随机数据的情况下正常初始化。

## NVS 加密

详情请参考 [NVS 加密](#)。

## NVS 分区生成程序

NVS 分区生成程序帮助生成 NVS 分区二进制文件，可使用烧录程序将二进制文件单独烧录至特定分区。烧录至分区上的键值对由 CSV 文件提供，详情请参考 [NVS 分区生成程序](#)。

可以直接使用函数 `nvs_create_partition_image` 通过 CMake 创建分区二进制文件，无需手动调用 `nvs_partition_gen.py` 工具：

```
nvs_create_partition_image(<partition> <csv> [FLASH_IN_PROJECT] [DEPENDS dep dep_
→dep ...])
```

位置参数：

参数	描述
partition	NVS 分区名
csv	解析的 CSV 文件路径

可选参数：

参数	描述
FLASH_IN_PROJECT	NVS 分区名
DEPENDS	指定命令依赖的文件

在没有指定 `FLASH_IN_PROJECT` 的情况下，也支持生成分区镜像，不过此时需要使用 `idf.py <partition>-flash` 手动进行烧录。举个例子，如果分区名为 `nvs`，则需使用的命令为 `idf.py nvs-flash`。

目前，仅支持从组件中的 `CMakeLists.txt` 文件调用 `nvs_create_partition_image`，且此选项仅适用于非加密分区。

## 应用示例

ESP-IDF [storage](#) 目录下提供了数个代码示例：

### [storage/nvs\\_rw\\_value](#)

演示如何读取及写入 NVS 单个整数值。

此示例中的值表示 ESP32-H2 模组重启次数。NVS 中数据不会因为模组重启而丢失，因此只有将这一值存储于 NVS 中，才能起到重启次数计数器的作用。

该示例也演示了如何检测读取/写入操作是否成功，以及某个特定值是否在 NVS 中尚未初始化。诊断程序以纯文本形式提供，有助于追踪程序流程，及时发现问题。

### [storage/nvs\\_rw\\_blob](#)

演示如何读取及写入 NVS 单个整数值和 BLOB（二进制大对象），并在 NVS 中存储这一数值，即便 ESP32-H2 模组重启也不会消失。

- value - 记录 ESP32-H2 模组软重启次数和硬重启次数。
- blob - 内含记录模组运行次数的表格。此表格将被从 NVS 读取至动态分配的 RAM 上。每次手动软重启后，表格内运行次数即增加一次，新加的运行次数被写入 NVS。下拉 GPIO0 即可手动软重启。

该示例也演示了如何执行诊断程序以检测读取/写入操作是否成功。

[storage/nvs\\_rw\\_value\\_cxx](#)

这个例子与 [storage/nvs\\_rw\\_value](#) 完全一样，只是使用了 C++ 的 NVS 句柄类。

## 内部实现

**键值对日志** NVS 按顺序存储键值对，新的键值对添加在最后。因此，如需更新某一键值对，实际是在日志最后增加一对新的键值对，同时将旧的键值对标记为已擦除。

**页面和条目** NVS 库在其操作中主要使用两个实体：页面和条目。页面是一个逻辑结构，用于存储部分的整体日志。逻辑页面对应 flash 的一个物理扇区，正在使用中的页面具有与之相关联的序列号。序列号赋予了页面顺序，较高的序列号对应较晚创建的页面。页面有以下几种状态：

**空或未初始化** 页面对应的 flash 扇区为空白状态（所有字节均为 0xff）。此时，页面未存储任何数据且没有关联的序列号。

**活跃状态** 此时 flash 已完成初始化，页头部写入 flash，页面已具备有效序列号。页面中存在一些空条目，可写入数据。任意时刻，至多有一个页面处于活跃状态。

**写满状态** flash 已写满键值对，状态不再改变。用户无法向写满状态下的页面写入新键值对，但仍可将一些键值对标记为已擦除。

**擦除状态** 未擦除的键值对将移至其他页面，以便擦除当前页面。这一状态仅为暂时性状态，即 API 调用返回时，页面应脱离这一状态。如果设备突然断电，下次开机时，设备将继续把未擦除的键值对移至其他页面，并继续擦除当前页面。

**损坏状态** 页头部包含无效数据，无法进一步解析该页面中的数据，因此之前写入该页面的所有条目均无法访问。相应的 flash 扇区并不会被立即擦除，而是与其他处于未初始化状态的扇区一起等待后续使用。这一状态可能对调试有用。

flash 扇区映射至逻辑页面并没有特定的顺序，NVS 库会检查存储在 flash 扇区的页面序列号，并根据序列号组织页面。

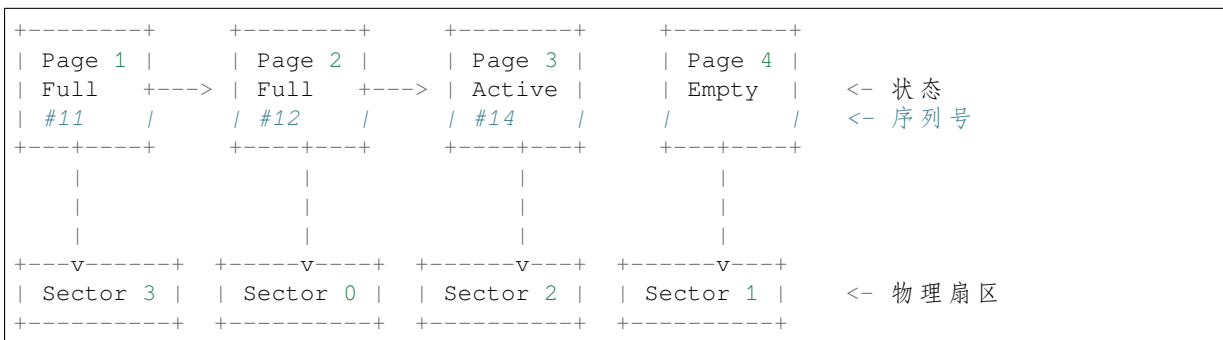

**页面结构** 当前，我们假设 flash 扇区大小为 4096 字节，并且 ESP32-H2 flash 加密硬件在 32 字节块上运行。未来有可能引入一些编译时可配置项（可通过 menuconfig 进行配置），以适配具有不同扇区大小的 flash 芯片。但目前尚不清楚 SPI flash 驱动和 SPI flash cache 之类的系统组件是否支持其他扇区大小。

页面由头部、条目状态位图和条目三部分组成。为了实现与 ESP32-H2 flash 加密功能兼容，条目大小设置为 32 字节。如果键值为整数型，条目则保存一个键值对；如果键值为字符串或 BLOB 类型，则条目仅保存一个键值对的部分内容（更多信息详见条目结构描述）。

页面结构如下图所示，括号内数字表示该部分的大小（以字节为单位）。



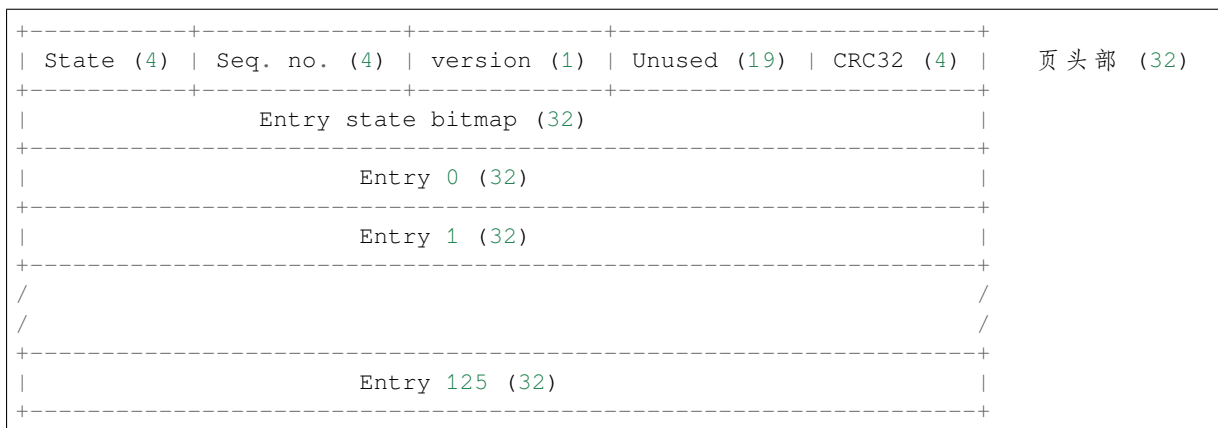

头部和条目状态位图写入 flash 时不加密。如果启用了 ESP32-H2 flash 加密功能，则条目写入 flash 时将会加密。

通过将 0 写入某些位可以定义页面状态值，表示状态改变。因此，如果需要变更页面状态，并不一定要擦除页面，除非要将其变更为擦除状态。

头部中的 version 字段反映了所用的 NVS 格式版本。为实现向后兼容，版本升级从 0xff 开始依次递减 (例如，version-1 为 0xff，version-2 为 0xfe，以此类推)。

头部中 CRC32 值是由不包含状态值的条目计算所得 (4 到 28 字节)。当前未使用的条目用 0xff 字节填充。

条目结构和条目状态位图的详细信息见下文描述。

**条目和条目状态位图** 每个条目可处于以下三种状态之一，每个状态在条目状态位图中用两位表示。位图中的最后四位 (256 - 2 \* 126) 未使用。

**空 (2'b11)** 条目还未写入任何内容，处于未初始化状态 (全部字节为 0xff)。

**写入 (2'b10)** 一个键值对 (或跨多个条目的键值对的部分内容) 已写入条目中。

**擦除 (2'b00)** 条目中的键值对已丢弃，条目内容不再解析。

**条目结构** 如果键值类型为基础类型，即 1 - 8 个字节长度的整数型，条目将保存一个键值对；如果键值类型为字符串或 BLOB 类型，条目将保存整个键值对的部分内容。另外，如果键值为字符串类型且跨多个条目，则键值所跨的所有条目均保存在同一页面。BLOB 则可以切分为多个块，实现跨多个页面。BLOB 索引是一个附加的固定长度元数据条目，用于追踪 BLOB 块。目前条目仍支持早期 BLOB 格式 (可读取可修改)，但这些 BLOB 一经修改，即以新格式储存至条目。

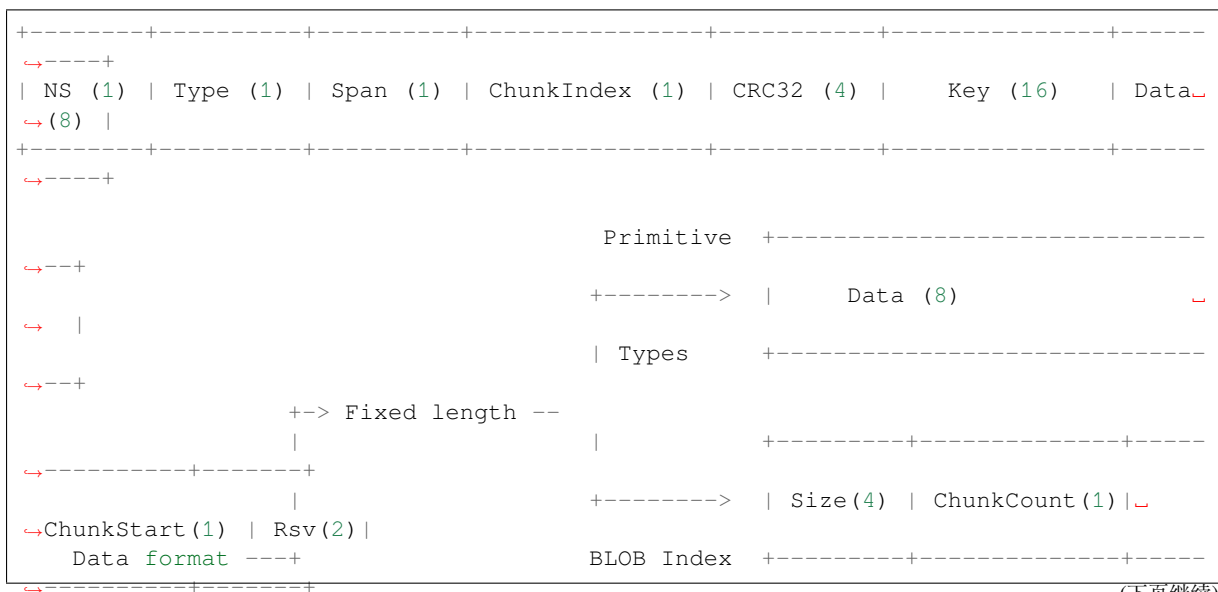

(下页继续)

	+-----+-----+-----+
--> Variable length -->	Size (2)   Rsv (2)   CRC32 (4)
(Strings, BLOB Data)	+-----+-----+-----+

条目结构中各个字段含义如下：

**命名空间 (NS, NameSpace)** 该条目的命名空间索引，详细信息参见命名空间实现章节。

**类型 (Type)** 一个字节表示的值的的数据类型，`nvs_flash/include/nvs_handle.hpp` 下的 `ItemType` 枚举了可能的类型。

**跨度 (Span)** 该键值对所用的条目数量。如果键值为整数型，条目数量即为 1。如果键值为字符串或 BLOB，则条目数量取决于值的长度。

**块索引 (ChunkIndex)** 用于存储 BLOB 类型数据块的索引。如果键值为其他数据类型，则此处索引应写入 `0xff`。

**CRC32** 对条目下所有字节进行校验后，所得的校验和（CRC32 字段不计算在内）。

**键 (Key)** 即以零结尾的 ASCII 字符串，字符串最长为 15 字节，不包含最后一个字节的零终止符。

**数据 (Data)** 如果键值类型为整数型，则数据字段仅包含键值。如果键值小于八个字节，使用 `0xff` 填充未使用的部分（右侧）。

如果键值类型为 BLOB 索引条目，则该字段的八个字节将保存以下数据块信息：

- **块大小** 整个 BLOB 数据的大小（以字节为单位）。该字段仅用于 BLOB 索引类型条目。
- **ChunkCount** 存储过程中 BLOB 分成的数据块总量。该字段仅用于 BLOB 索引类型条目。
- **ChunkStart** BLOB 第一个数据块的块索引，后续数据块索引依次递增，步长为 1。该字段仅用于 BLOB 索引类型条目。

如果键值类型为字符串或 BLOB 数据块，数据字段的这八个字节将保存该键值的一些附加信息，如下所示：

- **数据大小** 实际数据的大小（以字节为单位）。如果键值类型为字符串，此字段也应将零终止符包含在内。此字段仅用于字符串和 BLOB 类型条目。
- **CRC32** 数据所有字节的校验和，该字段仅用于字符串和 BLOB 类型条目。

可变长度值（字符串和 BLOB）写入后续条目，每个条目 32 字节。第一个条目的 `Span` 字段将指明使用了多少条目。

**命名空间** 如上所述，每个键值对属于一个命名空间。命名空间标识符（字符串）也作为键值对的键，存储在索引为 0 的命名空间中。与这些键对应的值就是这些命名空间的索引。

+-----+-----+-----+	
NS=0 Type=uint8_t Key="wifi" Value=1	Entry describing namespace "wifi"
+-----+-----+-----+	
NS=1 Type=uint32_t Key="channel" Value=6	Key "channel" in namespace "wifi"
+-----+-----+-----+	
NS=0 Type=uint8_t Key="pwm" Value=2	Entry describing namespace "pwm"
+-----+-----+-----+	
NS=2 Type=uint16_t Key="channel" Value=20	Key "channel" in namespace "pwm"
+-----+-----+-----+	

**条目哈希列表** 为了减少对 flash 执行的读操作次数，`Page` 类对象均设有一个列表，包含一对数据：条目索引和条目哈希值。该列表可大大提高检索速度，而无需迭代所有条目并逐个从 flash 中读取。`Page::findItem` 首先从哈希列表中检索条目哈希值，如果条目存在，则在页面内给出条目索引。由于哈希冲突，在哈希列表中检索条目哈希值可能会得到不同的条目，对 flash 中条目再次迭代可解决这一冲突。

哈希列表中每个节点均包含一个 24 位哈希值和 8 位条目索引。哈希值根据条目命名空间、键名和块索引由 CRC32 计算所得，计算结果保留 24 位。为减少将 32 位条目存储在链表中的开销，链表采用了数组的双向链表。每个数组占用 128 个字节，包含 29 个条目、两个链表指针和一个 32 位计数字段。因此，每页额外需要的 RAM 最少为 128 字节，最多为 640 字节。



## API 参考

### Header File

- [components/nvs\\_flash/include/nvs\\_flash.h](#)
- This header file can be included with:

```
#include "nvs_flash.h"
```

- This header file is a part of the API provided by the `nvs_flash` component. To declare that your component depends on `nvs_flash`, add the following to your `CMakeLists.txt`:

```
REQUIRES nvs_flash
```

or

```
PRIV_REQUIRES nvs_flash
```

### Functions

*esp\_err\_t* **nvs\_flash\_init** (void)

Initialize the default NVS partition.

This API initialises the default NVS partition. The default NVS partition is the one that is labeled "nvs" in the partition table.

When "NVS\_ENCRYPTION" is enabled in the menuconfig, this API enables the NVS encryption for the default NVS partition as follows

- Read security configurations from the first NVS key partition listed in the partition table. (NVS key partition is any "data" type partition which has the subtype value set to "nvs\_keys")
- If the NVS key partition obtained in the previous step is empty, generate and store new keys in that NVS key partition.
- Internally call "nvs\_flash\_secure\_init()" with the security configurations obtained/generated in the previous steps.

Post initialization NVS read/write APIs remain the same irrespective of NVS encryption.

#### 返回

- ESP\_OK if storage was successfully initialized.
- ESP\_ERR\_NVS\_NO\_FREE\_PAGES if the NVS storage contains no empty pages (which may happen if NVS partition was truncated)
- ESP\_ERR\_NOT\_FOUND if no partition with label "nvs" is found in the partition table
- ESP\_ERR\_NO\_MEM in case memory could not be allocated for the internal structures
- one of the error codes from the underlying flash storage driver
- error codes from `nvs_flash_read_security_cfg` API (when "NVS\_ENCRYPTION" is enabled).
- error codes from `nvs_flash_generate_keys` API (when "NVS\_ENCRYPTION" is enabled).
- error codes from `nvs_flash_secure_init_partition` API (when "NVS\_ENCRYPTION" is enabled) .

*esp\_err\_t* **nvs\_flash\_init\_partition** (const char \*partition\_label)

Initialize NVS flash storage for the specified partition.

**参数** `partition_label` -- [in] Label of the partition. Must be no longer than 16 characters.

#### 返回

- ESP\_OK if storage was successfully initialized.
- ESP\_ERR\_NVS\_NO\_FREE\_PAGES if the NVS storage contains no empty pages (which may happen if NVS partition was truncated)
- ESP\_ERR\_NOT\_FOUND if specified partition is not found in the partition table
- ESP\_ERR\_NO\_MEM in case memory could not be allocated for the internal structures
- one of the error codes from the underlying flash storage driver

*esp\_err\_t* **nvs\_flash\_init\_partition\_ptr** (const *esp\_partition\_t* \*partition)

Initialize NVS flash storage for the partition specified by partition pointer.

**参数** *partition* -- [in] pointer to a partition obtained by the ESP partition API.

**返回**

- ESP\_OK if storage was successfully initialized
- ESP\_ERR\_NVS\_NO\_FREE\_PAGES if the NVS storage contains no empty pages (which may happen if NVS partition was truncated)
- ESP\_ERR\_INVALID\_ARG in case partition is NULL
- ESP\_ERR\_NO\_MEM in case memory could not be allocated for the internal structures
- one of the error codes from the underlying flash storage driver

*esp\_err\_t* **nvs\_flash\_deinit** (void)

Deinitialize NVS storage for the default NVS partition.

Default NVS partition is the partition with "nvs" label in the partition table.

**返回**

- ESP\_OK on success (storage was deinitialized)
- ESP\_ERR\_NVS\_NOT\_INITIALIZED if the storage was not initialized prior to this call

*esp\_err\_t* **nvs\_flash\_deinit\_partition** (const char \*partition\_label)

Deinitialize NVS storage for the given NVS partition.

**参数** *partition\_label* -- [in] Label of the partition

**返回**

- ESP\_OK on success
- ESP\_ERR\_NVS\_NOT\_INITIALIZED if the storage for given partition was not initialized prior to this call

*esp\_err\_t* **nvs\_flash\_erase** (void)

Erase the default NVS partition.

Erases all contents of the default NVS partition (one with label "nvs").

---

**备注:** If the partition is initialized, this function first de-initializes it. Afterwards, the partition has to be initialized again to be used.

---

**返回**

- ESP\_OK on success
- ESP\_ERR\_NOT\_FOUND if there is no NVS partition labeled "nvs" in the partition table
- different error in case de-initialization fails (shouldn't happen)

*esp\_err\_t* **nvs\_flash\_erase\_partition** (const char \*part\_name)

Erase specified NVS partition.

Erase all content of a specified NVS partition

---

**备注:** If the partition is initialized, this function first de-initializes it. Afterwards, the partition has to be initialized again to be used.

---

**参数** *part\_name* -- [in] Name (label) of the partition which should be erased

**返回**

- ESP\_OK on success
- ESP\_ERR\_NOT\_FOUND if there is no NVS partition with the specified name in the partition table
- different error in case de-initialization fails (shouldn't happen)

`esp_err_t nvs_flash_erase_partition_ptr` (const `esp_partition_t` \*partition)

Erase custom partition.

Erase all content of specified custom partition.

---

**备注:** If the partition is initialized, this function first de-initializes it. Afterwards, the partition has to be initialized again to be used.

---

**参数** `partition` -- [in] pointer to a partition obtained by the ESP partition API.

**返回**

- ESP\_OK on success
- ESP\_ERR\_NOT\_FOUND if there is no partition with the specified parameters in the partition table
- ESP\_ERR\_INVALID\_ARG in case partition is NULL
- one of the error codes from the underlying flash storage driver

`esp_err_t nvs_flash_secure_init` (`nvs_sec_cfg_t` \*cfg)

Initialize the default NVS partition.

This API initialises the default NVS partition. The default NVS partition is the one that is labeled "nvs" in the partition table.

**参数** `cfg` -- [in] Security configuration (keys) to be used for NVS encryption/decryption. If `cfg` is NULL, no encryption is used.

**返回**

- ESP\_OK if storage has been initialized successfully.
- ESP\_ERR\_NVS\_NO\_FREE\_PAGES if the NVS storage contains no empty pages (which may happen if NVS partition was truncated)
- ESP\_ERR\_NOT\_FOUND if no partition with label "nvs" is found in the partition table
- ESP\_ERR\_NO\_MEM in case memory could not be allocated for the internal structures
- one of the error codes from the underlying flash storage driver

`esp_err_t nvs_flash_secure_init_partition` (const char \*partition\_label, `nvs_sec_cfg_t` \*cfg)

Initialize NVS flash storage for the specified partition.

**参数**

- `partition_label` -- [in] Label of the partition. Note that internally, a reference to passed value is kept and it should be accessible for future operations
- `cfg` -- [in] Security configuration (keys) to be used for NVS encryption/decryption. If `cfg` is null, no encryption/decryption is used.

**返回**

- ESP\_OK if storage has been initialized successfully.
- ESP\_ERR\_NVS\_NO\_FREE\_PAGES if the NVS storage contains no empty pages (which may happen if NVS partition was truncated)
- ESP\_ERR\_NOT\_FOUND if specified partition is not found in the partition table
- ESP\_ERR\_NO\_MEM in case memory could not be allocated for the internal structures
- one of the error codes from the underlying flash storage driver

`esp_err_t nvs_flash_generate_keys` (const `esp_partition_t` \*partition, `nvs_sec_cfg_t` \*cfg)

Generate and store NVS keys in the provided esp partition.

**参数**

- `partition` -- [in] Pointer to partition structure obtained using `esp_partition_find_first` or `esp_partition_get`. Must be non-NULL.
- `cfg` -- [out] Pointer to nvs security configuration structure. Pointer must be non-NULL. Generated keys will be populated in this structure.

**返回**

- ESP\_OK, if `cfg` was read successfully;
- ESP\_ERR\_INVALID\_ARG, if partition or `cfg` is NULL;

- or error codes from esp\_partition\_write/erase APIs.

*esp\_err\_t* **nvs\_flash\_read\_security\_cfg** (const *esp\_partition\_t* \*partition, *nvs\_sec\_cfg\_t* \*cfg)

Read NVS security configuration from a partition.

---

**备注:** Provided partition is assumed to be marked 'encrypted'.

---

#### 参数

- **partition** -- **[in]** Pointer to partition structure obtained using esp\_partition\_find\_first or esp\_partition\_get. Must be non-NULL.
- **cfg** -- **[out]** Pointer to nvs security configuration structure. Pointer must be non-NULL.

#### 返回

- ESP\_OK, if cfg was read successfully;
- ESP\_ERR\_INVALID\_ARG, if partition or cfg is NULL
- ESP\_ERR\_NVS\_KEYS\_NOT\_INITIALIZED, if the partition is not yet written with keys.
- ESP\_ERR\_NVS\_CORRUPT\_KEY\_PART, if the partition containing keys is found to be corrupt
- or error codes from esp\_partition\_read API.

*esp\_err\_t* **nvs\_flash\_register\_security\_scheme** (*nvs\_sec\_scheme\_t* \*scheme\_cfg)

Registers the given security scheme for NVS encryption The scheme registered with sec\_scheme\_id by this API be used as the default security scheme for the "nvs" partition. Users will have to call this API explicitly in their application.

**参数** **scheme\_cfg** -- **[in]** Pointer to the security scheme configuration structure that the user (or the nvs\_key\_provider) wants to register.

#### 返回

- ESP\_OK, if security scheme registration succeeds;
- ESP\_ERR\_INVALID\_ARG, if scheme\_cfg is NULL;
- ESP\_FAIL, if security scheme registration fails

*nvs\_sec\_scheme\_t* \***nvs\_flash\_get\_default\_security\_scheme** (void)

Fetch the configuration structure for the default active security scheme for NVS encryption.

**返回** Pointer to the default active security scheme configuration (NULL if no scheme is registered yet i.e. active)

*esp\_err\_t* **nvs\_flash\_generate\_keys\_v2** (*nvs\_sec\_scheme\_t* \*scheme\_cfg, *nvs\_sec\_cfg\_t* \*cfg)

Generate (and store) the NVS keys using the specified key-protection scheme.

#### 参数

- **scheme\_cfg** -- **[in]** Security scheme specific configuration
- **cfg** -- **[out]** Security configuration (encryption keys)

#### 返回

- ESP\_OK, if cfg was populated successfully with generated encryption keys;
- ESP\_ERR\_INVALID\_ARG, if scheme\_cfg or cfg is NULL;
- ESP\_FAIL, if the key generation process fails

*esp\_err\_t* **nvs\_flash\_read\_security\_cfg\_v2** (*nvs\_sec\_scheme\_t* \*scheme\_cfg, *nvs\_sec\_cfg\_t* \*cfg)

Read NVS security configuration set by the specified security scheme.

#### 参数

- **scheme\_cfg** -- **[in]** Security scheme specific configuration
- **cfg** -- **[out]** Security configuration (encryption keys)

#### 返回

- ESP\_OK, if cfg was read successfully;
- ESP\_ERR\_INVALID\_ARG, if scheme\_cfg or cfg is NULL;
- ESP\_FAIL, if the key reading process fails

## Structures

struct **nvs\_sec\_cfg\_t**

Key for encryption and decryption.

### Public Members

uint8\_t **eky**[NVS\_KEY\_SIZE]

XTS encryption and decryption key

uint8\_t **tky**[NVS\_KEY\_SIZE]

XTS tweak key

struct **nvs\_sec\_scheme\_t**

NVS encryption: Security scheme configuration structure.

### Public Members

int **scheme\_id**

Security Scheme ID (E.g. HMAC)

void \***scheme\_data**

Scheme-specific data (E.g. eFuse block for HMAC-based key generation)

[\*nvs\\_flash\\_generate\\_keys\\_t\*](#) **nvs\_flash\_key\_gen**

Callback for the `nvs_flash_key_gen` implementation

[\*nvs\\_flash\\_read\\_cfg\\_t\*](#) **nvs\_flash\_read\_cfg**

Callback for the `nvs_flash_read_keys` implementation

## Macros

**NVS\_KEY\_SIZE**

## Type Definitions

typedef [\*esp\\_err\\_t\*](#) (\***nvs\_flash\_generate\_keys\_t**)(const void \*scheme\_data, [\*nvs\\_sec\\_cfg\\_t\*](#) \*cfg)

Callback function prototype for generating the NVS encryption keys.

typedef [\*esp\\_err\\_t\*](#) (\***nvs\_flash\_read\_cfg\_t**)(const void \*scheme\_data, [\*nvs\\_sec\\_cfg\\_t\*](#) \*cfg)

Callback function prototype for reading the NVS encryption keys.

## Header File

- [components/nvs\\_flash/include/nvs.h](#)
- This header file can be included with:

```
#include "nvs.h"
```

- This header file is a part of the API provided by the `nvs_flash` component. To declare that your component depends on `nvs_flash`, add the following to your `CMakeLists.txt`:

```
REQUIRES nvs_flash
```

or

```
PRIV_REQUIRES nvs_flash
```

## Functions

*esp\_err\_t* **nvs\_set\_i8** (*nvs\_handle\_t* handle, const char \*key, int8\_t value)

set int8\_t value for given key

Set value for the key, given its name. Note that the actual storage will not be updated until `nvs_commit` is called. Regardless whether key-value pair is created or updated, function always requires at least one `nvs` available entry. See `nvs_get_stats`. After create type of operation, the number of available entries is decreased by one. After update type of operation, the number of available entries remains the same.

### 参数

- **handle** -- [in] Handle obtained from `nvs_open` function. Handles that were opened read only cannot be used.
- **key** -- [in] Key name. Maximum length is `(NVS_KEY_NAME_MAX_SIZE-1)` characters. Shouldn't be empty.
- **value** -- [in] The value to set.

### 返回

- `ESP_OK` if value was set successfully
- `ESP_FAIL` if there is an internal error; most likely due to corrupted NVS partition (only if NVS assertion checks are disabled)
- `ESP_ERR_NVS_INVALID_HANDLE` if handle has been closed or is `NULL`
- `ESP_ERR_NVS_READ_ONLY` if storage handle was opened as read only
- `ESP_ERR_NVS_INVALID_NAME` if key name doesn't satisfy constraints
- `ESP_ERR_NVS_NOT_ENOUGH_SPACE` if there is not enough space in the underlying storage to save the value
- `ESP_ERR_NVS_REMOVE_FAILED` if the value wasn't updated because flash write operation has failed. The value was written however, and update will be finished after re-initialization of `nvs`, provided that flash operation doesn't fail again.

*esp\_err\_t* **nvs\_set\_u8** (*nvs\_handle\_t* handle, const char \*key, uint8\_t value)

set uint8\_t value for given key

This function is the same as `nvs_set_i8` except for the data type.

*esp\_err\_t* **nvs\_set\_i16** (*nvs\_handle\_t* handle, const char \*key, int16\_t value)

set int16\_t value for given key

This function is the same as `nvs_set_i8` except for the data type.

*esp\_err\_t* **nvs\_set\_u16** (*nvs\_handle\_t* handle, const char \*key, uint16\_t value)

set uint16\_t value for given key

This function is the same as `nvs_set_i8` except for the data type.

*esp\_err\_t* **nvs\_set\_i32** (*nvs\_handle\_t* handle, const char \*key, int32\_t value)

set int32\_t value for given key

This function is the same as `nvs_set_i8` except for the data type.

*esp\_err\_t* **nvs\_set\_u32** (*nvs\_handle\_t* handle, const char \*key, uint32\_t value)

set uint32\_t value for given key

This function is the same as `nvs_set_i8` except for the data type.

*esp\_err\_t* **nvs\_set\_i64** (*nvs\_handle\_t* handle, const char \*key, int64\_t value)

set int64\_t value for given key

This function is the same as `nvs_set_i8` except for the data type.

`esp_err_t nvs_set_u64` (*nvs\_handle\_t* handle, const char \*key, uint64\_t value)

set uint64\_t value for given key

This function is the same as `nvs_set_i8` except for the data type.

`esp_err_t nvs_set_str` (*nvs\_handle\_t* handle, const char \*key, const char \*value)

set string for given key

Sets string value for the key. Function requires whole space for new data to be available as contiguous entries in same nvs page. Operation consumes 1 overhead entry and 1 entry per each 32 characters of new string including zero character to be set. In case of value update for existing key, entries occupied by the previous value and overhead entry are returned to the pool of available entries. Note that storage of long string values can fail due to fragmentation of nvs pages even if `available_entries` returned by `nvs_get_stats` suggests enough overall space available. Note that the underlying storage will not be updated until `nvs_commit` is called.

#### 参数

- **handle** -- [in] Handle obtained from `nvs_open` function. Handles that were opened read only cannot be used.
- **key** -- [in] Key name. Maximum length is (NVS\_KEY\_NAME\_MAX\_SIZE-1) characters. Shouldn't be empty.
- **value** -- [in] The value to set. For strings, the maximum length (including null character) is 4000 bytes, if there is one complete page free for writing. This decreases, however, if the free space is fragmented.

#### 返回

- ESP\_OK if value was set successfully
- ESP\_ERR\_NVS\_INVALID\_HANDLE if handle has been closed or is NULL
- ESP\_ERR\_NVS\_READ\_ONLY if storage handle was opened as read only
- ESP\_ERR\_NVS\_INVALID\_NAME if key name doesn't satisfy constraints
- ESP\_ERR\_NVS\_NOT\_ENOUGH\_SPACE if there is not enough space in the underlying storage to save the value
- ESP\_ERR\_NVS\_REMOVE\_FAILED if the value wasn't updated because flash write operation has failed. The value was written however, and update will be finished after re-initialization of nvs, provided that flash operation doesn't fail again.
- ESP\_ERR\_NVS\_VALUE\_TOO\_LONG if the string value is too long

`esp_err_t nvs_get_i8` (*nvs\_handle\_t* handle, const char \*key, int8\_t \*out\_value)

get int8\_t value for given key

These functions retrieve value for the key, given its name. If `key` does not exist, or the requested variable type doesn't match the type which was used when setting a value, an error is returned.

In case of any error, `out_value` is not modified.

`out_value` has to be a pointer to an already allocated variable of the given type.

```
// Example of using nvs_get_i32:
int32_t max_buffer_size = 4096; // default value
esp_err_t err = nvs_get_i32(my_handle, "max_buffer_size", &max_buffer_size);
assert(err == ESP_OK || err == ESP_ERR_NVS_NOT_FOUND);
// if ESP_ERR_NVS_NOT_FOUND was returned, max_buffer_size will still
// have its default value.
```

#### 参数

- **handle** -- [in] Handle obtained from `nvs_open` function.
- **key** -- [in] Key name. Maximum length is (NVS\_KEY\_NAME\_MAX\_SIZE-1) characters. Shouldn't be empty.
- **out\_value** -- Pointer to the output value. May be NULL for `nvs_get_str` and `nvs_get_blob`, in this case required length will be returned in `length` argument.

#### 返回

- ESP\_OK if the value was retrieved successfully



- ESP\_FAIL if there is an internal error; most likely due to corrupted NVS partition (only if NVS assertion checks are disabled)
- ESP\_ERR\_NVS\_NOT\_FOUND if the requested key doesn't exist
- ESP\_ERR\_NVS\_INVALID\_HANDLE if handle has been closed or is NULL
- ESP\_ERR\_NVS\_INVALID\_NAME if key name doesn't satisfy constraints
- ESP\_ERR\_NVS\_INVALID\_LENGTH if length is not sufficient to store data

`esp_err_t nvs_get_u8(nvs_handle_t handle, const char *key, uint8_t *out_value)`  
get uint8\_t value for given key

This function is the same as `nvs_get_i8` except for the data type.

`esp_err_t nvs_get_i16(nvs_handle_t handle, const char *key, int16_t *out_value)`  
get int16\_t value for given key

This function is the same as `nvs_get_i8` except for the data type.

`esp_err_t nvs_get_u16(nvs_handle_t handle, const char *key, uint16_t *out_value)`  
get uint16\_t value for given key

This function is the same as `nvs_get_i8` except for the data type.

`esp_err_t nvs_get_i32(nvs_handle_t handle, const char *key, int32_t *out_value)`  
get int32\_t value for given key

This function is the same as `nvs_get_i8` except for the data type.

`esp_err_t nvs_get_u32(nvs_handle_t handle, const char *key, uint32_t *out_value)`  
get uint32\_t value for given key

This function is the same as `nvs_get_i8` except for the data type.

`esp_err_t nvs_get_i64(nvs_handle_t handle, const char *key, int64_t *out_value)`  
get int64\_t value for given key

This function is the same as `nvs_get_i8` except for the data type.

`esp_err_t nvs_get_u64(nvs_handle_t handle, const char *key, uint64_t *out_value)`  
get uint64\_t value for given key

This function is the same as `nvs_get_i8` except for the data type.

`esp_err_t nvs_get_str(nvs_handle_t handle, const char *key, char *out_value, size_t *length)`  
get string value for given key

These functions retrieve the data of an entry, given its key. If key does not exist, or the requested variable type doesn't match the type which was used when setting a value, an error is returned.

In case of any error, `out_value` is not modified.

All functions expect `out_value` to be a pointer to an already allocated variable of the given type.

`nvs_get_str` and `nvs_get_blob` functions support WinAPI-style length queries. To get the size necessary to store the value, call `nvs_get_str` or `nvs_get_blob` with zero `out_value` and non-zero pointer to length. Variable pointed to by length argument will be set to the required length. For `nvs_get_str`, this length includes the zero terminator. When calling `nvs_get_str` and `nvs_get_blob` with non-zero `out_value`, length has to be non-zero and has to point to the length available in `out_value`. It is suggested that `nvs_get/set_str` is used for zero-terminated C strings, and `nvs_get/set_blob` used for arbitrary data structures.

```
// Example (without error checking) of using nvs_get_str to get a string into
//dynamic array:
size_t required_size;
nvs_get_str(my_handle, "server_name", NULL, &required_size);
char* server_name = malloc(required_size);
nvs_get_str(my_handle, "server_name", server_name, &required_size);
```

(下页继续)



```
// Example (without error checking) of using nvs_get_blob to get a binary data
into a static array:
uint8_t mac_addr[6];
size_t size = sizeof(mac_addr);
nvs_get_blob(my_handle, "dst_mac_addr", mac_addr, &size);
```

### 参数

- **handle** -- **[in]** Handle obtained from `nvs_open` function.
- **key** -- **[in]** Key name. Maximum length is `(NVS_KEY_NAME_MAX_SIZE-1)` characters. Shouldn't be empty.
- **out\_value** -- **[out]** Pointer to the output value. May be `NULL` for `nvs_get_str` and `nvs_get_blob`, in this case required length will be returned in `length` argument.
- **length** -- **[inout]** A non-zero pointer to the variable holding the length of `out_value`. In case `out_value` a zero, will be set to the length required to hold the value. In case `out_value` is not zero, will be set to the actual length of the value written. For `nvs_get_str` this includes zero terminator.

### 返回

- `ESP_OK` if the value was retrieved successfully
- `ESP_FAIL` if there is an internal error; most likely due to corrupted NVS partition (only if NVS assertion checks are disabled)
- `ESP_ERR_NVS_NOT_FOUND` if the requested key doesn't exist
- `ESP_ERR_NVS_INVALID_HANDLE` if handle has been closed or is `NULL`
- `ESP_ERR_NVS_INVALID_NAME` if key name doesn't satisfy constraints
- `ESP_ERR_NVS_INVALID_LENGTH` if `length` is not sufficient to store data

`esp_err_t nvs_get_blob(nvs_handle_t handle, const char *key, void *out_value, size_t *length)`

get blob value for given key

This function behaves the same as `nvs_get_str`, except for the data type.

`esp_err_t nvs_open(const char *namespace_name, nvs_open_mode_t open_mode, nvs_handle_t *out_handle)`

Open non-volatile storage with a given namespace from the default NVS partition.

Multiple internal ESP-IDF and third party application modules can store their key-value pairs in the NVS module. In order to reduce possible conflicts on key names, each module can use its own namespace. The default NVS partition is the one that is labelled "nvs" in the partition table.

### 参数

- **namespace\_name** -- **[in]** Namespace name. Maximum length is `(NVS_KEY_NAME_MAX_SIZE-1)` characters. Shouldn't be empty.
- **open\_mode** -- **[in]** `NVS_READWRITE` or `NVS_READONLY`. If `NVS_READONLY`, will open a handle for reading only. All write requests will be rejected for this handle.
- **out\_handle** -- **[out]** If successful (return code is zero), handle will be returned in this argument.

### 返回

- `ESP_OK` if storage handle was opened successfully
- `ESP_FAIL` if there is an internal error; most likely due to corrupted NVS partition (only if NVS assertion checks are disabled)
- `ESP_ERR_NVS_NOT_INITIALIZED` if the storage driver is not initialized
- `ESP_ERR_NVS_PART_NOT_FOUND` if the partition with label "nvs" is not found
- `ESP_ERR_NVS_NOT_FOUND` id namespace doesn't exist yet and mode is `NVS_READONLY`
- `ESP_ERR_NVS_INVALID_NAME` if namespace name doesn't satisfy constraints
- `ESP_ERR_NO_MEM` in case memory could not be allocated for the internal structures
- `ESP_ERR_NVS_NOT_ENOUGH_SPACE` if there is no space for a new entry or there are too many different namespaces (maximum allowed different namespaces: 254)

- ESP\_ERR\_NOT\_ALLOWED if the NVS partition is read-only and mode is NVS\_READWRITE
- ESP\_ERR\_INVALID\_ARG if out\_handle is equal to NULL
- other error codes from the underlying storage driver

*esp\_err\_t* **nvs\_open\_from\_partition** (const char \*part\_name, const char \*namespace\_name, *nvs\_open\_mode\_t* open\_mode, *nvs\_handle\_t* \*out\_handle)

Open non-volatile storage with a given namespace from specified partition.

The behaviour is same as nvs\_open() API. However this API can operate on a specified NVS partition instead of default NVS partition. Note that the specified partition must be registered with NVS using nvs\_flash\_init\_partition() API.

#### 参数

- **part\_name** -- [in] Label (name) of the partition of interest for object read/write/erase
- **namespace\_name** -- [in] Namespace name. Maximum length is (NVS\_KEY\_NAME\_MAX\_SIZE-1) characters. Shouldn't be empty.
- **open\_mode** -- [in] NVS\_READWRITE or NVS\_READONLY. If NVS\_READONLY, will open a handle for reading only. All write requests will be rejected for this handle.
- **out\_handle** -- [out] If successful (return code is zero), handle will be returned in this argument.

#### 返回

- ESP\_OK if storage handle was opened successfully
- ESP\_FAIL if there is an internal error; most likely due to corrupted NVS partition (only if NVS assertion checks are disabled)
- ESP\_ERR\_NVS\_NOT\_INITIALIZED if the storage driver is not initialized
- ESP\_ERR\_NVS\_PART\_NOT\_FOUND if the partition with specified name is not found
- ESP\_ERR\_NVS\_NOT\_FOUND id namespace doesn't exist yet and mode is NVS\_READONLY
- ESP\_ERR\_NVS\_INVALID\_NAME if namespace name doesn't satisfy constraints
- ESP\_ERR\_NO\_MEM in case memory could not be allocated for the internal structures
- ESP\_ERR\_NVS\_NOT\_ENOUGH\_SPACE if there is no space for a new entry or there are too many different namespaces (maximum allowed different namespaces: 254)
- ESP\_ERR\_NOT\_ALLOWED if the NVS partition is read-only and mode is NVS\_READWRITE
- ESP\_ERR\_INVALID\_ARG if out\_handle is equal to NULL
- other error codes from the underlying storage driver

*esp\_err\_t* **nvs\_set\_blob** (*nvs\_handle\_t* handle, const char \*key, const void \*value, size\_t length)

set variable length binary value for given key

Sets variable length binary value for the key. Function uses 2 overhead and 1 entry per each 32 bytes of new data from the pool of available entries. See nvs\_get\_stats . In case of value update for existing key, space occupied by the existing value and 2 overhead entries are returned to the pool of available entries. Note that the underlying storage will not be updated until nvs\_commit is called.

#### 参数

- **handle** -- [in] Handle obtained from nvs\_open function. Handles that were opened read only cannot be used.
- **key** -- [in] Key name. Maximum length is (NVS\_KEY\_NAME\_MAX\_SIZE-1) characters. Shouldn't be empty.
- **value** -- [in] The value to set.
- **length** -- [in] length of binary value to set, in bytes; Maximum length is 508000 bytes or (97.6% of the partition size - 4000) bytes whichever is lower.

#### 返回

- ESP\_OK if value was set successfully
- ESP\_FAIL if there is an internal error; most likely due to corrupted NVS partition (only if NVS assertion checks are disabled)
- ESP\_ERR\_NVS\_INVALID\_HANDLE if handle has been closed or is NULL
- ESP\_ERR\_NVS\_READ\_ONLY if storage handle was opened as read only
- ESP\_ERR\_NVS\_INVALID\_NAME if key name doesn't satisfy constraints

- `ESP_ERR_NVS_NOT_ENOUGH_SPACE` if there is not enough space in the underlying storage to save the value
- `ESP_ERR_NVS_REMOVE_FAILED` if the value wasn't updated because flash write operation has failed. The value was written however, and update will be finished after re-initialization of nvs, provided that flash operation doesn't fail again.
- `ESP_ERR_NVS_VALUE_TOO_LONG` if the value is too long

`esp_err_t nvs_find_key` (*nvs\_handle\_t* handle, const char \*key, *nvs\_type\_t* \*out\_type)

Lookup key-value pair with given key name.

Note that function may indicate both existence of the key as well as the data type of NVS entry if it is found.

#### 参数

- **handle** -- **[in]** Storage handle obtained with `nvs_open`.
- **key** -- **[in]** Key name. Maximum length is `(NVS_KEY_NAME_MAX_SIZE-1)` characters. Shouldn't be empty.
- **out\_type** -- **[out]** Pointer to the output variable populated with data type of NVS entry in case key was found. May be NULL, respective data type is then not provided.

#### 返回

- `ESP_OK` if NVS entry for key provided was found
- `ESP_ERR_NVS_NOT_FOUND` if the requested key doesn't exist
- `ESP_ERR_NVS_INVALID_HANDLE` if handle has been closed or is NULL
- `ESP_FAIL` if there is an internal error; most likely due to corrupted NVS partition (only if NVS assertion checks are disabled)
- other error codes from the underlying storage driver

`esp_err_t nvs_erase_key` (*nvs\_handle\_t* handle, const char \*key)

Erase key-value pair with given key name.

Note that actual storage may not be updated until `nvs_commit` function is called.

#### 参数

- **handle** -- **[in]** Storage handle obtained with `nvs_open`. Handles that were opened read only cannot be used.
- **key** -- **[in]** Key name. Maximum length is `(NVS_KEY_NAME_MAX_SIZE-1)` characters. Shouldn't be empty.

#### 返回

- `ESP_OK` if erase operation was successful
- `ESP_FAIL` if there is an internal error; most likely due to corrupted NVS partition (only if NVS assertion checks are disabled)
- `ESP_ERR_NVS_INVALID_HANDLE` if handle has been closed or is NULL
- `ESP_ERR_NVS_READ_ONLY` if handle was opened as read only
- `ESP_ERR_NVS_NOT_FOUND` if the requested key doesn't exist
- other error codes from the underlying storage driver

`esp_err_t nvs_erase_all` (*nvs\_handle\_t* handle)

Erase all key-value pairs in a namespace.

Note that actual storage may not be updated until `nvs_commit` function is called.

**参数** **handle** -- **[in]** Storage handle obtained with `nvs_open`. Handles that were opened read only cannot be used.

#### 返回

- `ESP_OK` if erase operation was successful
- `ESP_FAIL` if there is an internal error; most likely due to corrupted NVS partition (only if NVS assertion checks are disabled)
- `ESP_ERR_NVS_INVALID_HANDLE` if handle has been closed or is NULL
- `ESP_ERR_NVS_READ_ONLY` if handle was opened as read only
- other error codes from the underlying storage driver

`esp_err_t nvs_commit` (*nvs\_handle\_t* handle)

Write any pending changes to non-volatile storage.

After setting any values, `nvs_commit()` must be called to ensure changes are written to non-volatile storage. Individual implementations may write to storage at other times, but this is not guaranteed.

**参数 handle** -- **[in]** Storage handle obtained with `nvs_open`. Handles that were opened read only cannot be used.

**返回**

- `ESP_OK` if the changes have been written successfully
- `ESP_ERR_NVS_INVALID_HANDLE` if handle has been closed or is `NULL`
- other error codes from the underlying storage driver

void `nvs_close` (`nvs_handle_t` handle)

Close the storage handle and free any allocated resources.

This function should be called for each handle opened with `nvs_open` once the handle is not in use any more. Closing the handle may not automatically write the changes to nonvolatile storage. This has to be done explicitly using `nvs_commit` function. Once this function is called on a handle, the handle should no longer be used.

**参数 handle** -- **[in]** Storage handle to close

`esp_err_t` `nvs_get_stats` (const char \*part\_name, `nvs_stats_t` \*nvs\_stats)

Fill structure `nvs_stats_t`. It provides info about memory used by NVS.

This function calculates the number of used entries, free entries, available entries, total entries and number of namespaces in partition.

```
// Example of nvs_get_stats() to get overview of actual statistics of data.
↪entries :
nvs_stats_t nvs_stats;
nvs_get_stats(NULL, &nvs_stats);
printf("Count: UsedEntries = (%lu), FreeEntries = (%lu), AvailableEntries = (
↪%lu), AllEntries = (%lu)\n",
      nvs_stats.used_entries, nvs_stats.free_entries, nvs_stats.available_
↪entries, nvs_stats.total_entries);
```

**参数**

- **part\_name** -- **[in]** Partition name NVS in the partition table. If pass a `NULL` than will use `NVS_DEFAULT_PART_NAME` ("nvs").
- **nvs\_stats** -- **[out]** Returns filled structure `nvs_stats_t`. It provides info about used memory the partition.

**返回**

- `ESP_OK` if the changes have been written successfully. Return param `nvs_stats` will be filled.
- `ESP_ERR_NVS_PART_NOT_FOUND` if the partition with label "name" is not found. Return param `nvs_stats` will be filled 0.
- `ESP_ERR_NVS_NOT_INITIALIZED` if the storage driver is not initialized. Return param `nvs_stats` will be filled 0.
- `ESP_ERR_INVALID_ARG` if `nvs_stats` is equal to `NULL`.
- `ESP_ERR_INVALID_STATE` if there is page with the status of `INVALID`. Return param `nvs_stats` will be filled not with correct values because not all pages will be counted. Counting will be interrupted at the first `INVALID` page.

`esp_err_t` `nvs_get_used_entry_count` (`nvs_handle_t` handle, `size_t` \*used\_entries)

Calculate all entries in a namespace.

An entry represents the smallest storage unit in NVS. Strings and blobs may occupy more than one entry. Note that to find out the total number of entries occupied by the namespace, add one to the returned value `used_entries` (if `err` is equal to `ESP_OK`). Because the name space entry takes one entry.

```
// Example of nvs_get_used_entry_count() to get amount of all key-value pairs.
↪in one namespace:
nvs_handle_t handle;
```

(下页继续)

```

nvs_open("namespace1", NVS_READWRITE, &handle);
...
size_t used_entries;
size_t total_entries_namespace;
if(nvs_get_used_entry_count(handle, &used_entries) == ESP_OK){
// the total number of entries occupied by the namespace
    total_entries_namespace = used_entries + 1;
}

```

**参数**

- **handle** -- **[in]** Handle obtained from `nvs_open` function.
- **used\_entries** -- **[out]** Returns amount of used entries from a namespace.

**返回**

- ESP\_OK if the changes have been written successfully. Return param `used_entries` will be filled valid value.
- ESP\_ERR\_NVS\_NOT\_INITIALIZED if the storage driver is not initialized. Return param `used_entries` will be filled 0.
- ESP\_ERR\_NVS\_INVALID\_HANDLE if handle has been closed or is NULL. Return param `used_entries` will be filled 0.
- ESP\_ERR\_INVALID\_ARG if `used_entries` is equal to NULL.
- Other error codes from the underlying storage driver. Return param `used_entries` will be filled 0.

`esp_err_t nvs_entry_find` (const char \*part\_name, const char \*namespace\_name, `nvs_type_t` type, `nvs_iterator_t` \*output\_iterator)

Create an iterator to enumerate NVS entries based on one or more parameters.

```

// Example of listing all the key-value pairs of any type under specified
↳partition and namespace
nvs_iterator_t it = NULL;
esp_err_t res = nvs_entry_find(<nvs_partition_name>, <namespace>, NVS_TYPE_
↳ANY, &it);
while(res == ESP_OK) {
nvs_entry_info_t info;
    nvs_entry_info(it, &info); // Can omit error check if parameters are
↳guaranteed to be non-NULL
    printf("key '%s', type '%d' \n", info.key, info.type);
    res = nvs_entry_next(&it);
}
nvs_release_iterator(it);

```

**参数**

- **part\_name** -- **[in]** Partition name
- **namespace\_name** -- **[in]** Set this value if looking for entries with a specific namespace. Pass NULL otherwise.
- **type** -- **[in]** One of `nvs_type_t` values.
- **output\_iterator** -- **[out]** Set to a valid iterator to enumerate all the entries found. Set to NULL if no entry for specified criteria was found. If any other error except ESP\_ERR\_INVALID\_ARG occurs, `output_iterator` is NULL, too. If ESP\_ERR\_INVALID\_ARG occurs, `output_iterator` is not changed. If a valid iterator is obtained through this function, it has to be released using `nvs_release_iterator` when not used any more, unless ESP\_ERR\_INVALID\_ARG is returned.

**返回**

- ESP\_OK if no internal error or programming error occurred.
- ESP\_ERR\_NVS\_NOT\_FOUND if no element of specified criteria has been found.
- ESP\_ERR\_NO\_MEM if memory has been exhausted during allocation of internal structures.

- `ESP_ERR_INVALID_ARG` if any of the parameters is `NULL`. Note: don't release `output_iterator` in case `ESP_ERR_INVALID_ARG` has been returned

`esp_err_t nvs_entry_find_in_handle` (*nvs\_handle\_t* handle, *nvs\_type\_t* type, *nvs\_iterator\_t* \*output\_iterator)

Create an iterator to enumerate NVS entries based on a handle and type.

```
// Example of listing all the key-value pairs of any type under specified_
↪handle (which defines a partition and namespace)
nvs_iterator_t it = NULL;
esp_err_t res = nvs_entry_find_in_handle(<nvs_handle>, NVS_TYPE_ANY, &it);
while(res == ESP_OK) {
nvs_entry_info_t info;
    nvs_entry_info(it, &info); // Can omit error check if parameters are_
↪guaranteed to be non-NULL
    printf("key '%s', type '%d' \n", info.key, info.type);
    res = nvs_entry_next(&it);
}
nvs_release_iterator(it);
```

### 参数

- **handle** -- **[in]** Handle obtained from `nvs_open` function.
- **type** -- **[in]** One of `nvs_type_t` values.
- **output\_iterator** -- **[out]** Set to a valid iterator to enumerate all the entries found. Set to `NULL` if no entry for specified criteria was found. If any other error except `ESP_ERR_INVALID_ARG` occurs, `output_iterator` is `NULL`, too. If `ESP_ERR_INVALID_ARG` occurs, `output_iterator` is not changed. If a valid iterator is obtained through this function, it has to be released using `nvs_release_iterator` when not used any more, unless `ESP_ERR_INVALID_ARG` is returned.

### 返回

- `ESP_OK` if no internal error or programming error occurred.
- `ESP_ERR_NVS_NOT_FOUND` if no element of specified criteria has been found.
- `ESP_ERR_NO_MEM` if memory has been exhausted during allocation of internal structures.
- `ESP_ERR_NVS_INVALID_HANDLE` if unknown handle was specified.
- `ESP_ERR_INVALID_ARG` if `output_iterator` parameter is `NULL`. Note: don't release `output_iterator` in case `ESP_ERR_INVALID_ARG` has been returned

`esp_err_t nvs_entry_next` (*nvs\_iterator\_t* \*iterator)

Advances the iterator to next item matching the iterator criteria.

Note that any copies of the iterator will be invalid after this call.

**参数** **iterator** -- **[inout]** Iterator obtained from `nvs_entry_find` or `nvs_entry_find_in_handle` function. Must be non-`NULL`. If any error except `ESP_ERR_INVALID_ARG` occurs, `iterator` is set to `NULL`. If `ESP_ERR_INVALID_ARG` occurs, `iterator` is not changed.

### 返回

- `ESP_OK` if no internal error or programming error occurred.
- `ESP_ERR_NVS_NOT_FOUND` if no next element matching the iterator criteria.
- `ESP_ERR_INVALID_ARG` if `iterator` is `NULL`.
- Possibly other errors in the future for internal programming or flash errors.

`esp_err_t nvs_entry_info` (const *nvs\_iterator\_t* iterator, *nvs\_entry\_info\_t* \*out\_info)

Fills `nvs_entry_info_t` structure with information about entry pointed to by the iterator.

### 参数

- **iterator** -- **[in]** Iterator obtained from `nvs_entry_find` or `nvs_entry_find_in_handle` function. Must be non-`NULL`.

- **out\_info** -- **[out]** Structure to which entry information is copied.
- 返回
- ESP\_OK if all parameters are valid; current iterator data has been written to out\_info
  - ESP\_ERR\_INVALID\_ARG if one of the parameters is NULL.

void **nvs\_release\_iterator** (*nvs\_iterator\_t* iterator)

Release iterator.

参数 **iterator** -- **[in]** Release iterator obtained from `nvs_entry_find` or `nvs_entry_find_in_handle` or `nvs_entry_next` function. NULL argument is allowed.

## Structures

struct **nvs\_entry\_info\_t**

information about entry obtained from `nvs_entry_info` function

### Public Members

char **namespace\_name**[NVS\_NS\_NAME\_MAX\_SIZE]

Namespace to which key-value belong

char **key**[NVS\_KEY\_NAME\_MAX\_SIZE]

Key of stored key-value pair

*nvs\_type\_t* **type**

Type of stored key-value pair

struct **nvs\_stats\_t**

---

备注: Info about storage space NVS.

---

### Public Members

size\_t **used\_entries**

Number of used entries.

size\_t **free\_entries**

Number of free entries. It includes also reserved entries.

size\_t **available\_entries**

Number of entries available for data storage.

size\_t **total\_entries**

Number of all entries.

size\_t **namespace\_count**

Number of namespaces.



**Macros****ESP\_ERR\_NVS\_BASE**

Starting number of error codes

**ESP\_ERR\_NVS\_NOT\_INITIALIZED**

The storage driver is not initialized

**ESP\_ERR\_NVS\_NOT\_FOUND**

A requested entry couldn't be found or namespace doesn't exist yet and mode is NVS\_READONLY

**ESP\_ERR\_NVS\_TYPE\_MISMATCH**

The type of set or get operation doesn't match the type of value stored in NVS

**ESP\_ERR\_NVS\_READ\_ONLY**

Storage handle was opened as read only

**ESP\_ERR\_NVS\_NOT\_ENOUGH\_SPACE**

There is not enough space in the underlying storage to save the value

**ESP\_ERR\_NVS\_INVALID\_NAME**

Namespace name doesn't satisfy constraints

**ESP\_ERR\_NVS\_INVALID\_HANDLE**

Handle has been closed or is NULL

**ESP\_ERR\_NVS\_REMOVE\_FAILED**

The value wasn't updated because flash write operation has failed. The value was written however, and update will be finished after re-initialization of nvs, provided that flash operation doesn't fail again.

**ESP\_ERR\_NVS\_KEY\_TOO\_LONG**

Key name is too long

**ESP\_ERR\_NVS\_PAGE\_FULL**

Internal error; never returned by nvs API functions

**ESP\_ERR\_NVS\_INVALID\_STATE**

NVS is in an inconsistent state due to a previous error. Call `nvs_flash_init` and `nvs_open` again, then retry.

**ESP\_ERR\_NVS\_INVALID\_LENGTH**

String or blob length is not sufficient to store data

**ESP\_ERR\_NVS\_NO\_FREE\_PAGES**

NVS partition doesn't contain any empty pages. This may happen if NVS partition was truncated. Erase the whole partition and call `nvs_flash_init` again.

**ESP\_ERR\_NVS\_VALUE\_TOO\_LONG**

Value doesn't fit into the entry or string or blob length is longer than supported by the implementation

**ESP\_ERR\_NVS\_PART\_NOT\_FOUND**

Partition with specified name is not found in the partition table



**ESP\_ERR\_NVS\_NEW\_VERSION\_FOUND**

NVS partition contains data in new format and cannot be recognized by this version of code

**ESP\_ERR\_NVS\_XTS\_ENCR\_FAILED**

XTS encryption failed while writing NVS entry

**ESP\_ERR\_NVS\_XTS\_DECR\_FAILED**

XTS decryption failed while reading NVS entry

**ESP\_ERR\_NVS\_XTS\_CFG\_FAILED**

XTS configuration setting failed

**ESP\_ERR\_NVS\_XTS\_CFG\_NOT\_FOUND**

XTS configuration not found

**ESP\_ERR\_NVS\_ENCR\_NOT\_SUPPORTED**

NVS encryption is not supported in this version

**ESP\_ERR\_NVS\_KEYS\_NOT\_INITIALIZED**

NVS key partition is uninitialized

**ESP\_ERR\_NVS\_CORRUPT\_KEY\_PART**

NVS key partition is corrupt

**ESP\_ERR\_NVS\_WRONG\_ENCRYPTION**

NVS partition is marked as encrypted with generic flash encryption. This is forbidden since the NVS encryption works differently.

**ESP\_ERR\_NVS\_CONTENT\_DIFFERS**

Internal error; never returned by nvs API functions. NVS key is different in comparison

**NVS\_DEFAULT\_PART\_NAME**

Default partition name of the NVS partition in the partition table

**NVS\_PART\_NAME\_MAX\_SIZE**

maximum length of partition name (excluding null terminator)

**NVS\_KEY\_NAME\_MAX\_SIZE**

Maximum length of NVS key name (including null terminator)

**NVS\_NS\_NAME\_MAX\_SIZE**

Maximum length of NVS namespace name (including null terminator)

**NVS\_GUARD\_SYSVIEW\_MACRO\_EXPANSION\_PUSH ()**

**NVS\_GUARD\_SYSVIEW\_MACRO\_EXPANSION\_POP ()**

### Type Definitions

typedef uint32\_t **nvs\_handle\_t**

Opaque pointer type representing non-volatile storage handle

typedef *nvs\_handle\_t* **nvs\_handle**

typedef *nvs\_open\_mode\_t* **nvs\_open\_mode**

typedef struct nvs\_opaque\_iterator\_t \***nvs\_iterator\_t**

Opaque pointer type representing iterator to nvs entries

### Enumerations

enum **nvs\_open\_mode\_t**

Mode of opening the non-volatile storage.

*Values:*

enumerator **NVS\_READONLY**

Read only

enumerator **NVS\_READWRITE**

Read and write

enum **nvs\_type\_t**

Types of variables.

*Values:*

enumerator **NVS\_TYPE\_U8**

Type uint8\_t

enumerator **NVS\_TYPE\_I8**

Type int8\_t

enumerator **NVS\_TYPE\_U16**

Type uint16\_t

enumerator **NVS\_TYPE\_I16**

Type int16\_t

enumerator **NVS\_TYPE\_U32**

Type uint32\_t

enumerator **NVS\_TYPE\_I32**

Type int32\_t

enumerator **NVS\_TYPE\_U64**

Type uint64\_t

enumerator **NVS\_TYPE\_I64**

Type int64\_t

enumerator **NVS\_TYPE\_STR**

Type string

enumerator **NVS\_TYPE\_BLOB**

Type blob

enumerator **NVS\_TYPE\_ANY**

Must be last

## 2.9.4 NVS 加密

### 概述

本文档主要介绍 NVS 加密功能，这一功能有助于实现设备在 flash 中的安全存储。

存储在 NVS 分区中的数据可以用 XTS-AES 进行加密，与磁盘加密标准 IEEE P1619 中提到的加密方式类似。加密时，每个条目都被视作一个 sector，而条目的相对地址（相对于分区起始位置）作为 sector-number 输入加密算法。

根据要使用的具体方案，可以选择启用 [CONFIG\\_NVS\\_ENCRYPTION](#) 和 [CONFIG\\_NVS\\_SEC\\_KEY\\_PROTECTION\\_SCHEME](#) > CONFIG\_NVS\_SEC\_KEY\_PROTECT\_USING\_FLASH\_ENC 或 CONFIG\_NVS\_SEC\_KEY\_PROTECT\_USING\_HMAC 实现 NVS 加密。

### NVS 加密：基于 flash 加密的方案

在这个方案中，NVS 加密所需的密钥存储在另一个分区中，该分区用 [flash 加密](#) 进行保护。因此，使用该方案时，必须先启用 [flash 加密](#)。

启用 [flash 加密](#) 时需同时启用 NVS 加密，因为 Wi-Fi 驱动程序会将凭据（如 SSID 和密码）储存在默认的 NVS 分区中。如已启用平台级加密，那么则需要同时启用 NVS 加密。

要用这一方案进行 NVS 加密，分区表中必须包含 [NVS 密钥分区](#)。在分区表选项 (menuconfig > Partition Table) 中，有两个包含 [NVS 密钥分区](#) 的分区表，可通过项目配置菜单 (idf.py menuconfig) 进行选择。要了解如何配置和使用 NVS 加密功能，请参考示例 [security/flash\\_encryption](#)。

**NVS 密钥分区** 应用如果要使用 NVS 加密（使用基于 flash 加密的方案）编译时，须使用类型为 data 和子类型为 key 的密钥分区。该分区应被标记为 encrypted 且最小为 4 KB（最小分区大小）。参考 [分区表](#) 了解详情。在分区表选项 (menuconfig > Partition Table) 中，有两个包含 [NVS 密钥分区](#) 的额外分区表，可以直接用于 NVS 加密。分区的结构如下所示：

```
+-----+-----+-----+-----+
|           XTS encryption key (32)           |
+-----+-----+-----+-----+
|           XTS tweak key (32)                |
+-----+-----+-----+-----+
|           CRC32 (4)                         |
+-----+-----+-----+-----+
```

可以通过以下两种方式之一生成 [NVS 密钥分区](#) 中的 XTS 加密密钥：

### 在 ESP32-H2 芯片上生成密钥

- 启用 NVS 加密时，可使用 API 函数 `nvs_flash_init()` 来初始化加密的默认 NVS 分区。该 API 函数会内部生成 ESP 芯片的 XTS 加密密钥，并找到第一个 NVS 密钥分区。
- 然后，该 API 函数使用 `nvs_flash/include/nvs_flash.h` 提供的 `nvs_flash_generate_keys()` API 函数，自动生成 NVS 密钥并存储到该分区。只有当相应的密钥分区为空时，才会生成和存储新密钥。然后，就可以利用 `nvs_flash_secure_init_partition()` 用此密钥分区来读取安全配置，以初始化自定义的加密 NVS 分区。
- API 函数 `nvs_flash_secure_init()` 和 `nvs_flash_secure_init_partition()` 不会内部生成密钥。如果要使用这两个 API 函数初始化加密的 NVS 分区，可以在启动后使用 `nvs_flash.h` 提供的 `nvs_flash_generate_keys()` API 函数生成密钥，然后由该 API 函数将生成的密钥以加密形式写入密钥分区中。

**备注：** 请注意，在使用此方法启动应用程序前，必须完全擦除 `nvs_keys` 分区。否则，应用程序可能会生成 `ESP_ERR_NVS_CORRUPT_KEY_PART` 错误代码，该代码假设 `nvs_keys` 分区不为空并且包含格式错误的数据。可以使用以下命令来实现：

```
parttool.py --port PORT --partition-table-file=PARTITION_TABLE_FILE --
↳partition-table-offset PARTITION_TABLE_OFFSET erase_partition --
↳partition-type=data --partition-subtype=nvs_keys
```

### 使用预生成的 NVS 密钥分区

如果 NVS 密钥分区中的密钥不是由应用程序生成，则需要使用预先生成的密钥分区。可以使用 NVS 分区生成程序生成包含 XTS 加密密钥的 NVS 密钥分区。然后使用以下两个命令将生成的密钥分区存储到 flash 上：

#### 1. 构建并烧写分区表

```
idf.py partition-table partition-table-flash
```

#### 2. 使用 `parttool.py`（参见分区表中分区工具相关章节）将密钥存储在 flash 上的 NVS 密钥分区中

```
parttool.py --port PORT --partition-table-offset PARTITION_TABLE_OFFSET
↳write_partition --partition-name="name of nvs_key partition" --input
↳NVS_KEY_PARTITION_FILE
```

**备注：** 如果设备是在 flash 加密开发模式下加密的，那么要更新 NVS 密钥分区就需要使用 `parttool.py` 来加密 NVS 密钥分区，并提供一个指向你构建目录中未加密分区表的指针 (`build/partition_table`)，因为设备上的分区表也是加密的。命令如下：

```
parttool.py --esptool-write-args encrypt --port PORT --partition-table-
↳file=PARTITION_TABLE_FILE --partition-table-offset PARTITION_TABLE_
↳OFFSET write_partition --partition-name="nvs_key 分区名称" --input NVS_
↳KEY_PARTITION_FILE
```

由于密钥分区被标记为 `encrypted`，且 `flash 加密` 已启用，引导程序会在首次启动时使用 flash 加密密钥对此分区进行加密。

一个应用程序可以使用不同的密钥对不同的 NVS 分区进行加密，从而拥有多个密钥分区。应用程序应为加密或解密操作提供正确的密钥分区和密钥信息。

### NVS 加密：基于 HMAC 外设的方案

此方案中，用于 NVS 加密的 XTS 密钥来自 eFuse 中编程的 HMAC 密钥，其目的是 `esp_efuse_purpose_t::ESP_EFUSE_KEY_PURPOSE_HMAC_UP`。由于加密密钥在运行时生成，不存储在 flash 中，因此这个功能不需要单独的 NVS 密钥分区。

---

**备注：**通过这个方案，无需启用 **flash 加密** 就能在 ESP32-H2 上实现安全存储。

---

**重要：**注意，此方案使用一个 eFuse 块来存储获取加密密钥所需的 HMAC 密钥。

---

- NVS 加密启用后，可用 API 函数 `nvs_flash_init()` 来初始化加密的默认 NVS 分区。该 API 函数首先检查 `CONFIG_NVS_SEC_HMAC_EFUSE_KEY_ID` 处是否存在一个 HMAC 密钥。
- 

**备注：**`CONFIG_NVS_SEC_HMAC_EFUSE_KEY_ID` 配置的有效范围为 0 (`hmac_key_id_t::HMAC_KEY0`) 到 5 (`hmac_key_id_t::HMAC_KEY5`)。默认情况下该配置为 6 (`hmac_key_id_t::HMAC_KEY_MAX`)，须在构建用户应用程序之前进行修改。

---

- 如果找不到密钥，会内部生成一个密钥，并储存在 `CONFIG_NVS_SEC_HMAC_EFUSE_KEY_ID` 指定的 eFuse 块中。
  - 如果找到用于 `esp_efuse_purpose_t::ESP_EFUSE_KEY_PURPOSE_HMAC_UP` 的密钥，该密钥也会用于 XTS 加密密钥的生成。
  - 如果指定的 eFuse 块被 `esp_efuse_purpose_t::ESP_EFUSE_KEY_PURPOSE_HMAC_UP` 以外目的的密钥占用，则会引发错误。
  - 然后，API `nvs_flash_init()` 使用 `nvs_flash/include/nvs_flash.h` 提供的 `nvs_flash_generate_keys_v2()` API 函数，自动生成所需的 NVS 密钥。该密钥还可用于读取安全配置（参见 `nvs_flash_read_security_cfg_v2()`）并通过 `nvs_flash_secure_init_partition()` 初始化自定义的加密 NVS 分区。
  - API 函数 `nvs_flash_secure_init()` 和 `nvs_flash_secure_init_partition()` 不会内部生成密钥。使用这些 API 函数初始化加密的 NVS 分区时，可在启动后用 API 函数 `nvs_flash_generate_keys_v2()` 生成密钥，或使用 `nvs_flash_read_security_cfg_v2()` 获取并填充 NVS 安全配置结构 `nvs_sec_cfg_t`，将其输入到上述 API 中。
- 

**备注：**可以使用以下命令预先在 eFuse 中设置自己的 HMAC 密钥：

```
espefuse.py -p PORT burn_key <BLOCK_KEYN> <hmac_key_file.bin> HMAC_UP
```

---

## 加密读/写

NVS API 函数 `nvs_get_*` 或 `nvs_set_*` 也可用于读取和写入加密的 NVS 分区。

### 加密默认的 NVS 分区

- 要为默认 NVS 分区启用加密，无需额外的步骤。在启用 `CONFIG_NVS_ENCRYPTION` 时，API 函数 `nvs_flash_init()` 会根据使用的方案（由 `CONFIG_NVS_SEC_KEY_PROTECTION_SCHEME` 设置）在内部执行一些额外步骤，为默认的 NVS 分区启用加密。
- 在基于 flash 加密的方案中，加密密钥由找到的第一个 **NVS 密钥分区** 生成。在 HMAC 方案中，密钥由 `CONFIG_NVS_SEC_HMAC_EFUSE_KEY_ID` 中烧录的 HMAC 密钥生成（参考 API 文档以了解更多信息）。

另外，还可使用 API 函数 `nvs_flash_secure_init()` 为默认 NVS 分区启用加密。

### 加密自定义 NVS 分区

- 要为一个自定义的 NVS 分区启用加密，使用 API 函数 `nvs_flash_secure_init_partition()` 代替 `nvs_flash_init_partition()`。
- 使用 API 函数 `nvs_flash_secure_init()` 和 `nvs_flash_secure_init_partition()` 时，为了在启用加密的情况下执行 NVS 读/写操作，应用程序应遵守以下步骤：
  1. 填充 NVS 安全配置结构 `nvs_sec_cfg_t`
    - 对基于 flash 加密的方案

- \* 使用 API 函数 `esp_partition_find` 查找密钥分区和 NVS 数据分区。
- \* 使用 API 函数 `nvs_flash_read_security_cfg()` 或 `nvs_flash_generate_keys()` 填充 `nvs_sec_cfg_t` 结构体。
- 对基于 HMAC 的方案
  - \* 用 `nvs_sec_config_hmac_t` 为设置特定方案配置数据，并使用 API `nvs_sec_provider_register_hmac()` 注册此基于 HMAC 的方案。该 API 也将用于填充特定方案的句柄（参见 `nvs_sec_scheme_t`）。
  - \* 使用 API 函数 `nvs_flash_read_security_cfg_v2()` 或 `nvs_flash_generate_keys_v2()` 填充 `nvs_sec_cfg_t` 结构体。

```

nvs_sec_cfg_t cfg = {};
nvs_sec_scheme_t *sec_scheme_handle = NULL;

nvs_sec_config_hmac_t sec_scheme_cfg = {};
hmac_key_id_t hmac_key = HMAC_KEY0;
sec_scheme_cfg.hmac_key_id = hmac_key;

ret = nvs_sec_provider_register_hmac(&sec_scheme_cfg, &sec_scheme_
↪handle);
if (ret != ESP_OK) {
return ret;
}

ret = nvs_flash_read_security_cfg_v2(sec_scheme_handle, &cfg);
if (ret != ESP_OK) {
if (ret == ESP_ERR_NVS_SEC_HMAC_KEY_NOT_FOUND) {
ret = nvs_flash_generate_keys_v2(&sec_scheme_handle, &cfg);
if (ret != ESP_OK) {
ESP_LOGE(TAG, "Failed to generate NVS encr-keys!");
return ret;
}
}
ESP_LOGE(TAG, "Failed to read NVS security cfg!");
return ret;
}

```

2. 使用 API 函数 `nvs_flash_secure_init()` 或 `nvs_flash_secure_init_partition()` 初始化 NVS flash 分区。
3. 使用 API 函数 `nvs_open()` 或 `nvs_open_from_partition()` 打开一个命名空间。
4. 使用 `nvs_get_*` 或 `nvs_set_*` 执行 NVS 读/写操作。
5. 使用 `nvs_flash_deinit()` 取消初始化 NVS 分区。

**备注：** 在采用基于 HMAC 的方案时，可以在不启用任何 NVS 加密的配置选项的情况下开始上述工作流：`CONFIG_NVS_ENCRYPTION`，`CONFIG_NVS_SEC_KEY_PROTECTION_SCHEME` -> `CONFIG_NVS_SEC_KEY_PROTECT_USING_HMAC` 和 `CONFIG_NVS_SEC_HMAC_EFUSE_KEY_ID`，以使用 `nvs_flash_secure_init()` API 加密默认分区及自定义的 NVS 分区。

## NVS Security Provider

组件 `nvs_sec_provider` 存储了 NVS 加密方案的所有特定实现代码，并且适用于未来的方案。此组件充当 `nvs_flash` 组件处理加密密钥的接口。组件 `nvs_sec_provider` 有自己的配置菜单，选定的安全方案和相应设置基于这一菜单注册到 `nvs_flash` 组件。

该组件通过工厂函数注册了特殊的安全框架，可以实现出厂即用的安全方案。在该方案中，无需使用 API 来生成、读取加密密钥（如 `nvs_sec_provider_register_hmac()`）。要了解 API 的使用，参考示例 `security/nvs_encryption_hmac`。

## API 参考

### Header File

- `components/nvs_sec_provider/include/nvs_sec_provider.h`
- This header file can be included with:

```
#include "nvs_sec_provider.h"
```

- This header file is a part of the API provided by the `nvs_sec_provider` component. To declare that your component depends on `nvs_sec_provider`, add the following to your `CMakeLists.txt`:

```
REQUIRES nvs_sec_provider
```

or

```
PRIV_REQUIRES nvs_sec_provider
```

### Functions

`esp_err_t nvs_sec_provider_register_flash_enc` (const `nvs_sec_config_flash_enc_t` \*`sec_scheme_cfg`, `nvs_sec_scheme_t` \*\*`sec_scheme_handle_out`)

Register the Flash-Encryption based scheme for NVS Encryption.

#### 参数

- `sec_scheme_cfg` -- [in] Security scheme specific configuration data
- `sec_scheme_handle_out` -- [out] Security scheme specific configuration handle

#### 返回

- `ESP_OK`, if `sec_scheme_handle_out` was populated successfully with the scheme configuration;
- `ESP_ERR_INVALID_ARG`, if `scheme_cfg_hmac` is `NULL`;
- `ESP_ERR_NO_MEM`, No memory for the scheme-specific handle `sec_scheme_handle_out`
- `ESP_ERR_NOT_FOUND`, if no `nvs_keys` partition is found

`esp_err_t nvs_sec_provider_register_hmac` (const `nvs_sec_config_hmac_t` \*`sec_scheme_cfg`, `nvs_sec_scheme_t` \*\*`sec_scheme_handle_out`)

Register the HMAC-based scheme for NVS Encryption.

#### 参数

- `sec_scheme_cfg` -- [in] Security scheme specific configuration data
- `sec_scheme_handle_out` -- [out] Security scheme specific configuration handle

#### 返回

- `ESP_OK`, if `sec_scheme_handle_out` was populated successfully with the scheme configuration;
- `ESP_ERR_INVALID_ARG`, if `scheme_cfg_hmac` is `NULL`;
- `ESP_ERR_NO_MEM`, No memory for the scheme-specific handle `sec_scheme_handle_out`

`esp_err_t nvs_sec_provider_deregister` (`nvs_sec_scheme_t` \*`sec_scheme_handle`)

Deregister the NVS encryption scheme registered with the given handle.

参数 `sec_scheme_handle` -- [in] Security scheme specific configuration handle

#### 返回

- `ESP_OK`, if the scheme registered with `sec_scheme_handle` was deregistered successfully
- `ESP_ERR_INVALID_ARG`, if `sec_scheme_handle` is `NULL`;

### Structures



struct **nvs\_sec\_config\_flash\_enc\_t**

Flash encryption-based scheme specific configuration data.

### Public Members

const *esp\_partition\_t* \***nvs\_keys\_part**

Partition of subtype `nvs_keys` holding the NVS encryption keys

struct **nvs\_sec\_config\_hmac\_t**

HMAC-based scheme specific configuration data.

### Public Members

*hmac\_key\_id\_t* **hmac\_key\_id**

HMAC Key ID used for generating the NVS encryption keys

### Macros

**ESP\_ERR\_NVS\_SEC\_BASE**

Starting number of error codes

**ESP\_ERR\_NVS\_SEC\_HMAC\_KEY\_NOT\_FOUND**

HMAC Key required to generate the NVS encryption keys not found

**ESP\_ERR\_NVS\_SEC\_HMAC\_KEY\_BLK\_ALREADY\_USED**

Provided eFuse block for HMAC key generation is already in use

**ESP\_ERR\_NVS\_SEC\_HMAC\_KEY\_GENERATION\_FAILED**

Failed to generate/write the HMAC key to eFuse

**ESP\_ERR\_NVS\_SEC\_HMAC\_XTS\_KEYS\_DERIV\_FAILED**

Failed to derive the NVS encryption keys based on the HMAC-based scheme

**NVS\_SEC\_PROVIDER\_CFG\_FLASH\_ENC\_DEFAULT** ()

Helper for populating the Flash encryption-based scheme specific configuration data.

**NVS\_SEC\_PROVIDER\_CFG\_HMAC\_DEFAULT** ()

Helper for populating the HMAC-based scheme specific configuration data.

### Enumerations

enum **nvs\_sec\_scheme\_id\_t**

NVS Encryption Keys Protection Scheme.

*Values:*

enumerator **NVS\_SEC\_SCHEME\_FLASH\_ENC**

Protect NVS encryption keys using Flash Encryption



enumerator **NVS\_SEC\_SCHEME\_HMAC**

Protect NVS encryption keys using HMAC peripheral

enumerator **NVS\_SEC\_SCHEME\_MAX**

## 2.9.5 NVS 分区生成程序

### 介绍

NVS 分区生成程序 (`nvs_flash/nvs_partition_generator/nvs_partition_gen.py`) 根据 CSV 文件中的键值对生成二进制文件。该二进制文件与非易失性存储库中定义的 NVS 结构兼容。

NVS 分区生成程序适合用于生成二进制数据 (blob)，其中包括设备生产时可从外部烧录的 ODM/OEM 数据。这也使得生产制造商在使用同一个应用固件的基础上，通过自定义参数，如序列号，为每个设备生成不同配置的二进制 NVS 分区。

### 准备工作

在加密模式下使用该程序，需安装下列软件包：

- cryptography

根目录下的 `requirements.txt` 包含必需 python 包，请预先安装。

**CSV 文件格式** CSV 文件每行需包含四个参数，以逗号隔开。具体参数描述见下表：

序号	参数	描述	说明
1	Key	主键，应用程序可通过查询此键来获取数据。	
2	Type	支持 file、data 和 namespace。	
3	Encoding	支持 u8、i8、u16、i16、u32、i32、u64、i64、string、hex2bin、base64 和 binary。决定二进制 bin 文件中 value 被编码成的类型。string 和 binary 编码的区别在于，string 数据以 NULL 字符结尾，binary 数据则不是。	file 类型当前仅支持 hex2bin、base64、string 和 binary 编码。
4	Value	Data value	namespace 字段的 encoding 和 value 应为空。namespace 的 encoding 和 value 为固定值，不可设置。这些单元格中的所有值都会被忽视。

**备注：**CSV 文件的第一行应始终为列标题，不可设置。

此类 CSV 文件的 Dump 示例如下：

```
key,type,encoding,value      <-- 列标题
namespace_name,namespace,,  <-- 第一个条目为 "namespace"
key1,data,u8,1
key2,file,string,/path/to/file
```

---

**备注:**

**请确保:**

- 逗号','前后无空格;
  - CSV 文件每行末尾无空格。
- 

### NVS 条目和命名空间 (namespace) 的关联

如 CSV 文件中出现命名空间条目, 后续条目均会被视为该命名空间的一部分, 直至找到下一个命名空间条目。找到新命名空间条目后, 后续所有条目都会被视为新命名空间的一部分。

---

**备注:** CSV 文件中第一个条目应始终为 namespace。

---

### 支持多页 blob

默认情况下, 二进制 blob 可跨多页, 格式参考[条目结构](#) 章节。如需使用旧版格式, 可在程序中禁用该功能。

### 支持加解密

NVS 分区生成程序还可使用 XTS-AES 加密生成二进制加密文件或对此类文件进行解密。更多信息详见[NVS 加密](#)。

### 运行程序

**使用方法:**

```
python nvs_partition_gen.py [-h] {generate,generate-key,encrypt,decrypt} ...
```

**可选参数:**

序号	参数	描述
1	-h / --help	显示帮助信息并退出

**命令:**

运行 `nvs_partition_gen.py {command} -h` 查看更多帮助信息

序号	参数	描述
1	generate	生成 NVS 分区
2	generate-key	生成加密密钥
3	encrypt	加密 NVS 分区
4	decrypt	解密 NVS 分区

### 生成 NVS 分区 (默认模式) 使用方法:

```
python nvs_partition_gen.py generate [-h] [--version {1,2}] [--outdir OUTDIR]
↔input output size
```

**位置参数:**

参数	描述
input	待解析的 CSV 文件路径
output	NVS 二进制文件的输出路径
size	NVS 分区大小 (以字节为单位, 且为 4096 的整数倍)

**可选参数:**

参数	描述
-h / --help	显示帮助信息并退出
--version {1,2}	<ul style="list-style-type: none"> <li>设置多页 blob 版本, 默认为版本 2。</li> <li>版本 1: 禁用多页 blob;</li> <li>版本 2: 启用多页 blob。</li> </ul>
--outdir OUTDIR	输出目录, 用于存储创建的文件。(默认当前目录)

运行如下命令创建 NVS 分区, 该程序同时会提供 CSV 示例文件:

```
python nvs_partition_gen.py generate sample_singlepage_blob.csv sample.bin 0x3000
```

**生成加密密钥分区 使用方法:**

```
python nvs_partition_gen.py generate-key [-h] [--key_protect_hmac] [--kp_hmac_
↪keygen]
                                [--kp_hmac_keyfile KP_HMAC_KEYFILE] ↪
↪[--kp_hmac_inputkey KP_HMAC_INPUTKEY]
                                [--keyfile KEYFILE] [--outdir OUTDIR]
```

**可选参数:**

参数	描述
-h / --help	显示帮助信息并退出
--keyfile KEYFILE	加密密钥分区文件的输出路径
--outdir OUTDIR	输出目录, 用于存储创建的文件 (默认当前目录)

**可选参数 (仅适用于 HMAC 方案):**

参数	描述
--key_protect_hmac	设置后使用基于 HMAC 的 NVS 加密密钥保护方案, 否则使用基于 flash 加密的默认方案
--kp_hmac_keygen	为基于 HMAC 的加密方案生成 HMAC 密钥
--kp_hmac_keyfile KP_HMAC_KEYFILE	HMAC 密钥文件的输出路径
--kp_hmac_inputkey KP_HMAC_INPUTKEY	包含 HMAC 密钥的文件, 用于生成 NVS 加密密钥

运行以下命令仅生成加密密钥分区:

```
python nvs_partition_gen.py generate-key
```

运行以下命令, 为基于 HMAC 的方案生成加密密钥:

- 生成 HMAC 密钥和 NVS 加密密钥:

```
python nvs_partition_gen.py generate-key --key_protect_hmac --kp_hmac_keygen
```

**备注：** 上述命令生成 <outdir>/keys/keys-<timestamp>.bin 格式的加密密钥和 <outdir>/keys/hmac-keys-<timestamp>.bin 格式的 HMAC 密钥。

- 基于 HMAC 密钥生成 NVS 加密密钥:

```
python nvs_partition_gen.py generate-key --key_protect_hmac --kp_hmac_inputkey_
↳testdata/sample_hmac_key.bin
```

**备注：** 可将自定义文件名作为参数提供给 HMAC 密钥和加密密钥。

### 生成 NVS 加密分区 使用方法:

```
python nvs_partition_gen.py encrypt [-h] [--version {1,2}] [--keygen]
                                     [--keyfile KEYFILE] [--inputkey INPUTKEY] [--
↳outdir OUTDIR]
                                     [--key_protect_hmac] [--kp_hmac_keygen]
                                     [--kp_hmac_keyfile KP_HMAC_KEYFILE] [--kp_hmac_
↳inputkey KP_HMAC_INPUTKEY]
                                     input output size
```

#### 位置参数:

参数	描述
input	待解析的 CSV 文件路径
output	NVS 二进制文件的输出路径
size	NVS 分区大小 (以字节为单位, 且为 4096 的整数倍)

#### 可选参数:

参数	描述
-h/--help	显示帮助信息并退出
--version {1,2}	<ul style="list-style-type: none"> <li>• 设置多页 blob 版本, 默认为版本 2。</li> <li>• 版本 1: 禁用多页 blob;</li> <li>• 版本 2: 启用多页 blob。</li> </ul>
--keygen	生成 NVS 分区加密密钥
--keyfile KEYFILE	密钥文件的输出路径
--inputkey INPUTKEY	内含 NVS 分区加密密钥的文件
--outdir OUTDIR	输出目录, 用于存储创建的文件。(默认当前目录)

#### 可选参数 (仅适用于 HMAC 方案) :

参数	描述
--key_protect_hmac	设置后使用基于 HMAC 的 NVS 加密密钥保护方案, 否则使用基于 flash 加密的默认方案
--kp_hmac_keygen	为基于 HMAC 的加密方案生成 HMAC 密钥
--kp_hmac_keyfile KP_HMAC_KEYFILE	HMAC 密钥文件的输出路径
--kp_hmac_inputkey KP_HMAC_INPUTKEY	包含 HMAC 密钥的文件, 用于生成 NVS 加密密钥

运行以下命令加密 NVS 分区，该程序同时会提供一个 CSV 示例文件。

- 通过 NVS 分区生成程序生成加密密钥来加密：

```
python nvs_partition_gen.py encrypt sample_singlepage_blob.csv sample_encr.bin
↪0x3000 --keygen
```

**备注：** 创建的加密密钥格式为 <outdir>/keys/keys-<timestamp>.bin。

- 要使用基于 HMAC 的方案生成加密分区，可将上述命令与附加参数搭配使用。
  - 通过 NVS 分区生成程序生成加密密钥和 HMAC 密钥，从而进行加密：

```
python nvs_partition_gen.py encrypt sample_singlepage_blob.csv sample_encr.
↪bin 0x3000 --keygen --key_protect_hmac --kp_hmac_keygen
```

**备注：** 上述命令生成 <outdir>/keys/keys-<timestamp>.bin 格式的加密密钥和 <outdir>/keys/hmac-keys-<timestamp>.bin 格式的 HMAC 密钥。

- 通过 NVS 分区生成程序使用用户提供的 HMAC 密钥生成加密密钥，从而进行加密：

```
python nvs_partition_gen.py encrypt sample_singlepage_blob.csv sample_encr.
↪bin 0x3000 --keygen --key_protect_hmac --kp_hmac_inputkey testdata/
↪sample_hmac_key.bin
```

**备注：** 可将自定义文件名作为参数提供给 HMAC 密钥和加密密钥。

- 通过 NVS 分区生成程序生成加密密钥，并将密钥存储于自定义的文件中：

```
python nvs_partition_gen.py encrypt sample_singlepage_blob.csv sample_encr.bin
↪0x3000 --keygen --keyfile sample_keys.bin
```

**备注：**

- 创建的加密密钥格式为 <outdir>/keys/sample\_keys.bin。
- 加密密钥存储于新建文件的 keys/ 目录下，与 NVS 密钥分区结构兼容。更多信息请参考 [NVS 密钥分区](#)。
- 将加密密钥用作二进制输入文件来进行加密：

```
python nvs_partition_gen.py encrypt sample_singlepage_blob.csv sample_encr.bin
↪0x3000 --inputkey sample_keys.bin
```

### 解密 NVS 分区 使用方法：

```
python nvs_partition_gen.py decrypt [-h] [--outdir OUTDIR] input key output
```

**位置参数：**

参数	描述
input	待解析的 NVS 加密分区文件路径
key	含有解密密钥的文件路径
output	已解密的二进制文件输出路径

**可选参数：**

参数	描述
-h / --help	显示帮助信息并退出
--outdir OUTDIR	输出目录，用于存储创建的文件（默认当前目录）

运行以下命令解密已加密的 NVS 分区：

```
python nvs_partition_gen.py decrypt sample_encr.bin sample_keys.bin sample_decr.bin
```

可以在命令中提供版本参数，选择格式版本号：

- 版本 1：禁用多页 blob
- 版本 2：启用多页 blob

**版本 1：禁用多页 blob** 如需禁用多页 blob，请按照如下命令将版本参数设置为 1，以此格式运行分区生成程序。该程序同时会提供一个 CSV 示例文件：

```
python nvs_partition_gen.py generate sample_singlepage_blob.csv sample.bin 0x3000 --
↪-version 1
```

**版本 2：启用多页 blob** 如需启用多页 blob，请按照如下命令将版本参数设置为 2，以此格式运行分区生成程序。该程序同时会提供一个 CSV 示例文件：

```
python nvs_partition_gen.py generate sample_multipage_blob.csv sample.bin 0x4000 --
↪version 2
```

#### 备注：

- NVS 分区最小为 0x3000 字节。
- 将二进制文件烧录至设备时，请确保与应用的 `sdkconfig` 设置一致。

#### 说明

- 分区生成程序不会对重复键进行检查，而将数据同时写入这两个重复键中。请注意不要使用同名的键；
- 新页面创建后，前一页的空白处不会再写入数据。CSV 文件中的字段须按次序排列以优化内存；
- 暂不支持 64 位数据类型。

## 2.9.6 NVS 分区解析程序

### 介绍

NVS 分区解析程序 `nvs_flash/nvs_partition_tool/nvs_tool.py` 加载并解析 NVS 存储分区，以便于调试和数据提取。该程序还支持完整性检查功能，可扫描分区中可能存在的错误。Blob 数据以 `base64` 格式进行编码。

### 加密分区

此程序不支持解密。如需解密 NVS 分区，请使用 [NVS 分区生成程序](#)。该工具支持 NVS 分区加解密。

## 使用方法

该程序提供了 `-f` 或 `-format` 选项，对应两种不同的输出格式：

- `json` - 所有输出均以 JSON 格式打印。
- `text` - 输出以可读文本的格式打印，有以下输出格式可选。

针对 `text` 输出格式，该程序提供了 `-d` 或 `-dump` 选项，包含六种不同的输出方式：

- `all` (默认) - 打印所有带有元数据的条目。
- `written` - 只打印带有元数据的写入条目。
- `minimal` - 打印写入的 `namespace:key = value` 对。
- `namespaces` - 打印所有写入的命名空间。
- `blobs` - 打印所有 blob 和字符串（若 blob 和字符串是以分块的形式，则对其进行重组）。
- `storage_info` - 打印每一页面的条目状态计数。

**注意：**该程序还提供 `none` 选项，该选项不会打印任何内容。如果 NVS 分区的内容并不相关，可以将该选项和完整性检查选项一起使用。

该程序支持完整性检查功能，选择选项 `-i` 或 `--integrity-check` 即可运行（该选项会导致 `json` 输出格式无效，因此只适用于 `text` 格式）。此功能可扫描整个分区，并打印出可能存在的错误。当此功能和 `-d none` 一起使用时，可只打印可能存在的错误。

## 2.9.7 SD/SDIO/MMC 驱动程序

### 概述

SD/SDIO/MMC 驱动是一种基于 SDMMC 和 SD SPI 主机驱动的协议级驱动程序，目前已支持 SD 存储器、SDIO 卡和 eMMC 芯片。

SDMMC 主机驱动和 SD SPI 主机驱动 (`esp_driver_sdmmc/include/driver/sdmmc_host.h` 和 `esp_driver_sdspi/include/driver/sdspi_host.h`) 为以下功能提供 API：

- 发送命令至从设备
- 接收和发送数据
- 处理总线错误

初始化函数及配置函数：

- 如需初始化和配置 SD SPI 主机，请参阅 [SD SPI 主机 API](#)

### 管脚配置

`..only:: SOC_SDMMC_USE_IOMUX and not SOC_SDMMC_USE_GPIO_MATRIX`

SDMMC 管脚为专用管脚，无需配置。

`..only:: SOC_SDMMC_USE_GPIO_MATRIX and not SOC_SDMMC_USE_IOMUX`

SDMMC 管脚信号通过 GPIO 交换矩阵配置，请在 `sdmmc_slot_config_t` 中配置管脚。

`..only:: esp32p4`

SDMMC 有两个卡槽：

- 卡槽 0 管脚为 UHS-I 模式专用，但驱动程序尚不支持此模式。

- 卡槽 1 管脚可通过 GPIO 交换矩阵配置，用于 UHS-I 之外的情况。如要使用卡槽 1，请在 `sdmmc_slot_config_t` 中配置管脚。

## 应用示例

ESP-IDF `storage/sd_card` 目录下提供了 SDMMC 驱动与 FatFs 库组合使用的示例，演示了先初始化卡，然后使用 POSIX 和 C 库 API 向卡读写数据。请参考示例目录下 `README.md` 文件，查看更多详细信息。

**复合卡 (存储 + IO)** 该驱动程序不支持 SD 复合卡，复合卡会被视为 IO 卡。

**线程安全** 多数应用程序仅需在一个任务中使用协议层。因此，协议层在 `sdmmc_card_t` 结构体或在访问 SDMMC 或 SD SPI 主机驱动程序时不使用任何类型的锁。这种锁通常在较高级别实现，例如文件系统驱动程序。

## API 参考

### Header File

- `components/sdmmc/include/sdmmc_cmd.h`
- This header file can be included with:

```
#include "sdmmc_cmd.h"
```

- This header file is a part of the API provided by the `sdmmc` component. To declare that your component depends on `sdmmc`, add the following to your `CMakeLists.txt`:

```
REQUIRES sdmmc
```

or

```
PRIV_REQUIRES sdmmc
```

### Functions

*esp\_err\_t* **sdmmc\_card\_init** (const `sdmmc_host_t` \*host, `sdmmc_card_t` \*out\_card)

Probe and initialize SD/MMC card using given host

---

**备注:** Only SD cards (SDSC and SDHC/SDXC) are supported now. Support for MMC/eMMC cards will be added later.

---

#### 参数

- **host** -- pointer to structure defining host controller
- **out\_card** -- pointer to structure which will receive information about the card when the function completes

#### 返回

- `ESP_OK` on success
- One of the error codes from SDMMC host controller

void **sdmmc\_card\_print\_info** (FILE \*stream, const `sdmmc_card_t` \*card)

Print information about the card to a stream.

#### 参数

- **stream** -- stream obtained using `fopen` or `fdopen`
- **card** -- card information structure initialized using `sdmmc_card_init`



*esp\_err\_t* **sdmmc\_get\_status** (sdmmc\_card\_t \*card)

Get status of SD/MMC card

**参数** **card** -- pointer to card information structure previously initialized using `sdmmc_card_init`

- 返回**
- ESP\_OK on success
  - One of the error codes from SDMMC host controller

*esp\_err\_t* **sdmmc\_write\_sectors** (sdmmc\_card\_t \*card, const void \*src, size\_t start\_sector, size\_t sector\_count)

Write given number of sectors to SD/MMC card

**参数**

- **card** -- pointer to card information structure previously initialized using `sdmmc_card_init`
- **src** -- pointer to data buffer to read data from; data size must be equal to `sector_count * card->csd.sector_size`
- **start\_sector** -- sector where to start writing
- **sector\_count** -- number of sectors to write

**返回**

- ESP\_OK on success or `sector_count` equal to 0
- One of the error codes from SDMMC host controller

*esp\_err\_t* **sdmmc\_read\_sectors** (sdmmc\_card\_t \*card, void \*dst, size\_t start\_sector, size\_t sector\_count)

Read given number of sectors from the SD/MMC card

**参数**

- **card** -- pointer to card information structure previously initialized using `sdmmc_card_init`
- **dst** -- pointer to data buffer to write into; buffer size must be at least `sector_count * card->csd.sector_size`
- **start\_sector** -- sector where to start reading
- **sector\_count** -- number of sectors to read

**返回**

- ESP\_OK on success or `sector_count` equal to 0
- One of the error codes from SDMMC host controller

*esp\_err\_t* **sdmmc\_erase\_sectors** (sdmmc\_card\_t \*card, size\_t start\_sector, size\_t sector\_count, sdmmc\_erase\_arg\_t arg)

Erase given number of sectors from the SD/MMC card

---

**备注:** When `sdmmc_erase_sectors` used with cards in SDSPI mode, it was observed that card requires re-init after erase operation.

---

**参数**

- **card** -- pointer to card information structure previously initialized using `sdmmc_card_init`
- **start\_sector** -- sector where to start erase
- **sector\_count** -- number of sectors to erase
- **arg** -- erase command (CMD38) argument

**返回**

- ESP\_OK on success or `sector_count` equal to 0
- One of the error codes from SDMMC host controller

*esp\_err\_t* **sdmmc\_can\_discard** (sdmmc\_card\_t \*card)

Check if SD/MMC card supports discard

**参数** **card** -- pointer to card information structure previously initialized using `sdmmc_card_init`

**返回**

- ESP\_OK if supported by the card/device
- ESP\_FAIL if not supported by the card/device

*esp\_err\_t* **sdmmc\_can\_trim** (sdmmc\_card\_t \*card)

Check if SD/MMC card supports trim

**参数** **card** -- pointer to card information structure previously initialized using `sdmmc_card_init`  
**返回**

- ESP\_OK if supported by the card/device
- ESP\_FAIL if not supported by the card/device

*esp\_err\_t* **sdmmc\_mmc\_can\_sanitize** (sdmmc\_card\_t \*card)

Check if SD/MMC card supports sanitize

**参数** **card** -- pointer to card information structure previously initialized using `sdmmc_card_init`  
**返回**

- ESP\_OK if supported by the card/device
- ESP\_FAIL if not supported by the card/device

*esp\_err\_t* **sdmmc\_mmc\_sanitize** (sdmmc\_card\_t \*card, uint32\_t timeout\_ms)

Sanitize the data that was unmapped by a Discard command

---

**备注:** Discard command has to precede sanitize operation. To discard, use `MMC_DICARD_ARG` with `sdmmc_erase_sectors` argument

---

**参数**

- **card** -- pointer to card information structure previously initialized using `sdmmc_card_init`
- **timeout\_ms** -- timeout value in milliseconds required to sanitize the selected range of sectors.

**返回**

- ESP\_OK on success
- One of the error codes from SDMMC host controller

*esp\_err\_t* **sdmmc\_full\_erase** (sdmmc\_card\_t \*card)

Erase complete SD/MMC card

**参数** **card** -- pointer to card information structure previously initialized using `sdmmc_card_init`  
**返回**

- ESP\_OK on success
- One of the error codes from SDMMC host controller

*esp\_err\_t* **sdmmc\_io\_read\_byte** (sdmmc\_card\_t \*card, uint32\_t function, uint32\_t reg, uint8\_t \*out\_byte)

Read one byte from an SDIO card using `IO_RW_DIRECT` (CMD52)

**参数**

- **card** -- pointer to card information structure previously initialized using `sdmmc_card_init`
- **function** -- IO function number
- **reg** -- byte address within IO function
- **out\_byte** -- **[out]** output, receives the value read from the card

**返回**

- ESP\_OK on success
- One of the error codes from SDMMC host controller

*esp\_err\_t* **sdmmc\_io\_write\_byte** (sdmmc\_card\_t \*card, uint32\_t function, uint32\_t reg, uint8\_t in\_byte, uint8\_t \*out\_byte)

Write one byte to an SDIO card using `IO_RW_DIRECT` (CMD52)

**参数**

- **card** -- pointer to card information structure previously initialized using `sdmmc_card_init`
- **function** -- IO function number
- **reg** -- byte address within IO function
- **in\_byte** -- value to be written
- **out\_byte** -- [out] if not NULL, receives new byte value read from the card (read-after-write).

#### 返回

- ESP\_OK on success
- One of the error codes from SDMMC host controller

*esp\_err\_t* **sdmmc\_io\_read\_bytes** (sdmmc\_card\_t \*card, uint32\_t function, uint32\_t addr, void \*dst, size\_t size)

Read multiple bytes from an SDIO card using IO\_RW\_EXTENDED (CMD53)

This function performs read operation using CMD53 in byte mode. For block mode, see `sdmmc_io_read_blocks`.

By default OP Code is set (incrementing address). To send CMD53 without this bit, OR the argument `addr` with `SDMMC_IO_FIXED_ADDR`.

#### 参数

- **card** -- pointer to card information structure previously initialized using `sdmmc_card_init`
- **function** -- IO function number
- **addr** -- byte address within IO function where reading starts
- **dst** -- buffer which receives the data read from card. Aligned to 4 byte boundary unless `SDMMC_HOST_FLAG_ALLOC_ALIGNED_BUF` flag is set when calling `sdmmc_card_init`. The flag is mandatory when the buffer is behind the cache.
- **size** -- number of bytes to read, 1 to 512.

#### 返回

- ESP\_OK on success
- ESP\_ERR\_INVALID\_SIZE if size exceeds 512 bytes
- One of the error codes from SDMMC host controller

*esp\_err\_t* **sdmmc\_io\_write\_bytes** (sdmmc\_card\_t \*card, uint32\_t function, uint32\_t addr, const void \*src, size\_t size)

Write multiple bytes to an SDIO card using IO\_RW\_EXTENDED (CMD53)

This function performs write operation using CMD53 in byte mode. For block mode, see `sdmmc_io_write_blocks`.

By default OP Code is set (incrementing address). To send CMD53 without this bit, OR the argument `addr` with `SDMMC_IO_FIXED_ADDR`.

#### 参数

- **card** -- pointer to card information structure previously initialized using `sdmmc_card_init`
- **function** -- IO function number
- **addr** -- byte address within IO function where writing starts
- **src** -- data to be written. Aligned to 4 byte boundary unless `SDMMC_HOST_FLAG_ALLOC_ALIGNED_BUF` flag is set when calling `sdmmc_card_init`. The flag is mandatory when the buffer is behind the cache.
- **size** -- number of bytes to write, 1 to 512.

#### 返回

- ESP\_OK on success
- ESP\_ERR\_INVALID\_SIZE if size exceeds 512 bytes
- One of the error codes from SDMMC host controller

*esp\_err\_t* **sdmmc\_io\_read\_blocks** (sdmmc\_card\_t \*card, uint32\_t function, uint32\_t addr, void \*dst, size\_t size)

Read blocks of data from an SDIO card using IO\_RW\_EXTENDED (CMD53)

This function performs read operation using CMD53 in block mode. For byte mode, see `sdmmc_io_read_bytes`.

By default OP Code is set (incrementing address). To send CMD53 without this bit, OR the argument `addr` with `SDMMC_IO_FIXED_ADDR`.

#### 参数

- **card** -- pointer to card information structure previously initialized using `sdmmc_card_init`
- **function** -- IO function number
- **addr** -- byte address within IO function where writing starts
- **dst** -- buffer which receives the data read from card. Aligned to 4 byte boundary, and also cache line size if the buffer is behind the cache.
- **size** -- number of bytes to read, must be divisible by the card block size.

#### 返回

- `ESP_OK` on success
- `ESP_ERR_INVALID_SIZE` if size is not divisible by 512 bytes
- One of the error codes from SDMMC host controller

*esp\_err\_t* `sdmmc_io_write_blocks` (`sdmmc_card_t *card`, `uint32_t function`, `uint32_t addr`, `const void *src`, `size_t size`)

Write blocks of data to an SDIO card using `IO_RW_EXTENDED` (CMD53)

This function performs write operation using CMD53 in block mode. For byte mode, see `sdmmc_io_write_bytes`.

By default OP Code is set (incrementing address). To send CMD53 without this bit, OR the argument `addr` with `SDMMC_IO_FIXED_ADDR`.

#### 参数

- **card** -- pointer to card information structure previously initialized using `sdmmc_card_init`
- **function** -- IO function number
- **addr** -- byte address within IO function where writing starts
- **src** -- data to be written. Aligned to 4 byte boundary, and also cache line size if the buffer is behind the cache.
- **size** -- number of bytes to read, must be divisible by the card block size.

#### 返回

- `ESP_OK` on success
- `ESP_ERR_INVALID_SIZE` if size is not divisible by 512 bytes
- One of the error codes from SDMMC host controller

*esp\_err\_t* `sdmmc_io_enable_int` (`sdmmc_card_t *card`)

Enable SDIO interrupt in the SDMMC host

**参数** `card` -- pointer to card information structure previously initialized using `sdmmc_card_init`

#### 返回

- `ESP_OK` on success
- `ESP_ERR_NOT_SUPPORTED` if the host controller does not support IO interrupts

*esp\_err\_t* `sdmmc_io_wait_int` (`sdmmc_card_t *card`, `TickType_t timeout_ticks`)

Block until an SDIO interrupt is received

Slave uses D1 line to signal interrupt condition to the host. This function can be used to wait for the interrupt.

#### 参数

- **card** -- pointer to card information structure previously initialized using `sdmmc_card_init`
- **timeout\_ticks** -- time to wait for the interrupt, in RTOS ticks

#### 返回

- `ESP_OK` if the interrupt is received
- `ESP_ERR_NOT_SUPPORTED` if the host controller does not support IO interrupts
- `ESP_ERR_TIMEOUT` if the interrupt does not happen in `timeout_ticks`

*esp\_err\_t* **sdmmc\_io\_get\_cis\_data** (sdmmc\_card\_t \*card, uint8\_t \*out\_buffer, size\_t buffer\_size, size\_t \*inout\_cis\_size)

Get the data of CIS region of an SDIO card.

You may provide a buffer not sufficient to store all the CIS data. In this case, this function stores as much data into your buffer as possible. Also, this function will try to get and return the size required for you.

#### 参数

- **card** -- pointer to card information structure previously initialized using `sdmmc_card_init`
- **out\_buffer** -- Output buffer of the CIS data
- **buffer\_size** -- Size of the buffer.
- **inout\_cis\_size** -- Mandatory, pointer to a size, input and output.
  - input: Limitation of maximum searching range, should be 0 or larger than `buffer_size`. The function searches for `CIS_CODE_END` until this range. Set to 0 to search infinitely.
  - output: The size required to store all the CIS data, if `CIS_CODE_END` is found.

#### 返回

- `ESP_OK`: on success
- `ESP_ERR_INVALID_RESPONSE`: if the card does not (correctly) support CIS.
- `ESP_ERR_INVALID_SIZE`: `CIS_CODE_END` found, but `buffer_size` is less than required size, which is stored in the `inout_cis_size` then.
- `ESP_ERR_NOT_FOUND`: if the `CIS_CODE_END` not found. Increase input value of `inout_cis_size` or set it to 0, if you still want to search for the end; output value of `inout_cis_size` is invalid in this case.
- and other error code return from `sdmmc_io_read_bytes`

*esp\_err\_t* **sdmmc\_io\_print\_cis\_info** (uint8\_t \*buffer, size\_t buffer\_size, FILE \*fp)

Parse and print the CIS information of an SDIO card.

**备注:** Not all the CIS codes and all kinds of tuples are supported. If you see some unresolved code, you can add the parsing of these code in `sdmmc_io.c` and contribute to the IDF through the Github repository.

```
using sdmmc_card_init
```

#### 参数

- **buffer** -- Buffer to parse
- **buffer\_size** -- Size of the buffer.
- **fp** -- File pointer to print to, set to NULL to print to stdout.

#### 返回

- `ESP_OK`: on success
- `ESP_ERR_NOT_SUPPORTED`: if the value from the card is not supported to be parsed.
- `ESP_ERR_INVALID_SIZE`: if the CIS size fields are not correct.

## Macros

### SDMMC\_IO\_FIXED\_ADDR

Call `sdmmc_io_read_bytes`, `sdmmc_io_write_bytes`, `sdmmc_io_read_blocks` or `sdmmc_io_write_bocks` APIs with address ORed by this flag to send CMD53 with OP Code clear (fixed address)

## Header File

- `components/esp_driver_sdmmc/include/driver/sdmmc_types.h`
- This header file can be included with:

```
#include "driver/sdmmc_types.h"
```

- This header file is a part of the API provided by the `esp_driver_sdmmc` component. To declare that your component depends on `esp_driver_sdmmc`, add the following to your `CMakeLists.txt`:

```
REQUIRES esp_driver_sdmmc
```

or

```
PRIV_REQUIRES esp_driver_sdmmc
```

## 2.9.8 分区 API

### 概述

`esp_partition` 组件提供了高层次的 API 函数，用于访问定义在分区表中的分区。这些 API 基于 *SPI flash API* 提供的低层次 API。

### 分区表 API

ESP-IDF 工程使用分区表保存 SPI flash 各区信息，包括引导程序、各种应用程序二进制文件、数据及文件系统等。请参阅分区表，查看详细信息。

该组件在 `esp_partition.h` 中声明了一些 API 函数，用以枚举在分区表中找到的分区，并对这些分区执行操作：

- `esp_partition_find()`：在分区表中查找特定类型的条目，返回一个不透明迭代器；
- `esp_partition_get()`：返回一个结构体，描述给定迭代器的分区；
- `esp_partition_next()`：将迭代器移至下一个找到的分区；
- `esp_partition_iterator_release()`：释放 `esp_partition_find()` 中返回的迭代器；
- `esp_partition_find_first()`：返回描述 `esp_partition_find()` 中找到的第一个分区的结构；
- `esp_partition_read()`、`esp_partition_write()` 和 `esp_partition_erase_range()` 等同于 `esp_flash_read()`、`esp_flash_write()` 和 `esp_flash_erase_region()`，但在分区边界内执行。

### 另请参考

- 分区表
- 空中升级 (OTA) 提供了高层 API 用于更新存储在 flash 中的 app 固件。
- 非易失性存储库 提供了结构化 API 用于存储 SPI flash 中的碎片数据。

### 分区表 API 参考

#### Header File

- `components/esp_partition/include/esp_partition.h`
- This header file can be included with:

```
#include "esp_partition.h"
```

- This header file is a part of the API provided by the `esp_partition` component. To declare that your component depends on `esp_partition`, add the following to your `CMakeLists.txt`:

```
REQUIRES esp_partition
```

or

```
PRIV_REQUIRES esp_partition
```

## Functions

*esp\_partition\_iterator\_t* **esp\_partition\_find** (*esp\_partition\_type\_t* type, *esp\_partition\_subtype\_t* subtype, const char \*label)

Find partition based on one or more parameters.

### 参数

- **type** -- Partition type, one of *esp\_partition\_type\_t* values or an 8-bit unsigned integer. To find all partitions, no matter the type, use `ESP_PARTITION_TYPE_ANY`, and set subtype argument to `ESP_PARTITION_SUBTYPE_ANY`.
- **subtype** -- Partition subtype, one of *esp\_partition\_subtype\_t* values or an 8-bit unsigned integer. To find all partitions of given type, use `ESP_PARTITION_SUBTYPE_ANY`.
- **label** -- (optional) Partition label. Set this value if looking for partition with a specific name. Pass `NULL` otherwise.

**返回** iterator which can be used to enumerate all the partitions found, or `NULL` if no partitions were found. Iterator obtained through this function has to be released using `esp_partition_iterator_release` when not used any more.

const *esp\_partition\_t* \***esp\_partition\_find\_first** (*esp\_partition\_type\_t* type, *esp\_partition\_subtype\_t* subtype, const char \*label)

Find first partition based on one or more parameters.

### 参数

- **type** -- Partition type, one of *esp\_partition\_type\_t* values or an 8-bit unsigned integer. To find all partitions, no matter the type, use `ESP_PARTITION_TYPE_ANY`, and set subtype argument to `ESP_PARTITION_SUBTYPE_ANY`.
- **subtype** -- Partition subtype, one of *esp\_partition\_subtype\_t* values or an 8-bit unsigned integer. To find all partitions of given type, use `ESP_PARTITION_SUBTYPE_ANY`.
- **label** -- (optional) Partition label. Set this value if looking for partition with a specific name. Pass `NULL` otherwise.

**返回** pointer to *esp\_partition\_t* structure, or `NULL` if no partition is found. This pointer is valid for the lifetime of the application.

const *esp\_partition\_t* \***esp\_partition\_get** (*esp\_partition\_iterator\_t* iterator)

Get *esp\_partition\_t* structure for given partition.

**参数** **iterator** -- Iterator obtained using `esp_partition_find`. Must be non-`NULL`.

**返回** pointer to *esp\_partition\_t* structure. This pointer is valid for the lifetime of the application.

*esp\_partition\_iterator\_t* **esp\_partition\_next** (*esp\_partition\_iterator\_t* iterator)

Move partition iterator to the next partition found.

Any copies of the iterator will be invalid after this call.

**参数** **iterator** -- Iterator obtained using `esp_partition_find`. Must be non-`NULL`.

**返回** `NULL` if no partition was found, valid *esp\_partition\_iterator\_t* otherwise.

void **esp\_partition\_iterator\_release** (*esp\_partition\_iterator\_t* iterator)

Release partition iterator.

**参数** **iterator** -- Iterator obtained using `esp_partition_find`. The iterator is allowed to be `NULL`, so it is not necessary to check its value before calling this function.

const *esp\_partition\_t* \***esp\_partition\_verify** (const *esp\_partition\_t* \*partition)

Verify partition data.

Given a pointer to partition data, verify this partition exists in the partition table (all fields match.)



This function is also useful to take partition data which may be in a RAM buffer and convert it to a pointer to the permanent partition data stored in flash.

Pointers returned from this function can be compared directly to the address of any pointer returned from *esp\_partition\_get()*, as a test for equality.

**参数** **partition** -- Pointer to partition data to verify. Must be non-NULL. All fields of this structure must match the partition table entry in flash for this function to return a successful match.

**返回**

- If partition not found, returns NULL.
- If found, returns a pointer to the *esp\_partition\_t* structure in flash. This pointer is always valid for the lifetime of the application.

*esp\_err\_t* **esp\_partition\_read** (const *esp\_partition\_t* \*partition, size\_t src\_offset, void \*dst, size\_t size)

Read data from the partition.

Partitions marked with an encryption flag will automatically be read and decrypted via a cache mapping.

**参数**

- **partition** -- Pointer to partition structure obtained using *esp\_partition\_find\_first* or *esp\_partition\_get*. Must be non-NULL.
- **dst** -- Pointer to the buffer where data should be stored. Pointer must be non-NULL and buffer must be at least 'size' bytes long.
- **src\_offset** -- Address of the data to be read, relative to the beginning of the partition.
- **size** -- Size of data to be read, in bytes.

**返回** ESP\_OK, if data was read successfully; ESP\_ERR\_INVALID\_ARG, if src\_offset exceeds partition size; ESP\_ERR\_INVALID\_SIZE, if read would go out of bounds of the partition; or one of error codes from lower-level flash driver.

*esp\_err\_t* **esp\_partition\_write** (const *esp\_partition\_t* \*partition, size\_t dst\_offset, const void \*src, size\_t size)

Write data to the partition.

Before writing data to flash, corresponding region of flash needs to be erased. This can be done using *esp\_partition\_erase\_range* function.

Partitions marked with an encryption flag will automatically be written via the *esp\_flash\_write\_encrypted()* function. If writing to an encrypted partition, all write offsets and lengths must be multiples of 16 bytes. See the *esp\_flash\_write\_encrypted()* function for more details. Unencrypted partitions do not have this restriction.

---

**备注:** Prior to writing to flash memory, make sure it has been erased with *esp\_partition\_erase\_range* call.

---

**参数**

- **partition** -- Pointer to partition structure obtained using *esp\_partition\_find\_first* or *esp\_partition\_get*. Must be non-NULL.
- **dst\_offset** -- Address where the data should be written, relative to the beginning of the partition.
- **src** -- Pointer to the source buffer. Pointer must be non-NULL and buffer must be at least 'size' bytes long.
- **size** -- Size of data to be written, in bytes.

**返回** ESP\_OK, if data was written successfully; ESP\_ERR\_INVALID\_ARG, if dst\_offset exceeds partition size; ESP\_ERR\_INVALID\_SIZE, if write would go out of bounds of the partition; ESP\_ERR\_NOT\_ALLOWED, if partition is read-only; or one of error codes from lower-level flash driver.

*esp\_err\_t* **esp\_partition\_read\_raw** (const *esp\_partition\_t* \*partition, size\_t src\_offset, void \*dst, size\_t size)

Read data from the partition without any transformation/decryption.



---

**备注:** This function is essentially the same as `esp_partition_read()` above. It just never decrypts data but returns it as is.

---

#### 参数

- **partition** -- Pointer to partition structure obtained using `esp_partition_find_first` or `esp_partition_get`. Must be non-NULL.
- **dst** -- Pointer to the buffer where data should be stored. Pointer must be non-NULL and buffer must be at least 'size' bytes long.
- **src\_offset** -- Address of the data to be read, relative to the beginning of the partition.
- **size** -- Size of data to be read, in bytes.

**返回** ESP\_OK, if data was read successfully; ESP\_ERR\_INVALID\_ARG, if `src_offset` exceeds partition size; ESP\_ERR\_INVALID\_SIZE, if read would go out of bounds of the partition; or one of error codes from lower-level flash driver.

*esp\_err\_t* **esp\_partition\_write\_raw** (const *esp\_partition\_t* \*partition, size\_t dst\_offset, const void \*src, size\_t size)

Write data to the partition without any transformation/encryption.

Before writing data to flash, corresponding region of flash needs to be erased. This can be done using `esp_partition_erase_range` function.

---

**备注:** This function is essentially the same as `esp_partition_write()` above. It just never encrypts data but writes it as is.

---

---

**备注:** Prior to writing to flash memory, make sure it has been erased with `esp_partition_erase_range` call.

---

#### 参数

- **partition** -- Pointer to partition structure obtained using `esp_partition_find_first` or `esp_partition_get`. Must be non-NULL.
- **dst\_offset** -- Address where the data should be written, relative to the beginning of the partition.
- **src** -- Pointer to the source buffer. Pointer must be non-NULL and buffer must be at least 'size' bytes long.
- **size** -- Size of data to be written, in bytes.

**返回** ESP\_OK, if data was written successfully; ESP\_ERR\_INVALID\_ARG, if `dst_offset` exceeds partition size; ESP\_ERR\_INVALID\_SIZE, if write would go out of bounds of the partition; ESP\_ERR\_NOT\_ALLOWED, if partition is read-only; or one of the error codes from lower-level flash driver.

*esp\_err\_t* **esp\_partition\_erase\_range** (const *esp\_partition\_t* \*partition, size\_t offset, size\_t size)

Erase part of the partition.

#### 参数

- **partition** -- Pointer to partition structure obtained using `esp_partition_find_first` or `esp_partition_get`. Must be non-NULL.
- **offset** -- Offset from the beginning of partition where erase operation should start. Must be aligned to `partition->erase_size`.
- **size** -- Size of the range which should be erased, in bytes. Must be divisible by `partition->erase_size`.

**返回** ESP\_OK, if the range was erased successfully; ESP\_ERR\_INVALID\_ARG, if iterator or `dst` are NULL; ESP\_ERR\_INVALID\_SIZE, if erase would go out of bounds of the partition;

ESP\_ERR\_NOT\_ALLOWED, if partition is read-only; or one of error codes from lower-level flash driver.

```
esp_err_t esp_partition_mmap (const esp_partition_t *partition, size_t offset, size_t size,
                               esp_partition_mmap_memory_t memory, const void **out_ptr,
                               esp_partition_mmap_handle_t *out_handle)
```

Configure MMU to map partition into data memory.

Unlike `spi_flash_mmap` function, which requires a 64kB aligned base address, this function doesn't impose such a requirement. If offset results in a flash address which is not aligned to 64kB boundary, address will be rounded to the lower 64kB boundary, so that mapped region includes requested range. Pointer returned via `out_ptr` argument will be adjusted to point to the requested offset (not necessarily to the beginning of mmap-ed region).

To release mapped memory, pass handle returned via `out_handle` argument to `esp_partition_munmap` function.

#### 参数

- **partition** -- Pointer to partition structure obtained using `esp_partition_find_first` or `esp_partition_get`. Must be non-NULL.
- **offset** -- Offset from the beginning of partition where mapping should start.
- **size** -- Size of the area to be mapped.
- **memory** -- Memory space where the region should be mapped
- **out\_ptr** -- Output, pointer to the mapped memory region
- **out\_handle** -- Output, handle which should be used for `esp_partition_munmap` call

返回 ESP\_OK, if successful

```
void esp_partition_munmap (esp_partition_mmap_handle_t handle)
```

Release region previously obtained using `esp_partition_mmap`.

---

**备注:** Calling this function will not necessarily unmap memory region. Region will only be unmapped when there are no other handles which reference this region. In case of partially overlapping regions it is possible that memory will be unmapped partially.

---

参数 **handle** -- Handle obtained from `spi_flash_mmap`

```
esp_err_t esp_partition_get_sha256 (const esp_partition_t *partition, uint8_t *sha_256)
```

Get SHA-256 digest for required partition.

For apps with SHA-256 appended to the app image, the result is the appended SHA-256 value for the app image content. The hash is verified before returning, if app content is invalid then the function returns `ESP_ERR_IMAGE_INVALID`. For apps without SHA-256 appended to the image, the result is the SHA-256 of all bytes in the app image. For other partition types, the result is the SHA-256 of the entire partition.

#### 参数

- **partition** -- **[in]** Pointer to info for partition containing app or data. (fields: address, size and type, are required to be filled).
- **sha\_256** -- **[out]** Returned SHA-256 digest for a given partition.

#### 返回

- ESP\_OK: In case of successful operation.
- ESP\_ERR\_INVALID\_ARG: The size was 0 or the sha\_256 was NULL.
- ESP\_ERR\_NO\_MEM: Cannot allocate memory for sha256 operation.
- ESP\_ERR\_IMAGE\_INVALID: App partition doesn't contain a valid app image.
- ESP\_FAIL: An allocation error occurred.

```
bool esp_partition_check_identity (const esp_partition_t *partition_1, const esp_partition_t
                                     *partition_2)
```

Check for the identity of two partitions by SHA-256 digest.

#### 参数

- **partition\_1** -- [in] Pointer to info for partition 1 containing app or data. (fields: address, size and type, are required to be filled).
- **partition\_2** -- [in] Pointer to info for partition 2 containing app or data. (fields: address, size and type, are required to be filled).

#### 返回

- True: In case of the two firmware is equal.
- False: Otherwise

*esp\_err\_t* **esp\_partition\_register\_external** (*esp\_flash\_t* \*flash\_chip, size\_t offset, size\_t size, const char \*label, *esp\_partition\_type\_t* type, *esp\_partition\_subtype\_t* subtype, const *esp\_partition\_t* \*\*out\_partition)

Register a partition on an external flash chip.

This API allows designating certain areas of external flash chips (identified by the *esp\_flash\_t* structure) as partitions. This allows using them with components which access SPI flash through the *esp\_partition* API.

#### 参数

- **flash\_chip** -- Pointer to the structure identifying the flash chip
- **offset** -- Address in bytes, where the partition starts
- **size** -- Size of the partition in bytes
- **label** -- Partition name
- **type** -- One of the partition types (ESP\_PARTITION\_TYPE\_\*), or an integer. Note that applications can not be booted from external flash chips, so using ESP\_PARTITION\_TYPE\_APP is not supported.
- **subtype** -- One of the partition subtypes (ESP\_PARTITION\_SUBTYPE\_\*), or an integer.
- **out\_partition** -- [out] Output, if non-NULL, receives the pointer to the resulting *esp\_partition\_t* structure

#### 返回

- ESP\_OK on success
- ESP\_ERR\_NO\_MEM if memory allocation has failed
- ESP\_ERR\_INVALID\_ARG if the new partition overlaps another partition on the same flash chip
- ESP\_ERR\_INVALID\_SIZE if the partition doesn't fit into the flash chip size

*esp\_err\_t* **esp\_partition\_deregister\_external** (const *esp\_partition\_t* \*partition)

Deregister the partition previously registered using *esp\_partition\_register\_external*.

**参数** **partition** -- pointer to the partition structure obtained from *esp\_partition\_register\_external*,

#### 返回

- ESP\_OK on success
- ESP\_ERR\_NOT\_FOUND if the partition pointer is not found
- ESP\_ERR\_INVALID\_ARG if the partition comes from the partition table
- ESP\_ERR\_INVALID\_ARG if the partition was not registered using *esp\_partition\_register\_external* function.

void **esp\_partition\_unload\_all** (void)

Unload partitions and free space allocated by them.

## Structures

struct **esp\_partition\_t**

partition information structure

This is not the format in flash, that format is *esp\_partition\_info\_t*.

However, this is the format used by this API.

## Public Members

*esp\_flash\_t* \***flash\_chip**

SPI flash chip on which the partition resides

*esp\_partition\_type\_t* **type**

partition type (app/data)

*esp\_partition\_subtype\_t* **subtype**

partition subtype

uint32\_t **address**

starting address of the partition in flash

uint32\_t **size**

size of the partition, in bytes

uint32\_t **erase\_size**

size the erase operation should be aligned to

char **label**[17]

partition label, zero-terminated ASCII string

bool **encrypted**

flag is set to true if partition is encrypted

bool **readonly**

flag is set to true if partition is read-only

## Macros

**ESP\_PARTITION\_SUBTYPE\_OTA** (i)

Convenience macro to get *esp\_partition\_subtype\_t* value for the i-th OTA partition.

## Type Definitions

typedef uint32\_t **esp\_partition\_mmap\_handle\_t**

Opaque handle for memory region obtained from *esp\_partition\_mmap*.

typedef struct *esp\_partition\_iterator\_opaque\_* \***esp\_partition\_iterator\_t**

Opaque partition iterator type.

## Enumerations

enum **esp\_partition\_mmap\_memory\_t**

Enumeration which specifies memory space requested in an *mmap* call.

*Values:*

enumerator **ESP\_PARTITION\_MMAP\_DATA**

map to data memory (Vaddr0), allows byte-aligned access, 4 MB total

enumerator **ESP\_PARTITION\_MMAP\_INST**

map to instruction memory (Vaddr1-3), allows only 4-byte-aligned access, 11 MB total

enum **esp\_partition\_type\_t**

Partition type.

---

**备注:** Partition types with integer value 0x00-0x3F are reserved for partition types defined by ESP-IDF. Any other integer value 0x40-0xFE can be used by individual applications, without restriction.

---

*Values:*

enumerator **ESP\_PARTITION\_TYPE\_APP**

Application partition type.

enumerator **ESP\_PARTITION\_TYPE\_DATA**

Data partition type.

enumerator **ESP\_PARTITION\_TYPE\_ANY**

Used to search for partitions with any type.

enum **esp\_partition\_subtype\_t**

Partition subtype.

Application-defined partition types (0x40-0xFE) can set any numeric subtype value.

---

**备注:** These ESP-IDF-defined partition subtypes apply to partitions of type **ESP\_PARTITION\_TYPE\_APP** and **ESP\_PARTITION\_TYPE\_DATA**.

---

*Values:*

enumerator **ESP\_PARTITION\_SUBTYPE\_APP\_FACTORY**

Factory application partition.

enumerator **ESP\_PARTITION\_SUBTYPE\_APP\_OTA\_MIN**

Base for OTA partition subtypes.

enumerator **ESP\_PARTITION\_SUBTYPE\_APP\_OTA\_0**

OTA partition 0.

enumerator **ESP\_PARTITION\_SUBTYPE\_APP\_OTA\_1**

OTA partition 1.

enumerator **ESP\_PARTITION\_SUBTYPE\_APP\_OTA\_2**

OTA partition 2.

enumerator **ESP\_PARTITION\_SUBTYPE\_APP\_OTA\_3**

OTA partition 3.

- enumerator **ESP\_PARTITION\_SUBTYPE\_APP\_OTA\_4**  
OTA partition 4.
- enumerator **ESP\_PARTITION\_SUBTYPE\_APP\_OTA\_5**  
OTA partition 5.
- enumerator **ESP\_PARTITION\_SUBTYPE\_APP\_OTA\_6**  
OTA partition 6.
- enumerator **ESP\_PARTITION\_SUBTYPE\_APP\_OTA\_7**  
OTA partition 7.
- enumerator **ESP\_PARTITION\_SUBTYPE\_APP\_OTA\_8**  
OTA partition 8.
- enumerator **ESP\_PARTITION\_SUBTYPE\_APP\_OTA\_9**  
OTA partition 9.
- enumerator **ESP\_PARTITION\_SUBTYPE\_APP\_OTA\_10**  
OTA partition 10.
- enumerator **ESP\_PARTITION\_SUBTYPE\_APP\_OTA\_11**  
OTA partition 11.
- enumerator **ESP\_PARTITION\_SUBTYPE\_APP\_OTA\_12**  
OTA partition 12.
- enumerator **ESP\_PARTITION\_SUBTYPE\_APP\_OTA\_13**  
OTA partition 13.
- enumerator **ESP\_PARTITION\_SUBTYPE\_APP\_OTA\_14**  
OTA partition 14.
- enumerator **ESP\_PARTITION\_SUBTYPE\_APP\_OTA\_15**  
OTA partition 15.
- enumerator **ESP\_PARTITION\_SUBTYPE\_APP\_OTA\_MAX**  
Max subtype of OTA partition.
- enumerator **ESP\_PARTITION\_SUBTYPE\_APP\_TEST**  
Test application partition.
- enumerator **ESP\_PARTITION\_SUBTYPE\_DATA\_OTA**  
OTA selection partition.
- enumerator **ESP\_PARTITION\_SUBTYPE\_DATA\_PHY**  
PHY init data partition.

enumerator **ESP\_PARTITION\_SUBTYPE\_DATA\_NVS**

NVS partition.

enumerator **ESP\_PARTITION\_SUBTYPE\_DATA\_COREDUMP**

COREDUMP partition.

enumerator **ESP\_PARTITION\_SUBTYPE\_DATA\_NVS\_KEYS**

Partition for NVS keys.

enumerator **ESP\_PARTITION\_SUBTYPE\_DATA\_EFUSE\_EM**

Partition for emulate eFuse bits.

enumerator **ESP\_PARTITION\_SUBTYPE\_DATA\_UNDEFINED**

Undefined (or unspecified) data partition.

enumerator **ESP\_PARTITION\_SUBTYPE\_DATA\_ESPHTTPD**

ESPHTTPD partition.

enumerator **ESP\_PARTITION\_SUBTYPE\_DATA\_FAT**

FAT partition.

enumerator **ESP\_PARTITION\_SUBTYPE\_DATA\_SPIFFS**

SPIFFS partition.

enumerator **ESP\_PARTITION\_SUBTYPE\_DATA\_LITTLEFS**

LITTLEFS partition.

enumerator **ESP\_PARTITION\_SUBTYPE\_ANY**

Used to search for partitions with any subtype.

## 2.9.9 SPIFFS 文件系统

### 概述

SPIFFS 是一个用于 SPI NOR flash 设备的嵌入式文件系统，支持磨损均衡、文件系统一致性检查等功能。

### 说明

- 目前，SPIFFS 尚不支持目录，但可以生成扁平结构。如果 SPIFFS 挂载在 /spiffs 下，在 /spiffs/tmp/myfile.txt 路径下创建一个文件则会在 SPIFFS 中生成一个名为 /tmp/myfile.txt 的文件，而不是在 /spiffs/tmp 下生成名为 myfile.txt 的文件；
- SPIFFS 并非实时栈，每次写操作耗时不等；
- 目前，SPIFFS 尚不支持检测或处理已损坏的块。
- SPIFFS 只能稳定地使用约 75% 的指定分区容量。
- 当文件系统空间不足时，垃圾收集器会尝试多次扫描文件系统来寻找可用空间。根据所需空间的不同，写操作会被调用多次，每次函数调用将花费几秒。同一操作可能会花费不同时长的问题缘于 SPIFFS 的设计，且已在官方的 [SPIFFS github 仓库](https://github.com/EspressifSystem/SPIFFS) 或是 <https://github.com/espressif/esp-idf/issues/1737> 中被多次报告。这个问题可以通过 [SPIFFS 配置](#) 部分缓解。

- 当垃圾收集器尝试多次（默认为 10 次）扫描整个文件系统以回收空间时，在每次扫描期间，如果有可用的数据块，则垃圾收集器会释放一个数据块。因此，如果为垃圾收集器设置的最大运行次数为  $n$ （可通过 `SPIFFS_GC_MAX_RUNS` 选项配置，该选项位于 [SPIFFS 配置](#) 中），那么  $n$  倍数据块大小的空间将可用于写入数据。如果尝试写入超过  $n$  倍数据块大小的数据，写入操作可能会失败并返回错误。
- 如果 ESP32-H2 在文件系统操作期间断电，可能会导致 SPIFFS 损坏。但是仍可通过 `esp_spiffs_check` 函数恢复文件系统。详情请参阅官方 [SPIFFS FAQ](#)。

## 工具

`spiffsgen.py` `spiffsgen.py`（只写）是 SPIFFS 的一种 Python 实现，可用于从主机文件夹内容生成文件系统镜像。打开终端并运行以下命令即可使用 `spiffsgen.py`：

```
python spiffsgen.py <image_size> <base_dir> <output_file>
```

参数（必选）说明如下：

- **image\_size**：分区大小，用于烧录生成的 SPIFFS 镜像；
- **base\_dir**：创建 SPIFFS 镜像的目录；
- **output\_file**：SPIFFS 镜像输出文件。

其他参数（可选）也参与控制镜像的生成，用户可以运行以下帮助命令，查看这些参数的具体信息：

```
python spiffsgen.py --help
```

上述可选参数对应 SPIFFS 构建配置选项。若想顺利生成可用的镜像，请确保使用的参数或配置与构建 SPIFFS 时所用的参数或配置相同。运行帮助命令将显示参数所对应的 SPIFFS 构建配置。如未指定参数，将使用帮助信息中的默认值。

镜像生成后，用户可以使用 `esptool.py` 或 `parttool.py` 烧录镜像。

用户可以在命令行或脚本中手动单独调用 `spiffsgen.py`，也可以直接从构建系统调用 `spiffs_create_partition_image` 来使用 `spiffsgen.py`：

```
spiffs_create_partition_image(<partition> <base_dir> [FLASH_IN_PROJECT] [DEPENDS_
↳dep dep dep...])
```

在构建系统中使用 `spiffsgen.py` 更为方便，构建配置会自动传递给 `spiffsgen.py` 工具，确保生成的镜像可用于构建。比如，单独调用 `spiffsgen.py` 时需要用到 **image\_size** 参数，但在构建系统中调用 `spiffs_create_partition_image` 时，仅需要 **partition** 参数，镜像大小将直接从工程分区表中获取。

使用 `spiffs_create_partition_image`，必须从组件 `CMakeLists.txt` 文件调用。

用户也可以指定 `FLASH_IN_PROJECT`，然后使用 `idf.py flash` 将镜像与应用程序二进制文件、分区表等一起自动烧录至设备，例如：

```
spiffs_create_partition_image(my_spiffs_partition my_folder FLASH_IN_PROJECT)
```

不指定 `FLASH_IN_PROJECT/SPIFFS_IMAGE_FLASH_IN_PROJECT` 也可以生成镜像，但须使用 `esptool.py`、`parttool.py` 或自定义构建系统目标手动烧录。

有时基本目录中的内容是在构建时生成的，用户可以使用 `DEPENDS/SPIFFS_IMAGE_DEPENDS` 指定目标，因此可以在生成镜像之前执行此目标：

```
add_custom_target(dep COMMAND ...)

spiffs_create_partition_image(my_spiffs_partition my_folder DEPENDS dep)
```

请参考 [storage/spiffsgen](#)，查看示例。



**mkspiiffs** 用户也可以使用 **mkspiiffs** 工具创建 SPIFFS 分区镜像。与 `spiiffsgen.py` 相似，**mkspiiffs** 也可以用于从指定文件夹中生成镜像，然后使用 `esptool.py` 烧录镜像。

该工具需要获取以下参数：

- **Block Size**: 4096 (SPI flash 标准)
- **Page Size**: 256 (SPI flash 标准)
- **Image Size**: 分区大小 (以字节为单位, 可从分区表中获取)
- **Partition Offset**: 分区起始地址 (可从分区表中获取)

运行以下命令，将文件夹打包成 1 MB 大小的镜像：

```
mkspiiffs -c [src_folder] -b 4096 -p 256 -s 0x100000 spiiffs.bin
```

运行以下命令，将镜像烧录到 ESP32-H2 (偏移量: 0x110000)：

```
python esptool.py --chip esp32h2 --port [port] --baud [baud] write_flash -z_
↳0x110000 spiiffs.bin
```

**选择合适的 SPIFFS 工具** 上面介绍的两款 SPIFFS 工具功能相似，需根据实际情况，选择合适的一款。

以下情况优先选用 `spiiffsgen.py` 工具：

1. 仅需在构建时简单生成 SPIFFS 镜像，请选择使用 `spiiffsgen.py`，因为 `spiiffsgen.py` 可以直接在构建系统中使用函数或命令生成 SPIFFS 镜像。
2. 主机没有可用的 C/C++ 编译器时，可以选择使用 `spiiffsgen.py` 工具，因为 `spiiffsgen.py` 不需要编译。

以下情况优先选用 `mkspiiffs` 工具：

1. 如果用户除了需要生成镜像外，还需要拆包 SPIFFS 镜像，请选择使用 `mkspiiffs` 工具，因为 `spiiffsgen.py` 目前尚不支持此功能。
2. 如果用户当前环境中 Python 解释器不可用，但主机编译器可用，或者有预编译的 `mkspiiffs` 二进制文件，此时请选择使用 `mkspiiffs` 工具。但是，`mkspiiffs` 没有集成到构建系统，用户必须自己完成以下工作：在构建期间编译 `mkspiiffs` (如果未使用预编译的二进制文件)，为输出文件创建构建规则或目标，将适当的参数传递给工具等。

## 另请参阅

- [分区表](#)

## 应用示例

`storage/spiiffs` 目录下提供了 SPIFFS 应用示例。该示例初始化并挂载了一个 SPIFFS 分区，然后使用 POSIX 和 C 库 API 写入和读取数据。请参考 `example` 目录下的 `README.md` 文件，获取详细信息。

## 高级 API 参考

### Header File

- `components/spiiffs/include/esp_spiiffs.h`
- This header file can be included with:

```
#include "esp_spiiffs.h"
```

- This header file is a part of the API provided by the `spiiffs` component. To declare that your component depends on `spiiffs`, add the following to your `CMakeLists.txt`:

```
REQUIRES spiiffs
```

or

```
PRIV_REQUIRES spiiffs
```

## Functions

*esp\_err\_t* **esp\_vfs\_spiffs\_register** (const *esp\_vfs\_spiffs\_conf\_t* \*conf)

Register and mount SPIFFS to VFS with given path prefix.

**参数** *conf* -- Pointer to *esp\_vfs\_spiffs\_conf\_t* configuration structure

**返回**

- ESP\_OK if success
- ESP\_ERR\_NO\_MEM if objects could not be allocated
- ESP\_ERR\_INVALID\_STATE if already mounted or partition is encrypted
- ESP\_ERR\_NOT\_FOUND if partition for SPIFFS was not found
- ESP\_FAIL if mount or format fails

*esp\_err\_t* **esp\_vfs\_spiffs\_unregister** (const char \*partition\_label)

Unregister and unmount SPIFFS from VFS

**参数** *partition\_label* -- Same label as passed to *esp\_vfs\_spiffs\_register*.

**返回**

- ESP\_OK if successful
- ESP\_ERR\_INVALID\_STATE already unregistered

bool **esp\_spiffs\_mounted** (const char \*partition\_label)

Check if SPIFFS is mounted

**参数** *partition\_label* -- Optional, label of the partition to check. If not specified, first partition with subtype=spiiffs is used.

**返回**

- true if mounted
- false if not mounted

*esp\_err\_t* **esp\_spiffs\_format** (const char \*partition\_label)

Format the SPIFFS partition

**参数** *partition\_label* -- Same label as passed to *esp\_vfs\_spiffs\_register*.

**返回**

- ESP\_OK if successful
- ESP\_FAIL on error

*esp\_err\_t* **esp\_spiffs\_info** (const char \*partition\_label, size\_t \*total\_bytes, size\_t \*used\_bytes)

Get information for SPIFFS

**参数**

- *partition\_label* -- Same label as passed to *esp\_vfs\_spiffs\_register*
- *total\_bytes* -- [out] Size of the file system
- *used\_bytes* -- [out] Current used bytes in the file system

**返回**

- ESP\_OK if success
- ESP\_ERR\_INVALID\_STATE if not mounted

*esp\_err\_t* **esp\_spiffs\_check** (const char \*partition\_label)

Check integrity of SPIFFS

**参数** *partition\_label* -- Same label as passed to *esp\_vfs\_spiffs\_register*

**返回**

- ESP\_OK if successful
- ESP\_ERR\_INVALID\_STATE if not mounted
- ESP\_FAIL on error

`esp_err_t esp_spiffs_gc` (const char \*partition\_label, size\_t size\_to\_gc)

Perform garbage collection in SPIFFS partition.

Call this function to run GC and ensure that at least the given amount of space is available in the partition. This function will fail with `ESP_ERR_NOT_FINISHED` if it is not possible to reclaim the requested space (that is, not enough free or deleted pages in the filesystem). This function will also fail if it fails to reclaim the requested space after `CONFIG_SPIFFS_GC_MAX_RUNS` number of GC iterations. On one GC iteration, SPIFFS will erase one logical block (4kB). Therefore the value of `CONFIG_SPIFFS_GC_MAX_RUNS` should be set at least to the maximum expected `size_to_gc`, divided by 4096. For example, if the application expects to make room for a 1MB file and calls `esp_spiffs_gc(label, 1024 * 1024)`, `CONFIG_SPIFFS_GC_MAX_RUNS` should be set to at least 256. On the other hand, increasing `CONFIG_SPIFFS_GC_MAX_RUNS` value increases the maximum amount of time for which any SPIFFS GC or write operation may potentially block.

#### 参数

- **partition\_label** -- Label of the partition to be garbage-collected. The partition must be already mounted.
- **size\_to\_gc** -- The number of bytes that the GC process should attempt to make available.

#### 返回

- `ESP_OK` on success
- `ESP_ERR_NOT_FINISHED` if GC fails to reclaim the size given by `size_to_gc`
- `ESP_ERR_INVALID_STATE` if the partition is not mounted
- `ESP_FAIL` on all other errors

## Structures

struct **esp\_vfs\_spiffs\_conf\_t**

Configuration structure for `esp_vfs_spiffs_register`.

### Public Members

const char \***base\_path**

File path prefix associated with the filesystem.

const char \***partition\_label**

Optional, label of SPIFFS partition to use. If set to `NULL`, first partition with subtype=`spiffs` will be used.

size\_t **max\_files**

Maximum files that could be open at the same time.

bool **format\_if\_mount\_failed**

If true, it will format the file system if it fails to mount.

## 2.9.10 虚拟文件系统组件

### 概述

虚拟文件系统 (VFS) 组件为驱动程序提供一个统一接口，可以操作类文件对象。这类驱动程序可以是 FAT、SPIFFS 等真实文件系统，也可以是提供文件类接口的设备驱动程序。

VFS 组件支持 C 库函数（如 `fopen` 和 `fprintf` 等）与文件系统 (FS) 驱动程序协同工作。在高层级，每个 FS 驱动程序均与某些路径前缀相关联。当一个 C 库函数需要打开文件时，VFS 组件将搜索与该文件所在文件路径相关联的 FS 驱动程序，并将调用传递给该驱动程序。针对该文件的读取、写入等其他操作的调用也将传递给这个驱动程序。

例如，使用 `/fat` 前缀注册 FAT 文件系统驱动，之后即可调用 `fopen("/fat/file.txt", "w")`。之后，VFS 将调用 FAT 驱动的 `open` 函数，并将参数 `/file.txt` 和合适的打开模式传递给 `open` 函数；后续对返回的 `FILE*` 数据流调用 C 库函数也同样会传递给 FAT 驱动。

## 注册 FS 驱动程序

如需注册 FS 驱动程序，应用程序首先要定义一个 `esp_vfs_t` 结构体实例，并用指向 FS API 的函数指针填充它。

```
esp_vfs_t myfs = {
    .flags = ESP_VFS_FLAG_DEFAULT,
    .write = &myfs_write,
    .open = &myfs_open,
    .fstat = &myfs_fstat,
    .close = &myfs_close,
    .read = &myfs_read,
};

ESP_ERROR_CHECK(esp_vfs_register("/data", &myfs, NULL));
```

在上述代码中需要用到 `read`、`write` 或 `read_p`、`write_p`，具体使用哪组函数由 FS 驱动程序 API 的声明方式决定。

示例 1：声明 API 函数时不带额外的上下文指针参数，即 FS 驱动程序为单例模式，此时使用 `write`

```
ssize_t myfs_write(int fd, const void * data, size_t size);

// In definition of esp_vfs_t:
    .flags = ESP_VFS_FLAG_DEFAULT,
    .write = &myfs_write,
// ... other members initialized

// When registering FS, context pointer (third argument) is NULL:
ESP_ERROR_CHECK(esp_vfs_register("/data", &myfs, NULL));
```

示例 2：声明 API 函数时需要一个额外的上下文指针作为参数，即可支持多个 FS 驱动程序实例，此时使用 `write_p`

```
ssize_t myfs_write(myfs_t* fs, int fd, const void * data, size_t size);

// In definition of esp_vfs_t:
    .flags = ESP_VFS_FLAG_CONTEXT_PTR,
    .write_p = &myfs_write,
// ... other members initialized

// When registering FS, pass the FS context pointer into the third argument
// (hypothetical myfs_mount function is used for illustrative purposes)
myfs_t* myfs_inst1 = myfs_mount(partition1->offset, partition1->size);
ESP_ERROR_CHECK(esp_vfs_register("/data1", &myfs, myfs_inst1));

// Can register another instance:
myfs_t* myfs_inst2 = myfs_mount(partition2->offset, partition2->size);
ESP_ERROR_CHECK(esp_vfs_register("/data2", &myfs, myfs_inst2));
```

**同步输入/输出多路复用** VFS 组件支持通过 `select()` 进行同步输入/输出多路复用，其实现方式如下：

1. 调用 `select()`，使用时提供的文件描述符可以属于不同的 VFS 驱动。
2. 文件描述符被分为几组，每组属于一个 VFS 驱动。
3. 非套接字 VFS 驱动的文件描述符由 `start_select()` 移交给指定的 VFS 驱动，后文会对此进行详述。该函数代表指定驱动 `select()` 的实现。这是一个非阻塞的调用，意味着在设置好检查与指定文件描述符相关事件的环境后，该函数应该立即返回。
4. 套接字 VFS 驱动的文件描述符由 `socket_select()` 移交给套接字 VFS 驱动，后文会对此进行详述。这是一个阻塞调用，意味着只有当有一个与套接字文件描述符相关的事件或非套接字驱动发出信号让 `socket_select()` 退出时，它才会返回。
5. 从各个 VFS 驱动程序收集结果，并通过对环境检查取消初始化来终止所有驱动程序。
6. `select()` 调用结束并返回适当的结果。

**非套接字 VFS 驱动** 如果要使用非套接字 VFS 驱动的文件描述符调用 `select()`，那么需要用函数 `start_select()` 和 `end_select()` 注册该驱动，具体如下：

```
// In definition of esp_vfs_t:
    .start_select = &uart_start_select,
    .end_select = &uart_end_select,
// ... other members initialized
```

调用 `start_select()` 函数可以设置环境，检测指定 VFS 驱动的文件描述符读取/写入/错误条件。

调用 `end_select()` 函数可以终止/取消初始化/释放由 `start_select()` 设置的环境。

**备注：** 在少数情况下，在调用 `end_select()` 之前可能并没有调用过 `start_select()`。因此 `end_select()` 的实现必须在该情况下返回错误而不能崩溃。

如需获取更多信息，请参考 [esp\\_driver\\_uart/src/uart\\_vfs.c](#) 中 UART 外设的 VFS 驱动，尤其是函数 `uart_vfs_dev_register()`、`uart_start_select()` 和 `uart_end_select()`。

请参考以下示例，查看如何使用 VFS 文件描述符调用 `select()`：

- [peripherals/uart/uart\\_select](#)
- [system/select](#)

**套接字 VFS 驱动** 套接字 VFS 驱动会使用自实现的 `socket_select()` 函数，在读取/写入/错误条件时，非套接字 VFS 驱动会通知该函数。

可通过定义以下函数注册套接字 VFS 驱动：

```
// In definition of esp_vfs_t:
    .socket_select = &lwip_select,
    .get_socket_select_semaphore = &lwip_get_socket_select_semaphore,
    .stop_socket_select = &lwip_stop_socket_select,
    .stop_socket_select_isr = &lwip_stop_socket_select_isr,
// ... other members initialized
```

函数 `socket_select()` 是套接字驱动对 `select()` 的内部实现。该函数只对套接字 VFS 驱动的文件描述符起作用。

`get_socket_select_semaphore()` 返回信号对象 (semaphore)，用于非套接字驱动程序中，以终止 `socket_select()` 的等待。

`stop_socket_select()` 通过传递 `get_socket_select_semaphore()` 函数返回的对象来终止 `socket_select()` 函数的等待。

`stop_socket_select_isr()` 与 `stop_socket_select()` 的作用相似，但是前者可在 ISR 中使用。

请参考 [lwip/port/esp32xx/vfs\\_lwip.c](#) 以了解使用 LWIP 的套接字驱动参考实现。

**备注：**如果 `select()` 用于套接字文件描述符，可以禁用 `CONFIG_VFS_SUPPORT_SELECT` 选项来减少代码量，提高性能。不要在 `select()` 调用过程中更改套接字驱动，否则会出现一些未定义行为。

## 路径

已注册的 FS 驱动程序均有一个路径前缀与之关联，此路径前缀即为分区的挂载点。

如果挂载点中嵌套了其他挂载点，则在打开文件时使用具有最长匹配路径前缀的挂载点。例如，假设以下文件系统已在 VFS 中注册：

- 在 `/data` 下注册 FS 驱动程序 1
- 在 `/data/static` 下注册 FS 驱动程序 2

那么：

- 打开 `/data/log.txt` 会调用驱动程序 FS 1；
- 打开 `/data/static/index.html` 需调用 FS 驱动程序 2；
- 即便 FS 驱动程序 2 中没有 `/index.html`，也不会 FS 驱动程序 1 中查找 `/static/index.html`。

挂载点名称必须以路径分隔符 (`/`) 开头，且分隔符后至少包含一个字符。但在以下情况中，VFS 同样支持空的挂载点名称：1. 应用程序需要提供一个“最后方案”下使用的文件系统；2. 应用程序需要同时覆盖 VFS 功能。如果没有与路径匹配的前缀，就会使用到这种文件系统。

VFS 不会对路径中的点 (`.`) 进行特殊处理，也不会将 `..` 视为对父目录的引用。在上述示例中，使用 `/data/static/./log.txt` 路径不会调用 FS 驱动程序 1 打开 `/log.txt`。特定的 FS 驱动程序（如 FATFS）可能以不同的方式处理文件名中的点。

执行打开文件操作时，FS 驱动程序仅得到文件的相对路径（挂载点前缀已经被去除）：

1. 以 `/data` 为路径前缀注册 `myfs` 驱动；
2. 应用程序调用 `fopen("/data/config.json", ...)`；
3. VFS 调用 `myfs_open("/config.json", ...)`；
4. `myfs` 驱动打开 `/config.json` 文件。

VFS 对文件路径长度没有限制，但文件系统路径前缀受 `ESP_VFS_PATH_MAX` 限制，即路径前缀上限为 `ESP_VFS_PATH_MAX`。各个文件系统驱动则可能会对自己的文件名长度设置一些限制。

## 文件描述符

文件描述符是一组很小的正整数，从 0 到 `FD_SETSIZE - 1`，`FD_SETSIZE` 定义在 `sys/select.h`。最大文件描述符由 `CONFIG_LWIP_MAX_SOCKETS` 定义，且为套接字保留。VFS 中包含一个名为 `s_fd_table` 的查找表，用于将全局文件描述符映射至 `s_vfs` 数组中注册的 VFS 驱动索引。

## 标准 IO 流 (`stdin`, `stdout`, `stderr`)

如果 `menuconfig` 中 `UART for console output` 选项没有设置为 `None`，则 `stdin`、`stdout` 和 `stderr` 将默认从 UART 读取或写入。UART0 或 UART1 可用作标准 IO。默认情况下，UART0 使用 115200 波特率，TX 管脚为 GPIO1，RX 管脚为 GPIO3。上述参数可以在 `menuconfig` 中更改。

对 `stdout` 或 `stderr` 执行写入操作将会向 UART 发送 FIFO 发送字符，对 `stdin` 执行读取操作则会从 UART 接收 FIFO 中取出字符。

默认情况下，VFS 使用简单的函数对 UART 进行读写操作。在所有数据放进 UART FIFO 之前，写操作将处于 `busy-wait` 状态，读操作处于非阻塞状态，仅返回 FIFO 中已有数据。由于读操作为非阻塞，高层次 C 库函数调用（如 `fscanf("%d\n", &var);`）可能获取不到所需结果。

如果应用程序使用 UART 驱动，则可以调用 `uart_vfs_dev_use_driver()` 函数来指导 VFS 使用驱动中断、读写阻塞功能等，也可以调用 `uart_vfs_dev_use_nonblocking()` 来恢复非阻塞函数。



VFS 还为输入和输出提供换行符转换功能（可选）。多数应用程序在程序内部发送或接收以 LF (“\n”) 结尾的行，但不同的终端程序可能需要不同的换行符，比如 CR 或 CRLF。应用程序可以通过 `menuconfig` 或者调用 `uart_vfs_dev_port_set_rx_line_endings()` 和 `uart_vfs_dev_port_set_tx_line_endings()` 为输入输出配置换行符。

**标准流和 FreeRTOS 任务** `stdin`、`stdout` 和 `stderr` 的 FILE 对象在所有 FreeRTOS 任务之间共享，指向这些对象的指针分别存储在每个任务的 `struct _reent` 中。

预处理器把如下代码解释为 `fprintf(__getreent()->_stderr, "42\n");`:

```
fprintf(stderr, "42\n");
```

其中 `__getreent()` 函数将为每个任务返回一个指向 `newlib libc` 中 `struct _reent` 的指针。每个任务的 TCB 均拥有一个 `struct _reent` 结构体，任务初始化后，`struct _reent` 结构体中的 `_stdin`、`_stdout` 和 `_stderr` 将会被赋予 `_GLOBAL_REENT` 中 `_stdin`、`_stdout` 和 `_stderr` 的值，`_GLOBAL_REENT` 即为 FreeRTOS 启动之前所用结构体。

这样设计带来的结果是：

- 允许设置给定任务的 `stdin`、`stdout` 和 `stderr`，而不影响其他任务，例如通过 `stdin = fopen("/dev/uart/1", "r");`
- 但使用 `fclose` 关闭默认 `stdin`、`stdout` 或 `stderr` 将同时关闭相应的 FILE 流对象，因此会影响其他任务；
- 如需更改新任务的默认 `stdin`、`stdout` 和 `stderr` 流，请在创建新任务之前修改 `_GLOBAL_REENT->_stdin(_stdout, _stderr)`。

## eventfd()

`eventfd()` 是一个很强大的工具，可以循环通知基于 `select()` 的自定义事件。在 ESP-IDF 中，`eventfd()` 的实现大体上与 [man\(2\) eventfd](#) 中的描述相同，主要区别如下：

- 在调用 `eventfd()` 之前必须先调用 `esp_vfs_eventfd_register()`；
- 标志中没有 `EFD_CLOEXEC`、`EFD_NONBLOCK` 和 `EFD_SEMAPHORE` 选项；
- `EFD_SUPPORT_ISR` 选项已经被添加到标志中。在中断处理程序中读取和写入 `eventfd` 需要这个标志。

注意，用 `EFD_SUPPORT_ISR` 创建 `eventfd` 将导致在读取、写入文件时，以及在设置这个文件的 `select()` 开始和结束时，暂时禁用中断。

## API 参考

### Header File

- [components/vfs/include/esp\\_vfs.h](#)
- This header file can be included with:

```
#include "esp_vfs.h"
```

- This header file is a part of the API provided by the `vfs` component. To declare that your component depends on `vfs`, add the following to your `CMakeLists.txt`:

```
REQUIRES vfs
```

or

```
PRIV_REQUIRES vfs
```

## Functions

`ssize_t esp_vfs_write` (struct \_reent \*r, int fd, const void \*data, size\_t size)

These functions are to be used in newlib syscall table. They will be called by newlib when it needs to use any of the syscalls.

`off_t esp_vfs_lseek` (struct \_reent \*r, int fd, off\_t size, int mode)

`ssize_t esp_vfs_read` (struct \_reent \*r, int fd, void \*dst, size\_t size)

`int esp_vfs_open` (struct \_reent \*r, const char \*path, int flags, int mode)

`int esp_vfs_close` (struct \_reent \*r, int fd)

`int esp_vfs_fstat` (struct \_reent \*r, int fd, struct stat \*st)

`int esp_vfs_stat` (struct \_reent \*r, const char \*path, struct stat \*st)

`int esp_vfs_link` (struct \_reent \*r, const char \*n1, const char \*n2)

`int esp_vfs_unlink` (struct \_reent \*r, const char \*path)

`int esp_vfs_rename` (struct \_reent \*r, const char \*src, const char \*dst)

`int esp_vfs_utime` (const char \*path, const struct utimbuf \*times)

`esp_err_t esp_vfs_register` (const char \*base\_path, const *esp\_vfs\_t* \*vfs, void \*ctx)

Register a virtual filesystem for given path prefix.

#### 参数

- **base\_path** -- file path prefix associated with the filesystem. Must be a zero-terminated C string, may be empty. If not empty, must be up to `ESP_VFS_PATH_MAX` characters long, and at least 2 characters long. Name must start with a "/" and must not end with "/". For example, "/data" or "/dev/spi" are valid. These VFSes would then be called to handle file paths such as "/data/myfile.txt" or "/dev/spi/0". In the special case of an empty `base_path`, a "fallback" VFS is registered. Such VFS will handle paths which are not matched by any other registered VFS.
- **vfs** -- Pointer to *esp\_vfs\_t*, a structure which maps syscalls to the filesystem driver functions. VFS component doesn't assume ownership of this pointer.
- **ctx** -- If `vfs->flags` has `ESP_VFS_FLAG_CONTEXT_PTR` set, a pointer which should be passed to VFS functions. Otherwise, NULL.

**返回** `ESP_OK` if successful, `ESP_ERR_NO_MEM` if too many VFSes are registered.

`esp_err_t esp_vfs_register_fd_range` (const *esp\_vfs\_t* \*vfs, void \*ctx, int min\_fd, int max\_fd)

Special case function for registering a VFS that uses a method other than `open()` to open new file descriptors from the interval `<min_fd; max_fd)`.

This is a special-purpose function intended for registering LWIP sockets to VFS.

#### 参数

- **vfs** -- Pointer to *esp\_vfs\_t*. Meaning is the same as for `esp_vfs_register()`.
- **ctx** -- Pointer to context structure. Meaning is the same as for `esp_vfs_register()`.
- **min\_fd** -- The smallest file descriptor this VFS will use.
- **max\_fd** -- Upper boundary for file descriptors this VFS will use (the biggest file descriptor plus one).

**返回** `ESP_OK` if successful, `ESP_ERR_NO_MEM` if too many VFSes are registered, `ESP_ERR_INVALID_ARG` if the file descriptor boundaries are incorrect.

`esp_err_t esp_vfs_register_with_id` (const *esp\_vfs\_t* \*vfs, void \*ctx, *esp\_vfs\_id\_t* \*vfs\_id)

Special case function for registering a VFS that uses a method other than `open()` to open new file descriptors. In comparison with `esp_vfs_register_fd_range`, this function doesn't pre-register an interval of file descriptors. File descriptors can be registered later, by using `esp_vfs_register_fd`.

#### 参数

- **vfs** -- Pointer to *esp\_vfs\_t*. Meaning is the same as for `esp_vfs_register()`.
- **ctx** -- Pointer to context structure. Meaning is the same as for `esp_vfs_register()`.



- **vfs\_id** -- Here will be written the VFS ID which can be passed to `esp_vfs_register_fd` for registering file descriptors.
- 返回 ESP\_OK if successful, ESP\_ERR\_NO\_MEM if too many VFSes are registered, ESP\_ERR\_INVALID\_ARG if the file descriptor boundaries are incorrect.

*esp\_err\_t* **esp\_vfs\_unregister** (const char \*base\_path)

Unregister a virtual filesystem for given path prefix

- 参数 **base\_path** -- file prefix previously used in `esp_vfs_register` call
- 返回 ESP\_OK if successful, ESP\_ERR\_INVALID\_STATE if VFS for given prefix hasn't been registered

*esp\_err\_t* **esp\_vfs\_unregister\_with\_id** (*esp\_vfs\_id\_t* vfs\_id)

Unregister a virtual filesystem with the given index

- 参数 **vfs\_id** -- The VFS ID returned by `esp_vfs_register_with_id`
- 返回 ESP\_OK if successful, ESP\_ERR\_INVALID\_STATE if VFS for the given index hasn't been registered

*esp\_err\_t* **esp\_vfs\_register\_fd** (*esp\_vfs\_id\_t* vfs\_id, int \*fd)

Special function for registering another file descriptor for a VFS registered by `esp_vfs_register_with_id`. This function should only be used to register permanent file descriptors (socket fd) that are not removed after being closed.

参数

- **vfs\_id** -- VFS identifier returned by `esp_vfs_register_with_id`.
  - **fd** -- The registered file descriptor will be written to this address.
- 返回 ESP\_OK if the registration is successful, ESP\_ERR\_NO\_MEM if too many file descriptors are registered, ESP\_ERR\_INVALID\_ARG if the arguments are incorrect.

*esp\_err\_t* **esp\_vfs\_register\_fd\_with\_local\_fd** (*esp\_vfs\_id\_t* vfs\_id, int local\_fd, bool permanent, int \*fd)

Special function for registering another file descriptor with given `local_fd` for a VFS registered by `esp_vfs_register_with_id`.

参数

- **vfs\_id** -- VFS identifier returned by `esp_vfs_register_with_id`.
  - **local\_fd** -- The fd in the local vfs. Passing -1 will set the local fd as the (\*fd) value.
  - **permanent** -- Whether the fd should be treated as permanent (not removed after close())
  - **fd** -- The registered file descriptor will be written to this address.
- 返回 ESP\_OK if the registration is successful, ESP\_ERR\_NO\_MEM if too many file descriptors are registered, ESP\_ERR\_INVALID\_ARG if the arguments are incorrect.

*esp\_err\_t* **esp\_vfs\_unregister\_fd** (*esp\_vfs\_id\_t* vfs\_id, int fd)

Special function for unregistering a file descriptor belonging to a VFS registered by `esp_vfs_register_with_id`.

参数

- **vfs\_id** -- VFS identifier returned by `esp_vfs_register_with_id`.
  - **fd** -- File descriptor which should be unregistered.
- 返回 ESP\_OK if the registration is successful, ESP\_ERR\_INVALID\_ARG if the arguments are incorrect.

int **esp\_vfs\_select** (int nfd, fd\_set \*readfds, fd\_set \*writefds, fd\_set \*errorfds, struct timeval \*timeout)

Synchronous I/O multiplexing which implements the functionality of POSIX `select()` for VFS.

参数

- **nfd** -- Specifies the range of descriptors which should be checked. The first `nfd` descriptors will be checked in each set.
- **readfds** -- If not NULL, then points to a descriptor set that on input specifies which descriptors should be checked for being ready to read, and on output indicates which descriptors are ready to read.

- **writelfds** -- If not NULL, then points to a descriptor set that on input specifies which descriptors should be checked for being ready to write, and on output indicates which descriptors are ready to write.
- **errorfds** -- If not NULL, then points to a descriptor set that on input specifies which descriptors should be checked for error conditions, and on output indicates which descriptors have error conditions.
- **timeout** -- If not NULL, then points to timeval structure which specifies the time period after which the functions should time-out and return. If it is NULL, then the function will not time-out. Note that the timeout period is rounded up to the system tick and incremented by one.

**返回** The number of descriptors set in the descriptor sets, or -1 when an error (specified by errno) have occurred.

void **esp\_vfs\_select\_triggered** (*esp\_vfs\_select\_sem\_t* sem)

Notification from a VFS driver about a read/write/error condition.

This function is called when the VFS driver detects a read/write/error condition as it was requested by the previous call to start\_select.

**参数 sem** -- semaphore structure which was passed to the driver by the start\_select call

void **esp\_vfs\_select\_triggered\_isr** (*esp\_vfs\_select\_sem\_t* sem, BaseType\_t \*woken)

Notification from a VFS driver about a read/write/error condition (ISR version)

This function is called when the VFS driver detects a read/write/error condition as it was requested by the previous call to start\_select.

**参数**

- **sem** -- semaphore structure which was passed to the driver by the start\_select call
- **woken** -- is set to pdTRUE if the function wakes up a task with higher priority

ssize\_t **esp\_vfs\_pread** (int fd, void \*dst, size\_t size, off\_t offset)

Implements the VFS layer of POSIX pread()

**参数**

- **fd** -- File descriptor used for read
- **dst** -- Pointer to the buffer where the output will be written
- **size** -- Number of bytes to be read
- **offset** -- Starting offset of the read

**返回** A positive return value indicates the number of bytes read. -1 is return on failure and errno is set accordingly.

ssize\_t **esp\_vfs\_pwrite** (int fd, const void \*src, size\_t size, off\_t offset)

Implements the VFS layer of POSIX pwrite()

**参数**

- **fd** -- File descriptor used for write
- **src** -- Pointer to the buffer from where the output will be read
- **size** -- Number of bytes to write
- **offset** -- Starting offset of the write

**返回** A positive return value indicates the number of bytes written. -1 is return on failure and errno is set accordingly.

void **esp\_vfs\_dump\_fds** (FILE \*fp)

Dump the existing VFS FDs data to FILE\* fp.

Dump the FDs in the format:

```
<VFS Path Prefix>-<FD seen by App>-<FD seen by driver>
```

**where:**

```
VFS Path Prefix : file prefix used in the esp_vfs_register call
```

(下页继续)

```

    FD seen by App      : file descriptor returned by the vfs to the application.
    ↪for the path prefix
    FD seen by driver  : file descriptor used by the driver for the same file.
    ↪prefix.

```

参数 **fp** -- File descriptor where data will be dumped

## Structures

struct **esp\_vfs\_select\_sem\_t**  
VFS semaphore type for select()

## Public Members

bool **is\_sem\_local**  
type of "sem" is SemaphoreHandle\_t when true, defined by socket driver otherwise

void \***sem**  
semaphore instance

struct **esp\_vfs\_t**  
VFS definition structure.

This structure should be filled with pointers to corresponding FS driver functions.

VFS component will translate all FDs so that the filesystem implementation sees them starting at zero. The caller sees a global FD which is prefixed with an pre-filesystem-implementation.

Some FS implementations expect some state (e.g. pointer to some structure) to be passed in as a first argument. For these implementations, populate the members of this structure which have `_p` suffix, set flags member to `ESP_VFS_FLAG_CONTEXT_PTR` and provide the context pointer to `esp_vfs_register` function. If the implementation doesn't use this extra argument, populate the members without `_p` suffix and set flags member to `ESP_VFS_FLAG_DEFAULT`.

If the FS driver doesn't provide some of the functions, set corresponding members to `NULL`.

## Public Members

int **flags**  
ESP\_VFS\_FLAG\_CONTEXT\_PTR      and/or      ESP\_VFS\_FLAG\_READONLY\_FS      or  
ESP\_VFS\_FLAG\_DEFAULT

ssize\_t (\***write\_p**)(void \*p, int fd, const void \*data, size\_t size)  
Write with context pointer

ssize\_t (\***write**)(int fd, const void \*data, size\_t size)  
Write without context pointer

off\_t (\***lseek\_p**)(void \*p, int fd, off\_t size, int mode)  
Seek with context pointer

`off_t (*lseek)(int fd, off_t size, int mode)`

Seek without context pointer

`ssize_t (*read_p)(void *ctx, int fd, void *dst, size_t size)`

Read with context pointer

`ssize_t (*read)(int fd, void *dst, size_t size)`

Read without context pointer

`ssize_t (*pread_p)(void *ctx, int fd, void *dst, size_t size, off_t offset)`

pread with context pointer

`ssize_t (*pread)(int fd, void *dst, size_t size, off_t offset)`

pread without context pointer

`ssize_t (*pwrite_p)(void *ctx, int fd, const void *src, size_t size, off_t offset)`

pwrite with context pointer

`ssize_t (*pwrite)(int fd, const void *src, size_t size, off_t offset)`

pwrite without context pointer

`int (*open_p)(void *ctx, const char *path, int flags, int mode)`

open with context pointer

`int (*open)(const char *path, int flags, int mode)`

open without context pointer

`int (*close_p)(void *ctx, int fd)`

close with context pointer

`int (*close)(int fd)`

close without context pointer

`int (*fstat_p)(void *ctx, int fd, struct stat *st)`

fstat with context pointer

`int (*fstat)(int fd, struct stat *st)`

fstat without context pointer

`int (*stat_p)(void *ctx, const char *path, struct stat *st)`

stat with context pointer

`int (*stat)(const char *path, struct stat *st)`

stat without context pointer

`int (*link_p)(void *ctx, const char *n1, const char *n2)`

link with context pointer

int (\***link**)(const char \*n1, const char \*n2)

link without context pointer

int (\***unlink\_p**)(void \*ctx, const char \*path)

unlink with context pointer

int (\***unlink**)(const char \*path)

unlink without context pointer

int (\***rename\_p**)(void \*ctx, const char \*src, const char \*dst)

rename with context pointer

int (\***rename**)(const char \*src, const char \*dst)

rename without context pointer

DIR \*(\***opendir\_p**)(void \*ctx, const char \*name)

opendir with context pointer

DIR \*(\***opendir**)(const char \*name)

opendir without context pointer

struct dirent \*(\***readdir\_p**)(void \*ctx, DIR \*pdir)

readdir with context pointer

struct dirent \*(\***readdir**)(DIR \*pdir)

readdir without context pointer

int (\***readdir\_r\_p**)(void \*ctx, DIR \*pdir, struct dirent \*entry, struct dirent \*\*out\_dirent)

readdir\_r with context pointer

int (\***readdir\_r**)(DIR \*pdir, struct dirent \*entry, struct dirent \*\*out\_dirent)

readdir\_r without context pointer

long (\***telldir\_p**)(void \*ctx, DIR \*pdir)

telldir with context pointer

long (\***telldir**)(DIR \*pdir)

telldir without context pointer

void (\***seekdir\_p**)(void \*ctx, DIR \*pdir, long offset)

seekdir with context pointer

void (\***seekdir**)(DIR \*pdir, long offset)

seekdir without context pointer

int (\***closedir\_p**)(void \*ctx, DIR \*pdir)

closedir with context pointer

int (**\*closedir**)(DIR \*pdir)  
closedir without context pointer

int (**\*mkdir\_p**)(void \*ctx, const char \*name, mode\_t mode)  
mkdir with context pointer

int (**\*mkdir**)(const char \*name, mode\_t mode)  
mkdir without context pointer

int (**\*rmdir\_p**)(void \*ctx, const char \*name)  
rmdir with context pointer

int (**\*rmdir**)(const char \*name)  
rmdir without context pointer

int (**\*fcntl\_p**)(void \*ctx, int fd, int cmd, int arg)  
fcntl with context pointer

int (**\*fcntl**)(int fd, int cmd, int arg)  
fcntl without context pointer

int (**\*ioctl\_p**)(void \*ctx, int fd, int cmd, va\_list args)  
ioctl with context pointer

int (**\*ioctl**)(int fd, int cmd, va\_list args)  
ioctl without context pointer

int (**\*fsync\_p**)(void \*ctx, int fd)  
fsync with context pointer

int (**\*fsync**)(int fd)  
fsync without context pointer

int (**\*access\_p**)(void \*ctx, const char \*path, int amode)  
access with context pointer

int (**\*access**)(const char \*path, int amode)  
access without context pointer

int (**\*truncate\_p**)(void \*ctx, const char \*path, off\_t length)  
truncate with context pointer

int (**\*truncate**)(const char \*path, off\_t length)  
truncate without context pointer

int (**\*ftruncate\_p**)(void \*ctx, int fd, off\_t length)  
ftruncate with context pointer

int (**\*ftruncate**)(int fd, off\_t length)  
ftruncate without context pointer

int (**\*utime\_p**)(void \*ctx, const char \*path, const struct utimbuf \*times)  
utime with context pointer

int (**\*utime**)(const char \*path, const struct utimbuf \*times)  
utime without context pointer

int (**\*tcsetattr\_p**)(void \*ctx, int fd, int optional\_actions, const struct termios \*p)  
tcsetattr with context pointer

int (**\*tcsetattr**)(int fd, int optional\_actions, const struct termios \*p)  
tcsetattr without context pointer

int (**\*tcgetattr\_p**)(void \*ctx, int fd, struct termios \*p)  
tcgetattr with context pointer

int (**\*tcgetattr**)(int fd, struct termios \*p)  
tcgetattr without context pointer

int (**\*tcdrain\_p**)(void \*ctx, int fd)  
tcdrain with context pointer

int (**\*tcdrain**)(int fd)  
tcdrain without context pointer

int (**\*tcflush\_p**)(void \*ctx, int fd, int select)  
tcflush with context pointer

int (**\*tcflush**)(int fd, int select)  
tcflush without context pointer

int (**\*tcflow\_p**)(void \*ctx, int fd, int action)  
tcflow with context pointer

int (**\*tcflow**)(int fd, int action)  
tcflow without context pointer

pid\_t (**\*tcgetsid\_p**)(void \*ctx, int fd)  
tcgetsid with context pointer

pid\_t (**\*tcgetsid**)(int fd)  
tcgetsid without context pointer

int (**\*tcsendbreak\_p**)(void \*ctx, int fd, int duration)  
tcsendbreak with context pointer

int (\***tcsendbreak**)(int fd, int duration)

tcsendbreak without context pointer

*esp\_err\_t* (\***start\_select**)(int nfd, fd\_set \*readfds, fd\_set \*writefds, fd\_set \*exceptfds,  
*esp\_vfs\_select\_sem\_t* sem, void \*\*end\_select\_args)

start\_select is called for setting up synchronous I/O multiplexing of the desired file descriptors in the given VFS

int (\***socket\_select**)(int nfd, fd\_set \*readfds, fd\_set \*writefds, fd\_set \*errorfds, struct timeval \*timeout)

socket select function for socket FDs with the functionality of POSIX select(); this should be set only for the socket VFS

void (\***stop\_socket\_select**)(void \*sem)

called by VFS to interrupt the socket\_select call when select is activated from a non-socket VFS driver; set only for the socket driver

void (\***stop\_socket\_select\_isr**)(void \*sem, BaseType\_t \*woken)

stop\_socket\_select which can be called from ISR; set only for the socket driver

void (\***get\_socket\_select\_semaphore**)(void)

end\_select is called to stop the I/O multiplexing and deinitialize the environment created by start\_select for the given VFS

*esp\_err\_t* (\***end\_select**)(void \*end\_select\_args)

get\_socket\_select\_semaphore returns semaphore allocated in the socket driver; set only for the socket driver

## Macros

### MAX\_FDS

Maximum number of (global) file descriptors.

### ESP\_VFS\_PATH\_MAX

Maximum length of path prefix (not including zero terminator)

### ESP\_VFS\_FLAG\_DEFAULT

Default value of flags member in *esp\_vfs\_t* structure.

### ESP\_VFS\_FLAG\_CONTEXT\_PTR

Flag which indicates that FS needs extra context pointer in syscalls.

### ESP\_VFS\_FLAG\_READONLY\_FS

Flag which indicates that FS is located on read-only partition.

## Type Definitions

typedef int **esp\_vfs\_id\_t**



## Header File

- `components/vfs/include/esp_vfs_dev.h`
- This header file can be included with:

```
#include "esp_vfs_dev.h"
```

- This header file is a part of the API provided by the `vfs` component. To declare that your component depends on `vfs`, add the following to your `CMakeLists.txt`:

```
REQUIRES vfs
```

or

```
PRIV_REQUIRES vfs
```

## Functions

void `esp_vfs_dev_uart_register` (void)

void `esp_vfs_dev_uart_use_nonblocking` (int `uart_num`)

void `esp_vfs_dev_uart_use_driver` (int `uart_num`)

int `esp_vfs_dev_uart_port_set_rx_line_endings` (int `uart_num`, `esp_line_endings_t` `mode`)

int `esp_vfs_dev_uart_port_set_tx_line_endings` (int `uart_num`, `esp_line_endings_t` `mode`)

void `esp_vfs_dev_uart_set_rx_line_endings` (`esp_line_endings_t` `mode`)

Set the line endings expected to be received on UART.

This specifies the conversion between line endings received on UART and newlines ('  
, LF) passed into stdin:

- `ESP_LINE_ENDINGS_CRLF`: convert CRLF to LF
- `ESP_LINE_ENDINGS_CR`: convert CR to LF
- `ESP_LINE_ENDINGS_LF`: no modification

---

**备注:** this function is not thread safe w.r.t. reading from UART

---

**参数** `mode` -- line endings expected on UART

void `esp_vfs_dev_uart_set_tx_line_endings` (`esp_line_endings_t` `mode`)

Set the line endings to sent to UART.

This specifies the conversion between newlines ('  
, LF) on stdout and line endings sent over UART:

- `ESP_LINE_ENDINGS_CRLF`: convert LF to CRLF
- `ESP_LINE_ENDINGS_CR`: convert LF to CR
- `ESP_LINE_ENDINGS_LF`: no modification

---

**备注:** this function is not thread safe w.r.t. writing to UART

---

**参数 mode** -- line endings to send to UART

void **esp\_vfs\_usb\_serial\_jtag\_use\_driver** (void)

set VFS to use USB-SERIAL-JTAG driver for reading and writing

---

**备注:** application must configure USB-SERIAL-JTAG driver before calling these functions With these functions, read and write are blocking and interrupt-driven.

---

void **esp\_vfs\_usb\_serial\_jtag\_use\_nonblocking** (void)

set VFS to use simple functions for reading and writing UART Read is non-blocking, write is busy waiting until TX FIFO has enough space. These functions are used by default.

### Header File

- `components/esp_driver_uart/include/driver/uart_vfs.h`
- This header file can be included with:

```
#include "driver/uart_vfs.h"
```

- This header file is a part of the API provided by the `esp_driver_uart` component. To declare that your component depends on `esp_driver_uart`, add the following to your `CMakeLists.txt`:

```
REQUIRES esp_driver_uart
```

or

```
PRIV_REQUIRES esp_driver_uart
```

### Functions

void **uart\_vfs\_dev\_register** (void)

Add /dev/uart virtual filesystem driver.

This function is called from startup code to enable serial output

int **uart\_vfs\_dev\_port\_set\_rx\_line\_endings** (int uart\_num, esp\_line\_endings\_t mode)

Set the line endings expected to be received on specified UART.

This specifies the conversion between line endings received on UART and newlines ('', LF) passed into stdin:

- `ESP_LINE_ENDINGS_CRLF`: convert CRLF to LF
- `ESP_LINE_ENDINGS_CR`: convert CR to LF
- `ESP_LINE_ENDINGS_LF`: no modification

---

**备注:** this function is not thread safe w.r.t. reading from UART

---

### 参数

- **uart\_num** -- the UART number
- **mode** -- line endings to send to UART

**返回** 0 if succeeded, or -1 when an error (specified by `errno`) have occurred.

`int uart_vfs_dev_port_set_tx_line_endings` (int `uart_num`, `esp_line_endings_t` `mode`)

Set the line endings to sent to specified UART.

This specifies the conversion between newlines ('  
, LF) on stdout and line endings sent over UART:

- `ESP_LINE_ENDINGS_CRLF`: convert LF to CRLF
- `ESP_LINE_ENDINGS_CR`: convert LF to CR
- `ESP_LINE_ENDINGS_LF`: no modification

---

**备注:** this function is not thread safe w.r.t. writing to UART

---

#### 参数

- `uart_num` -- the UART number
- `mode` -- line endings to send to UART

**返回** 0 if succeeded, or -1 when an error (specified by `errno`) have occurred.

`void uart_vfs_dev_use_nonblocking` (int `uart_num`)

set VFS to use simple functions for reading and writing UART

Read is non-blocking, write is busy waiting until TX FIFO has enough space. These functions are used by default.

**参数** `uart_num` -- UART peripheral number

`void uart_vfs_dev_use_driver` (int `uart_num`)

set VFS to use UART driver for reading and writing

---

**备注:** Application must configure UART driver before calling these functions With these functions, read and write are blocking and interrupt-driven.

---

**参数** `uart_num` -- UART peripheral number

### Header File

- [components/vfs/include/esp\\_vfs\\_eventfd.h](#)
- This header file can be included with:

```
#include "esp_vfs_eventfd.h"
```

- This header file is a part of the API provided by the `vfs` component. To declare that your component depends on `vfs`, add the following to your `CMakeLists.txt`:

```
REQUIRES vfs
```

or

```
PRIV_REQUIRES vfs
```

### Functions

`esp_err_t esp_vfs_eventfd_register` (const `esp_vfs_eventfd_config_t` \*`config`)

Registers the event vfs.

**返回** `ESP_OK` if successful, `ESP_ERR_NO_MEM` if too many VFSes are registered.

`esp_err_t esp_vfs_eventfd_unregister` (void)

Unregisters the event vfs.

返回 ESP\_OK if successful, ESP\_ERR\_INVALID\_STATE if VFS for given prefix hasn't been registered

int `eventfd` (unsigned int initval, int flags)

## Structures

struct `esp_vfs_eventfd_config_t`

Eventfd vfs initialization settings.

## Public Members

size\_t `max_fds`

The maximum number of eventfds supported

## Macros

`EFD_SUPPORT_ISR`

`ESP_VFS_EVENTD_CONFIG_DEFAULT` ()

## 2.9.11 磨损均衡 API

### 概述

ESP32-H2 所使用的 flash，特别是 SPI flash，多数具备扇区结构，且每个扇区仅允许有限次数的擦除/修改操作。为了避免过度使用某一扇区，乐鑫提供了磨损均衡组件，无需用户介入即可帮助用户均衡各个扇区之间的磨损。

磨损均衡组件包含了通过分区组件对外部 SPI flash 进行数据读取、写入、擦除和存储器映射相关的 API 函数。磨损均衡组件还具有软件上更高级别的 API 函数，与 *FAT 文件系统* 协同工作。

磨损均衡组件与 FAT 文件系统组件共用 FAT 文件系统的扇区，扇区大小为 4096 字节，是标准 flash 扇区的大小。在这种模式下，磨损均衡组件性能达到最佳，但需要在 RAM 中占用更多内存。

为了节省内存，磨损均衡组件还提供了另外两种模式，均使用 512 字节大小的扇区：

- **性能模式**：先将数据保存在 RAM 中，擦除扇区，然后将数据存储回 flash。如果设备在扇区擦写过程中突然断电，则整个扇区（4096 字节）数据将全部丢失。
- **安全模式**：数据先保存在 flash 中空余扇区，擦除扇区后，数据即存储回去。如果设备断电，上电后可立即恢复数据。

设备默认设置如下：

- 定义扇区大小为 512 字节
- 默认使用性能模式

您可以使用配置菜单更改设置。

磨损均衡组件不会将数据缓存在 RAM 中。写入和擦除函数直接修改 flash，函数返回后，flash 即完成修改。

## 磨损均衡访问 API

处理 flash 数据常用的 API 如下所示：

- `wl_mount` - 为指定分区挂载并初始化磨损均衡模块
- `wl_unmount` - 卸载分区并释放磨损均衡模块
- `wl_erase_range` - 擦除 flash 中指定的地址范围
- `wl_write` - 将数据写入分区
- `wl_read` - 从分区读取数据
- `wl_size` - 返回可用内存的大小（以字节为单位）
- `wl_sector_size` - 返回一个扇区的大小

请尽量避免直接使用原始磨损均衡函数，建议您使用文件系统特定的函数。

## 内存大小

内存大小是根据分区参数在磨损均衡模块中计算所得，由于模块使用 flash 部分扇区存储内部数据，因此计算所得内存大小有少许偏差。

## 另请参阅

- [FAT 文件系统](#)
- [分区表](#)

## 应用示例

`storage/wear_levelling` 中提供了一款磨损均衡驱动与 FatFs 库结合使用的示例。该示例初始化磨损均衡驱动，挂载 FAT 文件系统分区，并使用 POSIX（可移植操作系统接口）和 C 库 API 从中写入和读取数据。如需了解更多信息，请参考 `storage/wear_levelling/README.md`。

## 高级 API 参考

### 头文件

- `fatfs/vfs/esp_vfs_fat.h`

有关高级磨损均衡函数 `esp_vfs_fat_spiflash_mount_rw_wl()`、`esp_vfs_fat_spiflash_unmount_rw_wl()` 和结构体 `esp_vfs_fat_mount_config_t` 的详细内容，请参见 [FAT 文件系统](#)。

## 中层 API 参考

### Header File

- `components/wear_levelling/include/wear_levelling.h`
- This header file can be included with:

```
#include "wear_levelling.h"
```

- This header file is a part of the API provided by the `wear_levelling` component. To declare that your component depends on `wear_levelling`, add the following to your `CMakeLists.txt`:

```
REQUIRES wear_levelling
```

or

```
PRIV_REQUIRES wear_levelling
```

**Functions**

*esp\_err\_t* **wl\_mount** (const *esp\_partition\_t* \*partition, *wl\_handle\_t* \*out\_handle)

Mount WL for defined partition.

**参数**

- **partition** -- that will be used for access
- **out\_handle** -- handle of the WL instance

**返回**

- ESP\_OK, if the WL allocation is successful;
- ESP\_ERR\_INVALID\_ARG, if the arguments for WL configuration are not valid;
- ESP\_ERR\_NO\_MEM, if the WL allocation fails because of insufficient memory;

*esp\_err\_t* **wl\_unmount** (*wl\_handle\_t* handle)

Unmount WL for defined partition.

**参数** **handle** -- WL partition handle

**返回**

- ESP\_OK, if the operation is successful;
- or one of error codes from lower-level flash driver.

*esp\_err\_t* **wl\_erase\_range** (*wl\_handle\_t* handle, *size\_t* start\_addr, *size\_t* size)

Erase part of the WL storage.

**参数**

- **handle** -- WL handle that are related to the partition
- **start\_addr** -- Address from where erase operation should start. Must be aligned to the result of function `wl_sector_size(...)`.
- **size** -- Size of the range which should be erased, in bytes. Must be divisible by the result of function `wl_sector_size(...)`.

**返回**

- ESP\_OK, if the given range was erased successfully;
- ESP\_ERR\_INVALID\_ARG, if iterator or dst are NULL;
- ESP\_ERR\_INVALID\_SIZE, if erase would go out of bounds of the partition;
- or one of error codes from lower-level flash driver.

*esp\_err\_t* **wl\_write** (*wl\_handle\_t* handle, *size\_t* dest\_addr, const void \*src, *size\_t* size)

Write data to the WL storage.

Before writing data to flash, corresponding region of flash needs to be erased. This can be done using `wl_erase_range` function.

---

**备注:** Prior to writing to WL storage, make sure it has been erased with `wl_erase_range` call.

---

**参数**

- **handle** -- WL handle corresponding to the WL partition
- **dest\_addr** -- Address where the data should be written, relative to the beginning of the partition.
- **src** -- Pointer to the source buffer. Pointer must be non-NULL and buffer must be at least 'size' bytes long.
- **size** -- Size of data to be written, in bytes.

**返回**

- ESP\_OK, if data was written successfully;
- ESP\_ERR\_INVALID\_ARG, if `dst_offset` exceeds partition size;
- ESP\_ERR\_INVALID\_SIZE, if write would go out of bounds of the partition;
- or one of error codes from lower-level flash driver.

*esp\_err\_t* **wl\_read** (*wl\_handle\_t* handle, *size\_t* src\_addr, void \*dest, *size\_t* size)

Read data from the WL storage.

**参数**

- **handle** -- WL module instance that was initialized before
- **dest** -- Pointer to the buffer where data should be stored. The Pointer must be non-NULL and the buffer must be at least 'size' bytes long.
- **src\_addr** -- Address of the data to be read, relative to the beginning of the partition.
- **size** -- Size of data to be read, in bytes.

#### 返回

- ESP\_OK, if data was read successfully;
- ESP\_ERR\_INVALID\_ARG, if src\_offset exceeds partition size;
- ESP\_ERR\_INVALID\_SIZE, if read would go out of bounds of the partition;
- or one of error codes from lower-level flash driver.

size\_t **wl\_size** (*wl\_handle\_t* handle)

Get the actual flash size in use for the WL storage partition.

参数 **handle** -- WL module handle that was initialized before

返回 usable size, in bytes

size\_t **wl\_sector\_size** (*wl\_handle\_t* handle)

Get sector size of the WL instance.

参数 **handle** -- WL module handle that was initialized before

返回 sector size, in bytes

## Macros

**WL\_INVALID\_HANDLE**

## Type Definitions

```
typedef int32_t wl_handle_t
```

wear levelling handle

此部分 API 代码示例存放在 ESP-IDF 示例项目的 [storage](#) 目录下。

## 2.10 系统 API

### 2.10.1 应用程序镜像格式

#### 应用程序镜像结构

应用程序镜像包含以下内容：

1. *esp\_image\_header\_t* 结构体描述了 SPI flash 的模式和内存段的数量。
2. *esp\_image\_segment\_header\_t* 结构体描述了每个段、每个段的长度及其在 ESP32-H2 内存中的位置，此描述后接长度为 *data\_len* 的数据。镜像中每个段的数据偏移量的计算方式如下：
  - 0 段的偏移量 =  $\text{sizeof}(\text{esp\_image\_header\_t}) + \text{sizeof}(\text{esp\_image\_segment\_header\_t})$
  - 1 段的偏移量 = 0 段的偏移量 + 0 段长度 +  $\text{sizeof}(\text{esp\_image\_segment\_header\_t})$
  - 2 段的偏移量 = 1 段的偏移量 + 1 段长度 +  $\text{sizeof}(\text{esp\_image\_segment\_header\_t})$
  - ...

*segment\_count* 字段定义了每个段的数量，存储在 *esp\_image\_header\_t* 中。各段段数量不能超过 *ESP\_IMAGE\_MAX\_SEGMENTS*。

运行以下命令，获取镜像段列表：

```
esptool.py --chip esp32h2 image_info build/app.bin
```

```
esptool.py v2.3.1
Image version: 1
Entry point: 40080ea4
13 segments

Segment 1: len 0x13ce0 load 0x3f400020 file_offs 0x00000018 SOC_DROM
Segment 2: len 0x00000 load 0x3ff80000 file_offs 0x00013d00 SOC_RTC_DRAM
Segment 3: len 0x00000 load 0x3ff80000 file_offs 0x00013d08 SOC_RTC_DRAM
Segment 4: len 0x028e0 load 0x3ffb0000 file_offs 0x00013d10 DRAM
Segment 5: len 0x00000 load 0x3ffb28e0 file_offs 0x000165f8 DRAM
Segment 6: len 0x00400 load 0x40080000 file_offs 0x00016600 SOC_IRAM
Segment 7: len 0x09600 load 0x40080400 file_offs 0x00016a08 SOC_IRAM
Segment 8: len 0x62e4c load 0x400d0018 file_offs 0x00020010 SOC_IROM
Segment 9: len 0x06cec load 0x40089a00 file_offs 0x00082e64 SOC_IROM
Segment 10: len 0x00000 load 0x400c0000 file_offs 0x00089b58 SOC_RTC_IRAM
Segment 11: len 0x00004 load 0x50000000 file_offs 0x00089b60 SOC_RTC_DATA
Segment 12: len 0x00000 load 0x50000004 file_offs 0x00089b6c SOC_RTC_DATA
Segment 13: len 0x00000 load 0x50000004 file_offs 0x00089b74 SOC_RTC_DATA
Checksum: e8 (valid)
Validation Hash: 407089ca0eae2bbf83b4120979d3354b1c938a49cb7a0c997f240474ef2ec76b_
↳ (valid)
```

应用程序启动时，ESP-IDF 日志中也会包含段的相关信息：

```
I (443) esp_image: segment 0: paddr=0x00020020 vaddr=0x3f400020 size=0x13ce0 (↳
↳81120) map
I (489) esp_image: segment 1: paddr=0x00033d08 vaddr=0x3ff80000 size=0x00000 ( 0)↳
↳load
I (530) esp_image: segment 2: paddr=0x00033d10 vaddr=0x3ff80000 size=0x00000 ( 0)↳
↳load
I (571) esp_image: segment 3: paddr=0x00033d18 vaddr=0x3ffb0000 size=0x028e0 (↳
↳10464) load
I (612) esp_image: segment 4: paddr=0x00036600 vaddr=0x3ffb28e0 size=0x00000 ( 0)↳
↳load
I (654) esp_image: segment 5: paddr=0x00036608 vaddr=0x40080000 size=0x00400 (↳
↳1024) load
I (695) esp_image: segment 6: paddr=0x00036a10 vaddr=0x40080400 size=0x09600 (↳
↳38400) load
I (737) esp_image: segment 7: paddr=0x00040018 vaddr=0x400d0018 size=0x62e4c_
↳405068) map
I (847) esp_image: segment 8: paddr=0x000a2e6c vaddr=0x40089a00 size=0x06cec (↳
↳27884) load
I (888) esp_image: segment 9: paddr=0x000a9b60 vaddr=0x400c0000 size=0x00000 ( 0)↳
↳load
I (929) esp_image: segment 10: paddr=0x000a9b68 vaddr=0x50000000 size=0x00004 ( 4)↳
↳load
I (971) esp_image: segment 11: paddr=0x000a9b74 vaddr=0x50000004 size=0x00000 ( 0)↳
↳load
I (1012) esp_image: segment 12: paddr=0x000a9b7c vaddr=0x50000004 size=0x00000 (↳
↳0) load
```

有关内存段类型和地址范围的详细信息，请参阅 [ESP32-H2 技术参考手册 > 系统和存储器 > 内部存储器 \[PDF\]](#)。

3. 镜像有一个校验和字节，位于最后一个段之后。此字节写在一个十六字节填充边界上，因此应用程序镜像可能需要填充。
4. 如果在 `esp_image_header_t` 中设置了 `hash_appended` 字段，则会附加 SHA256 校验和字段。SHA256 哈希值的计算范围是从第一个字节开始，到这个字段为止。该字段长度为 32 字节。
5. 如果选项 `CONFIG_SECURE_SIGNED_APPS_SCHEME` 设置为 ECDSA，那么应用程序镜像将有额外的 68 字节用于 ECDSA 签名，其中包括：



- 版本号 (4 字节)
  - 签名数据 (64 字节)
6. 如果选项 `CONFIG_SECURE_SIGNED_APPS_SCHEME` 设置为 `RSA` 或 `ECDSA (V2)`, 则应用程序镜像将有一个额外的签名扇区, 大小为 4K 字节。关于此签名扇区格式的更多内容, 请参考 [Signature Block Format](#)。

## 应用程序描述

应用程序二进制文件的 DROM 段从 `esp_app_desc_t` 结构体开始, 该结构体中包含了用于描述应用程序的特定字段, 如下所示:

- `magic_word`: `esp_app_desc_t` 结构体的魔术词
- `secure_version`: 参见防回滚
- `version`: 参见应用程序版本<sup>1</sup>
- `project_name`: 通过 `PROJECT_NAME` 填充<sup>1</sup>
- `time` 和 `date`: 编译时间和日期
- `idf_ver`: ESP-IDF 的版本<sup>1</sup>
- `app_elf_sha256`: 包含应用程序 ELF 文件的 sha256 哈希

这个结构体有助于识别通过空中升级 (OTA) 上传的镜像, 因为其中包含一个固定的偏移量, 大小为 `sizeof(esp_image_header_t) + sizeof(esp_image_segment_header_t)`。一旦设备接收到包含此结构体的第一个段, 就能根据其中的充分信息来确定是否应继续更新。

要获取当前运行的应用程序的 `esp_app_desc_t` 结构体, 请调用 `esp_app_get_description()`。

要获取另一个 OTA 分区的 `esp_app_desc_t` 结构体, 请调用 `esp_ota_get_partition_description()`。

## 向应用程序添加自定义结构体

也可以自定义类似的结构体, 并使其相对于镜像起始位置有一个固定的偏移量。

采用以下方式向镜像添加自定义结构体:

```
const __attribute__((section(".rodata_custom_desc"))) esp_custom_app_desc_t custom_
↪app_desc = { ... }
```

自定义结构体的偏移量为 `sizeof(esp_image_header_t) + sizeof(esp_image_segment_header_t) + sizeof(esp_app_desc_t)`。

需在 `CMakeLists.txt` 中添加 `target_link_libraries(${COMPONENT_TARGET} "-u custom_app_desc")`, 确保自定义结构体在未使用时也位于镜像中。

## API 参考

### Header File

- `components/bootloader_support/include/esp_app_format.h`
- This header file can be included with:

```
#include "esp_app_format.h"
```

- This header file is a part of the API provided by the `bootloader_support` component. To declare that your component depends on `bootloader_support`, add the following to your `CMakeLists.txt`:

```
REQUIRES bootloader_support
```

or

<sup>1</sup> 最大长度为 32 个字符, 其中包括 `null` 终止符。也就是说, 如果 `PROJECT_NAME` 的长度超过 31 个字符, 超出的字符将被忽略。

`PRIV_REQUIRES bootloader_support`

## Structures

struct **esp\_image\_header\_t**

Main header of binary image.

### Public Members

uint8\_t **magic**

Magic word ESP\_IMAGE\_HEADER\_MAGIC

uint8\_t **segment\_count**

Count of memory segments

uint8\_t **spi\_mode**

flash read mode (esp\_image\_spi\_mode\_t as uint8\_t)

uint8\_t **spi\_speed**

flash frequency (esp\_image\_spi\_freq\_t as uint8\_t)

uint8\_t **spi\_size**

flash chip size (esp\_image\_flash\_size\_t as uint8\_t)

uint32\_t **entry\_addr**

Entry address

uint8\_t **wp\_pin**

WP pin when SPI pins set via efuse (read by ROM bootloader, the IDF bootloader uses software to configure the WP pin and sets this field to 0xEE=disabled)

uint8\_t **spi\_pin\_drv**[3]

Drive settings for the SPI flash pins (read by ROM bootloader)

*esp\_chip\_id\_t* **chip\_id**

Chip identification number

uint8\_t **min\_chip\_rev**

Minimal chip revision supported by image After the Major and Minor revision eFuses were introduced into the chips, this field is no longer used. But for compatibility reasons, we keep this field and the data in it. Use min\_chip\_rev\_full instead. The software interprets this as a Major version for most of the chips and as a Minor version for the ESP32-C3.

uint16\_t **min\_chip\_rev\_full**

Minimal chip revision supported by image, in format: major \* 100 + minor

uint16\_t **max\_chip\_rev\_full**

Maximal chip revision supported by image, in format: major \* 100 + minor

uint8\_t **reserved**[4]

Reserved bytes in additional header space, currently unused

uint8\_t **hash\_appended**

If 1, a SHA256 digest "simple hash" (of the entire image) is appended after the checksum. Included in image length. This digest is separate to secure boot and only used for detecting corruption. For secure boot signed images, the signature is appended after this (and the simple hash is included in the signed data).

struct **esp\_image\_segment\_header\_t**

Header of binary image segment.

### Public Members

uint32\_t **load\_addr**

Address of segment

uint32\_t **data\_len**

Length of data

### Macros

**ESP\_IMAGE\_HEADER\_MAGIC**

The magic word for the *esp\_image\_header\_t* structure.

**ESP\_IMAGE\_MAX\_SEGMENTS**

Max count of segments in the image.

### Enumerations

enum **esp\_chip\_id\_t**

ESP chip ID.

*Values:*

enumerator **ESP\_CHIP\_ID\_ESP32**

chip ID: ESP32

enumerator **ESP\_CHIP\_ID\_ESP32S2**

chip ID: ESP32-S2

enumerator **ESP\_CHIP\_ID\_ESP32C3**

chip ID: ESP32-C3

enumerator **ESP\_CHIP\_ID\_ESP32S3**

chip ID: ESP32-S3

enumerator **ESP\_CHIP\_ID\_ESP32C2**

chip ID: ESP32-C2

enumerator **ESP\_CHIP\_ID\_ESP32C6**

chip ID: ESP32-C6

enumerator **ESP\_CHIP\_ID\_ESP32H2**

chip ID: ESP32-H2

enumerator **ESP\_CHIP\_ID\_ESP32P4**

chip ID: ESP32-P4

enumerator **ESP\_CHIP\_ID\_INVALID**

Invalid chip ID (we defined it to make sure the `esp_chip_id_t` is 2 bytes size)

enum **esp\_image\_spi\_mode\_t**

SPI flash mode, used in [esp\\_image\\_header\\_t](#).

*Values:*

enumerator **ESP\_IMAGE\_SPI\_MODE\_QIO**

SPI mode QIO

enumerator **ESP\_IMAGE\_SPI\_MODE\_QOUT**

SPI mode QOUT

enumerator **ESP\_IMAGE\_SPI\_MODE\_DIO**

SPI mode DIO

enumerator **ESP\_IMAGE\_SPI\_MODE\_DOUT**

SPI mode DOUT

enumerator **ESP\_IMAGE\_SPI\_MODE\_FAST\_READ**

SPI mode FAST\_READ

enumerator **ESP\_IMAGE\_SPI\_MODE\_SLOW\_READ**

SPI mode SLOW\_READ

enum **esp\_image\_spi\_freq\_t**

SPI flash clock division factor.

*Values:*

enumerator **ESP\_IMAGE\_SPI\_SPEED\_DIV\_2**

The SPI flash clock frequency is divided by 2 of the clock source

enumerator **ESP\_IMAGE\_SPI\_SPEED\_DIV\_3**

The SPI flash clock frequency is divided by 3 of the clock source

enumerator **ESP\_IMAGE\_SPI\_SPEED\_DIV\_4**

The SPI flash clock frequency is divided by 4 of the clock source

enumerator **ESP\_IMAGE\_SPI\_SPEED\_DIV\_1**

The SPI flash clock frequency equals to the clock source

enum **esp\_image\_flash\_size\_t**

Supported SPI flash sizes.

*Values:*

enumerator **ESP\_IMAGE\_FLASH\_SIZE\_1MB**

SPI flash size 1 MB

enumerator **ESP\_IMAGE\_FLASH\_SIZE\_2MB**

SPI flash size 2 MB

enumerator **ESP\_IMAGE\_FLASH\_SIZE\_4MB**

SPI flash size 4 MB

enumerator **ESP\_IMAGE\_FLASH\_SIZE\_8MB**

SPI flash size 8 MB

enumerator **ESP\_IMAGE\_FLASH\_SIZE\_16MB**

SPI flash size 16 MB

enumerator **ESP\_IMAGE\_FLASH\_SIZE\_32MB**

SPI flash size 32 MB

enumerator **ESP\_IMAGE\_FLASH\_SIZE\_64MB**

SPI flash size 64 MB

enumerator **ESP\_IMAGE\_FLASH\_SIZE\_128MB**

SPI flash size 128 MB

enumerator **ESP\_IMAGE\_FLASH\_SIZE\_MAX**

SPI flash size MAX

## 2.10.2 引导加载程序镜像的格式

引导加载程序镜像与应用程序镜像具有相同的结构，参见[应用程序镜像结构](#)。二者唯一的区别在于描述引导加载程序的结构体不同。

要查看关于引导加载程序镜像的更多内容，请运行以下命令：

```
esptool.py --chip esp32h2 image_info build/bootloader/bootloader.bin --version 2
```

输出结果如下形式所示：

```
File size: 26576 (bytes)

ESP32 image header
=====
Image version: 1
Entry point: 0x40080658
Segments: 4
Flash size: 2MB
```

(下页继续)

```
Flash freq: 40m
Flash mode: DIO

ESP32 extended image header
=====
WP pin: 0xee
Flash pins drive settings: clk_drv: 0x0, q_drv: 0x0, d_drv: 0x0, cs0_drv: 0x0, hd_
↳drv: 0x0, wp_drv: 0x0
Chip ID: 0
Minimal chip revision: v0.0, (legacy min_rev = 0)
Maximal chip revision: v3.99

Segments information
=====
Segment   Length   Load addr   File offs   Memory types
-----
1   0x01bb0   0x3fff0030   0x00000018   BYTE_ACCESSIBLE, DRAM, DIRAM_DRAM
2   0x03c90   0x40078000   0x00001bd0   CACHE_APP
3   0x00004   0x40080400   0x00005868   IRAM
4   0x00f2c   0x40080404   0x00005874   IRAM

ESP32 image footer
=====
Checksum: 0x65 (valid)
Validation hash: 6f31a7f8512f26f6bce7c3b270f93bf6cf1ee4602c322998ca8ce27433527e92_
↳(valid)

Bootloader information
=====
Bootloader version: 1
ESP-IDF: v5.1-dev-4304-gcb51a3b-dirty
Compile time: Mar 30 2023 19:14:17
```

## 引导加载程序描述

引导加载程序二进制文件的 DRAM0 段起始位置为 `esp_bootloader_desc_t` 结构体，其中包含描述引导加载程序的特定字段。此结构体位置具有固定偏移量，大小为 `sizeof(esp_image_header_t) + sizeof(esp_image_segment_header_t)`。

- `magic_byte`: `esp_bootloader_desc` 结构体的魔术字节
- `reserved`: 保留供 IDF 未来使用
- `version`: 引导加载程序版本，参见 `CONFIG_BOOTLOADER_PROJECT_VER`
- `idf_ver`: IDF 版本。<sup>1</sup>
- `date` 和 `time`: 编译日期和时间
- `reserved2`: 保留供 IDF 未来使用

如需从正在运行的引导加载程序中获取 `esp_bootloader_desc_t` 结构体，请使用 `esp_bootloader_get_description()`。

如需从正在运行的应用程序中获取 `esp_bootloader_desc_t` 结构体，请使用 `esp_ota_get_bootloader_description()`。

## API 参考

### Header File

- `components/esp_bootloader_format/include/esp_bootloader_desc.h`
- This header file can be included with:

<sup>1</sup> 最大长度为 32 个字符，包括空终止符。

```
#include "esp_bootloader_desc.h"
```

- This header file is a part of the API provided by the `esp_bootloader_format` component. To declare that your component depends on `esp_bootloader_format`, add the following to your `CMakeLists.txt`:

```
REQUIRES esp_bootloader_format
```

or

```
PRIV_REQUIRES esp_bootloader_format
```

### Functions

const *esp\_bootloader\_desc\_t*\* **esp\_bootloader\_get\_description** (void)

Return `esp_bootloader_desc` structure.

Intended for use by the bootloader.

**返回** Pointer to `esp_bootloader_desc` structure.

### Structures

struct **esp\_bootloader\_desc\_t**

Bootloader description structure.

### Public Members

uint8\_t **magic\_byte**

Magic byte `ESP_BOOTLOADER_DESC_MAGIC_BYTE`

uint8\_t **reserved**[3]

reserved for IDF

uint32\_t **version**

Bootloader version

char **idf\_ver**[32]

Version IDF

char **date\_time**[24]

Compile date and time

uint8\_t **reserved2**[16]

reserved for IDF

### Macros

**ESP\_BOOTLOADER\_DESC\_MAGIC\_BYTE**

The magic byte for the `esp_bootloader_desc` structure that is in DRAM.

### 2.10.3 应用级追踪

## 概述

ESP-IDF 支持用于程序行为分析的 **应用级追踪**功能。在 `menuconfig` 中启用该功能后，即可通过 JTAG 接口在主机和 ESP32-H2 之间传输任意数据，最小化程序的执行开销。

在程序运行时，开发人员可使用该库向主机发送应用程序的特定执行状态，并接收来自应用程序的命令或其他信息。该库的主要用例包括：

1. 收集特定应用程序的数据，参见 [特定应用程序的跟踪](#)。
2. 向主机发送轻量级日志，参见 [记录日志到主机](#)。
3. 系统行为分析，参见 [基于 SEGGER System View 的系统行为分析](#)。

## API 参考

### Header File

- `components/app_trace/include/esp_app_trace.h`
- This header file can be included with:

```
#include "esp_app_trace.h"
```

- This header file is a part of the API provided by the `app_trace` component. To declare that your component depends on `app_trace`, add the following to your `CMakeLists.txt`:

```
REQUIRES app_trace
```

or

```
PRIV_REQUIRES app_trace
```

### Functions

`esp_err_t esp_apptrace_init` (void)

Initializes application tracing module.

---

**备注:** Should be called before any `esp_apptrace_xxx` call.

---

返回 ESP\_OK on success, otherwise see `esp_err_t`

void `esp_apptrace_down_buffer_config` (uint8\_t \*buf, uint32\_t size)

Configures down buffer.

---

**备注:** Needs to be called before attempting to receive any data using `esp_apptrace_down_buffer_get` and `esp_apptrace_read`. This function does not protect internal data by lock.

---

#### 参数

- **buf** -- Address of buffer to use for down channel (host to target) data.
- **size** -- Size of the buffer.

uint8\_t \*`esp_apptrace_buffer_get` (`esp_apptrace_dest_t` dest, uint32\_t size, uint32\_t tmo)

Allocates buffer for trace data. Once the data in the buffer is ready to be sent, `esp_apptrace_buffer_put` must be called to indicate it.

#### 参数

- **dest** -- Indicates HW interface to send data.
- **size** -- Size of data to write to trace buffer.
- **tmo** -- Timeout for operation (in us). Use `ESP_APPTRACE_TMO_INFINITE` to wait indefinitely.



返回 non-NULL on success, otherwise NULL.

*esp\_err\_t* **esp\_appttrace\_buffer\_put** (*esp\_appttrace\_dest\_t* dest, uint8\_t \*ptr, uint32\_t tmo)

Indicates that the data in the buffer is ready to be sent. This function is a counterpart of and must be preceded by `esp_appttrace_buffer_get`.

参数

- **dest** -- Indicates HW interface to send data. Should be identical to the same parameter in call to `esp_appttrace_buffer_get`.
- **ptr** -- Address of trace buffer to release. Should be the value returned by call to `esp_appttrace_buffer_get`.
- **tmo** -- Timeout for operation (in us). Use `ESP_APPTRACE_TMO_INFINITE` to wait indefinitely.

返回 ESP\_OK on success, otherwise see `esp_err_t`

*esp\_err\_t* **esp\_appttrace\_write** (*esp\_appttrace\_dest\_t* dest, const void \*data, uint32\_t size, uint32\_t tmo)

Writes data to trace buffer.

参数

- **dest** -- Indicates HW interface to send data.
- **data** -- Address of data to write to trace buffer.
- **size** -- Size of data to write to trace buffer.
- **tmo** -- Timeout for operation (in us). Use `ESP_APPTRACE_TMO_INFINITE` to wait indefinitely.

返回 ESP\_OK on success, otherwise see `esp_err_t`

int **esp\_appttrace\_vprintf\_to** (*esp\_appttrace\_dest\_t* dest, uint32\_t tmo, const char \*fmt, va\_list ap)

vprintf-like function to send log messages to host via specified HW interface.

参数

- **dest** -- Indicates HW interface to send data.
- **tmo** -- Timeout for operation (in us). Use `ESP_APPTRACE_TMO_INFINITE` to wait indefinitely.
- **fmt** -- Address of format string.
- **ap** -- List of arguments.

返回 Number of bytes written.

int **esp\_appttrace\_vprintf** (const char \*fmt, va\_list ap)

vprintf-like function to send log messages to host.

参数

- **fmt** -- Address of format string.
- **ap** -- List of arguments.

返回 Number of bytes written.

*esp\_err\_t* **esp\_appttrace\_flush** (*esp\_appttrace\_dest\_t* dest, uint32\_t tmo)

Flushes remaining data in trace buffer to host.

参数

- **dest** -- Indicates HW interface to flush data on.
- **tmo** -- Timeout for operation (in us). Use `ESP_APPTRACE_TMO_INFINITE` to wait indefinitely.

返回 ESP\_OK on success, otherwise see `esp_err_t`

*esp\_err\_t* **esp\_appttrace\_flush\_nolock** (*esp\_appttrace\_dest\_t* dest, uint32\_t min\_sz, uint32\_t tmo)

Flushes remaining data in trace buffer to host without locking internal data. This is a special version of `esp_appttrace_flush` which should be called from panic handler.

参数

- **dest** -- Indicates HW interface to flush data on.
- **min\_sz** -- Threshold for flushing data. If current filling level is above this value, data will be flushed. TRAX destinations only.

- **tmo** -- Timeout for operation (in us). Use `ESP_APPTRACE_TMO_INFINITE` to wait indefinitely.

返回 `ESP_OK` on success, otherwise see `esp_err_t`

`esp_err_t esp_appttrace_read(esp_appttrace_dest_t dest, void *data, uint32_t *size, uint32_t tmo)`

Reads host data from trace buffer.

#### 参数

- **dest** -- Indicates HW interface to read the data on.
- **data** -- Address of buffer to put data from trace buffer.
- **size** -- Pointer to store size of read data. Before call to this function pointed memory must hold requested size of data
- **tmo** -- Timeout for operation (in us). Use `ESP_APPTRACE_TMO_INFINITE` to wait indefinitely.

返回 `ESP_OK` on success, otherwise see `esp_err_t`

`uint8_t *esp_appttrace_down_buffer_get(esp_appttrace_dest_t dest, uint32_t *size, uint32_t tmo)`

Retrieves incoming data buffer if any. Once data in the buffer is processed, `esp_appttrace_down_buffer_put` must be called to indicate it.

#### 参数

- **dest** -- Indicates HW interface to receive data.
- **size** -- Address to store size of available data in down buffer. Must be initialized with requested value.
- **tmo** -- Timeout for operation (in us). Use `ESP_APPTRACE_TMO_INFINITE` to wait indefinitely.

返回 non-NULL on success, otherwise NULL.

`esp_err_t esp_appttrace_down_buffer_put(esp_appttrace_dest_t dest, uint8_t *ptr, uint32_t tmo)`

Indicates that the data in the down buffer is processed. This function is a counterpart of and must be preceded by `esp_appttrace_down_buffer_get`.

#### 参数

- **dest** -- Indicates HW interface to receive data. Should be identical to the same parameter in call to `esp_appttrace_down_buffer_get`.
- **ptr** -- Address of trace buffer to release. Should be the value returned by call to `esp_appttrace_down_buffer_get`.
- **tmo** -- Timeout for operation (in us). Use `ESP_APPTRACE_TMO_INFINITE` to wait indefinitely.

返回 `ESP_OK` on success, otherwise see `esp_err_t`

`bool esp_appttrace_host_is_connected(esp_appttrace_dest_t dest)`

Checks whether host is connected.

参数 **dest** -- Indicates HW interface to use.

返回 true if host is connected, otherwise false

`void *esp_appttrace_fopen(esp_appttrace_dest_t dest, const char *path, const char *mode)`

Opens file on host. This function has the same semantic as 'fopen' except for the first argument.

#### 参数

- **dest** -- Indicates HW interface to use.
- **path** -- Path to file.
- **mode** -- Mode string. See `fopen` for details.

返回 non zero file handle on success, otherwise 0

`int esp_appttrace_fclose(esp_appttrace_dest_t dest, void *stream)`

Closes file on host. This function has the same semantic as 'fclose' except for the first argument.

#### 参数

- **dest** -- Indicates HW interface to use.
- **stream** -- File handle returned by `esp_appttrace_fopen`.

返回 Zero on success, otherwise non-zero. See `fclose` for details.

size\_t **esp\_appttrace\_fwrite** (*esp\_appttrace\_dest\_t* dest, const void \*ptr, size\_t size, size\_t nmemb, void \*stream)

Writes to file on host. This function has the same semantic as 'fwrite' except for the first argument.

#### 参数

- **dest** -- Indicates HW interface to use.
- **ptr** -- Address of data to write.
- **size** -- Size of an item.
- **nmemb** -- Number of items to write.
- **stream** -- File handle returned by esp\_appttrace\_fopen.

返回 Number of written items. See fwrite for details.

size\_t **esp\_appttrace\_fread** (*esp\_appttrace\_dest\_t* dest, void \*ptr, size\_t size, size\_t nmemb, void \*stream)

Read file on host. This function has the same semantic as 'fread' except for the first argument.

#### 参数

- **dest** -- Indicates HW interface to use.
- **ptr** -- Address to store read data.
- **size** -- Size of an item.
- **nmemb** -- Number of items to read.
- **stream** -- File handle returned by esp\_appttrace\_fopen.

返回 Number of read items. See fread for details.

int **esp\_appttrace\_fseek** (*esp\_appttrace\_dest\_t* dest, void \*stream, long offset, int whence)

Set position indicator in file on host. This function has the same semantic as 'fseek' except for the first argument.

#### 参数

- **dest** -- Indicates HW interface to use.
- **stream** -- File handle returned by esp\_appttrace\_fopen.
- **offset** -- Offset. See fseek for details.
- **whence** -- Position in file. See fseek for details.

返回 Zero on success, otherwise non-zero. See fseek for details.

int **esp\_appttrace\_ftell** (*esp\_appttrace\_dest\_t* dest, void \*stream)

Get current position indicator for file on host. This function has the same semantic as 'ftell' except for the first argument.

#### 参数

- **dest** -- Indicates HW interface to use.
- **stream** -- File handle returned by esp\_appttrace\_fopen.

返回 Current position in file. See ftell for details.

int **esp\_appttrace\_fstop** (*esp\_appttrace\_dest\_t* dest)

Indicates to the host that all file operations are complete. This function should be called after all file operations are finished and indicate to the host that it can perform cleanup operations (close open files etc.).

参数 **dest** -- Indicates HW interface to use.

返回 ESP\_OK on success, otherwise see esp\_err\_t

int **esp\_appttrace\_feof** (*esp\_appttrace\_dest\_t* dest, void \*stream)

Test end-of-file indicator on a stream. This function has the same semantic as 'feof' except for the first argument.

#### 参数

- **dest** -- Indicates HW interface to use.
- **stream** -- File handle returned by esp\_appttrace\_fopen.

返回 Non-Zero if end-of-file indicator is set for stream. See feof for details.

void **esp\_gcov\_dump** (void)

Triggers gcov info dump. This function waits for the host to connect to target before dumping data.

## Enumerations

enum **esp\_apptrace\_dest\_t**

Application trace data destinations bits.

*Values:*

enumerator **ESP\_APPTRACE\_DEST\_JTAG**

JTAG destination.

enumerator **ESP\_APPTRACE\_DEST\_TRAX**

xxx\_TRAX name is obsolete, use more common xxx\_JTAG

enumerator **ESP\_APPTRACE\_DEST\_UART**

UART destination.

enumerator **ESP\_APPTRACE\_DEST\_MAX**

enumerator **ESP\_APPTRACE\_DEST\_NUM**

## Header File

- [components/app\\_trace/include/esp\\_sysview\\_trace.h](#)
- This header file can be included with:

```
#include "esp_sysview_trace.h"
```

- This header file is a part of the API provided by the `app_trace` component. To declare that your component depends on `app_trace`, add the following to your `CMakeLists.txt`:

```
REQUIRES app_trace
```

or

```
PRIV_REQUIRES app_trace
```

## Functions

static inline *esp\_err\_t* **esp\_sysview\_flush** (uint32\_t tmo)

Flushes remaining data in SystemView trace buffer to host.

**参数** `tmo` -- Timeout for operation (in us). Use `ESP_APPTRACE_TMO_INFINITE` to wait indefinitely.

**返回** `ESP_OK`.

int **esp\_sysview\_vprintf** (const char \*format, va\_list args)

vprintf-like function to sent log messages to the host.

**参数**

- **format** -- Address of format string.
- **args** -- List of arguments.

**返回** Number of bytes written.

*esp\_err\_t* **esp\_sysview\_heap\_trace\_start** (uint32\_t tmo)

Starts SystemView heap tracing.

**参数** `tmo` -- Timeout (in us) to wait for the host to be connected. Use -1 to wait forever.

**返回** `ESP_OK` on success, `ESP_ERR_TIMEOUT` if operation has been timed out.

`esp_err_t esp_sysview_heap_trace_stop` (void)

Stops SystemView heap tracing.

返回 ESP\_OK.

void `esp_sysview_heap_trace_alloc` (void \*addr, uint32\_t size, const void \*callers)

Sends heap allocation event to the host.

参数

- **addr** -- Address of allocated block.
- **size** -- Size of allocated block.
- **callers** -- Pointer to array with callstack addresses. Array size must be CONFIG\_HEAP\_TRACING\_STACK\_DEPTH.

void `esp_sysview_heap_trace_free` (void \*addr, const void \*callers)

Sends heap de-allocation event to the host.

参数

- **addr** -- Address of de-allocated block.
- **callers** -- Pointer to array with callstack addresses. Array size must be CONFIG\_HEAP\_TRACING\_STACK\_DEPTH.

## 2.10.4 使用外部堆栈调用函数

### 概述

执行某个给定函数时，可以使用用户分配的堆栈空间，且该堆栈空间独立于当前任务的堆栈。这一机制能够节省在调用常用函数时浪费大量堆栈空间，例如 `printf` 函数。具体而言，将给定函数作为参数传入 `esp_execute_shared_stack_function()` 中，给定函数便会在共享堆栈空间内作为回调函数延迟执行。

**警告：** `esp_execute_shared_stack_function()` 只会为所提供的共享堆栈内存做最基础的设置。传递给该函数以在共享堆栈空间上执行的函数，或调用该函数的任何函数，都不应执行以下任何操作：

- 使用线程局部存储 (TLS)
- 调用 `vTaskDelete(NULL)` 删除当前运行的任务

此外，从共享堆栈上运行的函数或调用该函数的任何函数来调用回溯，回溯信息都可能不正确。这方面的限制十分严格，因此将来 `esp_execute_shared_stack_function()` 可能会被弃用。如有用例必须使用 `esp_execute_shared_stack_function()` 函数才能实现，请提交 [GitHub Issue](#)。

### 使用方法

`esp_execute_shared_stack_function()` 需要四个参数：

- 由调用者分配的互斥锁，防止同一函数共享分配的堆栈
- 指向分配的堆栈顶部的指针
- 以字节为单位的堆栈的大小
- 指向需要共享堆栈的函数的指针

通过这一功能，用户指定的函数被作为回调函数延迟执行，并在用户分配的空间中调用，无需从当前任务堆栈中获取空间。

该函数的使用方式如下所示：

```

void external_stack_function(void)
{
    printf("Executing this printf from external stack! \n");
}

//假设要使用一个单独的堆栈空间来调用 printf 函数
//允许应用程序减小其堆栈大小
void app_main()
{
    //从堆中或以静态方式分配一个堆栈 buffer:
    StackType_t *shared_stack = malloc(8192 * sizeof(StackType_t));
    assert(shared_stack != NULL);

    //分配一个互斥锁:
    SemaphoreHandle_t printf_lock = xSemaphoreCreateMutex();
    assert(printf_lock != NULL);

    //使用宏助手调用所需函数:
    esp_execute_shared_stack_function(printf_lock,
                                     shared_stack,
                                     8192,
                                     external_stack_function);

    vSemaphoreDelete(printf_lock);
    free(shared_stack);
}

```

## API 参考

### Header File

- [components/esp\\_system/include/esp\\_expression\\_with\\_stack.h](#)
- This header file can be included with:

```
#include "esp_expression_with_stack.h"
```

### Functions

void **esp\_execute\_shared\_stack\_function** (*SemaphoreHandle\_t* lock, void \*stack, size\_t stack\_size, *shared\_stack\_function* function)

Calls function on user defined shared stack space.

After returning, the original stack is used again.

---

**备注:** if either lock, stack or stack size is invalid, the expression will be called using the current stack.

---

**警告:** This function does minimal preparation of the provided piece of memory (stack). DO NOT do any of the following in function or any of its callees:

- Use Thread-local storage
- Use the Floating-point unit on ESP32-P4
- Use the AI co-processor on ESP32-P4
- Call vTaskDelete(NULL) (deleting the currently running task) Furthermore, backtraces will be wrong when called from function or any of its callees. The limitations are quite sever, so that we might deprecate this function in the future. If you have any use case which can only be implemented using this function, please open an issue on github.

### 参数

- **lock** -- Mutex object to protect in case of shared stack
- **stack** -- Pointer to user allocated stack
- **stack\_size** -- Size of current stack in bytes
- **function** -- pointer to the shared stack function to be executed

### Macros

**ESP\_EXECUTE\_EXPRESSION\_WITH\_STACK** (lock, stack, stack\_size, expression)

### Type Definitions

```
typedef void (*shared_stack_function)(void)
```

## 2.10.5 芯片版本

### 概述

ESP32-H2 可能包含多个芯片版本。引入不同的版本主要用于修复问题，有时也用于添加新功能。[版本控制方案](#) 描述了这些芯片修订的版本以及运行时读取版本信息所用的 API。

须考虑应用程序、ESP-IDF 版本和芯片版本之间的兼容性：

- 应用程序可能依赖于某个芯片版本的修复内容或功能。
- 较新版本的硬件可能与较早版本的 ESP-IDF 不兼容。

本文档的[ESP-IDF 兼容性检查](#) 部分描述了应用程序如何明确芯片版本需求，以及 ESP-IDF 如何对兼容性进行检查。文档最后提供了此方案的故障排除相关信息。

### 版本控制方案

芯片版本号通常以 `vX.Y` 的形式表示，其中：

- `X` 表示主版本号。该号码变更表示在旧版芯片上使用的软件与新版芯片不兼容，必须升级软件方可使用。
- `Y` 表示次版本号。该号码变更表示在旧版芯片上使用的软件与新版芯片兼容，无需升级软件。

如果新版芯片不包含重大变更，则可以兼容旧版芯片上运行的软件。此时，新版芯片的主版本号不变，次版本号加 1。例如，版本号从 `v1.1` 变为 `v1.2`。

相反，如果新版芯片包含重大变更，则 **无法兼容** 旧版芯片的软件。此时，新版芯片的主版本号增加，次版本号设置为 0。例如，版本号从 `v1.1` 变为 `v2.0`。

此版本控制方式能够表示芯片版本之间的衍生关系，并清晰表明芯片变更是否为重大变更。

在芯片发生非重大变更时，ESP-IDF 的执行逻辑应与此前最近版本的逻辑相同，从而达到无缝衔接。在这样便可直接将编译后的二进制文件迁移到更新了次版本的芯片上，无需升级 ESP-IDF 版本并重新编译整个项目。

当二进制文件在更新了主版本的芯片上意外执行时，软件也能够根据主版本报告问题。此主次版本方案还允许硬件变更分支化。

---

**备注：** 目前的主次版本号芯片版本方案是从 ESP-IDF v5.0 开始引入的。因此，早期 ESP-IDF 创建的引导加载程序将继续使用晶圆版本表示的芯片版本方案。

---



**用于芯片版本的 eFuse 位** 芯片使用以下几个 eFuse 字段来进行版本控制：

- 主版本号 (WAFER\_VERSION\_MAJOR eFuse)
- 次版本号 (WAFER\_VERSION\_MINOR eFuse)
- 忽略最大版本限制位 (DISABLE\_WAFER\_VERSION\_MAJOR eFuse)。请参考[ESP-IDF 兼容性检查](#)了解此 eFuse 字段。

**备注：**此前的版本控制逻辑基于单一的 eFuse 版本字段，即 WAFER\_VERSION。这种方式无法表明芯片的更新是否为重大更新，是一种线性的版本控制逻辑。

**芯片版本 API** 使用下列 API 从 eFuse 中读取芯片版本：

- `efuse_hal_chip_revision()`，返回的版本格式为 `major * 100 + minor`。
- `efuse_hal_get_major_chip_version()` 返回主版本号。
- `efuse_hal_get_minor_chip_version()` 返回次版本号。

下列 Kconfig 选项（格式为 `major * 100 + minor`）可以将芯片版本依赖添加到代码中：

- `CONFIG_ESP32H2_REV_MIN_FULL`
- `CONFIG_ESP_REV_MIN_FULL`
- `CONFIG_ESP32H2_REV_MAX_FULL`
- `CONFIG_ESP_REV_MAX_FULL`

## ESP-IDF 兼容性检查

如果构建的应用程序需要支持特定芯片的多个版本，可通过 Kconfig 指定支持的最小和最大芯片版本号。

最小芯片版本号可以通过 Kconfig 选项 `CONFIG_ESP32H2_REV_MIN` 来选择。设置最小芯片版本后，软件只能在较新的芯片版本上运行，以便支持某些功能或修复某些错误。

最大芯片版本号无法指定，只能由当前使用的 ESP-IDF 版本自动决定。ESP-IDF 会拒绝启动任何超过最大芯片版本号的芯片版本。由于特定版本的 ESP-IDF 无法预知未来的芯片版本更新，因此最大芯片版本号通常设置为 `maximum supported MAJOR version + 99`。可以设置“忽略最大版本” eFuse 来绕过最大版本限制，但这不能确保软件正常工作。

下文介绍了芯片版本未通过兼容性检查时显示的故障排除信息及解决方法，并描述了在早期 ESP-IDF 版本中与软件行为和兼容性检查相关的技术细节。

## 故障排除

1. 如果第二阶段引导加载程序所运行的芯片版本低于镜像（如软件镜像）中指定的最小版本，会发生重启并显示以下消息：

```
Image requires chip rev >= v3.0, but chip is v1.0
```

要解决此问题，

- 确保使用的芯片达到了要求的最低版本及以上。
- 减小 `CONFIG_ESP32H2_REV_MIN` 的值并重建镜像，使镜像的版本与当前芯片版本兼容。

1. 如果应用程序所需的芯片版本不处于最小和最大芯片版本的区间范围内，会发生重启并显示以下消息：

```
Image requires chip rev <= v2.99, but chip is v3.0
```

为解决此问题，需更新 ESP-IDF 到较新版本，以支持该芯片版本 (`CONFIG_ESP32H2_REV_MAX_FULL`)。也可以在 eFuse 中设置 `Ignore maximal revision` 位，或使用与当前 ESP-IDF 版本兼容的其他芯片版本。



**二进制镜像的常见版本需求** 二级引导程序和应用程序二进制镜像中包含 `esp_image_header_t` 头文件，其中记录了可以运行该软件的芯片版本号。这一头文件有 3 个与版本相关的字段：

- `min_chip_rev` - 镜像所需芯片的最小主版本号（但对于 ESP32-C3，该字段指次版本号）。其值由 `CONFIG_ESP32H2_REV_MIN` 确定。
- `min_chip_rev_full` - 镜像所需芯片的最小次版本号，格式为 `major * 100 + minor`。其值由 `CONFIG_ESP32H2_REV_MIN` 确定。
- `max_chip_rev_full` - 镜像所需芯片的最大版本，格式为 `major * 100 + minor`。其值由 `CONFIG_ESP32H2_REV_MAX_FULL` 确定。用户无法对其进行修改，仅当 ESP-IDF 支持新版本时由乐鑫官方进行更改。

**最大和最小版本限制** 应用启动过程中，检查最小和最大版本的顺序如下：

1. 在运行第 2 阶段引导启动程序前，第 1 阶段引导启动程序（ROM 引导启动程序）不会在 `esp_image_header_t` 中检查最小和最大版本字段。
2. 在第 2 阶段引导启动程序的初始化阶段，会检查引导程序自身是否可以在此版本的芯片上启动。它从引导启动程序镜像的头文件中读取最小版本，并与 eFuse 中的芯片版本进行比较。如果芯片版本低于最小版本，引导启动程序会拒绝启动并中止运行。此阶段不检查最大版本。
3. 然后，第 2 阶段引导启动程序会检查应用程序的版本要求。它从应用程序镜像的头文件中读取最小和最大版本，并与 eFuse 中的芯片版本进行比较。如果该芯片版本低于最小版本或高于最大版本，引导程序会拒绝启动并中止。然而，如果设置了忽略最大版本位，则可以忽略最大版本限制。软件确定可以使用此芯片版本时，用户可以自行设置忽略位。
4. 在空中升级 (OTA) 阶段，运行中的应用程序会检查新软件是否与芯片版本相匹配。它会从新应用程序镜像的标头中提取最小和最大版本，并与 eFuse 中的芯片版本进行比较。应用程序检查版本匹配的方式与引导启动程序相同，即芯片版本须处在最小和最大版本之间（忽略最大版本的逻辑也相同）。

**向后兼容旧版 ESP-IDF 构建的引导启动程序** 请使用 `esptool chip_id` 命令查看芯片版本。

## 参考链接

- [芯片版本编号方案兼容指南](#)
- [ESP-IDF 版本与乐鑫芯片版本兼容性](#)
- [SoC Errata](#)
- [ESP-IDF 版本简介](#)

## API 参考

### Header File

- `components/hal/include/hal/efuse_hal.h`
- This header file can be included with:

```
#include "hal/efuse_hal.h"
```

### Functions

void `efuse_hal_get_mac` (uint8\_t \*mac)

get factory mac address

uint32\_t `efuse_hal_chip_revision` (void)

Returns chip version.

**返回** Chip version in format: Major \* 100 + Minor

uint32\_t `efuse_hal_blk_version` (void)

Return block version.

**返回** Block version in format: Major \* 100 + Minor

bool **efuse\_hal\_flash\_encryption\_enabled** (void)

Is flash encryption currently enabled in hardware?

Flash encryption is enabled if the FLASH\_CRYPT\_CNT efuse has an odd number of bits set.

**返回** true if flash encryption is enabled.

bool **efuse\_hal\_get\_disable\_wafer\_version\_major** (void)

Returns the status of whether the bootloader (and OTA) will check the maximum chip version or not.

**返回** true - Skip the maximum chip version check.

uint32\_t **efuse\_hal\_get\_major\_chip\_version** (void)

Returns major chip version.

uint32\_t **efuse\_hal\_get\_minor\_chip\_version** (void)

Returns minor chip version.

void **efuse\_hal\_set\_ecdsa\_key** (int efuse\_key\_blk)

Set the efuse block that should be used as ECDSA private key.

---

**备注:** The efuse block must be burnt with key purpose ECDSA\_KEY

---

**参数** **efuse\_key\_blk** -- Efuse key block number (Must be in [EFUSE\_BLK\_KEY0...EFUSE\_BLK\_KEY\_MAX - 1] range)

## 2.10.6 控制台终端

ESP-IDF 提供了 `console` 组件，它包含了开发基于串口的交互式控制终端所需要的所有模块，主要支持以下功能：

- 行编辑，由 `linenoise` 库具体实现，它支持处理退格键和方向键，支持回看命令的历史记录，支持命令的自动补全和参数提示。
- 将命令行拆分为参数列表。
- 参数解析，由 `argtable3` 库具体实现，该库提供解析 GNU 样式的命令行参数的 API。
- 用于注册和调度命令的函数。
- 帮助创建 REPL (Read-Evaluate-Print-Loop) 环境的函数。

---

**备注:** 这些功能模块可以一起使用，也可以独立使用，例如仅使用行编辑和命令注册的功能，然后使用 `getopt` 函数或者自定义的函数来实现参数解析，而不是直接使用 `argtable3` 库。同样地，还可以使用更简单的命令输入方法（比如 `fgets` 函数）和其他用于命令分割和参数解析的方法。

---



---

**备注:** 当在支持硬件 USB 串行接口的芯片上使用控制台应用程序时，建议禁用次级串口控制台输出。次级输出仅用于显示，对于交互式应用程序没有任何作用。

---

### 行编辑

行编辑功能允许用户通过按键输入来编辑命令，使用退格键删除符号，使用左/右键在命令中移动光标，使用上/下键导航到之前输入的命令，使用制表键（“Tab”）来自动补全命令。

---

**备注:** 此功能依赖于终端应用程序对 ANSI 转义符的支持。因此，显示原始 UART 数据的串口监视器不能与行编辑库一同使用。如果运行 `system/console` 示例程序的时候看到的输出结果是 `[6n` 或者类似的转义字符而不是命令行提示符 `esp>` 时，就表明当前的串口监视器不支持 ANSI 转义字符。已知可用的串

口监视程序有 GNU screen、minicom 和 esp-idf-monitor（可以通过在项目目录下执行 `idf.py monitor` 来调用）。

前往这里可以查看 [linenoise](#) 库提供的所有函数的描述。

**配置** Linenoise 库不需要显式地初始化，但是在调用行编辑函数之前，可能需要对某些配置的默认值稍作修改。

- `linenoiseClearScreen()`  
使用转义字符清除终端屏幕，并将光标定位在左上角。
- `linenoiseSetMultiLine()`  
在单行和多行编辑模式之间进行切换。单行模式下，如果命令的长度超过终端的宽度，会在行内滚动命令文本以显示文本的结尾，在这种情况下，文本的开头部分会被隐藏。单行模式在每次按下按键时发送给屏幕刷新的数据比较少，与多行模式相比更不容易发生故障。另一方面，在单行模式下编辑命令和复制命令将变得更加困难。默认情况下开启的是单行模式。
- `linenoiseAllowEmpty()`  
设置 `linenoise` 库收到空行的解析行为，设置为 `true` 时返回长度为零的字符串 ("")，设置为 `false` 时返回 `NULL`。默认情况下，将返回长度为零的字符串。
- `linenoiseSetMaxLineLen()`  
设置 `linenoise` 库中每行的最大长度，默认长度为 4096 字节，可以通过更新该默认值来优化 RAM 内存的使用。

### 主循环

- `linenoise()`  
在大多数情况下，控制台应用程序都会具有相同的工作形式——在某个循环中不断读取输入的内容，然后解析再处理。`linenoise()` 是专门用来获取用户按键输入的函数，当回车键被按下后会返回完整的一行内容。因此可以用它来完成前面循环中的“读取”任务。
- `linenoiseFree()`  
必须调用此函数才能释放从 `linenoise()` 函数获取的命令行缓冲区。

### 提示和补全

- `linenoiseSetCompletionCallback()`  
当用户按下制表键时，`linenoise` 会调用 **补全回调函数**，该回调函数会检查当前已经输入的内容，然后调用 `linenoiseAddCompletion()` 函数来提供所有可能的补全后的命令列表。启用补全功能，需要事先调用 `linenoiseSetCompletionCallback()` 函数来注册补全回调函数。`console` 组件提供了一个现成的函数来为注册的命令提供补全功能 `esp_console_get_completion()`（见下文）。
- `linenoiseAddCompletion()`  
补全回调函数会通过调用此函数来通知 `linenoise` 库当前键入命令所有可能的补全结果。
- `linenoiseSetHintsCallback()`  
每当用户的输入改变时，`linenoise` 就会调用此回调函数，检查到目前为止输入的命令行内容，然后提供带有提示信息的字符串（例如命令参数列表），然后会在同一行上用不同的颜色显示出该文本。
- `linenoiseSetFreeHintsCallback()`  
如果 **提示回调函数** 返回的提示字符串是动态分配的或者需要以其它方式回收，就需要使用 `linenoiseSetFreeHintsCallback()` 注册具体的清理函数。

### 历史记录

- `linenoiseHistorySetMaxLen()`  
该函数设置要保留在内存中的最近输入的命令的数量。用户通过使用向上/向下箭头来导航历史记录。
- `linenoiseHistoryAdd()`  
`Linenoise` 不会自动向历史记录中添加命令，应用程序需要调用此函数来将命令字符串添加到历史记录中。

- `linenoiseHistorySave()`  
该函数将命令的历史记录从 RAM 中保存为文本文件，例如保存到 SD 卡或者 flash 的文件系统中。
- `linenoiseHistoryLoad()`  
与 `linenoiseHistorySave` 相对应，从文件中加载历史记录。
- `linenoiseHistoryFree()`  
释放在用于存储命令历史记录的内存。当使用完 `linenoise` 库后需要调用此函数。

### 将命令行拆分成参数列表

`console` 组件提供 `esp_console_split_argv()` 函数来将命令行字符串拆分为参数列表。该函数会返回参数的数量 (`argc`) 和一个指针数组，该指针数组可以作为 `argv` 参数传递给任何接受 `argc`, `argv` 格式参数的函数。

根据以下规则来将命令行拆分成参数列表：

- 参数由空格分隔
- 如果参数本身需要使用空格，可以使用 `\`（反斜杠）对它们进行转义
- 其它能被识别的转义字符有 `\\`（显示反斜杠本身）和 `\"`（显示双引号）
- 可以使用双引号来引用参数，引号只可能出现在参数的开头和结尾。参数中的引号必须如上所述进行转义。参数周围的引号会被 `esp_console_split_argv()` 函数删除

示例：

- `abc def 1 20 .3 > [ abc, def, 1, 20, .3 ]`
- `abc "123 456" def > [ abc, 123 456, def ]`
- ``a\ b\\c\" > [ a b\c" ]`

### 参数解析

对于参数解析，`console` 组件使用 `argtable3` 库。有关 `argtable3` 的介绍请查看 [教程](#) 或者 [Github 仓库](#) 中的 [示例代码](#)。

### 命令的注册与调度

`console` 组件包含了一些工具函数，用来注册命令，将用户输入的命令和已经注册的命令进行匹配，使用命令行输入的参数调用命令。

应用程序首先调用 `esp_console_init()` 来初始化命令注册模块，然后调用 `esp_console_cmd_register()` 函数注册命令处理程序。

对于每个命令，应用程序需要提供以下信息（需要以 `esp_console_cmd_t` 结构体的形式给出）：

- 命令名字（不含空格的字符串）
- 帮助文档，解释该命令的用途
- 可选的提示文本，列出命令的参数。如果应用程序使用 `Argtable3` 库来解析参数，则可以通过提供指向 `argtable` 参数定义结构体的指针来自动生成提示文本
- 命令处理函数（无上下文），或
- 命令处理函数（有上下文）。如要使用此函数，则必须在调用其他命令 **之前** 调用 `esp_console_cmd_set_context()` 初始化上下文。

---

**备注：** 使用接受上下文的命令处理函数或者不接受上下文的命令处理函数均可，但两者不能同时使用。如果使用接受上下文的命令处理程序函数，则必须调用 `esp_console_cmd_set_context()` 初始化上下文，否则该函数可能会访问未初始化的上下文。

---

命令注册模块还提供了其它函数：

- `esp_console_run()`  
该函数接受命令行字符串，使用 `esp_console_split_argv()` 函数将其拆分为 `argc/argv` 形式的参数列表，在已经注册的组件列表中查找命令，如果找到，则执行其对应的处理程序。

- `esp_console_register_help_command()`  
将 `help` 命令添加到已注册命令列表中，此命令将会以列表的方式打印所有注册的命令及其参数和帮助文本。
- `esp_console_get_completion()`  
与 `linenoise` 库中的 `linenoiseSetCompletionCallback()` 一同使用的回调函数，根据已经注册的命令列表为 `linenoise` 提供补全功能。
- `esp_console_get_hint()`  
与 `linenoise` 库中 `linenoiseSetHintsCallback()` 一同使用的回调函数，为 `linenoise` 提供已经注册的命令的参数提示功能。

## 初始化 REPL 环境

除了上述的各种函数，`console` 组件还提供了一些 API 来帮助创建一个基本的 REPL 环境。

在一个典型的 `console` 应用中，你只需要调用 `esp_console_new_repl_uart()`，它会为你初始化好构建在 UART 基础上的 REPL 环境，其中包括安装 UART 驱动，基本的 `console` 配置，创建一个新的线程来执行 REPL 任务，注册一些基本的命令（比如 `help` 命令）。

之后你可以使用 `esp_console_cmd_register()` 来注册其它命令。REPL 环境在初始化后需要再调用 `esp_console_start_repl()` 函数才能开始运行。

同样，如果 REPL 环境是构建在 `USB_SERIAL_JTAG` 设备基础上，你只需要先调用 `esp_console_new_repl_usb_serial_jtag()` 函数进行初始化，然后再照常调用其它函数。

## 应用程序示例

`system/console` 目录下提供了 `console` 组件的示例应用程序，展示了具体的使用方法。该示例介绍了如何初始化 UART 和 VFS 的功能，设置 `linenoise` 库，从 UART 中读取命令并加以处理，然后将历史命令存储到 flash 中。更多信息，请参阅示例代码目录中的 `README.md` 文件。

此外，ESP-IDF 还提供了众多基于 `console` 组件的示例程序，它们可以辅助应用程序的开发。例如，`peripherals/i2c/i2c_tools`，`wifi/iperf` 等等。

## API 参考

### Header File

- `components/console/esp_console.h`
- This header file can be included with:

```
#include "esp_console.h"
```

- This header file is a part of the API provided by the `console` component. To declare that your component depends on `console`, add the following to your `CMakeLists.txt`:

```
REQUIRES console
```

or

```
PRIV_REQUIRES console
```

### Functions

`esp_err_t esp_console_init (const esp_console_config_t *config)`

initialize console module

---

**备注:** Call this once before using other console module features

---

**参数** `config` -- console configuration

**返回**

- ESP\_OK on success
- ESP\_ERR\_NO\_MEM if out of memory
- ESP\_ERR\_INVALID\_STATE if already initialized
- ESP\_ERR\_INVALID\_ARG if the configuration is invalid

*esp\_err\_t* `esp_console_deinit` (void)

de-initialize console module

---

**备注:** Call this once when done using console module functions

---

**返回**

- ESP\_OK on success
- ESP\_ERR\_INVALID\_STATE if not initialized yet

*esp\_err\_t* `esp_console_cmd_register` (const *esp\_console\_cmd\_t* \*cmd)

Register console command.

---

**备注:** If the member `func_w_context` of `cmd` is set instead of `func`, then the member `context` is passed to the function pointed to by `func_w_context`.

---

**参数** `cmd` -- pointer to the command description; can point to a temporary value

**返回**

- ESP\_OK on success
- ESP\_ERR\_NO\_MEM if out of memory
- ESP\_ERR\_INVALID\_ARG if command description includes invalid arguments
- ESP\_ERR\_INVALID\_ARG if both `func` and `func_w_context` members of `cmd` are non-NULL
- ESP\_ERR\_INVALID\_ARG if both `func` and `func_w_context` members of `cmd` are NULL

*esp\_err\_t* `esp_console_run` (const char \*cmdline, int \*cmd\_ret)

Run command line.

**参数**

- `cmdline` -- command line (command name followed by a number of arguments)
- `cmd_ret` -- [out] return code from the command (set if command was run)

**返回**

- ESP\_OK, if command was run
- ESP\_ERR\_INVALID\_ARG, if the command line is empty, or only contained whitespace
- ESP\_ERR\_NOT\_FOUND, if command with given name wasn't registered
- ESP\_ERR\_INVALID\_STATE, if `esp_console_init` wasn't called

*size\_t* `esp_console_split_argv` (char \*line, char \*\*argv, *size\_t* argv\_size)

Split command line into arguments in place.

```
* - This function finds whitespace-separated arguments in the given input line.
*
*   'abc def 1 20 .3' -> [ 'abc', 'def', '1', '20', '.3' ]
*
* - Argument which include spaces may be surrounded with quotes. In this case
*   spaces are preserved and quotes are stripped.
*
```

(下页继续)



```

*      'abc "123 456" def' -> [ 'abc', '123 456', 'def' ]
*
* - Escape sequences may be used to produce backslash, double quote, and space:
*
*      'a\ b\\c\"' -> [ 'a b\c"' ]
*

```

**备注:** Pointers to at most `argv_size - 1` arguments are returned in `argv` array. The pointer after the last one (i.e. `argv[argc]`) is set to `NULL`.

#### 参数

- **line** -- pointer to buffer to parse; it is modified in place
- **argv** -- array where the pointers to arguments are written
- **argv\_size** -- number of elements in `argv_array` (max. number of arguments)

**返回** number of arguments found (`argc`)

void **esp\_console\_get\_completion** (const char \*buf, *linenoiseCompletions* \*lc)

Callback which provides command completion for linenoise library.

When using linenoise for line editing, command completion support can be enabled like this:

```
linenoiseSetCompletionCallback(&esp_console_get_completion);
```

#### 参数

- **buf** -- the string typed by the user
- **lc** -- *linenoiseCompletions* to be filled in

const char \***esp\_console\_get\_hint** (const char \*buf, int \*color, int \*bold)

Callback which provides command hints for linenoise library.

When using linenoise for line editing, hints support can be enabled as follows:

```
linenoiseSetHintsCallback((linenoiseHintsCallback*) &esp_console_get_hint);
```

The extra cast is needed because `linenoiseHintsCallback` is defined as returning a `char*` instead of `const char*`.

#### 参数

- **buf** -- line typed by the user
- **color** -- [out] ANSI color code to be used when displaying the hint
- **bold** -- [out] set to 1 if hint has to be displayed in bold

**返回** string containing the hint text. This string is persistent and should not be freed (i.e. `linenoiseSetFreeHintsCallback` should not be used).

*esp\_err\_t* **esp\_console\_register\_help\_command** (void)

Register a 'help' command.

Default 'help' command prints the list of registered commands along with hints and help strings if no additional argument is given. If an additional argument is given, the help command will look for a command with the same name and only print the hints and help strings of that command.

#### 返回

- `ESP_OK` on success
- `ESP_ERR_INVALID_STATE`, if `esp_console_init` wasn't called

*esp\_err\_t* **esp\_console\_new\_repl\_uart** (const *esp\_console\_dev\_uart\_config\_t* \*dev\_config, const *esp\_console\_repl\_config\_t* \*repl\_config, *esp\_console\_repl\_t* \*\*ret\_repl)

Establish a console REPL environment over UART driver.

**Attention** This function is meant to be used in the examples to make the code more compact. Applications which use console functionality should be based on the underlying `linenoise` and `esp_console` functions.

**备注:** This is an all-in-one function to establish the environment needed for REPL, includes:

- Install the UART driver on the console UART (8n1, 115200, REF\_TICK clock source)
- Configures the stdin/stdout to go through the UART driver
- Initializes `linenoise`
- Spawn new thread to run REPL in the background

#### 参数

- **dev\_config** -- **[in]** UART device configuration
- **repl\_config** -- **[in]** REPL configuration
- **ret\_repl** -- **[out]** return REPL handle after initialization succeed, return NULL otherwise

#### 返回

- ESP\_OK on success
- ESP\_FAIL Parameter error

*esp\_err\_t* `esp_console_new_repl_usb_serial_jtag` (const *esp\_console\_dev\_usb\_serial\_jtag\_config\_t* \*dev\_config, const *esp\_console\_repl\_config\_t* \*repl\_config, *esp\_console\_repl\_t* \*\*ret\_repl)

Establish a console REPL (Read-eval-print loop) environment over USB-SERIAL-JTAG.

**Attention** This function is meant to be used in the examples to make the code more compact. Applications which use console functionality should be based on the underlying `linenoise` and `esp_console` functions.

**备注:** This is an all-in-one function to establish the environment needed for REPL, includes:

- Initializes `linenoise`
- Spawn new thread to run REPL in the background

#### 参数

- **dev\_config** -- **[in]** USB-SERIAL-JTAG configuration
- **repl\_config** -- **[in]** REPL configuration
- **ret\_repl** -- **[out]** return REPL handle after initialization succeed, return NULL otherwise

#### 返回

- ESP\_OK on success
- ESP\_FAIL Parameter error

*esp\_err\_t* `esp_console_start_repl` (*esp\_console\_repl\_t* \*repl)

Start REPL environment.

**备注:** Once the REPL gets started, it won't be stopped until the user calls `repl->del(repl)` to destroy the REPL environment.

**参数** **repl** -- **[in]** REPL handle returned from `esp_console_new_repl_XXX`

#### 返回

- ESP\_OK on success
- ESP\_ERR\_INVALID\_STATE, if repl has started already



## Structures

struct **esp\_console\_config\_t**

Parameters for console initialization.

### Public Members

size\_t **max\_cmdline\_length**

length of command line buffer, in bytes

size\_t **max\_cmdline\_args**

maximum number of command line arguments to parse

uint32\_t **heap\_alloc\_caps**

where to (e.g. MALLOC\_CAP\_SPIRAM) allocate heap objects such as cmds used by esp\_console

int **hint\_color**

ASCII color code of hint text.

int **hint\_bold**

Set to 1 to print hint text in bold.

struct **esp\_console\_repl\_config\_t**

Parameters for console REPL (Read Eval Print Loop)

### Public Members

uint32\_t **max\_history\_len**

maximum length for the history

const char \***history\_save\_path**

file path used to save history commands, set to NULL won't save to file system

uint32\_t **task\_stack\_size**

repl task stack size

uint32\_t **task\_priority**

repl task priority

BaseType\_t **task\_core\_id**

repl task affinity, i.e. which core the task is pinned to

const char \***prompt**

prompt (NULL represents default: "esp> ")

size\_t **max\_cmdline\_length**

maximum length of a command line. If 0, default value will be used

struct **esp\_console\_dev\_uart\_config\_t**

Parameters for console device: UART.

### Public Members

int **channel**

UART channel number (count from zero)

int **baud\_rate**

Communication baud rate.

int **tx\_gpio\_num**

GPIO number for TX path, -1 means using default one.

int **rx\_gpio\_num**

GPIO number for RX path, -1 means using default one.

struct **esp\_console\_dev\_usb\_serial\_jtag\_config\_t**

Parameters for console device: USB-SERIAL-JTAG.

---

**备注:** It's an empty structure for now, reserved for future

---

struct **esp\_console\_cmd\_t**

Console command description.

### Public Members

const char \***command**

Command name. Must not be NULL, must not contain spaces. The pointer must be valid until the call to `esp_console_deinit`.

const char \***help**

Help text for the command, shown by help command. If set, the pointer must be valid until the call to `esp_console_deinit`. If not set, the command will not be listed in 'help' output.

const char \***hint**

Hint text, usually lists possible arguments. If set to NULL, and 'argtable' field is non-NULL, hint will be generated automatically

*esp\_console\_cmd\_func\_t* **func**

Pointer to a function which implements the command.

---

**备注:** : Setting both `func` and `func_w_context` is not allowed.

---

void \***argtable**

Array or structure of pointers to `arg_xxx` structures, may be NULL. Used to generate hint text if 'hint' is set to NULL. Array/structure which this field points to must end with an `arg_end`. Only used for the duration of `esp_console_cmd_register` call.

***esp\_console\_cmd\_func\_with\_context\_t* func\_w\_context**

Pointer to a context aware function which implements the command.

---

**备注:** : Setting both `func` and `func_w_context` is not allowed.

---

void **\*context**

Context pointer to user-defined per-command context data. This is used if context aware function `func_w_context` is set.

struct **esp\_console\_repl\_s**

Console REPL base structure.

### Public Members

*esp\_err\_t* (\*del)(*esp\_console\_repl\_t* \*repl)

Delete console REPL environment.

**Param repl [in]** REPL handle returned from `esp_console_new_repl_xxx`

**Return**

- ESP\_OK on success
- ESP\_FAIL on errors

### Macros

**ESP\_CONSOLE\_CONFIG\_DEFAULT** ()

Default console configuration value.

**ESP\_CONSOLE\_REPL\_CONFIG\_DEFAULT** ()

Default console repl configuration value.

**ESP\_CONSOLE\_DEV\_UART\_CONFIG\_DEFAULT** ()

**ESP\_CONSOLE\_DEV\_USB\_SERIAL\_JTAG\_CONFIG\_DEFAULT** ()

### Type Definitions

typedef struct *linenoiseCompletions* **linenoiseCompletions**

typedef int (\***esp\_console\_cmd\_func\_t**)(int argc, char \*\*argv)

Console command main function.

**Param argc** number of arguments

**Param argv** array with argc entries, each pointing to a zero-terminated string argument

**Return** console command return code, 0 indicates "success"

typedef int (\***esp\_console\_cmd\_func\_with\_context\_t**)(void \*context, int argc, char \*\*argv)

Console command main function, with context.

**Param context** a user context given at invocation

**Param argc** number of arguments

**Param argv** array with argc entries, each pointing to a zero-terminated string argument

**Return** console command return code, 0 indicates "success"

typedef struct *esp\_console\_repl\_s* **esp\_console\_repl\_t**

Type defined for console REPL.

## 2.10.7 eFuse Manager

### Introduction

The eFuse Manager library is designed to structure access to eFuse bits and make using these easy. This library operates eFuse bits by a structure name which is assigned in eFuse table. This sections introduces some concepts used by eFuse Manager.

### Hardware Description

The ESP32-H2 has a number of eFuses which can store system and user parameters. Each eFuse is a one-bit field which can be programmed to 1 after which it cannot be reverted back to 0. Some of system parameters are using these eFuse bits directly by hardware modules and have special place (for example EFUSE\_BLK0).

For more details, see **ESP32-H2 Technical Reference Manual > eFuse Controller (eFuse) [PDF]**. Some eFuse bits are available for user applications.

ESP32-H2 has 11 eFuse blocks each of the size of 256 bits (not all bits are available):

- EFUSE\_BLK0 is used entirely for system purposes;
- EFUSE\_BLK1 is used entirely for system purposes;
- EFUSE\_BLK2 is used entirely for system purposes;
- EFUSE\_BLK3 (also named EFUSE\_BLK\_USER\_DATA) can be used for user purposes;
- EFUSE\_BLK4 (also named EFUSE\_BLK\_KEY0) can be used as key (for secure\_boot or flash\_encryption) or for user purposes;
- EFUSE\_BLK5 (also named EFUSE\_BLK\_KEY1) can be used as key (for secure\_boot or flash\_encryption) or for user purposes;
- EFUSE\_BLK6 (also named EFUSE\_BLK\_KEY2) can be used as key (for secure\_boot or flash\_encryption) or for user purposes;
- EFUSE\_BLK7 (also named EFUSE\_BLK\_KEY3) can be used as key (for secure\_boot or flash\_encryption) or for user purposes;
- EFUSE\_BLK8 (also named EFUSE\_BLK\_KEY4) can be used as key (for secure\_boot or flash\_encryption) or for user purposes;
- EFUSE\_BLK9 (also named EFUSE\_BLK\_KEY5) can be used for any purpose except for flash encryption or ECDSA (due to a HW bug);
- EFUSE\_BLK10 (also named EFUSE\_BLK\_SYS\_DATA\_PART2) is reserved for system purposes.

Each block is divided into 8 32-bits registers.

### eFuse Manager Component

The component has API functions for reading and writing fields. Access to the fields is carried out through the structures that describe the location of the eFuse bits in the blocks. The component provides the ability to form fields of any length and from any number of individual bits. The description of the fields is made in a CSV file in a table form. To generate from a tabular form (CSV file) in the C-source uses the tool `efuse_table_gen.py`. The tool checks the CSV file for uniqueness of field names and bit intersection, in case of using a *custom* file from the user's project directory, the utility checks with the *common* CSV file.

CSV files:

- *common* (`esp_efuse_table.csv`) - contains eFuse fields which are used inside the ESP-IDF. C-source generation should be done manually when changing this file (run command `idf.py efuse-common-table`). Note that changes in this file can lead to incorrect operation.
- *custom* - (optional and can be enabled by `CONFIG_EFUSE_CUSTOM_TABLE`) contains eFuse fields that are used by the user in their application. C-source generation should be done manually when changing this file and running `idf.py efuse-custom-table`.

## Description CSV File

The CSV file contains a description of the eFuse fields. In the simple case, one field has one line of description. Table header:

```
# field_name, efuse_block(EFUSE_BLK0..EFUSE_BLK10), bit_start(0..255), bit_
↪count(1..256), comment
```

Individual params in CSV file the following meanings:

### field\_name

Name of field. The prefix *ESP\_EFUSE\_* is added to the name, and this field name is available in the code. This name is used to access the fields. The name must be unique for all fields. If the line has an empty name, then this line is combined with the previous field. This allows you to set an arbitrary order of bits in the field, and expand the field as well (see *MAC\_FACTORY* field in the common table). The field\_name supports structured format using *.* to show that the field belongs to another field (see *WR\_DIS* and *RD\_DIS* in the common table).

### efuse\_block

Block number. It determines where the eFuse bits are placed for this field. Available *EFUSE\_BLK0..EFUSE\_BLK10*.

### bit\_start

Start bit number (0..255). The bit\_start field can be omitted. In this case, it is set to bit\_start + bit\_count from the previous record, if it has the same efuse\_block. Otherwise (if efuse\_block is different, or this is the first entry), an error will be generated.

### bit\_count

The number of bits to use in this field (1..-). This parameter cannot be omitted. This field also may be *MAX\_BLK\_LEN* in this case, the field length has the maximum block length.

### comment

This param is using for comment field, it also move to C-header file. The comment field can be omitted.

If a non-sequential bit order is required to describe a field, then the field description in the following lines should be continued without specifying a name, indicating that it belongs to one field. For example two fields *MAC\_FACTORY* and *MAC\_FACTORY\_CRC*:

```
# Factory MAC address #
#####
MAC_FACTORY,          EFUSE_BLK0,    72,    8,    Factory MAC addr [0]
,                    EFUSE_BLK0,    64,    8,    Factory MAC addr [1]
,                    EFUSE_BLK0,    56,    8,    Factory MAC addr [2]
,                    EFUSE_BLK0,    48,    8,    Factory MAC addr [3]
,                    EFUSE_BLK0,    40,    8,    Factory MAC addr [4]
,                    EFUSE_BLK0,    32,    8,    Factory MAC addr [5]
MAC_FACTORY_CRC,     EFUSE_BLK0,    80,    8,    CRC8 for factory MAC address
```

This field is available in code as *ESP\_EFUSE\_MAC\_FACTORY* and *ESP\_EFUSE\_MAC\_FACTORY\_CRC*.

## Structured eFuse Fields

```
WR_DIS,                EFUSE_BLK0,    0,    32,    Write protection
WR_DIS.RD_DIS,        EFUSE_BLK0,    0,    1,    Write protection for↪
↪RD_DIS
WR_DIS.FIELD_1,       EFUSE_BLK0,    1,    1,    Write protection for↪
↪FIELD_1
WR_DIS.FIELD_2,       EFUSE_BLK0,    2,    4,    Write protection for↪
↪FIELD_2 (includes B1 and B2)
```

(下页继续)

(续上页)

WR_DIS.FIELD_2.B1, ↪FIELD_2.B1	EFUSE_BLK0,	2,	2,	Write protection for
WR_DIS.FIELD_2.B2, ↪FIELD_2.B2	EFUSE_BLK0,	4,	2,	Write protection for
WR_DIS.FIELD_3, ↪FIELD_3	EFUSE_BLK0,	5,	1,	Write protection for
WR_DIS.FIELD_3.ALIAS, ↪FIELD_3 (just a alias for WR_DIS.FIELD_3)	EFUSE_BLK0,	5,	1,	Write protection for
WR_DIS.FIELD_4, ↪FIELD_4	EFUSE_BLK0,	7,	1,	Write protection for

The structured eFuse field looks like `WR_DIS.RD_DIS` where the dot points that this field belongs to the parent field - `WR_DIS` and cannot be out of the parent's range.

It is possible to use some levels of structured fields as `WR_DIS.FIELD_2.B1` and `B2`. These fields should not be crossed each other and should be in the range of two fields: `WR_DIS` and `WR_DIS.FIELD_2`.

It is possible to create aliases for fields with the same range, see `WR_DIS.FIELD_3` and `WR_DIS.FIELD_3.ALIAS`.

The ESP-IDF names for structured eFuse fields should be unique. The `efuse_table_gen` tool generates the final names where the dot is replaced by `_`. The names for using in ESP-IDF are `ESP_EFUSE_WR_DIS`, `ESP_EFUSE_WR_DIS_RD_DIS`, `ESP_EFUSE_WR_DIS_FIELD_2_B1`, etc.

The `efuse_table_gen` tool checks that the fields do not overlap each other and must be within the range of a field if there is a violation, then throws the following error:

```
Field at USER_DATA, EFUSE_BLK3, 0, 256 intersected with SERIAL_NUMBER, EFUSE_
↪BLK3, 0, 32
```

**Solution:** Describe `SERIAL_NUMBER` to be included in `USER_DATA`. (`USER_DATA.SERIAL_NUMBER`).

```
Field at FIELD, EFUSE_BLK3, 0, 50 out of range FIELD.MAJOR_NUMBER, EFUSE_BLK3,
↪60, 32
```

**Solution:** Change `bit_start` for `FIELD.MAJOR_NUMBER` from 60 to 0, so `MAJOR_NUMBER` is in the `FIELD` range.

### efuse\_table\_gen.py Tool

The tool is designed to generate C-source files from CSV file and validate fields. First of all, the check is carried out on the uniqueness of the names and overlaps of the field bits. If an additional *custom* file is used, it will be checked with the existing *common* file (`esp_efuse_table.csv`). In case of errors, a message will be displayed and the string that caused the error. C-source files contain structures of type `esp_efuse_desc_t`.

To generate a *common* files, use the following command `idf.py efuse-common-table` or:

```
cd $IDF_PATH/components/efuse/
./efuse_table_gen.py --idf_target esp32h2 esp32h2/esp_efuse_table.csv
```

After generation in the folder `$IDF_PATH/components/efuse/esp32h2` create:

- `esp_efuse_table.c` file.
- In *include* folder `esp_efuse_table.c` file.

To generate a *custom* files, use the following command `idf.py efuse-custom-table` or:

```
cd $IDF_PATH/components/efuse/
./efuse_table_gen.py --idf_target esp32h2 esp32h2/esp_efuse_table.csv PROJECT_PATH/
↪main/esp_efuse_custom_table.csv
```

After generation in the folder `PROJECT_PATH/main` create:

- `esp_efuse_custom_table.c` file.
- In `include` folder `esp_efuse_custom_table.c` file.

To use the generated fields, you need to include two files:

```
#include "esp_efuse.h"
#include "esp_efuse_table.h" // or "esp_efuse_custom_table.h"
```

## Supported Coding Scheme

Coding schemes are used to protect against data corruption. ESP32-H2 supports two coding schemes:

- None. EFUSE\_BLK0 is stored with four backups, meaning each bit is stored four times. This backup scheme is automatically applied by the hardware and is not visible to software. EFUSE\_BLK0 can be written many times.
- RS. EFUSE\_BLK1 - EFUSE\_BLK10 use Reed-Solomon coding scheme that supports up to 5 bytes of automatic error correction. Software encodes the 32-byte EFUSE\_BLKx using RS (44, 32) to generate a 12-byte check code, and then burn the EFUSE\_BLKx and the check code into eFuse at the same time. The eFuse Controller automatically decodes the RS encoding and applies error correction when reading back the eFuse block. Because the RS check codes are generated across the entire 256-bit eFuse block, each block can only be written to one time.

To write some fields into one block, or different blocks in one time, you need to use the batch writing mode. Firstly set this mode through `esp_efuse_batch_write_begin()` function then write some fields as usual using the `esp_efuse_write_...` functions. At the end to burn them, call the `esp_efuse_batch_write_commit()` function. It burns prepared data to the eFuse blocks and disables the batch recording mode.

---

**备注:** If there is already pre-written data in the eFuse block using the Reed-Solomon encoding scheme, then it is not possible to write anything extra (even if the required bits are empty) without breaking the previous encoding data. This encoding data will be overwritten with new encoding data and completely destroyed (however, the payload eFuses are not damaged). It can be related to: CUSTOM\_MAC, SPI\_PAD\_CONFIG\_HD, SPI\_PAD\_CONFIG\_CS, etc. Please contact Espressif to order the required pre-burnt eFuses.

FOR TESTING ONLY (NOT RECOMMENDED): You can ignore or suppress errors that violate encoding scheme data in order to burn the necessary bits in the eFuse block.

---

## eFuse API

Access to the fields is via a pointer to the description structure. API functions have some basic operation:

- `esp_efuse_read_field_blob()` - returns an array of read eFuse bits.
- `esp_efuse_read_field_cnt()` - returns the number of bits programmed as "1".
- `esp_efuse_write_field_blob()` - writes an array.
- `esp_efuse_write_field_cnt()` - writes a required count of bits as "1".
- `esp_efuse_get_field_size()` - returns the number of bits by the field name.
- `esp_efuse_read_reg()` - returns value of eFuse register.
- `esp_efuse_write_reg()` - writes value to eFuse register.
- `esp_efuse_get_coding_scheme()` - returns eFuse coding scheme for blocks.
- `esp_efuse_read_block()` - reads key to eFuse block starting at the offset and the required size.
- `esp_efuse_write_block()` - writes key to eFuse block starting at the offset and the required size.
- `esp_efuse_batch_write_begin()` - set the batch mode of writing fields.
- `esp_efuse_batch_write_commit()` - writes all prepared data for batch writing mode and reset the batch writing mode.
- `esp_efuse_batch_write_cancel()` - reset the batch writing mode and prepared data.
- `esp_efuse_get_key_dis_read()` - Returns a read protection for the key block.
- `esp_efuse_set_key_dis_read()` - Sets a read protection for the key block.

- `esp_efuse_get_key_dis_write()` - Returns a write protection for the key block.
- `esp_efuse_set_key_dis_write()` - Sets a write protection for the key block.
- `esp_efuse_get_key_purpose()` - Returns the current purpose set for an eFuse key block.
- `esp_efuse_write_key()` - Programs a block of key data to an eFuse block
- `esp_efuse_write_keys()` - Programs keys to unused eFuse blocks
- `esp_efuse_find_purpose()` - Finds a key block with the particular purpose set.
- `esp_efuse_get_keypurpose_dis_write()` - Returns a write protection of the key purpose field for an eFuse key block (for esp32 always true).
- `esp_efuse_key_block_unused()` - Returns true if the key block is unused, false otherwise.
- `esp_efuse_destroy_block()` - Destroys the data in this eFuse block. There are two things to do (1) if write protection is not set, then the remaining unset bits are burned, (2) set read protection for this block if it is not locked.

For frequently used fields, special functions are made, like this `esp_efuse_get_pkg_ver()`.

### eFuse API for Keys

EFUSE\_BLK\_KEY0 - EFUSE\_BLK\_KEY5 are intended to keep up to 6 keys with a length of 256-bits. Each key has an ESP\_EFUSE\_KEY\_PURPOSE\_x field which defines the purpose of these keys. The purpose field is described in `esp_efuse_purpose_t`.

The purposes like ESP\_EFUSE\_KEY\_PURPOSE\_XTS\_AES... are used for flash encryption.

The purposes like ESP\_EFUSE\_KEY\_PURPOSE\_SECURE\_BOOT\_DIGEST... are used for secure boot.

There are some eFuse APIs useful to work with states of keys.

- `esp_efuse_get_purpose_field()` - Returns a pointer to a key purpose for an eFuse key block.
- `esp_efuse_get_key()` - Returns a pointer to a key block.
- `esp_efuse_set_key_purpose()` - Sets a key purpose for an eFuse key block.
- `esp_efuse_set_keypurpose_dis_write()` - Sets a write protection of the key purpose field for an eFuse key block.
- `esp_efuse_find_unused_key_block()` - Search for an unused key block and return the first one found.
- `esp_efuse_count_unused_key_blocks()` - Returns the number of unused eFuse key blocks in the range EFUSE\_BLK\_KEY0..EFUSE\_BLK\_KEY\_MAX
- `esp_efuse_get_digest_revoke()` - Returns the status of the Secure Boot public key digest revocation bit.
- `esp_efuse_set_digest_revoke()` - Sets the Secure Boot public key digest revocation bit.
- `esp_efuse_get_write_protect_of_digest_revoke()` - Returns a write protection of the Secure Boot public key digest revocation bit.
- `esp_efuse_set_write_protect_of_digest_revoke()` - Sets a write protection of the Secure Boot public key digest revocation bit.

### How to Add a New Field

1. Find a free bits for field. Show `esp_efuse_table.csv` file or run `idf.py show-efuse-table` or the next command:

```
$ ./efuse_table_gen.py -t IDF_TARGET_PATH_NAME esp32h2/esp_efuse_table.csv --info
Max number of bits in BLK 256
Parsing efuse CSV input file esp32c6/esp_efuse_table.csv ...
Verifying efuse table...
Sorted efuse table:
#           field_name           efuse_block      bit_start      _
↪bit_count
1           WR_DIS                 EFUSE_BLK0       0              _
↪32
```

(下页继续)



(续上页)

2	WR_DIS.RD_DIS	EFUSE_BLK0	0	└
↪1				
3	WR_DIS.DIS_ICACHE	EFUSE_BLK0	2	└
↪1				
4	WR_DIS.DIS_USB_JTAG	EFUSE_BLK0	2	└
↪1				
5	WR_DIS.POWERGLITCH_EN	EFUSE_BLK0	2	└
↪1				
6	WR_DIS.DIS_FORCE_DOWNLOAD	EFUSE_BLK0	2	└
↪1				
7	WR_DIS.SPI_DOWNLOAD_MSPI_DIS	EFUSE_BLK0	2	└
↪1				
8	WR_DIS.DIS_TWAI	EFUSE_BLK0	2	└
↪1				
9	WR_DIS.JTAG_SEL_ENABLE	EFUSE_BLK0	2	└
↪1				
10	WR_DIS.DIS_PAD_JTAG	EFUSE_BLK0	2	└
↪1				
11	WR_DIS.DIS_DOWNLOAD_MANUAL_ENCRYPT	EFUSE_BLK0	2	└
↪1				
12	WR_DIS.WDT_DELAY_SEL	EFUSE_BLK0	3	└
↪1				
13	WR_DIS.SPI_BOOT_CRYPT_CNT	EFUSE_BLK0	4	└
↪1				
14	WR_DIS.SECURE_BOOT_KEY_REVOKE0	EFUSE_BLK0	5	└
↪1				
15	WR_DIS.SECURE_BOOT_KEY_REVOKE1	EFUSE_BLK0	6	└
↪1				
16	WR_DIS.SECURE_BOOT_KEY_REVOKE2	EFUSE_BLK0	7	└
↪1				
17	WR_DIS.KEY_PURPOSE_0	EFUSE_BLK0	8	└
↪1				
18	WR_DIS.KEY_PURPOSE_1	EFUSE_BLK0	9	└
↪1				
19	WR_DIS.KEY_PURPOSE_2	EFUSE_BLK0	10	└
↪1				
20	WR_DIS.KEY_PURPOSE_3	EFUSE_BLK0	11	└
↪1				
21	WR_DIS.KEY_PURPOSE_4	EFUSE_BLK0	12	└
↪1				
22	WR_DIS.KEY_PURPOSE_5	EFUSE_BLK0	13	└
↪1				
23	WR_DIS.SEC_DPA_LEVEL	EFUSE_BLK0	14	└
↪1				
24	WR_DIS.CRYPT_DPA_ENABLE	EFUSE_BLK0	14	└
↪1				
25	WR_DIS.SECURE_BOOT_EN	EFUSE_BLK0	15	└
↪1				
26	WR_DIS.SECURE_BOOT_AGGRESSIVE_REVOKE	EFUSE_BLK0	16	└
↪1				
27	WR_DIS.ECDSA_FORCE_USE_HARDWARE_K	EFUSE_BLK0	17	└
↪1				
28	WR_DIS.FLASH_TPUW	EFUSE_BLK0	18	└
↪1				
29	WR_DIS.DIS_DOWNLOAD_MODE	EFUSE_BLK0	18	└
↪1				
30	WR_DIS.DIS_DIRECT_BOOT	EFUSE_BLK0	18	└
↪1				
31	WR_DIS.DIS_USB_SERIAL_JTAG_ROM_PRINT	EFUSE_BLK0	18	└
↪1				
32	WR_DIS.DIS_USB_SERIAL_JTAG_DOWNLOAD_MODE	EFUSE_BLK0	18	└
↪1				

(下页继续)

(续上页)

33	WR_DIS.ENABLE_SECURITY_DOWNLOAD	EFUSE_BLK0	18	↪
↪1				
34	WR_DIS.UART_PRINT_CONTROL	EFUSE_BLK0	18	↪
↪1				
35	WR_DIS.FORCE_SEND_RESUME	EFUSE_BLK0	18	↪
↪1				
36	WR_DIS.SECURE_VERSION	EFUSE_BLK0	18	↪
↪1				
37	WR_DIS.SECURE_BOOT_DISABLE_FAST_WAKE	EFUSE_BLK0	18	↪
↪1				
38	WR_DIS.HYS_EN_PAD0	EFUSE_BLK0	19	↪
↪1				
39	WR_DIS.HYS_EN_PAD1	EFUSE_BLK0	19	↪
↪1				
40	WR_DIS.BLK1	EFUSE_BLK0	20	↪
↪1				
41	WR_DIS.MAC	EFUSE_BLK0	20	↪
↪1				
42	WR_DIS.MAC_EXT	EFUSE_BLK0	20	↪
↪1				
43	WR_DIS.WAFER_VERSION_MINOR	EFUSE_BLK0	20	↪
↪1				
44	WR_DIS.WAFER_VERSION_MAJOR	EFUSE_BLK0	20	↪
↪1				
45	WR_DIS.DISABLE_WAFER_VERSION_MAJOR	EFUSE_BLK0	20	↪
↪1				
46	WR_DIS.FLASH_CAP	EFUSE_BLK0	20	↪
↪1				
47	WR_DIS.FLASH_TEMP	EFUSE_BLK0	20	↪
↪1				
48	WR_DIS.FLASH_VENDOR	EFUSE_BLK0	20	↪
↪1				
49	WR_DIS.PKG_VERSION	EFUSE_BLK0	20	↪
↪1				
50	WR_DIS.SYS_DATA_PART1	EFUSE_BLK0	21	↪
↪1				
51	WR_DIS.OPTIONAL_UNIQUE_ID	EFUSE_BLK0	21	↪
↪1				
52	WR_DIS.BLK_VERSION_MINOR	EFUSE_BLK0	21	↪
↪1				
53	WR_DIS.BLK_VERSION_MAJOR	EFUSE_BLK0	21	↪
↪1				
54	WR_DIS.DISABLE_BLK_VERSION_MAJOR	EFUSE_BLK0	21	↪
↪1				
55	WR_DIS.BLOCK_USR_DATA	EFUSE_BLK0	22	↪
↪1				
56	WR_DIS.CUSTOM_MAC	EFUSE_BLK0	22	↪
↪1				
57	WR_DIS.BLOCK_KEY0	EFUSE_BLK0	23	↪
↪1				
58	WR_DIS.BLOCK_KEY1	EFUSE_BLK0	24	↪
↪1				
59	WR_DIS.BLOCK_KEY2	EFUSE_BLK0	25	↪
↪1				
60	WR_DIS.BLOCK_KEY3	EFUSE_BLK0	26	↪
↪1				
61	WR_DIS.BLOCK_KEY4	EFUSE_BLK0	27	↪
↪1				
62	WR_DIS.BLOCK_KEY5	EFUSE_BLK0	28	↪
↪1				
63	WR_DIS.BLOCK_SYS_DATA2	EFUSE_BLK0	29	↪
↪1				

(下页继续)

(续上页)

64	WR_DIS.USB_EXCHG_PINS	EFUSE_BLK0	30	└
↔1				
65	WR_DIS.VDD_SPI_AS_GPIO	EFUSE_BLK0	30	└
↔1				
66	WR_DIS.SOFT_DIS_JTAG	EFUSE_BLK0	31	└
↔1				
67	RD_DIS	EFUSE_BLK0	32	└
↔7				
68	RD_DIS.BLOCK_KEY0	EFUSE_BLK0	32	└
↔1				
69	RD_DIS.BLOCK_KEY1	EFUSE_BLK0	33	└
↔1				
70	RD_DIS.BLOCK_KEY2	EFUSE_BLK0	34	└
↔1				
71	RD_DIS.BLOCK_KEY3	EFUSE_BLK0	35	└
↔1				
72	RD_DIS.BLOCK_KEY4	EFUSE_BLK0	36	└
↔1				
73	RD_DIS.BLOCK_KEY5	EFUSE_BLK0	37	└
↔1				
74	RD_DIS.BLOCK_SYS_DATA2	EFUSE_BLK0	38	└
↔1				
75	DIS_ICACHE	EFUSE_BLK0	40	└
↔1				
76	DIS_USB_JTAG	EFUSE_BLK0	41	└
↔1				
77	POWERGLITCH_EN	EFUSE_BLK0	42	└
↔1				
78	DIS_FORCE_DOWNLOAD	EFUSE_BLK0	44	└
↔1				
79	SPI_DOWNLOAD_MSPI_DIS	EFUSE_BLK0	45	└
↔1				
80	DIS_TWAI	EFUSE_BLK0	46	└
↔1				
81	JTAG_SEL_ENABLE	EFUSE_BLK0	47	└
↔1				
82	SOFT_DIS_JTAG	EFUSE_BLK0	48	└
↔3				
83	DIS_PAD_JTAG	EFUSE_BLK0	51	└
↔1				
84	DIS_DOWNLOAD_MANUAL_ENCRYPT	EFUSE_BLK0	52	└
↔1				
85	USB_EXCHG_PINS	EFUSE_BLK0	57	└
↔1				
86	VDD_SPI_AS_GPIO	EFUSE_BLK0	58	└
↔1				
87	WDT_DELAY_SEL	EFUSE_BLK0	80	└
↔2				
88	SPI_BOOT_CRYPT_CNT	EFUSE_BLK0	82	└
↔3				
89	SECURE_BOOT_KEY_REVOKE0	EFUSE_BLK0	85	└
↔1				
90	SECURE_BOOT_KEY_REVOKE1	EFUSE_BLK0	86	└
↔1				
91	SECURE_BOOT_KEY_REVOKE2	EFUSE_BLK0	87	└
↔1				
92	KEY_PURPOSE_0	EFUSE_BLK0	88	└
↔4				
93	KEY_PURPOSE_1	EFUSE_BLK0	92	└
↔4				
94	KEY_PURPOSE_2	EFUSE_BLK0	96	└
↔4				

(下页继续)

(续上页)

95	KEY_PURPOSE_3	EFUSE_BLK0	100	↔
↔4				
96	KEY_PURPOSE_4	EFUSE_BLK0	104	↔
↔4				
97	KEY_PURPOSE_5	EFUSE_BLK0	108	↔
↔4				
98	SEC_DPA_LEVEL	EFUSE_BLK0	112	↔
↔2				
99	ECDSA_FORCE_USE_HARDWARE_K	EFUSE_BLK0	114	↔
↔1				
100	CRYPT_DPA_ENABLE	EFUSE_BLK0	115	↔
↔1				
101	SECURE_BOOT_EN	EFUSE_BLK0	116	↔
↔1				
102	SECURE_BOOT_AGGRESSIVE_REVOKE	EFUSE_BLK0	117	↔
↔1				
103	FLASH_TPUW	EFUSE_BLK0	124	↔
↔4				
104	DIS_DOWNLOAD_MODE	EFUSE_BLK0	128	↔
↔1				
105	DIS_DIRECT_BOOT	EFUSE_BLK0	129	↔
↔1				
106	DIS_USB_SERIAL_JTAG_ROM_PRINT	EFUSE_BLK0	130	↔
↔1				
107	DIS_USB_SERIAL_JTAG_DOWNLOAD_MODE	EFUSE_BLK0	132	↔
↔1				
108	ENABLE_SECURITY_DOWNLOAD	EFUSE_BLK0	133	↔
↔1				
109	UART_PRINT_CONTROL	EFUSE_BLK0	134	↔
↔2				
110	FORCE_SEND_RESUME	EFUSE_BLK0	136	↔
↔1				
111	SECURE_VERSION	EFUSE_BLK0	137	↔
↔16				
112	SECURE_BOOT_DISABLE_FAST_WAKE	EFUSE_BLK0	153	↔
↔1				
113	HYS_EN_PAD0	EFUSE_BLK0	154	↔
↔6				
114	HYS_EN_PAD1	EFUSE_BLK0	160	↔
↔22				
115	MAC	EFUSE_BLK1	0	↔
↔8				
116	MAC	EFUSE_BLK1	8	↔
↔8				
117	MAC	EFUSE_BLK1	16	↔
↔8				
118	MAC	EFUSE_BLK1	24	↔
↔8				
119	MAC	EFUSE_BLK1	32	↔
↔8				
120	MAC	EFUSE_BLK1	40	↔
↔8				
121	MAC_EXT	EFUSE_BLK1	48	↔
↔16				
122	WAFER_VERSION_MINOR	EFUSE_BLK1	114	↔
↔3				
123	WAFER_VERSION_MAJOR	EFUSE_BLK1	117	↔
↔2				
124	DISABLE_WAFER_VERSION_MAJOR	EFUSE_BLK1	119	↔
↔1				
125	FLASH_CAP	EFUSE_BLK1	120	↔
↔3				

(下页继续)

(续上页)

126	FLASH_TEMP	EFUSE_BLK1	123	└
↔2				
127	FLASH_VENDOR	EFUSE_BLK1	125	└
↔3				
128	PKG_VERSION	EFUSE_BLK1	128	└
↔3				
129	SYS_DATA_PART2	EFUSE_BLK10	0	└
↔256				
130	OPTIONAL_UNIQUE_ID	EFUSE_BLK2	0	└
↔128				
131	BLK_VERSION_MINOR	EFUSE_BLK2	130	└
↔3				
132	BLK_VERSION_MAJOR	EFUSE_BLK2	133	└
↔2				
133	DISABLE_BLK_VERSION_MAJOR	EFUSE_BLK2	135	└
↔1				
134	USER_DATA	EFUSE_BLK3	0	└
↔256				
135	USER_DATA.MAC_CUSTOM	EFUSE_BLK3	200	└
↔48				
136	KEY0	EFUSE_BLK4	0	└
↔256				
137	KEY1	EFUSE_BLK5	0	└
↔256				
138	KEY2	EFUSE_BLK6	0	└
↔256				
139	KEY3	EFUSE_BLK7	0	└
↔256				
140	KEY4	EFUSE_BLK8	0	└
↔256				
141	KEY5	EFUSE_BLK9	0	└
↔256				

Used bits in efuse table:

EFUSE\_BLK0  
 [0 31] [0 0] [2 2] ... [21 22] [22 30] [30 38] [32 38] [40 42] [44 52] [57 58] [80└  
 ↔117] [124 130] [132 181]

EFUSE\_BLK1  
 [0 63] [114 130]

EFUSE\_BLK10  
 [0 255]

EFUSE\_BLK2  
 [0 127] [130 135]

EFUSE\_BLK3  
 [0 255] [200 247]

EFUSE\_BLK4  
 [0 255]

EFUSE\_BLK5  
 [0 255]

EFUSE\_BLK6  
 [0 255]

EFUSE\_BLK7  
 [0 255]

EFUSE\_BLK8  
 [0 255]

EFUSE\_BLK9  
 [0 255]

Note: Not printed ranges are free for using. (bits in EFUSE\_BLK0 are reserved for└  
 ↔Espressif)

The number of bits not included in square brackets is free (some bits are reserved for Espressif). All fields are checked for overlapping.

To add fields to an existing field, use the *Structured efuse fields* technique. For example, adding the fields: SERIAL\_NUMBER, MODEL\_NUMBER and HARDWARE\_REV to an existing USER\_DATA field. Use . (dot) to show an attachment in a field.

USER_DATA.SERIAL_NUMBER,	EFUSE_BLK3,	0,	32,
USER_DATA.MODEL_NUMBER,	EFUSE_BLK3,	32,	10,
USER_DATA.HARDWARE_REV,	EFUSE_BLK3,	42,	10,

2. Fill a line for field: field\_name, efuse\_block, bit\_start, bit\_count, comment.
3. Run a show\_efuse\_table command to check eFuse table. To generate source files run efuse\_common\_table or efuse\_custom\_table command.

You may get errors such as intersects with or out of range. Please see how to solve them in the *Structured efuse fields* article.

## Bit Order

The eFuses bit order is little endian (see the example below), it means that eFuse bits are read and written from LSB to MSB:

```
$ espefuse.py dump

USER_DATA      (BLOCK3      ) [3 ] read_regs: 03020100 07060504 0B0A0908_
↳0F0E0D0C 13121111 17161514 1B1A1918 1F1E1D1C
BLOCK4        (BLOCK4      ) [4 ] read_regs: 03020100 07060504 0B0A0908_
↳0F0E0D0C 13121111 17161514 1B1A1918 1F1E1D1C

where is the register representation:

EFUSE_RD_USR_DATA0_REG = 0x03020100
EFUSE_RD_USR_DATA1_REG = 0x07060504
EFUSE_RD_USR_DATA2_REG = 0x0B0A0908
EFUSE_RD_USR_DATA3_REG = 0x0F0E0D0C
EFUSE_RD_USR_DATA4_REG = 0x13121111
EFUSE_RD_USR_DATA5_REG = 0x17161514
EFUSE_RD_USR_DATA6_REG = 0x1B1A1918
EFUSE_RD_USR_DATA7_REG = 0x1F1E1D1C

where is the byte representation:

byte[0] = 0x00, byte[1] = 0x01, ... byte[3] = 0x03, byte[4] = 0x04, ..., byte[31]_
↳= 0x1F
```

For example, csv file describes the USER\_DATA field, which occupies all 256 bits (a whole block).

USER_DATA,	EFUSE_BLK3,	0,	256,	User data
USER_DATA.FIELD1,	EFUSE_BLK3,	16,	16,	Field1
ID,	EFUSE_BLK4,	8,	3,	ID bit[0..2]
,	EFUSE_BLK4,	16,	2,	ID bit[3..4]
,	EFUSE_BLK4,	32,	3,	ID bit[5..7]

Thus, reading the eFuse USER\_DATA block written as above gives the following results:

```
uint8_t buf[32] = { 0 };
esp_efuse_read_field_blob(ESP_EFUSE_USER_DATA, &buf, sizeof(buf) * 8);
// buf[0] = 0x00, buf[1] = 0x01, ... buf[31] = 0x1F

uint32_t field1 = 0;
size_t field1_size = ESP_EFUSE_USER_DATA[0]->bit_count; // can be used for this_
↳case because it only consists of one entry
```

(下页继续)

```

esp_efuse_read_field_blob(ESP_EFUSE_USER_DATA, &field1, field1_size);
// field1 = 0x0302

uint32_t field1_1 = 0;
esp_efuse_read_field_blob(ESP_EFUSE_USER_DATA, &field1_1, 2); // reads only first_
↳2 bits
// field1 = 0x0002

uint8_t id = 0;
size_t id_size = esp_efuse_get_field_size(ESP_EFUSE_ID); // returns 6
// size_t id_size = ESP_EFUSE_USER_DATA[0]->bit_count; // cannot be used because_
↳it consists of 3 entries. It returns 3 not 6.
esp_efuse_read_field_blob(ESP_EFUSE_ID, &id, id_size);
// id = 0x91
// b'100 10 001
//   [3] [2] [3]

uint8_t id_1 = 0;
esp_efuse_read_field_blob(ESP_EFUSE_ID, &id_1, 3);
// id = 0x01
// b'001

```

### Get eFuses During Build

There is a way to get the state of eFuses at the build stage of the project. There are two cmake functions for this:

- `espefuse_get_json_summary()` - It calls the `espefuse.py summary --format json` command and returns a json string (it is not stored in a file).
- `espefuse_get_efuse()` - It finds a given eFuse name in the json string and returns its property.

The json string has the following properties:

```

{
  "MAC": {
    "bit_len": 48,
    "block": 0,
    "category": "identity",
    "description": "Factory MAC Address",
    "efuse_type": "bytes:6",
    "name": "MAC",
    "pos": 0,
    "readable": true,
    "value": "94:b9:7e:5a:6e:58 (CRC 0xe2 OK)",
    "word": 1,
    "writeable": true
  },
}

```

These functions can be used from a top-level project `CMakeLists.txt` ([get-started/hello\\_world/CMakeLists.txt](#)):

```

# ...
project(hello_world)

espefuse_get_json_summary(efuse_json)
espefuse_get_efuse(ret_data ${efuse_json} "MAC" "value")
message("MAC:" ${ret_data})

```

The format of the value property is the same as shown in `espefuse.py summary`.

```
MAC:94:b9:7e:5a:6e:58 (CRC 0xe2 OK)
```

There is an example test `system/efuse/CMakeLists.txt` which adds a custom target `efuse-summary`. This allows you to run the `idf.py efuse-summary` command to read the required eFuses (specified in the `efuse_names` list) at any time, not just at project build time.

## Debug eFuse & Unit Tests

**Virtual eFuses** The Kconfig option `CONFIG_EFUSE_VIRTUAL` virtualizes eFuse values inside the eFuse Manager, so writes are emulated and no eFuse values are permanently changed. This can be useful for debugging app and unit tests. During startup, the eFuses are copied to RAM. All eFuse operations (read and write) are performed with RAM instead of the real eFuse registers.

In addition to the `CONFIG_EFUSE_VIRTUAL` option there is `CONFIG_EFUSE_VIRTUAL_KEEP_IN_FLASH` option that adds a feature to keep eFuses in flash memory. To use this mode the `partition_table` should have the `efuse` partition. `partition.csv`: `"efuse_em, data, efuse, , 0x2000,"`. During startup, the eFuses are copied from flash or, in case if flash is empty, from real eFuse to RAM and then update flash. This option allows keeping eFuses after reboots (possible to test `secure_boot` and `flash_encryption` features with this option).

**Flash Encryption Testing** Flash Encryption (FE) is a hardware feature that requires the physical burning of eFuses: `key` and `FLASH_CRYPT_CNT`. If FE is not actually enabled then enabling the `CONFIG_EFUSE_VIRTUAL_KEEP_IN_FLASH` option just gives testing possibilities and does not encrypt anything in the flash, even though the logs say encryption happens. The `bootloader_flash_write()` is adapted for this purpose. But if FE is already enabled on the chip and you run an application or bootloader created with the `CONFIG_EFUSE_VIRTUAL_KEEP_IN_FLASH` option then the flash encryption/decryption operations will work properly (data are encrypted as it is written into an encrypted flash partition and decrypted when they are read from an encrypted partition).

**espefuse.py** `esptool` includes a useful tool for reading/writing ESP32-H2 eFuse bits - `espefuse.py`.

```
espefuse.py -p PORT summary

espefuse.py v4.6-dev
Connecting....
Detecting chip type... ESP32-H2

=== Run "summary" command ===
EFUSE_NAME (Block) Description = [Meaningful Value] [Readable/Writeable] (Hex↵
↵Value)
-----
↵-----
Config fuses:
WR_DIS (BLOCK0)                               Disable programming of↵
↵individual eFuses                            = 0 R/W (0x00000000)
RD_DIS (BLOCK0)                               Disable reading from BLOCK4-10 ↵
↵                                             = 0 R/W (0b00000000)
DIS_ICACHE (BLOCK0)                           Represents whether icache is↵
↵disabled or enabled. = False R/W (0b0)      1: disabled. 0: enabled
POWERGLITCH_EN (BLOCK0)                       Represents whether power glitch↵
↵function is enable = False R/W (0b0)       d. 1: enabled. 0: disabled
DIS_TWAI (BLOCK0)                             Represents whether TWAI↵
↵function is disabled or en = False R/W (0b0)  abled. 1: disabled. 0: enabled
DIS_DIRECT_BOOT (BLOCK0)                     Represents whether direct boot↵
↵mode is disabled or = False R/W (0b0)     enabled. 1: disabled. 0:↵
↵enabled
UART_PRINT_CONTROL (BLOCK0)                   Set the default UARTboot↵
↵message output mode = Enable R/W (0b00)
```

(下页继续)





DIS_PAD_JTAG (BLOCK0) ↪disabled in the hard wa = False R/W (0b0)  ↪enabled	Represents whether JTAG is y(permanently). 1: disabled. 0:
Mac fuses: MAC (BLOCK1) = 60:55:f9:f7:2c:a2:ff:fe (OK) R/W MAC_EXT (BLOCK1) ↪address = ff:fe (OK) R/W CUSTOM_MAC (BLOCK3) = 00:00:00:00:00:00:ff:fe (OK) R/W	MAC address  Stores the extended bits of MAC  Custom MAC
Security fuses: DIS_FORCE_DOWNLOAD (BLOCK0) ↪that forces chip i = False R/W (0b0)  ↪or enabled. 1: disab	Represents whether the function nto download mode is disabled  led. 0: enabled
SPI_DOWNLOAD_MSPI_DIS (BLOCK0) ↪controller during boot_mod = False R/W (0b0)  ↪enabled. 1: disabled. 0:	Represents whether SPI0 e_download is disabled or  enabled
DIS_DOWNLOAD_MANUAL_ENCRYPT (BLOCK0) ↪encrypt function is disab = False R/W (0b0)  ↪boot mode). 1: disable	Represents whether flash led or enabled(except in SPI  ed. 0: enabled
SPI_BOOT_CRYPT_CNT (BLOCK0) ↪or 3 bits are set = Disable R/W (0b000)	Enables flash encryption when 1 and disables otherwise
SECURE_BOOT_KEY_REVOKE0 (BLOCK0) ↪ = False R/W (0b0)	Revoke 1st secure boot key
SECURE_BOOT_KEY_REVOKE1 (BLOCK0) ↪ = False R/W (0b0)	Revoke 2nd secure boot key
SECURE_BOOT_KEY_REVOKE2 (BLOCK0) ↪ = False R/W (0b0)	Revoke 3rd secure boot key
KEY_PURPOSE_0 (BLOCK0) ↪ = USER R/W (0x0)	Represents the purpose of Key0
KEY_PURPOSE_1 (BLOCK0) ↪ = USER R/W (0x0)	Represents the purpose of Key1
KEY_PURPOSE_2 (BLOCK0) ↪ = USER R/W (0x0)	Represents the purpose of Key2
KEY_PURPOSE_3 (BLOCK0) ↪ = USER R/W (0x0)	Represents the purpose of Key3
KEY_PURPOSE_4 (BLOCK0) ↪ = USER R/W (0x0)	Represents the purpose of Key4
KEY_PURPOSE_5 (BLOCK0) ↪ = USER R/W (0x0)	Represents the purpose of Key5
SEC_DPA_LEVEL (BLOCK0) ↪by configuring the = 0 R/W (0b00)	Represents the spa secure level  clock random divide mode
ECDSA_FORCE_USE_HARDWARE_K (BLOCK0) ↪random number k is for = False R/W (0b0)  ↪used. 0: not force use	Represents whether hardware ced used in ESDCA. 1: force  d
CRYPT_DPA_ENABLE (BLOCK0) ↪attack is enabled. 1:e = False R/W (0b0)	Represents whether anti-dpa nabled. 0: disabled



DIS_USB_SERIAL_JTAG_ROM_PRINT (BLOCK0) ↪Serial-JTAG print duri = False R/W (0b0)	. 1: exchanged. 0: not exchanged Set this bit to disable USB- ng rom boot
DIS_USB_SERIAL_JTAG_DOWNLOAD_MODE (BLOCK0) ↪Serial-JTAG download fu = False R/W (0b0)	Represents whether the USB- nction is disabled or enabled.
↪1: disabled. 0: ena	bled
Vdd fuses: VDD_SPI_AS_GPIO (BLOCK0) ↪is functioned as gp = False R/W (0b0)	Represents whether vdd spi pin io. 1: functioned. 0: not
↪functioned	
Wdt fuses: WDT_DELAY_SEL (BLOCK0) ↪timeout threshold = 0 R/W (0b00)	Represents whether RTC watchdog is selected at startup. 1:
↪selected. 0: not select	ed

To get a dump for all eFuse registers.

```

espefuse.py -p PORT dump

espefuse.py dump
espefuse.py v4.6-dev
Connecting....
Detecting chip type... ESP32-H2
BLOCK0 ( ) [0 ] read_regs: 00000000 00000000 00000000
↪00000000 00000000 00000000
MAC_SPI_8M_0 (BLOCK1 ) [1 ] read_regs: f9f72ca2 fffe6055 00000000
↪00000000 00000000 00000000
BLOCK_SYS_DATA (BLOCK2 ) [2 ] read_regs: 00000000 00000000 00000000
↪00000000 00000000 00000000 00000000 00000000
BLOCK_USR_DATA (BLOCK3 ) [3 ] read_regs: 00000000 00000000 00000000
↪00000000 00000000 00000000 00000000 00000000
BLOCK_KEY0 (BLOCK4 ) [4 ] read_regs: 00000000 00000000 00000000
↪00000000 00000000 00000000 00000000 00000000
BLOCK_KEY1 (BLOCK5 ) [5 ] read_regs: 00000000 00000000 00000000
↪00000000 00000000 00000000 00000000 00000000
BLOCK_KEY2 (BLOCK6 ) [6 ] read_regs: 00000000 00000000 00000000
↪00000000 00000000 00000000 00000000 00000000
BLOCK_KEY3 (BLOCK7 ) [7 ] read_regs: 00000000 00000000 00000000
↪00000000 00000000 00000000 00000000 00000000
BLOCK_KEY4 (BLOCK8 ) [8 ] read_regs: 00000000 00000000 00000000
↪00000000 00000000 00000000 00000000 00000000
BLOCK_KEY5 (BLOCK9 ) [9 ] read_regs: 00000000 00000000 00000000
↪00000000 00000000 00000000 00000000 00000000
BLOCK_SYS_DATA2 (BLOCK10 ) [10] read_regs: 00000000 00000000 00000000
↪00000000 00000000 00000000 00000000 00000000

BLOCK0 ( ) [0 ] err__regs: 00000000 00000000 00000000
↪00000000 00000000 00000000
EFUSE_RD_RS_ERR0_REG 0x00000000
EFUSE_RD_RS_ERR1_REG 0x00000000

=== Run "dump" command ===

```

## Header File

- [components/efuse/esp32h2/include/esp\\_efuse\\_chip.h](#)
- This header file can be included with:

```
#include "esp_efuse_chip.h"
```

- This header file is a part of the API provided by the `efuse` component. To declare that your component depends on `efuse`, add the following to your `CMakeLists.txt`:

```
REQUIRES efuse
```

or

```
PRIV_REQUIRES efuse
```

## Enumerations

enum **esp\_efuse\_block\_t**

Type of eFuse blocks ESP32H2.

*Values:*

enumerator **EFUSE\_BLK0**

Number of eFuse BLOCK0. REPEAT\_DATA

enumerator **EFUSE\_BLK1**

Number of eFuse BLOCK1. MAC\_SPI\_8M\_SYS

enumerator **EFUSE\_BLK2**

Number of eFuse BLOCK2. SYS\_DATA\_PART1

enumerator **EFUSE\_BLK\_SYS\_DATA\_PART1**

Number of eFuse BLOCK2. SYS\_DATA\_PART1

enumerator **EFUSE\_BLK3**

Number of eFuse BLOCK3. USER\_DATA

enumerator **EFUSE\_BLK\_USER\_DATA**

Number of eFuse BLOCK3. USER\_DATA

enumerator **EFUSE\_BLK4**

Number of eFuse BLOCK4. KEY0

enumerator **EFUSE\_BLK\_KEY0**

Number of eFuse BLOCK4. KEY0

enumerator **EFUSE\_BLK5**

Number of eFuse BLOCK5. KEY1

enumerator **EFUSE\_BLK\_KEY1**

Number of eFuse BLOCK5. KEY1

enumerator **EFUSE\_BLK6**

Number of eFuse BLOCK6. KEY2

enumerator **EFUSE\_BLK\_KEY2**

Number of eFuse BLOCK6. KEY2

enumerator **EFUSE\_BLK7**

Number of eFuse BLOCK7. KEY3

enumerator **EFUSE\_BLK\_KEY3**

Number of eFuse BLOCK7. KEY3

enumerator **EFUSE\_BLK8**

Number of eFuse BLOCK8. KEY4

enumerator **EFUSE\_BLK\_KEY4**

Number of eFuse BLOCK8. KEY4

enumerator **EFUSE\_BLK9**

Number of eFuse BLOCK9. KEY5

enumerator **EFUSE\_BLK\_KEY5**

Number of eFuse BLOCK9. KEY5

enumerator **EFUSE\_BLK\_KEY\_MAX**

enumerator **EFUSE\_BLK10**

Number of eFuse BLOCK10. SYS\_DATA\_PART2

enumerator **EFUSE\_BLK\_SYS\_DATA\_PART2**

Number of eFuse BLOCK10. SYS\_DATA\_PART2

enumerator **EFUSE\_BLK\_MAX**

enum **esp\_efuse\_coding\_scheme\_t**

Type of coding scheme.

*Values:*

enumerator **EFUSE\_CODING\_SCHEME\_NONE**

None

enumerator **EFUSE\_CODING\_SCHEME\_RS**

Reed-Solomon coding

enum **esp\_efuse\_purpose\_t**

Type of key purpose.

*Values:*

enumerator **ESP\_EFUSE\_KEY\_PURPOSE\_USER**

User purposes (software-only use)

enumerator **ESP\_EFUSE\_KEY\_PURPOSE\_ECDSA\_KEY**

ECDSA private key (Expected in little endian order)

enumerator **ESP\_EFUSE\_KEY\_PURPOSE\_RESERVED**

Reserved (Used as a place holder)

enumerator **ESP\_EFUSE\_KEY\_PURPOSE\_XTS\_AES\_128\_KEY**

XTS\_AES\_128\_KEY (flash/PSRAM encryption)

enumerator **ESP\_EFUSE\_KEY\_PURPOSE\_HMAC\_DOWN\_ALL**

HMAC Downstream mode

enumerator **ESP\_EFUSE\_KEY\_PURPOSE\_HMAC\_DOWN\_JTAG**

JTAG soft enable key (uses HMAC Downstream mode)

enumerator **ESP\_EFUSE\_KEY\_PURPOSE\_HMAC\_DOWN\_DIGITAL\_SIGNATURE**

Digital Signature peripheral key (uses HMAC Downstream mode)

enumerator **ESP\_EFUSE\_KEY\_PURPOSE\_HMAC\_UP**

HMAC Upstream mode

enumerator **ESP\_EFUSE\_KEY\_PURPOSE\_SECURE\_BOOT\_DIGEST0**

SECURE\_BOOT\_DIGEST0 (Secure Boot key digest)

enumerator **ESP\_EFUSE\_KEY\_PURPOSE\_SECURE\_BOOT\_DIGEST1**

SECURE\_BOOT\_DIGEST1 (Secure Boot key digest)

enumerator **ESP\_EFUSE\_KEY\_PURPOSE\_SECURE\_BOOT\_DIGEST2**

SECURE\_BOOT\_DIGEST2 (Secure Boot key digest)

enumerator **ESP\_EFUSE\_KEY\_PURPOSE\_MAX**

MAX PURPOSE

### Header File

- [components/efuse/include/esp\\_efuse.h](#)
- This header file can be included with:

```
#include "esp_efuse.h"
```

- This header file is a part of the API provided by the `efuse` component. To declare that your component depends on `efuse`, add the following to your `CMakeLists.txt`:

```
REQUIRES efuse
```

or

```
PRIV_REQUIRES efuse
```

**Functions**

*esp\_err\_t* **esp\_efuse\_read\_field\_blob** (const *esp\_efuse\_desc\_t* \*field[], void \*dst, size\_t dst\_size\_bits)

Reads bits from EFUSE field and writes it into an array.

The number of read bits will be limited to the minimum value from the description of the bits in "field" structure or "dst\_size\_bits" required size. Use "esp\_efuse\_get\_field\_size()" function to determine the length of the field.

---

**备注:** Please note that reading in the batch mode does not show uncommitted changes.

---

**参数**

- **field** -- [in] A pointer to the structure describing the fields of efuse.
- **dst** -- [out] A pointer to array that will contain the result of reading.
- **dst\_size\_bits** -- [in] The number of bits required to read. If the requested number of bits is greater than the field, the number will be limited to the field size.

**返回**

- ESP\_OK: The operation was successfully completed.
- ESP\_ERR\_INVALID\_ARG: Error in the passed arguments.

bool **esp\_efuse\_read\_field\_bit** (const *esp\_efuse\_desc\_t* \*field[])

Read a single bit eFuse field as a boolean value.

---

**备注:** The value must exist and must be a single bit wide. If there is any possibility of an error in the provided arguments, call esp\_efuse\_read\_field\_blob() and check the returned value instead.

---



---

**备注:** If assertions are enabled and the parameter is invalid, execution will abort

---



---

**备注:** Please note that reading in the batch mode does not show uncommitted changes.

---

**参数** **field** -- [in] A pointer to the structure describing the fields of efuse.

**返回**

- true: The field parameter is valid and the bit is set.
- false: The bit is not set, or the parameter is invalid and assertions are disabled.

*esp\_err\_t* **esp\_efuse\_read\_field\_cnt** (const *esp\_efuse\_desc\_t* \*field[], size\_t \*out\_cnt)

Reads bits from EFUSE field and returns number of bits programmed as "1".

If the bits are set not sequentially, they will still be counted.

---

**备注:** Please note that reading in the batch mode does not show uncommitted changes.

---

**参数**

- **field** -- [in] A pointer to the structure describing the fields of efuse.
- **out\_cnt** -- [out] A pointer that will contain the number of programmed as "1" bits.

**返回**

- ESP\_OK: The operation was successfully completed.
- ESP\_ERR\_INVALID\_ARG: Error in the passed arguments.

*esp\_err\_t* **esp\_efuse\_write\_field\_blob** (const *esp\_efuse\_desc\_t* \*field[], const void \*src, size\_t src\_size\_bits)

Writes array to EFUSE field.



The number of write bits will be limited to the minimum value from the description of the bits in "field" structure or "src\_size\_bits" required size. Use "esp\_efuse\_get\_field\_size()" function to determine the length of the field. After the function is completed, the writing registers are cleared.

#### 参数

- **field** -- [in] A pointer to the structure describing the fields of efuse.
- **src** -- [in] A pointer to array that contains the data for writing.
- **src\_size\_bits** -- [in] The number of bits required to write.

#### 返回

- ESP\_OK: The operation was successfully completed.
- ESP\_ERR\_INVALID\_ARG: Error in the passed arguments.
- ESP\_ERR\_EFUSE\_REPEATED\_PROG: Error repeated programming of programmed bits is strictly forbidden.
- ESP\_ERR\_CODING: Error range of data does not match the coding scheme.

*esp\_err\_t* **esp\_efuse\_write\_field\_cnt** (const *esp\_efuse\_desc\_t* \*field[], size\_t cnt)

Writes a required count of bits as "1" to EFUSE field.

If there are no free bits in the field to set the required number of bits to "1", ESP\_ERR\_EFUSE\_CNT\_IS\_FULL error is returned, the field will not be partially recorded. After the function is completed, the writing registers are cleared.

#### 参数

- **field** -- [in] A pointer to the structure describing the fields of efuse.
- **cnt** -- [in] Required number of programmed as "1" bits.

#### 返回

- ESP\_OK: The operation was successfully completed.
- ESP\_ERR\_INVALID\_ARG: Error in the passed arguments.
- ESP\_ERR\_EFUSE\_CNT\_IS\_FULL: Not all requested cnt bits is set.

*esp\_err\_t* **esp\_efuse\_write\_field\_bit** (const *esp\_efuse\_desc\_t* \*field[])

Write a single bit eFuse field to 1.

For use with eFuse fields that are a single bit. This function will write the bit to value 1 if it is not already set, or does nothing if the bit is already set.

This is equivalent to calling esp\_efuse\_write\_field\_cnt() with the cnt parameter equal to 1, except that it will return ESP\_OK if the field is already set to 1.

**参数** **field** -- [in] Pointer to the structure describing the efuse field.

#### 返回

- ESP\_OK: The operation was successfully completed, or the bit was already set to value 1.
- ESP\_ERR\_INVALID\_ARG: Error in the passed arguments, including if the efuse field is not 1 bit wide.

*esp\_err\_t* **esp\_efuse\_set\_write\_protect** (*esp\_efuse\_block\_t* blk)

Sets a write protection for the whole block.

After that, it is impossible to write to this block. The write protection does not apply to block 0.

**参数** **blk** -- [in] Block number of eFuse. (EFUSE\_BLK1, EFUSE\_BLK2 and EFUSE\_BLK3)

#### 返回

- ESP\_OK: The operation was successfully completed.
- ESP\_ERR\_INVALID\_ARG: Error in the passed arguments.
- ESP\_ERR\_EFUSE\_CNT\_IS\_FULL: Not all requested cnt bits is set.
- ESP\_ERR\_NOT\_SUPPORTED: The block does not support this command.

*esp\_err\_t* **esp\_efuse\_set\_read\_protect** (*esp\_efuse\_block\_t* blk)

Sets a read protection for the whole block.

After that, it is impossible to read from this block. The read protection does not apply to block 0.

**参数** **blk** -- [in] Block number of eFuse. (EFUSE\_BLK1, EFUSE\_BLK2 and EFUSE\_BLK3)

#### 返回

- ESP\_OK: The operation was successfully completed.
- ESP\_ERR\_INVALID\_ARG: Error in the passed arguments.
- ESP\_ERR\_EFUSE\_CNT\_IS\_FULL: Not all requested cnt bits is set.
- ESP\_ERR\_NOT\_SUPPORTED: The block does not support this command.

int **esp\_efuse\_get\_field\_size** (const *esp\_efuse\_desc\_t* \*field[])

Returns the number of bits used by field.

**参数 field** -- [in] A pointer to the structure describing the fields of efuse.

**返回** Returns the number of bits used by field.

uint32\_t **esp\_efuse\_read\_reg** (*esp\_efuse\_block\_t* blk, unsigned int num\_reg)

Returns value of efuse register.

This is a thread-safe implementation. Example: EFUSE\_BLK2\_RDATA3\_REG where (blk=2, num\_reg=3)

---

**备注:** Please note that reading in the batch mode does not show uncommitted changes.

---

#### 参数

- **blk** -- [in] Block number of eFuse.
- **num\_reg** -- [in] The register number in the block.

**返回** Value of register

*esp\_err\_t* **esp\_efuse\_write\_reg** (*esp\_efuse\_block\_t* blk, unsigned int num\_reg, uint32\_t val)

Write value to efuse register.

Apply a coding scheme if necessary. This is a thread-safe implementation. Example: EFUSE\_BLK3\_WDATA0\_REG where (blk=3, num\_reg=0)

#### 参数

- **blk** -- [in] Block number of eFuse.
- **num\_reg** -- [in] The register number in the block.
- **val** -- [in] Value to write.

#### 返回

- ESP\_OK: The operation was successfully completed.
- ESP\_ERR\_EFUSE\_REPEATED\_PROG: Error repeated programming of programmed bits is strictly forbidden.

*esp\_efuse\_coding\_scheme\_t* **esp\_efuse\_get\_coding\_scheme** (*esp\_efuse\_block\_t* blk)

Return efuse coding scheme for blocks.

---

**备注:** The coding scheme is applicable only to 1, 2 and 3 blocks. For 0 block, the coding scheme is always NONE.

---

**参数 blk** -- [in] Block number of eFuse.

**返回** Return efuse coding scheme for blocks

*esp\_err\_t* **esp\_efuse\_read\_block** (*esp\_efuse\_block\_t* blk, void \*dst\_key, size\_t offset\_in\_bits, size\_t size\_bits)

Read key to efuse block starting at the offset and the required size.

---

**备注:** Please note that reading in the batch mode does not show uncommitted changes.

---

#### 参数

- **blk** -- [in] Block number of eFuse.
- **dst\_key** -- [in] A pointer to array that will contain the result of reading.

- **offset\_in\_bits** -- [in] Start bit in block.
- **size\_bits** -- [in] The number of bits required to read.

**返回**

- ESP\_OK: The operation was successfully completed.
- ESP\_ERR\_INVALID\_ARG: Error in the passed arguments.
- ESP\_ERR\_CODING: Error range of data does not match the coding scheme.

*esp\_err\_t* **esp\_efuse\_write\_block** (*esp\_efuse\_block\_t* blk, const void \*src\_key, size\_t offset\_in\_bits, size\_t size\_bits)

Write key to efuse block starting at the offset and the required size.

**参数**

- **blk** -- [in] Block number of eFuse.
- **src\_key** -- [in] A pointer to array that contains the key for writing.
- **offset\_in\_bits** -- [in] Start bit in block.
- **size\_bits** -- [in] The number of bits required to write.

**返回**

- ESP\_OK: The operation was successfully completed.
- ESP\_ERR\_INVALID\_ARG: Error in the passed arguments.
- ESP\_ERR\_CODING: Error range of data does not match the coding scheme.
- ESP\_ERR\_EFUSE\_REPEATED\_PROG: Error repeated programming of programmed bits

uint32\_t **esp\_efuse\_get\_pkg\_ver** (void)

Returns chip package from efuse.

**返回** chip package

void **esp\_efuse\_reset** (void)

Reset efuse write registers.

Efuse write registers are written to zero, to negate any changes that have been staged here.

---

**备注:** This function is not threadsafe, if calling code updates efuse values from multiple tasks then this is caller's responsibility to serialise.

---

*esp\_err\_t* **esp\_efuse\_disable\_rom\_download\_mode** (void)

Disable ROM Download Mode via eFuse.

Permanently disables the ROM Download Mode feature. Once disabled, if the SoC is booted with strapping pins set for ROM Download Mode then an error is printed instead.

---

**备注:** Not all SoCs support this option. An error will be returned if called on an ESP32 with a silicon revision lower than 3, as these revisions do not support this option.

---

---

**备注:** If ROM Download Mode is already disabled, this function does nothing and returns success.

---

**返回**

- ESP\_OK If the eFuse was successfully burned, or had already been burned.
- ESP\_ERR\_NOT\_SUPPORTED (ESP32 only) This SoC is not capable of disabling UART download mode
- ESP\_ERR\_INVALID\_STATE (ESP32 only) This eFuse is write protected and cannot be written

*esp\_err\_t* **esp\_efuse\_set\_rom\_log\_scheme** (*esp\_efuse\_rom\_log\_scheme\_t* log\_scheme)

Set boot ROM log scheme via eFuse.

---

**备注:** By default, the boot ROM will always print to console. This API can be called to set the log scheme only once per chip, once the value is changed from the default it can't be changed again.

---

**参数** **log\_scheme** -- Supported ROM log scheme

**返回**

- ESP\_OK If the eFuse was successfully burned, or had already been burned.
- ESP\_ERR\_NOT\_SUPPORTED (ESP32 only) This SoC is not capable of setting ROM log scheme
- ESP\_ERR\_INVALID\_STATE This eFuse is write protected or has been burned already

*esp\_err\_t* **esp\_efuse\_enable\_rom\_secure\_download\_mode** (void)

Switch ROM Download Mode to Secure Download mode via eFuse.

Permanently enables Secure Download mode. This mode limits the use of ROM Download Mode functions to simple flash read, write and erase operations, plus a command to return a summary of currently enabled security features.

---

**备注:** If Secure Download mode is already enabled, this function does nothing and returns success.

---

---

**备注:** Disabling the ROM Download Mode also disables Secure Download Mode.

---

**返回**

- ESP\_OK If the eFuse was successfully burned, or had already been burned.
- ESP\_ERR\_INVALID\_STATE ROM Download Mode has been disabled via eFuse, so Secure Download mode is unavailable.

uint32\_t **esp\_efuse\_read\_secure\_version** (void)

Return secure\_version from efuse field.

**返回** Secure version from efuse field

bool **esp\_efuse\_check\_secure\_version** (uint32\_t secure\_version)

Check secure\_version from app and secure\_version and from efuse field.

**参数** **secure\_version** -- Secure version from app.

**返回**

- True: If version of app is equal or more then secure\_version from efuse.

*esp\_err\_t* **esp\_efuse\_update\_secure\_version** (uint32\_t secure\_version)

Write efuse field by secure\_version value.

Update the secure\_version value is available if the coding scheme is None. Note: Do not use this function in your applications. This function is called as part of the other API.

**参数** **secure\_version** -- [in] Secure version from app.

**返回**

- ESP\_OK: Successful.
- ESP\_FAIL: secure version of app cannot be set to efuse field.
- ESP\_ERR\_NOT\_SUPPORTED: Anti rollback is not supported with the 3/4 and Repeat coding scheme.

**esp\_err\_t esp\_efuse\_batch\_write\_begin** (void)

Set the batch mode of writing fields.

This mode allows you to write the fields in the batch mode when need to burn several efuses at one time. To enable batch mode call begin() then perform as usually the necessary operations read and write and at the end call commit() to actually burn all written efuses. The batch mode can be used nested. The commit will be done by the last commit() function. The number of begin() functions should be equal to the number of commit() functions.

Note: If batch mode is enabled by the first task, at this time the second task cannot write/read efuses. The second task will wait for the first task to complete the batch operation.

```
// Example of using the batch writing mode.

// set the batch writing mode
esp_efuse_batch_write_begin();

// use any writing functions as usual
esp_efuse_write_field_blob(ESP_EFUSE_...);
esp_efuse_write_field_cnt(ESP_EFUSE_...);
esp_efuse_set_write_protect(EFUSE_BLKx);
esp_efuse_write_reg(EFUSE_BLKx, ...);
esp_efuse_write_block(EFUSE_BLKx, ...);
esp_efuse_write(ESP_EFUSE_1, 3); // ESP_EFUSE_1 == 1, here we write a new
↳value = 3. The changes will be burn by the commit() function.
esp_efuse_read...(ESP_EFUSE_1); // this function returns ESP_EFUSE_1 == 1
↳because uncommitted changes are not readable, it will be available only
↳after commit.
...

// esp_efuse_batch_write APIs can be called recursively.
esp_efuse_batch_write_begin();
esp_efuse_set_write_protect(EFUSE_BLKx);
esp_efuse_batch_write_commit(); // the burn will be skipped here, it will be
↳done in the last commit().

...

// Write all of these fields to the efuse registers
esp_efuse_batch_write_commit();
esp_efuse_read...(ESP_EFUSE_1); // this function returns ESP_EFUSE_1 == 3.
```

**备注:** Please note that reading in the batch mode does not show uncommitted changes.

**返回**

- ESP\_OK: Successful.

**esp\_err\_t esp\_efuse\_batch\_write\_cancel** (void)

Reset the batch mode of writing fields.

It will reset the batch writing mode and any written changes.

**返回**

- ESP\_OK: Successful.
- ESP\_ERR\_INVALID\_STATE: The batch mode was not set.

**esp\_err\_t esp\_efuse\_batch\_write\_commit** (void)

Writes all prepared data for the batch mode.

Must be called to ensure changes are written to the efuse registers. After this the batch writing mode will be reset.

返回

- ESP\_OK: Successful.
- ESP\_ERR\_INVALID\_STATE: The deferred writing mode was not set.

bool **esp\_efuse\_block\_is\_empty** (*esp\_efuse\_block\_t* block)

Checks that the given block is empty.

返回

- True: The block is empty.
- False: The block is not empty or was an error.

bool **esp\_efuse\_get\_key\_dis\_read** (*esp\_efuse\_block\_t* block)

Returns a read protection for the key block.

参数 **block** -- [in] A key block in the range EFUSE\_BLK\_KEY0..EFUSE\_BLK\_KEY\_MAX

返回 True: The key block is read protected False: The key block is readable.

*esp\_err\_t* **esp\_efuse\_set\_key\_dis\_read** (*esp\_efuse\_block\_t* block)

Sets a read protection for the key block.

参数 **block** -- [in] A key block in the range EFUSE\_BLK\_KEY0..EFUSE\_BLK\_KEY\_MAX

返回

- ESP\_OK: Successful.
- ESP\_ERR\_INVALID\_ARG: Error in the passed arguments.
- ESP\_ERR\_EFUSE\_REPEATED\_PROG: Error repeated programming of programmed bits is strictly forbidden.
- ESP\_ERR\_CODING: Error range of data does not match the coding scheme.

bool **esp\_efuse\_get\_key\_dis\_write** (*esp\_efuse\_block\_t* block)

Returns a write protection for the key block.

参数 **block** -- [in] A key block in the range EFUSE\_BLK\_KEY0..EFUSE\_BLK\_KEY\_MAX

返回 True: The key block is write protected False: The key block is writeable.

*esp\_err\_t* **esp\_efuse\_set\_key\_dis\_write** (*esp\_efuse\_block\_t* block)

Sets a write protection for the key block.

参数 **block** -- [in] A key block in the range EFUSE\_BLK\_KEY0..EFUSE\_BLK\_KEY\_MAX

返回

- ESP\_OK: Successful.
- ESP\_ERR\_INVALID\_ARG: Error in the passed arguments.
- ESP\_ERR\_EFUSE\_REPEATED\_PROG: Error repeated programming of programmed bits is strictly forbidden.
- ESP\_ERR\_CODING: Error range of data does not match the coding scheme.

bool **esp\_efuse\_key\_block\_unused** (*esp\_efuse\_block\_t* block)

Returns true if the key block is unused, false otherwise.

An unused key block is all zero content, not read or write protected, and has purpose 0 (ESP\_EFUSE\_KEY\_PURPOSE\_USER)

参数 **block** -- key block to check.

返回

- True if key block is unused,
- False if key block is used or the specified block index is not a key block.

bool **esp\_efuse\_find\_purpose** (*esp\_efuse\_purpose\_t* purpose, *esp\_efuse\_block\_t* \*block)

Find a key block with the particular purpose set.

参数

- **purpose** -- [in] Purpose to search for.

- **block** -- **[out]** Pointer in the range EFUSE\_BLK\_KEY0..EFUSE\_BLK\_KEY\_MAX which will be set to the key block if found. Can be NULL, if only need to test the key block exists.

**返回**

- True: If found,
- False: If not found (value at block pointer is unchanged).

bool **esp\_efuse\_get\_keypurpose\_dis\_write** (*esp\_efuse\_block\_t* block)

Returns a write protection of the key purpose field for an efuse key block.

---

**备注:** For ESP32: no keypurpose, it returns always True.

---

**参数** **block** -- **[in]** A key block in the range EFUSE\_BLK\_KEY0..EFUSE\_BLK\_KEY\_MAX

**返回** True: The key purpose is write protected. False: The key purpose is writeable.

*esp\_efuse\_purpose\_t* **esp\_efuse\_get\_key\_purpose** (*esp\_efuse\_block\_t* block)

Returns the current purpose set for an efuse key block.

**参数** **block** -- **[in]** A key block in the range EFUSE\_BLK\_KEY0..EFUSE\_BLK\_KEY\_MAX

**返回**

- Value: If Successful, it returns the value of the purpose related to the given key block.
- ESP\_EFUSE\_KEY\_PURPOSE\_MAX: Otherwise.

const *esp\_efuse\_desc\_t* \*\***esp\_efuse\_get\_purpose\_field** (*esp\_efuse\_block\_t* block)

Returns a pointer to a key purpose for an efuse key block.

To get the value of this field use `esp_efuse_read_field_blob()` or `esp_efuse_get_key_purpose()`.

**参数** **block** -- **[in]** A key block in the range EFUSE\_BLK\_KEY0..EFUSE\_BLK\_KEY\_MAX

**返回** Pointer: If Successful returns a pointer to the corresponding efuse field otherwise NULL.

const *esp\_efuse\_desc\_t* \*\***esp\_efuse\_get\_key** (*esp\_efuse\_block\_t* block)

Returns a pointer to a key block.

**参数** **block** -- **[in]** A key block in the range EFUSE\_BLK\_KEY0..EFUSE\_BLK\_KEY\_MAX

**返回** Pointer: If Successful returns a pointer to the corresponding efuse field otherwise NULL.

*esp\_err\_t* **esp\_efuse\_set\_key\_purpose** (*esp\_efuse\_block\_t* block, *esp\_efuse\_purpose\_t* purpose)

Sets a key purpose for an efuse key block.

**参数**

- **block** -- **[in]** A key block in the range EFUSE\_BLK\_KEY0..EFUSE\_BLK\_KEY\_MAX
- **purpose** -- **[in]** Key purpose.

**返回**

- ESP\_OK: Successful.
- ESP\_ERR\_INVALID\_ARG: Error in the passed arguments.
- ESP\_ERR\_EFUSE\_REPEATED\_PROG: Error repeated programming of programmed bits is strictly forbidden.
- ESP\_ERR\_CODING: Error range of data does not match the coding scheme.

*esp\_err\_t* **esp\_efuse\_set\_keypurpose\_dis\_write** (*esp\_efuse\_block\_t* block)

Sets a write protection of the key purpose field for an efuse key block.

**参数** **block** -- **[in]** A key block in the range EFUSE\_BLK\_KEY0..EFUSE\_BLK\_KEY\_MAX

**返回**

- ESP\_OK: Successful.
- ESP\_ERR\_INVALID\_ARG: Error in the passed arguments.
- ESP\_ERR\_EFUSE\_REPEATED\_PROG: Error repeated programming of programmed bits is strictly forbidden.



- ESP\_ERR\_CODING: Error range of data does not match the coding scheme.

*esp\_efuse\_block\_t* **esp\_efuse\_find\_unused\_key\_block** (void)

Search for an unused key block and return the first one found.

See `esp_efuse_key_block_unused` for a description of an unused key block.

**返回** First unused key block, or `EFUSE_BLK_KEY_MAX` if no unused key block is found.

unsigned **esp\_efuse\_count\_unused\_key\_blocks** (void)

Return the number of unused efuse key blocks in the range `EFUSE_BLK_KEY0..EFUSE_BLK_KEY_MAX`.

bool **esp\_efuse\_get\_digest\_revoke** (unsigned num\_digest)

Returns the status of the Secure Boot public key digest revocation bit.

**参数** `num_digest` -- [in] The number of digest in range 0..2

**返回**

- True: If key digest is revoked,
- False; If key digest is not revoked.

*esp\_err\_t* **esp\_efuse\_set\_digest\_revoke** (unsigned num\_digest)

Sets the Secure Boot public key digest revocation bit.

**参数** `num_digest` -- [in] The number of digest in range 0..2

**返回**

- ESP\_OK: Successful.
- ESP\_ERR\_INVALID\_ARG: Error in the passed arguments.
- ESP\_ERR\_EFUSE\_REPEATED\_PROG: Error repeated programming of programmed bits is strictly forbidden.
- ESP\_ERR\_CODING: Error range of data does not match the coding scheme.

bool **esp\_efuse\_get\_write\_protect\_of\_digest\_revoke** (unsigned num\_digest)

Returns a write protection of the Secure Boot public key digest revocation bit.

**参数** `num_digest` -- [in] The number of digest in range 0..2

**返回** True: The revocation bit is write protected. False: The revocation bit is writeable.

*esp\_err\_t* **esp\_efuse\_set\_write\_protect\_of\_digest\_revoke** (unsigned num\_digest)

Sets a write protection of the Secure Boot public key digest revocation bit.

**参数** `num_digest` -- [in] The number of digest in range 0..2

**返回**

- ESP\_OK: Successful.
- ESP\_ERR\_INVALID\_ARG: Error in the passed arguments.
- ESP\_ERR\_EFUSE\_REPEATED\_PROG: Error repeated programming of programmed bits is strictly forbidden.
- ESP\_ERR\_CODING: Error range of data does not match the coding scheme.

*esp\_err\_t* **esp\_efuse\_write\_key** (*esp\_efuse\_block\_t* block, *esp\_efuse\_purpose\_t* purpose, const void \*key, size\_t key\_size\_bytes)

Program a block of key data to an efuse block.

The burn of a key, protection bits, and a purpose happens in batch mode.

---

**备注:** This API also enables the read protection efuse bit for certain key blocks like XTS-AES, HMAC, ECDSA etc. This ensures that the key is only accessible to hardware peripheral.

---

---

**备注:** For SoC's with capability `SOC_EFUSE_ECDSA_USE_HARDWARE_K` (e.g., ESP32-H2), this API writes an additional efuse bit for ECDSA key purpose to enforce hardware TRNG generated k mode in the peripheral.

---



**参数**

- **block** -- [in] Block to read purpose for. Must be in range EFUSE\_BLK\_KEY0 to EFUSE\_BLK\_KEY\_MAX. Key block must be unused (`esp_efuse_key_block_unused`).
- **purpose** -- [in] Purpose to set for this key. Purpose must be already unset.
- **key** -- [in] Pointer to data to write.
- **key\_size\_bytes** -- [in] Bytes length of data to write.

**返回**

- ESP\_OK: Successful.
- ESP\_ERR\_INVALID\_ARG: Error in the passed arguments.
- ESP\_ERR\_INVALID\_STATE: Error in efuses state, unused block not found.
- ESP\_ERR\_EFUSE\_REPEATED\_PROG: Error repeated programming of programmed bits is strictly forbidden.
- ESP\_ERR\_CODING: Error range of data does not match the coding scheme.

*esp\_err\_t* **esp\_efuse\_write\_keys** (const *esp\_efuse\_purpose\_t* purposes[], uint8\_t keys[][32], unsigned number\_of\_keys)

Program keys to unused efuse blocks.

The burn of keys, protection bits, and purposes happens in batch mode.

---

**备注:** This API also enables the read protection efuse bit for certain key blocks like XTS-AES, HMAC, ECDSA etc. This ensures that the key is only accessible to hardware peripheral.

---



---

**备注:** For SoC's with capability SOC\_EFUSE\_ECDSA\_USE\_HARDWARE\_K (e.g., ESP32-H2), this API writes an additional efuse bit for ECDSA key purpose to enforce hardware TRNG generated k mode in the peripheral.

---

**参数**

- **purposes** -- [in] Array of purposes (purpose[number\_of\_keys]).
- **keys** -- [in] Array of keys (uint8\_t keys[number\_of\_keys][32]). Each key is 32 bytes long.
- **number\_of\_keys** -- [in] The number of keys to write (up to 6 keys).

**返回**

- ESP\_OK: Successful.
- ESP\_ERR\_INVALID\_ARG: Error in the passed arguments.
- ESP\_ERR\_INVALID\_STATE: Error in efuses state, unused block not found.
- ESP\_ERR\_NOT\_ENOUGH\_UNUSED\_KEY\_BLOCKS: Error not enough unused key blocks available
- ESP\_ERR\_EFUSE\_REPEATED\_PROG: Error repeated programming of programmed bits is strictly forbidden.
- ESP\_ERR\_CODING: Error range of data does not match the coding scheme.

*esp\_err\_t* **esp\_secure\_boot\_read\_key\_digests** (*esp\_secure\_boot\_key\_digests\_t* \*trusted\_key\_digests)

Read key digests from efuse. Any revoked/missing digests will be marked as NULL.

**参数** **trusted\_key\_digests** -- [out] Trusted keys digests, stored in this parameter after successfully completing this function. The number of digests depends on the SOC's capabilities.

**返回**

- ESP\_OK: Successful.
- ESP\_FAIL: If trusted\_keys is NULL or there is no valid digest.

*esp\_err\_t* **esp\_efuse\_check\_errors** (void)

Checks eFuse errors in BLOCK0.

It does a BLOCK0 check if eFuse EFUSE\_ERR\_RST\_ENABLE is set. If BLOCK0 has an error, it prints the error and returns ESP\_FAIL, which should be treated as esp\_restart.

---

**备注:** Refers to ESP32-C3 only.

---

#### 返回

- ESP\_OK: No errors in BLOCK0.
- ESP\_FAIL: Error in BLOCK0 requiring reboot.

*esp\_err\_t* **esp\_efuse\_destroy\_block** (*esp\_efuse\_block\_t* block)

Destroys the data in the given efuse block, if possible.

Data destruction occurs through the following steps: 1) Destroy data in the block:

- If write protection is inactive for the block, then unset bits are burned.
- If write protection is active, the block remains unaltered. 2) Set read protection for the block if possible (check write-protection for RD\_DIS). In this case, data becomes inaccessible, and the software reads it as all zeros. If write protection is enabled and read protection can not be set, data in the block remains readable (returns an error).

Do not use the batch mode with this function as it does the burning itself!

**参数** **block** -- [**in**] A key block in the range EFUSE\_BLK\_KEY0..EFUSE\_BLK\_KEY\_MAX

#### 返回

- ESP\_OK: Successful.
- ESP\_FAIL: Data remained readable because the block is write-protected and read protection can not be set.

## Structures

struct **esp\_efuse\_desc\_t**

Type definition for an eFuse field.

### Public Members

*esp\_efuse\_block\_t* **efuse\_block**

Block of eFuse

uint8\_t **bit\_start**

Start bit [0..255]

uint16\_t **bit\_count**

Length of bit field [1..-]

struct **esp\_secure\_boot\_key\_digests\_t**

Pointers to the trusted key digests.

The number of digests depends on the SOC's capabilities.

### Public Members

const void \***key\_digests**[3]

Pointers to the key digests

## Macros

### ESP\_ERR\_EFUSE

Base error code for efuse api.

### ESP\_OK\_EFUSE\_CNT

OK the required number of bits is set.

### ESP\_ERR\_EFUSE\_CNT\_IS\_FULL

Error field is full.

### ESP\_ERR\_EFUSE\_REPEATED\_PROG

Error repeated programming of programmed bits is strictly forbidden.

### ESP\_ERR\_CODING

Error while a encoding operation.

### ESP\_ERR\_NOT\_ENOUGH\_UNUSED\_KEY\_BLOCKS

Error not enough unused key blocks available

### ESP\_ERR\_DAMAGED\_READING

Error. Burn or reset was done during a reading operation leads to damage read data. This error is internal to the efuse component and not returned by any public API.

## Enumerations

### enum esp\_efuse\_rom\_log\_scheme\_t

Type definition for ROM log scheme.

*Values:*

enumerator **ESP\_EFUSE\_ROM\_LOG\_ALWAYS\_ON**

Always enable ROM logging

enumerator **ESP\_EFUSE\_ROM\_LOG\_ON\_GPIO\_LOW**

ROM logging is enabled when specific GPIO level is low during start up

enumerator **ESP\_EFUSE\_ROM\_LOG\_ON\_GPIO\_HIGH**

ROM logging is enabled when specific GPIO level is high during start up

enumerator **ESP\_EFUSE\_ROM\_LOG\_ALWAYS\_OFF**

Disable ROM logging permanently

## 2.10.8 错误代码和辅助函数

本节列出了 ESP-IDF 中常见错误代码的定义，以及部分与错误处理相关的辅助函数。

有关 ESP-IDF 中错误代码的基本信息，请参阅[错误处理](#)。

有关 ESP-IDF 定义的错误代码的完整列表，请参阅[错误代码参考](#)。

## API 参考

### Header File

- `components/esp_common/include/esp_check.h`
- This header file can be included with:

```
#include "esp_check.h"
```

### Macros

**ESP\_RETURN\_ON\_ERROR** (x, log\_tag, format, ...)

Macro which can be used to check the error code. If the code is not `ESP_OK`, it prints the message and returns. In the future, we want to switch to C++20. We also want to become compatible with clang. Hence, we provide two versions of the following macros. The first one is using the GNU extension `##_VA_ARGS__`. The second one is using the C++20 feature `VA_OPT(,)`. This allows users to compile their code with standard C++20 enabled instead of the GNU extension. Below C++20, we haven't found any good alternative to using `##_VA_ARGS__`. Macro which can be used to check the error code. If the code is not `ESP_OK`, it prints the message and returns.

**ESP\_RETURN\_ON\_ERROR\_ISR** (x, log\_tag, format, ...)

A version of `ESP_RETURN_ON_ERROR()` macro that can be called from ISR.

**ESP\_RETURN\_VOID\_ON\_ERROR** (x, log\_tag, format, ...)

Macro which can be used to check the error code. If the code is not `ESP_OK`, it prints the message and returns. This macro is used when the function returns void.

**ESP\_RETURN\_VOID\_ON\_ERROR\_ISR** (x, log\_tag, format, ...)

A version of `ESP_RETURN_VOID_ON_ERROR()` macro that can be called from ISR.

**ESP\_GOTO\_ON\_ERROR** (x, goto\_tag, log\_tag, format, ...)

Macro which can be used to check the error code. If the code is not `ESP_OK`, it prints the message, sets the local variable 'ret' to the code, and then exits by jumping to 'goto\_tag'.

**ESP\_GOTO\_ON\_ERROR\_ISR** (x, goto\_tag, log\_tag, format, ...)

A version of `ESP_GOTO_ON_ERROR()` macro that can be called from ISR.

**ESP\_RETURN\_ON\_FALSE** (a, err\_code, log\_tag, format, ...)

Macro which can be used to check the condition. If the condition is not 'true', it prints the message and returns with the supplied 'err\_code'.

**ESP\_RETURN\_ON\_FALSE\_ISR** (a, err\_code, log\_tag, format, ...)

A version of `ESP_RETURN_ON_FALSE()` macro that can be called from ISR.

**ESP\_RETURN\_VOID\_ON\_FALSE** (a, log\_tag, format, ...)

Macro which can be used to check the condition. If the condition is not 'true', it prints the message and returns without a value.

**ESP\_RETURN\_VOID\_ON\_FALSE\_ISR** (a, log\_tag, format, ...)

A version of `ESP_RETURN_VOID_ON_FALSE()` macro that can be called from ISR.

**ESP\_GOTO\_ON\_FALSE** (a, err\_code, goto\_tag, log\_tag, format, ...)

Macro which can be used to check the condition. If the condition is not 'true', it prints the message, sets the local variable 'ret' to the supplied 'err\_code', and then exits by jumping to 'goto\_tag'.

**ESP\_GOTO\_ON\_FALSE\_ISR** (a, err\_code, goto\_tag, log\_tag, format, ...)

A version of `ESP_GOTO_ON_FALSE()` macro that can be called from ISR.

## Header File

- `components/esp_common/include/esp_err.h`
- This header file can be included with:

```
#include "esp_err.h"
```

## Functions

const char \***esp\_err\_to\_name** (*esp\_err\_t* code)

Returns string for `esp_err_t` error codes.

This function finds the error code in a pre-generated lookup-table and returns its string representation.

The function is generated by the Python script `tools/gen_esp_err_to_name.py` which should be run each time an `esp_err_t` error is modified, created or removed from the IDF project.

**参数** `code` -- `esp_err_t` error code

**返回** string error message

const char \***esp\_err\_to\_name\_r** (*esp\_err\_t* code, char \*buf, size\_t buflen)

Returns string for `esp_err_t` and system error codes.

This function finds the error code in a pre-generated lookup-table of `esp_err_t` errors and returns its string representation. If the error code is not found then it is attempted to be found among system errors.

The function is generated by the Python script `tools/gen_esp_err_to_name.py` which should be run each time an `esp_err_t` error is modified, created or removed from the IDF project.

**参数**

- **code** -- `esp_err_t` error code
- **buf** -- [out] buffer where the error message should be written
- **buflen** -- Size of buffer buf. At most buflen bytes are written into the buf buffer (including the terminating null byte).

**返回** buf containing the string error message

## Macros

### ESP\_OK

`esp_err_t` value indicating success (no error)

### ESP\_FAIL

Generic `esp_err_t` code indicating failure

### ESP\_ERR\_NO\_MEM

Out of memory

### ESP\_ERR\_INVALID\_ARG

Invalid argument

### ESP\_ERR\_INVALID\_STATE

Invalid state

### ESP\_ERR\_INVALID\_SIZE

Invalid size

### ESP\_ERR\_NOT\_FOUND

Requested resource not found

**ESP\_ERR\_NOT\_SUPPORTED**

Operation or feature not supported

**ESP\_ERR\_TIMEOUT**

Operation timed out

**ESP\_ERR\_INVALID\_RESPONSE**

Received response was invalid

**ESP\_ERR\_INVALID\_CRC**

CRC or checksum was invalid

**ESP\_ERR\_INVALID\_VERSION**

Version was invalid

**ESP\_ERR\_INVALID\_MAC**

MAC address was invalid

**ESP\_ERR\_NOT\_FINISHED**

Operation has not fully completed

**ESP\_ERR\_NOT\_ALLOWED**

Operation is not allowed

**ESP\_ERR\_WIFI\_BASE**

Starting number of WiFi error codes

**ESP\_ERR\_MESH\_BASE**

Starting number of MESH error codes

**ESP\_ERR\_FLASH\_BASE**

Starting number of flash error codes

**ESP\_ERR\_HW\_CRYPTO\_BASE**

Starting number of HW cryptography module error codes

**ESP\_ERR\_MEMPROT\_BASE**

Starting number of Memory Protection API error codes

**ESP\_ERROR\_CHECK** (x)

Macro which can be used to check the error code, and terminate the program in case the code is not ESP\_OK. Prints the error code, error location, and the failed statement to serial output.

Disabled if assertions are disabled.

**ESP\_ERROR\_CHECK\_WITHOUT\_ABORT** (x)

Macro which can be used to check the error code. Prints the error code, error location, and the failed statement to serial output. In comparison with ESP\_ERROR\_CHECK(), this prints the same error message but isn't terminating the program.

## Type Definitions

```
typedef int esp_err_t
```

### 2.10.9 ESP HTTPS OTA 升级

#### 概述

esp\_https\_ota 是现有 OTA（空中升级）API 的抽象层，其中提供了简化的 API，能够通过 HTTPS 升级固件。

#### 应用示例

```
esp_err_t do_firmware_upgrade()
{
    esp_http_client_config_t config = {
        .url = CONFIG_FIRMWARE_UPGRADE_URL,
        .cert_pem = (char *)server_cert_pem_start,
    };
    esp_https_ota_config_t ota_config = {
        .http_config = &config,
    };
    esp_err_t ret = esp_https_ota(&ota_config);
    if (ret == ESP_OK) {
        esp_restart();
    } else {
        return ESP_FAIL;
    }
    return ESP_OK;
}
```

#### 服务器验证

验证服务器时，应将 PEM 格式的根证书提供给 `esp_http_client_config_t::cert_pem` 成员。如需了解有关服务器验证的更多信息，请参阅 [TLS 服务器验证](#)。

---

**备注：** 应使用服务器端点的 **根证书** 应用于验证，而不能使用证书链中的任何中间证书，因为根证书有效期最长，且通常长时间维持不变。用户还可以通过 `esp_http_client_config_t::cert_bundle_attach` 成员使用 ESP x509 证书包功能进行验证，其中涵盖了大多数受信任的根证书。

---

#### 通过 HTTPS 下载部分镜像

要使用部分镜像下载功能，请启用 `esp_https_ota_config_t` 中的 `partial_http_download` 配置。启用此配置后，固件镜像将通过多个指定大小的 HTTP 请求进行下载。将 `max_http_request_size` 设置为所需值，即可指定每个请求的最大内容长度。

在从 AWS S3 等服务获取镜像时，这一选项非常有用。在启用该选项时，可以将 mbedTLS Rx 的 buffer 大小（即 `CONFIG_MBEDTLS_SSL_IN_CONTENT_LEN`）设置为较小的值。不启用此配置时，无法将其设置为较小值。

mbedTLS Rx buffer 的默认大小为 16 KB，但如果将 `partial_http_download` 的 `max_http_request_size` 设置为 4 KB，便能将 mbedTLS Rx 的 buffer 减小到 4 KB。使用这一配置方式预计可以节省约 12 KB 内存。

### 签名验证

要进一步提升安全性，还可以验证 OTA 固件镜像的签名。更多内容请参考[没有安全启动的安全 OTA 升级](#)。

### 高级 API

`esp_https_ota` 还提供一些高级 API，用于查看 OTA 过程的更多信息并满足其他控制需求。

如需查看使用高级 ESP\_HTTPS\_OTA API 的示例，请前往 [system/ota/advanced\\_https\\_ota](#)。

### 使用预加密固件进行 OTA 升级

如需使用预加密的固件进行 OTA 升级，请在组件的菜单配置中启用 `CONFIG_ESP_HTTPS_OTA_DECRYPT_CB` 选项。

如需查看使用预加密固件进行 OTA 升级的示例，请前往 [system/ota/pre\\_encrypted\\_ota](#)。

### OTA 系统事件

ESP HTTPS OTA 过程中可能发生各种系统事件。当特定事件发生时，会由[事件循环库](#)触发处理程序。此处理程序必须使用 `esp_event_handler_register()` 注册。这有助于 ESP HTTPS OTA 进行事件处理。

`esp_https_ota_event_t` 中包含了使用 ESP HTTPS OTA 升级时可能发生的所有事件。

### 事件处理程序示例

```
/* 用于捕获系统事件的事件处理程序 */
static void event_handler(void* arg, esp_event_base_t event_base,
                          int32_t event_id, void* event_data)
{
    if (event_base == ESP_HTTPS_OTA_EVENT) {
        switch (event_id) {
            case ESP_HTTPS_OTA_START:
                ESP_LOGI(TAG, "OTA started");
                break;
            case ESP_HTTPS_OTA_CONNECTED:
                ESP_LOGI(TAG, "Connected to server");
                break;
            case ESP_HTTPS_OTA_GET_IMG_DESC:
                ESP_LOGI(TAG, "Reading Image Description");
                break;
            case ESP_HTTPS_OTA_VERIFY_CHIP_ID:
                ESP_LOGI(TAG, "Verifying chip id of new image: %d", *(esp_
↪chip_id_t *)event_data);
                break;
            case ESP_HTTPS_OTA_DECRYPT_CB:
                ESP_LOGI(TAG, "Callback to decrypt function");
                break;
            case ESP_HTTPS_OTA_WRITE_FLASH:
                ESP_LOGD(TAG, "Writing to flash: %d written", *(int_
↪*)event_data);
```

(下页继续)



(续上页)

```

        break;
    case ESP_HTTPS_OTA_UPDATE_BOOT_PARTITION:
        ESP_LOGI(TAG, "Boot partition updated. Next Partition: %d
→", *(esp_partition_subtype_t *)event_data);
        break;
    case ESP_HTTPS_OTA_FINISH:
        ESP_LOGI(TAG, "OTA finish");
        break;
    case ESP_HTTPS_OTA_ABORT:
        ESP_LOGI(TAG, "OTA abort");
        break;
    }
}
}

```

系统事件循环中，不同 ESP HTTPS OTA 事件的预期数据类型如下所示：

- ESP\_HTTPS\_OTA\_START : NULL
- ESP\_HTTPS\_OTA\_CONNECTED : NULL
- ESP\_HTTPS\_OTA\_GET\_IMG\_DESC : NULL
- ESP\_HTTPS\_OTA\_VERIFY\_CHIP\_ID : esp\_chip\_id\_t
- ESP\_HTTPS\_OTA\_DECRYPT\_CB : NULL
- ESP\_HTTPS\_OTA\_WRITE\_FLASH : int
- ESP\_HTTPS\_OTA\_UPDATE\_BOOT\_PARTITION : esp\_partition\_subtype\_t
- ESP\_HTTPS\_OTA\_FINISH : NULL
- ESP\_HTTPS\_OTA\_ABORT : NULL

## API 参考

### Header File

- [components/esp\\_https\\_ota/include/esp\\_https\\_ota.h](#)
- This header file can be included with:

```
#include "esp_https_ota.h"
```

- This header file is a part of the API provided by the esp\_https\_ota component. To declare that your component depends on esp\_https\_ota, add the following to your CMakeLists.txt:

```
REQUIRES esp_https_ota
```

or

```
PRIV_REQUIRES esp_https_ota
```

### Functions

**esp\_err\_t esp\_https\_ota** (const *esp\_https\_ota\_config\_t* \*ota\_config)

HTTPS OTA Firmware upgrade.

This function allocates HTTPS OTA Firmware upgrade context, establishes HTTPS connection, reads image data from HTTP stream and writes it to OTA partition and finishes HTTPS OTA Firmware upgrade operation. This API supports URL redirection, but if CA cert of URLs differ then it should be appended to cert\_pem member of ota\_config->http\_config.

---

**备注：** This API handles the entire OTA operation, so if this API is being used then no other APIs from esp\_https\_ota component should be called. If more information and control is needed during the HTTPS OTA process, then one can use esp\_https\_ota\_begin and subsequent APIs. If this API returns successfully, esp\_restart() must be called to boot from the new firmware image.

---

**参数** `ota_config` -- [in] pointer to `esp_https_ota_config_t` structure.

**返回**

- ESP\_OK: OTA data updated, next reboot will use specified partition.
- ESP\_FAIL: For generic failure.
- ESP\_ERR\_INVALID\_ARG: Invalid argument
- ESP\_ERR\_OTA\_VALIDATE\_FAILED: Invalid app image
- ESP\_ERR\_NO\_MEM: Cannot allocate memory for OTA operation.
- ESP\_ERR\_FLASH\_OP\_TIMEOUT or ESP\_ERR\_FLASH\_OP\_FAIL: Flash write failed.
- For other return codes, refer OTA documentation in esp-idf's app\_update component.

`esp_err_t esp_https_ota_begin` (const `esp_https_ota_config_t` \*ota\_config, `esp_https_ota_handle_t` \*handle)

Start HTTPS OTA Firmware upgrade.

This function initializes ESP HTTPS OTA context and establishes HTTPS connection. This function must be invoked first. If this function returns successfully, then `esp_https_ota_perform` should be called to continue with the OTA process and there should be a call to `esp_https_ota_finish` on completion of OTA operation or on failure in subsequent operations. This API supports URL redirection, but if CA cert of URLs differ then it should be appended to `cert_pem` member of `http_config`, which is a part of `ota_config`. In case of error, this API explicitly sets `handle` to NULL.

---

**备注:** This API is blocking, so setting `is_async` member of `http_config` structure will result in an error.

---

**参数**

- `ota_config` -- [in] pointer to `esp_https_ota_config_t` structure
- `handle` -- [out] pointer to an allocated data of type `esp_https_ota_handle_t` which will be initialised in this function

**返回**

- ESP\_OK: HTTPS OTA Firmware upgrade context initialised and HTTPS connection established
- ESP\_FAIL: For generic failure.
- ESP\_ERR\_INVALID\_ARG: Invalid argument (missing/incorrect config, certificate, etc.)
- For other return codes, refer documentation in app\_update component and `esp_http_client` component in esp-idf.

`esp_err_t esp_https_ota_perform` (`esp_https_ota_handle_t` https\_ota\_handle)

Read image data from HTTP stream and write it to OTA partition.

This function reads image data from HTTP stream and writes it to OTA partition. This function must be called only if `esp_https_ota_begin()` returns successfully. This function must be called in a loop since it returns after every HTTP read operation thus giving you the flexibility to stop OTA operation midway.

**参数** `https_ota_handle` -- [in] pointer to `esp_https_ota_handle_t` structure

**返回**

- ESP\_ERR\_HTTPS\_OTA\_IN\_PROGRESS: OTA update is in progress, call this API again to continue.
- ESP\_OK: OTA update was successful
- ESP\_FAIL: OTA update failed
- ESP\_ERR\_INVALID\_ARG: Invalid argument
- ESP\_ERR\_INVALID\_VERSION: Invalid chip revision in image header
- ESP\_ERR\_OTA\_VALIDATE\_FAILED: Invalid app image
- ESP\_ERR\_NO\_MEM: Cannot allocate memory for OTA operation.
- ESP\_ERR\_FLASH\_OP\_TIMEOUT or ESP\_ERR\_FLASH\_OP\_FAIL: Flash write failed.
- For other return codes, refer OTA documentation in esp-idf's app\_update component.

bool **esp\_https\_ota\_is\_complete\_data\_received** (*esp\_https\_ota\_handle\_t* https\_ota\_handle)

Checks if complete data was received or not.

---

**备注:** This API can be called just before `esp_https_ota_finish()` to validate if the complete image was indeed received.

---

**参数** `https_ota_handle` -- [in] pointer to `esp_https_ota_handle_t` structure

**返回**

- false
- true

*esp\_err\_t* **esp\_https\_ota\_finish** (*esp\_https\_ota\_handle\_t* https\_ota\_handle)

Clean-up HTTPS OTA Firmware upgrade and close HTTPS connection.

This function closes the HTTP connection and frees the ESP HTTPS OTA context. This function switches the boot partition to the OTA partition containing the new firmware image.

---

**备注:** If this API returns successfully, `esp_restart()` must be called to boot from the new firmware image. `esp_https_ota_finish` should not be called after calling `esp_https_ota_abort`

---

**参数** `https_ota_handle` -- [in] pointer to `esp_https_ota_handle_t` structure

**返回**

- ESP\_OK: Clean-up successful
- ESP\_ERR\_INVALID\_STATE
- ESP\_ERR\_INVALID\_ARG: Invalid argument
- ESP\_ERR\_OTA\_VALIDATE\_FAILED: Invalid app image

*esp\_err\_t* **esp\_https\_ota\_abort** (*esp\_https\_ota\_handle\_t* https\_ota\_handle)

Clean-up HTTPS OTA Firmware upgrade and close HTTPS connection.

This function closes the HTTP connection and frees the ESP HTTPS OTA context.

---

**备注:** `esp_https_ota_abort` should not be called after calling `esp_https_ota_finish`

---

**参数** `https_ota_handle` -- [in] pointer to `esp_https_ota_handle_t` structure

**返回**

- ESP\_OK: Clean-up successful
- ESP\_ERR\_INVALID\_STATE: Invalid ESP HTTPS OTA state
- ESP\_FAIL: OTA not started
- ESP\_ERR\_NOT\_FOUND: OTA handle not found
- ESP\_ERR\_INVALID\_ARG: Invalid argument

*esp\_err\_t* **esp\_https\_ota\_get\_img\_desc** (*esp\_https\_ota\_handle\_t* https\_ota\_handle, *esp\_app\_desc\_t* \*new\_app\_info)

Reads app description from image header. The app description provides information like the "Firmware version" of the image.

---

**备注:** This API can be called only after `esp_https_ota_begin()` and before `esp_https_ota_perform()`. Calling this API is not mandatory.

---

**参数**

- `https_ota_handle` -- [in] pointer to `esp_https_ota_handle_t` structure

- **new\_app\_info** -- [out] pointer to an allocated *esp\_app\_desc\_t* structure
- 返回
- ESP\_ERR\_INVALID\_ARG: Invalid arguments
  - ESP\_ERR\_INVALID\_STATE: Invalid state to call this API. esp\_https\_ota\_begin() not called yet.
  - ESP\_FAIL: Failed to read image descriptor
  - ESP\_OK: Successfully read image descriptor

int **esp\_https\_ota\_get\_image\_len\_read** (*esp\_https\_ota\_handle\_t* https\_ota\_handle)

This function returns OTA image data read so far.

---

**备注:** This API should be called only if esp\_https\_ota\_perform() has been called at least once or if esp\_https\_ota\_get\_img\_desc has been called before.

---

**参数 https\_ota\_handle** -- [in] pointer to esp\_https\_ota\_handle\_t structure

返回

- -1 On failure
- total bytes read so far

int **esp\_https\_ota\_get\_image\_size** (*esp\_https\_ota\_handle\_t* https\_ota\_handle)

This function returns OTA image total size.

---

**备注:** This API should be called after esp\_https\_ota\_begin() has been already called. This can be used to create some sort of progress indication (in combination with esp\_https\_ota\_get\_image\_len\_read())

---

**参数 https\_ota\_handle** -- [in] pointer to esp\_https\_ota\_handle\_t structure

返回

- -1 On failure or chunked encoding
- total bytes of image

## Structures

struct **esp\_https\_ota\_config\_t**

ESP HTTPS OTA configuration.

## Public Members

const *esp\_http\_client\_config\_t* \***http\_config**

ESP HTTP client configuration

*http\_client\_init\_cb\_t* **http\_client\_init\_cb**

Callback after ESP HTTP client is initialised

bool **bulk\_flash\_erase**

Erase entire flash partition during initialization. By default flash partition is erased during write operation and in chunk of 4K sector size

bool **partial\_http\_download**

Enable Firmware image to be downloaded over multiple HTTP requests

int **max\_http\_request\_size**

Maximum request size for partial HTTP download

uint32\_t **buffer\_caps**

The memory capability to use when allocating the buffer for OTA update. Default capability is MAL-LOC\_CAP\_DEFAULT

### Macros

**ESP\_ERR\_HTTPS\_OTA\_BASE**

**ESP\_ERR\_HTTPS\_OTA\_IN\_PROGRESS**

### Type Definitions

typedef void \***esp\_https\_ota\_handle\_t**

typedef *esp\_err\_t* (\***http\_client\_init\_cb\_t**)(*esp\_http\_client\_handle\_t*)

### Enumerations

enum **esp\_https\_ota\_event\_t**

Events generated by OTA process.

*Values:*

enumerator **ESP\_HTTPS\_OTA\_START**

OTA started

enumerator **ESP\_HTTPS\_OTA\_CONNECTED**

Connected to server

enumerator **ESP\_HTTPS\_OTA\_GET\_IMG\_DESC**

Read app description from image header

enumerator **ESP\_HTTPS\_OTA\_VERIFY\_CHIP\_ID**

Verify chip id of new image

enumerator **ESP\_HTTPS\_OTA\_DECRYPT\_CB**

Callback to decrypt function

enumerator **ESP\_HTTPS\_OTA\_WRITE\_FLASH**

Flash write operation

enumerator **ESP\_HTTPS\_OTA\_UPDATE\_BOOT\_PARTITION**

Boot partition update after successful ota update

enumerator **ESP\_HTTPS\_OTA\_FINISH**

OTA finished

enumerator **ESP\_HTTPS\_OTA\_ABORT**

OTA aborted

## 2.10.10 事件循环库

### 概述

事件循环库使组件能够声明事件，允许其他组件注册处理程序（即在事件发生时执行的代码片段）。此时，无需直接涉及应用程序，松散耦合组件也能够其他组件状态变化时附加所需的行为。此外，通过将代码执行序列化，在指定的任务中运行事件循环库，可以简化事件处理程序，实现更高效的事件处理。

**备注：** 蓝牙栈各模块通过调用专用回调函数向应用程序传递事件，而非通过事件循环库传递。

### 调用 `esp_event` API

使用事件循环库时应注意区分“事件”与“事件循环”。

事件表示重要的发生事件，如 Wi-Fi 成功连接到接入点。引用事件时应使用由两部分组成的标识符，详情请参阅[事件定义与事件声明](#)。事件循环是连接事件和事件处理程序之间的桥梁，事件源通过使用事件循环库提供的 API 将事件发布到事件循环中，注册到事件循环中的事件处理程序会响应特定类型的事件。

以下为事件循环库的使用流程：

1. 定义一个函数，并在事件发布到事件循环中时运行该函数。此函数被称为事件处理程序，应具有与 `esp_event_handler_t` 同类型的签名。
2. 调用 `esp_event_loop_create()` 创建事件循环，该函数输出类型为 `esp_event_loop_handle_t` 的循环句柄，使用此 API 创建的事件循环称为用户事件循环。另有一种特殊事件循环，请参阅[默认事件循环](#)。
3. 调用 `esp_event_handler_register_with()` 将事件处理程序注册到循环中。处理程序可以注册到多个循环中，请参阅[注册处理程序注意事项](#)。
4. 事件源调用 `esp_event_post_to()` 将事件发布到事件循环中。
5. 调用 `esp_event_handler_unregister_with()`，组件可以在事件循环中取消注册事件处理程序。
6. 调用 `esp_event_loop_delete()` 删除不再需要的事件循环。

上述流程代码如下：

```
// 1. 定义事件处理程序
void run_on_event(void* handler_arg, esp_event_base_t base, int32_t id, void*_
↳event_data)
{
    // 事件处理程序逻辑
}

void app_main()
{
    // 2. 用一个类型为 esp_event_loop_args_t_
↳的配置结构体，指定所创建循环的属性。获取一个类型为 esp_event_loop_handle_t_
↳的句柄，用于其他 API 引用循环、执行操作。
    esp_event_loop_args_t loop_args = {
        .queue_size = ...,
        .task_name = ...
        .task_priority = ...,
        .task_stack_size = ...,
    }
```

(下页继续)

```

        .task_core_id = ...
    };

    esp_event_loop_handle_t loop_handle;

    esp_event_loop_create(&loop_args, &loop_handle);

    // 3. 注册在 (1) 中定义的事件处理程序。MY_EVENT_BASE 和 MY_EVENT_ID_
    ↪指定了一个假设事件：将处理程序 run_on_event 发布到循环中时，执行该处理程序。
    esp_event_handler_register_with(loop_handle, MY_EVENT_BASE, MY_EVENT_ID, run_
    ↪on_event, ...);

    ...

    // 4.
    ↪将事件发布到循环中。此时，事件排入事件循环队列，在某个时刻，事件循环会执行已注册到发布事件的事件
    ↪run_on_event。为简化过程，此示例从 app_main 调用 esp_event_post_
    ↪to，实际应用中可从任何其他任务中发布事件。
    esp_event_post_to(loop_handle, MY_EVENT_BASE, MY_EVENT_ID, ...);

    ...

    // 5. 注销无用的处理程序。
    esp_event_handler_unregister_with(loop_handle, MY_EVENT_BASE, MY_EVENT_ID, run_
    ↪on_event);

    ...

    // 6. 删除无用的事件循环。
    esp_event_loop_delete(loop_handle);
}

```

## 事件定义与事件声明

如前所述，事件标识符由两部分组成：事件根基和事件 ID。事件根基标识独立的事件组；事件 ID 标识组中的特定事件。可以将事件根基和事件 ID 类比为人的姓和名，姓表示一个家族，名表示家族中的某个人。

事件循环库提供了宏以便声明和定义事件根基。

声明事件根基：

```
ESP_EVENT_DECLARE_BASE(EVENT_BASE);
```

定义事件根基：

```
ESP_EVENT_DEFINE_BASE(EVENT_BASE);
```

**备注：**在 ESP-IDF 中，系统事件的根基标识符为大写字母，并以 `_EVENT` 结尾。例如，Wi-Fi 事件的根基声明为 `WIFI_EVENT`，以太网的事件根基声明为 `ETHERNET_EVENT` 等。这样一来，事件根基与常量类似（尽管根据宏 `ESP_EVENT_DECLARE_BASE` 和 `ESP_EVENT_DEFINE_BASE` 的定义，它们属于全局变量）。

建议以枚举类型声明事件 ID，它们通常放在公共头文件中。

事件 ID：

```
enum {
    EVENT_ID_1,
    EVENT_ID_2,
    EVENT_ID_3,
    ...
}
```

## 默认事件循环

默认事件循环是一种特殊循环，用于处理系统事件（如 Wi-Fi 事件）。用户无法使用该循环的句柄，创建、删除、注册/注销处理程序以及事件发布均通过用户事件循环 API 的变体完成，下表列出了这些变体及其对应用户事件循环。

用户事件循环	默认事件循环
<code>esp_event_loop_create()</code>	<code>esp_event_loop_create_default()</code>
<code>esp_event_loop_delete()</code>	<code>esp_event_loop_delete_default()</code>
<code>esp_event_handler_register_with()</code>	<code>esp_event_handler_register()</code>
<code>esp_event_handler_unregister_with()</code>	<code>esp_event_handler_unregister()</code>
<code>esp_event_post_to()</code>	<code>esp_event_post()</code>

比较二者签名可知，它们大部分是相似的，唯一区别在于默认事件循环的 API 不需要指定循环句柄。

除了 API 的差异和用于系统事件的特殊分类外，默认事件循环和用户事件循环的行为并无差异。实际上，用户甚至可以将自己的事件发布到默认事件循环中，以节省内存而无需创建自己的循环。

## 注册处理程序注意事项

通过重复调用 `esp_event_handler_register_with()`，可以将单个处理程序独立注册到多个事件中，且每次调用均可指定处理程序应执行的具体事件根基和事件 ID。

然而，在某些情况下，你可能希望处理程序在以下情况时执行：

- (1) 所有发布到循环的事件
- (2) 特定基本标识符的所有事件

为此，可调用特殊的事件根基标识符 `ESP_EVENT_ANY_BASE` 和特殊的事件 `ESP_EVENT_ANY_ID` 实现，这些特殊标识符可以作为 `esp_event_handler_register_with()` 的事件根基和事件 ID 参数传递。

因此 `esp_event_handler_register_with()` 的有效参数为：

1. `<event base>`, `<event ID>` - 根基为 `<event base>` 且 ID 为 `<event ID>` 的事件发布到循环中时，执行处理程序。
2. `<event base>`, `ESP_EVENT_ANY_ID` - 任何根基为 `<event base>` 的事件发布到循环中时，执行处理程序。
3. `ESP_EVENT_ANY_BASE`, `ESP_EVENT_ANY_ID` - 任何事件发布到循环中时，执行处理程序。

例如，如果注册了以下处理程序：

```
esp_event_handler_register_with(loop_handle, MY_EVENT_BASE, MY_EVENT_ID, run_on_
↳event_1, ...);
esp_event_handler_register_with(loop_handle, MY_EVENT_BASE, ESP_EVENT_ANY_ID, run_
↳on_event_2, ...);
esp_event_handler_register_with(loop_handle, ESP_EVENT_ANY_BASE, ESP_EVENT_ANY_ID,
↳run_on_event_3, ...);
```

如果假设事件由 `MY_EVENT_BASE` 和 `MY_EVENT_ID` 组成，则三个处理程序 `run_on_event_1`、`run_on_event_2` 和 `run_on_event_3` 都会执行。



如果假设事件由 MY\_EVENT\_BASE 和 MY\_OTHER\_EVENT\_ID 组成，则仅执行处理程序 run\_on\_event\_2 和 run\_on\_event\_3。

如果假设事件由 MY\_OTHER\_EVENT\_BASE 和 MY\_OTHER\_EVENT\_ID 组成，则仅执行处理程序 run\_on\_event\_3。

**处理程序自行注销** 通常情况下，由事件循环运行的事件处理程序 **不允许在该事件循环上执行任何注册/注销活动**，但允许处理程序自行注销。例如，可以执行以下操作：

```
void run_on_event(void* handler_arg, esp_event_base_t base, int32_t id, void*
↳event_data)
{
    esp_event_loop_handle_t *loop_handle = (esp_event_loop_handle_t*) handler_arg;
    esp_event_handler_unregister_with(*loop_handle, MY_EVENT_BASE, MY_EVENT_ID,
↳run_on_event);
}

void app_main(void)
{
    esp_event_loop_handle_t loop_handle;
    esp_event_loop_create(&loop_args, &loop_handle);
    esp_event_handler_register_with(loop_handle, MY_EVENT_BASE, MY_EVENT_ID, run_
↳on_event, &loop_handle);
    // ... 发布事件 MY_EVENT_BASE 和 MY_EVENT_ID, 并在某些时候运行循环
}
```

**注册处理程序及处理程序调度顺序** 一般而言，对于在调度期间与某个已发布事件匹配的处理程序，先注册的也会先执行。在所有注册均使用单个任务执行的情况下，可以通过在其他处理程序注册前注册目标处理程序，控制处理程序的执行顺序。如果计划利用这一规则，在有多个任务注册处理程序的情况下要多加小心。此时，虽然“先注册，先执行”的规则仍然成立，但率先执行的任务也会率先注册其处理程序，而由单个任务连续注册的处理函数仍然按相对顺序调度。但如果该任务在注册期间被另一个任务抢占，而该任务还注册了处理程序，则在调度期间，那些处理程序也将在处理其他任务时执行。

## 事件循环性能分析

要启动数据收集，统计所有已创建事件循环的数据，请激活配置选项 `CONFIG_ESP_EVENT_LOOP_PROFILING`，函数 `esp_event_dump()` 可将收集的统计数据输出到文件流中。有关转储信息的更多详情，请参阅 `esp_event_dump()` API 参考。

## 应用示例

使用 `esp_event` 库的示例存放在 `system/esp_event` 中，涵盖事件声明、循环创建、处理程序注册和注销以及事件发布。

其他使用 `esp_event` 库的示例：

- [NMEA Parser](#)，该示例将解码从 GPS 接收到的语句。

## API 参考

### Header File

- `components/esp_event/include/esp_event.h`
- This header file can be included with:

```
#include "esp_event.h"
```

- This header file is a part of the API provided by the `esp_event` component. To declare that your component depends on `esp_event`, add the following to your `CMakeLists.txt`:

```
REQUIRES esp_event
```

or

```
PRIV_REQUIRES esp_event
```

## Functions

*esp\_err\_t* **esp\_event\_loop\_create** (const *esp\_event\_loop\_args\_t* \*event\_loop\_args, *esp\_event\_loop\_handle\_t* \*event\_loop)

Create a new event loop.

### 参数

- **event\_loop\_args** -- [in] configuration structure for the event loop to create
- **event\_loop** -- [out] handle to the created event loop

### 返回

- ESP\_OK: Success
- ESP\_ERR\_INVALID\_ARG: event\_loop\_args or event\_loop was NULL
- ESP\_ERR\_NO\_MEM: Cannot allocate memory for event loops list
- ESP\_FAIL: Failed to create task loop
- Others: Fail

*esp\_err\_t* **esp\_event\_loop\_delete** (*esp\_event\_loop\_handle\_t* event\_loop)

Delete an existing event loop.

**参数** **event\_loop** -- [in] event loop to delete, must not be NULL

### 返回

- ESP\_OK: Success
- Others: Fail

*esp\_err\_t* **esp\_event\_loop\_create\_default** (void)

Create default event loop.

### 返回

- ESP\_OK: Success
- ESP\_ERR\_NO\_MEM: Cannot allocate memory for event loops list
- ESP\_ERR\_INVALID\_STATE: Default event loop has already been created
- ESP\_FAIL: Failed to create task loop
- Others: Fail

*esp\_err\_t* **esp\_event\_loop\_delete\_default** (void)

Delete the default event loop.

### 返回

- ESP\_OK: Success
- Others: Fail

*esp\_err\_t* **esp\_event\_loop\_run** (*esp\_event\_loop\_handle\_t* event\_loop, TickType\_t ticks\_to\_run)

Dispatch events posted to an event loop.

This function is used to dispatch events posted to a loop with no dedicated task, i.e. task name was set to NULL in event\_loop\_args argument during loop creation. This function includes an argument to limit the amount of time it runs, returning control to the caller when that time expires (or some time afterwards). There is no guarantee that a call to this function will exit at exactly the time of expiry. There is also no guarantee that events have been dispatched during the call, as the function might have spent all the allotted time waiting on the event queue. Once an event has been dequeued, however, it is guaranteed to be dispatched. This guarantee contributes to not being able to exit exactly at time of expiry as (1) blocking on internal mutexes is necessary for dispatching the dequeued event, and (2) during dispatch of the dequeued event there is no way to control the time occupied by handler code execution. The guaranteed time of exit is therefore the allotted time + amount of time required to dispatch the last dequeued event.

In cases where waiting on the queue times out, ESP\_OK is returned and not ESP\_ERR\_TIMEOUT, since it is normal behavior.

---

**备注:** encountering an unknown event that has been posted to the loop will only generate a warning, not an error.

---

#### 参数

- **event\_loop** -- **[in]** event loop to dispatch posted events from, must not be NULL
- **ticks\_to\_run** -- **[in]** number of ticks to run the loop

#### 返回

- ESP\_OK: Success
- Others: Fail

*esp\_err\_t* **esp\_event\_handler\_register** (*esp\_event\_base\_t* event\_base, int32\_t event\_id, *esp\_event\_handler\_t* event\_handler, void \*event\_handler\_arg)

Register an event handler to the system event loop (legacy).

This function can be used to register a handler for either: (1) specific events, (2) all events of a certain event base, or (3) all events known by the system event loop.

- specific events: specify exact event\_base and event\_id
- all events of a certain base: specify exact event\_base and use ESP\_EVENT\_ANY\_ID as the event\_id
- all events known by the loop: use ESP\_EVENT\_ANY\_BASE for event\_base and ESP\_EVENT\_ANY\_ID as the event\_id

Registering multiple handlers to events is possible. Registering a single handler to multiple events is also possible. However, registering the same handler to the same event multiple times would cause the previous registrations to be overwritten.

---

**备注:** the event loop library does not maintain a copy of event\_handler\_arg, therefore the user should ensure that event\_handler\_arg still points to a valid location by the time the handler gets called

---

#### 参数

- **event\_base** -- **[in]** the base ID of the event to register the handler for
- **event\_id** -- **[in]** the ID of the event to register the handler for
- **event\_handler** -- **[in]** the handler function which gets called when the event is dispatched
- **event\_handler\_arg** -- **[in]** data, aside from event data, that is passed to the handler when it is called

#### 返回

- ESP\_OK: Success
- ESP\_ERR\_NO\_MEM: Cannot allocate memory for the handler
- ESP\_ERR\_INVALID\_ARG: Invalid combination of event base and event ID
- Others: Fail

*esp\_err\_t* **esp\_event\_handler\_register\_with** (*esp\_event\_loop\_handle\_t* event\_loop, *esp\_event\_base\_t* event\_base, int32\_t event\_id, *esp\_event\_handler\_t* event\_handler, void \*event\_handler\_arg)

Register an event handler to a specific loop (legacy).

This function behaves in the same manner as esp\_event\_handler\_register, except the additional specification of the event loop to register the handler to.

---

**备注:** the event loop library does not maintain a copy of `event_handler_arg`, therefore the user should ensure that `event_handler_arg` still points to a valid location by the time the handler gets called

---

### 参数

- **event\_loop** -- **[in]** the event loop to register this handler function to, must not be NULL
- **event\_base** -- **[in]** the base ID of the event to register the handler for
- **event\_id** -- **[in]** the ID of the event to register the handler for
- **event\_handler** -- **[in]** the handler function which gets called when the event is dispatched
- **event\_handler\_arg** -- **[in]** data, aside from event data, that is passed to the handler when it is called

### 返回

- ESP\_OK: Success
- ESP\_ERR\_NO\_MEM: Cannot allocate memory for the handler
- ESP\_ERR\_INVALID\_ARG: Invalid combination of event base and event ID
- Others: Fail

```
esp_err_t esp_event_handler_instance_register_with(esp_event_loop_handle_t event_loop,
                                                    esp_event_base_t event_base, int32_t
                                                    event_id, esp_event_handler_t
                                                    event_handler, void *event_handler_arg,
                                                    esp_event_handler_instance_t *instance)
```

Register an instance of event handler to a specific loop.

This function can be used to register a handler for either: (1) specific events, (2) all events of a certain event base, or (3) all events known by the system event loop.

- specific events: specify exact `event_base` and `event_id`
- all events of a certain base: specify exact `event_base` and use `ESP_EVENT_ANY_ID` as the `event_id`
- all events known by the loop: use `ESP_EVENT_ANY_BASE` for `event_base` and `ESP_EVENT_ANY_ID` as the `event_id`

Besides the error, the function returns an instance object as output parameter to identify each registration. This is necessary to remove (unregister) the registration before the event loop is deleted.

Registering multiple handlers to events, registering a single handler to multiple events as well as registering the same handler to the same event multiple times is possible. Each registration yields a distinct instance object which identifies it over the registration lifetime.

---

**备注:** the event loop library does not maintain a copy of `event_handler_arg`, therefore the user should ensure that `event_handler_arg` still points to a valid location by the time the handler gets called

---



---

**备注:** Calling this function with `instance` set to NULL is equivalent to calling `esp_event_handler_register_with`.

---

### 参数

- **event\_loop** -- **[in]** the event loop to register this handler function to, must not be NULL
- **event\_base** -- **[in]** the base ID of the event to register the handler for
- **event\_id** -- **[in]** the ID of the event to register the handler for
- **event\_handler** -- **[in]** the handler function which gets called when the event is dispatched
- **event\_handler\_arg** -- **[in]** data, aside from event data, that is passed to the handler when it is called

- **instance** -- **[out]** An event handler instance object related to the registered event handler and data, can be NULL. This needs to be kept if the specific callback instance should be unregistered before deleting the whole event loop. Registering the same event handler multiple times is possible and yields distinct instance objects. The data can be the same for all registrations. If no unregistration is needed, but the handler should be deleted when the event loop is deleted, instance can be NULL.

#### 返回

- ESP\_OK: Success
- ESP\_ERR\_NO\_MEM: Cannot allocate memory for the handler
- ESP\_ERR\_INVALID\_ARG: Invalid combination of event base and event ID or instance is NULL
- Others: Fail

```
esp_err_t esp_event_handler_instance_register(esp_event_base_t event_base, int32_t event_id,
                                             esp_event_handler_t event_handler, void
                                             *event_handler_arg,
                                             esp_event_handler_instance_t *instance)
```

Register an instance of event handler to the default loop.

This function does the same as `esp_event_handler_instance_register_with`, except that it registers the handler to the default event loop.

---

**备注:** the event loop library does not maintain a copy of `event_handler_arg`, therefore the user should ensure that `event_handler_arg` still points to a valid location by the time the handler gets called

---



---

**备注:** Calling this function with instance set to NULL is equivalent to calling `esp_event_handler_register`.

---

#### 参数

- **event\_base** -- **[in]** the base ID of the event to register the handler for
- **event\_id** -- **[in]** the ID of the event to register the handler for
- **event\_handler** -- **[in]** the handler function which gets called when the event is dispatched
- **event\_handler\_arg** -- **[in]** data, aside from event data, that is passed to the handler when it is called
- **instance** -- **[out]** An event handler instance object related to the registered event handler and data, can be NULL. This needs to be kept if the specific callback instance should be unregistered before deleting the whole event loop. Registering the same event handler multiple times is possible and yields distinct instance objects. The data can be the same for all registrations. If no unregistration is needed, but the handler should be deleted when the event loop is deleted, instance can be NULL.

#### 返回

- ESP\_OK: Success
- ESP\_ERR\_NO\_MEM: Cannot allocate memory for the handler
- ESP\_ERR\_INVALID\_ARG: Invalid combination of event base and event ID or instance is NULL
- Others: Fail

```
esp_err_t esp_event_handler_unregister(esp_event_base_t event_base, int32_t event_id,
                                       esp_event_handler_t event_handler)
```

Unregister a handler with the system event loop (legacy).

Unregisters a handler, so it will no longer be called during dispatch. Handlers can be unregistered for any combination of `event_base` and `event_id` which were previously registered. To unregister a handler, the `event_base` and `event_id` arguments must match exactly the arguments passed to `esp_event_handler_register()` when that handler was registered. Passing `ESP_EVENT_ANY_BASE` and/or `ESP_EVENT_ANY_ID` will only unregister handlers that were registered with the same wildcard arguments.

---

**备注:** When using ESP\_EVENT\_ANY\_ID, handlers registered to specific event IDs using the same base will not be unregistered. When using ESP\_EVENT\_ANY\_BASE, events registered to specific bases will also not be unregistered. This avoids accidental unregistration of handlers registered by other users or components.

---

**参数**

- **event\_base** -- **[in]** the base of the event with which to unregister the handler
- **event\_id** -- **[in]** the ID of the event with which to unregister the handler
- **event\_handler** -- **[in]** the handler to unregister

返回 ESP\_OK success

返回 ESP\_ERR\_INVALID\_ARG invalid combination of event base and event ID

返回 others fail

*esp\_err\_t* **esp\_event\_handler\_unregister\_with** (*esp\_event\_loop\_handle\_t* event\_loop, *esp\_event\_base\_t* event\_base, int32\_t event\_id, *esp\_event\_handler\_t* event\_handler)

Unregister a handler from a specific event loop (legacy).

This function behaves in the same manner as `esp_event_handler_unregister`, except the additional specification of the event loop to unregister the handler with.

**参数**

- **event\_loop** -- **[in]** the event loop with which to unregister this handler function, must not be NULL
- **event\_base** -- **[in]** the base of the event with which to unregister the handler
- **event\_id** -- **[in]** the ID of the event with which to unregister the handler
- **event\_handler** -- **[in]** the handler to unregister

**返回**

- ESP\_OK: Success
- ESP\_ERR\_INVALID\_ARG: Invalid combination of event base and event ID
- Others: Fail

*esp\_err\_t* **esp\_event\_handler\_instance\_unregister\_with** (*esp\_event\_loop\_handle\_t* event\_loop, *esp\_event\_base\_t* event\_base, int32\_t event\_id, *esp\_event\_handler\_instance\_t* instance)

Unregister a handler instance from a specific event loop.

Unregisters a handler instance, so it will no longer be called during dispatch. Handler instances can be unregistered for any combination of `event_base` and `event_id` which were previously registered. To unregister a handler instance, the `event_base` and `event_id` arguments must match exactly the arguments passed to `esp_event_handler_instance_register()` when that handler instance was registered. Passing `ESP_EVENT_ANY_BASE` and/or `ESP_EVENT_ANY_ID` will only unregister handler instances that were registered with the same wildcard arguments.

---

**备注:** When using ESP\_EVENT\_ANY\_ID, handlers registered to specific event IDs using the same base will not be unregistered. When using ESP\_EVENT\_ANY\_BASE, events registered to specific bases will also not be unregistered. This avoids accidental unregistration of handlers registered by other users or components.

---

**参数**

- **event\_loop** -- **[in]** the event loop with which to unregister this handler function, must not be NULL
- **event\_base** -- **[in]** the base of the event with which to unregister the handler
- **event\_id** -- **[in]** the ID of the event with which to unregister the handler
- **instance** -- **[in]** the instance object of the registration to be unregistered

**返回**

- ESP\_OK: Success

- ESP\_ERR\_INVALID\_ARG: Invalid combination of event base and event ID
- Others: Fail

*esp\_err\_t* **esp\_event\_handler\_instance\_unregister** (*esp\_event\_base\_t* event\_base, *int32\_t* event\_id, *esp\_event\_handler\_instance\_t* instance)

Unregister a handler from the system event loop.

This function does the same as `esp_event_handler_instance_unregister_with`, except that it unregisters the handler instance from the default event loop.

#### 参数

- **event\_base** -- [in] the base of the event with which to unregister the handler
- **event\_id** -- [in] the ID of the event with which to unregister the handler
- **instance** -- [in] the instance object of the registration to be unregistered

#### 返回

- ESP\_OK: Success
- ESP\_ERR\_INVALID\_ARG: Invalid combination of event base and event ID
- Others: Fail

*esp\_err\_t* **esp\_event\_post** (*esp\_event\_base\_t* event\_base, *int32\_t* event\_id, const void \*event\_data, *size\_t* event\_data\_size, *TickType\_t* ticks\_to\_wait)

Posts an event to the system default event loop. The event loop library keeps a copy of event\_data and manages the copy's lifetime automatically (allocation + deletion); this ensures that the data the handler receives is always valid.

#### 参数

- **event\_base** -- [in] the event base that identifies the event
- **event\_id** -- [in] the event ID that identifies the event
- **event\_data** -- [in] the data, specific to the event occurrence, that gets passed to the handler
- **event\_data\_size** -- [in] the size of the event data
- **ticks\_to\_wait** -- [in] number of ticks to block on a full event queue

#### 返回

- ESP\_OK: Success
- ESP\_ERR\_TIMEOUT: Time to wait for event queue to unblock expired, queue full when posting from ISR
- ESP\_ERR\_INVALID\_ARG: Invalid combination of event base and event ID
- Others: Fail

*esp\_err\_t* **esp\_event\_post\_to** (*esp\_event\_loop\_handle\_t* event\_loop, *esp\_event\_base\_t* event\_base, *int32\_t* event\_id, const void \*event\_data, *size\_t* event\_data\_size, *TickType\_t* ticks\_to\_wait)

Posts an event to the specified event loop. The event loop library keeps a copy of event\_data and manages the copy's lifetime automatically (allocation + deletion); this ensures that the data the handler receives is always valid.

This function behaves in the same manner as `esp_event_post`, except the additional specification of the event loop to post the event to.

#### 参数

- **event\_loop** -- [in] the event loop to post to, must not be NULL
- **event\_base** -- [in] the event base that identifies the event
- **event\_id** -- [in] the event ID that identifies the event
- **event\_data** -- [in] the data, specific to the event occurrence, that gets passed to the handler
- **event\_data\_size** -- [in] the size of the event data
- **ticks\_to\_wait** -- [in] number of ticks to block on a full event queue

#### 返回

- ESP\_OK: Success
- ESP\_ERR\_TIMEOUT: Time to wait for event queue to unblock expired, queue full when posting from ISR



- ESP\_ERR\_INVALID\_ARG: Invalid combination of event base and event ID
- Others: Fail

*esp\_err\_t* **esp\_event\_isr\_post** (*esp\_event\_base\_t* event\_base, *int32\_t* event\_id, const void \*event\_data, *size\_t* event\_data\_size,  *BaseType\_t* \*task\_unblocked)

Special variant of `esp_event_post` for posting events from interrupt handlers.

---

**备注:** this function is only available when `CONFIG_ESP_EVENT_POST_FROM_ISR` is enabled

---



---

**备注:** when this function is called from an interrupt handler placed in IRAM, this function should be placed in IRAM as well by enabling `CONFIG_ESP_EVENT_POST_FROM_IRAM_ISR`

---

#### 参数

- **event\_base** -- **[in]** the event base that identifies the event
- **event\_id** -- **[in]** the event ID that identifies the event
- **event\_data** -- **[in]** the data, specific to the event occurrence, that gets passed to the handler
- **event\_data\_size** -- **[in]** the size of the event data; max is 4 bytes
- **task\_unblocked** -- **[out]** an optional parameter (can be NULL) which indicates that an event task with higher priority than currently running task has been unblocked by the posted event; a context switch should be requested before the interrupt is existed.

#### 返回

- ESP\_OK: Success
- ESP\_FAIL: Event queue for the default event loop full
- ESP\_ERR\_INVALID\_ARG: Invalid combination of event base and event ID, data size of more than 4 bytes
- Others: Fail

*esp\_err\_t* **esp\_event\_isr\_post\_to** (*esp\_event\_loop\_handle\_t* event\_loop, *esp\_event\_base\_t* event\_base, *int32\_t* event\_id, const void \*event\_data, *size\_t* event\_data\_size,  *BaseType\_t* \*task\_unblocked)

Special variant of `esp_event_post_to` for posting events from interrupt handlers.

---

**备注:** this function is only available when `CONFIG_ESP_EVENT_POST_FROM_ISR` is enabled

---



---

**备注:** when this function is called from an interrupt handler placed in IRAM, this function should be placed in IRAM as well by enabling `CONFIG_ESP_EVENT_POST_FROM_IRAM_ISR`

---

#### 参数

- **event\_loop** -- **[in]** the event loop to post to, must not be NULL
- **event\_base** -- **[in]** the event base that identifies the event
- **event\_id** -- **[in]** the event ID that identifies the event
- **event\_data** -- **[in]** the data, specific to the event occurrence, that gets passed to the handler
- **event\_data\_size** -- **[in]** the size of the event data
- **task\_unblocked** -- **[out]** an optional parameter (can be NULL) which indicates that an event task with higher priority than currently running task has been unblocked by the posted event; a context switch should be requested before the interrupt is existed.

#### 返回

- ESP\_OK: Success
- ESP\_FAIL: Event queue for the loop full



- ESP\_ERR\_INVALID\_ARG: Invalid combination of event base and event ID, data size of more than 4 bytes
- Others: Fail

`esp_err_t esp_event_dump` (FILE \*file)

Dumps statistics of all event loops.

Dumps event loop info in the format:

```

event loop
  handler
  handler
  ...
event loop
  handler
  handler
  ...

where:

event loop
  format: address,name rx:total_received dr:total_dropped
  where:
    address - memory address of the event loop
    name - name of the event loop, 'none' if no dedicated task
    total_received - number of successfully posted events
    total_dropped - number of events unsuccessfully posted due to queue_
→being full

handler
  format: address ev:base,id inv:total_invoked run:total_runtime
  where:
    address - address of the handler function
    base,id - the event specified by event base and ID this handler_
→executes
    total_invoked - number of times this handler has been invoked
    total_runtime - total amount of time used for invoking this handler

```

---

**备注:** this function is a noop when CONFIG\_ESP\_EVENT\_LOOP\_PROFILING is disabled

---

**参数** `file` -- [in] the file stream to output to

**返回**

- ESP\_OK: Success
- ESP\_ERR\_NO\_MEM: Cannot allocate memory for event loops list
- Others: Fail

## Structures

struct `esp_event_loop_args_t`

Configuration for creating event loops.

## Public Members

`int32_t queue_size`

size of the event loop queue

const char \***task\_name**

name of the event loop task; if NULL, a dedicated task is not created for event loop

UBaseType\_t **task\_priority**

priority of the event loop task, ignored if task name is NULL

uint32\_t **task\_stack\_size**

stack size of the event loop task, ignored if task name is NULL

BaseType\_t **task\_core\_id**

core to which the event loop task is pinned to, ignored if task name is NULL

### Header File

- [components/esp\\_event/include/esp\\_event\\_base.h](#)
- This header file can be included with:

```
#include "esp_event_base.h"
```

- This header file is a part of the API provided by the `esp_event` component. To declare that your component depends on `esp_event`, add the following to your `CMakeLists.txt`:

```
REQUIRES esp_event
```

or

```
PRIV_REQUIRES esp_event
```

### Macros

**ESP\_EVENT\_DECLARE\_BASE** (id)

**ESP\_EVENT\_DEFINE\_BASE** (id)

**ESP\_EVENT\_ANY\_BASE**

register handler for any event base

**ESP\_EVENT\_ANY\_ID**

register handler for any event id

### Type Definitions

typedef void \***esp\_event\_loop\_handle\_t**

a number that identifies an event with respect to a base

typedef void (\***esp\_event\_handler\_t**)(void \*event\_handler\_arg, esp\_event\_base\_t event\_base, int32\_t event\_id, void \*event\_data)

function called when an event is posted to the queue

typedef void \***esp\_event\_handler\_instance\_t**

context identifying an instance of a registered event handler

## 相关文档

### 2.10.11 FreeRTOS 概述

#### 概述

FreeRTOS 是一个开源的 RTOS（实时操作系统）内核，它以组件的形式集成到 ESP-IDF 中。因此，所有的 ESP-IDF 应用程序及多种 ESP-IDF 组件都基于 FreeRTOS 编写。FreeRTOS 内核已移植到 ESP 芯片的所有 CPU 架构（即 Xtensa 和 RISC-V）中。

此外，ESP-IDF 还提供了不同的 FreeRTOS 实现，支持在多核 ESP 目标芯片上的 SMP（对称多处理）。本文档主要介绍了 FreeRTOS 组件、ESP-IDF 提供的 FreeRTOS 实现，并简要介绍了这些实现的共同之处。

#### 实现

官方 FreeRTOS（下文称为原生 FreeRTOS）是一个单核 RTOS。为了支持各种多核 ESP 目标芯片，ESP-IDF 支持下述不同的 FreeRTOS 实现。

#### ESP-IDF FreeRTOS

ESP-IDF FreeRTOS 是基于原生 FreeRTOS v10.5.1 的 FreeRTOS 实现，其中包含支持 SMP 的大量更新。ESP-IDF FreeRTOS 最多支持两个核（即双核 SMP），但在设计上对这种场景进行了优化。关于 ESP-IDF FreeRTOS 及具体更新内容，请参考 [FreeRTOS \(IDF\)](#) 文档。

---

**备注：**ESP-IDF FreeRTOS 是目前 ESP-IDF 默认的 FreeRTOS 实现。

---

#### Amazon SMP FreeRTOS

Amazon SMP FreeRTOS 是由 Amazon 官方支持的 FreeRTOS SMP 实现。Amazon SMP FreeRTOS 能够支持 N 核，即双核以上。通过 [CONFIG\\_FREERTOS\\_SMP](#) 选项能够启用 Amazon SMP FreeRTOS。关于 Amazon SMP FreeRTOS 的更多细节，请参考 [官方 Amazon SMP FreeRTOS 文档](#)。

**警告：**Amazon SMP FreeRTOS 实现（及其在 ESP-IDF 中的移植）目前处于试验/测试状态，因此，可能会发生重大的行为变化及 API 变更。

#### 配置

**内核配置** 原生 FreeRTOS 要求移植工具和应用程序通过在 `FreeRTOSConfig.h` 头文件中添加各种 `#define config...` 宏定义来配置内核。原生 FreeRTOS 支持一系列内核配置选项，允许启用或禁用各种内核行为和功能。

然而，对于 ESP-IDF 中的所有 FreeRTOS 移植，`FreeRTOSConfig.h` 头文件被视为私有文件，用户不得修改。由于该选项在 ESP-IDF 中是必选项或不被支持，`FreeRTOSConfig.h` 中的大量内核配置选项均为硬编码。所有用户可配置的内核配置选项都在 `Component Config/FreeRTOS/Kernel` 下的 `menuconfig` 中。

关于用户可配置内核选项的完整列表，参见 [项目配置](#)。下列为常用的内核配置选项：

- `CONFIG_FREERTOS_UNICORE`: 仅在核 0 上运行 FreeRTOS。注意, 这不等同于运行原生 FreeRTOS。另外, 此选项还可能影响除 `freertos` 外其他组件的行为。关于在单核上运行 FreeRTOS 的更多内容, 请参考 [单核模式](#) (使用 ESP-IDF FreeRTOS 时) 或参考 Amazon SMP FreeRTOS 的官方文档, 还可以在 ESP-IDF 组件中搜索 `CONFIG_FREERTOS_UNICORE`。

**备注:** 由于 ESP32-H2 是一个单核 SoC, 所以总是会启用 `CONFIG_FREERTOS_UNICORE` 配置。

- `CONFIG_FREERTOS_ENABLE_BACKWARD_COMPATIBILITY` 可以向后兼容某些 FreeRTOS 宏、类型或函数, 这些宏、类型或函数已在 v8.0 及以上版本中弃用。

**端口配置** 其他不属于内核配置的 FreeRTOS 相关配置选项都在 Component Config/FreeRTOS/Port 下的 `menuconfig` 中。这些选项可以配置以下内容:

- FreeRTOS 端口本身 (如 tick 定时器选择, ISR 堆栈大小)
- 其他添加到 FreeRTOS 实现或端口的功能

## 使用 FreeRTOS

**应用程序入口点** 与原生 FreeRTOS 不同, 在 ESP-IDF 中使用 FreeRTOS 的用户 **永远不应调用** `vTaskStartScheduler()` 和 `vTaskEndScheduler()`。相反, ESP-IDF 会自动启动 FreeRTOS。用户必须定义一个 `void app_main(void)` 函数作为用户应用程序的入口点, 并在 ESP-IDF 启动时自动调用。

- 通常, 用户会从 `app_main` 中启动应用程序的其他任务。
- `app_main` 函数可以在任何时候返回 (应用终止前)。
- `app_main` 函数由 `main` 任务调用。

**后台任务** 在启动过程中, ESP-IDF 和 FreeRTOS 内核会自动创建多个在后台运行的任务, 如下表所示。

表 5: 启动过程创建任务列表

任务名称	描述	堆栈大小	亲和性	优先级
空闲任务 (IDLE <sub>x</sub> )	为每个 CPU 核创建并分配一个空闲任务 (IDLE <sub>x</sub> ), 其中 <i>x</i> 是 CPU 核的编号。当启用单核配置时, <i>x</i> 将被删除。	<code>CON-核</code> <code>FIG_FREERTOS_IDLE_TASK_STACK_SIZE</code>		0
FreeRTOS 定时器任务 (Tmr Svc)	如果应用程序调用了任何 FreeRTOS 定时器 API, FreeRTOS 会创建定时器服务或守护任务	<code>CON-核</code> <code>FIG_FREERTOS_TIMER_TASK_STACK_SIZE</code>		<code>CON-核</code>
主任务 (main)	简单调用 <code>app_main</code> 的任务在 <code>app_main</code> 返回时会自我删除	<code>CON-核</code> <code>FIG_ESP_MAIN_TASK_STACK_SIZE</code>		1
IPC 任务 (ipc <sub>x</sub> )	当 <code>CONFIG_FREERTOS_UNICORE</code> 为假时, 为每个 CPU 核创建并分配一个 IPC 任务 (ipc <sub>x</sub> )。IPC 任务用于实现处理器间调用 (IPC) 功能	<code>CON-核</code> <code>FIG_ESP_IPC_TASK_STACK_SIZE</code>		24
ESP 定时器任务 (esp_timer)	ESP-IDF 创建 ESP 定时器任务用于处理 ESP 定时器回调	<code>CON-核</code> <code>FIG_ESP_TIMER_TASK_STACK_SIZE</code>		22

**备注：**注意，如果应用程序使用了其他 ESP-IDF 功能（如 Wi-Fi 或蓝牙），那么这些功能可能会在上表的任务之外创建自己的后台任务。

### FreeRTOS 附加功能

ESP-IDF 还为 FreeRTOS 提供了一些补充功能，如环形 buffer、ESP-IDF 风格的 tick 钩子和 idle 钩子、以及 TLSP 删除回调。要了解更多信息，请参见[FreeRTOS（附加功能）](#)。

### FreeRTOS 堆

原生 FreeRTOS 自带堆实现选择，然而 ESP-IDF 已经实现了自己的堆（参见[堆内存分配](#)），因此不使用原生 FreeRTOS 的堆实现。ESP-IDF 中的所有 FreeRTOS 端口都将 FreeRTOS 内存分配或释放调用（例如 `pvPortMalloc()` 和 `pvPortFree()`）映射到 ESP-IDF 堆 API（即 `heap_caps_malloc()` 和 `heap_caps_free()`）。然而 FreeRTOS 端口可以确保 FreeRTOS 分配的所有动态内存都放在内部内存中。

**备注：**如果希望将 FreeRTOS 任务或对象放在外部内存中，可以使用以下方法：

- 使用一个 `...CreateWithCaps()` API，如 `xTaskCreateWithCaps()` 和 `xQueueCreateWithCaps()` 来分配任务或对象（参见[IDF 附加 API](#) 获取更多详细信息）。
- 使用 `heap_caps_malloc()` 为这些对象手动分配外部内存，然后使用 FreeRTOS 的一个 `...CreateStatic()` 函数从分配的内存中创建对象。

## 2.10.12 FreeRTOS (IDF)

本文档介绍了 ESP-IDF 框架内的 FreeRTOS 双核 SMP 实现，包含以下小节：

### 目录

- [FreeRTOS \(IDF\)](#)
  - [概述](#)
  - [对称多处理](#)
  - [任务](#)
  - [SMP 调度器](#)
  - [临界区](#)
  - [其他事项](#)
  - [API 参考](#)

### 概述

原始 FreeRTOS（下文称 Vanilla FreeRTOS）是一款小巧高效的实时操作系统，适用于许多单核 MCU 和 SoC。但为了支持双核 ESP 芯片，如 ESP32、ESP32-S3、ESP32-P4，ESP-IDF 特别提供了支持双核对称多处理 (SMP) 的 FreeRTOS 实现（下文称 IDF FreeRTOS）。

IDF FreeRTOS 源代码基于 Vanilla FreeRTOS v10.5.1，但内核行为和 API 都有重大修改，以支持双核 SMP。不过用户也可以启用 `CONFIG_FREERTOS_UNICORE` 选项，将 IDF FreeRTOS 配置为支持单核，详情请参阅[单核模式](#)。

---

**备注：** 本文档假定读者已具备 Vanilla FreeRTOS 的必要背景知识，即了解其特性、行为和 API 用法。如需了解背景知识，请参阅 [Vanilla FreeRTOS 文档](#)。

---

## 对称多处理

**基本概念** 对称多处理是一种计算架构，其中，两个及以上相同的 CPU 核连接到单个共享的主内存，并由单个操作系统控制。SMP 系统通常具有以下特点：

- 多个核独立运行。每个核都有自己的寄存器文件、中断和中断处理。
- 对每个核呈现相同的内存视图。因此，无论在哪个核上运行，访问特定内存地址的代码都会产生相同的效果。

与单核或非对称多处理系统相比，SMP 系统的主要优势在于：

- 存在多个核，支持多个硬件线程，从而提高整体处理吞吐量。
- 对称内存支持线程在执行期间切换核，从而提高 CPU 利用率。

尽管 SMP 系统支持线程切换核，但在某些情况下，线程必须或应该仅在特定核上运行。因此，在 SMP 系统中，线程也具备核亲和性，指定线程在哪个特定核上运行。

- 分配给特定核的线程只能在该核上运行。
- 未分配给特定核的线程支持在执行期间切换核。

**ESP 芯片上的 SMP** ESP32、ESP32-S3、ESP32-P4 等 ESP 芯片是双核 SMP SoC，具有以下硬件特性以支持 SMP：

- 具有两个完全相同的核，分别称为核 0 和核 1。代码段无论在哪个核上运行，都有相同的执行效果。
- 具有对称内存（除了少数例外情况）。
  - 如果多个核同时访问相同的内存地址，它们的访问会被内存总线串行化。
  - 通过 ISA 提供的原子比较和交换指令，可以实现对同一内存地址的真正原子访问。
- 跨核中断支持由一个核触发另一个核上的中断，这使得核间可以互相发送信号，如请求在另一个核上进行上下文切换。

---

**备注：** 在 ESP-IDF 中，核 0 和核 1 有时分别又被称为 PRO\_CPU 和 APP\_CPU。别名 PRO\_CPU 和 APP\_CPU 反映了典型 ESP-IDF 应用程序使用这两个 CPU 的方式。负责处理 Wi-Fi 或蓝牙等协议相关处理程序的任务通常会分配给核 0，因此称核 0 为 PRO\_CPU；而处理应用程序其余部分的任务会分配给核 1，因此称核 1 为 APP\_CPU。

---

## 任务

**创建任务** Vanilla FreeRTOS 提供以下用于创建任务的函数：

- 使用 `xTaskCreate()` 创建任务时，任务内存动态分配。
- 使用 `xTaskCreateStatic()` 创建任务时，任务内存静态分配，即由用户提供。

然而，在 SMP 系统中，任务需要分配到特定核。因此，ESP-IDF 提供了 Vanilla FreeRTOS 任务创建函数的 `...PinnedToCore()` 版本：

- 使用 `xTaskCreatePinnedToCore()` 可以创建具有特定核亲和性的任务，任务内存动态分配。
- 使用 `xTaskCreateStaticPinnedToCore()` 可以创建具有特定核亲和性的任务，任务内存静态分配，即由用户提供。

不同于普通的任务创建函数 API，`...PinnedToCore()` 版本的任务创建函数 API 有额外的 `xCoreID` 参数，用于指定所创建任务的核亲和性。核亲和性的有效值包括：

- 0：将创建的任务分配给核 0
- 1：将创建的任务分配给核 1
- `tskNO_AFFINITY`：支持任务在两个核上运行



注意，IDF FreeRTOS 仍支持普通的任务创建函数，但这些标准函数已经过调整，会内部调用其 ... `PinnedToCore()` 版本，同时将核亲和性设置为 `tskNO_AFFINITY`。

**备注：**IDF FreeRTOS 还更改了任务创建函数中的 `ulStackDepth` 参数。在 Vanilla FreeRTOS 中，任务堆栈的大小以字为单位指定，而在 IDF FreeRTOS 中，任务堆栈的大小以字节为单位指定。

**执行任务** IDF FreeRTOS 中任务的结构与 Vanilla FreeRTOS 相同。具体而言，IDF FreeRTOS 任务：

- 只能处于以下任一状态：运行中、就绪、阻塞或挂起。
- 任务函数通常为无限循环。
- 任务函数不应返回。

**删除任务** 调用 `vTaskDelete()` 可以在 Vanilla FreeRTOS 中删除任务。该函数可用于删除其他任务，若任务句柄为 `NULL` 则删除当前运行任务。如果删除的任务是当前正在运行的任务时，任务的内存释放有时会委托给空闲任务执行。

IDF FreeRTOS 提供了同样的 `vTaskDelete()` 函数。然而，IDF FreeRTOS 是一个双核系统，因此调用 `vTaskDelete()` 时，行为上会与 Vanilla FreeRTOS 有以下差异：

- 删除另一个核上运行的任务时，会在另一个核上触发一次让步，任务内存由其中一个空闲任务释放。
- 如果删除的任务没有在任一核上运行，则会立即释放其内存。

请避免删除正在另一个核上运行的任务，否则由于无法确定该任务正在执行的操作，可能会导致难以预料的行为，例如：

- 删除持有互斥锁的任务。
- 删除尚未释放其先前分配的内存的任务。

请尽可能自己设计应用程序，确保在调用 `vTaskDelete()` 时，删除的任务处于已知状态。例如：

- 当任务完成执行操作并清理了任务内使用的所有资源时，任务调用 `vTaskDelete(NULL)` 自行删除。
- 在被另一个任务删除前，任务调用 `vTaskSuspend()` 将自己置于挂起状态。

## SMP 调度器

对 Vanilla FreeRTOS 调度器最确切的描述是 **具有时间分片和固定优先级的抢占式调度器**，这意味着：

- 每个任务在创建时都赋予了固定优先级，调度器会执行具有最高优先级且处于就绪状态的任务。
- 调度器可以在不需要当前运行任务的协作下切换执行到另一个任务。
- 调度器会采用轮转方式，定期在具有相同优先级的就绪状态任务间切换执行，时间分片由时钟中断控制。

IDF FreeRTOS 调度器支持相同的调度特性，即固定优先级、抢占和时间分片，但也存在细微的行为差异。

**固定优先级** 在 Vanilla FreeRTOS 中，当调度器选择要运行的新任务时，往往会选择当前优先级最高的就绪任务。而在 IDF FreeRTOS 中，每个核都独立地调度要运行的任务。当特定核选择一个任务时，该核会选择优先级最高且可以在该核上运行的就绪状态任务。满足以下条件时，任务可以在核上运行：

- 任务亲和性兼容，即已分配或未分配给当前核。
- 该任务当前没有在其他核上运行。

但是，两个具有最高优先级的就绪任务不一定始终由调度器运行，因为还需考虑到任务的核亲和性。例如，给定以下任务：

- 优先级为 10 的任务 A，分配给核 0
- 优先级为 9 的任务 B，分配给核 0
- 优先级为 8 的任务 C，分配给核 1

经过调度后，任务 A 将在核 0 上运行，任务 C 将在核 1 上运行。即使任务 B 是第二优先级任务，也不会被执行。

**抢占** 在 Vanilla FreeRTOS 中，如果优先级更高的任务已准备好执行，调度器可以抢占当前正在运行的任务。同样，在 IDF FreeRTOS 任务中，如果调度器确定一个优先级更高的任务可以在某个核上运行，那么调度器可以单独抢占各个核。

但在某些情况下，一个优先级更高的就绪任务可以在多个核上运行。此时，调度器只会抢占一个核。即便当前有多个核可以抢占，调度器总是优先选择当前核。换句话说，如果优先级更高的就绪任务未分配，并且其优先级高于两个核的当前优先级，调度器将始终选择抢占当前核。例如，给定以下任务：

- 优先级为 8 的任务 A 当前在核 0 上运行
- 优先级为 9 的任务 B 当前在核 1 上运行
- 优先级为 10 的任务 C 未分配，并由任务 B 解除了阻塞

经过调度后，任务 A 将在核 0 上运行，任务 C 将抢占任务 B，因为调度器总是优先选择当前核。

**时间分片** Vanilla FreeRTOS 实现了时间分片，这意味着如果当前优先级最高的就绪任务包含多个就绪任务，调度器会在这些任务间轮转定期切换。

然而，在 IDF FreeRTOS 中，由于以下原因，特定任务可能无法在特定核上运行，因此无法实现完美的轮转时间分片：

- 任务分配给了另一个核。
- 任务未分配，但已经由其他核运行。

因此，当核在所有就绪状态任务中搜索寻找要运行的任务时，可能需要跳过同一优先级列表中的一些任务，或者降低优先级，以找到可以运行的就绪状态任务。

IDF FreeRTOS 调度器会确保已选择运行的任务置于列表末尾，为同一优先级的就绪状态任务实现最佳轮转时间分片。这样，在下次调度迭代（即，下一个滴答中断或让步）中，未经选择的任务优先级会更高。

以下示例展示了最佳轮转时间分片的实操。假设：

- 有四个相同优先级的就绪状态任务 AX、B0、C1 和 D1，其中：
  - 优先级是当前具有就绪状态任务的最高优先级。
  - 第一个字符代表任务名称，即 A、B、C、D。
  - 第二个字符表示任务核的分配情况，X 表示未分配。
- 任务列表始终从头开始搜索

1. 起始状态，尚未选择要运行的就绪状态任务。

```
Head [ AX , B0 , C1 , D0 ] Tail
```

2. 核 0 有一个滴答中断，搜索要运行的任务。选择任务 A，并将其移至列表末尾。

```
Core 0 ┌
      │
      ▼
Head [ AX , B0 , C1 , D0 ] Tail
      [0]
Head [ B0 , C1 , D0 , AX ] Tail
```

3. 核 1 有一个滴答中断，搜索要运行的任务。由于亲和性不兼容，任务 B 无法运行，因此核 1 跳到任务 C。选择任务 C，并将其移至列表末尾。

```
Core 1 ┌
      │
      ▼
Head [ B0 , C1 , D0 , AX ] Tail
      [0] [1]
Head [ B0 , D0 , AX , C1 ] Tail
```

4. 核 0 有另一个滴答中断，搜索要运行的任务。选择任务 B，并将其移至列表末尾。



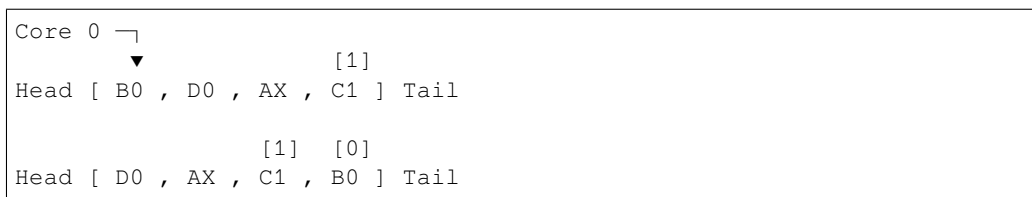

5. 核 1 有另一个滴答中断，搜索要运行的任务。由于亲和性不兼容，任务 D 无法运行，因此核 1 跳到任务 A。选择任务 A，并将其移至列表末尾。

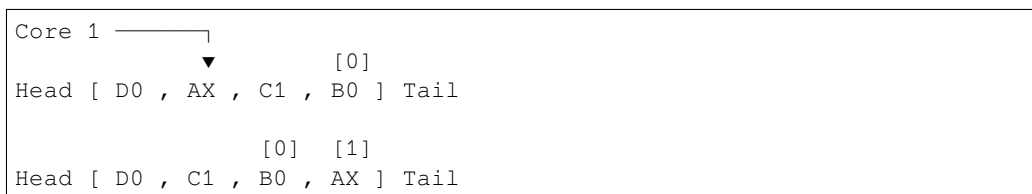

在使用最佳轮转时间分片时需注意：

- 相同优先级的多个就绪状态任务不一定可以像在 Vanilla FreeRTOS 中一样按顺序运行。如以上示例所示，核可能会跳过任务。
- 然而，经过足够的滴答次数，任务最终将获得一些处理时间。
- 如果核找不到优先级最高的可运行就绪任务，它将降低优先级来搜索任务。
- 为了实现理想的轮转时间分片，应确保特定优先级的所有任务都分配给同一个核。

**时钟中断** Vanilla FreeRTOS 要求定期发生滴答中断，滴答中断有以下作用：

- 增加调度器的滴答计数
- 为超时的阻塞任务解除阻塞
- 检查是否需要时间分片，即触发上下文切换
- 执行应用程序滴答函数

在 IDF FreeRTOS 中，每个核都会接收到定期中断，并独立运行滴答中断。每个核上的滴答中断周期相同，但可能不同步。然而，上述滴答中断任务不会由所有核同时执行，具体而言：

- 核 0 执行上述所有滴答中断任务
- 核 1 仅检查是否需要时间分片并执行应用程序滴答函数

**备注：**在 IDF FreeRTOS 中，核 0 是负责时间计数的唯一核。因此，任何阻止核 0 增加滴答计数的情况，例如暂停核 0 上的调度器，都会导致整个调度器的时间计数滞后。

**空闲任务** 启动调度器时，Vanilla FreeRTOS 会隐式创建一个优先级为 0 的空闲任务。当没有其他任务准备运行时，空闲任务运行并有以下作用：

- 释放已删除任务的内存
- 执行应用程序的空闲函数

而 IDF FreeRTOS 为每个核单独创建了一个固定的空闲任务。每个核上的空闲任务起到与其 Vanilla FreeRTOS 对应任务相同的作用。

**调度器挂起** Vanilla FreeRTOS 支持调用 `vTaskSuspendAll()` 挂起调度器，调用 `xTaskResumeAll()` 恢复调度器。调度器挂起时：

- 禁用任务切换，但仍启用中断。
- 禁止调用任何阻塞或让出函数，禁用时间分片。
- 时钟计数冻结，但仍会发生时钟中断以执行应用程序时钟函数。

调度器恢复时，`xTaskResumeAll()` 会补上所有丢失的时钟计数，并解除超时任务的阻塞。

在 IDF FreeRTOS 中，无法在多个核上同时挂起调度器。因此，在特定核上（如核 A）调用 `vTaskSuspendAll()` 时：

- 只在核 A 上禁用任务切换，但仍启用核 A 的中断。
- 禁止在核 A 上调用任何阻塞或让出函数，在核 A 上禁用时间分片。
- 核 A 上的中断解除任务阻塞时，对核 A 亲和的任务会进入核 A 的待执行任务列表。未分配的任务或对其他核亲和的任务可以在运行调度器的核上调度。
- 所有核上的调度器均挂起时，由中断解除阻塞的任务将进入它们分配的核的待执行任务列表。如果任务未分配，则进入调用中断的核的待执行任务列表。
- 如果核 A 是核 0，则时钟计数将被冻结，挂起的时钟计数将递增，但仍会发生时钟中断以执行应用程序时钟函数。

在特定核（如核 A）上调用 `xTaskResumeAll()` 时：

- 任何添加到核 A 的待执行任务列表中的任务将恢复执行。
- 如果核 A 是核 0，则挂起的时钟计数将回退，补上丢失的时钟计数。

**警告：** IDF FreeRTOS 上的调度器挂起仅暂停特定核上的调度，因此调度器挂起 **不能** 确保访问共享数据时任务互斥。如果需要互斥，请使用适当的锁定机制，如互斥锁或自旋锁。

## 临界区

**禁用中断** Vanilla FreeRTOS 支持通过调用 `taskDISABLE_INTERRUPTS` 和 `taskENABLE_INTERRUPTS` 分别禁用和启用中断。IDF FreeRTOS 提供了相同的 API，但中断只能在当前核上禁用或启用。

在 Vanilla FreeRTOS 以及其他普通单核系统中，禁用中断可以有效实现互斥，但在 SMP 系统中，禁用中断并不能确保实现互斥，而应使用有自旋锁的临界区以实现互斥。

**API 变更** Vanilla FreeRTOS 通过禁用中断实现临界区 (Critical Section)，以防止在临界区内发生抢占式上下文切换和中断服务，确保进入临界区的任务或 ISR 是访问共享资源的唯一实体。Vanilla FreeRTOS 中的临界区提供以下 API：

- `taskENTER_CRITICAL()` 通过禁用中断进入临界区
- `taskEXIT_CRITICAL()` 通过重新启用中断退出临界区
- `taskENTER_CRITICAL_FROM_ISR()` 通过禁用中断嵌套从 ISR 进入临界区
- `taskEXIT_CRITICAL_FROM_ISR()` 通过重新启用中断嵌套从 ISR 退出临界区

然而，在 SMP 系统中，仅禁用中断并不能构成临界区，因为存在其他核意味着共享资源仍可以同时访问。因此，IDF FreeRTOS 中的临界区是使用自旋锁实现的。为适应自旋锁，IDF FreeRTOS 中的临界区 API 包含一个额外的自旋锁参数，具体如下：

- 自旋锁为 `portMUX_TYPE` (请勿与 FreeRTOS 互斥混淆)
- `taskENTER_CRITICAL(&spinlock)` 从任务上下文进入临界区
- `taskEXIT_CRITICAL(&spinlock)` 从任务上下文退出临界区
- `taskENTER_CRITICAL_ISR(&spinlock)` 从中断上下文进入临界区
- `taskEXIT_CRITICAL_ISR(&spinlock)` 从中断上下文退出临界区

**备注：** 临界区 API 可以递归调用，即可以嵌套使用临界区。只要退出临界区的次数与进入的次数相同，多次递归进入临界区就是有效的。但是，由于临界区可以针对不同的自旋锁，因此在递归进入临界区时，应注意避免死锁。

自旋锁可以静态或动态分配。因此，提供了静态和动态初始化自旋锁的宏，如下代码片段所示。

- 静态分配自旋锁并使用 `portMUX_INITIALIZER_UNLOCKED` 初始化：

```
// 静态分配并初始化自旋锁
static portMUX_TYPE my_spinlock = portMUX_INITIALIZER_UNLOCKED;

void some_function(void)
{
    taskENTER_CRITICAL(&my_spinlock);
    // 此时已处于临界区
    taskEXIT_CRITICAL(&my_spinlock);
}

```

- 动态分配自旋锁并使用 portMUX\_INITIALIZER() 初始化:

```
// 动态分配自旋锁
portMUX_TYPE *my_spinlock = malloc(sizeof(portMUX_TYPE));
// 动态初始化自旋锁
portMUX_INITIALIZER(my_spinlock);

...

taskENTER_CRITICAL(my_spinlock);
// 访问资源
taskEXIT_CRITICAL(my_spinlock);

```

**实现** IDF FreeRTOS 中，特定核进入和退出临界区的过程如下：

- 对于 taskENTER\_CRITICAL(&spinlock) 或 taskENTER\_CRITICAL\_ISR(&spinlock)
  1. 核禁用其中断或中断嵌套，直到达到 configMAX\_SYSCALL\_INTERRUPT\_PRIORITY。
  2. 接着，核使用原子比较和设置指令在自旋锁上自旋，直到获取锁。当核能够将锁的所有者值设置为核的 ID 时，就获得了锁。
  3. 一旦获取了自旋锁，函数返回。剩余的临界区部分将在禁用中断或中断嵌套的情况下运行。
- 对于 taskEXIT\_CRITICAL(&spinlock) 或 taskEXIT\_CRITICAL\_ISR(&spinlock)
  1. 核通过清除自旋锁的所有者值释放自旋锁。
  2. 核重新启用中断或中断嵌套。

**限制与注意事项** 由于在临界区内禁用了中断或中断嵌套，产生了多个关于在临界区内可执行操作的限制，请牢记以下操作限制和注意事项：

- 临界区应尽可能短
  - 临界区持续时间越长，越可能延迟挂起中断的执行。
  - 临界区通常应仅涉及少量数据结构和/或硬件寄存器。
  - 如果可以，尽可能将执行操作和/或事件处理程序推迟到临界区之外。
- 不应在临界区内调用 FreeRTOS API
- 不应在临界区内调用任何阻塞或让出函数

## 其他事项

**单核模式** 尽管 IDF FreeRTOS 是为双核 SMP 专门设计的，但也可通过启用 `CONFIG_FREERTOS_UNICORE` 选项，将 IDF FreeRTOS 配置为支持单核。

对于 ESP32-S2 和 ESP32-C3 等单核芯片，`CONFIG_FREERTOS_UNICORE` 选项始终启用。对于 ESP32 和 ESP32-S3 等多核芯片也可以设置 `CONFIG_FREERTOS_UNICORE`，对于多核目标（如 ESP32 和 ESP32-S3），也可以设置 `CONFIG_FREERTOS_UNICORE`，但启用该选项后应用仅在核 0 上运行。

在单核模式下，IDF FreeRTOS 与 Vanilla FreeRTOS 完全相同，因此无需考虑前文提到的对内核行为的 SMP 更改。因此，在单核模式下构建 IDF FreeRTOS 具有以下特点：

- 内核在临界区内执行的所有操作都是确定的（即在临界区内不走链表）。
- 恢复了 Vanilla FreeRTOS 调度算法（包括完美的轮转时间分片）。
- 移除了所有单核构建中的 SMP 专用数据。

在单核模式下仍可调用 SMP API，这些 API 仍然保持公开，以便为单核和多核构建源代码，而无需调用不同的 API 集。不过，SMP API 在单核模式下不会展示任何 SMP 行为，因此实际上等同于其对应的单核模式 API。例如：

- 任何 `...ForCore(..., BaseType_t xCoreID)` SMP API 将只接受 0 为 `xCoreID` 的有效值。
- `...PinnedToCore()` 任务创建 API 将直接忽略 `xCoreID` 核亲和参数。
- 临界区 API 仍需要自旋锁参数，但不会使用自旋锁，临界区将恢复为仅用于禁用/启用中断。

## API 参考

本节介绍了 FreeRTOS 类型、函数和宏，均从 FreeRTOS 头文件自动生成。

## 任务 API

### Header File

- `components/freertos/FreeRTOS-Kernel/include/freertos/task.h`
- This header file can be included with:

```
#include "freertos/task.h"
```

### Functions

static inline BaseType\_t **xTaskCreate** (TaskFunction\_t pxTaskCode, const char \*const pcName, const configSTACK\_DEPTH\_TYPE usStackDepth, void \*const pvParameters, UBaseType\_t uxPriority, *TaskHandle\_t* \*const pxCreatedTask)

Create a new task and add it to the list of tasks that are ready to run.

Internally, within the FreeRTOS implementation, tasks use two blocks of memory. The first block is used to hold the task's data structures. The second block is used by the task as its stack. If a task is created using `xTaskCreate()` then both blocks of memory are automatically dynamically allocated inside the `xTaskCreate()` function. (see <https://www.FreeRTOS.org/a00111.html>). If a task is created using `xTaskCreateStatic()` then the application writer must provide the required memory. `xTaskCreateStatic()` therefore allows a task to be created without using any dynamic memory allocation.

See `xTaskCreateStatic()` for a version that does not use any dynamic memory allocation.

`xTaskCreate()` can only be used to create a task that has unrestricted access to the entire microcontroller memory map. Systems that include MPU support can alternatively create an MPU constrained task using `xTaskCreateRestricted()`.

Example usage:

```
// Task to be created.
void vTaskCode( void * pvParameters )
{
    for( ;; )
    {
        // Task code goes here.
    }
}

// Function that creates a task.
void vOtherFunction( void )
{
    static uint8_t ucParameterToPass;
    TaskHandle_t xHandle = NULL;
```

(下页继续)

```

// Create the task, storing the handle. Note that the passed parameter_
→ucParameterToPass
// must exist for the lifetime of the task, so in this case is declared static.
→ If it was just an
// an automatic stack variable it might no longer exist, or at least have been_
→corrupted, by the time
// the new task attempts to access it.
    xTaskCreate( vTaskCode, "NAME", STACK_SIZE, &ucParameterToPass, tskIDLE_
→PRIORITY, &xHandle );
    configASSERT( xHandle );

// Use the handle to delete the task.
if( xHandle != NULL )
{
    vTaskDelete( xHandle );
}
}

```

**备注:** If `configNUMBER_OF_CORES > 1`, this function will create an unpinned task (see `tskNO_AFFINITY` for more details).

**备注:** If program uses thread local variables (ones specified with `__thread` keyword) then storage for them will be allocated on the task's stack.

### 参数

- **pxTaskCode** -- Pointer to the task entry function. Tasks must be implemented to never return (i.e. continuous loop).
- **pcName** -- A descriptive name for the task. This is mainly used to facilitate debugging. Max length defined by `configMAX_TASK_NAME_LEN` - default is 16.
- **usStackDepth** -- The size of the task stack specified as the NUMBER OF BYTES. Note that this differs from vanilla FreeRTOS.
- **pvParameters** -- Pointer that will be used as the parameter for the task being created.
- **uxPriority** -- The priority at which the task should run. Systems that include MPU support can optionally create tasks in a privileged (system) mode by setting bit `portPRIVILEGE_BIT` of the priority parameter. For example, to create a privileged task at priority 2 the `uxPriority` parameter should be set to `( 2 | portPRIVILEGE_BIT )`.
- **pxCreatedTask** -- Used to pass back a handle by which the created task can be referenced.

**返回** `pdPASS` if the task was successfully created and added to a ready list, otherwise an error code defined in the file `projdefs.h`

```

static inline TaskHandle_t xTaskCreateStatic (TaskFunction_t pxTaskCode, const char *const pcName,
                                             const uint32_t ulStackDepth, void *const pvParameters,
                                             UBaseType_t uxPriority, StackType_t *const
                                             puxStackBuffer, StaticTask_t *const pxTaskBuffer)

```

Create a new task and add it to the list of tasks that are ready to run.

Internally, within the FreeRTOS implementation, tasks use two blocks of memory. The first block is used to hold the task's data structures. The second block is used by the task as its stack. If a task is created using `xTaskCreate()` then both blocks of memory are automatically dynamically allocated inside the `xTaskCreate()` function. (see <https://www.FreeRTOS.org/a00111.html>). If a task is created using `xTaskCreateStatic()` then the application writer must provide the required memory. `xTaskCreateStatic()` therefore allows a task to be created without using any dynamic memory allocation.

Example usage:

```
// Dimensions of the buffer that the task being created will use as its stack.
// NOTE: This is the number of words the stack will hold, not the number of
// bytes. For example, if each stack item is 32-bits, and this is set to 100,
// then 400 bytes (100 * 32-bits) will be allocated.
#define STACK_SIZE 200

// Structure that will hold the TCB of the task being created.
StaticTask_t xTaskBuffer;

// Buffer that the task being created will use as its stack. Note this is
// an array of StackType_t variables. The size of StackType_t is dependent on
// the RTOS port.
StackType_t xStack[ STACK_SIZE ];

// Function that implements the task being created.
void vTaskCode( void * pvParameters )
{
    // The parameter value is expected to be 1 as 1 is passed in the
    // pvParameters value in the call to xTaskCreateStatic().
    configASSERT( ( uint32_t ) pvParameters == 1UL );

    for( ;; )
    {
        // Task code goes here.
    }
}

// Function that creates a task.
void vOtherFunction( void )
{
    TaskHandle_t xHandle = NULL;

    // Create the task without using any dynamic memory allocation.
    xHandle = xTaskCreateStatic(
        vTaskCode,          // Function that implements the task.
        "NAME",            // Text name for the task.
        STACK_SIZE,        // Stack size in words, not bytes.
        ( void * ) 1,      // Parameter passed into the task.
        tskIDLE_PRIORITY, // Priority at which the task is created.
        xStack,            // Array to use as the task's stack.
        &xTaskBuffer );   // Variable to hold the task's data
    ↪ structure.

    // puxStackBuffer and pxTaskBuffer were not NULL, so the task will have
    // been created, and xHandle will be the task's handle. Use the handle
    // to suspend the task.
    vTaskSuspend( xHandle );
}

```

**备注:** If `configNUMBER_OF_CORES > 1`, this function will create an unpinned task (see `tskNO_AFFINITY` for more details).

**备注:** If program uses thread local variables (ones specified with `__thread` keyword) then storage for them will be allocated on the task's stack.

#### 参数

- **pxTaskCode** -- Pointer to the task entry function. Tasks must be implemented to never



return (i.e. continuous loop).

- **pcName** -- A descriptive name for the task. This is mainly used to facilitate debugging. The maximum length of the string is defined by `configMAX_TASK_NAME_LEN` in `FreeRTOSConfig.h`.
- **ulStackDepth** -- The size of the task stack specified as the NUMBER OF BYTES. Note that this differs from vanilla FreeRTOS.
- **pvParameters** -- Pointer that will be used as the parameter for the task being created.
- **uxPriority** -- The priority at which the task will run.
- **pxStackBuffer** -- Must point to a `StackType_t` array that has at least `ulStackDepth` indexes - the array will then be used as the task's stack, removing the need for the stack to be allocated dynamically.
- **pxTaskBuffer** -- Must point to a variable of type `StaticTask_t`, which will then be used to hold the task's data structures, removing the need for the memory to be allocated dynamically.

**返回** If neither `pxStackBuffer` nor `pxTaskBuffer` are `NULL`, then the task will be created and a handle to the created task is returned. If either `pxStackBuffer` or `pxTaskBuffer` are `NULL` then the task will not be created and `NULL` is returned.

void **vTaskAllocateMPURegions** (*TaskHandle\_t* xTask, const *MemoryRegion\_t* \*const pxRegions)

Memory regions are assigned to a restricted task when the task is created by a call to `xTaskCreateRestricted()`. These regions can be redefined using `vTaskAllocateMPURegions()`.

Example usage:

```
// Define an array of MemoryRegion_t structures that configures an MPU region
// allowing read/write access for 1024 bytes starting at the beginning of the
// ucOneKByte array. The other two of the maximum 3 definable regions are
// unused so set to zero.
static const MemoryRegion_t xAltRegions[ portNUM_CONFIGURABLE_REGIONS ] =
{
    // Base address      Length      Parameters
    { ucOneKByte,      1024,      portMPU_REGION_READ_WRITE },
    { 0,                0,         0 },
    { 0,                0,         0 }
};

void vATask( void *pvParameters )
{
    // This task was created such that it has access to certain regions of
    // memory as defined by the MPU configuration. At some point it is
    // desired that these MPU regions are replaced with that defined in the
    // xAltRegions const struct above. Use a call to vTaskAllocateMPURegions()
    // for this purpose. NULL is used as the task handle to indicate that this
    // function should modify the MPU regions of the calling task.
    vTaskAllocateMPURegions( NULL, xAltRegions );

    // Now the task can continue its function, but from this point on can only
    // access its stack and the ucOneKByte array (unless any other statically
    // defined or shared regions have been declared elsewhere).
}
```

**参数**

- **xTask** -- The handle of the task being updated.
- **pxRegions** -- A pointer to a `MemoryRegion_t` structure that contains the new memory region definitions.

void **vTaskDelete** (*TaskHandle\_t* xTaskToDelete)

`INCLUDE_vTaskDelete` must be defined as 1 for this function to be available. See the configuration section for more information.

Remove a task from the RTOS real time kernel's management. The task being deleted will be removed from all ready, blocked, suspended and event lists.

NOTE: The idle task is responsible for freeing the kernel allocated memory from tasks that have been deleted. It is therefore important that the idle task is not starved of microcontroller processing time if your application makes any calls to `vTaskDelete()`. Memory allocated by the task code is not automatically freed, and should be freed before the task is deleted.

See the demo application file `death.c` for sample code that utilises `vTaskDelete()`.

Example usage:

```
void vOtherFunction( void )
{
    TaskHandle_t xHandle;

    // Create the task, storing the handle.
    xTaskCreate( vTaskCode, "NAME", STACK_SIZE, NULL, tskIDLE_PRIORITY, &xHandle );

    // Use the handle to delete the task.
    vTaskDelete( xHandle );
}
```

**参数 `xTaskToDelete`** -- The handle of the task to be deleted. Passing NULL will cause the calling task to be deleted.

void **`vTaskDelay`**(const TickType\_t xTicksToDelay)

Delay a task for a given number of ticks. The actual time that the task remains blocked depends on the tick rate. The constant `portTICK_PERIOD_MS` can be used to calculate real time from the tick rate - with the resolution of one tick period.

`INCLUDE_vTaskDelay` must be defined as 1 for this function to be available. See the configuration section for more information.

`vTaskDelay()` specifies a time at which the task wishes to unblock relative to the time at which `vTaskDelay()` is called. For example, specifying a block period of 100 ticks will cause the task to unblock 100 ticks after `vTaskDelay()` is called. `vTaskDelay()` does not therefore provide a good method of controlling the frequency of a periodic task as the path taken through the code, as well as other task and interrupt activity, will affect the frequency at which `vTaskDelay()` gets called and therefore the time at which the task next executes. See `xTaskDelayUntil()` for an alternative API function designed to facilitate fixed frequency execution. It does this by specifying an absolute time (rather than a relative time) at which the calling task should unblock.

Example usage:

```
void vTaskFunction( void * pvParameters )
{
    // Block for 500ms.
    const TickType_t xDelay = 500 / portTICK_PERIOD_MS;

    for( ;; )
    {
        // Simply toggle the LED every 500ms, blocking between each toggle.
        vToggleLED();
        vTaskDelay( xDelay );
    }
}
```

**参数 `xTicksToDelay`** -- The amount of time, in tick periods, that the calling task should block.



BaseType\_t **xTaskDelayUntil** (TickType\_t \*const pxPreviousWakeTime, const TickType\_t xTimeIncrement)

INCLUDE\_xTaskDelayUntil must be defined as 1 for this function to be available. See the configuration section for more information.

Delay a task until a specified time. This function can be used by periodic tasks to ensure a constant execution frequency.

This function differs from vTaskDelay () in one important aspect: vTaskDelay () will cause a task to block for the specified number of ticks from the time vTaskDelay () is called. It is therefore difficult to use vTaskDelay () by itself to generate a fixed execution frequency as the time between a task starting to execute and that task calling vTaskDelay () may not be fixed [the task may take a different path though the code between calls, or may get interrupted or preempted a different number of times each time it executes].

Whereas vTaskDelay () specifies a wake time relative to the time at which the function is called, xTaskDelayUntil () specifies the absolute (exact) time at which it wishes to unblock.

The macro pdMS\_TO\_TICKS() can be used to calculate the number of ticks from a time specified in milliseconds with a resolution of one tick period.

Example usage:

```
// Perform an action every 10 ticks.
void vTaskFunction( void * pvParameters )
{
    TickType_t xLastWakeTime;
    const TickType_t xFrequency = 10;
    BaseType_t xWasDelayed;

    // Initialise the xLastWakeTime variable with the current time.
    xLastWakeTime = xTaskGetTickCount ();
    for( ;; )
    {
        // Wait for the next cycle.
        xWasDelayed = xTaskDelayUntil( &xLastWakeTime, xFrequency );

        // Perform action here. xWasDelayed value can be used to determine
        // whether a deadline was missed if the code here took too long.
    }
}
```

### 参数

- **pxPreviousWakeTime** -- Pointer to a variable that holds the time at which the task was last unblocked. The variable must be initialised with the current time prior to its first use (see the example below). Following this the variable is automatically updated within xTaskDelayUntil ().
- **xTimeIncrement** -- The cycle time period. The task will be unblocked at time \*pxPreviousWakeTime + xTimeIncrement. Calling xTaskDelayUntil with the same xTimeIncrement parameter value will cause the task to execute with a fixed interface period.

**返回** Value which can be used to check whether the task was actually delayed. Will be pdTRUE if the task was delayed and pdFALSE otherwise. A task will not be delayed if the next expected wake time is in the past.

BaseType\_t **xTaskAbortDelay** (TaskHandle\_t xTask)

INCLUDE\_xTaskAbortDelay must be defined as 1 in FreeRTOSConfig.h for this function to be available.

A task will enter the Blocked state when it is waiting for an event. The event it is waiting for can be a temporal event (waiting for a time), such as when vTaskDelay() is called, or an event on an object, such as when xQueueReceive() or ulTaskNotifyTake() is called. If the handle of a task that is in the Blocked state is used

in a call to `xTaskAbortDelay()` then the task will leave the Blocked state, and return from whichever function call placed the task into the Blocked state.

There is no 'FromISR' version of this function as an interrupt would need to know which object a task was blocked on in order to know which actions to take. For example, if the task was blocked on a queue the interrupt handler would then need to know if the queue was locked.

**参数 xTask** -- The handle of the task to remove from the Blocked state.

**返回** If the task referenced by `xTask` was not in the Blocked state then `pdFAIL` is returned. Otherwise `pdPASS` is returned.

`UBaseType_t uxTaskPriorityGet (const TaskHandle_t xTask)`

`INCLUDE_uxTaskPriorityGet` must be defined as 1 for this function to be available. See the configuration section for more information.

Obtain the priority of any task.

Example usage:

```
void vAFunction( void )
{
    TaskHandle_t xHandle;

    // Create a task, storing the handle.
    xTaskCreate( vTaskCode, "NAME", STACK_SIZE, NULL, tskIDLE_PRIORITY, &xHandle_
    ↪);

    // ...

    // Use the handle to obtain the priority of the created task.
    // It was created with tskIDLE_PRIORITY, but may have changed
    // it itself.
    if( uxTaskPriorityGet( xHandle ) != tskIDLE_PRIORITY )
    {
        // The task has changed it's priority.
    }

    // ...

    // Is our priority higher than the created task?
    if( uxTaskPriorityGet( xHandle ) < uxTaskPriorityGet( NULL ) )
    {
        // Our priority (obtained using NULL handle) is higher.
    }
}
```

**参数 xTask** -- Handle of the task to be queried. Passing a NULL handle results in the priority of the calling task being returned.

**返回** The priority of `xTask`.

`UBaseType_t uxTaskPriorityGetFromISR (const TaskHandle_t xTask)`

A version of `uxTaskPriorityGet()` that can be used from an ISR.

*eTaskState* **eTaskGetState** (*TaskHandle\_t* xTask)

`INCLUDE_eTaskGetState` must be defined as 1 for this function to be available. See the configuration section for more information.

Obtain the state of any task. States are encoded by the `eTaskState` enumerated type.

**参数 xTask** -- Handle of the task to be queried.

**返回** The state of xTask at the time the function was called. Note the state of the task might change between the function being called, and the functions return value being tested by the calling task.

void **vTaskGetInfo** (*TaskHandle\_t* xTask, *TaskStatus\_t* \*pxTaskStatus, BaseType\_t xGetFreeStackSize, *eTaskState* eState)

configUSE\_TRACE\_FACILITY must be defined as 1 for this function to be available. See the configuration section for more information.

Populates a TaskStatus\_t structure with information about a task.

Example usage:

```
void vAFunction( void )
{
    TaskHandle_t xHandle;
    TaskStatus_t xTaskDetails;

    // Obtain the handle of a task from its name.
    xHandle = xTaskGetHandle( "Task_Name" );

    // Check the handle is not NULL.
    configASSERT( xHandle );

    // Use the handle to obtain further information about the task.
    vTaskGetInfo( xHandle,
                  &xTaskDetails,
                  pdTRUE, // Include the high water mark in xTaskDetails.
                  eInvalid ); // Include the task state in xTaskDetails.
}
```

### 参数

- **xTask** -- Handle of the task being queried. If xTask is NULL then information will be returned about the calling task.
- **pxTaskStatus** -- A pointer to the TaskStatus\_t structure that will be filled with information about the task referenced by the handle passed using the xTask parameter.
- **xGetFreeStackSize** -- The TaskStatus\_t structure contains a member to report the stack high water mark of the task being queried. Calculating the stack high water mark takes a relatively long time, and can make the system temporarily unresponsive - so the xGetFreeStackSize parameter is provided to allow the high water mark checking to be skipped. The high watermark value will only be written to the TaskStatus\_t structure if xGetFreeStackSize is not set to pdFALSE;
- **eState** -- The TaskStatus\_t structure contains a member to report the state of the task being queried. Obtaining the task state is not as fast as a simple assignment - so the eState parameter is provided to allow the state information to be omitted from the TaskStatus\_t structure. To obtain state information then set eState to eInvalid - otherwise the value passed in eState will be reported as the task state in the TaskStatus\_t structure.

void **vTaskPrioritySet** (*TaskHandle\_t* xTask, UBaseType\_t uxNewPriority)

INCLUDE\_vTaskPrioritySet must be defined as 1 for this function to be available. See the configuration section for more information.

Set the priority of any task.

A context switch will occur before the function returns if the priority being set is higher than the currently executing task.

Example usage:

```

void vAFunction( void )
{
TaskHandle_t xHandle;

// Create a task, storing the handle.
xTaskCreate( vTaskCode, "NAME", STACK_SIZE, NULL, tskIDLE_PRIORITY, &xHandle_
→);

// ...

// Use the handle to raise the priority of the created task.
vTaskPrioritySet( xHandle, tskIDLE_PRIORITY + 1 );

// ...

// Use a NULL handle to raise our priority to the same value.
vTaskPrioritySet( NULL, tskIDLE_PRIORITY + 1 );
}

```

**参数**

- **xTask** -- Handle to the task for which the priority is being set. Passing a NULL handle results in the priority of the calling task being set.
- **uxNewPriority** -- The priority to which the task will be set.

void **vTaskSuspend** (*TaskHandle\_t* xTaskToSuspend)

INCLUDE\_vTaskSuspend must be defined as 1 for this function to be available. See the configuration section for more information.

Suspend any task. When suspended a task will never get any microcontroller processing time, no matter what its priority.

Calls to vTaskSuspend are not accumulative - i.e. calling vTaskSuspend () twice on the same task still only requires one call to vTaskResume () to ready the suspended task.

Example usage:

```

void vAFunction( void )
{
TaskHandle_t xHandle;

// Create a task, storing the handle.
xTaskCreate( vTaskCode, "NAME", STACK_SIZE, NULL, tskIDLE_PRIORITY, &xHandle_
→);

// ...

// Use the handle to suspend the created task.
vTaskSuspend( xHandle );

// ...

// The created task will not run during this period, unless
// another task calls vTaskResume( xHandle ).

//...

// Suspend ourselves.
vTaskSuspend( NULL );
}

```

(下页继续)

```
// We cannot get here unless another task calls vTaskResume
// with our handle as the parameter.
}
```

**参数 xTaskToSuspend** -- Handle to the task being suspended. Passing a NULL handle will cause the calling task to be suspended.

void **vTaskResume** (*TaskHandle\_t* xTaskToResume)

INCLUDE\_vTaskSuspend must be defined as 1 for this function to be available. See the configuration section for more information.

Resumes a suspended task.

A task that has been suspended by one or more calls to vTaskSuspend () will be made available for running again by a single call to vTaskResume ().

Example usage:

```
void vAFunction( void )
{
    TaskHandle_t xHandle;

    // Create a task, storing the handle.
    xTaskCreate( vTaskCode, "NAME", STACK_SIZE, NULL, tskIDLE_PRIORITY, &xHandle_
    →);

    // ...

    // Use the handle to suspend the created task.
    vTaskSuspend( xHandle );

    // ...

    // The created task will not run during this period, unless
    // another task calls vTaskResume( xHandle ).

    //...

    // Resume the suspended task ourselves.
    vTaskResume( xHandle );

    // The created task will once again get microcontroller processing
    // time in accordance with its priority within the system.
}
```

**参数 xTaskToResume** -- Handle to the task being readied.

BaseType\_t **xTaskResumeFromISR** (*TaskHandle\_t* xTaskToResume)

INCLUDE\_xTaskResumeFromISR must be defined as 1 for this function to be available. See the configuration section for more information.

An implementation of vTaskResume() that can be called from within an ISR.

A task that has been suspended by one or more calls to vTaskSuspend () will be made available for running again by a single call to xTaskResumeFromISR ().

xTaskResumeFromISR() should not be used to synchronise a task with an interrupt if there is a chance that the interrupt could arrive prior to the task being suspended - as this can lead to interrupts being missed. Use of a semaphore as a synchronisation mechanism would avoid this eventuality.

**参数** `xTaskToResume` -- Handle to the task being readied.

**返回** `pdTRUE` if resuming the task should result in a context switch, otherwise `pdFALSE`. This is used by the ISR to determine if a context switch may be required following the ISR.

void **vTaskSuspendAll** (void)

Suspends the scheduler without disabling interrupts. Context switches will not occur while the scheduler is suspended.

After calling `vTaskSuspendAll ()` the calling task will continue to execute without risk of being swapped out until a call to `xTaskResumeAll ()` has been made.

API functions that have the potential to cause a context switch (for example, `xTaskDelayUntil()`, `xQueueSend()`, etc.) must not be called while the scheduler is suspended.

Example usage:

```
void vTask1( void * pvParameters )
{
    for( ;; )
    {
        // Task code goes here.

        // ...

        // At some point the task wants to perform a long operation during
        // which it does not want to get swapped out. It cannot use
        // taskENTER_CRITICAL ()/taskEXIT_CRITICAL () as the length of the
        // operation may cause interrupts to be missed - including the
        // ticks.

        // Prevent the real time kernel swapping out the task.
        vTaskSuspendAll ();

        // Perform the operation here. There is no need to use critical
        // sections as we have all the microcontroller processing time.
        // During this time interrupts will still operate and the kernel
        // tick count will be maintained.

        // ...

        // The operation is complete. Restart the kernel.
        xTaskResumeAll ();
    }
}
```

BaseType\_t **xTaskResumeAll** (void)

Resumes scheduler activity after it was suspended by a call to `vTaskSuspendAll()`.

`xTaskResumeAll()` only resumes the scheduler. It does not unsuspend tasks that were previously suspended by a call to `vTaskSuspend()`.

Example usage:

```
void vTask1( void * pvParameters )
{
    for( ;; )
    {
        // Task code goes here.

        // ...

        // At some point the task wants to perform a long operation during
```

(下页继续)

```

// which it does not want to get swapped out. It cannot use
// taskENTER_CRITICAL ()/taskEXIT_CRITICAL () as the length of the
// operation may cause interrupts to be missed - including the
// ticks.

// Prevent the real time kernel swapping out the task.
    vTaskSuspendAll ();

// Perform the operation here. There is no need to use critical
// sections as we have all the microcontroller processing time.
// During this time interrupts will still operate and the real
// time kernel tick count will be maintained.

// ...

// The operation is complete. Restart the kernel. We want to force
// a context switch - but there is no point if resuming the scheduler
// caused a context switch already.
if( !xTaskResumeAll () )
    {
        taskYIELD ();
    }
}

```

**返回** If resuming the scheduler caused a context switch then pdTRUE is returned, otherwise pdFALSE is returned.

TickType\_t **xTaskGetTickCount** (void)

**返回** The count of ticks since vTaskStartScheduler was called.

TickType\_t **xTaskGetTickCountFromISR** (void)

This is a version of xTaskGetTickCount() that is safe to be called from an ISR - provided that TickType\_t is the natural word size of the microcontroller being used or interrupt nesting is either not supported or not being used.

**返回** The count of ticks since vTaskStartScheduler was called.

UBaseType\_t **uxTaskGetNumberOfTasks** (void)

**返回** The number of tasks that the real time kernel is currently managing. This includes all ready, blocked and suspended tasks. A task that has been deleted but not yet freed by the idle task will also be included in the count.

char \***pcTaskGetName** (*TaskHandle\_t* xTaskToQuery)

**返回** The text (human readable) name of the task referenced by the handle xTaskToQuery. A task can query its own name by either passing in its own handle, or by setting xTaskToQuery to NULL.

*TaskHandle\_t* **xTaskGetHandle** (const char \*pcNameToQuery)

NOTE: This function takes a relatively long time to complete and should be used sparingly.

**返回** The handle of the task that has the human readable name pcNameToQuery. NULL is returned if no matching name is found. INCLUDE\_xTaskGetHandle must be set to 1 in FreeRTOSConfig.h for pcTaskGetHandle() to be available.

BaseType\_t **xTaskGetStaticBuffers** (*TaskHandle\_t* xTask, StackType\_t \*\*ppuxStackBuffer, StaticTask\_t \*\*ppxTaskBuffer)

Retrieve pointers to a statically created task's data structure buffer and stack buffer. These are the same buffers that are supplied at the time of creation.

**参数**

- **xTask** -- The task for which to retrieve the buffers.
- **ppuxStackBuffer** -- Used to return a pointer to the task's stack buffer.
- **ppxTaskBuffer** -- Used to return a pointer to the task's data structure buffer.

**返回** pdTRUE if buffers were retrieved, pdFALSE otherwise.

UBaseType\_t **uxTaskGetStackHighWaterMark** (*TaskHandle\_t* xTask)

INCLUDE\_uxTaskGetStackHighWaterMark must be set to 1 in FreeRTOSConfig.h for this function to be available.

Returns the high water mark of the stack associated with xTask. That is, the minimum free stack space there has been (in words, so on a 32 bit machine a value of 1 means 4 bytes) since the task started. The smaller the returned number the closer the task has come to overflowing its stack.

uxTaskGetStackHighWaterMark() and uxTaskGetStackHighWaterMark2() are the same except for their return type. Using configSTACK\_DEPTH\_TYPE allows the user to determine the return type. It gets around the problem of the value overflowing on 8-bit types without breaking backward compatibility for applications that expect an 8-bit return type.

**参数** **xTask** -- Handle of the task associated with the stack to be checked. Set xTask to NULL to check the stack of the calling task.

**返回** The smallest amount of free stack space there has been (in words, so actual spaces on the stack rather than bytes) since the task referenced by xTask was created.

configSTACK\_DEPTH\_TYPE **uxTaskGetStackHighWaterMark2** (*TaskHandle\_t* xTask)

INCLUDE\_uxTaskGetStackHighWaterMark2 must be set to 1 in FreeRTOSConfig.h for this function to be available.

Returns the high water mark of the stack associated with xTask. That is, the minimum free stack space there has been (in words, so on a 32 bit machine a value of 1 means 4 bytes) since the task started. The smaller the returned number the closer the task has come to overflowing its stack.

uxTaskGetStackHighWaterMark() and uxTaskGetStackHighWaterMark2() are the same except for their return type. Using configSTACK\_DEPTH\_TYPE allows the user to determine the return type. It gets around the problem of the value overflowing on 8-bit types without breaking backward compatibility for applications that expect an 8-bit return type.

**参数** **xTask** -- Handle of the task associated with the stack to be checked. Set xTask to NULL to check the stack of the calling task.

**返回** The smallest amount of free stack space there has been (in words, so actual spaces on the stack rather than bytes) since the task referenced by xTask was created.

void **vTaskSetApplicationTaskTag** (*TaskHandle\_t* xTask, *TaskHookFunction\_t* pxHookFunction)

Sets pxHookFunction to be the task hook function used by the task xTask. Passing xTask as NULL has the effect of setting the calling tasks hook function.

*TaskHookFunction\_t* **xTaskGetApplicationTaskTag** (*TaskHandle\_t* xTask)

Returns the pxHookFunction value assigned to the task xTask. Do not call from an interrupt service routine - call xTaskGetApplicationTaskTagFromISR() instead.

*TaskHookFunction\_t* **xTaskGetApplicationTaskTagFromISR** (*TaskHandle\_t* xTask)

Returns the pxHookFunction value assigned to the task xTask. Can be called from an interrupt service routine.

void **vTaskSetThreadLocalStoragePointer** (*TaskHandle\_t* xTaskToSet, BaseType\_t xIndex, void \*pvValue)

Each task contains an array of pointers that is dimensioned by the configNUM\_THREAD\_LOCAL\_STORAGE\_POINTERS setting in FreeRTOSConfig.h. The kernel does not use the pointers itself, so the application writer can use the pointers for any purpose they wish. The following two functions are used to set and query a pointer respectively.

void \***pvTaskGetThreadLocalStoragePointer** (*TaskHandle\_t* xTaskToQuery, BaseType\_t xIndex)



```
void vApplicationGetIdleTaskMemory (StaticTask_t **ppxIdleTaskTCBBuffer, StackType_t
                                   **ppxIdleTaskStackBuffer, uint32_t *pulIdleTaskStackSize)
```

This function is used to provide a statically allocated block of memory to FreeRTOS to hold the Idle Task TCB. This function is required when configSUPPORT\_STATIC\_ALLOCATION is set. For more information see this URI: [https://www.FreeRTOS.org/a00110.html#configSUPPORT\\_STATIC\\_ALLOCATION](https://www.FreeRTOS.org/a00110.html#configSUPPORT_STATIC_ALLOCATION)

#### 参数

- **ppxIdleTaskTCBBuffer** -- A handle to a statically allocated TCB buffer
- **ppxIdleTaskStackBuffer** -- A handle to a statically allocated Stack buffer for the idle task
- **pulIdleTaskStackSize** -- A pointer to the number of elements that will fit in the allocated stack buffer

```
BaseType_t xTaskCallApplicationTaskHook (TaskHandle_t xTask, void *pvParameter)
```

Calls the hook function associated with xTask. Passing xTask as NULL has the effect of calling the Running tasks (the calling task) hook function.

pvParameter is passed to the hook function for the task to interpret as it wants. The return value is the value returned by the task hook function registered by the user.

```
TaskHandle_t xTaskGetIdleTaskHandle (void)
```

xTaskGetIdleTaskHandle() is only available if INCLUDE\_xTaskGetIdleTaskHandle is set to 1 in FreeRTOSConfig.h.

Simply returns the handle of the idle task of the current core. It is not valid to call xTaskGetIdleTaskHandle() before the scheduler has been started.

```
UBaseType_t uxTaskGetSystemState (TaskStatus_t *const pxTaskStatusArray, const UBaseType_t
                                   uxArraySize, configRUN_TIME_COUNTER_TYPE *const
                                   pulTotalRunTime)
```

configUSE\_TRACE\_FACILITY must be defined as 1 in FreeRTOSConfig.h for uxTaskGetSystemState() to be available.

uxTaskGetSystemState() populates an TaskStatus\_t structure for each task in the system. TaskStatus\_t structures contain, among other things, members for the task handle, task name, task priority, task state, and total amount of run time consumed by the task. See the TaskStatus\_t structure definition in this file for the full member list.

NOTE: This function is intended for debugging use only as its use results in the scheduler remaining suspended for an extended period.

Example usage:

```
// This example demonstrates how a human readable table of run time stats
// information is generated from raw data provided by uxTaskGetSystemState().
// The human readable table is written to pcWriteBuffer
void vTaskGetRunTimeStats( char *pcWriteBuffer )
{
    TaskStatus_t *pxTaskStatusArray;
    volatile UBaseType_t uxArraySize, x;
    configRUN_TIME_COUNTER_TYPE ulTotalRunTime, ulStatsAsPercentage;

    // Make sure the write buffer does not contain a string.
    pcWriteBuffer = 0x00;

    // Take a snapshot of the number of tasks in case it changes while this
    // function is executing.
    uxArraySize = uxTaskGetNumberOfTasks();

    // Allocate a TaskStatus_t structure for each task. An array could be
    // allocated statically at compile time.
```

(下页继续)

```

    pxTaskStatusArray = pvPortMalloc( uxArraySize * sizeof( TaskStatus_t ) );

    if( pxTaskStatusArray != NULL )
    {
        // Generate raw status information about each task.
        uxArraySize = uxTaskGetSystemState( pxTaskStatusArray, uxArraySize, &
        ↪ulTotalRunTime );

        // For percentage calculations.
        ulTotalRunTime /= 100UL;

        // Avoid divide by zero errors.
        if( ulTotalRunTime > 0 )
        {
            // For each populated position in the pxTaskStatusArray array,
            // format the raw data as human readable ASCII data
            for( x = 0; x < uxArraySize; x++ )
            {
                // What percentage of the total run time has the task used?
                // This will always be rounded down to the nearest integer.
                // ulTotalRunTimeDiv100 has already been divided by 100.
                ulStatsAsPercentage = pxTaskStatusArray[ x ].ulRunTimeCounter_
                ↪/ ulTotalRunTime;

                if( ulStatsAsPercentage > 0UL )
                {
                    sprintf( pcWriteBuffer, "%s\t\t%lu\t\t%lu%%\r\n",
                    ↪pxTaskStatusArray[ x ].pcTaskName, pxTaskStatusArray[ x ].ulRunTimeCounter,
                    ↪ulStatsAsPercentage );
                }
                else
                {
                    // If the percentage is zero here then the task has
                    // consumed less than 1% of the total run time.
                    sprintf( pcWriteBuffer, "%s\t\t%lu\t\t<1%%\r\n",
                    ↪pxTaskStatusArray[ x ].pcTaskName, pxTaskStatusArray[ x ].ulRunTimeCounter );
                }

                pcWriteBuffer += strlen( ( char * ) pcWriteBuffer );
            }
        }

        // The array is no longer needed, free the memory it consumes.
        vPortFree( pxTaskStatusArray );
    }
}

```

### 参数

- **pxTaskStatusArray** -- A pointer to an array of TaskStatus\_t structures. The array must contain at least one TaskStatus\_t structure for each task that is under the control of the RTOS. The number of tasks under the control of the RTOS can be determined using the uxTaskGetNumberOfTasks() API function.
- **uxArraySize** -- The size of the array pointed to by the pxTaskStatusArray parameter. The size is specified as the number of indexes in the array, or the number of TaskStatus\_t structures contained in the array, not by the number of bytes in the array.
- **pulTotalRunTime** -- If configGENERATE\_RUN\_TIME\_STATS is set to 1 in FreeRTOSConfig.h then \*pulTotalRunTime is set by uxTaskGetSystemState() to the total run time (as defined by the run time stats clock, see <https://www.FreeRTOS.org/rtos-run-time-stats.html>) since the target booted. pulTotalRunTime can be set to NULL to omit the total run time information.

**返回** The number of `TaskStatus_t` structures that were populated by `uxTaskGetSystemState()`. This should equal the number returned by the `uxTaskGetNumberOfTasks()` API function, but will be zero if the value passed in the `uxArraySize` parameter was too small.

void **vTaskList** (char \*pcWriteBuffer)

`configUSE_TRACE_FACILITY` and `configUSE_STATS_FORMATTING_FUNCTIONS` must both be defined as 1 for this function to be available. See the configuration section of the FreeRTOS.org website for more information.

NOTE 1: This function will disable interrupts for its duration. It is not intended for normal application runtime use but as a debug aid.

Lists all the current tasks, along with their current state and stack usage high water mark.

Tasks are reported as blocked ('B'), ready ('R'), deleted ('D') or suspended ('S').

PLEASE NOTE:

This function is provided for convenience only, and is used by many of the demo applications. Do not consider it to be part of the scheduler.

`vTaskList()` calls `uxTaskGetSystemState()`, then formats part of the `uxTaskGetSystemState()` output into a human readable table that displays task: names, states, priority, stack usage and task number. Stack usage specified as the number of unused `StackType_t` words stack can hold on top of stack - not the number of bytes.

`vTaskList()` has a dependency on the `sprintf()` C library function that might bloat the code size, use a lot of stack, and provide different results on different platforms. An alternative, tiny, third party, and limited functionality implementation of `sprintf()` is provided in many of the FreeRTOS/Demo sub-directories in a file called `printf-stdarg.c` (note `printf-stdarg.c` does not provide a full `snprintf()` implementation!).

It is recommended that production systems call `uxTaskGetSystemState()` directly to get access to raw stats data, rather than indirectly through a call to `vTaskList()`.

**参数 pcWriteBuffer** -- A buffer into which the above mentioned details will be written, in ASCII form. This buffer is assumed to be large enough to contain the generated report. Approximately 40 bytes per task should be sufficient.

void **vTaskGetRunTimeStats** (char \*pcWriteBuffer)

`configGENERATE_RUN_TIME_STATS` and `configUSE_STATS_FORMATTING_FUNCTIONS` must both be defined as 1 for this function to be available. The application must also then provide definitions for `portCONFIGURE_TIMER_FOR_RUN_TIME_STATS()` and `portGET_RUN_TIME_COUNTER_VALUE()` to configure a peripheral timer/counter and return the timers current count value respectively. The counter should be at least 10 times the frequency of the tick count.

NOTE 1: This function will disable interrupts for its duration. It is not intended for normal application runtime use but as a debug aid.

Setting `configGENERATE_RUN_TIME_STATS` to 1 will result in a total accumulated execution time being stored for each task. The resolution of the accumulated time value depends on the frequency of the timer configured by the `portCONFIGURE_TIMER_FOR_RUN_TIME_STATS()` macro. Calling `vTaskGetRunTimeStats()` writes the total execution time of each task into a buffer, both as an absolute count value and as a percentage of the total system execution time.

NOTE 2:

This function is provided for convenience only, and is used by many of the demo applications. Do not consider it to be part of the scheduler.

`vTaskGetRunTimeStats()` calls `uxTaskGetSystemState()`, then formats part of the `uxTaskGetSystemState()` output into a human readable table that displays the amount of time each task has spent in the Running state in both absolute and percentage terms.

`vTaskGetRunTimeStats()` has a dependency on the `sprintf()` C library function that might bloat the code size, use a lot of stack, and provide different results on different platforms. An alternative, tiny, third party, and limited functionality implementation of `sprintf()` is provided in many of the FreeRTOS/Demo sub-directories in a file called `printf-stdarg.c` (note `printf-stdarg.c` does not provide a full `snprintf()` implementation!).

It is recommended that production systems call `uxTaskGetSystemState()` directly to get access to raw stats data, rather than indirectly through a call to `vTaskGetRunTimeStats()`.

**参数 `pcWriteBuffer`** -- A buffer into which the execution times will be written, in ASCII form. This buffer is assumed to be large enough to contain the generated report. Approximately 40 bytes per task should be sufficient.

`configRUN_TIME_COUNTER_TYPE` **`ulTaskGetIdleRunTimeCounter`** (void)

`configGENERATE_RUN_TIME_STATS`, `configUSE_STATS_FORMATTING_FUNCTIONS` and `INCLUDE_xTaskGetIdleTaskHandle` must all be defined as 1 for these functions to be available. The application must also then provide definitions for `portCONFIGURE_TIMER_FOR_RUN_TIME_STATS()` and `portGET_RUN_TIME_COUNTER_VALUE()` to configure a peripheral timer/counter and return the timers current count value respectively. The counter should be at least 10 times the frequency of the tick count.

Setting `configGENERATE_RUN_TIME_STATS` to 1 will result in a total accumulated execution time being stored for each task. The resolution of the accumulated time value depends on the frequency of the timer configured by the `portCONFIGURE_TIMER_FOR_RUN_TIME_STATS()` macro. While `uxTaskGetSystemState()` and `vTaskGetRunTimeStats()` writes the total execution time of each task into a buffer, `ulTaskGetIdleRunTimeCounter()` returns the total execution time of just the idle task and `ulTaskGetIdleRunTimePercent()` returns the percentage of the CPU time used by just the idle task.

Note the amount of idle time is only a good measure of the slack time in a system if there are no other tasks executing at the idle priority, tickless idle is not used, and `configIDLE_SHOULD_YIELD` is set to 0.

---

**备注:** If `configNUMBER_OF_CORES > 1`, calling this function will query the idle task of the current core.

---

**返回** The total run time of the idle task or the percentage of the total run time consumed by the idle task. This is the amount of time the idle task has actually been executing. The unit of time is dependent on the frequency configured using the `portCONFIGURE_TIMER_FOR_RUN_TIME_STATS()` and `portGET_RUN_TIME_COUNTER_VALUE()` macros.

`configRUN_TIME_COUNTER_TYPE` **`ulTaskGetIdleRunTimePercent`** (void)

`BaseType_t` **`xTaskGenericNotifyWait`** (`UBaseType_t` `uxIndexToWaitOn`, `uint32_t` `ulBitsToClearOnEntry`, `uint32_t` `ulBitsToClearOnExit`, `uint32_t` `*pulNotificationValue`, `TickType_t` `xTicksToWait`)

Waits for a direct to task notification to be pending at a given index within an array of direct to task notifications.

See <https://www.FreeRTOS.org/RTOS-task-notifications.html> for details.

`configUSE_TASK_NOTIFICATIONS` must be undefined or defined as 1 for this function to be available.

Each task has a private array of "notification values" (or 'notifications'), each of which is a 32-bit unsigned integer (`uint32_t`). The constant `configTASK_NOTIFICATION_ARRAY_ENTRIES` sets the number of indexes in the array, and (for backward compatibility) defaults to 1 if left undefined. Prior to FreeRTOS V10.4.0 there was only one notification value per task.

Events can be sent to a task using an intermediary object. Examples of such objects are queues, semaphores, mutexes and event groups. Task notifications are a method of sending an event directly to a task without the need for such an intermediary object.

A notification sent to a task can optionally perform an action, such as update, overwrite or increment one of the task's notification values. In that way task notifications can be used to send data to a task, or be used as light weight and fast binary or counting semaphores.

A notification sent to a task will remain pending until it is cleared by the task calling `xTaskNotifyWaitIndexed()` or `ulTaskNotifyTakeIndexed()` (or their un-indexed equivalents). If the task was already in the Blocked state to wait for a notification when the notification arrives then the task will automatically be removed from the Blocked state (unblocked) and the notification cleared.

A task can use `xTaskNotifyWaitIndexed()` to [optionally] block to wait for a notification to be pending, or `ulTaskNotifyTakeIndexed()` to [optionally] block to wait for a notification value to have a non-zero value. The task does not consume any CPU time while it is in the Blocked state.

**NOTE** Each notification within the array operates independently - a task can only block on one notification within the array at a time and will not be unblocked by a notification sent to any other array index.

Backward compatibility information: Prior to FreeRTOS V10.4.0 each task had a single "notification value", and all task notification API functions operated on that value. Replacing the single notification value with an array of notification values necessitated a new set of API functions that could address specific notifications within the array. `xTaskNotifyWait()` is the original API function, and remains backward compatible by always operating on the notification value at index 0 in the array. Calling `xTaskNotifyWait()` is equivalent to calling `xTaskNotifyWaitIndexed()` with the `uxIndexToWaitOn` parameter set to 0.

### 参数

- **uxIndexToWaitOn** -- The index within the calling task's array of notification values on which the calling task will wait for a notification to be received. `uxIndexToWaitOn` must be less than `configTASK_NOTIFICATION_ARRAY_ENTRIES`. `xTaskNotifyWait()` does not have this parameter and always waits for notifications on index 0.
- **ulBitsToClearOnEntry** -- Bits that are set in `ulBitsToClearOnEntry` value will be cleared in the calling task's notification value before the task checks to see if any notifications are pending, and optionally blocks if no notifications are pending. Setting `ulBitsToClearOnEntry` to `ULONG_MAX` (if `limits.h` is included) or `0xffffffffUL` (if `limits.h` is not included) will have the effect of resetting the task's notification value to 0. Setting `ulBitsToClearOnEntry` to 0 will leave the task's notification value unchanged.
- **ulBitsToClearOnExit** -- If a notification is pending or received before the calling task exits the `xTaskNotifyWait()` function then the task's notification value (see the `xTaskNotify()` API function) is passed out using the `pulNotificationValue` parameter. Then any bits that are set in `ulBitsToClearOnExit` will be cleared in the task's notification value (note `*pulNotificationValue` is set before any bits are cleared). Setting `ulBitsToClearOnExit` to `ULONG_MAX` (if `limits.h` is included) or `0xffffffffUL` (if `limits.h` is not included) will have the effect of resetting the task's notification value to 0 before the function exits. Setting `ulBitsToClearOnExit` to 0 will leave the task's notification value unchanged when the function exits (in which case the value passed out in `pulNotificationValue` will match the task's notification value).
- **pulNotificationValue** -- Used to pass the task's notification value out of the function. Note the value passed out will not be effected by the clearing of any bits caused by `ulBitsToClearOnExit` being non-zero.
- **xTicksToWait** -- The maximum amount of time that the task should wait in the Blocked state for a notification to be received, should a notification not already be pending when `xTaskNotifyWait()` was called. The task will not consume any processing time while it is in the Blocked state. This is specified in kernel ticks, the macro `pdMS_TO_TICKS( value_in_ms )` can be used to convert a time specified in milliseconds to a time specified in ticks.

**返回** If a notification was received (including notifications that were already pending when `xTaskNotifyWait` was called) then `pdPASS` is returned. Otherwise `pdFAIL` is returned.

```
void vTaskGenericNotifyGiveFromISR (TaskHandle_t xTaskToNotify, UBaseType_t uxIndexToNotify,
                                     BaseType_t *pxHigherPriorityTaskWoken)
```

A version of `xTaskNotifyGiveIndexed()` that can be called from an interrupt service routine (ISR).

See <https://www.FreeRTOS.org/RTOS-task-notifications.html> for more details.

`configUSE_TASK_NOTIFICATIONS` must be undefined or defined as 1 for this macro to be available.

Each task has a private array of "notification values" (or 'notifications'), each of which is a 32-bit unsigned integer (`uint32_t`). The constant `configTASK_NOTIFICATION_ARRAY_ENTRIES` sets the number of indexes in the array, and (for backward compatibility) defaults to 1 if left undefined. Prior to FreeRTOS V10.4.0 there was only one notification value per task.

Events can be sent to a task using an intermediary object. Examples of such objects are queues, semaphores, mutexes and event groups. Task notifications are a method of sending an event directly to a task without the

need for such an intermediary object.

A notification sent to a task can optionally perform an action, such as update, overwrite or increment one of the task's notification values. In that way task notifications can be used to send data to a task, or be used as light weight and fast binary or counting semaphores.

`vTaskNotifyGiveIndexedFromISR()` is intended for use when task notifications are used as light weight and faster binary or counting semaphore equivalents. Actual FreeRTOS semaphores are given from an ISR using the `xSemaphoreGiveFromISR()` API function, the equivalent action that instead uses a task notification is `vTaskNotifyGiveIndexedFromISR()`.

When task notifications are being used as a binary or counting semaphore equivalent then the task being notified should wait for the notification using the `ulTaskNotifyTakeIndexed()` API function rather than the `xTaskNotifyWaitIndexed()` API function.

**NOTE** Each notification within the array operates independently - a task can only block on one notification within the array at a time and will not be unblocked by a notification sent to any other array index.

Backward compatibility information: Prior to FreeRTOS V10.4.0 each task had a single "notification value", and all task notification API functions operated on that value. Replacing the single notification value with an array of notification values necessitated a new set of API functions that could address specific notifications within the array. `xTaskNotifyFromISR()` is the original API function, and remains backward compatible by always operating on the notification value at index 0 within the array. Calling `xTaskNotifyGiveFromISR()` is equivalent to calling `xTaskNotifyGiveIndexedFromISR()` with the `uxIndexToNotify` parameter set to 0.

#### 参数

- **`xTaskToNotify`** -- The handle of the task being notified. The handle to a task can be returned from the `xTaskCreate()` API function used to create the task, and the handle of the currently running task can be obtained by calling `xTaskGetCurrentTaskHandle()`.
- **`uxIndexToNotify`** -- The index within the target task's array of notification values to which the notification is to be sent. `uxIndexToNotify` must be less than `configTASK_NOTIFICATION_ARRAY_ENTRIES`. `xTaskNotifyGiveFromISR()` does not have this parameter and always sends notifications to index 0.
- **`pxHigherPriorityTaskWoken`** -- `vTaskNotifyGiveFromISR()` will set `*pxHigherPriorityTaskWoken` to `pdTRUE` if sending the notification caused the task to which the notification was sent to leave the Blocked state, and the unblocked task has a priority higher than the currently running task. If `vTaskNotifyGiveFromISR()` sets this value to `pdTRUE` then a context switch should be requested before the interrupt is exited. How a context switch is requested from an ISR is dependent on the port - see the documentation page for the port in use.

`BaseType_t xTaskGenericNotifyStateClear ( TaskHandle_t xTask, UBaseType_t uxIndexToClear )`

See <https://www.FreeRTOS.org/RTOS-task-notifications.html> for details.

`configUSE_TASK_NOTIFICATIONS` must be undefined or defined as 1 for these functions to be available.

Each task has a private array of "notification values" (or 'notifications'), each of which is a 32-bit unsigned integer (`uint32_t`). The constant `configTASK_NOTIFICATION_ARRAY_ENTRIES` sets the number of indexes in the array, and (for backward compatibility) defaults to 1 if left undefined. Prior to FreeRTOS V10.4.0 there was only one notification value per task.

If a notification is sent to an index within the array of notifications then the notification at that index is said to be 'pending' until it is read or explicitly cleared by the receiving task. `xTaskNotifyStateClearIndexed()` is the function that clears a pending notification without reading the notification value. The notification value at the same array index is not altered. Set `xTask` to `NULL` to clear the notification state of the calling task.

Backward compatibility information: Prior to FreeRTOS V10.4.0 each task had a single "notification value", and all task notification API functions operated on that value. Replacing the single notification value with an array of notification values necessitated a new set of API functions that could address specific notifications within the array. `xTaskNotifyStateClear()` is the original API function, and remains backward compatible by always operating on the notification value at index 0 within the array. Calling `xTaskNotifyStateClear()` is equivalent to calling `xTaskNotifyStateClearIndexed()` with the `uxIndexToNotify` parameter set to 0.

#### 参数



- **xTask** -- The handle of the RTOS task that will have a notification state cleared. Set xTask to NULL to clear a notification state in the calling task. To obtain a task's handle create the task using xTaskCreate() and make use of the pxCreatedTask parameter, or create the task using xTaskCreateStatic() and store the returned value, or use the task's name in a call to xTaskGetHandle().
- **uxIndexToClear** -- The index within the target task's array of notification values to act upon. For example, setting uxIndexToClear to 1 will clear the state of the notification at index 1 within the array. uxIndexToClear must be less than configTASK\_NOTIFICATION\_ARRAY\_ENTRIES. ulTaskNotifyStateClear() does not have this parameter and always acts on the notification at index 0.

**返回** pdTRUE if the task's notification state was set to eNotWaitingNotification, otherwise pdFALSE.

uint32\_t **ulTaskGenericNotifyValueClear** (*TaskHandle\_t* xTask, UBaseType\_t uxIndexToClear, uint32\_t ulBitsToClear)

See <https://www.FreeRTOS.org/RTOS-task-notifications.html> for details.

configUSE\_TASK\_NOTIFICATIONS must be undefined or defined as 1 for these functions to be available.

Each task has a private array of "notification values" (or 'notifications'), each of which is a 32-bit unsigned integer (uint32\_t). The constant configTASK\_NOTIFICATION\_ARRAY\_ENTRIES sets the number of indexes in the array, and (for backward compatibility) defaults to 1 if left undefined. Prior to FreeRTOS V10.4.0 there was only one notification value per task.

ulTaskNotifyValueClearIndexed() clears the bits specified by the ulBitsToClear bit mask in the notification value at array index uxIndexToClear of the task referenced by xTask.

Backward compatibility information: Prior to FreeRTOS V10.4.0 each task had a single "notification value", and all task notification API functions operated on that value. Replacing the single notification value with an array of notification values necessitated a new set of API functions that could address specific notifications within the array. ulTaskNotifyValueClear() is the original API function, and remains backward compatible by always operating on the notification value at index 0 within the array. Calling ulTaskNotifyValueClear() is equivalent to calling ulTaskNotifyValueClearIndexed() with the uxIndexToClear parameter set to 0.

#### 参数

- **xTask** -- The handle of the RTOS task that will have bits in one of its notification values cleared. Set xTask to NULL to clear bits in a notification value of the calling task. To obtain a task's handle create the task using xTaskCreate() and make use of the pxCreatedTask parameter, or create the task using xTaskCreateStatic() and store the returned value, or use the task's name in a call to xTaskGetHandle().
- **uxIndexToClear** -- The index within the target task's array of notification values in which to clear the bits. uxIndexToClear must be less than configTASK\_NOTIFICATION\_ARRAY\_ENTRIES. ulTaskNotifyValueClear() does not have this parameter and always clears bits in the notification value at index 0.
- **ulBitsToClear** -- Bit mask of the bits to clear in the notification value of xTask. Set a bit to 1 to clear the corresponding bits in the task's notification value. Set ulBitsToClear to 0xffffffff (UINT\_MAX on 32-bit architectures) to clear the notification value to 0. Set ulBitsToClear to 0 to query the task's notification value without clearing any bits.

**返回** The value of the target task's notification value before the bits specified by ulBitsToClear were cleared.

void **vTaskSetTimeoutState** (Timeout\_t \*const pxTimeout)

Capture the current time for future use with xTaskCheckForTimeout().

**参数 pxTimeout** -- Pointer to a timeout object into which the current time is to be captured. The captured time includes the tick count and the number of times the tick count has overflowed since the system first booted.

BaseType\_t **xTaskCheckForTimeout** (Timeout\_t \*const pxTimeout, TickType\_t \*const pxTicksToWait)

Determines if pxTicksToWait ticks has passed since a time was captured using a call to vTaskSetTimeoutState(). The captured time includes the tick count and the number of times the tick count has overflowed.

## Example Usage:

```

// Driver library function used to receive uxWantedBytes from an Rx buffer
// that is filled by a UART interrupt. If there are not enough bytes in the
// Rx buffer then the task enters the Blocked state until it is notified that
// more data has been placed into the buffer. If there is still not enough
// data then the task re-enters the Blocked state, and xTaskCheckForTimeOut()
// is used to re-calculate the Block time to ensure the total amount of time
// spent in the Blocked state does not exceed MAX_TIME_TO_WAIT. This
// continues until either the buffer contains at least uxWantedBytes bytes,
// or the total amount of time spent in the Blocked state reaches
// MAX_TIME_TO_WAIT - at which point the task reads however many bytes are
// available up to a maximum of uxWantedBytes.

size_t xUART_Receive( uint8_t *pucBuffer, size_t uxWantedBytes )
{
    size_t uxReceived = 0;
    TickType_t xTicksToWait = MAX_TIME_TO_WAIT;
    TimeOut_t xTimeOut;

    // Initialize xTimeOut. This records the time at which this function
    // was entered.
    vTaskSetTimeOutState( &xTimeOut );

    // Loop until the buffer contains the wanted number of bytes, or a
    // timeout occurs.
    while( UART_bytes_in_rx_buffer( pxUARTInstance ) < uxWantedBytes )
    {
        // The buffer didn't contain enough data so this task is going to
        // enter the Blocked state. Adjusting xTicksToWait to account for
        // any time that has been spent in the Blocked state within this
        // function so far to ensure the total amount of time spent in the
        // Blocked state does not exceed MAX_TIME_TO_WAIT.
        if( xTaskCheckForTimeOut( &xTimeOut, &xTicksToWait ) != pdFALSE )
        {
            //Timed out before the wanted number of bytes were available,
            // exit the loop.
            break;
        }

        // Wait for a maximum of xTicksToWait ticks to be notified that the
        // receive interrupt has placed more data into the buffer.
        ulTaskNotifyTake( pdTRUE, xTicksToWait );
    }

    // Attempt to read uxWantedBytes from the receive buffer into pucBuffer.
    // The actual number of bytes read (which might be less than
    // uxWantedBytes) is returned.
    uxReceived = UART_read_from_receive_buffer( pxUARTInstance,
                                                pucBuffer,
                                                uxWantedBytes );

    return uxReceived;
}

```

## 参见:

<https://www.FreeRTOS.org/xTaskCheckForTimeOut.html>

## 参数

- **pxTimeOut** -- The time status as captured previously using vTaskSetTimeOutState. If the timeout has not yet occurred, it is updated to reflect the current time status.



- **pxTicksToWait** -- The number of ticks to check for timeout i.e. if pxTicksToWait ticks have passed since pxTimeOut was last updated (either by vTaskSetTimeOutState() or xTaskCheckForTimeOut()), the timeout has occurred. If the timeout has not occurred, pxTicksToWait is updated to reflect the number of remaining ticks.

**返回** If timeout has occurred, pdTRUE is returned. Otherwise pdFALSE is returned and pxTicksToWait is updated to reflect the number of remaining ticks.

BaseType\_t **xTaskCatchUpTicks** (TickType\_t xTicksToCatchUp)

This function corrects the tick count value after the application code has held interrupts disabled for an extended period resulting in tick interrupts having been missed.

This function is similar to vTaskStepTick(), however, unlike vTaskStepTick(), xTaskCatchUpTicks() may move the tick count forward past a time at which a task should be removed from the blocked state. That means tasks may have to be removed from the blocked state as the tick count is moved.

**参数 xTicksToCatchUp** -- The number of tick interrupts that have been missed due to interrupts being disabled. Its value is not computed automatically, so must be computed by the application writer.

**返回** pdTRUE if moving the tick count forward resulted in a task leaving the blocked state and a context switch being performed. Otherwise pdFALSE.

## Structures

struct **xTASK\_STATUS**

Used with the uxTaskGetSystemState() function to return the state of each task in the system.

## Public Members

*TaskHandle\_t* **xHandle**

The handle of the task to which the rest of the information in the structure relates.

const char \***pcTaskName**

A pointer to the task's name. This value will be invalid if the task was deleted since the structure was populated!

UBaseType\_t **xTaskNumber**

A number unique to the task.

*eTaskState* **eCurrentState**

The state in which the task existed when the structure was populated.

UBaseType\_t **uxCurrentPriority**

The priority at which the task was running (may be inherited) when the structure was populated.

UBaseType\_t **uxBasePriority**

The priority to which the task will return if the task's current priority has been inherited to avoid unbounded priority inversion when obtaining a mutex. Only valid if configUSE\_MUTEXES is defined as 1 in FreeRTOSConfig.h.

configRUN\_TIME\_COUNTER\_TYPE **ulRunTimeCounter**

The total run time allocated to the task so far, as defined by the run time stats clock. See <https://www.FreeRTOS.org/rtos-run-time-stats.html>. Only valid when configGENERATE\_RUN\_TIME\_STATS is defined as 1 in FreeRTOSConfig.h.

StackType\_t \***pxStackBase**

Points to the lowest address of the task's stack area.

configSTACK\_DEPTH\_TYPE **usStackHighWaterMark**

The minimum amount of stack space that has remained for the task since the task was created. The closer this value is to zero the closer the task has come to overflowing its stack.

BaseType\_t **xCoreID**

Core this task is pinned to (0, 1, or tskNO\_AFFINITY). If configNUMBER\_OF\_CORES == 1, this will always be 0.

## Macros

**tskIDLE\_PRIORITY**

Defines the priority used by the idle task. This must not be modified.

**tskNO\_AFFINITY**

Macro representing an unpinned (i.e., "no affinity") task in xCoreID parameters

**taskVALID\_CORE\_ID** (xCoreID)

Macro to check if an xCoreID value is valid

返回 pdTRUE if valid, pdFALSE otherwise.

**taskYIELD** ()

Macro for forcing a context switch.

**taskENTER\_CRITICAL** (x)

Macro to mark the start of a critical code region. Preemptive context switches cannot occur when in a critical region.

NOTE: This may alter the stack (depending on the portable implementation) so must be used with care!

**taskENTER\_CRITICAL\_FROM\_ISR** ()

**taskENTER\_CRITICAL\_ISR** (x)

**taskEXIT\_CRITICAL** (x)

Macro to mark the end of a critical code region. Preemptive context switches cannot occur when in a critical region.

NOTE: This may alter the stack (depending on the portable implementation) so must be used with care!

**taskEXIT\_CRITICAL\_FROM\_ISR** (x)

**taskEXIT\_CRITICAL\_ISR** (x)

**taskDISABLE\_INTERRUPTS** ()

Macro to disable all maskable interrupts.

**taskENABLE\_INTERRUPTS** ()

Macro to enable microcontroller interrupts.

**taskSCHEDULER\_SUSPENDED**

Definitions returned by xTaskGetSchedulerState(). taskSCHEDULER\_SUSPENDED is 0 to generate more optimal code when configASSERT() is defined as the constant is used in assert() statements.

**taskSCHEDULER\_NOT\_STARTED**

**taskSCHEDULER\_RUNNING****xTaskNotifyIndexed** (xTaskToNotify, uxIndexToNotify, ulValue, eAction)See <https://www.FreeRTOS.org/RTOS-task-notifications.html> for details.

configUSE\_TASK\_NOTIFICATIONS must be undefined or defined as 1 for these functions to be available.

Sends a direct to task notification to a task, with an optional value and action.

Each task has a private array of "notification values" (or 'notifications'), each of which is a 32-bit unsigned integer (uint32\_t). The constant configTASK\_NOTIFICATION\_ARRAY\_ENTRIES sets the number of indexes in the array, and (for backward compatibility) defaults to 1 if left undefined. Prior to FreeRTOS V10.4.0 there was only one notification value per task.

Events can be sent to a task using an intermediary object. Examples of such objects are queues, semaphores, mutexes and event groups. Task notifications are a method of sending an event directly to a task without the need for such an intermediary object.

A notification sent to a task can optionally perform an action, such as update, overwrite or increment one of the task's notification values. In that way task notifications can be used to send data to a task, or be used as light weight and fast binary or counting semaphores.

A task can use xTaskNotifyWaitIndexed() or ulTaskNotifyTakeIndexed() to [optionally] block to wait for a notification to be pending. The task does not consume any CPU time while it is in the Blocked state.

A notification sent to a task will remain pending until it is cleared by the task calling xTaskNotifyWaitIndexed() or ulTaskNotifyTakeIndexed() (or their un-indexed equivalents). If the task was already in the Blocked state to wait for a notification when the notification arrives then the task will automatically be removed from the Blocked state (unblocked) and the notification cleared.

**NOTE** Each notification within the array operates independently - a task can only block on one notification within the array at a time and will not be unblocked by a notification sent to any other array index.

Backward compatibility information: Prior to FreeRTOS V10.4.0 each task had a single "notification value", and all task notification API functions operated on that value. Replacing the single notification value with an array of notification values necessitated a new set of API functions that could address specific notifications within the array. xTaskNotify() is the original API function, and remains backward compatible by always operating on the notification value at index 0 in the array. Calling xTaskNotify() is equivalent to calling xTaskNotifyIndexed() with the uxIndexToNotify parameter set to 0.

eSetBits - The target notification value is bitwise ORed with ulValue. xTaskNotifyIndexed() always returns pdPASS in this case.

eIncrement - The target notification value is incremented. ulValue is not used and xTaskNotifyIndexed() always returns pdPASS in this case.

eSetValueWithOverwrite - The target notification value is set to the value of ulValue, even if the task being notified had not yet processed the previous notification at the same array index (the task already had a notification pending at that index). xTaskNotifyIndexed() always returns pdPASS in this case.

eSetValueWithoutOverwrite - If the task being notified did not already have a notification pending at the same array index then the target notification value is set to ulValue and xTaskNotifyIndexed() will return pdPASS. If the task being notified already had a notification pending at the same array index then no action is performed and pdFAIL is returned.

eNoAction - The task receives a notification at the specified array index without the notification value at that index being updated. ulValue is not used and xTaskNotifyIndexed() always returns pdPASS in this case.

pdPreviousNotificationValue - Can be used to pass out the subject task's notification value before any bits are modified by the notify function.

**参数**

- **xTaskToNotify** -- The handle of the task being notified. The handle to a task can be returned from the `xTaskCreate()` API function used to create the task, and the handle of the currently running task can be obtained by calling `xTaskGetCurrentTaskHandle()`.
- **uxIndexToNotify** -- The index within the target task's array of notification values to which the notification is to be sent. `uxIndexToNotify` must be less than `configTASK_NOTIFICATION_ARRAY_ENTRIES`. `xTaskNotify()` does not have this parameter and always sends notifications to index 0.
- **ulValue** -- Data that can be sent with the notification. How the data is used depends on the value of the `eAction` parameter.
- **eAction** -- Specifies how the notification updates the task's notification value, if at all. Valid values for `eAction` are as follows:

**返回** Dependent on the value of `eAction`. See the description of the `eAction` parameter.

**xTaskNotifyAndQueryIndexed** (`xTaskToNotify`, `uxIndexToNotify`, `ulValue`, `eAction`, `pulPreviousNotifyValue`)

See <https://www.FreeRTOS.org/RTOS-task-notifications.html> for details.

`xTaskNotifyAndQueryIndexed()` performs the same operation as `xTaskNotifyIndexed()` with the addition that it also returns the subject task's prior notification value (the notification value at the time the function is called rather than when the function returns) in the additional `pulPreviousNotifyValue` parameter.

`xTaskNotifyAndQuery()` performs the same operation as `xTaskNotify()` with the addition that it also returns the subject task's prior notification value (the notification value as it was at the time the function is called, rather than when the function returns) in the additional `pulPreviousNotifyValue` parameter.

**xTaskNotifyIndexedFromISR** (`xTaskToNotify`, `uxIndexToNotify`, `ulValue`, `eAction`, `pxHigherPriorityTaskWoken`)

See <https://www.FreeRTOS.org/RTOS-task-notifications.html> for details.

`configUSE_TASK_NOTIFICATIONS` must be undefined or defined as 1 for these functions to be available.

A version of `xTaskNotifyIndexed()` that can be used from an interrupt service routine (ISR).

Each task has a private array of "notification values" (or 'notifications'), each of which is a 32-bit unsigned integer (`uint32_t`). The constant `configTASK_NOTIFICATION_ARRAY_ENTRIES` sets the number of indexes in the array, and (for backward compatibility) defaults to 1 if left undefined. Prior to FreeRTOS V10.4.0 there was only one notification value per task.

Events can be sent to a task using an intermediary object. Examples of such objects are queues, semaphores, mutexes and event groups. Task notifications are a method of sending an event directly to a task without the need for such an intermediary object.

A notification sent to a task can optionally perform an action, such as update, overwrite or increment one of the task's notification values. In that way task notifications can be used to send data to a task, or be used as light weight and fast binary or counting semaphores.

A task can use `xTaskNotifyWaitIndexed()` to [optionally] block to wait for a notification to be pending, or `ulTaskNotifyTakeIndexed()` to [optionally] block to wait for a notification value to have a non-zero value. The task does not consume any CPU time while it is in the Blocked state.

A notification sent to a task will remain pending until it is cleared by the task calling `xTaskNotifyWaitIndexed()` or `ulTaskNotifyTakeIndexed()` (or their un-indexed equivalents). If the task was already in the Blocked state to wait for a notification when the notification arrives then the task will automatically be removed from the Blocked state (unblocked) and the notification cleared.

**NOTE** Each notification within the array operates independently - a task can only block on one notification within the array at a time and will not be unblocked by a notification sent to any other array index.

Backward compatibility information: Prior to FreeRTOS V10.4.0 each task had a single "notification value", and all task notification API functions operated on that value. Replacing the single notification value with an array of notification values necessitated a new set of API functions that could address specific notifications within the array. `xTaskNotifyFromISR()` is the original API function, and remains backward compatible by always operating on the notification value at index 0 within the array. Calling `xTaskNotifyFromISR()` is equivalent to calling `xTaskNotifyIndexedFromISR()` with the `uxIndexToNotify` parameter set to 0.

**eSetBits** - The task's notification value is bitwise ORed with `ulValue`. `xTaskNotify()` always returns `pdPASS` in this case.

**eIncrement** - The task's notification value is incremented. `ulValue` is not used and `xTaskNotify()` always returns `pdPASS` in this case.

**eSetValueWithOverwrite** - The task's notification value is set to the value of `ulValue`, even if the task being notified had not yet processed the previous notification (the task already had a notification pending). `xTaskNotify()` always returns `pdPASS` in this case.

**eSetValueWithoutOverwrite** - If the task being notified did not already have a notification pending then the task's notification value is set to `ulValue` and `xTaskNotify()` will return `pdPASS`. If the task being notified already had a notification pending then no action is performed and `pdFAIL` is returned.

**eNoAction** - The task receives a notification without its notification value being updated. `ulValue` is not used and `xTaskNotify()` always returns `pdPASS` in this case.

### 参数

- **uxIndexToNotify** -- The index within the target task's array of notification values to which the notification is to be sent. `uxIndexToNotify` must be less than `configTASK_NOTIFICATION_ARRAY_ENTRIES`. `xTaskNotifyFromISR()` does not have this parameter and always sends notifications to index 0.
- **xTaskToNotify** -- The handle of the task being notified. The handle to a task can be returned from the `xTaskCreate()` API function used to create the task, and the handle of the currently running task can be obtained by calling `xTaskGetCurrentTaskHandle()`.
- **ulValue** -- Data that can be sent with the notification. How the data is used depends on the value of the `eAction` parameter.
- **eAction** -- Specifies how the notification updates the task's notification value, if at all. Valid values for `eAction` are as follows:
- **pxHigherPriorityTaskWoken** -- `xTaskNotifyFromISR()` will set `*pxHigherPriorityTaskWoken` to `pdTRUE` if sending the notification caused the task to which the notification was sent to leave the Blocked state, and the unblocked task has a priority higher than the currently running task. If `xTaskNotifyFromISR()` sets this value to `pdTRUE` then a context switch should be requested before the interrupt is exited. How a context switch is requested from an ISR is dependent on the port - see the documentation page for the port in use.

**返回** Dependent on the value of `eAction`. See the description of the `eAction` parameter.

**xTaskNotifyAndQueryIndexedFromISR** (`xTaskToNotify`, `uxIndexToNotify`, `ulValue`, `eAction`, `pulPreviousNotificationValue`, `pxHigherPriorityTaskWoken`)

See <https://www.FreeRTOS.org/RTOS-task-notifications.html> for details.

`xTaskNotifyAndQueryIndexedFromISR()` performs the same operation as `xTaskNotifyIndexedFromISR()` with the addition that it also returns the subject task's prior notification value (the notification value at the time the function is called rather than at the time the function returns) in the additional `pulPreviousNotificationValue` parameter.

`xTaskNotifyAndQueryFromISR()` performs the same operation as `xTaskNotifyFromISR()` with the addition that it also returns the subject task's prior notification value (the notification value at the time the function is called rather than at the time the function returns) in the additional `pulPreviousNotificationValue` parameter.

**xTaskNotifyWait** (`ulBitsToClearOnEntry`, `ulBitsToClearOnExit`, `pulNotificationValue`, `xTicksToWait`)

**xTaskNotifyWaitIndexed** (`uxIndexToWaitOn`, `ulBitsToClearOnEntry`, `ulBitsToClearOnExit`, `pulNotificationValue`, `xTicksToWait`)

**xTaskNotifyGiveIndexed** (`xTaskToNotify`, `uxIndexToNotify`)

Sends a direct to task notification to a particular index in the target task's notification array in a manner similar to giving a counting semaphore.

See <https://www.FreeRTOS.org/RTOS-task-notifications.html> for more details.

`configUSE_TASK_NOTIFICATIONS` must be undefined or defined as 1 for these macros to be available.

Each task has a private array of "notification values" (or 'notifications'), each of which is a 32-bit unsigned integer (`uint32_t`). The constant `configTASK_NOTIFICATION_ARRAY_ENTRIES` sets the number of indexes in the array, and (for backward compatibility) defaults to 1 if left undefined. Prior to FreeRTOS V10.4.0 there was only one notification value per task.

Events can be sent to a task using an intermediary object. Examples of such objects are queues, semaphores, mutexes and event groups. Task notifications are a method of sending an event directly to a task without the need for such an intermediary object.

A notification sent to a task can optionally perform an action, such as update, overwrite or increment one of the task's notification values. In that way task notifications can be used to send data to a task, or be used as light weight and fast binary or counting semaphores.

`xTaskNotifyGiveIndexed()` is a helper macro intended for use when task notifications are used as light weight and faster binary or counting semaphore equivalents. Actual FreeRTOS semaphores are given using the `xSemaphoreGive()` API function, the equivalent action that instead uses a task notification is `xTaskNotifyGiveIndexed()`.

When task notifications are being used as a binary or counting semaphore equivalent then the task being notified should wait for the notification using the `ulTaskNotifyTakeIndexed()` API function rather than the `xTaskNotifyWaitIndexed()` API function.

**NOTE** Each notification within the array operates independently - a task can only block on one notification within the array at a time and will not be unblocked by a notification sent to any other array index.

Backward compatibility information: Prior to FreeRTOS V10.4.0 each task had a single "notification value", and all task notification API functions operated on that value. Replacing the single notification value with an array of notification values necessitated a new set of API functions that could address specific notifications within the array. `xTaskNotifyGive()` is the original API function, and remains backward compatible by always operating on the notification value at index 0 in the array. Calling `xTaskNotifyGive()` is equivalent to calling `xTaskNotifyGiveIndexed()` with the `uxIndexToNotify` parameter set to 0.

#### 参数

- **`xTaskToNotify`** -- The handle of the task being notified. The handle to a task can be returned from the `xTaskCreate()` API function used to create the task, and the handle of the currently running task can be obtained by calling `xTaskGetCurrentTaskHandle()`.
- **`uxIndexToNotify`** -- The index within the target task's array of notification values to which the notification is to be sent. `uxIndexToNotify` must be less than `configTASK_NOTIFICATION_ARRAY_ENTRIES`. `xTaskNotifyGive()` does not have this parameter and always sends notifications to index 0.

**返回** `xTaskNotifyGive()` is a macro that calls `xTaskNotify()` with the `eAction` parameter set to `eIncrement` - so `pdPASS` is always returned.

**`vTaskNotifyGiveFromISR`** (`xTaskToNotify`, `pxHigherPriorityTaskWoken`)

**`vTaskNotifyGiveIndexedFromISR`** (`xTaskToNotify`, `uxIndexToNotify`, `pxHigherPriorityTaskWoken`)

**`ulTaskNotifyTakeIndexed`** (`uxIndexToWaitOn`, `xClearCountOnExit`, `xTicksToWait`)

Waits for a direct to task notification on a particular index in the calling task's notification array in a manner similar to taking a counting semaphore.

See <https://www.FreeRTOS.org/RTOS-task-notifications.html> for details.

`configUSE_TASK_NOTIFICATIONS` must be undefined or defined as 1 for this function to be available.

Each task has a private array of "notification values" (or 'notifications'), each of which is a 32-bit unsigned integer (`uint32_t`). The constant `configTASK_NOTIFICATION_ARRAY_ENTRIES` sets the number of indexes in the array, and (for backward compatibility) defaults to 1 if left undefined. Prior to FreeRTOS V10.4.0 there was only one notification value per task.

Events can be sent to a task using an intermediary object. Examples of such objects are queues, semaphores, mutexes and event groups. Task notifications are a method of sending an event directly to a task without the need for such an intermediary object.



A notification sent to a task can optionally perform an action, such as update, overwrite or increment one of the task's notification values. In that way task notifications can be used to send data to a task, or be used as light weight and fast binary or counting semaphores.

`ulTaskNotifyTakeIndexed()` is intended for use when a task notification is used as a faster and lighter weight binary or counting semaphore alternative. Actual FreeRTOS semaphores are taken using the `xSemaphoreTake()` API function, the equivalent action that instead uses a task notification is `ulTaskNotifyTakeIndexed()`.

When a task is using its notification value as a binary or counting semaphore other tasks should send notifications to it using the `xTaskNotifyGiveIndexed()` macro, or `xTaskNotifyIndex()` function with the `eAction` parameter set to `eIncrement`.

`ulTaskNotifyTakeIndexed()` can either clear the task's notification value at the array index specified by the `uxIndexToWaitOn` parameter to zero on exit, in which case the notification value acts like a binary semaphore, or decrement the notification value on exit, in which case the notification value acts like a counting semaphore.

A task can use `ulTaskNotifyTakeIndexed()` to [optionally] block to wait for a notification. The task does not consume any CPU time while it is in the Blocked state.

Where as `xTaskNotifyWaitIndexed()` will return when a notification is pending, `ulTaskNotifyTakeIndexed()` will return when the task's notification value is not zero.

**NOTE** Each notification within the array operates independently - a task can only block on one notification within the array at a time and will not be unblocked by a notification sent to any other array index.

Backward compatibility information: Prior to FreeRTOS V10.4.0 each task had a single "notification value", and all task notification API functions operated on that value. Replacing the single notification value with an array of notification values necessitated a new set of API functions that could address specific notifications within the array. `ulTaskNotifyTake()` is the original API function, and remains backward compatible by always operating on the notification value at index 0 in the array. Calling `ulTaskNotifyTake()` is equivalent to calling `ulTaskNotifyTakeIndexed()` with the `uxIndexToWaitOn` parameter set to 0.

#### 参数

- **`uxIndexToWaitOn`** -- The index within the calling task's array of notification values on which the calling task will wait for a notification to be non-zero. `uxIndexToWaitOn` must be less than `configTASK_NOTIFICATION_ARRAY_ENTRIES`. `xTaskNotifyTake()` does not have this parameter and always waits for notifications on index 0.
- **`xClearCountOnExit`** -- if `xClearCountOnExit` is `pdFALSE` then the task's notification value is decremented when the function exits. In this way the notification value acts like a counting semaphore. If `xClearCountOnExit` is not `pdFALSE` then the task's notification value is cleared to zero when the function exits. In this way the notification value acts like a binary semaphore.
- **`xTicksToWait`** -- The maximum amount of time that the task should wait in the Blocked state for the task's notification value to be greater than zero, should the count not already be greater than zero when `ulTaskNotifyTake()` was called. The task will not consume any processing time while it is in the Blocked state. This is specified in kernel ticks, the macro `pdMS_TO_TICKS( value_in_ms )` can be used to convert a time specified in milliseconds to a time specified in ticks.

**返回** The task's notification count before it is either cleared to zero or decremented (see the `xClearCountOnExit` parameter).

**`xTaskNotifyStateClear`** (`xTask`)

**`xTaskNotifyStateClearIndexed`** (`xTask`, `uxIndexToClear`)

**`ulTaskNotifyValueClear`** (`xTask`, `ulBitsToClear`)

**`ulTaskNotifyValueClearIndexed`** (`xTask`, `uxIndexToClear`, `ulBitsToClear`)

#### Type Definitions

```
typedef struct tskTaskControlBlock *TaskHandle_t
```

```
typedef BaseType_t (*TaskHookFunction_t)(void*)
```

Defines the prototype to which the application task hook function must conform.

```
typedef struct xTASK_STATUS TaskStatus_t
```

Used with the uxTaskGetSystemState() function to return the state of each task in the system.

## Enumerations

```
enum eTaskState
```

Task states returned by eTaskGetState.

*Values:*

```
enumerator eRunning
```

A task is querying the state of itself, so must be running.

```
enumerator eReady
```

The task being queried is in a ready or pending ready list.

```
enumerator eBlocked
```

The task being queried is in the Blocked state.

```
enumerator eSuspended
```

The task being queried is in the Suspended state, or is in the Blocked state with an infinite time out.

```
enumerator eDeleted
```

The task being queried has been deleted, but its TCB has not yet been freed.

```
enumerator eInvalid
```

Used as an 'invalid state' value.

```
enum eNotifyAction
```

Actions that can be performed when vTaskNotify() is called.

*Values:*

```
enumerator eNoAction
```

Notify the task without updating its notify value.

```
enumerator eSetBits
```

Set bits in the task's notification value.

```
enumerator eIncrement
```

Increment the task's notification value.

```
enumerator eSetValueWithOverwrite
```

Set the task's notification value to a specific value even if the previous value has not yet been read by the task.



**enumerator eSetValueWithoutOverwrite**

Set the task's notification value if the previous value has been read by the task.

**enum eSleepModeStatus**

Possible return values for eTaskConfirmSleepModeStatus().

Values:

**enumerator eAbortSleep**

A task has been made ready or a context switch pended since portSUPPRESS\_TICKS\_AND\_SLEEP() was called - abort entering a sleep mode.

**enumerator eStandardSleep**

Enter a sleep mode that will not last any longer than the expected idle time.

**队列 API****Header File**

- [components/freertos/FreeRTOS-Kernel/include/freertos/queue.h](#)
- This header file can be included with:

```
#include "freertos/queue.h"
```

**Functions**

BaseType\_t **xQueueGenericSend** (*QueueHandle\_t* xQueue, const void \*const pvItemToQueue, TickType\_t xTicksToWait, const BaseType\_t xCopyPosition)

It is preferred that the macros xQueueSend(), xQueueSendToFront() and xQueueSendToBack() are used in place of calling this function directly.

Post an item on a queue. The item is queued by copy, not by reference. This function must not be called from an interrupt service routine. See xQueueSendFromISR () for an alternative which may be used in an ISR.

Example usage:

```
struct AMessage
{
    char ucMessageID;
    char ucData[ 20 ];
} xMessage;

uint32_t ulVar = 10UL;

void vATask( void *pvParameters )
{
    QueueHandle_t xQueue1, xQueue2;
    struct AMessage *pxMessage;

    // Create a queue capable of containing 10 uint32_t values.
    xQueue1 = xQueueCreate( 10, sizeof( uint32_t ) );

    // Create a queue capable of containing 10 pointers to AMessage structures.
    // These should be passed by pointer as they contain a lot of data.
    xQueue2 = xQueueCreate( 10, sizeof( struct AMessage * ) );
```

(下页继续)

```

// ...

if( xQueue1 != 0 )
{
// Send an uint32_t. Wait for 10 ticks for space to become
// available if necessary.
if( xQueueGenericSend( xQueue1, ( void * ) &ulVar, ( TickType_t ) 10,
↳queueSEND_TO_BACK ) != pdPASS )
{
// Failed to post the message, even after 10 ticks.
}
}

if( xQueue2 != 0 )
{
// Send a pointer to a struct AMessage object. Don't block if the
// queue is already full.
pxMessage = &xMessage;
xQueueGenericSend( xQueue2, ( void * ) &pxMessage, ( TickType_t ) 0,
↳queueSEND_TO_BACK );
}

//... Rest of task code.
}

```

**参数**

- **xQueue** -- The handle to the queue on which the item is to be posted.
- **pvItemToQueue** -- A pointer to the item that is to be placed on the queue. The size of the items the queue will hold was defined when the queue was created, so this many bytes will be copied from pvItemToQueue into the queue storage area.
- **xTicksToWait** -- The maximum amount of time the task should block waiting for space to become available on the queue, should it already be full. The call will return immediately if this is set to 0 and the queue is full. The time is defined in tick periods so the constant portTICK\_PERIOD\_MS should be used to convert to real time if this is required.
- **xCopyPosition** -- Can take the value queueSEND\_TO\_BACK to place the item at the back of the queue, or queueSEND\_TO\_FRONT to place the item at the front of the queue (for high priority messages).

**返回** pdTRUE if the item was successfully posted, otherwise errQUEUE\_FULL.

BaseType\_t **xQueuePeek** (*QueueHandle\_t* xQueue, void \*const pvBuffer, TickType\_t xTicksToWait)

Receive an item from a queue without removing the item from the queue. The item is received by copy so a buffer of adequate size must be provided. The number of bytes copied into the buffer was defined when the queue was created.

Successfully received items remain on the queue so will be returned again by the next call, or a call to xQueueReceive().

This macro must not be used in an interrupt service routine. See xQueuePeekFromISR() for an alternative that can be called from an interrupt service routine.

Example usage:

```

struct AMessage
{
char ucMessageID;
char ucData[ 20 ];
}

```

(下页继续)

```

} xMessage;

QueueHandle_t xQueue;

// Task to create a queue and post a value.
void vATask( void *pvParameters )
{
    struct AMessage *pxMessage;

    // Create a queue capable of containing 10 pointers to AMessage structures.
    // These should be passed by pointer as they contain a lot of data.
    xQueue = xQueueCreate( 10, sizeof( struct AMessage * ) );
    if( xQueue == 0 )
    {
        // Failed to create the queue.
    }

    // ...

    // Send a pointer to a struct AMessage object. Don't block if the
    // queue is already full.
    pxMessage = & xMessage;
    xQueueSend( xQueue, ( void * ) &pxMessage, ( TickType_t ) 0 );

    // ... Rest of task code.
}

// Task to peek the data from the queue.
void vADifferentTask( void *pvParameters )
{
    struct AMessage *pxRxdMessage;

    if( xQueue != 0 )
    {
        // Peek a message on the created queue. Block for 10 ticks if a
        // message is not immediately available.
        if( xQueuePeek( xQueue, &( pxRxdMessage ), ( TickType_t ) 10 ) )
        {
            // pxRxdMessage now points to the struct AMessage variable posted
            // by vATask, but the item still remains on the queue.
        }
    }

    // ... Rest of task code.
}

```

**参数**

- **xQueue** -- The handle to the queue from which the item is to be received.
- **pvBuffer** -- Pointer to the buffer into which the received item will be copied.
- **xTicksToWait** -- The maximum amount of time the task should block waiting for an item to receive should the queue be empty at the time of the call. The time is defined in tick periods so the constant portTICK\_PERIOD\_MS should be used to convert to real time if this is required. xQueuePeek() will return immediately if xTicksToWait is 0 and the queue is empty.

**返回** pdTRUE if an item was successfully received from the queue, otherwise pdFALSE.

BaseType\_t **xQueuePeekFromISR** (QueueHandle\_t xQueue, void \*const pvBuffer)

A version of xQueuePeek() that can be called from an interrupt service routine (ISR).

Receive an item from a queue without removing the item from the queue. The item is received by copy so a

buffer of adequate size must be provided. The number of bytes copied into the buffer was defined when the queue was created.

Successfully received items remain on the queue so will be returned again by the next call, or a call to `xQueueReceive()`.

#### 参数

- **xQueue** -- The handle to the queue from which the item is to be received.
- **pvBuffer** -- Pointer to the buffer into which the received item will be copied.

**返回** `pdTRUE` if an item was successfully received from the queue, otherwise `pdFALSE`.

`BaseType_t xQueueReceive (QueueHandle_t xQueue, void *const pvBuffer, TickType_t xTicksToWait)`

Receive an item from a queue. The item is received by copy so a buffer of adequate size must be provided. The number of bytes copied into the buffer was defined when the queue was created.

Successfully received items are removed from the queue.

This function must not be used in an interrupt service routine. See `xQueueReceiveFromISR` for an alternative that can.

Example usage:

```

struct AMessage
{
    char ucMessageID;
    char ucData[ 20 ];
} xMessage;

QueueHandle_t xQueue;

// Task to create a queue and post a value.
void vATask( void *pvParameters )
{
    struct AMessage *pxMessage;

    // Create a queue capable of containing 10 pointers to AMessage structures.
    // These should be passed by pointer as they contain a lot of data.
    xQueue = xQueueCreate( 10, sizeof( struct AMessage * ) );
    if( xQueue == 0 )
    {
        // Failed to create the queue.
    }

    // ...

    // Send a pointer to a struct AMessage object. Don't block if the
    // queue is already full.
    pxMessage = & xMessage;
    xQueueSend( xQueue, ( void * ) &pxMessage, ( TickType_t ) 0 );

    // ... Rest of task code.
}

// Task to receive from the queue.
void vADifferentTask( void *pvParameters )
{
    struct AMessage *pxRxdMessage;

    if( xQueue != 0 )
    {
        // Receive a message on the created queue. Block for 10 ticks if a
        // message is not immediately available.
    }
}

```

(下页继续)

(续上页)

```

if( xQueueReceive( xQueue, &(amp; pxRxdMessage ), ( TickType_t ) 10 ) )
{
    // pCRxdMessage now points to the struct AMessage variable posted
    // by vATask.
}

// ... Rest of task code.
}

```

**参数**

- **xQueue** -- The handle to the queue from which the item is to be received.
- **pvBuffer** -- Pointer to the buffer into which the received item will be copied.
- **xTicksToWait** -- The maximum amount of time the task should block waiting for an item to receive should the queue be empty at the time of the call. xQueueReceive() will return immediately if xTicksToWait is zero and the queue is empty. The time is defined in tick periods so the constant portTICK\_PERIOD\_MS should be used to convert to real time if this is required.

**返回** pdTRUE if an item was successfully received from the queue, otherwise pdFALSE.

UBaseType\_t **uxQueueMessagesWaiting** (const [QueueHandle\\_t](#) xQueue)

Return the number of messages stored in a queue.

**参数** **xQueue** -- A handle to the queue being queried.

**返回** The number of messages available in the queue.

UBaseType\_t **uxQueueSpacesAvailable** (const [QueueHandle\\_t](#) xQueue)

Return the number of free spaces available in a queue. This is equal to the number of items that can be sent to the queue before the queue becomes full if no items are removed.

**参数** **xQueue** -- A handle to the queue being queried.

**返回** The number of spaces available in the queue.

void **vQueueDelete** ([QueueHandle\\_t](#) xQueue)

Delete a queue - freeing all the memory allocated for storing of items placed on the queue.

**参数** **xQueue** -- A handle to the queue to be deleted.

BaseType\_t **xQueueGenericSendFromISR** ([QueueHandle\\_t](#) xQueue, const void \*const pvItemToQueue, BaseType\_t \*const pxHigherPriorityTaskWoken, const BaseType\_t xCopyPosition)

It is preferred that the macros xQueueSendFromISR(), xQueueSendToFrontFromISR() and xQueueSendToBackFromISR() be used in place of calling this function directly. xQueueGiveFromISR() is an equivalent for use by semaphores that don't actually copy any data.

Post an item on a queue. It is safe to use this function from within an interrupt service routine.

Items are queued by copy not reference so it is preferable to only queue small items, especially when called from an ISR. In most cases it would be preferable to store a pointer to the item being queued.

Example usage for buffered IO (where the ISR can obtain more than one value per call):

```

void vBufferISR( void )
{
    char cIn;
    BaseType_t xHigherPriorityTaskWokenByPost;

    // We have not woken a task at the start of the ISR.
    xHigherPriorityTaskWokenByPost = pdFALSE;
}

```

(下页继续)

```

// Loop until the buffer is empty.
do
{
// Obtain a byte from the buffer.
    cIn = portINPUT_BYTE( RX_REGISTER_ADDRESS );

// Post each byte.
    xQueueGenericSendFromISR( xRxQueue, &cIn, &xHigherPriorityTaskWokenByPost,
↪ queueSEND_TO_BACK );

} while( portINPUT_BYTE( BUFFER_COUNT ) );

// Now the buffer is empty we can switch context if necessary. Note that the
// name of the yield function required is port specific.
if( xHigherPriorityTaskWokenByPost )
{
    portYIELD_FROM_ISR();
}
}

```

**参数**

- **xQueue** -- The handle to the queue on which the item is to be posted.
- **pvItemToQueue** -- A pointer to the item that is to be placed on the queue. The size of the items the queue will hold was defined when the queue was created, so this many bytes will be copied from pvItemToQueue into the queue storage area.
- **pxHigherPriorityTaskWoken** -- xQueueGenericSendFromISR() will set \*pxHigherPriorityTaskWoken to pdTRUE if sending to the queue caused a task to unblock, and the unblocked task has a priority higher than the currently running task. If xQueueGenericSendFromISR() sets this value to pdTRUE then a context switch should be requested before the interrupt is exited.
- **xCopyPosition** -- Can take the value queueSEND\_TO\_BACK to place the item at the back of the queue, or queueSEND\_TO\_FRONT to place the item at the front of the queue (for high priority messages).

**返回** pdTRUE if the data was successfully sent to the queue, otherwise errQUEUE\_FULL.

BaseType\_t **xQueueGiveFromISR** (*QueueHandle\_t* xQueue, BaseType\_t \*const pxHigherPriorityTaskWoken)

BaseType\_t **xQueueReceiveFromISR** (*QueueHandle\_t* xQueue, void \*const pvBuffer, BaseType\_t \*const pxHigherPriorityTaskWoken)

Receive an item from a queue. It is safe to use this function from within an interrupt service routine.

Example usage:

```

QueueHandle_t xQueue;

// Function to create a queue and post some values.
void vAFunction( void *pvParameters )
{
    char cValueToPost;
    const TickType_t xTicksToWait = ( TickType_t )0xff;

    // Create a queue capable of containing 10 characters.
    xQueue = xQueueCreate( 10, sizeof( char ) );
    if( xQueue == 0 )
    {
        // Failed to create the queue.
    }
}

```

(下页继续)

```

}

// ...

// Post some characters that will be used within an ISR. If the queue
// is full then this task will block for xTicksToWait ticks.
cValueToPost = 'a';
xQueueSend( xQueue, ( void * ) &cValueToPost, xTicksToWait );
cValueToPost = 'b';
xQueueSend( xQueue, ( void * ) &cValueToPost, xTicksToWait );

// ... keep posting characters ... this task may block when the queue
// becomes full.

cValueToPost = 'c';
xQueueSend( xQueue, ( void * ) &cValueToPost, xTicksToWait );
}

// ISR that outputs all the characters received on the queue.
void vISR_Routine( void )
{
BaseType_t xTaskWokenByReceive = pdFALSE;
char cRxdChar;

while( xQueueReceiveFromISR( xQueue, ( void * ) &cRxdChar, &
↪xTaskWokenByReceive) )
{
// A character was received. Output the character now.
vOutputCharacter( cRxdChar );

// If removing the character from the queue woke the task that was
// posting onto the queue xTaskWokenByReceive will have been set to
// pdTRUE. No matter how many times this loop iterates only one
// task will be woken.
}

if( xTaskWokenByReceive != ( char ) pdFALSE;
{
taskYIELD ();
}
}

```

**参数**

- **xQueue** -- The handle to the queue from which the item is to be received.
- **pvBuffer** -- Pointer to the buffer into which the received item will be copied.
- **pxHigherPriorityTaskWoken** -- A task may be blocked waiting for space to become available on the queue. If xQueueReceiveFromISR causes such a task to unblock \*pxTaskWoken will get set to pdTRUE, otherwise \*pxTaskWoken will remain unchanged.

**返回** pdTRUE if an item was successfully received from the queue, otherwise pdFALSE.

BaseType\_t **xQueueIsQueueEmptyFromISR** (const [QueueHandle\\_t](#) xQueue)

Queries a queue to determine if the queue is empty. This function should only be used in an ISR.

**参数** **xQueue** -- The handle of the queue being queried

**返回** pdFALSE if the queue is not empty, or pdTRUE if the queue is empty.

BaseType\_t **xQueueIsQueueFullFromISR** (const [QueueHandle\\_t](#) xQueue)

Queries a queue to determine if the queue is full. This function should only be used in an ISR.

**参数** **xQueue** -- The handle of the queue being queried

**返回** pdFALSE if the queue is not full, or pdTRUE if the queue is full.

UBaseType\_t **uxQueueMessagesWaitingFromISR** (const *QueueHandle\_t* xQueue)

A version of uxQueueMessagesWaiting() that can be called from an ISR. Return the number of messages stored in a queue.

**参数** **xQueue** -- A handle to the queue being queried.

**返回** The number of messages available in the queue.

void **vQueueAddToRegistry** (*QueueHandle\_t* xQueue, const char \*pcQueueName)

The registry is provided as a means for kernel aware debuggers to locate queues, semaphores and mutexes. Call vQueueAddToRegistry() add a queue, semaphore or mutex handle to the registry if you want the handle to be available to a kernel aware debugger. If you are not using a kernel aware debugger then this function can be ignored.

configQUEUE\_REGISTRY\_SIZE defines the maximum number of handles the registry can hold. configQUEUE\_REGISTRY\_SIZE must be greater than 0 within FreeRTOSConfig.h for the registry to be available. Its value does not affect the number of queues, semaphores and mutexes that can be created - just the number that the registry can hold.

If vQueueAddToRegistry is called more than once with the same xQueue parameter, the registry will store the pcQueueName parameter from the most recent call to vQueueAddToRegistry.

**参数**

- **xQueue** -- The handle of the queue being added to the registry. This is the handle returned by a call to xQueueCreate(). Semaphore and mutex handles can also be passed in here.
- **pcQueueName** -- The name to be associated with the handle. This is the name that the kernel aware debugger will display. The queue registry only stores a pointer to the string - so the string must be persistent (global or preferably in ROM/Flash), not on the stack.

void **vQueueUnregisterQueue** (*QueueHandle\_t* xQueue)

The registry is provided as a means for kernel aware debuggers to locate queues, semaphores and mutexes. Call vQueueAddToRegistry() add a queue, semaphore or mutex handle to the registry if you want the handle to be available to a kernel aware debugger, and vQueueUnregisterQueue() to remove the queue, semaphore or mutex from the register. If you are not using a kernel aware debugger then this function can be ignored.

**参数** **xQueue** -- The handle of the queue being removed from the registry.

const char \***pcQueueGetName** (*QueueHandle\_t* xQueue)

The queue registry is provided as a means for kernel aware debuggers to locate queues, semaphores and mutexes. Call pcQueueGetName() to look up and return the name of a queue in the queue registry from the queue's handle.

**参数** **xQueue** -- The handle of the queue the name of which will be returned.

**返回** If the queue is in the registry then a pointer to the name of the queue is returned. If the queue is not in the registry then NULL is returned.

*QueueSetHandle\_t* **xQueueCreateSet** (const UBaseType\_t uxEventQueueLength)

Queue sets provide a mechanism to allow a task to block (pend) on a read operation from multiple queues or semaphores simultaneously.

See FreeRTOS/Source/Demo/Common/Minimal/QueueSet.c for an example using this function.

A queue set must be explicitly created using a call to xQueueCreateSet() before it can be used. Once created, standard FreeRTOS queues and semaphores can be added to the set using calls to xQueueAddToSet(). xQueueSelectFromSet() is then used to determine which, if any, of the queues or semaphores contained in the set is in a state where a queue read or semaphore take operation would be successful.

Note 1: See the documentation on <https://www.FreeRTOS.org/RTOS-queue-sets.html> for reasons why queue sets are very rarely needed in practice as there are simpler methods of blocking on multiple objects.

Note 2: Blocking on a queue set that contains a mutex will not cause the mutex holder to inherit the priority of the blocked task.

Note 3: An additional 4 bytes of RAM is required for each space in a every queue added to a queue set. Therefore counting semaphores that have a high maximum count value should not be added to a queue set.



Note 4: A receive (in the case of a queue) or take (in the case of a semaphore) operation must not be performed on a member of a queue set unless a call to `xQueueSelectFromSet()` has first returned a handle to that set member.

**参数 uxEventQueueLength** -- Queue sets store events that occur on the queues and semaphores contained in the set. `uxEventQueueLength` specifies the maximum number of events that can be queued at once. To be absolutely certain that events are not lost `uxEventQueueLength` should be set to the total sum of the length of the queues added to the set, where binary semaphores and mutexes have a length of 1, and counting semaphores have a length set by their maximum count value. Examples:

- If a queue set is to hold a queue of length 5, another queue of length 12, and a binary semaphore, then `uxEventQueueLength` should be set to  $(5 + 12 + 1)$ , or 18.
- If a queue set is to hold three binary semaphores then `uxEventQueueLength` should be set to  $(1 + 1 + 1)$ , or 3.
- If a queue set is to hold a counting semaphore that has a maximum count of 5, and a counting semaphore that has a maximum count of 3, then `uxEventQueueLength` should be set to  $(5 + 3)$ , or 8.

**返回** If the queue set is created successfully then a handle to the created queue set is returned. Otherwise NULL is returned.

BaseType\_t **xQueueAddToSet** (*QueueSetMemberHandle\_t* xQueueOrSemaphore, *QueueSetHandle\_t* xQueueSet)

Adds a queue or semaphore to a queue set that was previously created by a call to `xQueueCreateSet()`.

See FreeRTOS/Source/Demo/Common/Minimal/QueueSet.c for an example using this function.

Note 1: A receive (in the case of a queue) or take (in the case of a semaphore) operation must not be performed on a member of a queue set unless a call to `xQueueSelectFromSet()` has first returned a handle to that set member.

**参数**

- **xQueueOrSemaphore** -- The handle of the queue or semaphore being added to the queue set (cast to an *QueueSetMemberHandle\_t* type).
- **xQueueSet** -- The handle of the queue set to which the queue or semaphore is being added.

**返回** If the queue or semaphore was successfully added to the queue set then `pdPASS` is returned. If the queue could not be successfully added to the queue set because it is already a member of a different queue set then `pdFAIL` is returned.

BaseType\_t **xQueueRemoveFromSet** (*QueueSetMemberHandle\_t* xQueueOrSemaphore, *QueueSetHandle\_t* xQueueSet)

Removes a queue or semaphore from a queue set. A queue or semaphore can only be removed from a set if the queue or semaphore is empty.

See FreeRTOS/Source/Demo/Common/Minimal/QueueSet.c for an example using this function.

**参数**

- **xQueueOrSemaphore** -- The handle of the queue or semaphore being removed from the queue set (cast to an *QueueSetMemberHandle\_t* type).
- **xQueueSet** -- The handle of the queue set in which the queue or semaphore is included.

**返回** If the queue or semaphore was successfully removed from the queue set then `pdPASS` is returned. If the queue was not in the queue set, or the queue (or semaphore) was not empty, then `pdFAIL` is returned.

*QueueSetMemberHandle\_t* **xQueueSelectFromSet** (*QueueSetHandle\_t* xQueueSet, const TickType\_t xTicksToWait)

`xQueueSelectFromSet()` selects from the members of a queue set a queue or semaphore that either contains data (in the case of a queue) or is available to take (in the case of a semaphore). `xQueueSelectFromSet()` effectively allows a task to block (pend) on a read operation on all the queues and semaphores in a queue set simultaneously.

See FreeRTOS/Source/Demo/Common/Minimal/QueueSet.c for an example using this function.

Note 1: See the documentation on <https://www.FreeRTOS.org/RTOS-queue-sets.html> for reasons why queue sets are very rarely needed in practice as there are simpler methods of blocking on multiple objects.

Note 2: Blocking on a queue set that contains a mutex will not cause the mutex holder to inherit the priority of the blocked task.

Note 3: A receive (in the case of a queue) or take (in the case of a semaphore) operation must not be performed on a member of a queue set unless a call to `xQueueSelectFromSet()` has first returned a handle to that set member.

#### 参数

- **xQueueSet** -- The queue set on which the task will (potentially) block.
- **xTicksToWait** -- The maximum time, in ticks, that the calling task will remain in the Blocked state (with other tasks executing) to wait for a member of the queue set to be ready for a successful queue read or semaphore take operation.

**返回** `xQueueSelectFromSet()` will return the handle of a queue (cast to a `QueueSetMemberHandle_t` type) contained in the queue set that contains data, or the handle of a semaphore (cast to a `QueueSetMemberHandle_t` type) contained in the queue set that is available, or NULL if no such queue or semaphore exists before before the specified block time expires.

[\*QueueSetMemberHandle\\_t\*](#) **xQueueSelectFromSetFromISR** ([\*QueueSetHandle\\_t\*](#) xQueueSet)

A version of `xQueueSelectFromSet()` that can be used from an ISR.

#### Macros

**xQueueCreate** (uxQueueLength, uxItemSize)

Creates a new queue instance, and returns a handle by which the new queue can be referenced.

Internally, within the FreeRTOS implementation, queues use two blocks of memory. The first block is used to hold the queue's data structures. The second block is used to hold items placed into the queue. If a queue is created using `xQueueCreate()` then both blocks of memory are automatically dynamically allocated inside the `xQueueCreate()` function. (see <https://www.FreeRTOS.org/a00111.html>). If a queue is created using `xQueueCreateStatic()` then the application writer must provide the memory that will get used by the queue. `xQueueCreateStatic()` therefore allows a queue to be created without using any dynamic memory allocation.

<https://www.FreeRTOS.org/Embedded-RTOS-Queues.html>

Example usage:

```

struct AMessage
{
    char ucMessageID;
    char ucData[ 20 ];
};

void vATask( void *pvParameters )
{
    QueueHandle_t xQueue1, xQueue2;

    // Create a queue capable of containing 10 uint32_t values.
    xQueue1 = xQueueCreate( 10, sizeof( uint32_t ) );
    if( xQueue1 == 0 )
    {
        // Queue was not created and must not be used.
    }

    // Create a queue capable of containing 10 pointers to AMessage structures.
    // These should be passed by pointer as they contain a lot of data.
    xQueue2 = xQueueCreate( 10, sizeof( struct AMessage * ) );
    if( xQueue2 == 0 )
    {

```

(下页继续)

```
// Queue was not created and must not be used.
}

// ... Rest of task code.
}
```

**参数**

- **uxQueueLength** -- The maximum number of items that the queue can contain.
- **uxItemSize** -- The number of bytes each item in the queue will require. Items are queued by copy, not by reference, so this is the number of bytes that will be copied for each posted item. Each item on the queue must be the same size.

**返回** If the queue is successfully create then a handle to the newly created queue is returned. If the queue cannot be created then 0 is returned.

**xQueueCreateStatic** (uxQueueLength, uxItemSize, pucQueueStorage, pxQueueBuffer)

Creates a new queue instance, and returns a handle by which the new queue can be referenced.

Internally, within the FreeRTOS implementation, queues use two blocks of memory. The first block is used to hold the queue's data structures. The second block is used to hold items placed into the queue. If a queue is created using xQueueCreate() then both blocks of memory are automatically dynamically allocated inside the xQueueCreate() function. (see <https://www.FreeRTOS.org/a00111.html>). If a queue is created using xQueueCreateStatic() then the application writer must provide the memory that will get used by the queue. xQueueCreateStatic() therefore allows a queue to be created without using any dynamic memory allocation.

<https://www.FreeRTOS.org/Embedded-RTOS-Queues.html>

Example usage:

```
struct AMessage
{
    char ucMessageID;
    char ucData[ 20 ];
};

#define QUEUE_LENGTH 10
#define ITEM_SIZE sizeof( uint32_t )

// xQueueBuffer will hold the queue structure.
StaticQueue_t xQueueBuffer;

// ucQueueStorage will hold the items posted to the queue. Must be at least
// [(queue length) * ( queue item size)] bytes long.
uint8_t ucQueueStorage[ QUEUE_LENGTH * ITEM_SIZE ];

void vATask( void *pvParameters )
{
    QueueHandle_t xQueue1;

    // Create a queue capable of containing 10 uint32_t values.
    xQueue1 = xQueueCreate( QUEUE_LENGTH, // The number of items the queue can
    →hold.
                            ITEM_SIZE // The size of each item in the queue
    →hold the items in the queue.
                            &( ucQueueStorage[ 0 ] ), // The buffer that will
    →queue structure.
                            &xQueueBuffer ); // The buffer that will hold the

    // The queue is guaranteed to be created successfully as no dynamic memory
    // allocation is used. Therefore xQueue1 is now a handle to a valid queue.
```

(下页继续)

```
// ... Rest of task code.
}
```

**参数**

- **uxQueueLength** -- The maximum number of items that the queue can contain.
- **uxItemSize** -- The number of bytes each item in the queue will require. Items are queued by copy, not by reference, so this is the number of bytes that will be copied for each posted item. Each item on the queue must be the same size.
- **pucQueueStorage** -- If uxItemSize is not zero then pucQueueStorage must point to a uint8\_t array that is at least large enough to hold the maximum number of items that can be in the queue at any one time - which is ( uxQueueLength \* uxItemSize ) bytes. If uxItemSize is zero then pucQueueStorage can be NULL.
- **pxQueueBuffer** -- Must point to a variable of type StaticQueue\_t, which will be used to hold the queue's data structure.

**返回** If the queue is created then a handle to the created queue is returned. If pxQueueBuffer is NULL then NULL is returned.

**xQueueGetStaticBuffers** (xQueue, ppucQueueStorage, ppxStaticQueue)

Retrieve pointers to a statically created queue's data structure buffer and storage area buffer. These are the same buffers that are supplied at the time of creation.

**参数**

- **xQueue** -- The queue for which to retrieve the buffers.
- **ppucQueueStorage** -- Used to return a pointer to the queue's storage area buffer.
- **ppxStaticQueue** -- Used to return a pointer to the queue's data structure buffer.

**返回** pdTRUE if buffers were retrieved, pdFALSE otherwise.

**xQueueSendToFront** (xQueue, pvItemToQueue, xTicksToWait)

Post an item to the front of a queue. The item is queued by copy, not by reference. This function must not be called from an interrupt service routine. See xQueueSendFromISR () for an alternative which may be used in an ISR.

Example usage:

```
struct AMessage
{
    char ucMessageID;
    char ucData[ 20 ];
} xMessage;

uint32_t ulVar = 10UL;

void vATask( void *pvParameters )
{
    QueueHandle_t xQueue1, xQueue2;
    struct AMessage *pxMessage;

    // Create a queue capable of containing 10 uint32_t values.
    xQueue1 = xQueueCreate( 10, sizeof( uint32_t ) );

    // Create a queue capable of containing 10 pointers to AMessage structures.
    // These should be passed by pointer as they contain a lot of data.
    xQueue2 = xQueueCreate( 10, sizeof( struct AMessage * ) );

    // ...
```

(下页继续)

```

if( xQueue1 != 0 )
{
// Send an uint32_t. Wait for 10 ticks for space to become
// available if necessary.
if( xQueueSendToFront( xQueue1, ( void * ) &ulVar, ( TickType_t ) 10 ) != pdPASS )
    ↪pdPASS )
    {
// Failed to post the message, even after 10 ticks.
    }
}

if( xQueue2 != 0 )
{
// Send a pointer to a struct AMessage object. Don't block if the
// queue is already full.
    pxMessage = &xMessage;
    xQueueSendToFront( xQueue2, ( void * ) &pxMessage, ( TickType_t ) 0 );
}

// ... Rest of task code.
}

```

**参数**

- **xQueue** -- The handle to the queue on which the item is to be posted.
- **pvItemToQueue** -- A pointer to the item that is to be placed on the queue. The size of the items the queue will hold was defined when the queue was created, so this many bytes will be copied from pvItemToQueue into the queue storage area.
- **xTicksToWait** -- The maximum amount of time the task should block waiting for space to become available on the queue, should it already be full. The call will return immediately if this is set to 0 and the queue is full. The time is defined in tick periods so the constant portTICK\_PERIOD\_MS should be used to convert to real time if this is required.

**返回** pdTRUE if the item was successfully posted, otherwise errQUEUE\_FULL.

**xQueueSendToBack** (xQueue, pvItemToQueue, xTicksToWait)

This is a macro that calls xQueueGenericSend().

Post an item to the back of a queue. The item is queued by copy, not by reference. This function must not be called from an interrupt service routine. See xQueueSendFromISR () for an alternative which may be used in an ISR.

Example usage:

```

struct AMessage
{
    char ucMessageID;
    char ucData[ 20 ];
} xMessage;

uint32_t ulVar = 10UL;

void vATask( void *pvParameters )
{
    QueueHandle_t xQueue1, xQueue2;
    struct AMessage *pxMessage;

    // Create a queue capable of containing 10 uint32_t values.
    xQueue1 = xQueueCreate( 10, sizeof( uint32_t ) );

```

(下页继续)

```

// Create a queue capable of containing 10 pointers to AMessage structures.
// These should be passed by pointer as they contain a lot of data.
xQueue2 = xQueueCreate( 10, sizeof( struct AMessage * ) );

// ...

if( xQueue1 != 0 )
{
// Send an uint32_t. Wait for 10 ticks for space to become
// available if necessary.
if( xQueueSendToBack( xQueue1, ( void * ) &ulVar, ( TickType_t ) 10 ) != pdPASS )
{
// Failed to post the message, even after 10 ticks.
}
}

if( xQueue2 != 0 )
{
// Send a pointer to a struct AMessage object. Don't block if the
// queue is already full.
pxMessage = &xMessage;
xQueueSendToBack( xQueue2, ( void * ) &pxMessage, ( TickType_t ) 0 );
}

// ... Rest of task code.
}

```

**参数**

- **xQueue** -- The handle to the queue on which the item is to be posted.
- **pvItemToQueue** -- A pointer to the item that is to be placed on the queue. The size of the items the queue will hold was defined when the queue was created, so this many bytes will be copied from pvItemToQueue into the queue storage area.
- **xTicksToWait** -- The maximum amount of time the task should block waiting for space to become available on the queue, should it already be full. The call will return immediately if this is set to 0 and the queue is full. The time is defined in tick periods so the constant portTICK\_PERIOD\_MS should be used to convert to real time if this is required.

**返回** pdTRUE if the item was successfully posted, otherwise errQUEUE\_FULL.

**xQueueSend** (xQueue, pvItemToQueue, xTicksToWait)

This is a macro that calls xQueueGenericSend(). It is included for backward compatibility with versions of FreeRTOS.org that did not include the xQueueSendToFront() and xQueueSendToBack() macros. It is equivalent to xQueueSendToBack().

Post an item on a queue. The item is queued by copy, not by reference. This function must not be called from an interrupt service routine. See xQueueSendFromISR () for an alternative which may be used in an ISR.

Example usage:

```

struct AMessage
{
char ucMessageID;
char ucData[ 20 ];
} xMessage;

uint32_t ulVar = 10UL;

```

(下页继续)

```

void vATask( void *pvParameters )
{
QueueHandle_t xQueue1, xQueue2;
struct AMessage *pxMessage;

// Create a queue capable of containing 10 uint32_t values.
xQueue1 = xQueueCreate( 10, sizeof( uint32_t ) );

// Create a queue capable of containing 10 pointers to AMessage structures.
// These should be passed by pointer as they contain a lot of data.
xQueue2 = xQueueCreate( 10, sizeof( struct AMessage * ) );

// ...

if( xQueue1 != 0 )
{
// Send an uint32_t. Wait for 10 ticks for space to become
// available if necessary.
if( xQueueSend( xQueue1, ( void * ) &ulVar, ( TickType_t ) 10 ) != pdPASS )
{
// Failed to post the message, even after 10 ticks.
}
}

if( xQueue2 != 0 )
{
// Send a pointer to a struct AMessage object. Don't block if the
// queue is already full.
pxMessage = & xMessage;
xQueueSend( xQueue2, ( void * ) &pxMessage, ( TickType_t ) 0 );
}

// ... Rest of task code.
}

```

**参数**

- **xQueue** -- The handle to the queue on which the item is to be posted.
- **pvItemToQueue** -- A pointer to the item that is to be placed on the queue. The size of the items the queue will hold was defined when the queue was created, so this many bytes will be copied from pvItemToQueue into the queue storage area.
- **xTicksToWait** -- The maximum amount of time the task should block waiting for space to become available on the queue, should it already be full. The call will return immediately if this is set to 0 and the queue is full. The time is defined in tick periods so the constant portTICK\_PERIOD\_MS should be used to convert to real time if this is required.

**返回** pdTRUE if the item was successfully posted, otherwise errQUEUE\_FULL.

**xQueueOverwrite** (xQueue, pvItemToQueue)

Only for use with queues that have a length of one - so the queue is either empty or full.

Post an item on a queue. If the queue is already full then overwrite the value held in the queue. The item is queued by copy, not by reference.

This function must not be called from an interrupt service routine. See xQueueOverwriteFromISR () for an alternative which may be used in an ISR.

Example usage:

```

void vFunction( void *pvParameters )
{
QueueHandle_t xQueue;
uint32_t ulVarToSend, ulValReceived;

// Create a queue to hold one uint32_t value. It is strongly
// recommended *not* to use xQueueOverwrite() on queues that can
// contain more than one value, and doing so will trigger an assertion
// if configASSERT() is defined.
xQueue = xQueueCreate( 1, sizeof( uint32_t ) );

// Write the value 10 to the queue using xQueueOverwrite().
ulVarToSend = 10;
xQueueOverwrite( xQueue, &ulVarToSend );

// Peeking the queue should now return 10, but leave the value 10 in
// the queue. A block time of zero is used as it is known that the
// queue holds a value.
ulValReceived = 0;
xQueuePeek( xQueue, &ulValReceived, 0 );

if( ulValReceived != 10 )
{
// Error unless the item was removed by a different task.
}

// The queue is still full. Use xQueueOverwrite() to overwrite the
// value held in the queue with 100.
ulVarToSend = 100;
xQueueOverwrite( xQueue, &ulVarToSend );

// This time read from the queue, leaving the queue empty once more.
// A block time of 0 is used again.
xQueueReceive( xQueue, &ulValReceived, 0 );

// The value read should be the last value written, even though the
// queue was already full when the value was written.
if( ulValReceived != 100 )
{
// Error!
}

// ...
}

```

**参数**

- **xQueue** -- The handle of the queue to which the data is being sent.
- **pvItemToQueue** -- A pointer to the item that is to be placed on the queue. The size of the items the queue will hold was defined when the queue was created, so this many bytes will be copied from pvItemToQueue into the queue storage area.

**返回** `xQueueOverwrite()` is a macro that calls `xQueueGenericSend()`, and therefore has the same return values as `xQueueSendToFront()`. However, `pdPASS` is the only value that can be returned because `xQueueOverwrite()` will write to the queue even when the queue is already full.

**xQueueSendToFrontFromISR** (xQueue, pvItemToQueue, pxHigherPriorityTaskWoken)

This is a macro that calls `xQueueGenericSendFromISR()`.

Post an item to the front of a queue. It is safe to use this macro from within an interrupt service routine.

Items are queued by copy not reference so it is preferable to only queue small items, especially when called



from an ISR. In most cases it would be preferable to store a pointer to the item being queued.

Example usage for buffered IO (where the ISR can obtain more than one value per call):

```
void vBufferISR( void )
{
    char cIn;
    BaseType_t xHigherPriorityTaskWoken;

    // We have not woken a task at the start of the ISR.
    xHigherPriorityTaskWoken = pdFALSE;

    // Loop until the buffer is empty.
    do
    {
        // Obtain a byte from the buffer.
        cIn = portINPUT_BYTE( RX_REGISTER_ADDRESS );

        // Post the byte.
        xQueueSendToFrontFromISR( xRxQueue, &cIn, &xHigherPriorityTaskWoken );

    } while( portINPUT_BYTE( BUFFER_COUNT ) );

    // Now the buffer is empty we can switch context if necessary.
    if( xHigherPriorityTaskWoken )
    {
        taskYIELD ();
    }
}
```

#### 参数

- **xQueue** -- The handle to the queue on which the item is to be posted.
- **pvItemToQueue** -- A pointer to the item that is to be placed on the queue. The size of the items the queue will hold was defined when the queue was created, so this many bytes will be copied from pvItemToQueue into the queue storage area.
- **pxHigherPriorityTaskWoken** -- xQueueSendToFrontFromISR() will set \*pxHigherPriorityTaskWoken to pdTRUE if sending to the queue caused a task to unblock, and the unblocked task has a priority higher than the currently running task. If xQueueSendToFromFromISR() sets this value to pdTRUE then a context switch should be requested before the interrupt is exited.

**返回** pdTRUE if the data was successfully sent to the queue, otherwise errQUEUE\_FULL.

**xQueueSendToBackFromISR** (xQueue, pvItemToQueue, pxHigherPriorityTaskWoken)

This is a macro that calls xQueueGenericSendFromISR().

Post an item to the back of a queue. It is safe to use this macro from within an interrupt service routine.

Items are queued by copy not reference so it is preferable to only queue small items, especially when called from an ISR. In most cases it would be preferable to store a pointer to the item being queued.

Example usage for buffered IO (where the ISR can obtain more than one value per call):

```
void vBufferISR( void )
{
    char cIn;
    BaseType_t xHigherPriorityTaskWoken;

    // We have not woken a task at the start of the ISR.
    xHigherPriorityTaskWoken = pdFALSE;
```

(下页继续)

```

// Loop until the buffer is empty.
do
{
// Obtain a byte from the buffer.
    cIn = portINPUT_BYTE( RX_REGISTER_ADDRESS );

// Post the byte.
    xQueueSendToBackFromISR( xRxQueue, &cIn, &xHigherPriorityTaskWoken );

} while( portINPUT_BYTE( BUFFER_COUNT ) );

// Now the buffer is empty we can switch context if necessary.
if( xHigherPriorityTaskWoken )
{
    taskYIELD ();
}
}

```

**参数**

- **xQueue** -- The handle to the queue on which the item is to be posted.
- **pvItemToQueue** -- A pointer to the item that is to be placed on the queue. The size of the items the queue will hold was defined when the queue was created, so this many bytes will be copied from pvItemToQueue into the queue storage area.
- **pxHigherPriorityTaskWoken** -- xQueueSendToBackFromISR() will set \*pxHigherPriorityTaskWoken to pdTRUE if sending to the queue caused a task to unblock, and the unblocked task has a priority higher than the currently running task. If xQueueSendToBackFromISR() sets this value to pdTRUE then a context switch should be requested before the interrupt is exited.

**返回** pdTRUE if the data was successfully sent to the queue, otherwise errQUEUE\_FULL.

**xQueueOverwriteFromISR** (xQueue, pvItemToQueue, pxHigherPriorityTaskWoken)

A version of xQueueOverwrite() that can be used in an interrupt service routine (ISR).

Only for use with queues that can hold a single item - so the queue is either empty or full.

Post an item on a queue. If the queue is already full then overwrite the value held in the queue. The item is queued by copy, not by reference.

Example usage:

```

QueueHandle_t xQueue;

void vFunction( void *pvParameters )
{
// Create a queue to hold one uint32_t value. It is strongly
// recommended *not* to use xQueueOverwriteFromISR() on queues that can
// contain more than one value, and doing so will trigger an assertion
// if configASSERT() is defined.
xQueue = xQueueCreate( 1, sizeof( uint32_t ) );
}

void vAnInterruptHandler( void )
{
// xHigherPriorityTaskWoken must be set to pdFALSE before it is used.
BaseType_t xHigherPriorityTaskWoken = pdFALSE;
uint32_t ulVarToSend, ulValReceived;

```

(下页继续)

(续上页)

```

// Write the value 10 to the queue using xQueueOverwriteFromISR().
ulVarToSend = 10;
xQueueOverwriteFromISR( xQueue, &ulVarToSend, &xHigherPriorityTaskWoken );

// The queue is full, but calling xQueueOverwriteFromISR() again will still
// pass because the value held in the queue will be overwritten with the
// new value.
ulVarToSend = 100;
xQueueOverwriteFromISR( xQueue, &ulVarToSend, &xHigherPriorityTaskWoken );

// Reading from the queue will now return 100.

// ...

if( xHigherPriorityTaskWoken == pdTRUE )
{
// Writing to the queue caused a task to unblock and the unblocked task
// has a priority higher than or equal to the priority of the currently
// executing task (the task this interrupt interrupted). Perform a context
// switch so this interrupt returns directly to the unblocked task.
portYIELD_FROM_ISR(); // or portEND_SWITCHING_ISR() depending on the port.
}
}

```

**参数**

- **xQueue** -- The handle to the queue on which the item is to be posted.
- **pvItemToQueue** -- A pointer to the item that is to be placed on the queue. The size of the items the queue will hold was defined when the queue was created, so this many bytes will be copied from pvItemToQueue into the queue storage area.
- **pxHigherPriorityTaskWoken** -- xQueueOverwriteFromISR() will set \*pxHigherPriorityTaskWoken to pdTRUE if sending to the queue caused a task to unblock, and the unblocked task has a priority higher than the currently running task. If xQueueOverwriteFromISR() sets this value to pdTRUE then a context switch should be requested before the interrupt is exited.

**返回** xQueueOverwriteFromISR() is a macro that calls xQueueGenericSendFromISR(), and therefore has the same return values as xQueueSendToFrontFromISR(). However, pdPASS is the only value that can be returned because xQueueOverwriteFromISR() will write to the queue even when the queue is already full.

**xQueueSendFromISR** (xQueue, pvItemToQueue, pxHigherPriorityTaskWoken)

This is a macro that calls xQueueGenericSendFromISR(). It is included for backward compatibility with versions of FreeRTOS.org that did not include the xQueueSendToBackFromISR() and xQueueSendToFrontFromISR() macros.

Post an item to the back of a queue. It is safe to use this function from within an interrupt service routine.

Items are queued by copy not reference so it is preferable to only queue small items, especially when called from an ISR. In most cases it would be preferable to store a pointer to the item being queued.

Example usage for buffered IO (where the ISR can obtain more than one value per call):

```

void vBufferISR( void )
{
char cIn;
 BaseType_t xHigherPriorityTaskWoken;

// We have not woken a task at the start of the ISR.
xHigherPriorityTaskWoken = pdFALSE;

```

(下页继续)

```

// Loop until the buffer is empty.
do
{
// Obtain a byte from the buffer.
    cIn = portINPUT_BYTE( RX_REGISTER_ADDRESS );

// Post the byte.
    xQueueSendFromISR( xRxQueue, &cIn, &xHigherPriorityTaskWoken );

} while( portINPUT_BYTE( BUFFER_COUNT ) );

// Now the buffer is empty we can switch context if necessary.
if( xHigherPriorityTaskWoken )
{
// Actual macro used here is port specific.
    portYIELD_FROM_ISR ();
}
}

```

**参数**

- **xQueue** -- The handle to the queue on which the item is to be posted.
- **pvItemToQueue** -- A pointer to the item that is to be placed on the queue. The size of the items the queue will hold was defined when the queue was created, so this many bytes will be copied from pvItemToQueue into the queue storage area.
- **pxHigherPriorityTaskWoken** -- xQueueSendFromISR() will set \*pxHigherPriorityTaskWoken to pdTRUE if sending to the queue caused a task to unblock, and the unblocked task has a priority higher than the currently running task. If xQueueSendFromISR() sets this value to pdTRUE then a context switch should be requested before the interrupt is exited.

**返回** pdTRUE if the data was successfully sent to the queue, otherwise errQUEUE\_FULL.

**xQueueReset** (xQueue)

Reset a queue back to its original empty state. The return value is now obsolete and is always set to pdPASS.

**Type Definitions**

```
typedef struct QueueDefinition *QueueHandle_t
```

```
typedef struct QueueDefinition *QueueSetHandle_t
```

Type by which queue sets are referenced. For example, a call to xQueueCreateSet() returns an xQueueSet variable that can then be used as a parameter to xQueueSelectFromSet(), xQueueAddToSet(), etc.

```
typedef struct QueueDefinition *QueueSetMemberHandle_t
```

Queue sets can contain both queues and semaphores, so the QueueSetMemberHandle\_t is defined as a type to be used where a parameter or return value can be either an QueueHandle\_t or an SemaphoreHandle\_t.

**信号量 API****Header File**

- [components/freertos/FreeRTOS-Kernel/include/freertos/semphr.h](#)
- This header file can be included with:

```
#include "freertos/semphr.h"
```

**Macros****semBINARY\_SEMAPHORE\_QUEUE\_LENGTH****semSEMAPHORE\_QUEUE\_ITEM\_LENGTH****semGIVE\_BLOCK\_TIME****vSemaphoreCreateBinary** (xSemaphore)

In many usage scenarios it is faster and more memory efficient to use a direct to task notification in place of a binary semaphore! <https://www.FreeRTOS.org/RTOS-task-notifications.html>

This old vSemaphoreCreateBinary() macro is now deprecated in favour of the xSemaphoreCreateBinary() function. Note that binary semaphores created using the vSemaphoreCreateBinary() macro are created in a state such that the first call to 'take' the semaphore would pass, whereas binary semaphores created using xSemaphoreCreateBinary() are created in a state such that the the semaphore must first be 'given' before it can be 'taken'.

*Macro* that implements a semaphore by using the existing queue mechanism. The queue length is 1 as this is a binary semaphore. The data size is 0 as we don't want to actually store any data - we just want to know if the queue is empty or full.

This type of semaphore can be used for pure synchronisation between tasks or between an interrupt and a task. The semaphore need not be given back once obtained, so one task/interrupt can continuously 'give' the semaphore while another continuously 'takes' the semaphore. For this reason this type of semaphore does not use a priority inheritance mechanism. For an alternative that does use priority inheritance see xSemaphoreCreateMutex().

Example usage:

```
SemaphoreHandle_t xSemaphore = NULL;

void vATask( void * pvParameters )
{
    // Semaphore cannot be used before a call to vSemaphoreCreateBinary ().
    // This is a macro so pass the variable in directly.
    vSemaphoreCreateBinary( xSemaphore );

    if( xSemaphore != NULL )
    {
        // The semaphore was created successfully.
        // The semaphore can now be used.
    }
}
```

**参数**

- **xSemaphore** -- Handle to the created semaphore. Should be of type SemaphoreHandle\_t.

**xSemaphoreCreateBinary** ()

Creates a new binary semaphore instance, and returns a handle by which the new semaphore can be referenced.

In many usage scenarios it is faster and more memory efficient to use a direct to task notification in place of a binary semaphore! <https://www.FreeRTOS.org/RTOS-task-notifications.html>

Internally, within the FreeRTOS implementation, binary semaphores use a block of memory, in which the semaphore structure is stored. If a binary semaphore is created using xSemaphoreCreateBinary() then the required memory is automatically dynamically allocated inside the xSemaphoreCreateBinary() function. (see

<https://www.FreeRTOS.org/a00111.html>). If a binary semaphore is created using `xSemaphoreCreateBinaryStatic()` then the application writer must provide the memory. `xSemaphoreCreateBinaryStatic()` therefore allows a binary semaphore to be created without using any dynamic memory allocation.

The old `vSemaphoreCreateBinary()` macro is now deprecated in favour of this `xSemaphoreCreateBinary()` function. Note that binary semaphores created using the `vSemaphoreCreateBinary()` macro are created in a state such that the first call to 'take' the semaphore would pass, whereas binary semaphores created using `xSemaphoreCreateBinary()` are created in a state such that the the semaphore must first be 'given' before it can be 'taken'.

This type of semaphore can be used for pure synchronisation between tasks or between an interrupt and a task. The semaphore need not be given back once obtained, so one task/interrupt can continuously 'give' the semaphore while another continuously 'takes' the semaphore. For this reason this type of semaphore does not use a priority inheritance mechanism. For an alternative that does use priority inheritance see `xSemaphoreCreateMutex()`.

Example usage:

```
SemaphoreHandle_t xSemaphore = NULL;

void vATask( void * pvParameters )
{
    // Semaphore cannot be used before a call to xSemaphoreCreateBinary().
    // This is a macro so pass the variable in directly.
    xSemaphore = xSemaphoreCreateBinary();

    if( xSemaphore != NULL )
    {
        // The semaphore was created successfully.
        // The semaphore can now be used.
    }
}
```

**返回** Handle to the created semaphore, or NULL if the memory required to hold the semaphore's data structures could not be allocated.

#### **xSemaphoreCreateBinaryStatic** (pxStaticSemaphore)

Creates a new binary semaphore instance, and returns a handle by which the new semaphore can be referenced.

NOTE: In many usage scenarios it is faster and more memory efficient to use a direct to task notification in place of a binary semaphore! <https://www.FreeRTOS.org/RTOS-task-notifications.html>

Internally, within the FreeRTOS implementation, binary semaphores use a block of memory, in which the semaphore structure is stored. If a binary semaphore is created using `xSemaphoreCreateBinary()` then the required memory is automatically dynamically allocated inside the `xSemaphoreCreateBinary()` function. (see <https://www.FreeRTOS.org/a00111.html>). If a binary semaphore is created using `xSemaphoreCreateBinaryStatic()` then the application writer must provide the memory. `xSemaphoreCreateBinaryStatic()` therefore allows a binary semaphore to be created without using any dynamic memory allocation.

This type of semaphore can be used for pure synchronisation between tasks or between an interrupt and a task. The semaphore need not be given back once obtained, so one task/interrupt can continuously 'give' the semaphore while another continuously 'takes' the semaphore. For this reason this type of semaphore does not use a priority inheritance mechanism. For an alternative that does use priority inheritance see `xSemaphoreCreateMutex()`.

Example usage:

```
SemaphoreHandle_t xSemaphore = NULL;
StaticSemaphore_t xSemaphoreBuffer;
```

(下页继续)

```

void vATask( void * pvParameters )
{
    // Semaphore cannot be used before a call to xSemaphoreCreateBinary().
    // The semaphore's data structures will be placed in the xSemaphoreBuffer
    // variable, the address of which is passed into the function. The
    // function's parameter is not NULL, so the function will not attempt any
    // dynamic memory allocation, and therefore the function will not return
    // return NULL.
    xSemaphore = xSemaphoreCreateBinary( &xSemaphoreBuffer );

    // Rest of task code goes here.
}

```

**参数**

- **pxStaticSemaphore** -- Must point to a variable of type StaticSemaphore\_t, which will then be used to hold the semaphore's data structure, removing the need for the memory to be allocated dynamically.

**返回** If the semaphore is created then a handle to the created semaphore is returned. If pxSemaphoreBuffer is NULL then NULL is returned.

**xSemaphoreTake** (xSemaphore, xBlockTime)

Macro to obtain a semaphore. The semaphore must have previously been created with a call to xSemaphoreCreateBinary(), xSemaphoreCreateMutex() or xSemaphoreCreateCounting().

Example usage:

```

SemaphoreHandle_t xSemaphore = NULL;

// A task that creates a semaphore.
void vATask( void * pvParameters )
{
    // Create the semaphore to guard a shared resource.
    xSemaphore = xSemaphoreCreateBinary();
}

// A task that uses the semaphore.
void vAnotherTask( void * pvParameters )
{
    // ... Do other things.

    if( xSemaphore != NULL )
    {
        // See if we can obtain the semaphore. If the semaphore is not available
        // wait 10 ticks to see if it becomes free.
        if( xSemaphoreTake( xSemaphore, ( TickType_t ) 10 ) == pdTRUE )
        {
            // We were able to obtain the semaphore and can now access the
            // shared resource.

            // ...

            // We have finished accessing the shared resource. Release the
            // semaphore.
            xSemaphoreGive( xSemaphore );
        }
    }
    else
    {

```

(下页继续)

```
// We could not obtain the semaphore and can therefore not access
// the shared resource safely.
    }
}
}
```

**参数**

- **xSemaphore** -- A handle to the semaphore being taken - obtained when the semaphore was created.
- **xBlockTime** -- The time in ticks to wait for the semaphore to become available. The macro portTICK\_PERIOD\_MS can be used to convert this to a real time. A block time of zero can be used to poll the semaphore. A block time of portMAX\_DELAY can be used to block indefinitely (provided INCLUDE\_vTaskSuspend is set to 1 in FreeRTOSConfig.h).

**返回** pdTRUE if the semaphore was obtained. pdFALSE if xBlockTime expired without the semaphore becoming available.

**xSemaphoreTakeRecursive** (xMutex, xBlockTime)

Macro to recursively obtain, or 'take', a mutex type semaphore. The mutex must have previously been created using a call to xSemaphoreCreateRecursiveMutex();

configUSE\_RECURSIVE\_MUTEXES must be set to 1 in FreeRTOSConfig.h for this macro to be available.

This macro must not be used on mutexes created using xSemaphoreCreateMutex().

A mutex used recursively can be 'taken' repeatedly by the owner. The mutex doesn't become available again until the owner has called xSemaphoreGiveRecursive() for each successful 'take' request. For example, if a task successfully 'takes' the same mutex 5 times then the mutex will not be available to any other task until it has also 'given' the mutex back exactly five times.

## Example usage:

```
SemaphoreHandle_t xMutex = NULL;

// A task that creates a mutex.
void vATask( void * pvParameters )
{
    // Create the mutex to guard a shared resource.
    xMutex = xSemaphoreCreateRecursiveMutex();
}

// A task that uses the mutex.
void vAnotherTask( void * pvParameters )
{
    // ... Do other things.

    if( xMutex != NULL )
    {
        // See if we can obtain the mutex. If the mutex is not available
        // wait 10 ticks to see if it becomes free.
        if( xSemaphoreTakeRecursive( xSemaphore, ( TickType_t ) 10 ) == pdTRUE )
        {
            // We were able to obtain the mutex and can now access the
            // shared resource.

            // ...

            // For some reason due to the nature of the code further calls to
            // xSemaphoreTakeRecursive() are made on the same mutex. In real
            // code these would not be just sequential calls as this would make
            // no sense. Instead the calls are likely to be buried inside
```

(下页继续)



```

// a more complex call structure.
    xSemaphoreTakeRecursive( xMutex, ( TickType_t ) 10 );
    xSemaphoreTakeRecursive( xMutex, ( TickType_t ) 10 );

// The mutex has now been 'taken' three times, so will not be
// available to another task until it has also been given back
// three times. Again it is unlikely that real code would have
// these calls sequentially, but instead buried in a more complex
// call structure. This is just for illustrative purposes.
    xSemaphoreGiveRecursive( xMutex );
    xSemaphoreGiveRecursive( xMutex );
    xSemaphoreGiveRecursive( xMutex );

// Now the mutex can be taken by other tasks.
}
else
{
// We could not obtain the mutex and can therefore not access
// the shared resource safely.
}
}
}

```

**参数**

- **xMutex** -- A handle to the mutex being obtained. This is the handle returned by `xSemaphoreCreateRecursiveMutex()`;
- **xBlockTime** -- The time in ticks to wait for the semaphore to become available. The macro `portTICK_PERIOD_MS` can be used to convert this to a real time. A block time of zero can be used to poll the semaphore. If the task already owns the semaphore then `xSemaphoreTakeRecursive()` will return immediately no matter what the value of `xBlockTime`.

**返回** `pdTRUE` if the semaphore was obtained. `pdFALSE` if `xBlockTime` expired without the semaphore becoming available.

**xSemaphoreGive** (xSemaphore)

*Macro* to release a semaphore. The semaphore must have previously been created with a call to `xSemaphoreCreateBinary()`, `xSemaphoreCreateMutex()` or `xSemaphoreCreateCounting()`, and obtained using `xSemaphoreTake()`.

This macro must not be used from an ISR. See `xSemaphoreGiveFromISR()` for an alternative which can be used from an ISR.

This macro must also not be used on semaphores created using `xSemaphoreCreateRecursiveMutex()`.

Example usage:

```

SemaphoreHandle_t xSemaphore = NULL;

void vATask( void * pvParameters )
{
// Create the semaphore to guard a shared resource.
xSemaphore = vSemaphoreCreateBinary();

if( xSemaphore != NULL )
{
if( xSemaphoreGive( xSemaphore ) != pdTRUE )
{
// We would expect this call to fail because we cannot give

```

(下页继续)

```

// a semaphore without first "taking" it!
}

// Obtain the semaphore - don't block if the semaphore is not
// immediately available.
if( xSemaphoreTake( xSemaphore, ( TickType_t ) 0 ) )
{
// We now have the semaphore and can access the shared resource.

// ...

// We have finished accessing the shared resource so can free the
// semaphore.
if( xSemaphoreGive( xSemaphore ) != pdTRUE )
{
// We would not expect this call to fail because we must have
// obtained the semaphore to get here.
}
}
}
}

```

**参数**

- **xSemaphore** -- A handle to the semaphore being released. This is the handle returned when the semaphore was created.

**返回** pdTRUE if the semaphore was released. pdFALSE if an error occurred. Semaphores are implemented using queues. An error can occur if there is no space on the queue to post a message - indicating that the semaphore was not first obtained correctly.

**xSemaphoreGiveRecursive** (xMutex)

Macro to recursively release, or 'give', a mutex type semaphore. The mutex must have previously been created using a call to xSemaphoreCreateRecursiveMutex();

configUSE\_RECURSIVE\_MUTEXES must be set to 1 in FreeRTOSConfig.h for this macro to be available.

This macro must not be used on mutexes created using xSemaphoreCreateMutex().

A mutex used recursively can be 'taken' repeatedly by the owner. The mutex doesn't become available again until the owner has called xSemaphoreGiveRecursive() for each successful 'take' request. For example, if a task successfully 'takes' the same mutex 5 times then the mutex will not be available to any other task until it has also 'given' the mutex back exactly five times.

Example usage:

```

SemaphoreHandle_t xMutex = NULL;

// A task that creates a mutex.
void vATask( void * pvParameters )
{
// Create the mutex to guard a shared resource.
xMutex = xSemaphoreCreateRecursiveMutex();
}

// A task that uses the mutex.
void vAnotherTask( void * pvParameters )
{
// ... Do other things.

if( xMutex != NULL )

```

(下页继续)

```

{
// See if we can obtain the mutex.  If the mutex is not available
// wait 10 ticks to see if it becomes free.
if( xSemaphoreTakeRecursive( xMutex, ( TickType_t ) 10 ) == pdTRUE )
    {
// We were able to obtain the mutex and can now access the
// shared resource.

// ...
// For some reason due to the nature of the code further calls to
// xSemaphoreTakeRecursive() are made on the same mutex.  In real
// code these would not be just sequential calls as this would make
// no sense.  Instead the calls are likely to be buried inside
// a more complex call structure.
        xSemaphoreTakeRecursive( xMutex, ( TickType_t ) 10 );
        xSemaphoreTakeRecursive( xMutex, ( TickType_t ) 10 );

// The mutex has now been 'taken' three times, so will not be
// available to another task until it has also been given back
// three times.  Again it is unlikely that real code would have
// these calls sequentially, it would be more likely that the calls
// to xSemaphoreGiveRecursive() would be called as a call stack
// unwound.  This is just for demonstrative purposes.
        xSemaphoreGiveRecursive( xMutex );
        xSemaphoreGiveRecursive( xMutex );
        xSemaphoreGiveRecursive( xMutex );

// Now the mutex can be taken by other tasks.
    }
else
    {
// We could not obtain the mutex and can therefore not access
// the shared resource safely.
    }
}
}

```

**参数**

- **xMutex** -- A handle to the mutex being released, or 'given'. This is the handle returned by xSemaphoreCreateMutex();

**返回** pdTRUE if the semaphore was given.

**xSemaphoreGiveFromISR** (xSemaphore, pxHigherPriorityTaskWoken)

Macro to release a semaphore. The semaphore must have previously been created with a call to xSemaphoreCreateBinary() or xSemaphoreCreateCounting().

Mutex type semaphores (those created using a call to xSemaphoreCreateMutex()) must not be used with this macro.

This macro can be used from an ISR.

Example usage:

```

#define LONG_TIME 0xffff
#define TICKS_TO_WAIT 10
SemaphoreHandle_t xSemaphore = NULL;

// Repetitive task.
void vATask( void * pvParameters )

```

(下页继续)

```

{
  for( ;; )
  {
    // We want this task to run every 10 ticks of a timer. The semaphore
    // was created before this task was started.

    // Block waiting for the semaphore to become available.
    if( xSemaphoreTake( xSemaphore, LONG_TIME ) == pdTRUE )
    {
      // It is time to execute.

      // ...

      // We have finished our task. Return to the top of the loop where
      // we will block on the semaphore until it is time to execute
      // again. Note when using the semaphore for synchronisation with an
      // ISR in this manner there is no need to 'give' the semaphore back.
    }
  }
}

// Timer ISR
void vTimerISR( void * pvParameters )
{
  static uint8_t ucLocalTickCount = 0;
  static BaseType_t xHigherPriorityTaskWoken;

  // A timer tick has occurred.

  // ... Do other time functions.

  // Is it time for vATask () to run?
  xHigherPriorityTaskWoken = pdFALSE;
  ucLocalTickCount++;
  if( ucLocalTickCount >= TICKS_TO_WAIT )
  {
    // Unblock the task by releasing the semaphore.
    xSemaphoreGiveFromISR( xSemaphore, &xHigherPriorityTaskWoken );

    // Reset the count so we release the semaphore again in 10 ticks time.
    ucLocalTickCount = 0;
  }

  if( xHigherPriorityTaskWoken != pdFALSE )
  {
    // We can force a context switch here. Context switching from an
    // ISR uses port specific syntax. Check the demo task for your port
    // to find the syntax required.
  }
}

```

**参数**

- **xSemaphore** -- A handle to the semaphore being released. This is the handle returned when the semaphore was created.
- **pxHigherPriorityTaskWoken** -- xSemaphoreGiveFromISR() will set \*pxHigherPriorityTaskWoken to pdTRUE if giving the semaphore caused a task to unblock, and the unblocked task has a priority higher than the currently running task. If xSemaphoreGiveFromISR() sets this value to pdTRUE then a context switch should be requested before the interrupt is exited.

**返回** pdTRUE if the semaphore was successfully given, otherwise errQUEUE\_FULL.

**xSemaphoreTakeFromISR** (xSemaphore, pxHigherPriorityTaskWoken)

Macro to take a semaphore from an ISR. The semaphore must have previously been created with a call to xSemaphoreCreateBinary() or xSemaphoreCreateCounting().

Mutex type semaphores (those created using a call to xSemaphoreCreateMutex()) must not be used with this macro.

This macro can be used from an ISR, however taking a semaphore from an ISR is not a common operation. It is likely to only be useful when taking a counting semaphore when an interrupt is obtaining an object from a resource pool (when the semaphore count indicates the number of resources available).

**参数**

- **xSemaphore** -- A handle to the semaphore being taken. This is the handle returned when the semaphore was created.
- **pxHigherPriorityTaskWoken** -- xSemaphoreTakeFromISR() will set \*pxHigherPriorityTaskWoken to pdTRUE if taking the semaphore caused a task to unblock, and the unblocked task has a priority higher than the currently running task. If xSemaphoreTakeFromISR() sets this value to pdTRUE then a context switch should be requested before the interrupt is exited.

**返回** pdTRUE if the semaphore was successfully taken, otherwise pdFALSE

**xSemaphoreCreateMutex** ()

Creates a new mutex type semaphore instance, and returns a handle by which the new mutex can be referenced.

Internally, within the FreeRTOS implementation, mutex semaphores use a block of memory, in which the mutex structure is stored. If a mutex is created using xSemaphoreCreateMutex() then the required memory is automatically dynamically allocated inside the xSemaphoreCreateMutex() function. (see <https://www.FreeRTOS.org/a00111.html>). If a mutex is created using xSemaphoreCreateMutexStatic() then the application writer must provide the memory. xSemaphoreCreateMutexStatic() therefore allows a mutex to be created without using any dynamic memory allocation.

Mutexes created using this function can be accessed using the xSemaphoreTake() and xSemaphoreGive() macros. The xSemaphoreTakeRecursive() and xSemaphoreGiveRecursive() macros must not be used.

This type of semaphore uses a priority inheritance mechanism so a task 'taking' a semaphore MUST ALWAYS 'give' the semaphore back once the semaphore it is no longer required.

Mutex type semaphores cannot be used from within interrupt service routines.

See xSemaphoreCreateBinary() for an alternative implementation that can be used for pure synchronisation (where one task or interrupt always 'gives' the semaphore and another always 'takes' the semaphore) and from within interrupt service routines.

Example usage:

```
SemaphoreHandle_t xSemaphore;

void vATask( void * pvParameters )
{
    // Semaphore cannot be used before a call to xSemaphoreCreateMutex().
    // This is a macro so pass the variable in directly.
    xSemaphore = xSemaphoreCreateMutex();

    if( xSemaphore != NULL )
    {
        // The semaphore was created successfully.
        // The semaphore can now be used.
    }
}
```

**返回** If the mutex was successfully created then a handle to the created semaphore is returned. If there was not enough heap to allocate the mutex data structures then NULL is returned.

**xSemaphoreCreateMutexStatic** (pxMutexBuffer)

Creates a new mutex type semaphore instance, and returns a handle by which the new mutex can be referenced.

Internally, within the FreeRTOS implementation, mutex semaphores use a block of memory, in which the mutex structure is stored. If a mutex is created using `xSemaphoreCreateMutex()` then the required memory is automatically dynamically allocated inside the `xSemaphoreCreateMutex()` function. (see <https://www.FreeRTOS.org/a00111.html>). If a mutex is created using `xSemaphoreCreateMutexStatic()` then the application writer must provide the memory. `xSemaphoreCreateMutexStatic()` therefore allows a mutex to be created without using any dynamic memory allocation.

Mutexes created using this function can be accessed using the `xSemaphoreTake()` and `xSemaphoreGive()` macros. The `xSemaphoreTakeRecursive()` and `xSemaphoreGiveRecursive()` macros must not be used.

This type of semaphore uses a priority inheritance mechanism so a task 'taking' a semaphore MUST ALWAYS 'give' the semaphore back once the semaphore it is no longer required.

Mutex type semaphores cannot be used from within interrupt service routines.

See `xSemaphoreCreateBinary()` for an alternative implementation that can be used for pure synchronisation (where one task or interrupt always 'gives' the semaphore and another always 'takes' the semaphore) and from within interrupt service routines.

Example usage:

```
SemaphoreHandle_t xSemaphore;
StaticSemaphore_t xMutexBuffer;

void vATask( void * pvParameters )
{
    // A mutex cannot be used before it has been created. xMutexBuffer is
    // into xSemaphoreCreateMutexStatic() so no dynamic memory allocation is
    // attempted.
    xSemaphore = xSemaphoreCreateMutexStatic( &xMutexBuffer );

    // As no dynamic memory allocation was performed, xSemaphore cannot be NULL,
    // so there is no need to check it.
}
```

**参数**

- **pxMutexBuffer** -- Must point to a variable of type `StaticSemaphore_t`, which will be used to hold the mutex's data structure, removing the need for the memory to be allocated dynamically.

**返回** If the mutex was successfully created then a handle to the created mutex is returned. If `pxMutexBuffer` was `NULL` then `NULL` is returned.

**xSemaphoreCreateRecursiveMutex** ()

Creates a new recursive mutex type semaphore instance, and returns a handle by which the new recursive mutex can be referenced.

Internally, within the FreeRTOS implementation, recursive mutexes use a block of memory, in which the mutex structure is stored. If a recursive mutex is created using `xSemaphoreCreateRecursiveMutex()` then the required memory is automatically dynamically allocated inside the `xSemaphoreCreateRecursiveMutex()` function. (see <https://www.FreeRTOS.org/a00111.html>). If a recursive mutex is created using `xSemaphoreCreateRecursiveMutexStatic()` then the application writer must provide the memory that will get used by the mutex. `xSemaphoreCreateRecursiveMutexStatic()` therefore allows a recursive mutex to be created without using any dynamic memory allocation.

Mutexes created using this macro can be accessed using the `xSemaphoreTakeRecursive()` and `xSemaphoreGiveRecursive()` macros. The `xSemaphoreTake()` and `xSemaphoreGive()` macros must not be used.

A mutex used recursively can be 'taken' repeatedly by the owner. The mutex doesn't become available again until the owner has called `xSemaphoreGiveRecursive()` for each successful 'take' request. For example, if a

task successfully 'takes' the same mutex 5 times then the mutex will not be available to any other task until it has also 'given' the mutex back exactly five times.

This type of semaphore uses a priority inheritance mechanism so a task 'taking' a semaphore MUST ALWAYS 'give' the semaphore back once the semaphore it is no longer required.

Mutex type semaphores cannot be used from within interrupt service routines.

See `xSemaphoreCreateBinary()` for an alternative implementation that can be used for pure synchronisation (where one task or interrupt always 'gives' the semaphore and another always 'takes' the semaphore) and from within interrupt service routines.

Example usage:

```
SemaphoreHandle_t xSemaphore;

void vATask( void * pvParameters )
{
    // Semaphore cannot be used before a call to xSemaphoreCreateMutex().
    // This is a macro so pass the variable in directly.
    xSemaphore = xSemaphoreCreateRecursiveMutex();

    if( xSemaphore != NULL )
    {
        // The semaphore was created successfully.
        // The semaphore can now be used.
    }
}
```

**返回** xSemaphore Handle to the created mutex semaphore. Should be of type SemaphoreHandle\_t.

#### **xSemaphoreCreateRecursiveMutexStatic** (pxStaticSemaphore)

Creates a new recursive mutex type semaphore instance, and returns a handle by which the new recursive mutex can be referenced.

Internally, within the FreeRTOS implementation, recursive mutexes use a block of memory, in which the mutex structure is stored. If a recursive mutex is created using `xSemaphoreCreateRecursiveMutex()` then the required memory is automatically dynamically allocated inside the `xSemaphoreCreateRecursiveMutex()` function. (see <https://www.FreeRTOS.org/a00111.html>). If a recursive mutex is created using `xSemaphoreCreateRecursiveMutexStatic()` then the application writer must provide the memory that will get used by the mutex. `xSemaphoreCreateRecursiveMutexStatic()` therefore allows a recursive mutex to be created without using any dynamic memory allocation.

Mutexes created using this macro can be accessed using the `xSemaphoreTakeRecursive()` and `xSemaphoreGiveRecursive()` macros. The `xSemaphoreTake()` and `xSemaphoreGive()` macros must not be used.

A mutex used recursively can be 'taken' repeatedly by the owner. The mutex doesn't become available again until the owner has called `xSemaphoreGiveRecursive()` for each successful 'take' request. For example, if a task successfully 'takes' the same mutex 5 times then the mutex will not be available to any other task until it has also 'given' the mutex back exactly five times.

This type of semaphore uses a priority inheritance mechanism so a task 'taking' a semaphore MUST ALWAYS 'give' the semaphore back once the semaphore it is no longer required.

Mutex type semaphores cannot be used from within interrupt service routines.

See `xSemaphoreCreateBinary()` for an alternative implementation that can be used for pure synchronisation (where one task or interrupt always 'gives' the semaphore and another always 'takes' the semaphore) and from within interrupt service routines.

Example usage:

```

SemaphoreHandle_t xSemaphore;
StaticSemaphore_t xMutexBuffer;

void vATask( void * pvParameters )
{
    // A recursive semaphore cannot be used before it is created. Here a
    // recursive mutex is created using xSemaphoreCreateRecursiveMutexStatic().
    // The address of xMutexBuffer is passed into the function, and will hold
    // the mutexes data structures - so no dynamic memory allocation will be
    // attempted.
    xSemaphore = xSemaphoreCreateRecursiveMutexStatic( &xMutexBuffer );

    // As no dynamic memory allocation was performed, xSemaphore cannot be NULL,
    // so there is no need to check it.
}

```

### 参数

- **pxStaticSemaphore** -- Must point to a variable of type StaticSemaphore\_t, which will then be used to hold the recursive mutex's data structure, removing the need for the memory to be allocated dynamically.

**返回** If the recursive mutex was successfully created then a handle to the created recursive mutex is returned. If pxStaticSemaphore was NULL then NULL is returned.

### **xSemaphoreCreateCounting** (uxMaxCount, uxInitialCount)

Creates a new counting semaphore instance, and returns a handle by which the new counting semaphore can be referenced.

In many usage scenarios it is faster and more memory efficient to use a direct to task notification in place of a counting semaphore! <https://www.FreeRTOS.org/RTOS-task-notifications.html>

Internally, within the FreeRTOS implementation, counting semaphores use a block of memory, in which the counting semaphore structure is stored. If a counting semaphore is created using xSemaphoreCreateCounting() then the required memory is automatically dynamically allocated inside the xSemaphoreCreateCounting() function. (see <https://www.FreeRTOS.org/a00111.html>). If a counting semaphore is created using xSemaphoreCreateCountingStatic() then the application writer can instead optionally provide the memory that will get used by the counting semaphore. xSemaphoreCreateCountingStatic() therefore allows a counting semaphore to be created without using any dynamic memory allocation.

Counting semaphores are typically used for two things:

#### 1) Counting events.

In this usage scenario an event handler will 'give' a semaphore each time an event occurs (incrementing the semaphore count value), and a handler task will 'take' a semaphore each time it processes an event (decrementing the semaphore count value). The count value is therefore the difference between the number of events that have occurred and the number that have been processed. In this case it is desirable for the initial count value to be zero.

#### 2) Resource management.

In this usage scenario the count value indicates the number of resources available. To obtain control of a resource a task must first obtain a semaphore - decrementing the semaphore count value. When the count value reaches zero there are no free resources. When a task finishes with the resource it 'gives' the semaphore back - incrementing the semaphore count value. In this case it is desirable for the initial count value to be equal to the maximum count value, indicating that all resources are free.

Example usage:



```

SemaphoreHandle_t xSemaphore;

void vATask( void * pvParameters )
{
    SemaphoreHandle_t xSemaphore = NULL;

    // Semaphore cannot be used before a call to xSemaphoreCreateCounting().
    // The max value to which the semaphore can count should be 10, and the
    // initial value assigned to the count should be 0.
    xSemaphore = xSemaphoreCreateCounting( 10, 0 );

    if( xSemaphore != NULL )
    {
        // The semaphore was created successfully.
        // The semaphore can now be used.
    }
}

```

**参数**

- **uxMaxCount** -- The maximum count value that can be reached. When the semaphore reaches this value it can no longer be 'given'.
- **uxInitialCount** -- The count value assigned to the semaphore when it is created.

**返回** Handle to the created semaphore. Null if the semaphore could not be created.

**xSemaphoreCreateCountingStatic** (uxMaxCount, uxInitialCount, pxSemaphoreBuffer)

Creates a new counting semaphore instance, and returns a handle by which the new counting semaphore can be referenced.

In many usage scenarios it is faster and more memory efficient to use a direct to task notification in place of a counting semaphore! <https://www.FreeRTOS.org/RTOS-task-notifications.html>

Internally, within the FreeRTOS implementation, counting semaphores use a block of memory, in which the counting semaphore structure is stored. If a counting semaphore is created using `xSemaphoreCreateCounting()` then the required memory is automatically dynamically allocated inside the `xSemaphoreCreateCounting()` function. (see <https://www.FreeRTOS.org/a00111.html>). If a counting semaphore is created using `xSemaphoreCreateCountingStatic()` then the application writer must provide the memory. `xSemaphoreCreateCountingStatic()` therefore allows a counting semaphore to be created without using any dynamic memory allocation.

Counting semaphores are typically used for two things:

## 1) Counting events.

In this usage scenario an event handler will 'give' a semaphore each time an event occurs (incrementing the semaphore count value), and a handler task will 'take' a semaphore each time it processes an event (decrementing the semaphore count value). The count value is therefore the difference between the number of events that have occurred and the number that have been processed. In this case it is desirable for the initial count value to be zero.

## 2) Resource management.

In this usage scenario the count value indicates the number of resources available. To obtain control of a resource a task must first obtain a semaphore - decrementing the semaphore count value. When the count value reaches zero there are no free resources. When a task finishes with the resource it 'gives' the semaphore back - incrementing the semaphore count value. In this case it is desirable for the initial count value to be equal to the - maximum count value, indicating that all resources are free.

Example usage:

```

SemaphoreHandle_t xSemaphore;
StaticSemaphore_t xSemaphoreBuffer;

void vATask( void * pvParameters )
{
    SemaphoreHandle_t xSemaphore = NULL;

    // Counting semaphore cannot be used before they have been created. Create
    // a counting semaphore using xSemaphoreCreateCountingStatic(). The max
    // value to which the semaphore can count is 10, and the initial value
    // assigned to the count will be 0. The address of xSemaphoreBuffer is
    // passed in and will be used to hold the semaphore structure, so no dynamic
    // memory allocation will be used.
    xSemaphore = xSemaphoreCreateCounting( 10, 0, &xSemaphoreBuffer );

    // No memory allocation was attempted so xSemaphore cannot be NULL, so there
    // is no need to check its value.
}

```

**参数**

- **uxMaxCount** -- The maximum count value that can be reached. When the semaphore reaches this value it can no longer be 'given'.
- **uxInitialCount** -- The count value assigned to the semaphore when it is created.
- **pxSemaphoreBuffer** -- Must point to a variable of type StaticSemaphore\_t, which will then be used to hold the semaphore's data structure, removing the need for the memory to be allocated dynamically.

**返回** If the counting semaphore was successfully created then a handle to the created counting semaphore is returned. If pxSemaphoreBuffer was NULL then NULL is returned.

**vSemaphoreDelete** (xSemaphore)

Delete a semaphore. This function must be used with care. For example, do not delete a mutex type semaphore if the mutex is held by a task.

**参数**

- **xSemaphore** -- A handle to the semaphore to be deleted.

**xSemaphoreGetMutexHolder** (xSemaphore)

If xMutex is indeed a mutex type semaphore, return the current mutex holder. If xMutex is not a mutex type semaphore, or the mutex is available (not held by a task), return NULL.

Note: This is a good way of determining if the calling task is the mutex holder, but not a good way of determining the identity of the mutex holder as the holder may change between the function exiting and the returned value being tested.

**xSemaphoreGetMutexHolderFromISR** (xSemaphore)

If xMutex is indeed a mutex type semaphore, return the current mutex holder. If xMutex is not a mutex type semaphore, or the mutex is available (not held by a task), return NULL.

**uxSemaphoreGetCount** (xSemaphore)

If the semaphore is a counting semaphore then uxSemaphoreGetCount() returns its current count value. If the semaphore is a binary semaphore then uxSemaphoreGetCount() returns 1 if the semaphore is available, and 0 if the semaphore is not available.

**uxSemaphoreGetCountFromISR** (xSemaphore)

semphr.h

```

UBaseType_t uxSemaphoreGetCountFromISR( SemaphoreHandle_t xSemaphore );

```

If the semaphore is a counting semaphore then uxSemaphoreGetCountFromISR() returns its current count value. If the semaphore is a binary semaphore then uxSemaphoreGetCountFromISR() returns 1 if the semaphore is available, and 0 if the semaphore is not available.

**xSemaphoreGetStaticBuffer** (xSemaphore, ppxSemaphoreBuffer)

Retrieve pointer to a statically created binary semaphore, counting semaphore, or mutex semaphore's data structure buffer. This is the same buffer that is supplied at the time of creation.

**参数**

- **xSemaphore** -- The semaphore for which to retrieve the buffer.
- **ppxSemaphoreBuffer** -- Used to return a pointer to the semaphore's data structure buffer.

**返回** pdTRUE if buffer was retrieved, pdFALSE otherwise.

**Type Definitions**

typedef *QueueHandle\_t* **SemaphoreHandle\_t**

**定时器 API****Header File**

- [components/freertos/FreeRTOS-Kernel/include/freertos/timers.h](#)
- This header file can be included with:

```
#include "freertos/timers.h"
```

**Functions**

*TimerHandle\_t* **xTimerCreate** (const char \*const pcTimerName, const TickType\_t xTimerPeriodInTicks, const BaseType\_t xAutoReload, void \*const pvTimerID, *TimerCallbackFunction\_t* pxCallbackFunction)

Creates a new software timer instance, and returns a handle by which the created software timer can be referenced.

Internally, within the FreeRTOS implementation, software timers use a block of memory, in which the timer data structure is stored. If a software timer is created using xTimerCreate() then the required memory is automatically dynamically allocated inside the xTimerCreate() function. (see <https://www.FreeRTOS.org/a00111.html>). If a software timer is created using xTimerCreateStatic() then the application writer must provide the memory that will get used by the software timer. xTimerCreateStatic() therefore allows a software timer to be created without using any dynamic memory allocation.

Timers are created in the dormant state. The xTimerStart(), xTimerReset(), xTimerStartFromISR(), xTimerResetFromISR(), xTimerChangePeriod() and xTimerChangePeriodFromISR() API functions can all be used to transition a timer into the active state.

Example usage:

```
* #define NUM_TIMERS 5
*
* // An array to hold handles to the created timers.
* TimerHandle_t xTimers[ NUM_TIMERS ];
*
* // An array to hold a count of the number of times each timer expires.
* int32_t lExpireCounters[ NUM_TIMERS ] = { 0 };
*
* // Define a callback function that will be used by multiple timer instances.
* // The callback function does nothing but count the number of times the
* // associated timer expires, and stop the timer once the timer has expired
* // 10 times.
* void vTimerCallback( TimerHandle_t pxTimer )
```

(下页继续)

```

* {
* int32_t lArrayIndex;
* const int32_t xMaxExpiryCountBeforeStopping = 10;
*
* // Optionally do something if the pxTimer parameter is NULL.
* configASSERT( pxTimer );
*
* // Which timer expired?
* lArrayIndex = ( int32_t ) pvTimerGetTimerID( pxTimer );
*
* // Increment the number of times that pxTimer has expired.
* lExpireCounters[ lArrayIndex ] += 1;
*
* // If the timer has expired 10 times then stop it from running.
* if( lExpireCounters[ lArrayIndex ] == xMaxExpiryCountBeforeStopping )
* {
*     // Do not use a block time if calling a timer API function from a
*     // timer callback function, as doing so could cause a deadlock!
*     xTimerStop( pxTimer, 0 );
* }
* }
*
* void main( void )
* {
* int32_t x;
*
* // Create then start some timers. Starting the timers before the
↳scheduler
* // has been started means the timers will start running immediately that
* // the scheduler starts.
* for( x = 0; x < NUM_TIMERS; x++ )
* {
*     xTimers[ x ] = xTimerCreate( "Timer", // Just a text
↳name, not used by the kernel.
*                               ( 100 * ( x + 1 ) ), // The timer
↳period in ticks.
*                               pdTRUE, // The timers
↳will auto-reload themselves when they expire.
*                               ( void * ) x, // Assign each
↳timer a unique id equal to its array index.
*                               vTimerCallback // Each timer
↳calls the same callback when it expires.
*                               );
*
*     if( xTimers[ x ] == NULL )
*     {
*         // The timer was not created.
*     }
*     else
*     {
*         // Start the timer. No block time is specified, and even if one
↳was
*         // it would be ignored because the scheduler has not yet been
*         // started.
*         if( xTimerStart( xTimers[ x ], 0 ) != pdPASS )
*         {
*             // The timer could not be set into the Active state.
*         }
*     }
* }
* }

```

(下页继续)

```

* // ...
* // Create tasks here.
* // ...
*
* // Starting the scheduler will start the timers running as they have_
↪already
* // been set into the active state.
* vTaskStartScheduler();
*
* // Should not reach here.
* for( ;; );
* }
*

```

**参数**

- **pcTimerName** -- A text name that is assigned to the timer. This is done purely to assist debugging. The kernel itself only ever references a timer by its handle, and never by its name.
- **xTimerPeriodInTicks** -- The timer period. The time is defined in tick periods so the constant portTICK\_PERIOD\_MS can be used to convert a time that has been specified in milliseconds. For example, if the timer must expire after 100 ticks, then xTimerPeriodInTicks should be set to 100. Alternatively, if the timer must expire after 500ms, then xPeriod can be set to ( 500 / portTICK\_PERIOD\_MS ) provided configTICK\_RATE\_HZ is less than or equal to 1000. Time timer period must be greater than 0.
- **xAutoReload** -- If xAutoReload is set to pdTRUE then the timer will expire repeatedly with a frequency set by the xTimerPeriodInTicks parameter. If xAutoReload is set to pdFALSE then the timer will be a one-shot timer and enter the dormant state after it expires.
- **pvTimerID** -- An identifier that is assigned to the timer being created. Typically this would be used in the timer callback function to identify which timer expired when the same callback function is assigned to more than one timer.
- **pxCallbackFunction** -- The function to call when the timer expires. Callback functions must have the prototype defined by TimerCallbackFunction\_t, which is "void vCallbackFunction( TimerHandle\_t xTimer );".

**返回** If the timer is successfully created then a handle to the newly created timer is returned. If the timer cannot be created because there is insufficient FreeRTOS heap remaining to allocate the timer structures then NULL is returned.

*TimerHandle\_t* **xTimerCreateStatic** (const char \*const pcTimerName, const TickType\_t xTimerPeriodInTicks, const BaseType\_t xAutoReload, void \*const pvTimerID, *TimerCallbackFunction\_t* pxCallbackFunction, StaticTimer\_t \*pxTimerBuffer)

Creates a new software timer instance, and returns a handle by which the created software timer can be referenced.

Internally, within the FreeRTOS implementation, software timers use a block of memory, in which the timer data structure is stored. If a software timer is created using xTimerCreate() then the required memory is automatically dynamically allocated inside the xTimerCreate() function. (see <https://www.FreeRTOS.org/a00111.html>). If a software timer is created using xTimerCreateStatic() then the application writer must provide the memory that will get used by the software timer. xTimerCreateStatic() therefore allows a software timer to be created without using any dynamic memory allocation.

Timers are created in the dormant state. The xTimerStart(), xTimerReset(), xTimerStartFromISR(), xTimerResetFromISR(), xTimerChangePeriod() and xTimerChangePeriodFromISR() API functions can all be used to transition a timer into the active state.

Example usage:

```

*
* // The buffer used to hold the software timer's data structure.
* static StaticTimer_t xTimerBuffer;
*
* // A variable that will be incremented by the software timer's callback
* // function.
* UBaseType_t uxVariableToIncrement = 0;
*
* // A software timer callback function that increments a variable passed to
* // it when the software timer was created. After the 5th increment the
* // callback function stops the software timer.
* static void prvTimerCallback( TimerHandle_t xExpiredTimer )
* {
*     UBaseType_t *puxVariableToIncrement;
*     BaseType_t xReturned;
*
*     // Obtain the address of the variable to increment from the timer ID.
*     puxVariableToIncrement = ( UBaseType_t * ) pvTimerGetTimerID(
*     ↪xExpiredTimer );
*
*     // Increment the variable to show the timer callback has executed.
*     ( *puxVariableToIncrement )++;
*
*     // If this callback has executed the required number of times, stop the
*     // timer.
*     if( *puxVariableToIncrement == 5 )
*     {
*         // This is called from a timer callback so must not block.
*         xTimerStop( xExpiredTimer, staticDONT_BLOCK );
*     }
* }
*
* void main( void )
* {
*     // Create the software time. xTimerCreateStatic() has an extra parameter
*     // than the normal xTimerCreate() API function. The parameter is a
*     ↪pointer
*     // to the StaticTimer_t structure that will hold the software timer
*     // structure. If the parameter is passed as NULL then the structure
*     ↪will be
*     // allocated dynamically, just as if xTimerCreate() had been called.
*     xTimer = xTimerCreateStatic( "T1", // Text name for the task.
*     ↪ Helps debugging only. Not used by FreeRTOS.
*     xTimerPeriod, // The period of the
*     ↪timer in ticks.
*     pdTRUE, // This is an auto-reload
*     ↪timer.
*     ( void * ) &uxVariableToIncrement, // A
*     ↪variable incremented by the software timer's callback function
*     prvTimerCallback, // The function to
*     ↪execute when the timer expires.
*     &xTimerBuffer ); // The buffer that will
*     ↪hold the software timer structure.
*
*     // The scheduler has not started yet so a block time is not used.
*     xReturned = xTimerStart( xTimer, 0 );
*
*     // ...
*     // Create tasks here.
*     // ...
*
* }

```

(下页继续)

```

* // Starting the scheduler will start the timers running as they have_
↪already
* // been set into the active state.
* vTaskStartScheduler();
*
* // Should not reach here.
* for( ;; );
* }
*

```

### 参数

- **pcTimerName** -- A text name that is assigned to the timer. This is done purely to assist debugging. The kernel itself only ever references a timer by its handle, and never by its name.
- **xTimerPeriodInTicks** -- The timer period. The time is defined in tick periods so the constant portTICK\_PERIOD\_MS can be used to convert a time that has been specified in milliseconds. For example, if the timer must expire after 100 ticks, then xTimerPeriodInTicks should be set to 100. Alternatively, if the timer must expire after 500ms, then xPeriod can be set to ( 500 / portTICK\_PERIOD\_MS ) provided configTICK\_RATE\_HZ is less than or equal to 1000. The timer period must be greater than 0.
- **xAutoReload** -- If xAutoReload is set to pdTRUE then the timer will expire repeatedly with a frequency set by the xTimerPeriodInTicks parameter. If xAutoReload is set to pdFALSE then the timer will be a one-shot timer and enter the dormant state after it expires.
- **pvTimerID** -- An identifier that is assigned to the timer being created. Typically this would be used in the timer callback function to identify which timer expired when the same callback function is assigned to more than one timer.
- **pxCallbackFunction** -- The function to call when the timer expires. Callback functions must have the prototype defined by TimerCallbackFunction\_t, which is "void vCallbackFunction( TimerHandle\_t xTimer );".
- **pxTimerBuffer** -- Must point to a variable of type StaticTimer\_t, which will be then be used to hold the software timer's data structures, removing the need for the memory to be allocated dynamically.

**返回** If the timer is created then a handle to the created timer is returned. If pxTimerBuffer was NULL then NULL is returned.

void \***pvTimerGetTimerID** (const *TimerHandle\_t* xTimer)

Returns the ID assigned to the timer.

IDs are assigned to timers using the pvTimerID parameter of the call to xTimerCreated() that was used to create the timer, and by calling the vTimerSetTimerID() API function.

If the same callback function is assigned to multiple timers then the timer ID can be used as time specific (timer local) storage.

Example usage:

See the xTimerCreate() API function example usage scenario.

**参数** **xTimer** -- The timer being queried.

**返回** The ID assigned to the timer being queried.

void **vTimerSetTimerID** (*TimerHandle\_t* xTimer, void \*pvNewID)

Sets the ID assigned to the timer.

IDs are assigned to timers using the pvTimerID parameter of the call to xTimerCreated() that was used to create the timer.

If the same callback function is assigned to multiple timers then the timer ID can be used as time specific (timer local) storage.

Example usage:

See the `xTimerCreate()` API function example usage scenario.

#### 参数

- **xTimer** -- The timer being updated.
- **pvNewID** -- The ID to assign to the timer.

BaseType\_t **xTimerIsTimerActive** (*TimerHandle\_t* xTimer)

Queries a timer to see if it is active or dormant.

A timer will be dormant if: 1) It has been created but not started, or 2) It is an expired one-shot timer that has not been restarted.

Timers are created in the dormant state. The `xTimerStart()`, `xTimerReset()`, `xTimerStartFromISR()`, `xTimerResetFromISR()`, `xTimerChangePeriod()` and `xTimerChangePeriodFromISR()` API functions can all be used to transition a timer into the active state.

Example usage:

```
* // This function assumes xTimer has already been created.
* void vAFunction( TimerHandle_t xTimer )
* {
*     if( xTimerIsTimerActive( xTimer ) != pdFALSE ) // or more simply and
*     equivalently "if( xTimerIsTimerActive( xTimer ) )"
*     {
*         // xTimer is active, do something.
*     }
*     else
*     {
*         // xTimer is not active, do something else.
*     }
* }
*
```

参数 **xTimer** -- The timer being queried.

返回 pdFALSE will be returned if the timer is dormant. A value other than pdFALSE will be returned if the timer is active.

*TaskHandle\_t* **xTimerGetTimerDaemonTaskHandle** (void)

Simply returns the handle of the timer service/daemon task. It is not valid to call `xTimerGetTimerDaemonTaskHandle()` before the scheduler has been started.

BaseType\_t **xTimerPendFunctionCallFromISR** (*PendedFunction\_t* xFunctionToPend, void \*pvParameter1, uint32\_t ulParameter2, BaseType\_t \*pxHigherPriorityTaskWoken)

Used from application interrupt service routines to defer the execution of a function to the RTOS daemon task (the timer service task, hence this function is implemented in `timers.c` and is prefixed with 'Timer').

Ideally an interrupt service routine (ISR) is kept as short as possible, but sometimes an ISR either has a lot of processing to do, or needs to perform processing that is not deterministic. In these cases `xTimerPendFunctionCallFromISR()` can be used to defer processing of a function to the RTOS daemon task.

A mechanism is provided that allows the interrupt to return directly to the task that will subsequently execute the pended callback function. This allows the callback function to execute contiguously in time with the interrupt - just as if the callback had executed in the interrupt itself.



Example usage:

```

*
* // The callback function that will execute in the context of the daemon_
* ↪task.
* // Note callback functions must all use this same prototype.
* void vProcessInterface( void *pvParameter1, uint32_t ulParameter2 )
* {
*     BaseType_t xInterfaceToService;
*
*     // The interface that requires servicing is passed in the second
*     // parameter. The first parameter is not used in this case.
*     xInterfaceToService = ( BaseType_t ) ulParameter2;
*
*     // ...Perform the processing here...
* }
*
* // An ISR that receives data packets from multiple interfaces
* void vAnISR( void )
* {
*     BaseType_t xInterfaceToService, xHigherPriorityTaskWoken;
*
*     // Query the hardware to determine which interface needs processing.
*     xInterfaceToService = prvCheckInterfaces();
*
*     // The actual processing is to be deferred to a task. Request the
*     // vProcessInterface() callback function is executed, passing in the
*     // number of the interface that needs processing. The interface to
*     // service is passed in the second parameter. The first parameter is
*     // not used in this case.
*     xHigherPriorityTaskWoken = pdFALSE;
*     xTimerPendFunctionCallFromISR( vProcessInterface, NULL, ( uint32_t ) ↪
*     ↪xInterfaceToService, &xHigherPriorityTaskWoken );
*
*     // If xHigherPriorityTaskWoken is now set to pdTRUE then a context
*     // switch should be requested. The macro used is port specific and will
*     // be either portYIELD_FROM_ISR() or portEND_SWITCHING_ISR() - refer to
*     // the documentation page for the port being used.
*     portYIELD_FROM_ISR( xHigherPriorityTaskWoken );
* }
*

```

### 参数

- **xFunctionToPend** -- The function to execute from the timer service/ daemon task. The function must conform to the PendedFunction\_t prototype.
- **pvParameter1** -- The value of the callback function's first parameter. The parameter has a void \* type to allow it to be used to pass any type. For example, unsigned longs can be cast to a void \*, or the void \* can be used to point to a structure.
- **ulParameter2** -- The value of the callback function's second parameter.
- **pxHigherPriorityTaskWoken** -- As mentioned above, calling this function will result in a message being sent to the timer daemon task. If the priority of the timer daemon task (which is set using configTIMER\_TASK\_PRIORITY in FreeRTOSConfig.h) is higher than the priority of the currently running task (the task the interrupt interrupted) then \*pxHigherPriorityTaskWoken will be set to pdTRUE within xTimerPendFunctionCallFromISR(), indicating that a context switch should be requested before the interrupt exits. For that reason \*pxHigherPriorityTaskWoken must be initialised to pdFALSE. See the example code below.

**返回** pdPASS is returned if the message was successfully sent to the timer daemon task, otherwise pdFALSE is returned.

BaseType\_t **xTimerPendFunctionCall** (*PendedFunction\_t* xFunctionToPend, void \*pvParameter1, uint32\_t ulParameter2, TickType\_t xTicksToWait)

Used to defer the execution of a function to the RTOS daemon task (the timer service task, hence this function is implemented in timers.c and is prefixed with "Timer").

#### 参数

- **xFunctionToPend** -- The function to execute from the timer service/ daemon task. The function must conform to the PendedFunction\_t prototype.
- **pvParameter1** -- The value of the callback function's first parameter. The parameter has a void \* type to allow it to be used to pass any type. For example, unsigned longs can be cast to a void \*, or the void \* can be used to point to a structure.
- **ulParameter2** -- The value of the callback function's second parameter.
- **xTicksToWait** -- Calling this function will result in a message being sent to the timer daemon task on a queue. xTicksToWait is the amount of time the calling task should remain in the Blocked state (so not using any processing time) for space to become available on the timer queue if the queue is found to be full.

**返回** pdPASS is returned if the message was successfully sent to the timer daemon task, otherwise pdFALSE is returned.

const char \***pcTimerGetName** (*TimerHandle\_t* xTimer)

Returns the name that was assigned to a timer when the timer was created.

**参数** **xTimer** -- The handle of the timer being queried.

**返回** The name assigned to the timer specified by the xTimer parameter.

void **vTimerSetReloadMode** (*TimerHandle\_t* xTimer, const BaseType\_t xAutoReload)

Updates a timer to be either an auto-reload timer, in which case the timer automatically resets itself each time it expires, or a one-shot timer, in which case the timer will only expire once unless it is manually restarted.

#### 参数

- **xTimer** -- The handle of the timer being updated.
- **xAutoReload** -- If xAutoReload is set to pdTRUE then the timer will expire repeatedly with a frequency set by the timer's period (see the xTimerPeriodInTicks parameter of the xTimerCreate() API function). If xAutoReload is set to pdFALSE then the timer will be a one-shot timer and enter the dormant state after it expires.

BaseType\_t **xTimerGetReloadMode** (*TimerHandle\_t* xTimer)

Queries a timer to determine if it is an auto-reload timer, in which case the timer automatically resets itself each time it expires, or a one-shot timer, in which case the timer will only expire once unless it is manually restarted.

**参数** **xTimer** -- The handle of the timer being queried.

**返回** If the timer is an auto-reload timer then pdTRUE is returned, otherwise pdFALSE is returned.

UBaseType\_t **uxTimerGetReloadMode** (*TimerHandle\_t* xTimer)

Queries a timer to determine if it is an auto-reload timer, in which case the timer automatically resets itself each time it expires, or a one-shot timer, in which case the timer will only expire once unless it is manually restarted.

**参数** **xTimer** -- The handle of the timer being queried.

**返回** If the timer is an auto-reload timer then pdTRUE is returned, otherwise pdFALSE is returned.

TickType\_t **xTimerGetPeriod** (*TimerHandle\_t* xTimer)

Returns the period of a timer.

**参数** **xTimer** -- The handle of the timer being queried.

**返回** The period of the timer in ticks.

TickType\_t **xTimerGetExpiryTime** (*TimerHandle\_t* xTimer)

Returns the time in ticks at which the timer will expire. If this is less than the current tick count then the expiry time has overflowed from the current time.

**参数 xTimer** -- The handle of the timer being queried.

**返回** If the timer is running then the time in ticks at which the timer will next expire is returned. If the timer is not running then the return value is undefined.

BaseType\_t **xTimerGetStaticBuffer** (*TimerHandle\_t* xTimer, StaticTimer\_t \*\*ppxTimerBuffer)

Retrieve pointer to a statically created timer's data structure buffer. This is the same buffer that is supplied at the time of creation.

**参数**

- **xTimer** -- The timer for which to retrieve the buffer.
- **ppxTimerBuffer** -- Used to return a pointer to the timers's data structure buffer.

**返回** pdTRUE if the buffer was retrieved, pdFALSE otherwise.

void **vApplicationGetTimerTaskMemory** (StaticTask\_t \*\*ppxTimerTaskTCBBuffer, StackType\_t \*\*ppxTimerTaskStackBuffer, uint32\_t \*pulTimerTaskStackSize)

This function is used to provide a statically allocated block of memory to FreeRTOS to hold the Timer Task TCB. This function is required when configSUPPORT\_STATIC\_ALLOCATION is set. For more information see this URI: [https://www.FreeRTOS.org/a00110.html#configSUPPORT\\_STATIC\\_ALLOCATION](https://www.FreeRTOS.org/a00110.html#configSUPPORT_STATIC_ALLOCATION)

**参数**

- **ppxTimerTaskTCBBuffer** -- A handle to a statically allocated TCB buffer
- **ppxTimerTaskStackBuffer** -- A handle to a statically allocated Stack buffer for the idle task
- **pulTimerTaskStackSize** -- A pointer to the number of elements that will fit in the allocated stack buffer

## Macros

**xTimerStart** (xTimer, xTicksToWait)

Timer functionality is provided by a timer service/daemon task. Many of the public FreeRTOS timer API functions send commands to the timer service task through a queue called the timer command queue. The timer command queue is private to the kernel itself and is not directly accessible to application code. The length of the timer command queue is set by the configTIMER\_QUEUE\_LENGTH configuration constant.

xTimerStart() starts a timer that was previously created using the xTimerCreate() API function. If the timer had already been started and was already in the active state, then xTimerStart() has equivalent functionality to the xTimerReset() API function.

Starting a timer ensures the timer is in the active state. If the timer is not stopped, deleted, or reset in the mean time, the callback function associated with the timer will get called 'n' ticks after xTimerStart() was called, where 'n' is the timers defined period.

It is valid to call xTimerStart() before the scheduler has been started, but when this is done the timer will not actually start until the scheduler is started, and the timers expiry time will be relative to when the scheduler is started, not relative to when xTimerStart() was called.

The configUSE\_TIMERS configuration constant must be set to 1 for xTimerStart() to be available.

Example usage:

See the xTimerCreate() API function example usage scenario.

**参数**

- **xTimer** -- The handle of the timer being started/restarted.
- **xTicksToWait** -- Specifies the time, in ticks, that the calling task should be held in the Blocked state to wait for the start command to be successfully sent to the timer command queue, should the queue already be full when xTimerStart() was called. xTicksToWait is ignored if xTimerStart() is called before the scheduler is started.

**返回** pdFAIL will be returned if the start command could not be sent to the timer command queue even after xTicksToWait ticks had passed. pdPASS will be returned if the command was successfully sent to the timer command queue. When the command is actually processed will

depend on the priority of the timer service/daemon task relative to other tasks in the system, although the timers expiry time is relative to when `xTimerStart()` is actually called. The timer service/daemon task priority is set by the `configTIMER_TASK_PRIORITY` configuration constant.

#### **xTimerStop** (xTimer, xTicksToWait)

Timer functionality is provided by a timer service/daemon task. Many of the public FreeRTOS timer API functions send commands to the timer service task through a queue called the timer command queue. The timer command queue is private to the kernel itself and is not directly accessible to application code. The length of the timer command queue is set by the `configTIMER_QUEUE_LENGTH` configuration constant.

`xTimerStop()` stops a timer that was previously started using either of the `The xTimerStart()`, `xTimerReset()`, `xTimerStartFromISR()`, `xTimerResetFromISR()`, `xTimerChangePeriod()` or `xTimerChangePeriodFromISR()` API functions.

Stopping a timer ensures the timer is not in the active state.

The `configUSE_TIMERS` configuration constant must be set to 1 for `xTimerStop()` to be available.

Example usage:

See the `xTimerCreate()` API function example usage scenario.

#### 参数

- **xTimer** -- The handle of the timer being stopped.
- **xTicksToWait** -- Specifies the time, in ticks, that the calling task should be held in the Blocked state to wait for the stop command to be successfully sent to the timer command queue, should the queue already be full when `xTimerStop()` was called. `xTicksToWait` is ignored if `xTimerStop()` is called before the scheduler is started.

**返回** `pdFAIL` will be returned if the stop command could not be sent to the timer command queue even after `xTicksToWait` ticks had passed. `pdPASS` will be returned if the command was successfully sent to the timer command queue. When the command is actually processed will depend on the priority of the timer service/daemon task relative to other tasks in the system. The timer service/daemon task priority is set by the `configTIMER_TASK_PRIORITY` configuration constant.

#### **xTimerChangePeriod** (xTimer, xNewPeriod, xTicksToWait)

Timer functionality is provided by a timer service/daemon task. Many of the public FreeRTOS timer API functions send commands to the timer service task through a queue called the timer command queue. The timer command queue is private to the kernel itself and is not directly accessible to application code. The length of the timer command queue is set by the `configTIMER_QUEUE_LENGTH` configuration constant.

`xTimerChangePeriod()` changes the period of a timer that was previously created using the `xTimerCreate()` API function.

`xTimerChangePeriod()` can be called to change the period of an active or dormant state timer.

The `configUSE_TIMERS` configuration constant must be set to 1 for `xTimerChangePeriod()` to be available.

Example usage:

```
* // This function assumes xTimer has already been created. If the timer
* // referenced by xTimer is already active when it is called, then the timer
* // is deleted. If the timer referenced by xTimer is not active when it is
* // called, then the period of the timer is set to 500ms and the timer is
* // started.
* void vAFunction( TimerHandle_t xTimer )
* {
*     if( xTimerIsTimerActive( xTimer ) != pdFALSE ) // or more simply and
*     →equivalently "if( xTimerIsTimerActive( xTimer ) )"
*     {
```

(下页继续)

```

*      // xTimer is already active - delete it.
*      xTimerDelete( xTimer );
*    }
*    else
*    {
*      // xTimer is not active, change its period to 500ms. This will also
*      // cause the timer to start. Block for a maximum of 100 ticks if the
*      // change period command cannot immediately be sent to the timer
*      // command queue.
*      if( xTimerChangePeriod( xTimer, 500 / portTICK_PERIOD_MS, 100 ) ==_
↪pdPASS )
*      {
*        // The command was successfully sent.
*      }
*      else
*      {
*        // The command could not be sent, even after waiting for 100_
↪ticks
*        // to pass. Take appropriate action here.
*      }
*    }
* }
*

```

### 参数

- **xTimer** -- The handle of the timer that is having its period changed.
- **xNewPeriod** -- The new period for xTimer. Timer periods are specified in tick periods, so the constant portTICK\_PERIOD\_MS can be used to convert a time that has been specified in milliseconds. For example, if the timer must expire after 100 ticks, then xNewPeriod should be set to 100. Alternatively, if the timer must expire after 500ms, then xNewPeriod can be set to ( 500 / portTICK\_PERIOD\_MS ) provided configTICK\_RATE\_HZ is less than or equal to 1000.
- **xTicksToWait** -- Specifies the time, in ticks, that the calling task should be held in the Blocked state to wait for the change period command to be successfully sent to the timer command queue, should the queue already be full when xTimerChangePeriod() was called. xTicksToWait is ignored if xTimerChangePeriod() is called before the scheduler is started.

**返回** pdFAIL will be returned if the change period command could not be sent to the timer command queue even after xTicksToWait ticks had passed. pdPASS will be returned if the command was successfully sent to the timer command queue. When the command is actually processed will depend on the priority of the timer service/daemon task relative to other tasks in the system. The timer service/daemon task priority is set by the configTIMER\_TASK\_PRIORITY configuration constant.

### **xTimerDelete** (xTimer, xTicksToWait)

Timer functionality is provided by a timer service/daemon task. Many of the public FreeRTOS timer API functions send commands to the timer service task through a queue called the timer command queue. The timer command queue is private to the kernel itself and is not directly accessible to application code. The length of the timer command queue is set by the configTIMER\_QUEUE\_LENGTH configuration constant.

xTimerDelete() deletes a timer that was previously created using the xTimerCreate() API function.

The configUSE\_TIMERS configuration constant must be set to 1 for xTimerDelete() to be available.

Example usage:

See the xTimerChangePeriod() API function example usage scenario.

### 参数

- **xTimer** -- The handle of the timer being deleted.
- **xTicksToWait** -- Specifies the time, in ticks, that the calling task should be held in the Blocked state to wait for the delete command to be successfully sent to the timer command queue, should the queue already be full when xTimerDelete() was called. xTicksToWait is ignored if xTimerDelete() is called before the scheduler is started.

**返回** pdFAIL will be returned if the delete command could not be sent to the timer command queue even after xTicksToWait ticks had passed. pdPASS will be returned if the command was successfully sent to the timer command queue. When the command is actually processed will depend on the priority of the timer service/daemon task relative to other tasks in the system. The timer service/daemon task priority is set by the configTIMER\_TASK\_PRIORITY configuration constant.

#### **xTimerReset** (xTimer, xTicksToWait)

Timer functionality is provided by a timer service/daemon task. Many of the public FreeRTOS timer API functions send commands to the timer service task through a queue called the timer command queue. The timer command queue is private to the kernel itself and is not directly accessible to application code. The length of the timer command queue is set by the configTIMER\_QUEUE\_LENGTH configuration constant.

xTimerReset() re-starts a timer that was previously created using the xTimerCreate() API function. If the timer had already been started and was already in the active state, then xTimerReset() will cause the timer to re-evaluate its expiry time so that it is relative to when xTimerReset() was called. If the timer was in the dormant state then xTimerReset() has equivalent functionality to the xTimerStart() API function.

Resetting a timer ensures the timer is in the active state. If the timer is not stopped, deleted, or reset in the mean time, the callback function associated with the timer will get called 'n' ticks after xTimerReset() was called, where 'n' is the timers defined period.

It is valid to call xTimerReset() before the scheduler has been started, but when this is done the timer will not actually start until the scheduler is started, and the timers expiry time will be relative to when the scheduler is started, not relative to when xTimerReset() was called.

The configUSE\_TIMERS configuration constant must be set to 1 for xTimerReset() to be available.

Example usage:

```
* // When a key is pressed, an LCD back-light is switched on. If 5 seconds
↳pass
* // without a key being pressed, then the LCD back-light is switched off. In
* // this case, the timer is a one-shot timer.
*
* TimerHandle_t xBacklightTimer = NULL;
*
* // The callback function assigned to the one-shot timer. In this case the
* // parameter is not used.
* void vBacklightTimerCallback( TimerHandle_t pxTimer )
* {
*     // The timer expired, therefore 5 seconds must have passed since a key
*     // was pressed. Switch off the LCD back-light.
*     vSetBacklightState( BACKLIGHT_OFF );
* }
*
* // The key press event handler.
* void vKeyPressEventHandler( char cKey )
* {
*     // Ensure the LCD back-light is on, then reset the timer that is
*     // responsible for turning the back-light off after 5 seconds of
*     // key inactivity. Wait 10 ticks for the command to be successfully sent
*     // if it cannot be sent immediately.
*     vSetBacklightState( BACKLIGHT_ON );
*     if( xTimerReset( xBacklightTimer, 100 ) != pdPASS )
*     {
```

(下页继续)

```

*         // The reset command was not executed successfully. Take appropriate
*         // action here.
*     }
*
*     // Perform the rest of the key processing here.
* }
*
* void main( void )
* {
*     int32_t x;
*
*     // Create then start the one-shot timer that is responsible for turning
*     // the back-light off if no keys are pressed within a 5 second period.
*     xBacklightTimer = xTimerCreate( "BacklightTimer",           // Just a
* ↪text name, not used by the kernel.
*
* ↪timer period in ticks.
*                                     pdFALSE,                 // The timer
* ↪is a one-shot timer.
*                                     0,                        // The id is
* ↪not used by the callback so can take any value.
*                                     vBacklightTimerCallback    // The
* ↪callback function that switches the LCD back-light off.
*                                     );
*
*     if( xBacklightTimer == NULL )
*     {
*         // The timer was not created.
*     }
*     else
*     {
*         // Start the timer. No block time is specified, and even if one was
*         // it would be ignored because the scheduler has not yet been
*         // started.
*         if( xTimerStart( xBacklightTimer, 0 ) != pdPASS )
*         {
*             // The timer could not be set into the Active state.
*         }
*     }
*
*     // ...
*     // Create tasks here.
*     // ...
*
*     // Starting the scheduler will start the timer running as it has already
*     // been set into the active state.
*     vTaskStartScheduler();
*
*     // Should not reach here.
*     for( ;; );
* }
*

```

**参数**

- **xTimer** -- The handle of the timer being reset/started/restarted.
- **xTicksToWait** -- Specifies the time, in ticks, that the calling task should be held in the Blocked state to wait for the reset command to be successfully sent to the timer command queue, should the queue already be full when xTimerReset() was called. xTicksToWait is ignored if xTimerReset() is called before the scheduler is started.

**返回** pdFAIL will be returned if the reset command could not be sent to the timer command queue even after xTicksToWait ticks had passed. pdPASS will be returned if the command



was successfully sent to the timer command queue. When the command is actually processed will depend on the priority of the timer service/daemon task relative to other tasks in the system, although the timers expiry time is relative to when xTimerStart() is actually called. The timer service/daemon task priority is set by the configTIMER\_TASK\_PRIORITY configuration constant.

#### **xTimerStartFromISR** (xTimer, pxHigherPriorityTaskWoken)

A version of xTimerStart() that can be called from an interrupt service routine.

Example usage:

```
* // This scenario assumes xBacklightTimer has already been created. When a
* // key is pressed, an LCD back-light is switched on. If 5 seconds pass
* // without a key being pressed, then the LCD back-light is switched off. In
* // this case, the timer is a one-shot timer, and unlike the example given for
* // the xTimerReset() function, the key press event handler is an interrupt
* // service routine.
*
* // The callback function assigned to the one-shot timer. In this case the
* // parameter is not used.
* void vBacklightTimerCallback( TimerHandle_t pxTimer )
* {
*     // The timer expired, therefore 5 seconds must have passed since a key
*     // was pressed. Switch off the LCD back-light.
*     vSetBacklightState( BACKLIGHT_OFF );
* }
*
* // The key press interrupt service routine.
* void vKeyPressEventInterruptHandler( void )
* {
*     BaseType_t xHigherPriorityTaskWoken = pdFALSE;
*
*     // Ensure the LCD back-light is on, then restart the timer that is
*     // responsible for turning the back-light off after 5 seconds of
*     // key inactivity. This is an interrupt service routine so can only
*     // call FreeRTOS API functions that end in "FromISR".
*     vSetBacklightState( BACKLIGHT_ON );
*
*     // xTimerStartFromISR() or xTimerResetFromISR() could be called here
*     // as both cause the timer to re-calculate its expiry time.
*     // xHigherPriorityTaskWoken was initialised to pdFALSE when it was
*     // declared (in this function).
*     if( xTimerStartFromISR( xBacklightTimer, &xHigherPriorityTaskWoken ) !=
↳pdPASS )
*     {
*         // The start command was not executed successfully. Take appropriate
*         // action here.
*     }
*
*     // Perform the rest of the key processing here.
*
*     // If xHigherPriorityTaskWoken equals pdTRUE, then a context switch
*     // should be performed. The syntax required to perform a context switch
*     // from inside an ISR varies from port to port, and from compiler to
*     // compiler. Inspect the demos for the port you are using to find the
*     // actual syntax required.
*     if( xHigherPriorityTaskWoken != pdFALSE )
*     {
*         // Call the interrupt safe yield function here (actual function
*         // depends on the FreeRTOS port being used).

```

(下页继续)



```
* }
* }
*
```

**参数**

- **xTimer** -- The handle of the timer being started/restarted.
- **pxHigherPriorityTaskWoken** -- The timer service/daemon task spends most of its time in the Blocked state, waiting for messages to arrive on the timer command queue. Calling xTimerStartFromISR() writes a message to the timer command queue, so has the potential to transition the timer service/daemon task out of the Blocked state. If calling xTimerStartFromISR() causes the timer service/daemon task to leave the Blocked state, and the timer service/ daemon task has a priority equal to or greater than the currently executing task (the task that was interrupted), then \*pxHigherPriorityTaskWoken will get set to pdTRUE internally within the xTimerStartFromISR() function. If xTimerStartFromISR() sets this value to pdTRUE then a context switch should be performed before the interrupt exits.

**返回** pdFAIL will be returned if the start command could not be sent to the timer command queue. pdPASS will be returned if the command was successfully sent to the timer command queue. When the command is actually processed will depend on the priority of the timer service/daemon task relative to other tasks in the system, although the timers expiry time is relative to when xTimerStartFromISR() is actually called. The timer service/daemon task priority is set by the configTIMER\_TASK\_PRIORITY configuration constant.

**xTimerStopFromISR** (xTimer, pxHigherPriorityTaskWoken)

A version of xTimerStop() that can be called from an interrupt service routine.

**Example usage:**

```
* // This scenario assumes xTimer has already been created and started. When
* // an interrupt occurs, the timer should be simply stopped.
*
* // The interrupt service routine that stops the timer.
* void vAnExampleInterruptServiceRoutine( void )
* {
* BaseType_t xHigherPriorityTaskWoken = pdFALSE;
*
* // The interrupt has occurred - simply stop the timer.
* // xHigherPriorityTaskWoken was set to pdFALSE where it was defined
* // (within this function). As this is an interrupt service routine, only
* // FreeRTOS API functions that end in "FromISR" can be used.
* if( xTimerStopFromISR( xTimer, &xHigherPriorityTaskWoken ) != pdPASS )
* {
* // The stop command was not executed successfully. Take appropriate
* // action here.
* }
*
* // If xHigherPriorityTaskWoken equals pdTRUE, then a context switch
* // should be performed. The syntax required to perform a context switch
* // from inside an ISR varies from port to port, and from compiler to
* // compiler. Inspect the demos for the port you are using to find the
* // actual syntax required.
* if( xHigherPriorityTaskWoken != pdFALSE )
* {
* // Call the interrupt safe yield function here (actual function
* // depends on the FreeRTOS port being used).
* }
* }
*
```

## 参数

- **xTimer** -- The handle of the timer being stopped.
- **pxHigherPriorityTaskWoken** -- The timer service/daemon task spends most of its time in the Blocked state, waiting for messages to arrive on the timer command queue. Calling xTimerStopFromISR() writes a message to the timer command queue, so has the potential to transition the timer service/daemon task out of the Blocked state. If calling xTimerStopFromISR() causes the timer service/daemon task to leave the Blocked state, and the timer service/ daemon task has a priority equal to or greater than the currently executing task (the task that was interrupted), then \*pxHigherPriorityTaskWoken will get set to pdTRUE internally within the xTimerStopFromISR() function. If xTimerStopFromISR() sets this value to pdTRUE then a context switch should be performed before the interrupt exits.

**返回** pdFAIL will be returned if the stop command could not be sent to the timer command queue. pdPASS will be returned if the command was successfully sent to the timer command queue. When the command is actually processed will depend on the priority of the timer service/daemon task relative to other tasks in the system. The timer service/daemon task priority is set by the configTIMER\_TASK\_PRIORITY configuration constant.

**xTimerChangePeriodFromISR** (xTimer, xNewPeriod, pxHigherPriorityTaskWoken)

A version of xTimerChangePeriod() that can be called from an interrupt service routine.

Example usage:

```
* // This scenario assumes xTimer has already been created and started. When
* // an interrupt occurs, the period of xTimer should be changed to 500ms.
*
* // The interrupt service routine that changes the period of xTimer.
* void vAnExampleInterruptServiceRoutine( void )
* {
* BaseType_t xHigherPriorityTaskWoken = pdFALSE;
*
* // The interrupt has occurred - change the period of xTimer to 500ms.
* // xHigherPriorityTaskWoken was set to pdFALSE where it was defined
* // (within this function). As this is an interrupt service routine, only
* // FreeRTOS API functions that end in "FromISR" can be used.
* if( xTimerChangePeriodFromISR( xTimer, &xHigherPriorityTaskWoken ) !=
↳pdPASS )
* {
* // The command to change the timers period was not executed
* // successfully. Take appropriate action here.
* }
*
* // If xHigherPriorityTaskWoken equals pdTRUE, then a context switch
* // should be performed. The syntax required to perform a context switch
* // from inside an ISR varies from port to port, and from compiler to
* // compiler. Inspect the demos for the port you are using to find the
* // actual syntax required.
* if( xHigherPriorityTaskWoken != pdFALSE )
* {
* // Call the interrupt safe yield function here (actual function
* // depends on the FreeRTOS port being used).
* }
* }
*
```

## 参数

- **xTimer** -- The handle of the timer that is having its period changed.
- **xNewPeriod** -- The new period for xTimer. Timer periods are specified in tick periods, so the constant portTICK\_PERIOD\_MS can be used to convert a time that has been spec-

ified in milliseconds. For example, if the timer must expire after 100 ticks, then `xNewPeriod` should be set to 100. Alternatively, if the timer must expire after 500ms, then `xNewPeriod` can be set to  $( 500 / \text{portTICK\_PERIOD\_MS} )$  provided `configTICK_RATE_HZ` is less than or equal to 1000.

- **pxHigherPriorityTaskWoken** -- The timer service/daemon task spends most of its time in the Blocked state, waiting for messages to arrive on the timer command queue. Calling `xTimerChangePeriodFromISR()` writes a message to the timer command queue, so has the potential to transition the timer service/ daemon task out of the Blocked state. If calling `xTimerChangePeriodFromISR()` causes the timer service/daemon task to leave the Blocked state, and the timer service/daemon task has a priority equal to or greater than the currently executing task (the task that was interrupted), then `*pxHigherPriorityTaskWoken` will get set to `pdTRUE` internally within the `xTimerChangePeriodFromISR()` function. If `xTimerChangePeriodFromISR()` sets this value to `pdTRUE` then a context switch should be performed before the interrupt exits.

**返回** `pdFAIL` will be returned if the command to change the timers period could not be sent to the timer command queue. `pdPASS` will be returned if the command was successfully sent to the timer command queue. When the command is actually processed will depend on the priority of the timer service/daemon task relative to other tasks in the system. The timer service/daemon task priority is set by the `configTIMER_TASK_PRIORITY` configuration constant.

#### **xTimerResetFromISR** (xTimer, pxHigherPriorityTaskWoken)

A version of `xTimerReset()` that can be called from an interrupt service routine.

Example usage:

```
* // This scenario assumes xBacklightTimer has already been created. When a
* // key is pressed, an LCD back-light is switched on. If 5 seconds pass
* // without a key being pressed, then the LCD back-light is switched off. In
* // this case, the timer is a one-shot timer, and unlike the example given for
* // the xTimerReset() function, the key press event handler is an interrupt
* // service routine.
*
* // The callback function assigned to the one-shot timer. In this case the
* // parameter is not used.
* void vBacklightTimerCallback( TimerHandle_t pxTimer )
* {
*     // The timer expired, therefore 5 seconds must have passed since a key
*     // was pressed. Switch off the LCD back-light.
*     vSetBacklightState( BACKLIGHT_OFF );
* }
*
* // The key press interrupt service routine.
* void vKeyPressEventInterruptHandler( void )
* {
*     BaseType_t xHigherPriorityTaskWoken = pdFALSE;
*
*     // Ensure the LCD back-light is on, then reset the timer that is
*     // responsible for turning the back-light off after 5 seconds of
*     // key inactivity. This is an interrupt service routine so can only
*     // call FreeRTOS API functions that end in "FromISR".
*     vSetBacklightState( BACKLIGHT_ON );
*
*     // xTimerStartFromISR() or xTimerResetFromISR() could be called here
*     // as both cause the timer to re-calculate its expiry time.
*     // xHigherPriorityTaskWoken was initialised to pdFALSE when it was
*     // declared (in this function).
*     if( xTimerResetFromISR( xBacklightTimer, &xHigherPriorityTaskWoken ) !=
*     ↪pdPASS )
*     {
```

(下页继续)

```

*         // The reset command was not executed successfully. Take appropriate
*         // action here.
*     }
*
*     // Perform the rest of the key processing here.
*
*     // If xHigherPriorityTaskWoken equals pdTRUE, then a context switch
*     // should be performed. The syntax required to perform a context switch
*     // from inside an ISR varies from port to port, and from compiler to
*     // compiler. Inspect the demos for the port you are using to find the
*     // actual syntax required.
*     if( xHigherPriorityTaskWoken != pdFALSE )
*     {
*         // Call the interrupt safe yield function here (actual function
*         // depends on the FreeRTOS port being used).
*     }
* }
*

```

### 参数

- **xTimer** -- The handle of the timer that is to be started, reset, or restarted.
- **pxHigherPriorityTaskWoken** -- The timer service/daemon task spends most of its time in the Blocked state, waiting for messages to arrive on the timer command queue. Calling xTimerResetFromISR() writes a message to the timer command queue, so has the potential to transition the timer service/daemon task out of the Blocked state. If calling xTimerResetFromISR() causes the timer service/daemon task to leave the Blocked state, and the timer service/ daemon task has a priority equal to or greater than the currently executing task (the task that was interrupted), then \*pxHigherPriorityTaskWoken will get set to pdTRUE internally within the xTimerResetFromISR() function. If xTimerResetFromISR() sets this value to pdTRUE then a context switch should be performed before the interrupt exits.

**返回** pdFAIL will be returned if the reset command could not be sent to the timer command queue. pdPASS will be returned if the command was successfully sent to the timer command queue. When the command is actually processed will depend on the priority of the timer service/daemon task relative to other tasks in the system, although the timers expiry time is relative to when xTimerResetFromISR() is actually called. The timer service/daemon task priority is set by the configTIMER\_TASK\_PRIORITY configuration constant.

### Type Definitions

```
typedef struct tmrTimerControl *TimerHandle_t
```

```
typedef void (*TimerCallbackFunction_t)(TimerHandle_t xTimer)
```

Defines the prototype to which timer callback functions must conform.

```
typedef void (*PendedFunction_t)(void*, uint32_t)
```

Defines the prototype to which functions used with the xTimerPendFunctionCallFromISR() function must conform.

### 事件组 API

#### Header File

- [components/freertos/FreeRTOS-Kernel/include/freertos/event\\_groups.h](#)
- This header file can be included with:

```
#include "freertos/event_groups.h"
```

## Functions

### *EventGroupHandle\_t* **xEventGroupCreate** (void)

Create a new event group.

Internally, within the FreeRTOS implementation, event groups use a [small] block of memory, in which the event group's structure is stored. If an event groups is created using `xEventGroupCreate()` then the required memory is automatically dynamically allocated inside the `xEventGroupCreate()` function. (see <https://www.FreeRTOS.org/a00111.html>). If an event group is created using `xEventGroupCreateStatic()` then the application writer must instead provide the memory that will get used by the event group. `xEventGroupCreateStatic()` therefore allows an event group to be created without using any dynamic memory allocation.

Although event groups are not related to ticks, for internal implementation reasons the number of bits available for use in an event group is dependent on the `configUSE_16_BIT_TICKS` setting in `FreeRTOSConfig.h`. If `configUSE_16_BIT_TICKS` is 1 then each event group contains 8 usable bits (bit 0 to bit 7). If `configUSE_16_BIT_TICKS` is set to 0 then each event group has 24 usable bits (bit 0 to bit 23). The `EventBits_t` type is used to store event bits within an event group.

Example usage:

```
// Declare a variable to hold the created event group.
EventGroupHandle_t xCreatedEventGroup;

// Attempt to create the event group.
xCreatedEventGroup = xEventGroupCreate();

// Was the event group created successfully?
if( xCreatedEventGroup == NULL )
{
    // The event group was not created because there was insufficient
    // FreeRTOS heap available.
}
else
{
    // The event group was created.
}
```

**返回** If the event group was created then a handle to the event group is returned. If there was insufficient FreeRTOS heap available to create the event group then NULL is returned. See <https://www.FreeRTOS.org/a00111.html>

### *EventGroupHandle\_t* **xEventGroupCreateStatic** (StaticEventGroup\_t \*pxEventGroupBuffer)

Create a new event group.

Internally, within the FreeRTOS implementation, event groups use a [small] block of memory, in which the event group's structure is stored. If an event groups is created using `xEventGroupCreate()` then the required memory is automatically dynamically allocated inside the `xEventGroupCreate()` function. (see <https://www.FreeRTOS.org/a00111.html>). If an event group is created using `xEventGroupCreateStatic()` then the application writer must instead provide the memory that will get used by the event group. `xEventGroupCreateStatic()` therefore allows an event group to be created without using any dynamic memory allocation.

Although event groups are not related to ticks, for internal implementation reasons the number of bits available for use in an event group is dependent on the `configUSE_16_BIT_TICKS` setting in `FreeRTOSConfig.h`. If `configUSE_16_BIT_TICKS` is 1 then each event group contains 8 usable bits (bit 0 to bit 7). If `configUSE_16_BIT_TICKS` is set to 0 then each event group has 24 usable bits (bit 0 to bit 23). The `EventBits_t` type is used to store event bits within an event group.

Example usage:

```
// StaticEventGroup_t is a publicly accessible structure that has the same
// size and alignment requirements as the real event group structure. It is
// provided as a mechanism for applications to know the size of the event
// group (which is dependent on the architecture and configuration file
// settings) without breaking the strict data hiding policy by exposing the
// real event group internals. This StaticEventGroup_t variable is passed
// into the xSemaphoreCreateEventGroupStatic() function and is used to store
// the event group's data structures
StaticEventGroup_t xEventGroupBuffer;

// Create the event group without dynamically allocating any memory.
xEventGroup = xEventGroupCreateStatic( &xEventGroupBuffer );
```

**参数 pxEventGroupBuffer** -- pxEventGroupBuffer must point to a variable of type StaticEventGroup\_t, which will be then be used to hold the event group's data structures, removing the need for the memory to be allocated dynamically.

**返回** If the event group was created then a handle to the event group is returned. If pxEventGroupBuffer was NULL then NULL is returned.

**EventBits\_t xEventGroupWaitBits** (*EventGroupHandle\_t* xEventGroup, const *EventBits\_t* uxBitsToWaitFor, const *BaseType\_t* xClearOnExit, const *BaseType\_t* xWaitForAllBits, *TickType\_t* xTicksToWait)

[Potentially] block to wait for one or more bits to be set within a previously created event group.

This function cannot be called from an interrupt.

Example usage:

```
#define BIT_0 ( 1 << 0 )
#define BIT_4 ( 1 << 4 )

void aFunction( EventGroupHandle_t xEventGroup )
{
EventBits_t uxBits;
const TickType_t xTicksToWait = 100 / portTICK_PERIOD_MS;

// Wait a maximum of 100ms for either bit 0 or bit 4 to be set within
// the event group. Clear the bits before exiting.
uxBits = xEventGroupWaitBits(
    xEventGroup,      // The event group being tested.
    BIT_0 | BIT_4,   // The bits within the event group to wait_
    ↪for.
    pdTRUE,          // BIT_0 and BIT_4 should be cleared before_
    ↪returning.
    pdFALSE,        // Don't wait for both bits, either bit will_
    ↪do.
    xTicksToWait ); // Wait a maximum of 100ms for either bit to_
    ↪be set.

if( ( uxBits & ( BIT_0 | BIT_4 ) ) == ( BIT_0 | BIT_4 ) )
{
// xEventGroupWaitBits() returned because both bits were set.
}
else if( ( uxBits & BIT_0 ) != 0 )
{
// xEventGroupWaitBits() returned because just BIT_0 was set.
}
else if( ( uxBits & BIT_4 ) != 0 )
```

(下页继续)

```

    {
// xEventGroupWaitBits() returned because just BIT_4 was set.
    }
else
    {
// xEventGroupWaitBits() returned because xTicksToWait ticks passed
// without either BIT_0 or BIT_4 becoming set.
    }
}

```

**参数**

- **xEventGroup** -- The event group in which the bits are being tested. The event group must have previously been created using a call to xEventGroupCreate().
- **uxBitsToWaitFor** -- A bitwise value that indicates the bit or bits to test inside the event group. For example, to wait for bit 0 and/or bit 2 set uxBitsToWaitFor to 0x05. To wait for bits 0 and/or bit 1 and/or bit 2 set uxBitsToWaitFor to 0x07. Etc.
- **xClearOnExit** -- If xClearOnExit is set to pdTRUE then any bits within uxBitsToWaitFor that are set within the event group will be cleared before xEventGroupWaitBits() returns if the wait condition was met (if the function returns for a reason other than a timeout). If xClearOnExit is set to pdFALSE then the bits set in the event group are not altered when the call to xEventGroupWaitBits() returns.
- **xWaitForAllBits** -- If xWaitForAllBits is set to pdTRUE then xEventGroupWaitBits() will return when either all the bits in uxBitsToWaitFor are set or the specified block time expires. If xWaitForAllBits is set to pdFALSE then xEventGroupWaitBits() will return when any one of the bits set in uxBitsToWaitFor is set or the specified block time expires. The block time is specified by the xTicksToWait parameter.
- **xTicksToWait** -- The maximum amount of time (specified in 'ticks') to wait for one/all (depending on the xWaitForAllBits value) of the bits specified by uxBitsToWaitFor to become set. A value of portMAX\_DELAY can be used to block indefinitely (provided INCLUDE\_vTaskSuspend is set to 1 in FreeRTOSConfig.h).

**返回** The value of the event group at the time either the bits being waited for became set, or the block time expired. Test the return value to know which bits were set. If xEventGroupWaitBits() returned because its timeout expired then not all the bits being waited for will be set. If xEventGroupWaitBits() returned because the bits it was waiting for were set then the returned value is the event group value before any bits were automatically cleared in the case that xClearOnExit parameter was set to pdTRUE.

**EventBits\_t xEventGroupClearBits** (*EventGroupHandle\_t* xEventGroup, const *EventBits\_t* uxBitsToClear)

Clear bits within an event group. This function cannot be called from an interrupt.

Example usage:

```

#define BIT_0 ( 1 << 0 )
#define BIT_4 ( 1 << 4 )

void aFunction( EventGroupHandle_t xEventGroup )
{
EventBits_t uxBits;

// Clear bit 0 and bit 4 in xEventGroup.
    uxBits = xEventGroupClearBits(
                xEventGroup,    // The event group being updated.
                BIT_0 | BIT_4 ); // The bits being cleared.

if( ( uxBits & ( BIT_0 | BIT_4 ) ) == ( BIT_0 | BIT_4 ) )
    {

```

(下页继续)

```

// Both bit 0 and bit 4 were set before xEventGroupClearBits() was
// called. Both will now be clear (not set).
}
else if( ( uxBits & BIT_0 ) != 0 )
{
// Bit 0 was set before xEventGroupClearBits() was called. It will
// now be clear.
}
else if( ( uxBits & BIT_4 ) != 0 )
{
// Bit 4 was set before xEventGroupClearBits() was called. It will
// now be clear.
}
else
{
// Neither bit 0 nor bit 4 were set in the first place.
}
}

```

**参数**

- **xEventGroup** -- The event group in which the bits are to be cleared.
- **uxBitsToClear** -- A bitwise value that indicates the bit or bits to clear in the event group. For example, to clear bit 3 only, set uxBitsToClear to 0x08. To clear bit 3 and bit 0 set uxBitsToClear to 0x09.

**返回** The value of the event group before the specified bits were cleared.

**EventBits\_t xEventGroupSetBits** (*EventGroupHandle\_t* xEventGroup, const *EventBits\_t* uxBitsToSet)

Set bits within an event group. This function cannot be called from an interrupt. xEventGroupSetBitsFromISR() is a version that can be called from an interrupt.

Setting bits in an event group will automatically unblock tasks that are blocked waiting for the bits.

Example usage:

```

#define BIT_0 ( 1 << 0 )
#define BIT_4 ( 1 << 4 )

void aFunction( EventGroupHandle_t xEventGroup )
{
EventBits_t uxBits;

// Set bit 0 and bit 4 in xEventGroup.
uxBits = xEventGroupSetBits(
            xEventGroup,    // The event group being updated.
            BIT_0 | BIT_4 ); // The bits being set.

if( ( uxBits & ( BIT_0 | BIT_4 ) ) == ( BIT_0 | BIT_4 ) )
{
// Both bit 0 and bit 4 remained set when the function returned.
}
else if( ( uxBits & BIT_0 ) != 0 )
{
// Bit 0 remained set when the function returned, but bit 4 was
// cleared. It might be that bit 4 was cleared automatically as a
// task that was waiting for bit 4 was removed from the Blocked
// state.
}
else if( ( uxBits & BIT_4 ) != 0 )

```

(下页继续)



```

    {
// Bit 4 remained set when the function returned, but bit 0 was
// cleared. It might be that bit 0 was cleared automatically as a
// task that was waiting for bit 0 was removed from the Blocked
// state.
    }
else
{
// Neither bit 0 nor bit 4 remained set. It might be that a task
// was waiting for both of the bits to be set, and the bits were
// cleared as the task left the Blocked state.
}
}

```

**参数**

- **xEventGroup** -- The event group in which the bits are to be set.
- **uxBitsToSet** -- A bitwise value that indicates the bit or bits to set. For example, to set bit 3 only, set uxBitsToSet to 0x08. To set bit 3 and bit 0 set uxBitsToSet to 0x09.

**返回** The value of the event group at the time the call to xEventGroupSetBits() returns. There are two reasons why the returned value might have the bits specified by the uxBitsToSet parameter cleared. First, if setting a bit results in a task that was waiting for the bit leaving the blocked state then it is possible the bit will be cleared automatically (see the xClearBitOnExit parameter of xEventGroupWaitBits()). Second, any unblocked (or otherwise Ready state) task that has a priority above that of the task that called xEventGroupSetBits() will execute and may change the event group value before the call to xEventGroupSetBits() returns.

**EventBits\_t xEventGroupSync** (*EventGroupHandle\_t* xEventGroup, const *EventBits\_t* uxBitsToSet, const *EventBits\_t* uxBitsToWaitFor, *TickType\_t* xTicksToWait)

Atomically set bits within an event group, then wait for a combination of bits to be set within the same event group. This functionality is typically used to synchronise multiple tasks, where each task has to wait for the other tasks to reach a synchronisation point before proceeding.

This function cannot be used from an interrupt.

The function will return before its block time expires if the bits specified by the uxBitsToWait parameter are set, or become set within that time. In this case all the bits specified by uxBitsToWait will be automatically cleared before the function returns.

Example usage:

```

// Bits used by the three tasks.
#define TASK_0_BIT      ( 1 << 0 )
#define TASK_1_BIT      ( 1 << 1 )
#define TASK_2_BIT      ( 1 << 2 )

#define ALL_SYNC_BITS ( TASK_0_BIT | TASK_1_BIT | TASK_2_BIT )

// Use an event group to synchronise three tasks. It is assumed this event
// group has already been created elsewhere.
EventGroupHandle_t xEventBits;

void vTask0( void *pvParameters )
{
EventBits_t uxReturn;
TickType_t xTicksToWait = 100 / portTICK_PERIOD_MS;

for( ;; )
{

```

(下页继续)

```

// Perform task functionality here.

// Set bit 0 in the event flag to note this task has reached the
// sync point. The other two tasks will set the other two bits defined
// by ALL_SYNC_BITS. All three tasks have reached the synchronisation
// point when all the ALL_SYNC_BITS are set. Wait a maximum of 100ms
// for this to happen.
    uxReturn = xEventGroupSync( xEventBits, TASK_0_BIT, ALL_SYNC_BITS,
↪xTicksToWait );

if( ( uxReturn & ALL_SYNC_BITS ) == ALL_SYNC_BITS )
{
    // All three tasks reached the synchronisation point before the call
    // to xEventGroupSync() timed out.
}
}

void vTask1( void *pvParameters )
{
    for( ;; )
    {
        // Perform task functionality here.

        // Set bit 1 in the event flag to note this task has reached the
        // synchronisation point. The other two tasks will set the other two
        // bits defined by ALL_SYNC_BITS. All three tasks have reached the
        // synchronisation point when all the ALL_SYNC_BITS are set. Wait
        // indefinitely for this to happen.
        xEventGroupSync( xEventBits, TASK_1_BIT, ALL_SYNC_BITS, portMAX_DELAY );

        // xEventGroupSync() was called with an indefinite block time, so
        // this task will only reach here if the synchronisation was made by all
        // three tasks, so there is no need to test the return value.
    }
}

void vTask2( void *pvParameters )
{
    for( ;; )
    {
        // Perform task functionality here.

        // Set bit 2 in the event flag to note this task has reached the
        // synchronisation point. The other two tasks will set the other two
        // bits defined by ALL_SYNC_BITS. All three tasks have reached the
        // synchronisation point when all the ALL_SYNC_BITS are set. Wait
        // indefinitely for this to happen.
        xEventGroupSync( xEventBits, TASK_2_BIT, ALL_SYNC_BITS, portMAX_DELAY );

        // xEventGroupSync() was called with an indefinite block time, so
        // this task will only reach here if the synchronisation was made by all
        // three tasks, so there is no need to test the return value.
    }
}

```

### 参数

- **xEventGroup** -- The event group in which the bits are being tested. The event group must have previously been created using a call to `xEventGroupCreate()`.
- **uxBitsToSet** -- The bits to set in the event group before determining if, and possibly waiting for, all the bits specified by the `uxBitsToWait` parameter are set.

- **uxBitsToWaitFor** -- A bitwise value that indicates the bit or bits to test inside the event group. For example, to wait for bit 0 and bit 2 set uxBitsToWaitFor to 0x05. To wait for bits 0 and bit 1 and bit 2 set uxBitsToWaitFor to 0x07. Etc.
- **xTicksToWait** -- The maximum amount of time (specified in 'ticks') to wait for all of the bits specified by uxBitsToWaitFor to become set.

**返回** The value of the event group at the time either the bits being waited for became set, or the block time expired. Test the return value to know which bits were set. If xEventGroupSync() returned because its timeout expired then not all the bits being waited for will be set. If xEventGroupSync() returned because all the bits it was waiting for were set then the returned value is the event group value before any bits were automatically cleared.

*EventBits\_t* **xEventGroupGetBitsFromISR** (*EventGroupHandle\_t* xEventGroup)

A version of xEventGroupGetBits() that can be called from an ISR.

**参数** **xEventGroup** -- The event group being queried.

**返回** The event group bits at the time xEventGroupGetBitsFromISR() was called.

void **vEventGroupDelete** (*EventGroupHandle\_t* xEventGroup)

Delete an event group that was previously created by a call to xEventGroupCreate(). Tasks that are blocked on the event group will be unblocked and obtain 0 as the event group's value.

**参数** **xEventGroup** -- The event group being deleted.

BaseType\_t **xEventGroupGetStaticBuffer** (*EventGroupHandle\_t* xEventGroup, StaticEventGroup\_t  
\*\*ppxEventGroupBuffer)

Retrieve a pointer to a statically created event groups's data structure buffer. It is the same buffer that is supplied at the time of creation.

**参数**

- **xEventGroup** -- The event group for which to retrieve the buffer.
- **ppxEventGroupBuffer** -- Used to return a pointer to the event groups's data structure buffer.

**返回** pdTRUE if the buffer was retrieved, pdFALSE otherwise.

## Macros

**xEventGroupClearBitsFromISR** (xEventGroup, uxBitsToClear)

A version of xEventGroupClearBits() that can be called from an interrupt.

Setting bits in an event group is not a deterministic operation because there are an unknown number of tasks that may be waiting for the bit or bits being set. FreeRTOS does not allow nondeterministic operations to be performed while interrupts are disabled, so protects event groups that are accessed from tasks by suspending the scheduler rather than disabling interrupts. As a result event groups cannot be accessed directly from an interrupt service routine. Therefore xEventGroupClearBitsFromISR() sends a message to the timer task to have the clear operation performed in the context of the timer task.

Example usage:

```
#define BIT_0 ( 1 << 0 )
#define BIT_4 ( 1 << 4 )

// An event group which it is assumed has already been created by a call to
// xEventGroupCreate().
EventGroupHandle_t xEventGroup;

void anInterruptHandler( void )
{
// Clear bit 0 and bit 4 in xEventGroup.
    xResult = xEventGroupClearBitsFromISR(
                xEventGroup, // The event group being updated.
```

(下页继续)

```

        BIT_0 | BIT_4 ); // The bits being set.

if( xResult == pdPASS )
    {
    // The message was posted successfully.
    portYIELD_FROM_ISR(pdTRUE);
    }
}

```

**备注:** If this function returns `pdPASS` then the timer task is ready to run and a `portYIELD_FROM_ISR(pdTRUE)` should be executed to perform the needed clear on the event group. This behavior is different from `xEventGroupSetBitsFromISR` because the parameter `xHigherPriorityTaskWoken` is not present.

#### 参数

- **xEventGroup** -- The event group in which the bits are to be cleared.
- **uxBitsToClear** -- A bitwise value that indicates the bit or bits to clear. For example, to clear bit 3 only, set `uxBitsToClear` to `0x08`. To clear bit 3 and bit 0 set `uxBitsToClear` to `0x09`.

**返回** If the request to execute the function was posted successfully then `pdPASS` is returned, otherwise `pdFALSE` is returned. `pdFALSE` will be returned if the timer service queue was full.

#### **xEventGroupSetBitsFromISR** (xEventGroup, uxBitsToSet, pxHigherPriorityTaskWoken)

A version of `xEventGroupSetBits()` that can be called from an interrupt.

Setting bits in an event group is not a deterministic operation because there are an unknown number of tasks that may be waiting for the bit or bits being set. FreeRTOS does not allow nondeterministic operations to be performed in interrupts or from critical sections. Therefore `xEventGroupSetBitsFromISR()` sends a message to the timer task to have the set operation performed in the context of the timer task - where a scheduler lock is used in place of a critical section.

Example usage:

```

#define BIT_0 ( 1 << 0 )
#define BIT_4 ( 1 << 4 )

// An event group which it is assumed has already been created by a call to
// xEventGroupCreate().
EventGroupHandle_t xEventGroup;

void anInterruptHandler( void )
{
    BaseType_t xHigherPriorityTaskWoken, xResult;

    // xHigherPriorityTaskWoken must be initialised to pdFALSE.
    xHigherPriorityTaskWoken = pdFALSE;

    // Set bit 0 and bit 4 in xEventGroup.
    xResult = xEventGroupSetBitsFromISR(
        xEventGroup, // The event group being updated.
        BIT_0 | BIT_4 // The bits being set.
        &xHigherPriorityTaskWoken );

    // Was the message posted successfully?
    if( xResult == pdPASS )
    {
        // If xHigherPriorityTaskWoken is now set to pdTRUE then a context

```

(下页继续)

```

// switch should be requested. The macro used is port specific and
// will be either portYIELD_FROM_ISR() or portEND_SWITCHING_ISR() -
// refer to the documentation page for the port being used.
    portYIELD_FROM_ISR( xHigherPriorityTaskWoken );
}
}

```

**参数**

- **xEventGroup** -- The event group in which the bits are to be set.
- **uxBitsToSet** -- A bitwise value that indicates the bit or bits to set. For example, to set bit 3 only, set uxBitsToSet to 0x08. To set bit 3 and bit 0 set uxBitsToSet to 0x09.
- **pxHigherPriorityTaskWoken** -- As mentioned above, calling this function will result in a message being sent to the timer daemon task. If the priority of the timer daemon task is higher than the priority of the currently running task (the task the interrupt interrupted) then \*pxHigherPriorityTaskWoken will be set to pdTRUE by xEventGroupSetBitsFromISR(), indicating that a context switch should be requested before the interrupt exits. For that reason \*pxHigherPriorityTaskWoken must be initialised to pdFALSE. See the example code below.

**返回** If the request to execute the function was posted successfully then pdPASS is returned, otherwise pdFALSE is returned. pdFALSE will be returned if the timer service queue was full.

**xEventGroupGetBits** (xEventGroup)

Returns the current value of the bits in an event group. This function cannot be used from an interrupt.

**参数**

- **xEventGroup** -- The event group being queried.

**返回** The event group bits at the time xEventGroupGetBits() was called.

**Type Definitions**

```
typedef struct EventGroupDef_t *EventGroupHandle_t
```

```
typedef TickType_t EventBits_t
```

**流缓冲区 API****Header File**

- `components/freertos/FreeRTOS-Kernel/include/freertos/stream_buffer.h`
- This header file can be included with:

```
#include "freertos/stream_buffer.h"
```

**Functions**

```
BaseType_t xStreamBufferGetStaticBuffers (StreamBufferHandle_t xStreamBuffer, uint8_t
                                         **ppucStreamBufferStorageArea, StaticStreamBuffer_t
                                         **ppxStaticStreamBuffer)
```

Retrieve pointers to a statically created stream buffer's data structure buffer and storage area buffer. These are the same buffers that are supplied at the time of creation.

**参数**

- **xStreamBuffer** -- The stream buffer for which to retrieve the buffers.
- **ppucStreamBufferStorageArea** -- Used to return a pointer to the stream buffer's storage area buffer.

- **ppxStaticStreamBuffer** -- Used to return a pointer to the stream buffer's data structure buffer.

返回 pdTRUE if buffers were retrieved, pdFALSE otherwise.

size\_t **xStreamBufferSend** (*StreamBufferHandle\_t* xStreamBuffer, const void \*pvTxData, size\_t xDataLengthBytes, TickType\_t xTicksToWait)

Sends bytes to a stream buffer. The bytes are copied into the stream buffer.

**NOTE:** Uniquely among FreeRTOS objects, the stream buffer implementation (so also the message buffer implementation, as message buffers are built on top of stream buffers) assumes there is only one task or interrupt that will write to the buffer (the writer), and only one task or interrupt that will read from the buffer (the reader). It is safe for the writer and reader to be different tasks or interrupts, but, unlike other FreeRTOS objects, it is not safe to have multiple different writers or multiple different readers. If there are to be multiple different writers then the application writer must place each call to a writing API function (such as xStreamBufferSend()) inside a critical section and set the send block time to 0. Likewise, if there are to be multiple different readers then the application writer must place each call to a reading API function (such as xStreamBufferReceive()) inside a critical section and set the receive block time to 0.

Use xStreamBufferSend() to write to a stream buffer from a task. Use xStreamBufferSendFromISR() to write to a stream buffer from an interrupt service routine (ISR).

Example use:

```
void vAFunction( StreamBufferHandle_t xStreamBuffer )
{
    size_t xBytesSent;
    uint8_t ucArrayToSend[] = { 0, 1, 2, 3 };
    char *pcStringToSend = "String to send";
    const TickType_t x100ms = pdMS_TO_TICKS( 100 );

    // Send an array to the stream buffer, blocking for a maximum of 100ms to
    // wait for enough space to be available in the stream buffer.
    xBytesSent = xStreamBufferSend( xStreamBuffer, ( void * ) ucArrayToSend,
    ↪ sizeof( ucArrayToSend ), x100ms );

    if( xBytesSent != sizeof( ucArrayToSend ) )
    {
        // The call to xStreamBufferSend() times out before there was enough
        // space in the buffer for the data to be written, but it did
        // successfully write xBytesSent bytes.
    }

    // Send the string to the stream buffer. Return immediately if there is not
    // enough space in the buffer.
    xBytesSent = xStreamBufferSend( xStreamBuffer, ( void * ) pcStringToSend,
    ↪ strlen( pcStringToSend ), 0 );

    if( xBytesSent != strlen( pcStringToSend ) )
    {
        // The entire string could not be added to the stream buffer because
        // there was not enough free space in the buffer, but xBytesSent bytes
        // were sent. Could try again to send the remaining bytes.
    }
}
```

### 参数

- **xStreamBuffer** -- The handle of the stream buffer to which a stream is being sent.
- **pvTxData** -- A pointer to the buffer that holds the bytes to be copied into the stream buffer.
- **xDataLengthBytes** -- The maximum number of bytes to copy from pvTxData into the stream buffer.

- **xTicksToWait** -- The maximum amount of time the task should remain in the Blocked state to wait for enough space to become available in the stream buffer, should the stream buffer contain too little space to hold the another xDataLengthBytes bytes. The block time is specified in tick periods, so the absolute time it represents is dependent on the tick frequency. The macro pdMS\_TO\_TICKS() can be used to convert a time specified in milliseconds into a time specified in ticks. Setting xTicksToWait to port-MAX\_DELAY will cause the task to wait indefinitely (without timing out), provided INCLUDE\_vTaskSuspend is set to 1 in FreeRTOSConfig.h. If a task times out before it can write all xDataLengthBytes into the buffer it will still write as many bytes as possible. A task does not use any CPU time when it is in the blocked state.

**返回** The number of bytes written to the stream buffer. If a task times out before it can write all xDataLengthBytes into the buffer it will still write as many bytes as possible.

size\_t **xStreamBufferSendFromISR** (*StreamBufferHandle\_t* xStreamBuffer, const void \*pvTxData, size\_t xDataLengthBytes, BaseType\_t \*const pxHigherPriorityTaskWoken)

Interrupt safe version of the API function that sends a stream of bytes to the stream buffer.

**NOTE:** Uniquely among FreeRTOS objects, the stream buffer implementation (so also the message buffer implementation, as message buffers are built on top of stream buffers) assumes there is only one task or interrupt that will write to the buffer (the writer), and only one task or interrupt that will read from the buffer (the reader). It is safe for the writer and reader to be different tasks or interrupts, but, unlike other FreeRTOS objects, it is not safe to have multiple different writers or multiple different readers. If there are to be multiple different writers then the application writer must place each call to a writing API function (such as xStreamBufferSend()) inside a critical section and set the send block time to 0. Likewise, if there are to be multiple different readers then the application writer must place each call to a reading API function (such as xStreamBufferReceive()) inside a critical section and set the receive block time to 0.

Use xStreamBufferSend() to write to a stream buffer from a task. Use xStreamBufferSendFromISR() to write to a stream buffer from an interrupt service routine (ISR).

Example use:

```
// A stream buffer that has already been created.
StreamBufferHandle_t xStreamBuffer;

void vAnInterruptServiceRoutine( void )
{
    size_t xBytesSent;
    char *pcStringToSend = "String to send";
    BaseType_t xHigherPriorityTaskWoken = pdFALSE; // Initialised to pdFALSE.

    // Attempt to send the string to the stream buffer.
    xBytesSent = xStreamBufferSendFromISR( xStreamBuffer,
                                           ( void * ) pcStringToSend,
                                           strlen( pcStringToSend ),
                                           &xHigherPriorityTaskWoken );

    if( xBytesSent != strlen( pcStringToSend ) )
    {
        // There was not enough free space in the stream buffer for the entire
        // string to be written, ut xBytesSent bytes were written.
    }

    // If xHigherPriorityTaskWoken was set to pdTRUE inside
    // xStreamBufferSendFromISR() then a task that has a priority above the
    // priority of the currently executing task was unblocked and a context
    // switch should be performed to ensure the ISR returns to the unblocked
    // task. In most FreeRTOS ports this is done by simply passing
    // xHigherPriorityTaskWoken into portYIELD_FROM_ISR(), which will test the
```

(下页继续)



(续上页)

```
// variables value, and perform the context switch if necessary. Check the
// documentation for the port in use for port specific instructions.
portYIELD_FROM_ISR( xHigherPriorityTaskWoken );
}
```

**参数**

- **xStreamBuffer** -- The handle of the stream buffer to which a stream is being sent.
- **pvTxData** -- A pointer to the data that is to be copied into the stream buffer.
- **xDataLengthBytes** -- The maximum number of bytes to copy from pvTxData into the stream buffer.
- **pxHigherPriorityTaskWoken** -- It is possible that a stream buffer will have a task blocked on it waiting for data. Calling xStreamBufferSendFromISR() can make data available, and so cause a task that was waiting for data to leave the Blocked state. If calling xStreamBufferSendFromISR() causes a task to leave the Blocked state, and the unblocked task has a priority higher than the currently executing task (the task that was interrupted), then, internally, xStreamBufferSendFromISR() will set \*pxHigherPriorityTaskWoken to pdTRUE. If xStreamBufferSendFromISR() sets this value to pdTRUE, then normally a context switch should be performed before the interrupt is exited. This will ensure that the interrupt returns directly to the highest priority Ready state task. \*pxHigherPriorityTaskWoken should be set to pdFALSE before it is passed into the function. See the example code below for an example.

**返回** The number of bytes actually written to the stream buffer, which will be less than xDataLengthBytes if the stream buffer didn't have enough free space for all the bytes to be written.

size\_t **xStreamBufferReceive** (*StreamBufferHandle\_t* xStreamBuffer, void \*pvRxData, size\_t xBufferLengthBytes, TickType\_t xTicksToWait)

Receives bytes from a stream buffer.

**NOTE:** Uniquely among FreeRTOS objects, the stream buffer implementation (so also the message buffer implementation, as message buffers are built on top of stream buffers) assumes there is only one task or interrupt that will write to the buffer (the writer), and only one task or interrupt that will read from the buffer (the reader). It is safe for the writer and reader to be different tasks or interrupts, but, unlike other FreeRTOS objects, it is not safe to have multiple different writers or multiple different readers. If there are to be multiple different writers then the application writer must place each call to a writing API function (such as xStreamBufferSend()) inside a critical section and set the send block time to 0. Likewise, if there are to be multiple different readers then the application writer must place each call to a reading API function (such as xStreamBufferReceive()) inside a critical section and set the receive block time to 0.

Use xStreamBufferReceive() to read from a stream buffer from a task. Use xStreamBufferReceiveFromISR() to read from a stream buffer from an interrupt service routine (ISR).

Example use:

```
void vAFunction( StreamBuffer_t xStreamBuffer )
{
    uint8_t ucRxData[ 20 ];
    size_t xReceivedBytes;
    const TickType_t xBlockTime = pdMS_TO_TICKS( 20 );

    // Receive up to another sizeof( ucRxData ) bytes from the stream buffer.
    // Wait in the Blocked state (so not using any CPU processing time) for a
    // maximum of 100ms for the full sizeof( ucRxData ) number of bytes to be
    // available.
    xReceivedBytes = xStreamBufferReceive( xStreamBuffer,
                                          ( void * ) ucRxData,
                                          sizeof( ucRxData ),
                                          xBlockTime );
}
```

(下页继续)



```

if( xReceivedBytes > 0 )
{
// A ucRxData contains another xReceivedBytes bytes of data, which can
// be processed here....
}
}

```

**参数**

- **xStreamBuffer** -- The handle of the stream buffer from which bytes are to be received.
- **pvRxData** -- A pointer to the buffer into which the received bytes will be copied.
- **xBufferLengthBytes** -- The length of the buffer pointed to by the pvRxData parameter. This sets the maximum number of bytes to receive in one call. xStreamBufferReceive will return as many bytes as possible up to a maximum set by xBufferLengthBytes.
- **xTicksToWait** -- The maximum amount of time the task should remain in the Blocked state to wait for data to become available if the stream buffer is empty. xStreamBufferReceive() will return immediately if xTicksToWait is zero. The block time is specified in tick periods, so the absolute time it represents is dependent on the tick frequency. The macro pdMS\_TO\_TICKS() can be used to convert a time specified in milliseconds into a time specified in ticks. Setting xTicksToWait to portMAX\_DELAY will cause the task to wait indefinitely (without timing out), provided INCLUDE\_vTaskSuspend is set to 1 in FreeRTOSConfig.h. A task does not use any CPU time when it is in the Blocked state.

**返回** The number of bytes actually read from the stream buffer, which will be less than xBufferLengthBytes if the call to xStreamBufferReceive() timed out before xBufferLengthBytes were available.

size\_t **xStreamBufferReceiveFromISR** (*StreamBufferHandle\_t* xStreamBuffer, void \*pvRxData, size\_t xBufferLengthBytes, BaseType\_t \*const pxHigherPriorityTaskWoken)

An interrupt safe version of the API function that receives bytes from a stream buffer.

Use xStreamBufferReceive() to read bytes from a stream buffer from a task. Use xStreamBufferReceiveFromISR() to read bytes from a stream buffer from an interrupt service routine (ISR).

Example use:

```

// A stream buffer that has already been created.
StreamBuffer_t xStreamBuffer;

void vAnInterruptServiceRoutine( void )
{
uint8_t ucRxData[ 20 ];
size_t xReceivedBytes;
BaseType_t xHigherPriorityTaskWoken = pdFALSE; // Initialised to pdFALSE.

// Receive the next stream from the stream buffer.
xReceivedBytes = xStreamBufferReceiveFromISR( xStreamBuffer,
( void * ) ucRxData,
sizeof( ucRxData ),
&xHigherPriorityTaskWoken );

if( xReceivedBytes > 0 )
{
// ucRxData contains xReceivedBytes read from the stream buffer.
// Process the stream here....
}
}

```

(下页继续)

```

// If xHigherPriorityTaskWoken was set to pdTRUE inside
// xStreamBufferReceiveFromISR() then a task that has a priority above the
// priority of the currently executing task was unblocked and a context
// switch should be performed to ensure the ISR returns to the unblocked
// task. In most FreeRTOS ports this is done by simply passing
// xHigherPriorityTaskWoken into portYIELD_FROM_ISR(), which will test the
// variables value, and perform the context switch if necessary. Check the
// documentation for the port in use for port specific instructions.
portYIELD_FROM_ISR( xHigherPriorityTaskWoken );
}

```

**参数**

- **xStreamBuffer** -- The handle of the stream buffer from which a stream is being received.
- **pvRxData** -- A pointer to the buffer into which the received bytes are copied.
- **xBufferLengthBytes** -- The length of the buffer pointed to by the pvRxData parameter. This sets the maximum number of bytes to receive in one call. xStreamBufferReceive will return as many bytes as possible up to a maximum set by xBufferLengthBytes.
- **pxHigherPriorityTaskWoken** -- It is possible that a stream buffer will have a task blocked on it waiting for space to become available. Calling xStreamBufferReceiveFromISR() can make space available, and so cause a task that is waiting for space to leave the Blocked state. If calling xStreamBufferReceiveFromISR() causes a task to leave the Blocked state, and the unblocked task has a priority higher than the currently executing task (the task that was interrupted), then, internally, xStreamBufferReceiveFromISR() will set \*pxHigherPriorityTaskWoken to pdTRUE. If xStreamBufferReceiveFromISR() sets this value to pdTRUE, then normally a context switch should be performed before the interrupt is exited. That will ensure the interrupt returns directly to the highest priority Ready state task. \*pxHigherPriorityTaskWoken should be set to pdFALSE before it is passed into the function. See the code example below for an example.

**返回** The number of bytes read from the stream buffer, if any.

void **vStreamBufferDelete** (*StreamBufferHandle\_t* xStreamBuffer)

Deletes a stream buffer that was previously created using a call to xStreamBufferCreate() or xStreamBufferCreateStatic(). If the stream buffer was created using dynamic memory (that is, by xStreamBufferCreate()), then the allocated memory is freed.

A stream buffer handle must not be used after the stream buffer has been deleted.

**参数 xStreamBuffer** -- The handle of the stream buffer to be deleted.

BaseType\_t **xStreamBufferIsFull** (*StreamBufferHandle\_t* xStreamBuffer)

Queries a stream buffer to see if it is full. A stream buffer is full if it does not have any free space, and therefore cannot accept any more data.

**参数 xStreamBuffer** -- The handle of the stream buffer being queried.

**返回** If the stream buffer is full then pdTRUE is returned. Otherwise pdFALSE is returned.

BaseType\_t **xStreamBufferIsEmpty** (*StreamBufferHandle\_t* xStreamBuffer)

Queries a stream buffer to see if it is empty. A stream buffer is empty if it does not contain any data.

**参数 xStreamBuffer** -- The handle of the stream buffer being queried.

**返回** If the stream buffer is empty then pdTRUE is returned. Otherwise pdFALSE is returned.

BaseType\_t **xStreamBufferReset** (*StreamBufferHandle\_t* xStreamBuffer)

Resets a stream buffer to its initial, empty, state. Any data that was in the stream buffer is discarded. A stream buffer can only be reset if there are no tasks blocked waiting to either send to or receive from the stream buffer.

**参数 xStreamBuffer** -- The handle of the stream buffer being reset.

**返回** If the stream buffer is reset then pdPASS is returned. If there was a task blocked waiting to send to or read from the stream buffer then the stream buffer is not reset and pdFAIL is returned.

size\_t **xStreamBufferSpacesAvailable** (*StreamBufferHandle\_t* xStreamBuffer)

Queries a stream buffer to see how much free space it contains, which is equal to the amount of data that can be sent to the stream buffer before it is full.

**参数 xStreamBuffer** -- The handle of the stream buffer being queried.

**返回** The number of bytes that can be written to the stream buffer before the stream buffer would be full.

size\_t **xStreamBufferBytesAvailable** (*StreamBufferHandle\_t* xStreamBuffer)

Queries a stream buffer to see how much data it contains, which is equal to the number of bytes that can be read from the stream buffer before the stream buffer would be empty.

**参数 xStreamBuffer** -- The handle of the stream buffer being queried.

**返回** The number of bytes that can be read from the stream buffer before the stream buffer would be empty.

BaseType\_t **xStreamBufferSetTriggerLevel** (*StreamBufferHandle\_t* xStreamBuffer, size\_t xTriggerLevel)

A stream buffer's trigger level is the number of bytes that must be in the stream buffer before a task that is blocked on the stream buffer to wait for data is moved out of the blocked state. For example, if a task is blocked on a read of an empty stream buffer that has a trigger level of 1 then the task will be unblocked when a single byte is written to the buffer or the task's block time expires. As another example, if a task is blocked on a read of an empty stream buffer that has a trigger level of 10 then the task will not be unblocked until the stream buffer contains at least 10 bytes or the task's block time expires. If a reading task's block time expires before the trigger level is reached then the task will still receive however many bytes are actually available. Setting a trigger level of 0 will result in a trigger level of 1 being used. It is not valid to specify a trigger level that is greater than the buffer size.

A trigger level is set when the stream buffer is created, and can be modified using xStreamBufferSetTriggerLevel().

**参数**

- **xStreamBuffer** -- The handle of the stream buffer being updated.
- **xTriggerLevel** -- The new trigger level for the stream buffer.

**返回** If xTriggerLevel was less than or equal to the stream buffer's length then the trigger level will be updated and pdTRUE is returned. Otherwise pdFALSE is returned.

BaseType\_t **xStreamBufferSendCompletedFromISR** (*StreamBufferHandle\_t* xStreamBuffer, BaseType\_t \*pxHigherPriorityTaskWoken)

For advanced users only.

The sbSEND\_COMPLETED() macro is called from within the FreeRTOS APIs when data is sent to a message buffer or stream buffer. If there was a task that was blocked on the message or stream buffer waiting for data to arrive then the sbSEND\_COMPLETED() macro sends a notification to the task to remove it from the Blocked state. xStreamBufferSendCompletedFromISR() does the same thing. It is provided to enable application writers to implement their own version of sbSEND\_COMPLETED(), and MUST NOT BE USED AT ANY OTHER TIME.

See the example implemented in FreeRTOS/Demo/Minimal/MessageBufferAMP.c for additional information.

**参数**

- **xStreamBuffer** -- The handle of the stream buffer to which data was written.
- **pxHigherPriorityTaskWoken** -- \*pxHigherPriorityTaskWoken should be initialised to pdFALSE before it is passed into xStreamBufferSendCompletedFromISR(). If calling xStreamBufferSendCompletedFromISR() removes a task from the Blocked state, and the task has a priority above the priority of the currently running task, then \*pxHigherPriorityTaskWoken will get set to pdTRUE indicating that a context switch should be performed before exiting the ISR.

**返回** If a task was removed from the Blocked state then pdTRUE is returned. Otherwise pdFALSE is returned.

BaseType\_t **xStreamBufferReceiveCompletedFromISR** (*StreamBufferHandle\_t* xStreamBuffer, BaseType\_t \*pxHigherPriorityTaskWoken)

For advanced users only.

The sbRECEIVE\_COMPLETED() macro is called from within the FreeRTOS APIs when data is read out of a message buffer or stream buffer. If there was a task that was blocked on the message or stream buffer waiting for data to arrive then the sbRECEIVE\_COMPLETED() macro sends a notification to the task to remove it from the Blocked state. xStreamBufferReceiveCompletedFromISR() does the same thing. It is provided to enable application writers to implement their own version of sbRECEIVE\_COMPLETED(), and **MUST NOT BE USED AT ANY OTHER TIME**.

See the example implemented in FreeRTOS/Demo/Minimal/MessageBufferAMP.c for additional information.

#### 参数

- **xStreamBuffer** -- The handle of the stream buffer from which data was read.
- **pxHigherPriorityTaskWoken** -- \*pxHigherPriorityTaskWoken should be initialised to pdFALSE before it is passed into xStreamBufferReceiveCompletedFromISR(). If calling xStreamBufferReceiveCompletedFromISR() removes a task from the Blocked state, and the task has a priority above the priority of the currently running task, then \*pxHigherPriorityTaskWoken will get set to pdTRUE indicating that a context switch should be performed before exiting the ISR.

**返回** If a task was removed from the Blocked state then pdTRUE is returned. Otherwise pdFALSE is returned.

#### Macros

**xStreamBufferCreateWithCallback** (xBufferSizeBytes, xTriggerLevelBytes, pxSendCompletedCallback, pxReceiveCompletedCallback)

Creates a new stream buffer using dynamically allocated memory. See xStreamBufferCreateStatic() for a version that uses statically allocated memory (memory that is allocated at compile time).

configSUPPORT\_DYNAMIC\_ALLOCATION must be set to 1 or left undefined in FreeRTOSConfig.h for xStreamBufferCreate() to be available.

Example use:

```
void vAFunction( void )
{
StreamBufferHandle_t xStreamBuffer;
const size_t xStreamBufferSizeBytes = 100, xTriggerLevel = 10;

// Create a stream buffer that can hold 100 bytes. The memory used to hold
// both the stream buffer structure and the data in the stream buffer is
// allocated dynamically.
xStreamBuffer = xStreamBufferCreate( xStreamBufferSizeBytes, xTriggerLevel );

if( xStreamBuffer == NULL )
{
// There was not enough heap memory space available to create the
// stream buffer.
}
else
{
// The stream buffer was created successfully and can now be used.
}
}
```

#### 参数

- **xBufferSizeBytes** -- The total number of bytes the stream buffer will be able to hold at any one time.
- **xTriggerLevelBytes** -- The number of bytes that must be in the stream buffer before a task that is blocked on the stream buffer to wait for data is moved out of the blocked state. For example, if a task is blocked on a read of an empty stream buffer that has a trigger level of 1 then the task will be unblocked when a single byte is written to the buffer or the task's block time expires. As another example, if a task is blocked on a read of an empty stream buffer that has a trigger level of 10 then the task will not be unblocked until the stream buffer contains at least 10 bytes or the task's block time expires. If a reading task's block time expires before the trigger level is reached then the task will still receive however many bytes are actually available. Setting a trigger level of 0 will result in a trigger level of 1 being used. It is not valid to specify a trigger level that is greater than the buffer size.
- **pxSendCompletedCallback** -- Callback invoked when number of bytes at least equal to trigger level is sent to the stream buffer. If the parameter is NULL, it will use the default implementation provided by sbSEND\_COMPLETED macro. To enable the callback, configUSE\_SB\_COMPLETED\_CALLBACK must be set to 1 in FreeRTOSConfig.h.
- **pxReceiveCompletedCallback** -- Callback invoked when more than zero bytes are read from a stream buffer. If the parameter is NULL, it will use the default implementation provided by sbRECEIVE\_COMPLETED macro. To enable the callback, configUSE\_SB\_COMPLETED\_CALLBACK must be set to 1 in FreeRTOSConfig.h.

**返回** If NULL is returned, then the stream buffer cannot be created because there is insufficient heap memory available for FreeRTOS to allocate the stream buffer data structures and storage area. A non-NULL value being returned indicates that the stream buffer has been created successfully - the returned value should be stored as the handle to the created stream buffer.

**xStreamBufferCreateStaticWithCallback** (xBufferSizeBytes, xTriggerLevelBytes, pucStreamBufferStorageArea, pxStaticStreamBuffer, pxSendCompletedCallback, pxReceiveCompletedCallback)

Creates a new stream buffer using statically allocated memory. See xStreamBufferCreate() for a version that uses dynamically allocated memory.

configSUPPORT\_STATIC\_ALLOCATION must be set to 1 in FreeRTOSConfig.h for xStreamBufferCreateStatic() to be available.

Example use:

```
// Used to dimension the array used to hold the streams. The available space
// will actually be one less than this, so 999.
#define STORAGE_SIZE_BYTES 1000

// Defines the memory that will actually hold the streams within the stream
// buffer.
static uint8_t ucStorageBuffer[ STORAGE_SIZE_BYTES ];

// The variable used to hold the stream buffer structure.
StaticStreamBuffer_t xStreamBufferStruct;

void MyFunction( void )
{
    StreamBufferHandle_t xStreamBuffer;
    const size_t xTriggerLevel = 1;

    xStreamBuffer = xStreamBufferCreateStatic( sizeof( ucStorageBuffer ),
                                              xTriggerLevel,
                                              ucStorageBuffer,
                                              &xStreamBufferStruct );
}
```

(下页继续)

```
// As neither the pucStreamBufferStorageArea or pxStaticStreamBuffer
// parameters were NULL, xStreamBuffer will not be NULL, and can be used to
// reference the created stream buffer in other stream buffer API calls.

// Other code that uses the stream buffer can go here.
}
```

**参数**

- **xBufferSizeBytes** -- The size, in bytes, of the buffer pointed to by the pucStream-BufferStorageArea parameter.
- **xTriggerLevelBytes** -- The number of bytes that must be in the stream buffer before a task that is blocked on the stream buffer to wait for data is moved out of the blocked state. For example, if a task is blocked on a read of an empty stream buffer that has a trigger level of 1 then the task will be unblocked when a single byte is written to the buffer or the task's block time expires. As another example, if a task is blocked on a read of an empty stream buffer that has a trigger level of 10 then the task will not be unblocked until the stream buffer contains at least 10 bytes or the task's block time expires. If a reading task's block time expires before the trigger level is reached then the task will still receive however many bytes are actually available. Setting a trigger level of 0 will result in a trigger level of 1 being used. It is not valid to specify a trigger level that is greater than the buffer size.
- **pucStreamBufferStorageArea** -- Must point to a uint8\_t array that is at least xBufferSizeBytes big. This is the array to which streams are copied when they are written to the stream buffer.
- **pxStaticStreamBuffer** -- Must point to a variable of type StaticStreamBuffer\_t, which will be used to hold the stream buffer's data structure.
- **pxSendCompletedCallback** -- Callback invoked when number of bytes at least equal to trigger level is sent to the stream buffer. If the parameter is NULL, it will use the default implementation provided by sbSEND\_COMPLETED macro. To enable the callback, configUSE\_SB\_COMPLETED\_CALLBACK must be set to 1 in FreeRTOSConfig.h.
- **pxReceiveCompletedCallback** -- Callback invoked when more than zero bytes are read from a stream buffer. If the parameter is NULL, it will use the default implementation provided by sbRECEIVE\_COMPLETED macro. To enable the callback, configUSE\_SB\_COMPLETED\_CALLBACK must be set to 1 in FreeRTOSConfig.h.

**返回** If the stream buffer is created successfully then a handle to the created stream buffer is returned. If either pucStreamBufferStorageArea or pxStaticstreamBuffer are NULL then NULL is returned.

**Type Definitions**

```
typedef struct StreamBufferDef_t *StreamBufferHandle_t
```

```
typedef void (*StreamBufferCallbackFunction_t)(StreamBufferHandle_t xStreamBuffer, BaseType_t xIsInsideISR, BaseType_t *const pxHigherPriorityTaskWoken)
```

Type used as a stream buffer's optional callback.

**消息缓冲区 API****Header File**

- components/freertos/FreeRTOS-Kernel/include/freertos/message\_buffer.h
- This header file can be included with:

```
#include "freertos/message_buffer.h"
```



**Macros**

**xMessageBufferCreateWithCallback** (xBufferSizeBytes, pxSendCompletedCallback, pxReceiveCompletedCallback)

Creates a new message buffer using dynamically allocated memory. See xMessageBufferCreateStatic() for a version that uses statically allocated memory (memory that is allocated at compile time).

configSUPPORT\_DYNAMIC\_ALLOCATION must be set to 1 or left undefined in FreeRTOSConfig.h for xMessageBufferCreate() to be available.

Example use:

```
void vAFunction( void )
{
    MessageBufferHandle_t xMessageBuffer;
    const size_t xMessageBufferSizeBytes = 100;

    // Create a message buffer that can hold 100 bytes. The memory used to hold
    // both the message buffer structure and the messages themselves is allocated
    // dynamically. Each message added to the buffer consumes an additional 4
    // bytes which are used to hold the length of the message.
    xMessageBuffer = xMessageBufferCreate( xMessageBufferSizeBytes );

    if( xMessageBuffer == NULL )
    {
        // There was not enough heap memory space available to create the
        // message buffer.
    }
    else
    {
        // The message buffer was created successfully and can now be used.
    }
}
```

**参数**

- **xBufferSizeBytes** -- The total number of bytes (not messages) the message buffer will be able to hold at any one time. When a message is written to the message buffer an additional sizeof( size\_t ) bytes are also written to store the message's length. sizeof( size\_t ) is typically 4 bytes on a 32-bit architecture, so on most 32-bit architectures a 10 byte message will take up 14 bytes of message buffer space.
- **pxSendCompletedCallback** -- Callback invoked when a send operation to the message buffer is complete. If the parameter is NULL or xMessageBufferCreate() is called without the parameter, then it will use the default implementation provided by sbSEND\_COMPLETED macro. To enable the callback, configUSE\_SB\_COMPLETED\_CALLBACK must be set to 1 in FreeRTOSConfig.h.
- **pxReceiveCompletedCallback** -- Callback invoked when a receive operation from the message buffer is complete. If the parameter is NULL or xMessageBufferCreate() is called without the parameter, it will use the default implementation provided by sbRECEIVE\_COMPLETED macro. To enable the callback, configUSE\_SB\_COMPLETED\_CALLBACK must be set to 1 in FreeRTOSConfig.h.

**返回** If NULL is returned, then the message buffer cannot be created because there is insufficient heap memory available for FreeRTOS to allocate the message buffer data structures and storage area. A non-NULL value being returned indicates that the message buffer has been created successfully - the returned value should be stored as the handle to the created message buffer.

**xMessageBufferCreateStaticWithCallback** (xBufferSizeBytes, pucMessageBufferStorageArea, pxStaticMessageBuffer, pxSendCompletedCallback, pxReceiveCompletedCallback)

Creates a new message buffer using statically allocated memory. See xMessageBufferCreate() for a version that uses dynamically allocated memory.

Example use:

```
// Used to dimension the array used to hold the messages. The available space
// will actually be one less than this, so 999.
#define STORAGE_SIZE_BYTES 1000

// Defines the memory that will actually hold the messages within the message
// buffer.
static uint8_t ucStorageBuffer[ STORAGE_SIZE_BYTES ];

// The variable used to hold the message buffer structure.
StaticMessageBuffer_t xMessageBufferStruct;

void MyFunction( void )
{
    MessageBufferHandle_t xMessageBuffer;

    xMessageBuffer = xMessageBufferCreateStatic( sizeof( ucStorageBuffer ),
                                                ucStorageBuffer,
                                                &xMessageBufferStruct );

    // As neither the pucMessageBufferStorageArea or pxStaticMessageBuffer
    // parameters were NULL, xMessageBuffer will not be NULL, and can be used to
    // reference the created message buffer in other message buffer API calls.

    // Other code that uses the message buffer can go here.
}
```

### 参数

- **xBufferSizeBytes** -- The size, in bytes, of the buffer pointed to by the `pucMessageBufferStorageArea` parameter. When a message is written to the message buffer an additional `sizeof( size_t )` bytes are also written to store the message's length. `sizeof( size_t )` is typically 4 bytes on a 32-bit architecture, so on most 32-bit architecture a 10 byte message will take up 14 bytes of message buffer space. The maximum number of bytes that can be stored in the message buffer is actually `(xBufferSizeBytes - 1)`.
- **pucMessageBufferStorageArea** -- Must point to a `uint8_t` array that is at least `xBufferSizeBytes` big. This is the array to which messages are copied when they are written to the message buffer.
- **pxStaticMessageBuffer** -- Must point to a variable of type `StaticMessageBuffer_t`, which will be used to hold the message buffer's data structure.
- **pxSendCompletedCallback** -- Callback invoked when a new message is sent to the message buffer. If the parameter is `NULL` or `xMessageBufferCreate()` is called without the parameter, then it will use the default implementation provided by `sbSEND_COMPLETED` macro. To enable the callback, `configUSE_SB_COMPLETED_CALLBACK` must be set to 1 in `FreeRTOSConfig.h`.
- **pxReceiveCompletedCallback** -- Callback invoked when a message is read from a message buffer. If the parameter is `NULL` or `xMessageBufferCreate()` is called without the parameter, it will use the default implementation provided by `sbRECEIVE_COMPLETED` macro. To enable the callback, `configUSE_SB_COMPLETED_CALLBACK` must be set to 1 in `FreeRTOSConfig.h`.

**返回** If the message buffer is created successfully then a handle to the created message buffer is returned. If either `pucMessageBufferStorageArea` or `pxStaticmessageBuffer` are `NULL` then `NULL` is returned.

**xMessageBufferGetStaticBuffers** (`xMessageBuffer`, `ppucMessageBufferStorageArea`,  
`ppxStaticMessageBuffer`)

Retrieve pointers to a statically created message buffer's data structure buffer and storage area buffer. These are the same buffers that are supplied at the time of creation.



**参数**

- **xMessageBuffer** -- The message buffer for which to retrieve the buffers.
- **ppucMessageBufferStorageArea** -- Used to return a pointer to the message buffer's storage area buffer.
- **ppxStaticMessageBuffer** -- Used to return a pointer to the message buffer's data structure buffer.

**返回** pdTRUE if buffers were retrieved, pdFALSE otherwise.

**xMessageBufferSend** (xMessageBuffer, pvTxData, xDataLengthBytes, xTicksToWait)

Sends a discrete message to the message buffer. The message can be any length that fits within the buffer's free space, and is copied into the buffer.

**NOTE:** Uniquely among FreeRTOS objects, the stream buffer implementation (so also the message buffer implementation, as message buffers are built on top of stream buffers) assumes there is only one task or interrupt that will write to the buffer (the writer), and only one task or interrupt that will read from the buffer (the reader). It is safe for the writer and reader to be different tasks or interrupts, but, unlike other FreeRTOS objects, it is not safe to have multiple different writers or multiple different readers. If there are to be multiple different writers then the application writer must place each call to a writing API function (such as xMessageBufferSend()) inside a critical section and set the send block time to 0. Likewise, if there are to be multiple different readers then the application writer must place each call to a reading API function (such as xMessageBufferRead()) inside a critical section and set the receive block time to 0.

Use xMessageBufferSend() to write to a message buffer from a task. Use xMessageBufferSendFromISR() to write to a message buffer from an interrupt service routine (ISR).

Example use:

```
void vAFunction( MessageBufferHandle_t xMessageBuffer )
{
    size_t xBytesSent;
    uint8_t ucArrayToSend[] = { 0, 1, 2, 3 };
    char *pcStringToSend = "String to send";
    const TickType_t x100ms = pdMS_TO_TICKS( 100 );

    // Send an array to the message buffer, blocking for a maximum of 100ms to
    // wait for enough space to be available in the message buffer.
    xBytesSent = xMessageBufferSend( xMessageBuffer, ( void * ) ucArrayToSend,
    ↪sizeof( ucArrayToSend ), x100ms );

    if( xBytesSent != sizeof( ucArrayToSend ) )
    {
        // The call to xMessageBufferSend() times out before there was enough
        // space in the buffer for the data to be written.
    }

    // Send the string to the message buffer. Return immediately if there is
    // not enough space in the buffer.
    xBytesSent = xMessageBufferSend( xMessageBuffer, ( void * ) pcStringToSend,
    ↪strlen( pcStringToSend ), 0 );

    if( xBytesSent != strlen( pcStringToSend ) )
    {
        // The string could not be added to the message buffer because there was
        // not enough free space in the buffer.
    }
}
```

**参数**

- **xMessageBuffer** -- The handle of the message buffer to which a message is being sent.
- **pvTxData** -- A pointer to the message that is to be copied into the message buffer.

- **xDataLengthBytes** -- The length of the message. That is, the number of bytes to copy from pvTxData into the message buffer. When a message is written to the message buffer an additional sizeof( size\_t ) bytes are also written to store the message's length. sizeof( size\_t ) is typically 4 bytes on a 32-bit architecture, so on most 32-bit architecture setting xDataLengthBytes to 20 will reduce the free space in the message buffer by 24 bytes (20 bytes of message data and 4 bytes to hold the message length).
- **xTicksToWait** -- The maximum amount of time the calling task should remain in the Blocked state to wait for enough space to become available in the message buffer, should the message buffer have insufficient space when xMessageBufferSend() is called. The calling task will never block if xTicksToWait is zero. The block time is specified in tick periods, so the absolute time it represents is dependent on the tick frequency. The macro pdMS\_TO\_TICKS() can be used to convert a time specified in milliseconds into a time specified in ticks. Setting xTicksToWait to portMAX\_DELAY will cause the task to wait indefinitely (without timing out), provided INCLUDE\_vTaskSuspend is set to 1 in FreeRTOSConfig.h. Tasks do not use any CPU time when they are in the Blocked state.

**返回** The number of bytes written to the message buffer. If the call to xMessageBufferSend() times out before there was enough space to write the message into the message buffer then zero is returned. If the call did not time out then xDataLengthBytes is returned.

**xMessageBufferSendFromISR** (xMessageBuffer, pvTxData, xDataLengthBytes, pxHigherPriorityTaskWoken)

Interrupt safe version of the API function that sends a discrete message to the message buffer. The message can be any length that fits within the buffer's free space, and is copied into the buffer.

**NOTE:** Uniquely among FreeRTOS objects, the stream buffer implementation (so also the message buffer implementation, as message buffers are built on top of stream buffers) assumes there is only one task or interrupt that will write to the buffer (the writer), and only one task or interrupt that will read from the buffer (the reader). It is safe for the writer and reader to be different tasks or interrupts, but, unlike other FreeRTOS objects, it is not safe to have multiple different writers or multiple different readers. If there are to be multiple different writers then the application writer must place each call to a writing API function (such as xMessageBufferSend()) inside a critical section and set the send block time to 0. Likewise, if there are to be multiple different readers then the application writer must place each call to a reading API function (such as xMessageBufferRead()) inside a critical section and set the receive block time to 0.

Use xMessageBufferSend() to write to a message buffer from a task. Use xMessageBufferSendFromISR() to write to a message buffer from an interrupt service routine (ISR).

Example use:

```
// A message buffer that has already been created.
MessageBufferHandle_t xMessageBuffer;

void vAnInterruptServiceRoutine( void )
{
    size_t xBytesSent;
    char *pcStringToSend = "String to send";
    BaseType_t xHigherPriorityTaskWoken = pdFALSE; // Initialised to pdFALSE.

    // Attempt to send the string to the message buffer.
    xBytesSent = xMessageBufferSendFromISR( xMessageBuffer,
                                           ( void * ) pcStringToSend,
                                           strlen( pcStringToSend ),
                                           &xHigherPriorityTaskWoken );

    if( xBytesSent != strlen( pcStringToSend ) )
    {
        // The string could not be added to the message buffer because there was
        // not enough free space in the buffer.
    }
}
```

(下页继续)

```

// If xHigherPriorityTaskWoken was set to pdTRUE inside
// xMessageBufferSendFromISR() then a task that has a priority above the
// priority of the currently executing task was unblocked and a context
// switch should be performed to ensure the ISR returns to the unblocked
// task. In most FreeRTOS ports this is done by simply passing
// xHigherPriorityTaskWoken into portYIELD_FROM_ISR(), which will test the
// variables value, and perform the context switch if necessary. Check the
// documentation for the port in use for port specific instructions.
portYIELD_FROM_ISR( xHigherPriorityTaskWoken );
}

```

**参数**

- **xMessageBuffer** -- The handle of the message buffer to which a message is being sent.
- **pvTxData** -- A pointer to the message that is to be copied into the message buffer.
- **xDataLengthBytes** -- The length of the message. That is, the number of bytes to copy from pvTxData into the message buffer. When a message is written to the message buffer an additional sizeof( size\_t ) bytes are also written to store the message's length. sizeof( size\_t ) is typically 4 bytes on a 32-bit architecture, so on most 32-bit architecture setting xDataLengthBytes to 20 will reduce the free space in the message buffer by 24 bytes (20 bytes of message data and 4 bytes to hold the message length).
- **pxHigherPriorityTaskWoken** -- It is possible that a message buffer will have a task blocked on it waiting for data. Calling xMessageBufferSendFromISR() can make data available, and so cause a task that was waiting for data to leave the Blocked state. If calling xMessageBufferSendFromISR() causes a task to leave the Blocked state, and the unblocked task has a priority higher than the currently executing task (the task that was interrupted), then, internally, xMessageBufferSendFromISR() will set \*pxHigherPriorityTaskWoken to pdTRUE. If xMessageBufferSendFromISR() sets this value to pdTRUE, then normally a context switch should be performed before the interrupt is exited. This will ensure that the interrupt returns directly to the highest priority Ready state task. \*pxHigherPriorityTaskWoken should be set to pdFALSE before it is passed into the function. See the code example below for an example.

**返回** The number of bytes actually written to the message buffer. If the message buffer didn't have enough free space for the message to be stored then 0 is returned, otherwise xDataLengthBytes is returned.

**xMessageBufferReceive** (xMessageBuffer, pvRxData, xBufferLengthBytes, xTicksToWait)

Receives a discrete message from a message buffer. Messages can be of variable length and are copied out of the buffer.

**NOTE:** Uniquely among FreeRTOS objects, the stream buffer implementation (so also the message buffer implementation, as message buffers are built on top of stream buffers) assumes there is only one task or interrupt that will write to the buffer (the writer), and only one task or interrupt that will read from the buffer (the reader). It is safe for the writer and reader to be different tasks or interrupts, but, unlike other FreeRTOS objects, it is not safe to have multiple different writers or multiple different readers. If there are to be multiple different writers then the application writer must place each call to a writing API function (such as xMessageBufferSend()) inside a critical section and set the send block time to 0. Likewise, if there are to be multiple different readers then the application writer must place each call to a reading API function (such as xMessageBufferRead()) inside a critical section and set the receive block time to 0.

Use xMessageBufferReceive() to read from a message buffer from a task. Use xMessageBufferReceiveFromISR() to read from a message buffer from an interrupt service routine (ISR).

Example use:

```

void vAFunction( MessageBuffer_t xMessageBuffer )
{
    uint8_t ucRxData[ 20 ];
    size_t xReceivedBytes;
    const TickType_t xBlockTime = pdMS_TO_TICKS( 20 );

    // Receive the next message from the message buffer. Wait in the Blocked
    // state (so not using any CPU processing time) for a maximum of 100ms for
    // a message to become available.
    xReceivedBytes = xMessageBufferReceive( xMessageBuffer,
                                           ( void * ) ucRxData,
                                           sizeof( ucRxData ),
                                           xBlockTime );

    if( xReceivedBytes > 0 )
    {
        // A ucRxData contains a message that is xReceivedBytes long. Process
        // the message here....
    }
}

```

### 参数

- **xMessageBuffer** -- The handle of the message buffer from which a message is being received.
- **pvRxData** -- A pointer to the buffer into which the received message is to be copied.
- **xBufferLengthBytes** -- The length of the buffer pointed to by the pvRxData parameter. This sets the maximum length of the message that can be received. If xBufferLengthBytes is too small to hold the next message then the message will be left in the message buffer and 0 will be returned.
- **xTicksToWait** -- The maximum amount of time the task should remain in the Blocked state to wait for a message, should the message buffer be empty. xMessageBufferReceive() will return immediately if xTicksToWait is zero and the message buffer is empty. The block time is specified in tick periods, so the absolute time it represents is dependent on the tick frequency. The macro pdMS\_TO\_TICKS() can be used to convert a time specified in milliseconds into a time specified in ticks. Setting xTicksToWait to portMAX\_DELAY will cause the task to wait indefinitely (without timing out), provided INCLUDE\_vTaskSuspend is set to 1 in FreeRTOSConfig.h. Tasks do not use any CPU time when they are in the Blocked state.

**返回** The length, in bytes, of the message read from the message buffer, if any. If xMessageBufferReceive() times out before a message became available then zero is returned. If the length of the message is greater than xBufferLengthBytes then the message will be left in the message buffer and zero is returned.

**xMessageBufferReceiveFromISR** (xMessageBuffer, pvRxData, xBufferLengthBytes, pxHigherPriorityTaskWoken)

An interrupt safe version of the API function that receives a discrete message from a message buffer. Messages can be of variable length and are copied out of the buffer.

**NOTE:** Uniquely among FreeRTOS objects, the stream buffer implementation (so also the message buffer implementation, as message buffers are built on top of stream buffers) assumes there is only one task or interrupt that will write to the buffer (the writer), and only one task or interrupt that will read from the buffer (the reader). It is safe for the writer and reader to be different tasks or interrupts, but, unlike other FreeRTOS objects, it is not safe to have multiple different writers or multiple different readers. If there are to be multiple different writers then the application writer must place each call to a writing API function (such as xMessageBufferSend()) inside a critical section and set the send block time to 0. Likewise, if there are to be multiple different readers then the application writer must place each call to a reading API function (such as xMessageBufferRead()) inside a critical section and set the receive block time to 0.

Use xMessageBufferReceive() to read from a message buffer from a task. Use xMessageBufferReceive-

FromISR() to read from a message buffer from an interrupt service routine (ISR).

Example use:

```
// A message buffer that has already been created.
MessageBuffer_t xMessageBuffer;

void vAnInterruptServiceRoutine( void )
{
    uint8_t ucRxData[ 20 ];
    size_t xReceivedBytes;
    BaseType_t xHigherPriorityTaskWoken = pdFALSE; // Initialised to pdFALSE.

    // Receive the next message from the message buffer.
    xReceivedBytes = xMessageBufferReceiveFromISR( xMessageBuffer,
                                                    ( void * ) ucRxData,
                                                    sizeof( ucRxData ),
                                                    &xHigherPriorityTaskWoken );

    if( xReceivedBytes > 0 )
    {
        // A ucRxData contains a message that is xReceivedBytes long. Process
        // the message here....
    }

    // If xHigherPriorityTaskWoken was set to pdTRUE inside
    // xMessageBufferReceiveFromISR() then a task that has a priority above the
    // priority of the currently executing task was unblocked and a context
    // switch should be performed to ensure the ISR returns to the unblocked
    // task. In most FreeRTOS ports this is done by simply passing
    // xHigherPriorityTaskWoken into portYIELD_FROM_ISR(), which will test the
    // variables value, and perform the context switch if necessary. Check the
    // documentation for the port in use for port specific instructions.
    portYIELD_FROM_ISR( xHigherPriorityTaskWoken );
}
```

### 参数

- **xMessageBuffer** -- The handle of the message buffer from which a message is being received.
- **pvRxData** -- A pointer to the buffer into which the received message is to be copied.
- **xBufferLengthBytes** -- The length of the buffer pointed to by the pvRxData parameter. This sets the maximum length of the message that can be received. If xBufferLengthBytes is too small to hold the next message then the message will be left in the message buffer and 0 will be returned.
- **pxHigherPriorityTaskWoken** -- It is possible that a message buffer will have a task blocked on it waiting for space to become available. Calling xMessageBufferReceiveFromISR() can make space available, and so cause a task that is waiting for space to leave the Blocked state. If calling xMessageBufferReceiveFromISR() causes a task to leave the Blocked state, and the unblocked task has a priority higher than the currently executing task (the task that was interrupted), then, internally, xMessageBufferReceiveFromISR() will set \*pxHigherPriorityTaskWoken to pdTRUE. If xMessageBufferReceiveFromISR() sets this value to pdTRUE, then normally a context switch should be performed before the interrupt is exited. That will ensure the interrupt returns directly to the highest priority Ready state task. \*pxHigherPriorityTaskWoken should be set to pdFALSE before it is passed into the function. See the code example below for an example.

**返回** The length, in bytes, of the message read from the message buffer, if any.

**vMessageBufferDelete** (xMessageBuffer)

Deletes a message buffer that was previously created using a call to xMessageBufferCreate() or xMessage-

BufferCreateStatic(). If the message buffer was created using dynamic memory (that is, by xMessageBufferCreate()), then the allocated memory is freed.

A message buffer handle must not be used after the message buffer has been deleted.

#### 参数

- **xMessageBuffer** -- The handle of the message buffer to be deleted.

#### **xMessageBufferIsFull** (xMessageBuffer)

Tests to see if a message buffer is full. A message buffer is full if it cannot accept any more messages, of any size, until space is made available by a message being removed from the message buffer.

#### 参数

- **xMessageBuffer** -- The handle of the message buffer being queried.

**返回** If the message buffer referenced by xMessageBuffer is full then pdTRUE is returned. Otherwise pdFALSE is returned.

#### **xMessageBufferIsEmpty** (xMessageBuffer)

Tests to see if a message buffer is empty (does not contain any messages).

#### 参数

- **xMessageBuffer** -- The handle of the message buffer being queried.

**返回** If the message buffer referenced by xMessageBuffer is empty then pdTRUE is returned. Otherwise pdFALSE is returned.

#### **xMessageBufferReset** (xMessageBuffer)

Resets a message buffer to its initial empty state, discarding any message it contained.

A message buffer can only be reset if there are no tasks blocked on it.

#### 参数

- **xMessageBuffer** -- The handle of the message buffer being reset.

**返回** If the message buffer was reset then pdPASS is returned. If the message buffer could not be reset because either there was a task blocked on the message queue to wait for space to become available, or to wait for a message to be available, then pdFAIL is returned.

#### **xMessageBufferSpaceAvailable** (xMessageBuffer)

message\_buffer.h

```
size_t xMessageBufferSpaceAvailable( MessageBufferHandle_t xMessageBuffer );
```

Returns the number of bytes of free space in the message buffer.

#### 参数

- **xMessageBuffer** -- The handle of the message buffer being queried.

**返回** The number of bytes that can be written to the message buffer before the message buffer would be full. When a message is written to the message buffer an additional sizeof( size\_t ) bytes are also written to store the message's length. sizeof( size\_t ) is typically 4 bytes on a 32-bit architecture, so if xMessageBufferSpacesAvailable() returns 10, then the size of the largest message that can be written to the message buffer is 6 bytes.

#### **xMessageBufferSpacesAvailable** (xMessageBuffer)

#### **xMessageBufferNextLengthBytes** (xMessageBuffer)

Returns the length (in bytes) of the next message in a message buffer. Useful if xMessageBufferReceive() returned 0 because the size of the buffer passed into xMessageBufferReceive() was too small to hold the next message.

#### 参数

- **xMessageBuffer** -- The handle of the message buffer being queried.

**返回** The length (in bytes) of the next message in the message buffer, or 0 if the message buffer is empty.



**xMessageBufferSendCompletedFromISR** (xMessageBuffer, pxHigherPriorityTaskWoken)

For advanced users only.

The sbSEND\_COMPLETED() macro is called from within the FreeRTOS APIs when data is sent to a message buffer or stream buffer. If there was a task that was blocked on the message or stream buffer waiting for data to arrive then the sbSEND\_COMPLETED() macro sends a notification to the task to remove it from the Blocked state. xMessageBufferSendCompletedFromISR() does the same thing. It is provided to enable application writers to implement their own version of sbSEND\_COMPLETED(), and MUST NOT BE USED AT ANY OTHER TIME.

See the example implemented in FreeRTOS/Demo/Minimal/MessageBufferAMP.c for additional information.

**参数**

- **xMessageBuffer** -- The handle of the stream buffer to which data was written.
- **pxHigherPriorityTaskWoken** -- \*pxHigherPriorityTaskWoken should be initialised to pdFALSE before it is passed into xMessageBufferSendCompletedFromISR(). If calling xMessageBufferSendCompletedFromISR() removes a task from the Blocked state, and the task has a priority above the priority of the currently running task, then \*pxHigherPriorityTaskWoken will get set to pdTRUE indicating that a context switch should be performed before exiting the ISR.

**返回** If a task was removed from the Blocked state then pdTRUE is returned. Otherwise pdFALSE is returned.

**xMessageBufferReceiveCompletedFromISR** (xMessageBuffer, pxHigherPriorityTaskWoken)

For advanced users only.

The sbRECEIVE\_COMPLETED() macro is called from within the FreeRTOS APIs when data is read out of a message buffer or stream buffer. If there was a task that was blocked on the message or stream buffer waiting for data to arrive then the sbRECEIVE\_COMPLETED() macro sends a notification to the task to remove it from the Blocked state. xMessageBufferReceiveCompletedFromISR() does the same thing. It is provided to enable application writers to implement their own version of sbRECEIVE\_COMPLETED(), and MUST NOT BE USED AT ANY OTHER TIME.

See the example implemented in FreeRTOS/Demo/Minimal/MessageBufferAMP.c for additional information.

**参数**

- **xMessageBuffer** -- The handle of the stream buffer from which data was read.
- **pxHigherPriorityTaskWoken** -- \*pxHigherPriorityTaskWoken should be initialised to pdFALSE before it is passed into xMessageBufferReceiveCompletedFromISR(). If calling xMessageBufferReceiveCompletedFromISR() removes a task from the Blocked state, and the task has a priority above the priority of the currently running task, then \*pxHigherPriorityTaskWoken will get set to pdTRUE indicating that a context switch should be performed before exiting the ISR.

**返回** If a task was removed from the Blocked state then pdTRUE is returned. Otherwise pdFALSE is returned.

**Type Definitions**

typedef *StreamBufferHandle\_t* **MessageBufferHandle\_t**

Type by which message buffers are referenced. For example, a call to xMessageBufferCreate() returns an MessageBufferHandle\_t variable that can then be used as a parameter to xMessageBufferSend(), xMessageBufferReceive(), etc. Message buffer is essentially built as a stream buffer hence its handle is also set to same type as a stream buffer handle.

**2.10.13 FreeRTOS (附加功能)**

ESP-IDF 为 FreeRTOS 提供了多种附加功能。这些附加功能适用于 ESP-IDF 支持的所有 FreeRTOS 实现，即 ESP-IDF FreeRTOS 和 Amazon SMP FreeRTOS。本文档介绍了这些附加功能，内容包括以下几个部分：

## 目录

- *FreeRTOS* (附加功能)
  - 概述
  - 环形 *buffer*
  - *ESP-IDF tick* 钩子和 *idle* 钩子
  - *TLSP* 删除回调
  - *IDF* 附加 *API*
  - 组件专用功能
  - *API* 参考

## 概述

ESP-IDF 为 FreeRTOS 提供了以下附加功能：

- **环形 buffer**：FIFO 缓冲区，支持任意长度的数据项。
- **ESP-IDF tick 钩子和 idle 钩子**：ESP-IDF 提供了多个自定义的 tick 钩子和 idle 钩子，相较于 FreeRTOS，支持的钩子数量更多且更灵活。
- **线程本地存储指针 (TLSP) 删除回调**：当一个任务被删除时，TLSP 删除回调会自动运行，从而自动清理 TLSP。
- **IDF 附加 API**：专用于 ESP-IDF 的附加函数，用于增强 FreeRTOS 的功能。
- **组件专用功能**：目前只添加了一个专用于组件的功能，即 `ORIG_INCLUDE_PATH`。

## 环形 buffer

FreeRTOS 提供了流 buffer 和消息 buffer，作为在任务和 ISR 之间发送任意大小数据的主要机制。然而，FreeRTOS 流 buffer 和消息 buffer 具有以下限制：

- 仅支持单一的发送者和单一的接收者
- 数据通过复制的方式进行传递
- 无法为延迟发送（即发送获取）预留 buffer 空间

为此，ESP-IDF 提供了一个单独的环形 buffer 来解决上述问题。

ESP-IDF 环形 buffer 是一个典型的 FIFO buffer，支持任意大小的数据项。在数据项大小可变的条件下，环形 buffer 比 FreeRTOS 队列更节约内存，可以替代 FreeRTOS 队列使用。环形 buffer 的容量不是由可以存储的数据项数量衡量的，而是由用于存储数据项的内存量来衡量的。

环形 buffer 提供了 API 来发送数据项，或为环形 buffer 中的数据项分配空间，以便进行手动填充。为提高效率，**数据项都通过引用的方式从环形 buffer 中检索出来**。因此，所有检索出的数据项也**必须**通过 `vRingbufferReturnItem()` 或 `vRingbufferReturnItemFromISR()` 返回到环形 buffer，以便将其从环形 buffer 中完全移除。

环形 buffer 分为以下三种类型：

**不可分割 buffer**：确保将一个数据项存储在连续的内存中，并且在任何情况下都不会尝试分割数据项。当数据项必须占用连续的内存时，请使用不可分割 buffer。**仅不可分割 buffer 允许为延迟发送保留缓冲空间**。更多信息请参考函数 `xRingbufferSendAcquire()` 和 `xRingbufferSendComplete()` 的文档。

**可分割 buffer**：当数据项在 buffer 末尾绕回时，如果 buffer 头部和尾部的总空间足够，则支持将一个数据项分成两部分进行存储。可分割 buffer 比不可分割 buffer 更节省内存，但在检索时可能会返回数据项的两个部分。

**字节 buffer**：不将数据存储为单独的数据项。所有数据都存储为字节序列，每次可以发送或检索任意大小的字节。当不需要单独维护数据项时，推荐使用字节 buffer，例如字节流。

---

**备注：**不可分割 buffer 和可分割 buffer 在 32 位对齐地址上存储数据项。因此，在检索一个数据项时，数据项指针一定也是 32 位对齐的。这在向 DMA 发送数据时非常有用。

---



**备注：**存储在不可分割或可分割 `buffer` 中的每个数据项 **需要额外的 8 字节用于标头**。数据项大小会向上取整为 32 位对齐大小，即 4 字节的倍数，实际的数据项大小则记录在标头中。不可分割和可分割 `buffer` 的大小在创建时也会向上取整。

**使用方法** 以下示例演示了如何使用 `xRingbufferCreate()` 和 `xRingbufferSend()` 来创建环形 `buffer`，并向其发送数据项：

```
#include "freertos/ringbuf.h"
static char tx_item[] = "test_item";

...

//创建环形 buffer
RingbufHandle_t buf_handle;
buf_handle = xRingbufferCreate(1028, RINGBUF_TYPE_NOSPLIT);
if (buf_handle == NULL) {
    printf("Failed to create ring buffer\n");
}

//发送一个数据项
UBaseType_t res = xRingbufferSend(buf_handle, tx_item, sizeof(tx_item), pdMS_
↪TO_TICKS(1000));
if (res != pdTRUE) {
    printf("Failed to send item\n");
}
```

以下示例演示了如何使用 `xRingbufferSendAcquire()` 和 `xRingbufferSendComplete()` 代替 `xRingbufferSend()` 来获取环形 `buffer` (`RINGBUF_TYPE_NOSPLIT` 类型) 上的内存，然后向其发送一个数据项。虽然增加了一个步骤，但可以实现获取要写入内存的地址，并自行写入内存。

```
#include "freertos/ringbuf.h"
#include "soc/lldesc.h"

typedef struct {
    lldesc_t dma_desc;
    uint8_t buf[1];
} dma_item_t;

#define DMA_ITEM_SIZE(N) (sizeof(lldesc_t)+((N)+3)&(~3))

...

//为 DMA 描述符和相应的数据 buffer 检索空间
//此步骤必须通过 SendAcquire 完成，否则，复制时地址可能会不同
dma_item_t *item;
UBaseType_t res = xRingbufferSendAcquire(buf_handle,
    (void**) &item, DMA_ITEM_SIZE(buffer_size), pdMS_TO_
↪TICKS(1000));
if (res != pdTRUE) {
    printf("Failed to acquire memory for item\n");
}
item->dma_desc = (lldesc_t) {
    .size = buffer_size,
    .length = buffer_size,
    .eof = 0,
    .owner = 1,
    .buf = item->buf,
};
//实际发送到环形 buffer 以供使用
```

(下页继续)

```

res = xRingbufferSendComplete(buf_handle, &item);
if (res != pdTRUE) {
    printf("Failed to send item\n");
}

```

以下示例演示了使用 `xRingbufferReceive()` 和 `vRingbufferReturnItem()` 从不可分割环形 buffer 中检索和返回数据项:

```

...

//从不可分割环形 buffer 中接收一个数据项
size_t item_size;
char *item = (char *)xRingbufferReceive(buf_handle, &item_size, pdMS_TO_
↪TICKS(1000));

//Check received item
if (item != NULL) {
    //Print item
    for (int i = 0; i < item_size; i++) {
        printf("%c", item[i]);
    }
    printf("\n");
    //返回数据项
    vRingbufferReturnItem(buf_handle, (void *)item);
} else {
    //数据项检索失败
    printf("Failed to receive item\n");
}

```

以下示例演示了使用 `xRingbufferReceiveSplit()` 和 `vRingbufferReturnItem()` 从可分割环形 buffer 中检索和返回数据项:

```

...

//从可分割环形 buffer 中接收一个数据项
size_t item_size1, item_size2;
char *item1, *item2;
BaseType_t ret = xRingbufferReceiveSplit(buf_handle, (void **)&item1, (void_
↪*)&item2, &item_size1, &item_size2, pdMS_TO_TICKS(1000));

//检查收到的数据项
if (ret == pdTRUE && item1 != NULL) {
    for (int i = 0; i < item_size1; i++) {
        printf("%c", item1[i]);
    }
    vRingbufferReturnItem(buf_handle, (void *)item1);
    //Check if item was split
    if (item2 != NULL) {
        for (int i = 0; i < item_size2; i++) {
            printf("%c", item2[i]);
        }
        vRingbufferReturnItem(buf_handle, (void *)item2);
    }
    printf("\n");
} else {
    //接收数据项失败
    printf("Failed to receive item\n");
}

```

以下示例演示了使用 `xRingbufferReceiveUpTo()` 和 `vRingbufferReturnItem()` 从字节 buffer 中检索和返回数据项:

```

...

//从字节 buffer 中接收数据
size_t item_size;
char *item = (char *)xRingbufferReceiveUpTo(buf_handle, &item_size, pdMS_TO_
↳TICKS(1000), sizeof(tx_item));

//检查接收到的数据
if (item != NULL) {
    //Print item
    for (int i = 0; i < item_size; i++) {
        printf("%c", item[i]);
    }
    printf("\n");
    //返回数据项
    vRingbufferReturnItem(buf_handle, (void *)item);
} else {
    //接收数据项失败
    printf("Failed to receive item\n");
}

```

对于以上函数的 ISR 安全版本，请调用 `xRingbufferSendFromISR()`、`xRingbufferReceiveFromISR()`、`xRingbufferReceiveSplitFromISR()`、`xRingbufferReceiveUpToFromISR()` 和 `vRingbufferReturnItemFromISR()`。

**备注：**当字节在环形 buffer 的末端绕回时，需调用 `RingbufferReceive[UpTo][FromISR]()` 两次。

**发送到环形 buffer** 以下图表将不可分割和可分割 buffer 与字节 buffer 进行对比，说明了三者在发送数据或数据项方面的差异。图表中，假设分别向 **128 字节的 buffer** 发送大小为 **18、3 和 27 字节** 的三个数据项：



图 30: 向不可分割或可分割的环形 buffer 发送数据项

对于不可分割和可分割 buffer，每个数据项前都有 8 字节标头信息。此外，为了保持整体的 32 位对齐，每个数据项占用的空间都会 **向上取整到最接近的 32 位对齐大小**。数据项的实际大小会记录在标头中，并在检索数据项时返回。

参考上图，18、3 和 27 字节的数据项分别 **向上取整为 20、4 和 28 字节**，然后在每个数据项前面添加一个 8 字节的标头。

字节 buffer 将数据视为一个字节序列，不会引入任何额外开销，不添加标头信息。因此，发送到字节 buffer 的所有数据都会合并成一个数据项。

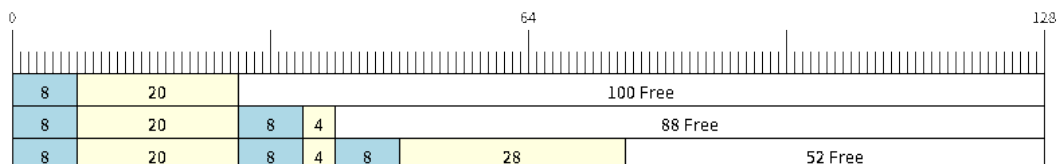
参考上图，18、3 和 27 字节的数据项被顺序写入字节 buffer，并 **合并成一个 48 字节的数据项**。

**使用 SendAcquire 和 SendComplete** 不可分割 buffer 中的数据项严格按照 FIFO 顺序通过 `SendAcquire` 获取，并且必须通过 `SendComplete` 发送到 buffer 以便访问。也可以发送或获取多个数据项，且无需严格遵照获取顺序，但接收数据项却必须遵循 FIFO。所以，如果不为最早获取的数据项调用 `SendComplete`，就无法接收后续数据项。



图 31: 向字节 buffer 发送数据项

以下图表说明了当 `SendAcquire` 和 `SendComplete` 顺序不同时的情形。一开始，已经有一个 16 字节的数据项发送到环形 buffer。然后调用 `SendAcquire` 在环形 buffer 上获取 20、8、24 字节的空闲空间。

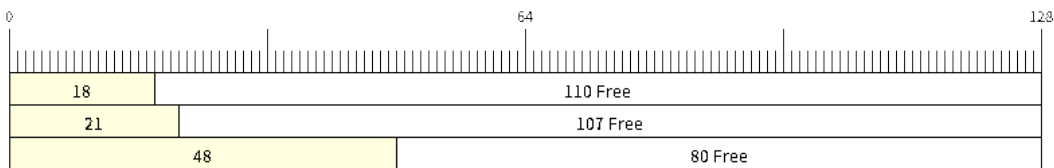

图 32: 在不可分割环形 buffer 中 `SendAcquire/SendComplete` 数据项

然后填充 buffer，按照 8、24、20 字节的顺序通过 `SendComplete` 将数据项发送到环形 buffer。当 8 字节和 24 字节的数据发送后，仍只能获取 16 字节的数据项。因此，如果不为 20 字节数据项调用 `SendComplete`，就无法获取该数据项，也无法获取 20 字节后的数据项。

当 20 字节数据项最终发送完成后，就可以在 buffer 中最初的 16 字节数据项之后，按照 20、8、24 字节的顺序接收所有的三个数据项。

由于 `SendAcquire` 及 `SendComplete` 要求所获取的 buffer 必须是完整的（未包装的），故可分割 buffer 和字节 buffer 不支持上述调用操作。

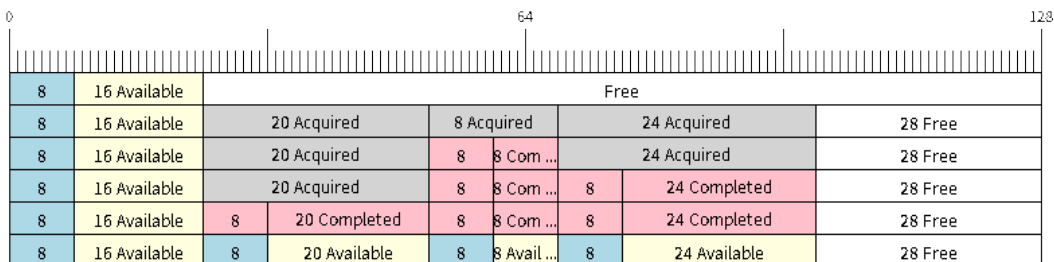
**绕回** 以下图表说明了发送数据项需要绕回时，不可分割、可分割和字节 buffer 之间的差异。图表假设有一个 128 字节的 buffer，其中有 56 字节的空闲空间可以绕回使用，并发送了一个 28 字节的数据项。



图 33: 在不可分割 buffer 中绕回

不可分割 buffer 只在连续的空闲空间中存储数据项，在任何情况下都不分割数据项。当 buffer 尾部的空闲空间不足以完全存储数据项及其标头时，尾部的空闲空间将被标记为虚拟数据。然后，数据项将绕回并存储在 buffer 头部的空闲空间中。

参考上图，buffer 尾部的 16 字节空闲空间不足以存储 28 字节的数据项，因此，这 16 字节被标记为虚拟数据，然后将数据项写入了 buffer 头部的空闲空间中。

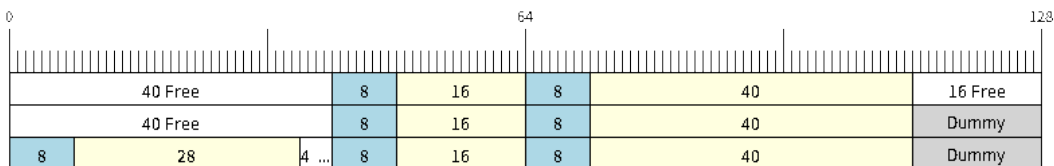

图 34: 在可分割 buffer 中绕回

当 buffer 尾部的空闲空间不足以存储数据项及其标头时，可分割 buffer 会尝试 **将数据项分割成两部分**。分割的的两部分数据项都将有自己的标头，因此会产生额外的 8 字节开销。

参考上图，buffer 尾部的 16 字节空闲空间不足以存储 28 字节的数据项。因此将数据项分割成两部分（8 字节和 20 字节），并将两部分写入 buffer。

**备注：** 可分割 buffer 将其分割好的两部分数据视为两个独立的数据项，因此不应调用 `xRingbufferReceive()`。需调用 `xRingbufferReceiveSplit()` 以线程安全的方式接收分割的两部分数据项。

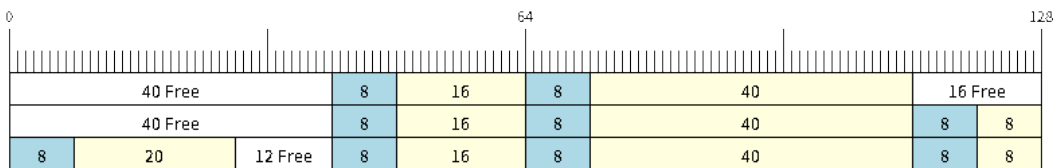

图 35: 在字节 buffer 中绕回

字节 buffer **将尽可能多的数据存储到 buffer 尾部的空闲空间中**。剩余的数据会存储在 buffer 头部的空闲空间。在字节 buffer 中绕回不会产生任何额外开销。

参考上图，buffer 尾部的 16 字节空闲空间不足以完全存储 28 字节的数据，因此，将数据填入这 16 字节空闲空间后，剩余的 12 字节会被写入 buffer 头部的空闲空间。此时，buffer 包含两个独立的连续数据，并且每个连续数据都被字节 buffer 视为一个独立数据项。

**检索/返回** 以下图表说明了在检索和返回数据时，不可分割、可分割 buffer 和字节 buffer 之间的差异：

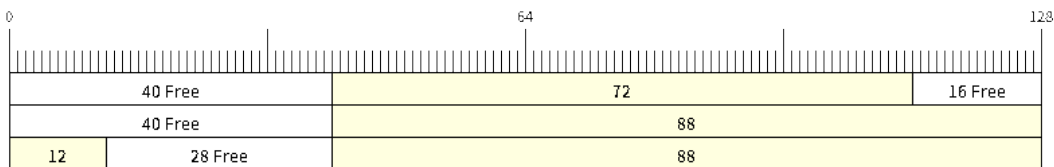

图 36: 在不可分割和可分割环形 buffer 中检索/返回数据项

不可分割 buffer 和可分割 buffer 中的数据项 **按严格的 FIFO 顺序检索并 必须返回**，以释放占用的空间。在返回之前可以检索多个数据项，且不必按照检索的顺序返回数据项。但是，释放空间必须按 FIFO 顺序进行，因此如果不返回最早检索的数据项，就无法释放后续数据项占用的空间。

参考上图，**16、20 和 8 字节的数据项按 FIFO 顺序被检索出来**。但是，这些数据项并不是按照被检索的顺序返回的。最先返回的是 20 字节的数据项，然后分别返回 8 字节和 16 字节的数据项。直到第一个数据项（即 16 字节的数据项）返回后，空间才会被释放。

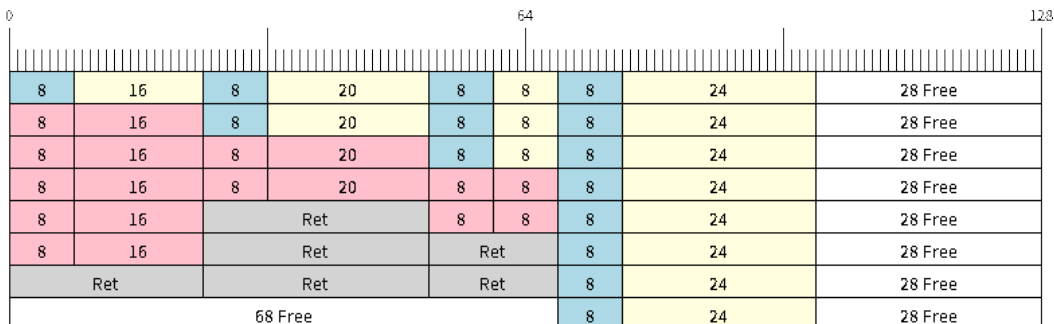

图 37: 在字节 buffer 中检索/返回数据

字节 buffer **不允许在返回之前进行多次检索**（每次检索必须在下一次检索之前返回结果）。使用 `xRingbufferReceive()` 或 `xRingbufferReceiveFromISR()` 时，会检索所有连续存储的数据。使用 `xRingbufferReceiveUpTo()` 或 `xRingbufferReceiveUpToFromISR()` 可限制检索的最大字节数。由于每次检索后都必须返回，因此数据一返回就会释放空间。

参考上图，buffer 尾部 38 字节连续存储的数据被检索、返回和释放。然后，下一次调用 `xRingbufferReceive()` 或 `xRingbufferReceiveFromISR()` 时，buffer 将绕回并对头部的 30 字节连续存储数据进行同样的处理。

**使用队列集的环形 buffer** 使用 `xRingbufferAddToQueueSetRead()` 可以将环形 buffer 添加到 FreeRTOS 队列集中，这样每次环形 buffer 接收一个数据项或数据时，队列集都会收到通知。添加到队列集后，每次从环形 buffer 检索数据项时都应该先调用 `xQueueSelectFromSet()`。要检查选定的队列集成员是否为环形 buffer，调用 `xRingbufferCanRead()`。

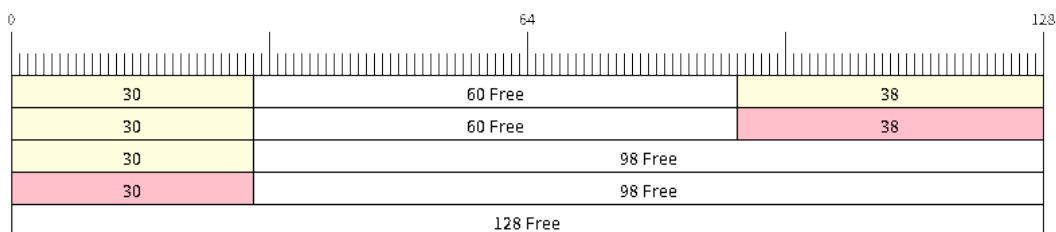
以下示例演示了如何使用包含环形 buffer 的队列集：

```
#include "freertos/queue.h"
#include "freertos/ringbuf.h"

...

//创建环形 buffer 和队列集
RingbufHandle_t buf_handle = xRingbufferCreate(1028, RINGBUF_TYPE_NOSPLIT);
QueueSetHandle_t queue_set = xQueueCreateSet(3);

//向队列集中添加环形 buffer
if (xRingbufferAddToQueueSetRead(buf_handle, queue_set) != pdTRUE) {
    printf("Failed to add to queue set\n");
}

...

//阻塞队列集
QueueSetMemberHandle_t member = xQueueSelectFromSet(queue_set, pdMS_TO_
↪TICKS(1000));

//检查成员是否为环形 buffer
if (member != NULL && xRingbufferCanRead(buf_handle, member) == pdTRUE) {
    //Member is ring buffer, receive item from ring buffer
}
```

(下页继续)

```

    size_t item_size;
    char *item = (char *)xRingbufferReceive(buf_handle, &item_size, 0);

    //处理数据项
    ...

} else {
    ...
}

```

**使用静态分配的环形 buffer** `xRingbufferCreateStatic()` 可用于创建具有特定内存需求的环形 buffer (如在外部 RAM 中分配的环形 buffer)。环形 buffer 使用的所有内存块都必须在创建之前手动分配, 然后传递给 `xRingbufferCreateStatic()` 以初始化为环形 buffer。这些内存块中包括:

- 环形 buffer 的数据结构类型 `StaticRingbuffer_t`。
- 环形 buffer 的存储区域, 大小为 `xBufferSize`。注意, 对于不可分割和可分割 buffer, `xBufferSize` 必须为 32 位对齐大小。

这些块的分配方式取决于具体的需求。例如, 静态声明所有块, 或动态分配为具有特定功能的块, 如外部 RAM。

**备注:** 当删除通过 `xRingbufferCreateStatic()` 创建的环形 buffer 时, `vRingbufferDelete()` 函数不会释放任何内存块。释放内存必须在调用 `vRingbufferDelete()` 后手动完成。

下面的代码片段演示了一个完全在外部 RAM 中分配的环形 buffer:

```

#include "freertos/ringbuf.h"
#include "freertos/semphr.h"
#include "esp_heap_caps.h"

#define BUFFER_SIZE    400    //32 位对齐大小
#define BUFFER_TYPE    RINGBUF_TYPE_NOSPLIT
...

//将 环形 buffer 数据结构体和存储区分配到外部 RAM 中
StaticRingbuffer_t *buffer_struct = (StaticRingbuffer_t *)heap_caps_
↳malloc(sizeof(StaticRingbuffer_t), MALLOC_CAP_SPIRAM);
uint8_t *buffer_storage = (uint8_t *)heap_caps_malloc(sizeof(uint8_t)*BUFFER_SIZE,
↳MALLOC_CAP_SPIRAM);

//使用手动分配的内存创建环形 buffer
RingbufHandle_t handle = xRingbufferCreateStatic(BUFFER_SIZE, BUFFER_TYPE, buffer_
↳storage, buffer_struct);

...

//使用后删除环形 buffer
vRingbufferDelete(handle);

//手动释放所有内存块
free(buffer_struct);
free(buffer_storage);

```

### ESP-IDF tick 钩子和 idle 钩子

FreeRTOS 允许应用程序在编译时提供一个 tick 钩子和一个 idle 钩子:



- FreeRTOS tick 钩子可以通过 `CONFIG_FREERTOS_USE_TICK_HOOK` 选项启用。应用程序必须提供 `void vApplicationTickHook( void )` 回调。
- FreeRTOS idle 钩子可以通过 `CONFIG_FREERTOS_USE_IDLE_HOOK` 选项启用。应用程序必须提供 `void vApplicationIdleHook( void )` 回调。

然而，FreeRTOS tick 钩子和 idle 钩子有以下不足：

- FreeRTOS 钩子是在编译时注册的
- 每种钩子只能注册一个
- 在多核目标芯片上，FreeRTOS 钩子是对称的，即每个内核的 tick 中断和 idle 任务最终都会调用同一个钩子

因此，ESP-IDF 提供了 tick 钩子和 idle 钩子来补充 FreeRTOS tick 和 idle 钩子的功能。ESP-IDF 钩子具有以下功能：

- 钩子可以在运行时注册和注销
- 可以注册多个钩子。每个内核中，同一类型的钩子最多可以注册 8 个
- 在多核目标芯片上，钩子可以是不对称的，即可以为每个内核注册不同的钩子

使用以下 API 注册和注销 ESP-IDF 钩子：

- 对于 tick 钩子：
  - 用 `esp_register_freertos_tick_hook()` 或 `esp_register_freertos_tick_hook_for_cpu()` 注册
  - 用 `esp_deregister_freertos_tick_hook()` 或 `esp_deregister_freertos_tick_hook_for_cpu()` 注销
- 对于 idle 钩子：
  - 使用 `esp_register_freertos_idle_hook()` 或 `esp_register_freertos_idle_hook_for_cpu()` 注册
  - 使用 `esp_deregister_freertos_idle_hook()` 或 `esp_deregister_freertos_idle_hook_for_cpu()` 注销

---

**备注：**在 cache 被禁用时，tick 中断仍保持活动，因此任何 tick 钩子（FreeRTOS 或 ESP-IDF）函数都必须放在内部 RAM 中。请参考 [SPI flash API documentation](#) 了解详情。

---

## TLSP 删除回调

原生 FreeRTOS 提供了线程本地存储指针 (TLSP) 功能，这些指针直接存储在特定任务的任务控制块 (TCB) 中。TLSP 允许每个任务拥有自己的数据结构指针集合。在原生 FreeRTOS 中：

- 在任务创建后，需调用 `vTaskSetThreadLocalStoragePointer()` 设置任务的 TLSP。
- 在任务的生命周期中，需调用 `pvTaskGetThreadLocalStoragePointer()` 获取任务的 TLSP。
- 在删除任务前，需释放 TLSP 指向的内存。

然而，为了能够自动释放 TLSP 内存，ESP-IDF 额外提供了 TLSP 删除回调功能。当删除任务时，这些删除回调函数会被自动调用，从而清除 TLSP 内存，无需在每个任务的代码中显式添加内存清除逻辑。

设置 TLSP 删除回调的方式与设置 TLSP 类似。

- `vTaskSetThreadLocalStoragePointerAndDelCallback()` 设置了特定的 TLSP 及其关联的回调。
- 调用原生 FreeRTOS 函数 `vTaskSetThreadLocalStoragePointer()` 只会将 TLSP 的关联删除回调设置为 `NULL`，也就是说，在任务删除期间不会调用该 TLSP 的回调。

在实现 TLSP 回调时，应注意以下几点：

- 回调 **绝对不能尝试阻塞或让出**，并且应尽可能缩短临界区的时间。
- 回调是在删除任务的内存即将被释放前调用的。因此，回调可以通过 `vTaskDelete()` 本身调用，也可以从空闲任务中调用。



## IDF 附加 API

`freertos/esp_additions/include/freertos/idf_additions.h` 头文件包含了 ESP-IDF 添加的与 FreeRTOS 相关的辅助函数。通过 `#include "freertos/idf_additions.h"` 可添加此头文件。

## 组件专用功能

除了基本 CMake 构建属性中提供的标准组件变量外，FreeRTOS 组件还提供了参数（目前只有一个参数）以简化与其他模块的集成：

- `ORIG_INCLUDE_PATH` - 包含指向 freeRTOS 根包含文件夹的绝对路径。因此可以直接用 `#include "FreeRTOS.h"` 引用头文件，而无需使用 `#include "freertos/FreeRTOS.h"`。

## API 参考

### 环形 buffer API

#### Header File

- `components/esp_ringbuf/include/freertos/ringbuf.h`
- This header file can be included with:

```
#include "freertos/ringbuf.h"
```

- This header file is a part of the API provided by the `esp_ringbuf` component. To declare that your component depends on `esp_ringbuf`, add the following to your `CMakeLists.txt`:

```
REQUIRES esp_ringbuf
```

or

```
PRIV_REQUIRES esp_ringbuf
```

#### Functions

`RingbufHandle_t xRingbufferCreate` (`size_t xBufferSize`, `RingbufferType_t xBufferType`)

Create a ring buffer.

---

**备注：** `xBufferSize` of no-split/allow-split buffers will be rounded up to the nearest 32-bit aligned size.

---

#### 参数

- **`xBufferSize`** -- **[in]** Size of the buffer in bytes. Note that items require space for a header in no-split/allow-split buffers
- **`xBufferType`** -- **[in]** Type of ring buffer, see documentation.

**返回** A handle to the created ring buffer, or NULL in case of error.

`RingbufHandle_t xRingbufferCreateNoSplit` (`size_t xItemSize`, `size_t xItemNum`)

Create a ring buffer of type `RINGBUF_TYPE_NOSPLIT` for a fixed `item_size`.

This API is similar to `xRingbufferCreate()`, but it will internally allocate additional space for the headers.

#### 参数

- **`xItemSize`** -- **[in]** Size of each item to be put into the ring buffer
- **`xItemNum`** -- **[in]** Maximum number of items the buffer needs to hold simultaneously

**返回** A `RingbufHandle_t` handle to the created ring buffer, or NULL in case of error.

---

*RingbufHandle\_t* **xRingbufferCreateStatic** (size\_t xBufferSize, *RingbufferType\_t* xBufferType, uint8\_t \*pucRingbufferStorage, *StaticRingbuffer\_t* \*pxStaticRingbuffer)

Create a ring buffer but manually provide the required memory.

---

**备注:** xBufferSize of no-split/allow-split buffers MUST be 32-bit aligned.

---

#### 参数

- **xBufferSize** -- [in] Size of the buffer in bytes.
- **xBufferType** -- [in] Type of ring buffer, see documentation
- **pucRingbufferStorage** -- [in] Pointer to the ring buffer's storage area. Storage area must have the same size as specified by xBufferSize
- **pxStaticRingbuffer** -- [in] Pointed to a struct of type *StaticRingbuffer\_t* which will be used to hold the ring buffer's data structure

**返回** A handle to the created ring buffer

BaseType\_t **xRingbufferSend** (*RingbufHandle\_t* xRingbuffer, const void \*pvItem, size\_t xItemSize, TickType\_t xTicksToWait)

Insert an item into the ring buffer.

Attempt to insert an item into the ring buffer. This function will block until enough free space is available or until it times out.

---

**备注:** For no-split/allow-split ring buffers, the actual size of memory that the item will occupy will be rounded up to the nearest 32-bit aligned size. This is done to ensure all items are always stored in 32-bit aligned fashion.

---



---

**备注:** For no-split/allow-split buffers, an xItemSize of 0 will result in an item with no data being set (i.e., item only contains the header). For byte buffers, an xItemSize of 0 will simply return pdTRUE without copying any data.

---

#### 参数

- **xRingbuffer** -- [in] Ring buffer to insert the item into
- **pvItem** -- [in] Pointer to data to insert. NULL is allowed if xItemSize is 0.
- **xItemSize** -- [in] Size of data to insert.
- **xTicksToWait** -- [in] Ticks to wait for room in the ring buffer.

#### 返回

- pdTRUE if succeeded
- pdFALSE on time-out or when the data is larger than the maximum permissible size of the buffer

BaseType\_t **xRingbufferSendFromISR** (*RingbufHandle\_t* xRingbuffer, const void \*pvItem, size\_t xItemSize, BaseType\_t \*pxHigherPriorityTaskWoken)

Insert an item into the ring buffer in an ISR.

Attempt to insert an item into the ring buffer from an ISR. This function will return immediately if there is insufficient free space in the buffer.

---

**备注:** For no-split/allow-split ring buffers, the actual size of memory that the item will occupy will be rounded up to the nearest 32-bit aligned size. This is done to ensure all items are always stored in 32-bit aligned fashion.

---



---

**备注:** For no-split/allow-split buffers, an xItemSize of 0 will result in an item with no data being set (i.e., item only contains the header). For byte buffers, an xItemSize of 0 will simply return pdTRUE without copying any

data.

---

#### 参数

- **xRingbuffer** -- [in] Ring buffer to insert the item into
- **pvItem** -- [in] Pointer to data to insert. NULL is allowed if xItemSize is 0.
- **xItemSize** -- [in] Size of data to insert.
- **pxHigherPriorityTaskWoken** -- [out] Value pointed to will be set to pdTRUE if the function woke up a higher priority task.

#### 返回

- pdTRUE if succeeded
- pdFALSE when the ring buffer does not have space.

BaseType\_t **xRingbufferSendAcquire** (*RingbufHandle\_t* xRingbuffer, void \*\*ppvItem, size\_t xItemSize, TickType\_t xTicksToWait)

Acquire memory from the ring buffer to be written to by an external source and to be sent later.

Attempt to allocate buffer for an item to be sent into the ring buffer. This function will block until enough free space is available or until it times out.

The item, as well as the following items `SendAcquire` or `Send` after it, will not be able to be read from the ring buffer until this item is actually sent into the ring buffer.

---

**备注:** Only applicable for no-split ring buffers now, the actual size of memory that the item will occupy will be rounded up to the nearest 32-bit aligned size. This is done to ensure all items are always stored in 32-bit aligned fashion.

---

---

**备注:** An xItemSize of 0 will result in a buffer being acquired, but the buffer will have a size of 0.

---

#### 参数

- **xRingbuffer** -- [in] Ring buffer to allocate the memory
- **ppvItem** -- [out] Double pointer to memory acquired (set to NULL if no memory were retrieved)
- **xItemSize** -- [in] Size of item to acquire.
- **xTicksToWait** -- [in] Ticks to wait for room in the ring buffer.

#### 返回

- pdTRUE if succeeded
- pdFALSE on time-out or when the data is larger than the maximum permissible size of the buffer

BaseType\_t **xRingbufferSendComplete** (*RingbufHandle\_t* xRingbuffer, void \*pvItem)

Actually send an item into the ring buffer allocated before by `xRingbufferSendAcquire`.

---

**备注:** Only applicable for no-split ring buffers. Only call for items allocated by `xRingbufferSendAcquire`.

---

#### 参数

- **xRingbuffer** -- [in] Ring buffer to insert the item into
- **pvItem** -- [in] Pointer to item in allocated memory to insert.

#### 返回

- pdTRUE if succeeded
- pdFALSE if fail for some reason.

void **\*xRingbufferReceive** (*RingbufHandle\_t* xRingbuffer, size\_t \*pxItemSize, TickType\_t xTicksToWait)

Retrieve an item from the ring buffer.

Attempt to retrieve an item from the ring buffer. This function will block until an item is available or until it times out.

---

**备注:** A call to `vRingbufferReturnItem()` is required after this to free the item retrieved.

---



---

**备注:** It is possible to receive items with a `pxItemSize` of 0 on no-split/allow split buffers.

---

#### 参数

- **xRingbuffer** -- [in] Ring buffer to retrieve the item from
- **pxItemSize** -- [out] Pointer to a variable to which the size of the retrieved item will be written.
- **xTicksToWait** -- [in] Ticks to wait for items in the ring buffer.

#### 返回

- Pointer to the retrieved item on success; `*pxItemSize` filled with the length of the item.
- NULL on timeout, `*pxItemSize` is untouched in that case.

void **\*xRingbufferReceiveFromISR** (*RingbufHandle\_t* xRingbuffer, size\_t \*pxItemSize)

Retrieve an item from the ring buffer in an ISR.

Attempt to retrieve an item from the ring buffer. This function returns immediately if there are no items available for retrieval

---

**备注:** A call to `vRingbufferReturnItemFromISR()` is required after this to free the item retrieved.

---



---

**备注:** Byte buffers do not allow multiple retrievals before returning an item

---



---

**备注:** Two calls to `RingbufferReceiveFromISR()` are required if the bytes wrap around the end of the ring buffer.

---



---

**备注:** It is possible to receive items with a `pxItemSize` of 0 on no-split/allow split buffers.

---

#### 参数

- **xRingbuffer** -- [in] Ring buffer to retrieve the item from
- **pxItemSize** -- [out] Pointer to a variable to which the size of the retrieved item will be written.

#### 返回

- Pointer to the retrieved item on success; `*pxItemSize` filled with the length of the item.
- NULL when the ring buffer is empty, `*pxItemSize` is untouched in that case.

BaseType\_t **xRingbufferReceiveSplit** (*RingbufHandle\_t* xRingbuffer, void \*\*ppvHeadItem, void \*\*ppvTailItem, size\_t \*pxHeadItemSize, size\_t \*pxTailItemSize, TickType\_t xTicksToWait)

Retrieve a split item from an allow-split ring buffer.

Attempt to retrieve a split item from an allow-split ring buffer. If the item is not split, only a single item is retrieved. If the item is split, both parts will be retrieved. This function will block until an item is available or until it times out.

---

**备注:** Call(s) to `vRingbufferReturnItem()` is required after this to free up the item(s) retrieved.

---

---

**备注:** This function should only be called on allow-split buffers

---

---

**备注:** It is possible to receive items with a `pxItemSize` of 0 on allow split buffers.

---

#### 参数

- **xRingbuffer** -- **[in]** Ring buffer to retrieve the item from
- **ppvHeadItem** -- **[out]** Double pointer to first part (set to NULL if no items were retrieved)
- **ppvTailItem** -- **[out]** Double pointer to second part (set to NULL if item is not split)
- **pxHeadItemSize** -- **[out]** Pointer to size of first part (unmodified if no items were retrieved)
- **pxTailItemSize** -- **[out]** Pointer to size of second part (unmodified if item is not split)
- **xTicksToWait** -- **[in]** Ticks to wait for items in the ring buffer.

#### 返回

- `pdTRUE` if an item (split or unsplit) was retrieved
- `pdFALSE` when no item was retrieved

BaseType\_t **xRingbufferReceiveSplitFromISR** (*RingbufHandle\_t* xRingbuffer, void \*\*ppvHeadItem, void \*\*ppvTailItem, size\_t \*pxHeadItemSize, size\_t \*pxTailItemSize)

Retrieve a split item from an allow-split ring buffer in an ISR.

Attempt to retrieve a split item from an allow-split ring buffer. If the item is not split, only a single item is retrieved. If the item is split, both parts will be retrieved. This function returns immediately if there are no items available for retrieval

---

**备注:** Calls to `vRingbufferReturnItemFromISR()` is required after this to free up the item(s) retrieved.

---

---

**备注:** This function should only be called on allow-split buffers

---

---

**备注:** It is possible to receive items with a `pxItemSize` of 0 on allow split buffers.

---

#### 参数

- **xRingbuffer** -- **[in]** Ring buffer to retrieve the item from
- **ppvHeadItem** -- **[out]** Double pointer to first part (set to NULL if no items were retrieved)
- **ppvTailItem** -- **[out]** Double pointer to second part (set to NULL if item is not split)
- **pxHeadItemSize** -- **[out]** Pointer to size of first part (unmodified if no items were retrieved)
- **pxTailItemSize** -- **[out]** Pointer to size of second part (unmodified if item is not split)

#### 返回

- `pdTRUE` if an item (split or unsplit) was retrieved
- `pdFALSE` when no item was retrieved

```
void *xRingbufferReceiveUpTo (RingbufHandle_t xRingbuffer, size_t *pxItemSize, TickType_t  
xTicksToWait, size_t xMaxSize)
```

Retrieve bytes from a byte buffer, specifying the maximum amount of bytes to retrieve.

Attempt to retrieve data from a byte buffer whilst specifying a maximum number of bytes to retrieve. This function will block until there is data available for retrieval or until it times out.

---

**备注:** A call to `vRingbufferReturnItem()` is required after this to free up the data retrieved.

---

---

**备注:** This function should only be called on byte buffers

---

---

**备注:** Byte buffers do not allow multiple retrievals before returning an item

---

---

**备注:** Two calls to `RingbufferReceiveUpTo()` are required if the bytes wrap around the end of the ring buffer.

---

#### 参数

- **xRingbuffer** -- [in] Ring buffer to retrieve the item from
- **pxItemSize** -- [out] Pointer to a variable to which the size of the retrieved item will be written.
- **xTicksToWait** -- [in] Ticks to wait for items in the ring buffer.
- **xMaxSize** -- [in] Maximum number of bytes to return.

#### 返回

- Pointer to the retrieved item on success; `*pxItemSize` filled with the length of the item.
- NULL on timeout, `*pxItemSize` is untouched in that case.

```
void *xRingbufferReceiveUpToFromISR (RingbufHandle_t xRingbuffer, size_t *pxItemSize, size_t  
xMaxSize)
```

Retrieve bytes from a byte buffer, specifying the maximum amount of bytes to retrieve. Call this from an ISR.

Attempt to retrieve bytes from a byte buffer whilst specifying a maximum number of bytes to retrieve. This function will return immediately if there is no data available for retrieval.

---

**备注:** A call to `vRingbufferReturnItemFromISR()` is required after this to free up the data received.

---

---

**备注:** This function should only be called on byte buffers

---

---

**备注:** Byte buffers do not allow multiple retrievals before returning an item

---

#### 参数

- **xRingbuffer** -- [in] Ring buffer to retrieve the item from
- **pxItemSize** -- [out] Pointer to a variable to which the size of the retrieved item will be written.
- **xMaxSize** -- [in] Maximum number of bytes to return. Size of 0 simply returns NULL.

#### 返回

- Pointer to the retrieved item on success; `*pxItemSize` filled with the length of the item.
- NULL when the ring buffer is empty, `*pxItemSize` is untouched in that case.

void **vRingbufferReturnItem** (*RingbufHandle\_t* xRingbuffer, void \*pvItem)

Return a previously-retrieved item to the ring buffer.

---

**备注:** If a split item is retrieved, both parts should be returned by calling this function twice

---

**参数**

- **xRingbuffer** -- **[in]** Ring buffer the item was retrieved from
- **pvItem** -- **[in]** Item that was received earlier

void **vRingbufferReturnItemFromISR** (*RingbufHandle\_t* xRingbuffer, void \*pvItem, BaseType\_t \*pxHigherPriorityTaskWoken)

Return a previously-retrieved item to the ring buffer from an ISR.

---

**备注:** If a split item is retrieved, both parts should be returned by calling this function twice

---

**参数**

- **xRingbuffer** -- **[in]** Ring buffer the item was retrieved from
- **pvItem** -- **[in]** Item that was received earlier
- **pxHigherPriorityTaskWoken** -- **[out]** Value pointed to will be set to pdTRUE if the function woke up a higher priority task.

void **vRingbufferDelete** (*RingbufHandle\_t* xRingbuffer)

Delete a ring buffer.

---

**备注:** This function will not deallocate any memory if the ring buffer was created using `xRingbufferCreateStatic()`. Deallocation must be done manually by the user.

---

**参数** **xRingbuffer** -- **[in]** Ring buffer to delete

size\_t **xRingbufferGetMaxItemSize** (*RingbufHandle\_t* xRingbuffer)

Get maximum size of an item that can be placed in the ring buffer.

This function returns the maximum size an item can have if it was placed in an empty ring buffer.

---

**备注:** The max item size for a no-split buffer is limited to  $((\text{buffer\_size}/2) - \text{header\_size})$ . This limit is imposed so that an item of max item size can always be sent to an empty no-split buffer regardless of the internal positions of the buffer's read/write/free pointers.

---

**参数** **xRingbuffer** -- **[in]** Ring buffer to query

**返回** Maximum size, in bytes, of an item that can be placed in a ring buffer.

size\_t **xRingbufferGetCurFreeSize** (*RingbufHandle\_t* xRingbuffer)

Get current free size available for an item/data in the buffer.

This gives the real time free space available for an item/data in the ring buffer. This represents the maximum size an item/data can have if it was currently sent to the ring buffer.

---

**备注:** An empty no-split buffer has a max current free size for an item that is limited to  $((\text{buffer\_size}/2) - \text{header\_size})$ . See API reference for `xRingbufferGetMaxItemSize()`.

---

**警告:** This API is not thread safe. So, if multiple threads are accessing the same ring buffer, it is the application's responsibility to ensure atomic access to this API and the subsequent Send

**参数** **xRingbuffer** -- [in] Ring buffer to query  
**返回** Current free size, in bytes, available for an entry

BaseType\_t **xRingbufferAddToQueueSetRead** (*RingbufHandle\_t* xRingbuffer, *QueueSetHandle\_t* xQueueSet)

Add the ring buffer to a queue set. Notified when data has been written to the ring buffer.

This function adds the ring buffer to a queue set, thus allowing a task to block on multiple queues/ring buffers. The queue set is notified when the new data becomes available to read on the ring buffer.

**参数**

- **xRingbuffer** -- [in] Ring buffer to add to the queue set
- **xQueueSet** -- [in] Queue set to add the ring buffer to

**返回**

- pdTRUE on success, pdFALSE otherwise

static inline BaseType\_t **xRingbufferCanRead** (*RingbufHandle\_t* xRingbuffer, *QueueSetMemberHandle\_t* xMember)

Check if the selected queue set member is a particular ring buffer.

This API checks if queue set member returned from xQueueSelectFromSet() is a particular ring buffer. If so, this indicates the ring buffer has items waiting to be retrieved.

**参数**

- **xRingbuffer** -- [in] Ring buffer to check
- **xMember** -- [in] Member returned from xQueueSelectFromSet

**返回**

- pdTRUE when selected queue set member is the ring buffer
- pdFALSE otherwise.

BaseType\_t **xRingbufferRemoveFromQueueSetRead** (*RingbufHandle\_t* xRingbuffer, *QueueSetHandle\_t* xQueueSet)

Remove the ring buffer from a queue set.

This function removes a ring buffer from a queue set. The ring buffer must have been previously added to the queue set using xRingbufferAddToQueueSetRead().

**参数**

- **xRingbuffer** -- [in] Ring buffer to remove from the queue set
- **xQueueSet** -- [in] Queue set to remove the ring buffer from

**返回**

- pdTRUE on success
- pdFALSE otherwise

void **vRingbufferGetInfo** (*RingbufHandle\_t* xRingbuffer, UBaseType\_t \*uxFree, UBaseType\_t \*uxRead, UBaseType\_t \*uxWrite, UBaseType\_t \*uxAcquire, UBaseType\_t \*uxItemsWaiting)

Get information about ring buffer status.

Get information of a ring buffer's current status such as free/read/write/acquire pointer positions, and number of items waiting to be retrieved. Arguments can be set to NULL if they are not required.

**参数**

- **xRingbuffer** -- [in] Ring buffer handle
- **uxFree** -- [out] Pointer use to store free pointer position
- **uxRead** -- [out] Pointer use to store read pointer position
- **uxWrite** -- [out] Pointer use to store write pointer position
- **uxAcquire** -- [out] Pointer use to store acquire pointer position



- **uxItemsWaiting** -- **[out]** Pointer use to store number of items (bytes for byte buffer) waiting to be retrieved

void **xRingbufferPrintInfo** (*RingbufHandle\_t* xRingbuffer)

Debugging function to print the internal pointers in the ring buffer.

**参数** **xRingbuffer** -- Ring buffer to show

BaseType\_t **xRingbufferGetStaticBuffer** (*RingbufHandle\_t* xRingbuffer, uint8\_t \*\*ppucRingbufferStorage, *StaticRingbuffer\_t* \*\*ppxStaticRingbuffer)

Retrieve the pointers to a statically created ring buffer.

**参数**

- **xRingbuffer** -- **[in]** Ring buffer
- **ppucRingbufferStorage** -- **[out]** Used to return a pointer to the queue's storage area buffer
- **ppxStaticRingbuffer** -- **[out]** Used to return a pointer to the queue's data structure buffer

**返回** pdTRUE if buffers were retrieved, pdFALSE otherwise.

*RingbufHandle\_t* **xRingbufferCreateWithCaps** (size\_t xBufferSize, *RingbufferType\_t* xBufferType, UBaseType\_t uxMemoryCaps)

Creates a ring buffer with specific memory capabilities.

This function is similar to xRingbufferCreate(), except that it allows the memory allocated for the ring buffer to have specific capabilities (e.g., MALLOC\_CAP\_INTERNAL).

---

**备注:** A queue created using this function must only be deleted using vRingbufferDeleteWithCaps()

---

**参数**

- **xBufferSize** -- **[in]** Size of the buffer in bytes
- **xBufferType** -- **[in]** Type of ring buffer, see documentation.
- **uxMemoryCaps** -- **[in]** Memory capabilities of the queue's memory (see esp\_heap\_caps.h)

**返回** Handle to the created ring buffer or NULL on failure.

void **vRingbufferDeleteWithCaps** (*RingbufHandle\_t* xRingbuffer)

Deletes a ring buffer previously created using xRingbufferCreateWithCaps()

**参数** **xRingbuffer** -- Ring buffer

## Structures

struct **xSTATIC\_RINGBUFFER**

Struct that is equivalent in size to the ring buffer's data structure.

The contents of this struct are not meant to be used directly. This structure is meant to be used when creating a statically allocated ring buffer where this struct is of the exact size required to store a ring buffer's control data structure.

## Type Definitions

typedef void \***RingbufHandle\_t**

Type by which ring buffers are referenced. For example, a call to xRingbufferCreate() returns a RingbufHandle\_t variable that can then be used as a parameter to xRingbufferSend(), xRingbufferReceive(), etc.

typedef struct *xSTATIC\_RINGBUFFER* **StaticRingbuffer\_t**

Struct that is equivalent in size to the ring buffer's data structure.

The contents of this struct are not meant to be used directly. This structure is meant to be used when creating a statically allocated ring buffer where this struct is of the exact size required to store a ring buffer's control data structure.

## Enumerations

enum **RingbufferType\_t**

*Values:*

enumerator **RINGBUF\_TYPE\_NOSPLIT**

No-split buffers will only store an item in contiguous memory and will never split an item. Each item requires an 8 byte overhead for a header and will always internally occupy a 32-bit aligned size of space.

enumerator **RINGBUF\_TYPE\_ALLOWSPLIT**

Allow-split buffers will split an item into two parts if necessary in order to store it. Each item requires an 8 byte overhead for a header, splitting incurs an extra header. Each item will always internally occupy a 32-bit aligned size of space.

enumerator **RINGBUF\_TYPE\_BYTEBUF**

Byte buffers store data as a sequence of bytes and do not maintain separate items, therefore byte buffers have no overhead. All data is stored as a sequence of byte and any number of bytes can be sent or retrieved each time.

enumerator **RINGBUF\_TYPE\_MAX**

## 钩子 API

### Header File

- `components/esp_system/include/esp_freertos_hooks.h`
- This header file can be included with:

```
#include "esp_freertos_hooks.h"
```

### Functions

*esp\_err\_t* **esp\_register\_freertos\_idle\_hook\_for\_cpu** (*esp\_freertos\_idle\_cb\_t* new\_idle\_cb, UBaseType\_t cpuid)

Register a callback to be called from the specified core's idle hook. The callback should return true if it should be called by the idle hook once per interrupt (or FreeRTOS tick), and return false if it should be called repeatedly as fast as possible by the idle hook.

**警告:** Idle callbacks MUST NOT, UNDER ANY CIRCUMSTANCES, CALL A FUNCTION THAT MIGHT BLOCK.

#### 参数

- **new\_idle\_cb** -- [in] Callback to be called
- **cpuid** -- [in] id of the core

#### 返回

- ESP\_OK: Callback registered to the specified core's idle hook
- ESP\_ERR\_NO\_MEM: No more space on the specified core's idle hook to register callback
- ESP\_ERR\_INVALID\_ARG: cpuid is invalid

*esp\_err\_t* **esp\_register\_freertos\_idle\_hook** (*esp\_freertos\_idle\_cb\_t* new\_idle\_cb)

Register a callback to the idle hook of the core that calls this function. The callback should return true if it should be called by the idle hook once per interrupt (or FreeRTOS tick), and return false if it should be called repeatedly as fast as possible by the idle hook.

**警告:** Idle callbacks MUST NOT, UNDER ANY CIRCUMSTANCES, CALL A FUNCTION THAT MIGHT BLOCK.

**参数** **new\_idle\_cb** -- [in] Callback to be called

**返回**

- ESP\_OK: Callback registered to the calling core's idle hook
- ESP\_ERR\_NO\_MEM: No more space on the calling core's idle hook to register callback

*esp\_err\_t* **esp\_register\_freertos\_tick\_hook\_for\_cpu** (*esp\_freertos\_tick\_cb\_t* new\_tick\_cb, UBaseType\_t cpuid)

Register a callback to be called from the specified core's tick hook.

**参数**

- **new\_tick\_cb** -- [in] Callback to be called
- **cpuid** -- [in] id of the core

**返回**

- ESP\_OK: Callback registered to specified core's tick hook
- ESP\_ERR\_NO\_MEM: No more space on the specified core's tick hook to register the callback
- ESP\_ERR\_INVALID\_ARG: cpuid is invalid

*esp\_err\_t* **esp\_register\_freertos\_tick\_hook** (*esp\_freertos\_tick\_cb\_t* new\_tick\_cb)

Register a callback to be called from the calling core's tick hook.

**参数** **new\_tick\_cb** -- [in] Callback to be called

**返回**

- ESP\_OK: Callback registered to the calling core's tick hook
- ESP\_ERR\_NO\_MEM: No more space on the calling core's tick hook to register the callback

void **esp\_deregister\_freertos\_idle\_hook\_for\_cpu** (*esp\_freertos\_idle\_cb\_t* old\_idle\_cb, UBaseType\_t cpuid)

Unregister an idle callback from the idle hook of the specified core.

**参数**

- **old\_idle\_cb** -- [in] Callback to be unregistered
- **cpuid** -- [in] id of the core

void **esp\_deregister\_freertos\_idle\_hook** (*esp\_freertos\_idle\_cb\_t* old\_idle\_cb)

Unregister an idle callback. If the idle callback is registered to the idle hooks of both cores, the idle hook will be unregistered from both cores.

**参数** **old\_idle\_cb** -- [in] Callback to be unregistered

void **esp\_deregister\_freertos\_tick\_hook\_for\_cpu** (*esp\_freertos\_tick\_cb\_t* old\_tick\_cb, UBaseType\_t cpuid)

Unregister a tick callback from the tick hook of the specified core.

**参数**

- **old\_tick\_cb** -- [in] Callback to be unregistered

- **cpuid** -- [in] id of the core

void **esp\_deregister\_freertos\_tick\_hook** (*esp\_freertos\_tick\_cb\_t* old\_tick\_cb)

Unregister a tick callback. If the tick callback is registered to the tick hooks of both cores, the tick hook will be unregistered from both cores.

参数 **old\_tick\_cb** -- [in] Callback to be unregistered

## Type Definitions

```
typedef bool (*esp_freertos_idle_cb_t)(void)
```

```
typedef void (*esp_freertos_tick_cb_t)(void)
```

## 附加 API

### Header File

- [components/freertos/esp\\_additions/include/freertos/idf\\_additions.h](#)
- This header file can be included with:

```
#include "freertos/idf_additions.h"
```

## Functions

BaseType\_t **xTaskCreatePinnedToCore** (TaskFunction\_t pxTaskCode, const char \*const pcName, const uint32\_t ulStackDepth, void \*const pvParameters, UBaseType\_t uxPriority, *TaskHandle\_t* \*const pxCreatedTask, const BaseType\_t xCoreID)

Create a new task that is pinned to a particular core.

This function is similar to `xTaskCreate()`, but allows the creation of a pinned task. The task's pinned core is specified by the `xCoreID` argument. If `xCoreID` is set to `tskNO_AFFINITY`, then the task is unpinned and can run on any core.

---

备注: If ( `configNUMBER_OF_CORES == 1` ), setting `xCoreID` to `tskNO_AFFINITY` will be treated as 0.

---

### 参数

- **pxTaskCode** -- Pointer to the task entry function.
- **pcName** -- A descriptive name for the task.
- **ulStackDepth** -- The size of the task stack specified as the NUMBER OF BYTES. Note that this differs from vanilla FreeRTOS.
- **pvParameters** -- Pointer that will be used as the parameter for the task being created.
- **uxPriority** -- The priority at which the task should run.
- **pxCreatedTask** -- Used to pass back a handle by which the created task can be referenced.
- **xCoreID** -- The core to which the task is pinned to, or `tskNO_AFFINITY` if the task has no core affinity.

返回 `pdPASS` if the task was successfully created and added to a ready list, otherwise an error code defined in the file `projdefs.h`

*TaskHandle\_t* **xTaskCreateStaticPinnedToCore** (TaskFunction\_t pxTaskCode, const char \*const pcName, const uint32\_t ulStackDepth, void \*const pvParameters, UBaseType\_t uxPriority, StackType\_t \*const puxStackBuffer, StaticTask\_t \*const pxTaskBuffer, const BaseType\_t xCoreID)

Create a new static task that is pinned to a particular core.

This function is similar to `xTaskCreateStatic()`, but allows the creation of a pinned task. The task's pinned core is specified by the `xCoreID` argument. If `xCoreID` is set to `tskNO_AFFINITY`, then the task is unpinned and can run on any core.

---

**备注:** If ( `configNUMBER_OF_CORES == 1` ), setting `xCoreID` to `tskNO_AFFINITY` will be treated as 0.

---

#### 参数

- **pxTaskCode** -- Pointer to the task entry function.
- **pcName** -- A descriptive name for the task.
- **ulStackDepth** -- The size of the task stack specified as the NUMBER OF BYTES. Note that this differs from vanilla FreeRTOS.
- **pvParameters** -- Pointer that will be used as the parameter for the task being created.
- **uxPriority** -- The priority at which the task should run.
- **pxStackBuffer** -- Must point to a `StackType_t` array that has at least `ulStackDepth` indexes
- **pxTaskBuffer** -- Must point to a variable of type `StaticTask_t`, which will then be used to hold the task's data structures,
- **xCoreID** -- The core to which the task is pinned to, or `tskNO_AFFINITY` if the task has no core affinity.

**返回** The task handle if the task was created, NULL otherwise.

`BaseType_t` **xTaskGetCoreID** (*TaskHandle\_t* xTask)

Get the current core ID of a particular task.

Helper function to get the core ID of a particular task. If the task is pinned to a particular core, the core ID is returned. If the task is not pinned to a particular core, `tskNO_AFFINITY` is returned.

If `CONFIG_FREERTOS_UNICORE` is enabled, this function simply returns 0.

[refactor-todo] See if this needs to be deprecated (IDF-8145)(IDF-8164)

---

**备注:** If `CONFIG_FREERTOS_SMP` is enabled, please call `vTaskCoreAffinityGet()` instead.

---



---

**备注:** In IDF FreeRTOS when `configNUMBER_OF_CORES == 1`, this function will always return 0,

---

**参数** **xTask** -- The task to query

**返回** The task's core ID or `tskNO_AFFINITY`

*TaskHandle\_t* **xTaskGetCurrentTaskHandleForCore** (`BaseType_t` xCoreID)

Get the handle of the task currently running on a certain core.

Because of the nature of SMP processing, there is no guarantee that this value will still be valid on return and should only be used for debugging purposes.

[refactor-todo] See if this needs to be deprecated (IDF-8145)

**参数** **xCoreID** -- The core to query

**返回** Handle of the current task running on the queried core

`uint8_t *`**pxTaskGetStackStart** (*TaskHandle\_t* xTask)

Returns the start of the stack associated with xTask.

Returns the lowest stack memory address, regardless of whether the stack grows up or down.

[refactor-todo] Change return type to StackType\_t (IDF-8158)

**参数** **xTask** -- Handle of the task associated with the stack returned. Set xTask to NULL to return the stack of the calling task.

**返回** A pointer to the start of the stack.

```
void vTaskSetThreadLocalStoragePointerAndDelCallback (TaskHandle_t xTaskToSet,
                                                    BaseType_t xIndex, void *pvValue,
                                                    TlsDeleteCallbackFunction_t
                                                    pvDelCallback)
```

Set local storage pointer and deletion callback.

Each task contains an array of pointers that is dimensioned by the configNUM\_THREAD\_LOCAL\_STORAGE\_POINTERS setting in FreeRTOSConfig.h. The kernel does not use the pointers itself, so the application writer can use the pointers for any purpose they wish.

Local storage pointers set for a task can reference dynamically allocated resources. This function is similar to vTaskSetThreadLocalStoragePointer, but provides a way to release these resources when the task gets deleted. For each pointer, a callback function can be set. This function will be called when task is deleted, with the local storage pointer index and value as arguments.

#### 参数

- **xTaskToSet** -- Task to set thread local storage pointer for
- **xIndex** -- The index of the pointer to set, from 0 to configNUM\_THREAD\_LOCAL\_STORAGE\_POINTERS - 1.
- **pvValue** -- Pointer value to set.
- **pvDelCallback** -- Function to call to dispose of the local storage pointer when the task is deleted.

```
BaseType_t xTaskCreatePinnedToCoreWithCaps (TaskFunction_t pvTaskCode, const char *const
                                           pcName, const configSTACK_DEPTH_TYPE
                                           usStackDepth, void *const pvParameters,
                                           UBaseType_t uxPriority, TaskHandle_t *const
                                           pvCreatedTask, const BaseType_t xCoreID,
                                           UBaseType_t uxMemoryCaps)
```

Creates a pinned task where its stack has specific memory capabilities.

This function is similar to xTaskCreatePinnedToCore(), except that it allows the memory allocated for the task's stack to have specific capabilities (e.g., MALLOC\_CAP\_SPIRAM).

However, the specified capabilities will NOT apply to the task's TCB as a TCB must always be in internal RAM.

#### 参数

- **pvTaskCode** -- Pointer to the task entry function
- **pcName** -- A descriptive name for the task
- **usStackDepth** -- The size of the task stack specified as the number of bytes
- **pvParameters** -- Pointer that will be used as the parameter for the task being created.
- **uxPriority** -- The priority at which the task should run.
- **pvCreatedTask** -- Used to pass back a handle by which the created task can be referenced.
- **xCoreID** -- Core to which the task is pinned to, or tskNO\_AFFINITY if unpinned.
- **uxMemoryCaps** -- Memory capabilities of the task stack's memory (see esp\_heap\_caps.h)

**返回** pdPASS if the task was successfully created and added to a ready list, otherwise an error code defined in the file projdefs.h

```
static inline BaseType_t xTaskCreateWithCaps (TaskFunction_t pvTaskCode, const char *const pcName,
                                             configSTACK_DEPTH_TYPE usStackDepth, void *const
                                             pvParameters, UBaseType_t uxPriority, TaskHandle_t
                                             *pvCreatedTask, UBaseType_t uxMemoryCaps)
```

Creates a task where its stack has specific memory capabilities.

This function is similar to `xTaskCreate()`, except that it allows the memory allocated for the task's stack to have specific capabilities (e.g., `MALLOC_CAP_SPIRAM`).

However, the specified capabilities will NOT apply to the task's TCB as a TCB must always be in internal RAM.

---

**备注:** A task created using this function must only be deleted using `vTaskDeleteWithCaps()`

---

#### 参数

- **pvTaskCode** -- Pointer to the task entry function
- **pcName** -- A descriptive name for the task
- **usStackDepth** -- The size of the task stack specified as the number of bytes
- **pvParameters** -- Pointer that will be used as the parameter for the task being created.
- **uxPriority** -- The priority at which the task should run.
- **pvCreatedTask** -- Used to pass back a handle by which the created task can be referenced.
- **uxMemoryCaps** -- Memory capabilities of the task stack's memory (see `esp_heap_caps.h`)

**返回** `pdPASS` if the task was successfully created and added to a ready list, otherwise an error code defined in the file `projdefs.h`

void **vTaskDeleteWithCaps** (*TaskHandle\_t* xTaskToDelete)

Deletes a task previously created using `xTaskCreateWithCaps()` or `xTaskCreatePinnedToCoreWithCaps()`

---

**备注:** It is recommended to use this API to delete tasks from another task's context, rather than self-deletion. When the task is being deleted, it is vital to ensure that it is not running on another core. This API must not be called from an interrupt context.

---

**参数** **xTaskToDelete** -- A handle to the task to be deleted

*QueueHandle\_t* **xQueueCreateWithCaps** (*UBaseType\_t* uxQueueLength, *UBaseType\_t* uxItemSize, *UBaseType\_t* uxMemoryCaps)

Creates a queue with specific memory capabilities.

This function is similar to `xQueueCreate()`, except that it allows the memory allocated for the queue to have specific capabilities (e.g., `MALLOC_CAP_INTERNAL`).

---

**备注:** A queue created using this function must only be deleted using `vQueueDeleteWithCaps()`

---

#### 参数

- **uxQueueLength** -- The maximum number of items that the queue can contain.
- **uxItemSize** -- The number of bytes each item in the queue will require.
- **uxMemoryCaps** -- Memory capabilities of the queue's memory (see `esp_heap_caps.h`)

**返回** Handle to the created queue or `NULL` on failure.

void **vQueueDeleteWithCaps** (*QueueHandle\_t* xQueue)

Deletes a queue previously created using `xQueueCreateWithCaps()`

**参数** **xQueue** -- A handle to the queue to be deleted.

static inline *SemaphoreHandle\_t* **xSemaphoreCreateBinaryWithCaps** (*UBaseType\_t* uxMemoryCaps)

Creates a binary semaphore with specific memory capabilities.

This function is similar to `vSemaphoreCreateBinary()`, except that it allows the memory allocated for the binary semaphore to have specific capabilities (e.g., `MALLOC_CAP_INTERNAL`).



---

**备注:** A binary semaphore created using this function must only be deleted using `vSemaphoreDeleteWithCaps()`

---

**参数 `uxMemoryCaps`** -- Memory capabilities of the binary semaphore's memory (see `esp_heap_caps.h`)

**返回** Handle to the created binary semaphore or NULL on failure.

```
static inline SemaphoreHandle_t xSemaphoreCreateCountingWithCaps (UBaseType_t uxMaxCount,  
                                                                UBaseType_t uxInitialCount,  
                                                                UBaseType_t uxMemoryCaps)
```

Creates a counting semaphore with specific memory capabilities.

This function is similar to `xSemaphoreCreateCounting()`, except that it allows the memory allocated for the counting semaphore to have specific capabilities (e.g., `MALLOC_CAP_INTERNAL`).

---

**备注:** A counting semaphore created using this function must only be deleted using `vSemaphoreDeleteWithCaps()`

---

**参数**

- **`uxMaxCount`** -- The maximum count value that can be reached.
- **`uxInitialCount`** -- The count value assigned to the semaphore when it is created.
- **`uxMemoryCaps`** -- Memory capabilities of the counting semaphore's memory (see `esp_heap_caps.h`)

**返回** Handle to the created counting semaphore or NULL on failure.

```
static inline SemaphoreHandle_t xSemaphoreCreateMutexWithCaps (UBaseType_t uxMemoryCaps)
```

Creates a mutex semaphore with specific memory capabilities.

This function is similar to `xSemaphoreCreateMutex()`, except that it allows the memory allocated for the mutex semaphore to have specific capabilities (e.g., `MALLOC_CAP_INTERNAL`).

---

**备注:** A mutex semaphore created using this function must only be deleted using `vSemaphoreDeleteWithCaps()`

---

**参数 `uxMemoryCaps`** -- Memory capabilities of the mutex semaphore's memory (see `esp_heap_caps.h`)

**返回** Handle to the created mutex semaphore or NULL on failure.

```
static inline SemaphoreHandle_t xSemaphoreCreateRecursiveMutexWithCaps (UBaseType_t  
                                                                uxMemoryCaps)
```

Creates a recursive mutex with specific memory capabilities.

This function is similar to `xSemaphoreCreateRecursiveMutex()`, except that it allows the memory allocated for the recursive mutex to have specific capabilities (e.g., `MALLOC_CAP_INTERNAL`).

---

**备注:** A recursive mutex created using this function must only be deleted using `vSemaphoreDeleteWithCaps()`

---

**参数 `uxMemoryCaps`** -- Memory capabilities of the recursive mutex's memory (see `esp_heap_caps.h`)

**返回** Handle to the created recursive mutex or NULL on failure.



void **vSemaphoreDeleteWithCaps** (*SemaphoreHandle\_t* xSemaphore)

Deletes a semaphore previously created using one of the xSemaphoreCreate...WithCaps() functions.

**参数** **xSemaphore** -- A handle to the semaphore to be deleted.

static inline *StreamBufferHandle\_t* **xStreamBufferCreateWithCaps** (size\_t xBufferSizeBytes, size\_t xTriggerLevelBytes, UBaseType\_t uxMemoryCaps)

Creates a stream buffer with specific memory capabilities.

This function is similar to xStreamBufferCreate(), except that it allows the memory allocated for the stream buffer to have specific capabilities (e.g., MALLOC\_CAP\_INTERNAL).

---

**备注:** A stream buffer created using this function must only be deleted using vStreamBufferDeleteWithCaps()

---

**参数**

- **xBufferSizeBytes** -- The total number of bytes the stream buffer will be able to hold at any one time.
- **xTriggerLevelBytes** -- The number of bytes that must be in the stream buffer before unblocking
- **uxMemoryCaps** -- Memory capabilities of the stream buffer's memory (see esp\_heap\_caps.h)

**返回** Handle to the created stream buffer or NULL on failure.

static inline void **vStreamBufferDeleteWithCaps** (*StreamBufferHandle\_t* xStreamBuffer)

Deletes a stream buffer previously created using xStreamBufferCreateWithCaps()

**参数** **xStreamBuffer** -- A handle to the stream buffer to be deleted.

static inline *MessageBufferHandle\_t* **xMessageBufferCreateWithCaps** (size\_t xBufferSizeBytes, UBaseType\_t uxMemoryCaps)

Creates a message buffer with specific memory capabilities.

This function is similar to xMessageBufferCreate(), except that it allows the memory allocated for the message buffer to have specific capabilities (e.g., MALLOC\_CAP\_INTERNAL).

---

**备注:** A message buffer created using this function must only be deleted using vMessageBufferDeleteWithCaps()

---

**参数**

- **xBufferSizeBytes** -- The total number of bytes (not messages) the message buffer will be able to hold at any one time.
- **uxMemoryCaps** -- Memory capabilities of the message buffer's memory (see esp\_heap\_caps.h)

**返回** Handle to the created message buffer or NULL on failure.

static inline void **vMessageBufferDeleteWithCaps** (*MessageBufferHandle\_t* xMessageBuffer)

Deletes a stream buffer previously created using xMessageBufferCreateWithCaps()

**参数** **xMessageBuffer** -- A handle to the message buffer to be deleted.

*EventGroupHandle\_t* **xEventGroupCreateWithCaps** (UBaseType\_t uxMemoryCaps)

Creates an event group with specific memory capabilities.

This function is similar to xEventGroupCreate(), except that it allows the memory allocated for the event group to have specific capabilities (e.g., MALLOC\_CAP\_INTERNAL).

---

**备注:** An event group created using this function must only be deleted using `vEventGroupDeleteWithCaps()`

---

**参数 `uxMemoryCaps`** -- Memory capabilities of the event group's memory (see `esp_heap_caps.h`)

**返回** Handle to the created event group or NULL on failure.

void **vEventGroupDeleteWithCaps** (*EventGroupHandle\_t* xEventGroup)

Deletes an event group previously created using `xEventGroupCreateWithCaps()`

**参数 `xEventGroup`** -- A handle to the event group to be deleted.

## Type Definitions

typedef void (\***TlsDeleteCallbackFunction\_t**)(int, void\*)

Prototype of local storage pointer deletion callback.

## 2.10.14 堆内存分配

### 栈 (stack) 和堆 (heap) 的区别

ESP-IDF 应用程序使用常见的计算机架构模式：由程序控制流动态分配的内存（即 **栈**）、由函数调用动态分配的内存（即 **堆**）以及在编译时分配的 **静态内存**。

由于 ESP-IDF 是一个多线程 RTOS 环境，因此每个 RTOS 任务都有自己的栈，这些栈默认在创建任务时从堆中分配。有关栈静态分配的方法，请参阅 `xTaskCreateStatic()`。

ESP32-H2 使用多种类型的 RAM，因此具备不同属性的堆，即基于属性的内存分配器允许应用程序按不同目的进行堆分配。

多数情况下，可直接使用 C 标准函数库中的 `malloc()` 和 `free()` 函数实现堆分配。为充分利用各种内存类型及其特性，ESP-IDF 还具有基于内存属性的堆内存分配器。要配备具有特定属性的内存，如 **DMA 存储器** 或可执行内存，可以创建具备所需属性的 OR 掩码，将其传递给 `heap_caps_malloc()`。

### 内存属性

ESP32-H2 包含多种类型的 RAM：

- **DRAM**（数据 RAM）是连接到 CPU 数据总线上的内存，用于存储数据。这是作为堆访问最常见的一种内存。
- **IRAM**（指令 RAM）是连接到 CPU 指令总线上的内存，通常仅用于存储可执行数据（即指令）。如果作为通用内存访问，则所有访问必须为 **32 位可访问内存**。
- **D/IRAM** 是连接到 CPU 数据总线和指令总线的 RAM，因此可用作指令 RAM 或数据 RAM。

有关内存类型的详细信息，请参阅 [存储器类型](#)。

所有的 DRAM 内存都可以单字节访问，因此所有的 DRAM 堆都具有 `MALLOC_CAP_8BIT` 属性。要获取所有 DRAM 堆的剩余空间大小，请调用 `heap_caps_get_free_size(MALLOC_CAP_8BIT)`。

调用 `malloc()` 时，ESP-IDF `malloc()` 内部调用 `heap_caps_malloc_default(size)`，使用属性 `MALLOC_CAP_DEFAULT` 分配内存。该属性可实现字节寻址功能，即存储空间的最小编址单位为字节。

`malloc()` 使用基于属性的分配系统，所以使用 `heap_caps_malloc()` 分配的内存可以通过调用标准的 `free()` 函数释放。

## 可用堆空间

**DRAM** 启动时，DRAM 堆包含应用程序未静态分配的所有数据内存，减少静态分配的 `buffer` 将增加可用的空闲堆空间。

调用命令 `idf.py size` 可查找静态分配内存大小。

**备注：**运行时可用的 DRAM 堆空间可能少于编译时计算的大小，因为启动时会在运行 FreeRTOS 调度程序之前从堆中分配部分内存，包括初始 FreeRTOS 任务的栈内存。

**IRAM** 启动时，IRAM 堆包含所有应用程序可执行代码未使用的指令内存。

调用命令 `idf.py size` 查找应用程序使用的 IRAM 量。

**D/IRAM** 一些内存存在 ESP32-H2 中可用作 DRAM 或 IRAM。如果从 D/IRAM 区域分配内存，则两种类型的内存的可用堆空间都会减少。

**堆空间大小** 启动时，所有 ESP-IDF 应用程序都会记录全部堆地址（和空间大小）的摘要，级别为 `Info`：

```
I (252) heap_init: Initializing. RAM available for dynamic allocation:
I (259) heap_init: At 3FFAE6E0 len 00001920 (6 KiB): DRAM
I (265) heap_init: At 3FFB2EC8 len 0002D138 (180 KiB): DRAM
I (272) heap_init: At 3FFE0440 len 00003AE0 (14 KiB): D/IRAM
I (278) heap_init: At 3FFE4350 len 0001BCB0 (111 KiB): D/IRAM
I (284) heap_init: At 4008944C len 00016BB4 (90 KiB): IRAM
```

**查找可用堆** 请参阅[堆内存信息](#)。

## 特殊用途

**DMA 存储器** 使用 `MALLOC_CAP_DMA` 标志分配适合与硬件 DMA 引擎（如 SPI 和 I2S）配合使用的内存，此属性标志不包括外部 PSRAM。

**32 位可访问内存** 如果某个内存结构体仅以 32 位为单位寻址，例如一个整数或指针数组，则可以使用 `MALLOC_CAP_32BIT` 标志分配。通过这一方式，分配器能够在无法调用 `malloc()` 的情况下提供 IRAM 内存，从而充分利用 ESP32-H2 中的所有可用内存。

请注意，使用 `MALLOC_CAP_32BIT` 分配的内存只能通过 32 位读写访问，其他类型的访问将导致 `LoadStoreError` 异常。

## 线程安全性

堆函数是线程安全的，因此可不受限制，在不同任务中同时调用多个堆函数。

从中断处理程序 (ISR) 上下文中调用 `malloc`、`free` 和相关函数虽然在技术层面可行（请参阅[从 ISR 调用堆相关函数](#)），但不建议使用此种方法，因为调用堆函数可能会延迟其他中断。建议重构应用程序，将 ISR 使用的任何 `buffer` 预先分配到 ISR 之外。之后可能会删除从 ISR 调用堆函数的功能。

## 从 ISR 调用堆相关函数

堆组件中的以下函数可以在中断处理程序 (ISR) 中调用：

- `heap_caps_malloc()`
- `heap_caps_malloc_default()`
- `heap_caps_realloc_default()`
- `heap_caps_malloc_prefer()`
- `heap_caps_realloc_prefer()`
- `heap_caps_calloc_prefer()`
- `heap_caps_free()`
- `heap_caps_realloc()`
- `heap_caps_calloc()`
- `heap_caps_aligned_alloc()`
- `heap_caps_aligned_free()`

---

**备注：** 不建议使用此种方法。

---

## 堆跟踪及调试

以下功能介绍详见[堆内存调试](#)：

- [堆信息](#)（释放内存空间等）
- [堆分配与释放函数挂钩](#)
- [堆损坏检测](#)
- [堆跟踪](#)（检测、监控内存泄漏等）

## 实现说明

堆属性分配器对芯片内存区域的了解源于 SoC 组件，该组件包含芯片的内存布局信息以及每个区域的不同属性。各区域的功能为首要考虑因素，如会优先使用 DRAM 和 IRAM 特定区域而非用途更广的 D/IRAM 区域来分配内存。

每个连续的内存区域都包含其自己的内存堆，由 `multi_heap` 函数创建。`multi_heap` 允许将任何连续的内存区域作为堆使用。

堆属性分配器通过对内存区域的了解初始化每个单独的堆，堆属性 API 中的分配函数将基于所需的属性、可用空间和每个区域使用的首选项为分配函数找到最合适的堆，随后为位于特定内存区域的堆调用 `multi_heap_malloc()`。

调用 `free()` 查找对应释放地址的特定堆，随后在特定的 `multi_heap` 实例上调用 `multi_heap_free()`。

## API 参考 - 堆分配

### Header File

- `components/heap/include/esp_heap_caps.h`
- This header file can be included with:

```
#include "esp_heap_caps.h"
```

### Functions

`esp_err_t heap_caps_register_failed_alloc_callback(esp_alloc_failed_hook_t callback)`

registers a callback function to be invoked if a memory allocation operation fails

参数 `callback` -- caller defined callback to be invoked

返回 ESP\_OK if callback was registered.

void \***heap\_caps\_malloc** (size\_t size, uint32\_t caps)

Allocate a chunk of memory which has the given capabilities.

Equivalent semantics to libc malloc(), for capability-aware memory.

参数

- **size** -- Size, in bytes, of the amount of memory to allocate
- **caps** -- Bitwise OR of MALLOC\_CAP\_\* flags indicating the type of memory to be returned

返回 A pointer to the memory allocated on success, NULL on failure

void **heap\_caps\_free** (void \*ptr)

Free memory previously allocated via heap\_caps\_malloc() or heap\_caps\_realloc().

Equivalent semantics to libc free(), for capability-aware memory.

In IDF, free(p) is equivalent to heap\_caps\_free(p).

参数 **ptr** -- Pointer to memory previously returned from heap\_caps\_malloc() or heap\_caps\_realloc(). Can be NULL.

void \***heap\_caps\_realloc** (void \*ptr, size\_t size, uint32\_t caps)

Reallocate memory previously allocated via heap\_caps\_malloc() or heap\_caps\_realloc().

Equivalent semantics to libc realloc(), for capability-aware memory.

In IDF, realloc(p, s) is equivalent to heap\_caps\_realloc(p, s, MALLOC\_CAP\_8BIT).

'caps' parameter can be different to the capabilities that any original 'ptr' was allocated with. In this way, realloc can be used to "move" a buffer if necessary to ensure it meets a new set of capabilities.

参数

- **ptr** -- Pointer to previously allocated memory, or NULL for a new allocation.
- **size** -- Size of the new buffer requested, or 0 to free the buffer.
- **caps** -- Bitwise OR of MALLOC\_CAP\_\* flags indicating the type of memory desired for the new allocation.

返回 Pointer to a new buffer of size 'size' with capabilities 'caps', or NULL if allocation failed.

void \***heap\_caps\_aligned\_alloc** (size\_t alignment, size\_t size, uint32\_t caps)

Allocate an aligned chunk of memory which has the given capabilities.

Equivalent semantics to libc aligned\_alloc(), for capability-aware memory.

参数

- **alignment** -- How the pointer received needs to be aligned must be a power of two
- **size** -- Size, in bytes, of the amount of memory to allocate
- **caps** -- Bitwise OR of MALLOC\_CAP\_\* flags indicating the type of memory to be returned

返回 A pointer to the memory allocated on success, NULL on failure

void **heap\_caps\_aligned\_free** (void \*ptr)

Used to deallocate memory previously allocated with heap\_caps\_aligned\_alloc.

---

备注: This function is deprecated, please consider using heap\_caps\_free() instead

---

参数 **ptr** -- Pointer to the memory allocated

void \***heap\_caps\_aligned\_calloc** (size\_t alignment, size\_t n, size\_t size, uint32\_t caps)

Allocate an aligned chunk of memory which has the given capabilities. The initialized value in the memory is set to zero.

参数

- **alignment** -- How the pointer received needs to be aligned must be a power of two
- **n** -- Number of continuing chunks of memory to allocate
- **size** -- Size, in bytes, of a chunk of memory to allocate
- **caps** -- Bitwise OR of `MALLOC_CAP_*` flags indicating the type of memory to be returned

**返回** A pointer to the memory allocated on success, NULL on failure

void \***heap\_caps\_malloc** (size\_t n, size\_t size, uint32\_t caps)

Allocate a chunk of memory which has the given capabilities. The initialized value in the memory is set to zero.

Equivalent semantics to `libc calloc()`, for capability-aware memory.

In IDF, `calloc(p)` is equivalent to `heap_caps_malloc(p, MALLOC_CAP_8BIT)`.

**参数**

- **n** -- Number of continuing chunks of memory to allocate
- **size** -- Size, in bytes, of a chunk of memory to allocate
- **caps** -- Bitwise OR of `MALLOC_CAP_*` flags indicating the type of memory to be returned

**返回** A pointer to the memory allocated on success, NULL on failure

size\_t **heap\_caps\_get\_total\_size** (uint32\_t caps)

Get the total size of all the regions that have the given capabilities.

This function takes all regions capable of having the given capabilities allocated in them and adds up the total space they have.

**参数 caps** -- Bitwise OR of `MALLOC_CAP_*` flags indicating the type of memory

**返回** total size in bytes

size\_t **heap\_caps\_get\_free\_size** (uint32\_t caps)

Get the total free size of all the regions that have the given capabilities.

This function takes all regions capable of having the given capabilities allocated in them and adds up the free space they have.

---

**备注:** Note that because of heap fragmentation it is probably not possible to allocate a single block of memory of this size. Use `heap_caps_get_largest_free_block()` for this purpose.

---

**参数 caps** -- Bitwise OR of `MALLOC_CAP_*` flags indicating the type of memory

**返回** Amount of free bytes in the regions

size\_t **heap\_caps\_get\_minimum\_free\_size** (uint32\_t caps)

Get the total minimum free memory of all regions with the given capabilities.

This adds all the low watermarks of the regions capable of delivering the memory with the given capabilities.

---

**备注:** Note the result may be less than the global all-time minimum available heap of this kind, as "low watermarks" are tracked per-region. Individual regions' heaps may have reached their "low watermarks" at different points in time. However, this result still gives a "worst case" indication for all-time minimum free heap.

---

**参数 caps** -- Bitwise OR of `MALLOC_CAP_*` flags indicating the type of memory

**返回** Amount of free bytes in the regions

size\_t **heap\_caps\_get\_largest\_free\_block** (uint32\_t caps)

Get the largest free block of memory able to be allocated with the given capabilities.

Returns the largest value of `s` for which `heap_caps_malloc(s, caps)` will succeed.

**参数 caps** -- Bitwise OR of MALLOC\_CAP\_\* flags indicating the type of memory

**返回** Size of the largest free block in bytes.

*esp\_err\_t* **heap\_caps\_monitor\_local\_minimum\_free\_size\_start** (void)

Start monitoring the value of `minimum_free_bytes` from the moment this function is called instead of from startup.

---

**备注:** This allows to detect local lows of the `minimum_free_bytes` value that wouldn't be detected otherwise.

---

**返回** `esp_err_t` ESP\_OK if the function executed properly ESP\_FAIL if called when monitoring already active

*esp\_err\_t* **heap\_caps\_monitor\_local\_minimum\_free\_size\_stop** (void)

Stop monitoring the value of `minimum_free_bytes`. After this call the `minimum_free_bytes` value calculated from startup will be returned in `heap_caps_get_info` and `heap_caps_get_minimum_free_size`.

**返回** `esp_err_t` ESP\_OK if the function executed properly ESP\_FAIL if called when monitoring not active

void **heap\_caps\_get\_info** (*multi\_heap\_info\_t* \*info, uint32\_t caps)

Get heap info for all regions with the given capabilities.

Calls `multi_heap_info()` on all heaps which share the given capabilities. The information returned is an aggregate across all matching heaps. The meanings of fields are the same as defined for *multi\_heap\_info\_t*, except that `minimum_free_bytes` has the same caveats described in `heap_caps_get_minimum_free_size()`.

**参数**

- **info** -- Pointer to a structure which will be filled with relevant heap metadata.
- **caps** -- Bitwise OR of MALLOC\_CAP\_\* flags indicating the type of memory

void **heap\_caps\_print\_heap\_info** (uint32\_t caps)

Print a summary of all memory with the given capabilities.

Calls `multi_heap_info` on all heaps which share the given capabilities, and prints a two-line summary for each, then a total summary.

**参数 caps** -- Bitwise OR of MALLOC\_CAP\_\* flags indicating the type of memory

bool **heap\_caps\_check\_integrity\_all** (bool print\_errors)

Check integrity of all heap memory in the system.

Calls `multi_heap_check` on all heaps. Optionally print errors if heaps are corrupt.

Calling this function is equivalent to calling `heap_caps_check_integrity` with the `caps` argument set to `MALLOC_CAP_INVALID`.

---

**备注:** Please increase the value of `CONFIG_ESP_INT_WDT_TIMEOUT_MS` when using this API with PSRAM enabled.

---

**参数 print\_errors** -- Print specific errors if heap corruption is found.

**返回** True if all heaps are valid, False if at least one heap is corrupt.

bool **heap\_caps\_check\_integrity** (uint32\_t caps, bool print\_errors)

Check integrity of all heaps with the given capabilities.

Calls `multi_heap_check` on all heaps which share the given capabilities. Optionally print errors if the heaps are corrupt.

See also `heap_caps_check_integrity_all` to check all heap memory in the system and `heap_caps_check_integrity_addr` to check memory around a single address.



---

**备注:** Please increase the value of `CONFIG_ESP_INT_WDT_TIMEOUT_MS` when using this API with PSRAM capability flag.

---

**参数**

- **caps** -- Bitwise OR of `MALLOC_CAP_*` flags indicating the type of memory
- **print\_errors** -- Print specific errors if heap corruption is found.

**返回** True if all heaps are valid, False if at least one heap is corrupt.

bool **heap\_caps\_check\_integrity\_addr** (intptr\_t addr, bool print\_errors)

Check integrity of heap memory around a given address.

This function can be used to check the integrity of a single region of heap memory, which contains the given address.

This can be useful if debugging heap integrity for corruption at a known address, as it has a lower overhead than checking all heap regions. Note that if the corrupt address moves around between runs (due to timing or other factors) then this approach won't work, and you should call `heap_caps_check_integrity` or `heap_caps_check_integrity_all` instead.

---

**备注:** The entire heap region around the address is checked, not only the adjacent heap blocks.

---

**参数**

- **addr** -- Address in memory. Check for corruption in region containing this address.
- **print\_errors** -- Print specific errors if heap corruption is found.

**返回** True if the heap containing the specified address is valid, False if at least one heap is corrupt or the address doesn't belong to a heap region.

void **heap\_caps\_malloc\_extmem\_enable** (size\_t limit)

Enable `malloc()` in external memory and set limit below which `malloc()` attempts are placed in internal memory.

When external memory is in use, the allocation strategy is to initially try to satisfy smaller allocation requests with internal memory and larger requests with external memory. This sets the limit between the two, as well as generally enabling allocation in external memory.

**参数** **limit** -- Limit, in bytes.

void \***heap\_caps\_malloc\_prefer** (size\_t size, size\_t num, ...)

Allocate a chunk of memory as preference in decreasing order.

**Attention** The variable parameters are bitwise OR of `MALLOC_CAP_*` flags indicating the type of memory. This API prefers to allocate memory with the first parameter. If failed, allocate memory with the next parameter. It will try in this order until allocating a chunk of memory successfully or fail to allocate memories with any of the parameters.

**参数**

- **size** -- Size, in bytes, of the amount of memory to allocate
- **num** -- Number of variable parameters

**返回** A pointer to the memory allocated on success, NULL on failure

void \***heap\_caps\_realloc\_prefer** (void \*ptr, size\_t size, size\_t num, ...)

Reallocate a chunk of memory as preference in decreasing order.

**参数**

- **ptr** -- Pointer to previously allocated memory, or NULL for a new allocation.
- **size** -- Size of the new buffer requested, or 0 to free the buffer.
- **num** -- Number of variable parameters



**返回** Pointer to a new buffer of size 'size', or NULL if allocation failed.

void **\*heap\_caps\_malloc\_prefer** (size\_t n, size\_t size, size\_t num, ...)

Allocate a chunk of memory as preference in decreasing order.

**参数**

- **n** -- Number of continuing chunks of memory to allocate
- **size** -- Size, in bytes, of a chunk of memory to allocate
- **num** -- Number of variable parameters

**返回** A pointer to the memory allocated on success, NULL on failure

void **heap\_caps\_dump** (uint32\_t caps)

Dump the full structure of all heaps with matching capabilities.

Prints a large amount of output to serial (because of locking limitations, the output bypasses stdout/stderr). For each (variable sized) block in each matching heap, the following output is printed on a single line:

- Block address (the data buffer returned by malloc is 4 bytes after this if heap debugging is set to Basic, or 8 bytes otherwise).
- Data size (the data size may be larger than the size requested by malloc, either due to heap fragmentation or because of heap debugging level).
- Address of next block in the heap.
- If the block is free, the address of the next free block is also printed.

**参数 caps** -- Bitwise OR of MALLOC\_CAP\_\* flags indicating the type of memory

void **heap\_caps\_dump\_all** (void)

Dump the full structure of all heaps.

Covers all registered heaps. Prints a large amount of output to serial.

Output is the same as for heap\_caps\_dump.

size\_t **heap\_caps\_get\_allocated\_size** (void \*ptr)

Return the size that a particular pointer was allocated with.

---

**备注:** The app will crash with an assertion failure if the pointer is not valid.

---

**参数 ptr** -- Pointer to currently allocated heap memory. Must be a pointer value previously returned by heap\_caps\_malloc, malloc, calloc, etc. and not yet freed.

**返回** Size of the memory allocated at this block.

void **heap\_caps\_walk** (uint32\_t caps, *heap\_caps\_walker\_cb\_t* walker\_func, void \*user\_data)

Function called to walk through the heaps with the given set of capabilities.

**参数**

- **caps** -- The set of capabilities assigned to the heaps to walk through
- **walker\_func** -- Callback called for each block of the heaps being traversed
- **user\_data** -- Opaque pointer to user defined data

void **heap\_caps\_walk\_all** (*heap\_caps\_walker\_cb\_t* walker\_func, void \*user\_data)

Function called to walk through all heaps defined by the heap component.

**参数**

- **walker\_func** -- Callback called for each block of the heaps being traversed
- **user\_data** -- Opaque pointer to user defined data

## Structures

struct **walker\_heap\_info**

Structure used to store heap related data passed to the walker callback function.

### Public Members

intptr\_t **start**

Start address of the heap in which the block is located.

intptr\_t **end**

End address of the heap in which the block is located.

struct **walker\_block\_info**

Structure used to store block related data passed to the walker callback function.

### Public Members

void \***ptr**

Pointer to the block data.

size\_t **size**

The size of the block.

bool **used**

Block status. True: used, False: free.

## Macros

**HEAP\_IRAM\_ATTR**

**MALLOC\_CAP\_EXEC**

Flags to indicate the capabilities of the various memory systems.

Memory must be able to run executable code

**MALLOC\_CAP\_32BIT**

Memory must allow for aligned 32-bit data accesses.

**MALLOC\_CAP\_8BIT**

Memory must allow for 8/16/...-bit data accesses.

**MALLOC\_CAP\_DMA**

Memory must be able to accessed by DMA.

**MALLOC\_CAP\_PID2**

Memory must be mapped to PID2 memory space (PIDs are not currently used)

**MALLOC\_CAP\_PID3**

Memory must be mapped to PID3 memory space (PIDs are not currently used)

**MALLOC\_CAP\_PID4**

Memory must be mapped to PID4 memory space (PIDs are not currently used)

**MALLOC\_CAP\_PID5**

Memory must be mapped to PID5 memory space (PIDs are not currently used)

**MALLOC\_CAP\_PID6**

Memory must be mapped to PID6 memory space (PIDs are not currently used)

**MALLOC\_CAP\_PID7**

Memory must be mapped to PID7 memory space (PIDs are not currently used)

**MALLOC\_CAP\_SPIRAM**

Memory must be in SPI RAM.

**MALLOC\_CAP\_INTERNAL**

Memory must be internal; specifically it should not disappear when flash/spiram cache is switched off.

**MALLOC\_CAP\_DEFAULT**

Memory can be returned in a non-capability-specific memory allocation (e.g. malloc(), calloc()) call.

**MALLOC\_CAP\_IRAM\_8BIT**

Memory must be in IRAM and allow unaligned access.

**MALLOC\_CAP\_RETENTION**

Memory must be able to accessed by retention DMA.

**MALLOC\_CAP\_RTCRAM**

Memory must be in RTC fast memory.

**MALLOC\_CAP\_TCM**

Memory must be in TCM memory.

**MALLOC\_CAP\_DMA\_DESC\_AHB**

Memory must be capable of containing AHB DMA descriptors.

**MALLOC\_CAP\_DMA\_DESC\_AXI**

Memory must be capable of containing AXI DMA descriptors.

**MALLOC\_CAP\_CACHE\_ALIGNED**

Memory must be aligned to the cache line size of any intermediate caches.

**MALLOC\_CAP\_INVALID**

Memory can't be used / list end marker.

**Type Definitions**

```
typedef void (*esp_alloc_failed_hook_t)(size_t size, uint32_t caps, const char *function_name)
```

callback called when an allocation operation fails, if registered

**Param size** in bytes of failed allocation

**Param caps** capabilities requested of failed allocation

**Param function\_name** function which generated the failure

```
typedef struct walker_heap_info walker_heap_info_t
```

Structure used to store heap related data passed to the walker callback function.

```
typedef struct walker_block_info walker_block_info_t
```

Structure used to store block related data passed to the walker callback function.

```
typedef bool (*heap_caps_walker_cb_t)(walker_heap_info_t heap_info, walker_block_info_t block_info, void *user_data)
```

Function callback used to get information of memory block during calls to heap\_caps\_walk or heap\_caps\_walk\_all.

**Param heap\_info** See walker\_heap\_info\_t

**Param block\_info** See walker\_block\_info\_t

**Param user\_data** Opaque pointer to user defined data

**Return** True to proceed with the heap traversal False to stop the traversal of the current heap and continue with the traversal of the next heap (if any)

## API 参考 - 初始化

### Header File

- components/heap/include/esp\_heap\_caps\_init.h
- This header file can be included with:

```
#include "esp_heap_caps_init.h"
```

### Functions

```
void heap_caps_init (void)
```

Initialize the capability-aware heap allocator.

This is called once in the IDF startup code. Do not call it at other times.

```
void heap_caps_enable_nonos_stack_heaps (void)
```

Enable heap(s) in memory regions where the startup stacks are located.

On startup, the pro/app CPUs have a certain memory region they use as stack, so we cannot do allocations in the regions these stack frames are. When FreeRTOS is completely started, they do not use that memory anymore and heap(s) there can be enabled.

```
esp_err_t heap_caps_add_region (intptr_t start, intptr_t end)
```

Add a region of memory to the collection of heaps at runtime.

Most memory regions are defined in soc\_memory\_layout.c for the SoC, and are registered via heap\_caps\_init(). Some regions can't be used immediately and are later enabled via heap\_caps\_enable\_nonos\_stack\_heaps().

Call this function to add a region of memory to the heap at some later time.

This function does not consider any of the "reserved" regions or other data in soc\_memory\_layout, caller needs to consider this themselves.

All memory within the region specified by start & end parameters must be otherwise unused.

The capabilities of the newly registered memory will be determined by the start address, as looked up in the regions specified in `soc_memory_layout.c`.

Use `heap_caps_add_region_with_caps()` to register a region with custom capabilities.

**备注:** Please refer to following example for memory regions allowed for addition to heap based on an existing region (address range for demonstration purpose only):

```
Existing region: 0x1000 <-> 0x3000
New region:      0x1000 <-> 0x3000 (Allowed)
New region:      0x1000 <-> 0x2000 (Allowed)
New region:      0x0000 <-> 0x1000 (Allowed)
New region:      0x3000 <-> 0x4000 (Allowed)
New region:      0x0000 <-> 0x2000 (NOT Allowed)
New region:      0x0000 <-> 0x4000 (NOT Allowed)
New region:      0x1000 <-> 0x4000 (NOT Allowed)
New region:      0x2000 <-> 0x4000 (NOT Allowed)
```

### 参数

- **start** -- Start address of new region.
- **end** -- End address of new region.

**返回** `ESP_OK` on success, `ESP_ERR_INVALID_ARG` if a parameter is invalid, `ESP_ERR_NOT_FOUND` if the specified start address doesn't reside in a known region, or any error returned by `heap_caps_add_region_with_caps()`.

*esp\_err\_t* `heap_caps_add_region_with_caps` (const uint32\_t caps[], intptr\_t start, intptr\_t end)

Add a region of memory to the collection of heaps at runtime, with custom capabilities.

Similar to `heap_caps_add_region()`, only custom memory capabilities are specified by the caller.

**备注:** Please refer to following example for memory regions allowed for addition to heap based on an existing region (address range for demonstration purpose only):

```
Existing region: 0x1000 <-> 0x3000
New region:      0x1000 <-> 0x3000 (Allowed)
New region:      0x1000 <-> 0x2000 (Allowed)
New region:      0x0000 <-> 0x1000 (Allowed)
New region:      0x3000 <-> 0x4000 (Allowed)
New region:      0x0000 <-> 0x2000 (NOT Allowed)
New region:      0x0000 <-> 0x4000 (NOT Allowed)
New region:      0x1000 <-> 0x4000 (NOT Allowed)
New region:      0x2000 <-> 0x4000 (NOT Allowed)
```

### 参数

- **caps** -- Ordered array of capability masks for the new region, in order of priority. Must have length `SOC_MEMORY_TYPE_NO_PRIOS`. Does not need to remain valid after the call returns.
- **start** -- Start address of new region.
- **end** -- End address of new region.

### 返回

- `ESP_OK` on success
- `ESP_ERR_INVALID_ARG` if a parameter is invalid
- `ESP_ERR_NO_MEM` if no memory to register new heap.
- `ESP_ERR_INVALID_SIZE` if the memory region is too small to fit a heap
- `ESP_FAIL` if region overlaps the start and/or end of an existing region

## API 参考 - 多堆 API

(注意：堆属性分配器在内部使用多堆 API，而多数 IDF 程序不需要直接调用此 API。)

### Header File

- [components/heap/include/multi\\_heap.h](#)
- This header file can be included with:

```
#include "multi_heap.h"
```

### Functions

void **multi\_heap\_aligned\_alloc** (*multi\_heap\_handle\_t* heap, size\_t size, size\_t alignment)

allocate a chunk of memory with specific alignment

#### 参数

- **heap** -- Handle to a registered heap.
- **size** -- size in bytes of memory chunk
- **alignment** -- how the memory must be aligned

返回 pointer to the memory allocated, NULL on failure

void **multi\_heap\_malloc** (*multi\_heap\_handle\_t* heap, size\_t size)

malloc() a buffer in a given heap

Semantics are the same as standard malloc(), only the returned buffer will be allocated in the specified heap.

#### 参数

- **heap** -- Handle to a registered heap.
- **size** -- Size of desired buffer.

返回 Pointer to new memory, or NULL if allocation fails.

void **multi\_heap\_aligned\_free** (*multi\_heap\_handle\_t* heap, void \*p)

free() a buffer aligned in a given heap.

---

**备注:** This function is deprecated, consider using multi\_heap\_free() instead

---

#### 参数

- **heap** -- Handle to a registered heap.
- **p** -- NULL, or a pointer previously returned from multi\_heap\_aligned\_alloc() for the same heap.

void **multi\_heap\_free** (*multi\_heap\_handle\_t* heap, void \*p)

free() a buffer in a given heap.

Semantics are the same as standard free(), only the argument 'p' must be NULL or have been allocated in the specified heap.

#### 参数

- **heap** -- Handle to a registered heap.
- **p** -- NULL, or a pointer previously returned from multi\_heap\_malloc() or multi\_heap\_realloc() for the same heap.

void **multi\_heap\_realloc** (*multi\_heap\_handle\_t* heap, void \*p, size\_t size)

realloc() a buffer in a given heap.

Semantics are the same as standard realloc(), only the argument 'p' must be NULL or have been allocated in the specified heap.

#### 参数

- **heap** -- Handle to a registered heap.

- **p** -- NULL, or a pointer previously returned from `multi_heap_malloc()` or `multi_heap_realloc()` for the same heap.
- **size** -- Desired new size for buffer.

返回 New buffer of 'size' containing contents of 'p', or NULL if reallocation failed.

`size_t multi_heap_get_allocated_size (multi_heap_handle_t heap, void *p)`

Return the size that a particular pointer was allocated with.

**参数**

- **heap** -- Handle to a registered heap.
- **p** -- Pointer, must have been previously returned from `multi_heap_malloc()` or `multi_heap_realloc()` for the same heap.

返回 Size of the memory allocated at this block. May be more than the original size argument, due to padding and minimum block sizes.

`multi_heap_handle_t multi_heap_register (void *start, size_t size)`

Register a new heap for use.

This function initialises a heap at the specified address, and returns a handle for future heap operations.

There is no equivalent function for deregistering a heap - if all blocks in the heap are free, you can immediately start using the memory for other purposes.

**参数**

- **start** -- Start address of the memory to use for a new heap.
- **size** -- Size (in bytes) of the new heap.

返回 Handle of a new heap ready for use, or NULL if the heap region was too small to be initialised.

`void multi_heap_set_lock (multi_heap_handle_t heap, void *lock)`

Associate a private lock pointer with a heap.

The lock argument is supplied to the `MULTI_HEAP_LOCK()` and `MULTI_HEAP_UNLOCK()` macros, defined in `multi_heap_platform.h`.

The lock in question must be recursive.

When the heap is first registered, the associated lock is NULL.

**参数**

- **heap** -- Handle to a registered heap.
- **lock** -- Optional pointer to a locking structure to associate with this heap.

`void multi_heap_dump (multi_heap_handle_t heap)`

Dump heap information to stdout.

For debugging purposes, this function dumps information about every block in the heap to stdout.

**参数** **heap** -- Handle to a registered heap.

`bool multi_heap_check (multi_heap_handle_t heap, bool print_errors)`

Check heap integrity.

Walks the heap and checks all heap data structures are valid. If any errors are detected, an error-specific message can be optionally printed to stderr. Print behaviour can be overridden at compile time by defining `MULTI_CHECK_FAIL_PRINTF` in `multi_heap_platform.h`.

---

**备注:** This function is not thread-safe as it sets a global variable with the value of `print_errors`.

---

**参数**

- **heap** -- Handle to a registered heap.
- **print\_errors** -- If true, errors will be printed to stderr.

返回 true if heap is valid, false otherwise.

`size_t multi_heap_free_size (multi_heap_handle_t heap)`

Return free heap size.

Returns the number of bytes available in the heap.

Equivalent to the `total_free_bytes` member returned by `multi_heap_get_heap_info()`.

Note that the heap may be fragmented, so the actual maximum size for a single `malloc()` may be lower. To know this size, see the `largest_free_block` member returned by `multi_heap_get_heap_info()`.

**参数** `heap` -- Handle to a registered heap.

**返回** Number of free bytes.

`size_t multi_heap_minimum_free_size (multi_heap_handle_t heap)`

Return the lifetime minimum free heap size.

Equivalent to the `minimum_free_bytes` member returned by `multi_heap_get_info()`.

Returns the lifetime "low watermark" of possible values returned from `multi_free_heap_size()`, for the specified heap.

**参数** `heap` -- Handle to a registered heap.

**返回** Number of free bytes.

`void multi_heap_get_info (multi_heap_handle_t heap, multi_heap_info_t *info)`

Return metadata about a given heap.

Fills a `multi_heap_info_t` structure with information about the specified heap.

**参数**

- **heap** -- Handle to a registered heap.
- **info** -- Pointer to a structure to fill with heap metadata.

`void *multi_heap_aligned_alloc_offs (multi_heap_handle_t heap, size_t size, size_t alignment, size_t offset)`

Perform an aligned allocation from the provided offset.

**参数**

- **heap** -- The heap in which to perform the allocation
- **size** -- The size of the allocation
- **alignment** -- How the memory must be aligned
- **offset** -- The offset at which the alignment should start

**返回** `void*` The ptr to the allocated memory

`size_t multi_heap_reset_minimum_free_bytes (multi_heap_handle_t heap)`

Reset the `minimum_free_bytes` value (setting it to `free_bytes`) and return the former value.

**参数** `heap` -- The heap in which the reset is taking place

**返回** `size_t` the value of `minimum_free_bytes` before it is reset

`void multi_heap_restore_minimum_free_bytes (multi_heap_handle_t heap, const size_t new_minimum_free_bytes_value)`

Set the value of `minimum_free_bytes` to `new_minimum_free_bytes_value` or keep the current value of `minimum_free_bytes` if it is smaller than `new_minimum_free_bytes_value`.

**参数**

- **heap** -- The heap in which the restore is taking place
- **new\_minimum\_free\_bytes\_value** -- The value to restore the `minimum_free_bytes` to

`void multi_heap_walk (multi_heap_handle_t heap, multi_heap_walker_cb_t walker_func, void *user_data)`

Call the `tlsf_walk_pool` function of the heap given as parameter with the walker function passed as parameter.

**参数**

- **heap** -- The heap to traverse
- **walker\_func** -- The walker to trigger on each block of the heap



- **user\_data** -- Opaque pointer to user defined data

## Structures

struct **multi\_heap\_info\_t**

Structure to access heap metadata via `multi_heap_get_info`.

### Public Members

size\_t **total\_free\_bytes**

Total free bytes in the heap. Equivalent to `multi_free_heap_size()`.

size\_t **total\_allocated\_bytes**

Total bytes allocated to data in the heap.

size\_t **largest\_free\_block**

Size of the largest free block in the heap. This is the largest malloc-able size.

size\_t **minimum\_free\_bytes**

Lifetime minimum free heap size. Equivalent to `multi_minimum_free_heap_size()`.

size\_t **allocated\_blocks**

Number of (variable size) blocks allocated in the heap.

size\_t **free\_blocks**

Number of (variable size) free blocks in the heap.

size\_t **total\_blocks**

Total number of (variable size) blocks in the heap.

## Type Definitions

typedef struct multi\_heap\_info **\*multi\_heap\_handle\_t**

Opaque handle to a registered heap.

typedef bool (**\*multi\_heap\_walker\_cb\_t**)(void \*block\_ptr, size\_t block\_size, int block\_used, void \*user\_data)

Callback called when walking the given heap blocks of memory.

**Param block\_ptr** Pointer to the block data

**Param block\_size** The size of the block

**Param block\_used** Block status. 0: free, 1: allocated

**Param user\_data** Opaque pointer to user defined data

**Return** True if the walker is expected to continue the heap traversal False if the walker is expected to stop the traversal of the heap

### 2.10.15 基于 MMU 的存储管理

## 简介

ESP32-H2 的存储管理单元 (MMU) 相对简单。它可以在物理存储地址和虚拟存储地址之间进行存储地址转换，因此，CPU 可以通过虚拟存储地址来访问物理存储。虚拟存储地址有多种类型，分别具有不同的功能。

ESP-IDF 提供了一个存储器映射驱动程序，用于管理这些物理存储地址和虚拟存储地址之间的关系，实现一些功能。例如，可以通过指针从 SPI flash 中读取内容。

存储映射驱动程序实际上是一个基于属性的虚拟存储地址分配器，允许应用程序为不同的目的分配虚拟存储地址。下文将此驱动程序称为 `esp_mmap` 驱动程序。

ESP-IDF 还提供了一个存储器同步驱动程序来处理潜在的不同步的情况。

## 物理存储类型

存储映射驱动程序目前支持映射到以下物理存储类型：

- SPI flash

## 虚拟存储的功能

- `MMU_MEM_CAP_EXEC`：此功能表示虚拟存储地址具有执行权限。注意，此权限的范围仅限 MMU 硬件内部。
- `MMU_MEM_CAP_READ`：此功能表示虚拟存储地址具有读取权限。注意，此权限的范围仅限 MMU 硬件内部。
- `MMU_MEM_CAP_WRITE`：此功能表示虚拟存储地址具有写入权限。注意，此权限的范围仅限 MMU 硬件内部。
- `MMU_MEM_CAP_32BIT`：此功能表示允许访问 32 位或 32 位倍数的虚拟存储。
- `MMU_MEM_CAP_8BIT`：此功能表示允许访问 8 位或 8 位倍数的虚拟存储。

如需了解具有特定功能的最大连续可映射块大小，请调用 `esp_mmu_map_get_max_consecutive_free_block_size()`。

## 存储管理驱动程序

### 驱动程序

**术语解释** 虚拟存储池由一个或多个虚拟存储区域组成，如下图所示：

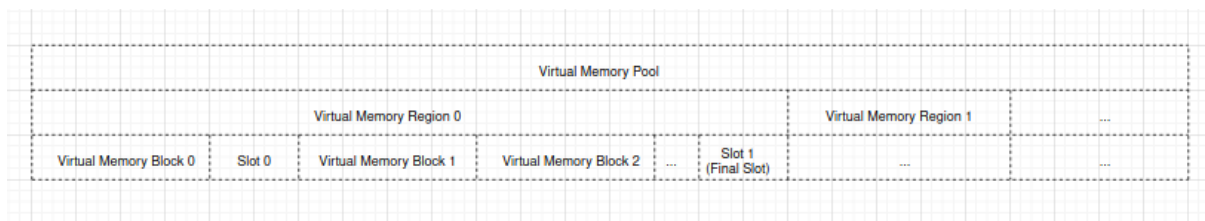

- 一个虚拟存储池是指可以映射到物理存储的整个虚拟地址范围。
- 一个虚拟存储区域是指具有相同属性的虚拟地址范围。
- 一个虚拟存储块是指一块动态映射的虚拟地址范围。
- 一个间隙是指两个虚拟存储块之间的虚拟地址范围。
- 一个物理存储块是指一块待映射或已映射到虚拟存储块的物理地址范围。
- 动态映射是指调用 `esp_mmap` 驱动程序 API `esp_mmu_map()` 进行的映射，此 API 会将给定的物理存储块映射到 `esp_mmap` 驱动程序分配的虚拟存储块中。

**存储块的关系** 在映射物理存储块 A 时，存储块 A 与此前已映射的另一个物理存储块 B 之间可能存在以下关系之一：

- 包含：块 A 被完全包含在块 B 内，如下图所示：

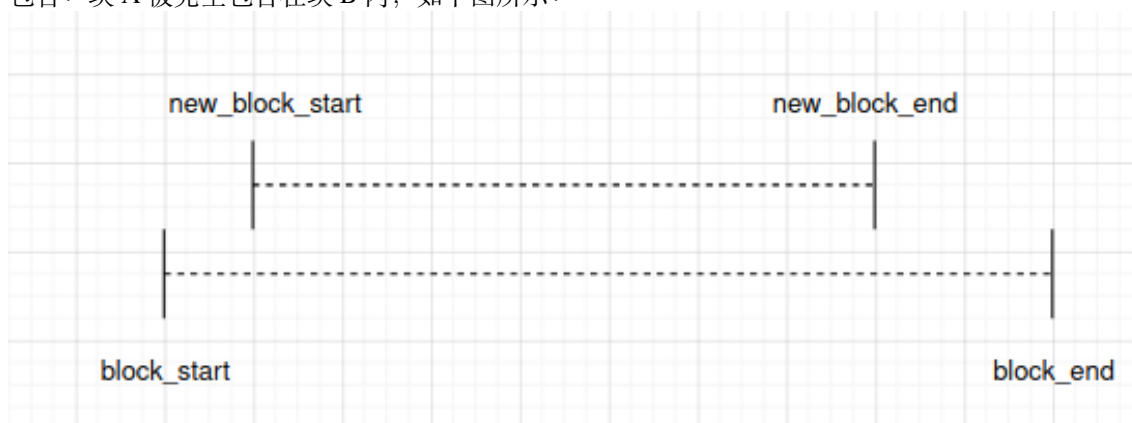

- 相同：块 A 与块 B 完全相同，如下图所示：

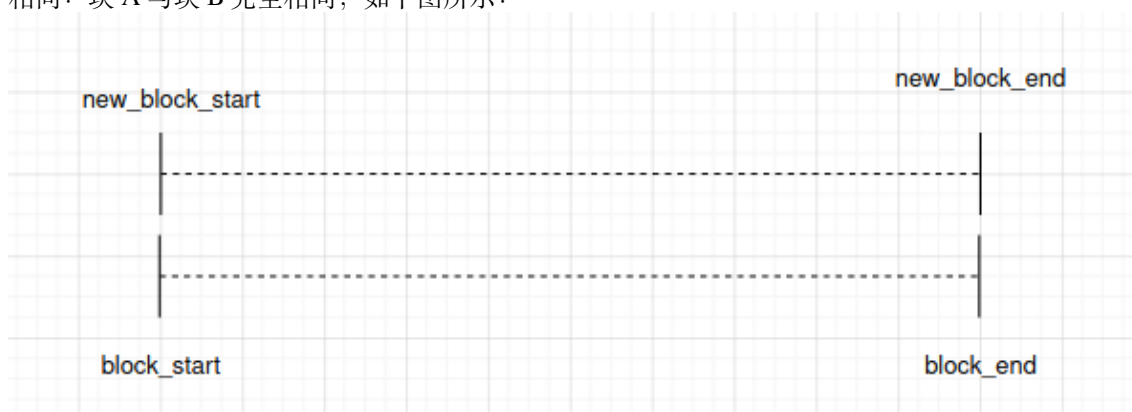

注意，esp\_mmap 驱动程序将相同 **视为包含**。

- 重叠：块 A 与块 B 重叠，如下图所示：

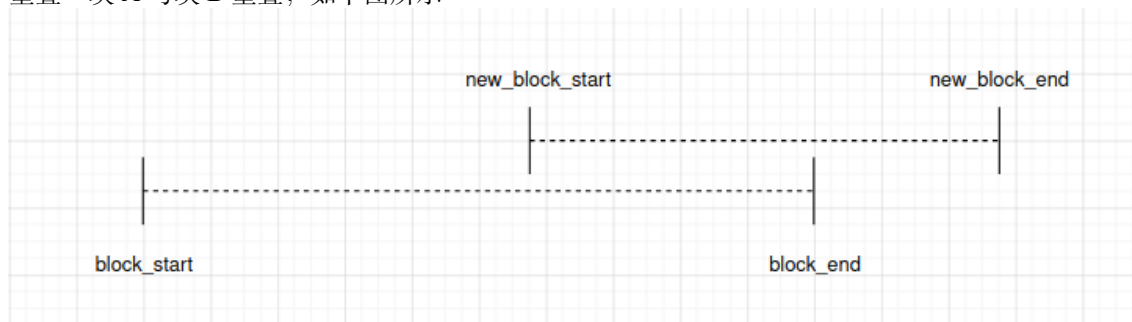

特殊情况下，当块 A 完全包围块 B 时，如下图所示：

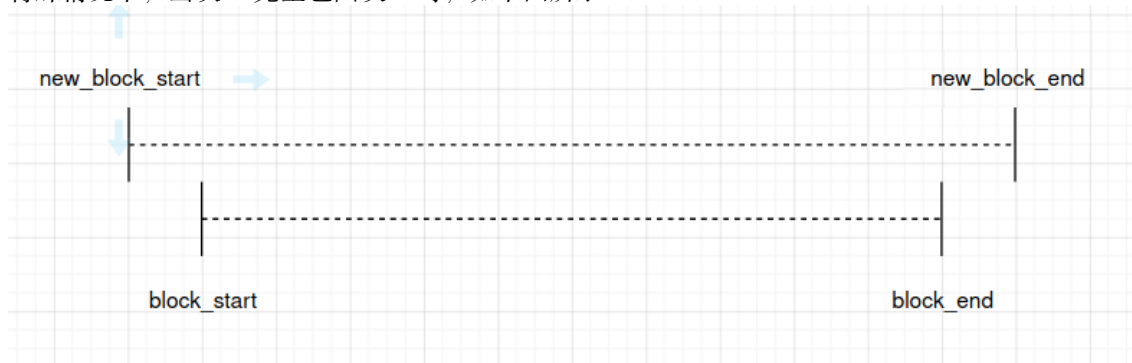

注意，esp\_mmap 驱动程序将这种情况 **视为重叠**。

## 驱动程序行为

**存储映射** 可以调用 `esp_mmu_map()` 进行动态映射。该 API 会根据你所选择的虚拟存储的属性分配一定大小的虚拟存储块，然后按照要求将此虚拟存储块映射到物理存储块中。esp\_mmap 驱动程序支持映射到一种或多种物理存储，因此，应在映射时指定物理存储目标。

默认情况下，物理存储块和虚拟存储块是一一对应。因此，当调用 `esp_mmu_map()` 时，如果存储关系不同，API 的行为也有所不同：

- 如果是“包含”的情形，此 API 将返回 `ESP_ERR_INVALID_STATE`。此时，由于之前已映射的虚拟存储包含待映射的虚拟存储，因此返回的 `out_ptr` 会指向之前映射的虚拟存储的起始地址。
- 如果是“相同”的情形，此 API 的行为与“包含”的情况完全相同。
- 如果是“重叠”的情形，此 API 默认返回 `ESP_ERR_INVALID_ARG`。这表明，esp\_mmap 驱动程序在默认情况下，不允许将一个物理存储地址映射到多个虚拟存储地址。

但是，可以使用 `ESP_MMU_MMAP_FLAG_PADDR_SHARED` flag，代表在物理地址和虚拟地址之间的一对多映射：

- 如果是“重叠”的情形，此 API 将按照要求分配一个新的虚拟存储块，并将其映射到给定的物理存储块中。

**取消存储映射** 可以调用 `esp_mmu_unmap()` 来取消先前存储块的映射。如果尝试取消映射的虚拟存储块实际尚未映射到任何物理存储块，此 API 将返回 `ESP_ERR_NOT_FOUND`。

**存储地址转换** esp\_mmap 驱动程序提供了两个辅助 API，用于虚拟存储地址和物理存储地址之间的转换：

- `esp_mmu_vaddr_to_paddr()` 可将虚拟存储地址转换为物理存储地址。
- `esp_mmu_paddr_to_vaddr()` 可将物理存储地址转换为虚拟存储地址。

**存储同步** 可以通过一种或多种方法来访问支持 MMU 的物理存储。

SPI flash 可以通过 SPI1 (ESP-IDF `spi_flash` 驱动 API) 或指针进行访问。ESP-IDF `spi_flash` 驱动 API 中已经考虑了存储同步，因此在使用时无需额外考虑存储同步。

## 线程安全

`esp_mmu_map.h` 中的 API 不能确保线程的安全性。

`esp_cache.h` 中的 API 能够确保线程的安全性。

## API 参考

### API 参考 - ESP MMAP 驱动

#### Header File

- [components/esp\\_mm/include/esp\\_mmu\\_map.h](#)
- This header file can be included with:

```
#include "esp_mmu_map.h"
```

- This header file is a part of the API provided by the `esp_mm` component. To declare that your component depends on `esp_mm`, add the following to your `CMakeLists.txt`:

```
REQUIRES esp_mm
```

or

```
PRIV_REQUIRES esp_mm
```

## Functions

*esp\_err\_t* **esp\_mmu\_map** (*esp\_paddr\_t* paddr\_start, *size\_t* size, *mmu\_target\_t* target, *mmu\_mem\_caps\_t* caps, *int* flags, *void \*\**out\_ptr)

Map a physical memory block to external virtual address block, with given capabilities.

---

**备注:** This API does not guarantee thread safety

---

### 参数

- **paddr\_start** -- **[in]** Start address of the physical memory block
- **size** -- **[in]** Size to be mapped. Size will be rounded up by to the nearest multiple of MMU page size
- **target** -- **[in]** Physical memory target you're going to map to, see *mmu\_target\_t*
- **caps** -- **[in]** Memory capabilities, see *mmu\_mem\_caps\_t*
- **flags** -- **[in]** Mmap flags
- **out\_ptr** -- **[out]** Start address of the mapped virtual memory

### 返回

- ESP\_OK
- ESP\_ERR\_INVALID\_ARG: Invalid argument, see printed logs
- ESP\_ERR\_NOT\_SUPPORTED: Only on ESP32, PSRAM is not a supported physical memory target
- ESP\_ERR\_NOT\_FOUND: No enough size free block to use
- ESP\_ERR\_NO\_MEM: Out of memory, this API will allocate some heap memory for internal usage
- ESP\_ERR\_INVALID\_STATE: Paddr is mapped already, this API will return corresponding *vaddr\_start + new\_block\_offset* as per the previously mapped block. Only to-be-mapped *paddr* block is totally enclosed by a previously mapped block will lead to this error. (Identical scenario will behave similarly) *new\_block\_start new\_block\_end*  
 |-----New Block -----||-----Block -----| *block\_start block\_end*

*esp\_err\_t* **esp\_mmu\_unmap** (*void \*ptr*)

Unmap a previously mapped virtual memory block.

---

**备注:** This API does not guarantee thread safety

---

**参数** *ptr* -- **[in]** Start address of the virtual memory

### 返回

- ESP\_OK
- ESP\_ERR\_INVALID\_ARG: Null pointer
- ESP\_ERR\_NOT\_FOUND: *Vaddr* is not in external memory, or it's not mapped yet

*esp\_err\_t* **esp\_mmu\_map\_get\_max\_consecutive\_free\_block\_size** (*mmu\_mem\_caps\_t* caps, *mmu\_target\_t* target, *size\_t* \*out\_len)

Get largest consecutive free external virtual memory block size, with given capabilities and given physical target.

### 参数

- **caps** -- **[in]** Bitwise OR of *MMU\_MEM\_CAP\_\** flags indicating the memory block
- **target** -- **[in]** Physical memory target you're going to map to, see *mmu\_target\_t*.
- **out\_len** -- **[out]** Largest free block length, in bytes.

### 返回

- ESP\_OK

- `ESP_ERR_INVALID_ARG`: Invalid arguments, could be null pointer

*esp\_err\_t* `esp_mmu_map_dump_mapped_blocks` (FILE \*stream)

Dump all the previously mapped blocks

---

**备注:** This API shall not be called from an ISR.

---



---

**备注:** This API does not guarantee thread safety

---

**参数** `stream` -- stream to print information to; use stdout or stderr to print to the console; use `fmemopen/open_memstream` to print to a string buffer.

**返回**

- `ESP_OK`

*esp\_err\_t* `esp_mmu_vaddr_to_paddr` (void \*vaddr, *esp\_paddr\_t* \*out\_paddr, `mmu_target_t` \*out\_target)

Convert virtual address to physical address.

**参数**

- `vaddr` -- [in] Virtual address
- `out_paddr` -- [out] Physical address
- `out_target` -- [out] Physical memory target, see `mmu_target_t`

**返回**

- `ESP_OK`
- `ESP_ERR_INVALID_ARG`: Null pointer, or vaddr is not within external memory
- `ESP_ERR_NOT_FOUND`: Vaddr is not mapped yet

*esp\_err\_t* `esp_mmu_paddr_to_vaddr` (*esp\_paddr\_t* paddr, `mmu_target_t` target, `mmu_vaddr_t` type, void \*\*out\_vaddr)

Convert physical address to virtual address.

**参数**

- `paddr` -- [in] Physical address
- `target` -- [in] Physical memory target, see `mmu_target_t`
- `type` -- [in] Virtual address type, could be either instruction or data
- `out_vaddr` -- [out] Virtual address

**返回**

- `ESP_OK`
- `ESP_ERR_INVALID_ARG`: Null pointer
- `ESP_ERR_NOT_FOUND`: Paddr is not mapped yet

*esp\_err\_t* `esp_mmu_paddr_find_caps` (const *esp\_paddr\_t* paddr, `mmu_mem_caps_t` \*out\_caps)

If the physical address is mapped, this API will provide the capabilities of the virtual address where the physical address is mapped to.

---

**备注:** : Only return value is `ESP_OK`(which means physically address is successfully mapped), then caps you get make sense.

---



---

**备注:** This API only check one page (see `CONFIG_MMU_PAGE_SIZE`), starting from the paddr

---

**参数**

- `paddr` -- [in] Physical address
- `out_caps` -- [out] Bitwise OR of `MMU_MEM_CAP_*` flags indicating the capabilities of a virtual address where the physical address is mapped to.

**返回**

- ESP\_OK: Physical address successfully mapped.
- ESP\_ERR\_INVALID\_ARG: Null pointer
- ESP\_ERR\_NOT\_FOUND: Physical address is not mapped successfully.

## Macros

### ESP\_MMU\_MMAP\_FLAG\_PADDR\_SHARED

Share this mapping.

MMU Memory Mapping Driver APIs for MMU supported memory

Driver Backgrounds:

## Type Definitions

```
typedef uint32_t esp_paddr_t
```

Physical memory type.

## 2.10.16 堆内存调试

### 概述

ESP-IDF 集成了用于请求堆内存信息、堆内存损坏检测和堆内存跟踪的工具，有助于跟踪内存相关错误。有关堆内存分配器的基本信息，请参阅堆内存分配。

### 堆内存信息

要获取堆内存状态的相关信息，请调用以下函数：

- `heap_caps_get_free_size()` 返回不同属性内存的当前空闲内存。
- `heap_caps_get_largest_free_block()` 返回堆中最大的空闲块，也是当前可分配的最大内存块。跟踪此值并将其与总空闲堆对比，可以检测堆碎片化情况。
- `heap_caps_get_minimum_free_size()` 可以跟踪堆启动以来的“低水位”。
- `heap_caps_get_info()` 返回一个 `multi_heap_info_t` 结构体，包含上述函数的信息，以及一些额外的特定堆内存数据（分配数量等）。
- `heap_caps_print_heap_info()` 将 `heap_caps_get_info()` 返回的信息摘要打印到标准输出。
- `heap_caps_dump()` 和 `heap_caps_dump_all()` 输出堆中每个内存块结构的详细信息。注意，这可能会产生大量输出。

### 堆内存分配与释放钩子函数

通过堆内存分配及释放检测钩子，可获取每次堆内存分配及释放操作成功的提示：

- 定义 `esp_heap_trace_alloc_hook()` 获取堆内存分配操作成功的提示
- 定义 `esp_heap_trace_free_hook()` 获取堆内存释放操作成功的提示

要启用此功能，请设置 `CONFIG_HEAP_USE_HOOKS` 选项。`esp_heap_trace_alloc_hook()` 和 `esp_heap_trace_free_hook()` 具有弱声明（即 `__attribute__((weak))`），因此无需为这两个钩子提供声明。鉴于从 ISR 中分配和释放堆内存存在技术上是可行的（但强烈不建议），`esp_heap_trace_alloc_hook()` 和 `esp_heap_trace_free_hook()` 可能会从 ISR 中调用。

不建议在钩子函数中执行（或调用 API 函数执行）阻塞操作或堆内存分配与释放。一般而言，最好保持代码简洁，避免在钩子函数中进行复杂计算。



要定义堆内存分配及释放钩子，请参阅如下示例：

```
#include "esp_heap_caps.h"

void esp_heap_trace_alloc_hook(void* ptr, size_t size, uint32_t caps)
{
    ...
}

void esp_heap_trace_free_hook(void* ptr)
{
    ...
}

void app_main()
{
    ...
}
```

### 堆内存损坏检测

堆内存损坏检测可检测到各类堆内存错误，包括：

- 越界写入和缓冲区溢出
- 写入已释放的内存
- 从已释放或未初始化的内存读取

**断言** 如 `heap/multi_heap.c` 等堆的实现方式包含许多断言，堆内存损坏则断言失败。为高效检测堆内存损坏，请确保在项目配置中通过 `CONFIG_COMPILER_OPTIMIZATION_ASSERTION_LEVEL` 选项启用断言。

如果堆完整性断言失败，将打印一行类似 `CORRUPT HEAP: multi_heap.c:225 detected at 0x3ffbb71c` 的内容，打印的内存地址即内容损坏的堆结构地址。

调用 `heap_caps_check_integrity_all()` 或相关函数可手动检测堆内存完整性，该函数可以检测所有请求的堆内存完整性，在禁用断言时仍可生效。若此完整性检测检测到错误，将打印相应错误及内容损坏的堆内存结构地址。

**内存分配失败钩子** 用户可以使用 `heap_caps_register_failed_alloc_callback()` 注册回调函数，每次内存分配操作失败时都会调用该函数。

此外，若启用 `CONFIG_HEAP_ABORT_WHEN_ALLOCATION_FAILS` 选项，可以在任何分配操作失败时，自动中止系统。

要注册内存分配失败的回调函数，请参阅如下示例：

```
#include "esp_heap_caps.h"

void heap_caps_alloc_failed_hook(size_t requested_size, uint32_t caps, const char_
↳*function_name)
{
    printf("%s was called but failed to allocate %d bytes with 0x%X capabilities. \n
↳", function_name, requested_size, caps);
}

void app_main()
{
    ...
    esp_err_t error = heap_caps_register_failed_alloc_callback(heap_caps_alloc_
↳failed_hook);
    ...
    void *ptr = heap_caps_malloc(allocation_size, MALLOC_CAP_DEFAULT);
```

(下页继续)



```

...
}

```

**定位堆内存损坏** 内存损坏可能是最难定位和修复的错误类型之一，因为导致内存损坏的原因可能与问题的表现毫不相干。以下是有关定位堆内存损坏的一些提示：

- 如果系统崩溃并提示 `CORRUPT HEAP:`，打印信息中通常包含栈跟踪，但此栈跟踪往往无效，因为系统会在检测到堆内存损坏后崩溃，但实际的损坏通常发生在其他位置，且损坏时间早于系统发现的时间。
- 将堆内存调试配置项级别增加到“轻度影响”或“全面”可以得到更准确的信息，定位首个内存损坏的地址。
- 在代码中定期调用 `heap_caps_check_integrity_all()` 或 `heap_caps_check_integrity_addr()` 可以定位内存损坏发生的确切时间。可以反复调整检测函数位置，以定位导致堆内存损坏的代码块。
- 根据损坏的内存地址，按照 [JTAG 调试](#) 在此地址上设置监视点，并在写入时使 CPU 暂停。
- 如果没有 JTAG，但大致了解损坏发生的时间，则可以通过 `esp_cpu_set_watchpoint()` 在软件中提前设置监视点，触发监视点将导致致命错误。函数使用示例为 `esp_cpu_set_watchpoint(0, (void *)addr, 4, ESP_WATCHPOINT_STORE)`。注意，监视点在各个 CPU 独立存在，并且仅设置在当前运行的 CPU 上，因此，若无法确定哪个 CPU 破坏了内存，则需要两个 CPU 上分别调用此函数。
- 对于缓冲区溢出，以 `HEAP_TRACE_ALL` 模式进行 [堆内存跟踪](#) 可以看到哪些调用函数正在从堆中分配哪些地址，详情请参阅 [堆内存跟踪定位堆内存损坏](#)。如果可以找到在已损坏地址的前一地址分配内存的函数，这些函数很可能就是使缓冲区溢出的函数。
- 调用 `heap_caps_dump()` 或 `heap_caps_dump_all()` 提示损坏区域周围堆块的情况，并了解哪些堆块可能已经溢出或下溢等。

**配置项** 暂时提高堆内存损坏检测级别，可以进一步获取有关堆内存损坏错误的详细信息。

在项目配置菜单中，可以在 Component config 下找到 Heap memory debugging 菜单，其中的 `CONFIG_HEAP_CORRUPTION_DETECTION` 选项可以设置为以下三种级别：

**基本模式（无污染）** 此为默认级别，默认情况下，不会启用任何特殊的堆内存损坏检测功能。但会启用提供的断言。如果堆的任何内部数据结构出现覆盖或损坏，就会打印出一个堆内存损坏错误。这通常表示缓冲区溢出或越界写入。

启用断言时，如果出现重复释放相同内存的情况（即双重释放），则会触发断言。

在基本模式调用 `heap_caps_check_integrity()`，可以检查所有堆结构的完整性，并在出错时打印错误信息。

**轻微影响模式** 在此级别下，每个分配的内存块都会在头尾加入“canary 字节”进行“污染”。如果应用程序在已分配缓冲区的边界外写入数据，则会破坏这些 canary 字节，导致完整性检查失败。

头 canary 字的值为 `0xABBA1234`（按字节顺序为 `3412BAAB`），尾 canary 字的值为 `0xBAAD5678`（按字节顺序为 `7856ADBA`）。

基本模式下的堆内存损坏检测可以检测到大多数越界写入，在检测到错误前的越界字节数取决于堆属性。但轻微影响模式更精确，可以检测到单个字节的越界写入。

启用轻微影响模式检测会增加内存使用量，每次内存分配需要 9 至 12 个额外的字节，具体取决于对齐方式。

在轻微影响模式下，每次调用 `heap_caps_free()` 时，都会检查要释放的缓冲区头尾 canary 字节是否匹配预期值。

调用 `heap_caps_check_integrity()` 时，会检查所有已分配的堆内存块的 canary 字节是否匹配预期值。

以上两种情况检查的是，在缓冲区返回给用户之前，已分配块的前 4 个字节是否为 0xABBA1234，以及在缓冲区返回给用户之后，最后 4 个字节是否为 0xBAAD5678。

如果检查到字节与上述值不同，通常表示缓冲区越界或下溢。其中越界表示在写入内存时，写入的数据超过了所分配内存的大小，导致写入了未分配的内存区域；下溢表示在读取内存时，读取的数据超出了所分配内存的范围，读取了未分配的内存区域的数据。

**全面检测模式** 此级别包含了轻微影响模式的检测功能，此外还会检查未初始化访问和使用已释放内存产生的错误。此模式会将所有新分配的内存填充为 0xCE，将所有已释放的内存填充为 0xFE。

启用全面检测模式会对运行性能产生实质影响，因为每次 `heap_caps_malloc()` 或 `heap_caps_free()` 操作完成时，都需要将所有内存设置为分配模式，并检查内存。但是，此模式更容易检测到其他方式难以发现的内存损坏错误。建议只在调试时启用此模式，请勿在生产环境中启用。

**全面检测模式下程序崩溃** 全面检测模式下，如果应用程序在读取或写入与 0xCECECECE 相关地址时崩溃，表示它读取了未初始化内存。此时，应修改应用程序，使用 `heap_caps calloc()` 将内存清零，或在使用前初始化内存。在栈分配的自动变量中也可能存在 0xCECECECE 的值，因为 ESP-IDF 中的大多数任务栈最初由堆分配，而在 C 中，栈内存默认未初始化。

如果应用程序崩溃，且异常寄存器转储指示某些地址或值为 0xFEFEFEFE，表示它读取了已释放的堆内存。此时，应修改应用程序，避免访问已释放的堆内存。

调用 `heap_caps_malloc()` 或 `heap_caps_realloc()` 时，如果在已释放的内存中找到了不同于 0xFEFEFEFE 的值，将导致应用程序崩溃。这表示应用程序写入了已经释放的内存，从而产生错误。

**全面检测模式下手动堆内存检测** 调用 `heap_caps_check_integrity()` 会打印与 0xFEFEFEFE、0xABBA1234、或 0xBAAD5678 相关的错误。在不同情况下，检测器均会检测给定模式，若未找到，则输出相应错误：

- 对于已释放的堆内存块，检测器会检查是否所有字节都设置为 0xFE，检测到任何其他值都表示错误写入了已释放内存。
- 对于已分配的堆内存块，检测器的检查模式与轻微影响模式相同，即在每个分配的缓冲区头部和尾部检查 canary 字节 0xABBA1234 和 0xBAAD5678，检测到任何其他字节都表示缓冲区越界或下溢。

## 堆任务跟踪

堆任务跟踪可获取堆内存分配的各任务信息，应用程序须指定计划跟踪堆分配的堆属性。

示例代码可参考 [system/heap\\_task\\_tracking](#)。

## 堆内存跟踪

堆内存跟踪支持跟踪用于分配或释放内存的代码，且支持以下两种跟踪模式：

- 独立模式。此模式下，跟踪数据保存在设备上（因此收集的信息大小受指定缓冲区限制），并由设备上的代码完成分析。部分 API 可访问和转储收集的信息。
- 主机模式。此模式不受独立模式所限制，其跟踪数据使用 `app_trace` 库通过 JTAG 连接发送到主机，随后使用特殊工具完成分析。

堆内存跟踪具有以下两种功能：

- 泄漏检测：检测已分配但未释放的内存。
- 堆内存使用分析：显示在跟踪运行期间所有分配或释放内存的函数。

**如何判断内存泄漏** 如果怀疑存在内存泄漏，首先要找出程序中存在泄漏的部分。调用 `heap_caps_get_free_size()` 或 [堆内存信息](#) 中的其他相关函数，跟踪应用程序的内存使用情况，尝试将泄漏范围缩小到某个或一系列空闲内存始终减少而没有恢复的函数。

**独立模式** 确定存在泄漏的代码后，请执行以下步骤：

- 启用 `CONFIG_HEAP_TRACING_DEST` 选项。
- 在程序早期调用函数 `heap_trace_init_standalone()` 注册一个可用于记录内存跟踪的缓冲区。
- 在有内存泄漏之嫌的代码块前，调用函数 `heap_trace_start()` 记录系统中的所有内存分配和释放操作。
- 在有内存泄露之嫌的代码块后，调用函数 `heap_trace_stop()` 停止跟踪。
- 调用函数 `heap_trace_dump()` 导出内存跟踪结果。

应用程序代码初始化、启动和停止堆内存跟踪的一般过程，见以下代码片段示例：

```
#include "esp_heap_trace.h"

#define NUM_RECORDS 100
static heap_trace_record_t trace_record[NUM_RECORDS]; // 该缓冲区必须在内部 RAM 中

...

void app_main()
{
    ...
    ESP_ERROR_CHECK( heap_trace_init_standalone(trace_record, NUM_RECORDS) );
    ...
}

void some_function()
{
    ESP_ERROR_CHECK( heap_trace_start(HEAP_TRACE_LEAKS) );

    do_something_you_suspect_is_leaking();

    ESP_ERROR_CHECK( heap_trace_stop() );
    heap_trace_dump();
    ...
}
```

堆内存跟踪堆输出将类似以下格式的内容：

```
2 allocations trace (100 entry buffer)
32 bytes (@ 0x3ffaf214) allocated CPU 0 ccount 0x2e9b7384 caller
8 bytes (@ 0x3ffaf804) allocated CPU 0 ccount 0x2e9b79c0 caller
40 bytes 'leaked' in trace (2 allocations)
total allocations 2 total frees 0
```

**备注：** 以上示例输出使用 [IDF 监视器](#)，自动将 PC 地址解码为其源文件和行号。

第一行表示与缓冲区的总大小相比，缓冲区内的分配条目数量。

在 `HEAP_TRACE_LEAKS` 模式下，对跟踪的每个未释放的已分配内存，打印的信息中都会包含以下内容：

- `XX bytes`：分配的字节数。
- `@ 0x...`：从 `heap_caps_malloc()` 或 `heap_caps_calloc()` 返回的堆地址。
- `Internal` 或 `PSRAM`：分配内存的一般位置。
- `CPU x`：分配过程中运行的 CPU（CPU 0 或 CPU 1）。
- `ccount 0x...`：分配时的 `CCOUNT`（CPU 循环计数器）寄存器值，CPU 0 与 CPU 1 中的这一值不同。

最后，将打印“泄漏”的总字节数（即在跟踪期间分配但未释放的总字节数），以及它所代表的总分配次数。

如果跟踪缓冲区不足以容纳所有分配，则会打印警告。如果看到此警告，请考虑缩短跟踪时间，或增加跟踪缓冲区中记录的数量。

**主机模式** 确定存在泄漏的代码后，请执行以下步骤：

- 在项目配置菜单中，导航至 Component settings > Heap Memory Debugging > [CONFIG\\_HEAP\\_TRACING\\_DEST](#) 并选择 Host-Based。
- 在项目配置菜单中，导航至 Component settings > Application Level Tracing > [CONFIG\\_APPTRACE\\_DESTINATION1](#) 并选择 Trace memory。
- 在项目配置菜单中，导航至 Component settings > Application Level Tracing > FreeRTOS SystemView Tracing 并启用 [CONFIG\\_APPTRACE\\_SV\\_ENABLE](#)。
- 在程序早期，调用函数 `heap_trace_init_tohost()`，初始化 JTAG 堆内存跟踪模块。
- 在有内存泄漏之嫌的代码块前，调用函数 `heap_trace_start()` 开始记录系统中的内存分配和释放操作。  
主机模式忽略该函数参数，堆内存跟踪模块以 `HEAP_TRACE_ALL` 传递后的方式运行，即所有的内存分配和释放都发送到主机。
- 在有内存泄露之嫌的代码块后，调用函数 `heap_trace_stop()` 停止跟踪。

应用程序代码初始化、启动和停止基于主机模式堆内存跟踪的一般过程，请参阅以下代码片段示例：

```
#include "esp_heap_trace.h"

...

void app_main()
{
    ...
    ESP_ERROR_CHECK( heap_trace_init_tohost() );
    ...
}

void some_function()
{
    ESP_ERROR_CHECK( heap_trace_start(HEAP_TRACE_LEAKS) );

    do_something_you_suspect_is_leaking();

    ESP_ERROR_CHECK( heap_trace_stop() );
    ...
}
```

要收集并分析堆内存跟踪结果，请在主机上完成以下操作：

1. 构建程序并将其下载到目标设备，详情请参阅[第五步：开始使用 ESP-IDF](#)吧。
2. 运行 OpenOCD（请参阅[JTAG 调试](#)）。

**备注：**使用此功能需要 v0.10.0-esp32-20181105 或更高版本的 OpenOCD。

3. 使用 GDB 可以自动启动和/或停止跟踪，为此应准备特殊的 gdbinit 文件：

```
target remote :3333

mon reset halt
maintenance flush register-cache

tb heap_trace_start
commands
mon esp sysview start file:///tmp/heap.svdat
c
end
```

(下页继续)

```

tb heap_trace_stop
commands
mon esp sysview stop
end
c

```

使用此文件，GDB 将连接到目标设备、重置该设备，在程序触发 `heap_trace_start()` 断点时开始跟踪，在程序触发 `heap_trace_stop()` 断点时停止跟踪。跟踪数据将保存至 `/tmp/heap_log.svdat`。

4. 使用命令 `riscv32-esp-elf-gdb -x gdbinit </path/to/program/elf>` 运行 GDB
5. 调用 `heap_trace_stop()` 函数使程序停止运行时，退出 GDB，跟踪数据将保存至 `/tmp/heap.svdat`
6. 运行处理脚本 `$IDF_PATH/tools/esp_app_trace/sysviewtrace_proc.py -p -b </path/to/program/elf> /tmp/heap_log.svdat`

堆内存跟踪堆输出将类似以下格式的内容：

```

Parse trace from '/tmp/heap.svdat'...
Stop parsing trace. (Timeout 0.000000 sec while reading 1 byte!)
Process events from '['/tmp/heap.svdat']'...
[0.002244575] HEAP: Allocated 1 byte @ 0x3ffaafd8 from task "alloc" on core 0 by:
/home/user/projects/esp/esp-idf/examples/system/sysview_tracing_heap_log/main/
↪sysview_heap_log.c:47
/home/user/projects/esp/esp-idf/components/freertos/port.c:355 (discriminator 1)

[0.002258425] HEAP: Allocated 2 bytes @ 0x3ffaaffe0 from task "alloc" on core 0 by:
/home/user/projects/esp/esp-idf/examples/system/sysview_tracing_heap_log/main/
↪sysview_heap_log.c:48
/home/user/projects/esp/esp-idf/components/freertos/port.c:355 (discriminator 1)

[0.002563725] HEAP: Freed bytes @ 0x3ffaaffe0 from the task "free" on core 0 by:
/home/user/projects/esp/esp-idf/examples/system/sysview_tracing_heap_log/main/
↪sysview_heap_log.c:31 (discriminator 9)
/home/user/projects/esp/esp-idf/components/freertos/port.c:355 (discriminator 1)

[0.002782950] HEAP: Freed bytes @ 0x3ffb40b8 from the task "main" on core 0 by:
/home/user/projects/esp/esp-idf/components/freertos/tasks.c:4590
/home/user/projects/esp/esp-idf/components/freertos/tasks.c:4590

[0.002798700] HEAP: Freed bytes @ 0x3ffb50bc from the task "main" on core 0 by:
/home/user/projects/esp/esp-idf/components/freertos/tasks.c:4590
/home/user/projects/esp/esp-idf/components/freertos/tasks.c:4590

[0.102436025] HEAP: Allocated 2 bytes @ 0x3ffaaffe0 from the task "alloc" on core 0
↪by:
/home/user/projects/esp/esp-idf/examples/system/sysview_tracing_heap_log/main/
↪sysview_heap_log.c:47
/home/user/projects/esp/esp-idf/components/freertos/port.c:355 (discriminator 1)

[0.102449800] HEAP: Allocated 4 bytes @ 0x3ffaaffe8 from the task "alloc" on core 0
↪by:
/home/user/projects/esp/esp-idf/examples/system/sysview_tracing_heap_log/main/
↪sysview_heap_log.c:48
/home/user/projects/esp/esp-idf/components/freertos/port.c:355 (discriminator 1)

[0.102666150] HEAP: Freed bytes @ 0x3ffaaffe8 from the task "free" on core 0 by:
/home/user/projects/esp/esp-idf/examples/system/sysview_tracing_heap_log/main/
↪sysview_heap_log.c:31 (discriminator 9)
/home/user/projects/esp/esp-idf/components/freertos/port.c:355 (discriminator 1)

```

(下页继续)

```
[0.202436200] HEAP: Allocated 3 bytes @ 0x3ffaffe8 from the task "alloc" on core 0
↳by:
/home/user/projects/esp/esp-idf/examples/system/sysview_tracing_heap_log/main/
↳sysview_heap_log.c:47
/home/user/projects/esp/esp-idf/components/freertos/port.c:355 (discriminator 1)

[0.202451725] HEAP: Allocated 6 bytes @ 0x3ffaaff0 from the task "alloc" on core 0
↳by:
/home/user/projects/esp/esp-idf/examples/system/sysview_tracing_heap_log/main/
↳sysview_heap_log.c:48
/home/user/projects/esp/esp-idf/components/freertos/port.c:355 (discriminator 1)

[0.202667075] HEAP: Freed bytes @ 0x3ffaaff0 from the task "free" on core 0 by:
/home/user/projects/esp/esp-idf/examples/system/sysview_tracing_heap_log/main/
↳sysview_heap_log.c:31 (discriminator 9)
/home/user/projects/esp/esp-idf/components/freertos/port.c:355 (discriminator 1)

[0.302436000] HEAP: Allocated 4 bytes @ 0x3ffaaff0 from the task "alloc" on core 0
↳by:
/home/user/projects/esp/esp-idf/examples/system/sysview_tracing_heap_log/main/
↳sysview_heap_log.c:47
/home/user/projects/esp/esp-idf/components/freertos/port.c:355 (discriminator 1)

[0.302451475] HEAP: Allocated 8 bytes @ 0x3ffb40b8 from the task "alloc" on core 0
↳by:
/home/user/projects/esp/esp-idf/examples/system/sysview_tracing_heap_log/main/
↳sysview_heap_log.c:48
/home/user/projects/esp/esp-idf/components/freertos/port.c:355 (discriminator 1)

[0.302667500] HEAP: Freed bytes @ 0x3ffb40b8 from the task "free" on core 0 by:
/home/user/projects/esp/esp-idf/examples/system/sysview_tracing_heap_log/main/
↳sysview_heap_log.c:31 (discriminator 9)
/home/user/projects/esp/esp-idf/components/freertos/port.c:355 (discriminator 1)

Processing completed.

Processed 1019 events

===== HEAP TRACE REPORT =====

Processed 14 heap events.

[0.002244575] HEAP: Allocated 1 bytes @ 0x3ffaafd8 from the task "alloc" on core 0
↳by:
/home/user/projects/esp/esp-idf/examples/system/sysview_tracing_heap_log/main/
↳sysview_heap_log.c:47
/home/user/projects/esp/esp-idf/components/freertos/port.c:355 (discriminator 1)

[0.102436025] HEAP: Allocated 2 bytes @ 0x3ffaffe0 from the task "alloc" on core 0
↳by:
/home/user/projects/esp/esp-idf/examples/system/sysview_tracing_heap_log/main/
↳sysview_heap_log.c:47
/home/user/projects/esp/esp-idf/components/freertos/port.c:355 (discriminator 1)

[0.202436200] HEAP: Allocated 3 bytes @ 0x3ffaffe8 from the task "alloc" on core 0
↳by:
/home/user/projects/esp/esp-idf/examples/system/sysview_tracing_heap_log/main/
↳sysview_heap_log.c:47
/home/user/projects/esp/esp-idf/components/freertos/port.c:355 (discriminator 1)
```



```
[0.302436000] HEAP: Allocated 4 bytes @ 0x3ffaaff0 from the task "alloc" on core 0
↳by:
/home/user/projects/esp/esp-idf/examples/system/sysview_tracing_heap_log/main/
↳sysview_heap_log.c:47
/home/user/projects/esp/esp-idf/components/freertos/port.c:355 (discriminator 1)

Found 10 leaked bytes in 4 blocks.
```

**堆内存跟踪定位堆内存损坏** 堆内存跟踪也是一种定位堆内存损坏位置的方法。当堆中的某个区域损坏时，可能是因为程序中的其他部分在相邻地址分配内存。

如果大致了解堆内存损坏发生的时间范围，启用 `HEAP_TRACE_ALL` 模式的堆内存跟踪，可以记录分配内存的所有函数及其相应地址。

以此方法使用堆内存跟踪与上文描述的内存泄漏检测类似，对已分配但未释放的内存输出结果相同，但还会显示已释放内存的记录。

**性能影响** 在 `menuconfig` 中启用堆内存跟踪，会增加程序代码的大小，即便未运行堆内存跟踪，也会对堆内存分配或释放操作的性能产生较小的负面影响。

运行堆内存跟踪时，堆内存分配或释放操作的速度明显变慢。增加为各内存分配的栈帧深度（见上文）也会造成这种性能影响。

为减轻堆内存跟踪运行时的性能损失，请启用 `CONFIG_HEAP_TRACE_HASH_MAP`。此时，将使用哈希映射机制处理堆内存跟踪记录，减少堆内存分配或释放操作的执行时长。设置 `CONFIG_HEAP_TRACE_HASH_MAP_SIZE` 的值可以调整哈希映射的大小。

**内存泄漏误报** 并非所有由 `heap_trace_dump()` 打印的信息都是内存泄漏，以下情况也可能打印信息：

- 在调用 `heap_trace_start()` 后分配且在调用 `heap_trace_stop()` 后才释放的内存都会出现在泄漏信息中。
- 系统中的其他任务也可能进行内存分配。根据这些任务的时间安排，报错的这部分内存很可能在调用 `heap_trace_stop()` 后释放。
- 当任务第一次使用 `stdio`，如调用 `heap_caps_printf()` 时，`libc` 会分配一个锁，即 `RTOS` 互斥信号量，该分配将持续至任务删除。
- 进行打印浮点数等调用 `heap_caps_printf()` 的操作时，会根据需要，从堆中分配一些内存，这些分配将持续至任务删除。
- 蓝牙、Wi-Fi 和 TCP/IP 库会分配堆内存缓冲区，处理传入或传出的数据，这些内存缓冲区通常持续时间较短。但如果在运行堆内存泄漏跟踪期间，网络底层接收或发送了数据，一些缓冲区可能会出现在堆内存泄漏跟踪输出中。
- 由于存在 `TIME_WAIT` 状态，TCP 连接在关闭后仍会使用一些内存，`TIME_WAIT` 状态结束后将释放这些内存。

要区分“真实”和“误报”的内存泄漏，可以在堆内存跟踪运行时多次调用可疑代码，并在堆内存跟踪输出中查找重复出现的内存分配情况。

## API 参考 - 堆内存跟踪

### Header File

- `components/heap/include/esp_heap_trace.h`
- This header file can be included with:

```
#include "esp_heap_trace.h"
```

**Functions**

*esp\_err\_t* **heap\_trace\_init\_standalone** (*heap\_trace\_record\_t* \*record\_buffer, size\_t num\_records)

Initialise heap tracing in standalone mode.

This function must be called before any other heap tracing functions.

To disable heap tracing and allow the buffer to be freed, stop tracing and then call `heap_trace_init_standalone(NULL, 0)`;

**参数**

- **record\_buffer** -- Provide a buffer to use for heap trace data. Note: External RAM is allowed, but it prevents recording allocations made from ISR's.
- **num\_records** -- Size of the heap trace buffer, as number of record structures.

**返回**

- **ESP\_ERR\_NOT\_SUPPORTED** Project was compiled without heap tracing enabled in menuconfig.
- **ESP\_ERR\_INVALID\_STATE** Heap tracing is currently in progress.
- **ESP\_OK** Heap tracing initialised successfully.

*esp\_err\_t* **heap\_trace\_init\_tohost** (void)

Initialise heap tracing in host-based mode.

This function must be called before any other heap tracing functions.

**返回**

- **ESP\_ERR\_INVALID\_STATE** Heap tracing is currently in progress.
- **ESP\_OK** Heap tracing initialised successfully.

*esp\_err\_t* **heap\_trace\_start** (*heap\_trace\_mode\_t* mode)

Start heap tracing. All heap allocations & frees will be traced, until `heap_trace_stop()` is called.

---

**备注:** `heap_trace_init_standalone()` must be called to provide a valid buffer, before this function is called.

---



---

**备注:** Calling this function while heap tracing is running will reset the heap trace state and continue tracing.

---

**参数** **mode** -- Mode for tracing.

- **HEAP\_TRACE\_ALL** means all heap allocations and frees are traced.
- **HEAP\_TRACE\_LEAKS** means only suspected memory leaks are traced. (When memory is freed, the record is removed from the trace buffer.)

**返回**

- **ESP\_ERR\_NOT\_SUPPORTED** Project was compiled without heap tracing enabled in menuconfig.
- **ESP\_ERR\_INVALID\_STATE** A non-zero-length buffer has not been set via `heap_trace_init_standalone()`.
- **ESP\_OK** Tracing is started.

*esp\_err\_t* **heap\_trace\_stop** (void)

Stop heap tracing.

**返回**

- **ESP\_ERR\_NOT\_SUPPORTED** Project was compiled without heap tracing enabled in menuconfig.
- **ESP\_ERR\_INVALID\_STATE** Heap tracing was not in progress.
- **ESP\_OK** Heap tracing stopped..

*esp\_err\_t* **heap\_trace\_resume** (void)

Resume heap tracing which was previously stopped.

Unlike `heap_trace_start()`, this function does not clear the buffer of any pre-existing trace records.



The heap trace mode is the same as when `heap_trace_start()` was last called (or `HEAP_TRACE_ALL` if `heap_trace_start()` was never called).

**返回**

- `ESP_ERR_NOT_SUPPORTED` Project was compiled without heap tracing enabled in `menuconfig`.
- `ESP_ERR_INVALID_STATE` Heap tracing was already started.
- `ESP_OK` Heap tracing resumed.

`size_t heap_trace_get_count` (void)

Return number of records in the heap trace buffer.

It is safe to call this function while heap tracing is running.

*esp\_err\_t heap\_trace\_get* (`size_t` index, *heap\_trace\_record\_t* \*record)

Return a raw record from the heap trace buffer.

---

**备注:** It is safe to call this function while heap tracing is running, however in `HEAP_TRACE_LEAK` mode record indexing may skip entries unless heap tracing is stopped first.

---

**参数**

- **index** -- Index (zero-based) of the record to return.
- **record** -- [out] Record where the heap trace record will be copied.

**返回**

- `ESP_ERR_NOT_SUPPORTED` Project was compiled without heap tracing enabled in `menuconfig`.
- `ESP_ERR_INVALID_STATE` Heap tracing was not initialised.
- `ESP_ERR_INVALID_ARG` Index is out of bounds for current heap trace record count.
- `ESP_OK` Record returned successfully.

void `heap_trace_dump` (void)

Dump heap trace record data to stdout.

---

**备注:** It is safe to call this function while heap tracing is running, however in `HEAP_TRACE_LEAK` mode the dump may skip entries unless heap tracing is stopped first.

---

void `heap_trace_dump_caps` (`const uint32_t` caps)

Dump heap trace from the memory of the capabilities passed as parameter.

**参数 caps** -- Capability(ies) of the memory from which to dump the trace. Set `MALLOC_CAP_INTERNAL` to dump heap trace data from internal memory. Set `MALLOC_CAP_SPIRAM` to dump heap trace data from PSRAM. Set both to dump both heap trace data.

*esp\_err\_t heap\_trace\_summary* (*heap\_trace\_summary\_t* \*summary)

Get summary information about the result of a heap trace.

---

**备注:** It is safe to call this function while heap tracing is running.

---

## Structures

struct `heap_trace_record_t`

Trace record data type. Stores information about an allocated region of memory.

### Public Members

uint32\_t **ccount**

CCOUNT of the CPU when the allocation was made. LSB (bit value 1) is the CPU number (0 or 1).

void \***address**

Address which was allocated. If NULL, then this record is empty.

size\_t **size**

Size of the allocation.

void \***allocated\_by**[CONFIG\_HEAP\_TRACING\_STACK\_DEPTH]

Call stack of the caller which allocated the memory.

void \***freed\_by**[CONFIG\_HEAP\_TRACING\_STACK\_DEPTH]

Call stack of the caller which freed the memory (all zero if not freed.)

struct **heap\_trace\_summary\_t**

Stores information about the result of a heap trace.

### Public Members

*heap\_trace\_mode\_t* **mode**

The heap trace mode we just completed / are running.

size\_t **total\_allocations**

The total number of allocations made during tracing.

size\_t **total\_frees**

The total number of frees made during tracing.

size\_t **count**

The number of records in the internal buffer.

size\_t **capacity**

The capacity of the internal buffer.

size\_t **high\_water\_mark**

The maximum value that 'count' got to.

size\_t **has\_overflowed**

True if the internal buffer overflowed at some point.

### Macros

**CONFIG\_HEAP\_TRACING\_STACK\_DEPTH**

## Type Definitions

typedef struct *heap\_trace\_record\_t* **heap\_trace\_record\_t**

Trace record data type. Stores information about an allocated region of memory.

## Enumerations

enum **heap\_trace\_mode\_t**

Values:

enumerator **HEAP\_TRACE\_ALL**

enumerator **HEAP\_TRACE\_LEAKS**

## 2.10.17 ESP 定时器

### API 参考

#### Header File

- [components/esp\\_timer/include/esp\\_timer.h](#)
- This header file can be included with:

```
#include "esp_timer.h"
```

- This header file is a part of the API provided by the `esp_timer` component. To declare that your component depends on `esp_timer`, add the following to your `CMakeLists.txt`:

```
REQUIRES esp_timer
```

or

```
PRIV_REQUIRES esp_timer
```

#### Functions

*esp\_err\_t* **esp\_timer\_early\_init**(void)

Minimal initialization of `esp_timer`.

This function can be called very early in startup process, after this call only *esp\_timer\_get\_time()* function can be used.

---

**备注:** This function is called from startup code. Applications do not need to call this function before using other `esp_timer` APIs.

---

#### 返回

- `ESP_OK` on success

*esp\_err\_t* **esp\_timer\_init** (void)

Initialize esp\_timer library.

This function will be called from startup code on every core. If Kconfig option `CONFIG_ESP_TIMER_ISR_AFFINITY` is set to `NO_AFFINITY`, it allocates the timer ISR on `MULTIPLE` cores and creates the timer task which can be run on any core.

---

**备注:** This function is called from startup code. Applications do not need to call this function before using other esp\_timer APIs. Before calling this function, *esp\_timer\_early\_init()* must be called by the startup code.

---

#### 返回

- `ESP_OK` on success
- `ESP_ERR_NO_MEM` if allocation has failed
- `ESP_ERR_INVALID_STATE` if already initialized
- other errors from interrupt allocator

*esp\_err\_t* **esp\_timer\_deinit** (void)

De-initialize esp\_timer library.

---

**备注:** Normally this function should not be called from applications

---

#### 返回

- `ESP_OK` on success
- `ESP_ERR_INVALID_STATE` if not yet initialized

*esp\_err\_t* **esp\_timer\_create** (const *esp\_timer\_create\_args\_t* \*create\_args, *esp\_timer\_handle\_t* \*out\_handle)

Create an esp\_timer instance.

---

**备注:** When timer no longer needed, delete it using *esp\_timer\_delete()*.

---

#### 参数

- **create\_args** -- Pointer to a structure with timer creation arguments. Not saved by the library, can be allocated on the stack.
- **out\_handle** -- [out] Output, pointer to *esp\_timer\_handle\_t* variable that holds the created timer handle.

#### 返回

- `ESP_OK` on success
- `ESP_ERR_INVALID_ARG` if some of the create\_args are not valid
- `ESP_ERR_INVALID_STATE` if esp\_timer library is not initialized yet
- `ESP_ERR_NO_MEM` if memory allocation fails

*esp\_err\_t* **esp\_timer\_start\_once** (*esp\_timer\_handle\_t* timer, uint64\_t timeout\_us)

Start a one-shot timer.

Timer represented by `timer` should not be running when this function is called.

#### 参数

- **timer** -- timer handle created using *esp\_timer\_create()*
- **timeout\_us** -- timer timeout, in microseconds relative to the current moment

#### 返回

- `ESP_OK` on success
- `ESP_ERR_INVALID_ARG` if the handle is invalid
- `ESP_ERR_INVALID_STATE` if the timer is already running

*esp\_err\_t* **esp\_timer\_start\_periodic** (*esp\_timer\_handle\_t* timer, uint64\_t period)

Start a periodic timer.

Timer represented by `timer` should not be running when this function is called. This function starts the timer which will trigger every `period` microseconds.

#### 参数

- **timer** -- timer handle created using *esp\_timer\_create()*
- **period** -- timer period, in microseconds

#### 返回

- ESP\_OK on success
- ESP\_ERR\_INVALID\_ARG if the handle is invalid
- ESP\_ERR\_INVALID\_STATE if the timer is already running

*esp\_err\_t* **esp\_timer\_restart** (*esp\_timer\_handle\_t* timer, uint64\_t timeout\_us)

Restart a currently running timer.

Type of <code>timer</code>	Action
One-shot timer	Restarted immediately and times out once in <code>timeout_us</code> microseconds
Periodic timer	Restarted immediately with a new period of <code>timeout_us</code> microseconds

#### 参数

- **timer** -- timer handle created using *esp\_timer\_create()*
- **timeout\_us** -- Timeout in microseconds relative to the current time. In case of a periodic timer, also represents the new period.

#### 返回

- ESP\_OK on success
- ESP\_ERR\_INVALID\_ARG if the handle is invalid
- ESP\_ERR\_INVALID\_STATE if the timer is not running

*esp\_err\_t* **esp\_timer\_stop** (*esp\_timer\_handle\_t* timer)

Stop a running timer.

This function stops the timer previously started using *esp\_timer\_start\_once()* or *esp\_timer\_start\_periodic()*.

参数 **timer** -- timer handle created using *esp\_timer\_create()*

#### 返回

- ESP\_OK on success
- ESP\_ERR\_INVALID\_STATE if the timer is not running

*esp\_err\_t* **esp\_timer\_delete** (*esp\_timer\_handle\_t* timer)

Delete an `esp_timer` instance.

The timer must be stopped before deleting. A one-shot timer which has expired does not need to be stopped.

参数 **timer** -- timer handle created using *esp\_timer\_create()*

#### 返回

- ESP\_OK on success
- ESP\_ERR\_INVALID\_STATE if the timer is running

int64\_t **esp\_timer\_get\_time** (void)

Get time in microseconds since boot.

返回 Number of microseconds since the initialization of ESP Timer

int64\_t **esp\_timer\_get\_next\_alarm** (void)

Get the timestamp of the next expected timeout.

返回 Timestamp of the nearest timer event, in microseconds. The timebase is the same as for the values returned by *esp\_timer\_get\_time()*.

`int64_t esp_timer_get_next_alarm_for_wake_up` (void)

Get the timestamp of the next expected timeout excluding those timers that should not interrupt light sleep (such timers have `esp_timer_create_args_t::skip_unhandled_events` enabled)

**返回** Timestamp of the nearest timer event, in microseconds. The timebase is the same as for the values returned by `esp_timer_get_time()`.

`esp_err_t esp_timer_get_period` (`esp_timer_handle_t` timer, `uint64_t` \*period)

Get the period of a timer.

This function fetches the timeout period of a timer. For a one-shot timer, the timeout period will be 0.

**参数**

- **timer** -- timer handle created using `esp_timer_create()`
- **period** -- memory to store the timer period value in microseconds

**返回**

- ESP\_OK on success
- ESP\_ERR\_INVALID\_ARG if the arguments are invalid

`esp_err_t esp_timer_get_expiry_time` (`esp_timer_handle_t` timer, `uint64_t` \*expiry)

Get the expiry time of a one-shot timer.

This function fetches the expiry time of a one-shot timer.

---

**备注:** Passing the timer handle of a periodic timer will result in an error.

---

**参数**

- **timer** -- timer handle created using `esp_timer_create()`
- **expiry** -- memory to store the timeout value in microseconds

**返回**

- ESP\_OK on success
- ESP\_ERR\_INVALID\_ARG if the arguments are invalid
- ESP\_ERR\_NOT\_SUPPORTED if the timer type is periodic

`esp_err_t esp_timer_dump` (FILE \*stream)

Dump the list of timers to a stream.

By default, this function prints the list of active (running) timers. The output format is:

```
| Name | Period | Alarm |
```

- Name —timer pointer
- Period —period of timer in microseconds, or 0 for one-shot timer
- Alarm - time of the next alarm in microseconds since boot, or 0 if the timer is not started

To print the list of all created timers, enable Kconfig option `CONFIG_ESP_TIMER_PROFILING`. In this case, the output format is:

```
| Name | Period | Alarm | Times_armed | Times_trigg | Times_skip | Cb_exec_time |
```

- Name —timer name
- Period —same as above
- Alarm —same as above
- Times\_armed —number of times the timer was armed via `esp_timer_start_X`
- Times\_triggered - number of times the callback was triggered
- Times\_skipped - number of times the callback was skipped
- Callback\_exec\_time - total time taken by callback to execute, across all calls

**参数** **stream** -- stream (such as stdout) to which to dump the information

**返回**

- ESP\_OK on success
- ESP\_ERR\_NO\_MEM if can not allocate temporary buffer for the output

void **esp\_timer\_isr\_dispatch\_need\_yield** (void)

Requests a context switch from a timer callback function.

This only works for a timer that has an ISR dispatch method. The context switch will be called after all ISR dispatch timers have been processed.

bool **esp\_timer\_is\_active** (*esp\_timer\_handle\_t* timer)

Returns status of a timer, active or not.

This function is used to identify if the timer is still active (running) or not.

**参数 timer** -- timer handle created using *esp\_timer\_create()*

**返回**

- 1 if timer is still active (running)
- 0 if timer is not active

*esp\_err\_t* **esp\_timer\_new\_etm\_alarm\_event** (*esp\_etm\_event\_handle\_t* \*out\_event)

Get the ETM event handle of esp\_timer underlying alarm event.

---

**备注:** The created ETM event object can be deleted later using *esp\_etm\_del\_event()*

---

---

**备注:** The ETM event is generated by the underlying hardware - systimer; therefore, if the esp\_timer is not clocked by systimer, then no ETM event will be generated.

---

**参数 out\_event** -- [out] Returned ETM event handle

**返回**

- ESP\_OK Success
- ESP\_ERR\_INVALID\_ARG Parameter error

## Structures

struct **esp\_timer\_create\_args\_t**

Timer configuration passed to *esp\_timer\_create()*

## Public Members

*esp\_timer\_cb\_t* **callback**

Callback function to execute when timer expires.

void \***arg**

Argument to pass to callback.

*esp\_timer\_dispatch\_t* **dispatch\_method**

Dispatch callback from task or ISR; if not specified, esp\_timer task.

const char \***name**

Timer name, used in *esp\_timer\_dump()* function.

bool **skip\_unhandled\_events**

Setting to skip unhandled events in light sleep for periodic timers.

### Type Definitions

typedef struct esp\_timer \***esp\_timer\_handle\_t**

Opaque type representing a single timer handle.

typedef void (\***esp\_timer\_cb\_t**)(void \*arg)

Timer callback function type.

**Param arg** pointer to opaque user-specific data

### Enumerations

enum **esp\_timer\_dispatch\_t**

Method to dispatch timer callback.

*Values:*

enumerator **ESP\_TIMER\_TASK**

Callback is dispatched from esp\_timer task.

enumerator **ESP\_TIMER\_ISR**

Callback is dispatched from interrupt handler.

enumerator **ESP\_TIMER\_MAX**

Sentinel value for the number of callback dispatch methods.

## 2.10.18 内部 API 和不稳定的 API

该文档列举了一些 API，这些 API 供内部使用或可能在 ESP-IDF 后续版本中被更改或删除。

### API 参考

#### Header File

- [components/esp\\_rom/include/esp\\_rom\\_sys.h](#)
- This header file can be included with:

```
#include "esp_rom_sys.h"
```

#### Functions

void **esp\_rom\_software\_reset\_system** (void)

Software Reset digital core include RTC.

It is not recommended to use this function in esp-idf, use esp\_restart() instead.

void **esp\_rom\_software\_reset\_cpu** (int cpu\_no)

Software Reset cpu core.

It is not recommended to use this function in esp-idf, use esp\_restart() instead.



参数 **cpu\_no** -- : The CPU to reset, 0 for PRO CPU, 1 for APP CPU.

int **esp\_rom\_printf** (const char \*fmt, ...)

Print formatted string to console device.

---

备注: float and long long data are not supported!

---

参数

- **fmt** -- Format string
- ... -- Additional arguments, depending on the format string

返回 int: Total number of characters written on success; A negative number on failure.

void **esp\_rom\_delay\_us** (uint32\_t us)

Pauses execution for us microseconds.

参数 **us** -- Number of microseconds to pause

void **esp\_rom\_install\_channel\_putc** (int channel, void (\*putc)(char c))

esp\_rom\_printf can print message to different channels simultaneously. This function can help install the low level putc function for esp\_rom\_printf.

参数

- **channel** -- Channel number (starting from 1)
- **putc** -- Function pointer to the putc implementation. Set NULL can disconnect esp\_rom\_printf with putc.

void **esp\_rom\_install\_uart\_printf** (void)

Install UART1 as the default console channel, equivalent to esp\_rom\_install\_channel\_putc(1, esp\_rom\_output\_putc)

soc\_reset\_reason\_t **esp\_rom\_get\_reset\_reason** (int cpu\_no)

Get reset reason of CPU.

参数 **cpu\_no** -- CPU number

返回 Reset reason code (see in soc/reset\_reasons.h)

void **esp\_rom\_route\_intr\_matrix** (int cpu\_core, uint32\_t periph\_intr\_id, uint32\_t cpu\_intr\_num)

Route peripheral interrupt sources to CPU's interrupt port by matrix.

Usually there're 4 steps to use an interrupt:

- Route peripheral interrupt source to CPU. e.g. `esp_rom_route_intr_matrix(0, ETS_WIFI_MAC_INTR_SOURCE, ETS_WMAC_INUM)`
- Set interrupt handler for CPU
- Enable CPU interrupt
- Enable peripheral interrupt

参数

- **cpu\_core** -- The CPU number, which the peripheral interrupt will inform to
- **periph\_intr\_id** -- The peripheral interrupt source number
- **cpu\_intr\_num** -- The CPU (external) interrupt number. On targets that use CLIC as their interrupt controller, this number represents the external interrupt number. For example, passing `cpu_intr_num = i` to this function would in fact bind peripheral source to CPU interrupt `CLIC_EXT_INTR_NUM_OFFSET + i`.

uint32\_t **esp\_rom\_get\_cpu\_ticks\_per\_us** (void)

Get the real CPU ticks per us.

返回 CPU ticks per us

```
void esp_rom_set_cpu_ticks_per_us (uint32_t ticks_per_us)
```

Set the real CPU tick rate.

---

**备注:** Call this function when CPU frequency is changed, otherwise the `esp_rom_delay_us` can be inaccurate.

---

参数 `ticks_per_us` -- CPU ticks per us

## 2.10.19 中断分配

### 概述

ESP32-H2 有一个核，28 个外部异步中断。每个中断的优先级别都可独立地通过编程设置。此外，还有 4 个核心本地中断源 (CLINT)。详细信息请参见 [ESP32-H2 技术参考手册 \[PDF\]](#)。

由于中断源数量多于中断，有时多个驱动程序可以共用一个中断。`esp_intr_alloc()` 抽象隐藏了这些实现细节。

驱动程序可以通过调用 `esp_intr_alloc()`，或 `esp_intr_alloc_intrstatus()` 为某个外设分配中断。通过向此函数传递 `flag`，可以指定中断类型、优先级和触发方式。然后，中断分配代码会找到适用的中断，使用中断矩阵将其连接到外设，并为其安装给定的中断处理程序和 ISR。

中断分配器提供两种不同的中断类型：共享中断和非共享中断，这两种中断需要不同处理方式。非共享中断在每次调用 `esp_intr_alloc()` 时，都会分配一个单独的中断，该中断仅用于与其相连的外设，只调用一个 ISR。共享中断则可以由多个外设触发，当其中一个外设发出中断信号时，会调用多个 ISR。因此，针对共享中断的 ISR 应检查对应外设的中断状态，以确定是否需要采取任何操作。

非共享中断可由电平或边缘触发。共享中断只能由电平触发，因为使用边缘触发可能会错过中断。

要解释为什么共享中断只能由电平触发，以外设 A 和外设 B 共用一个边缘触发中断为例进行说明：当外设 B 触发中断时，会将其中断信号设置为高电平，产生一个从低到高的边缘，进而锁存 CPU 中断位，并触发 ISR。接着，ISR 开始执行，检查到此时外设 A 没有触发中断，于是继续处理外设 B 的中断信号，最后将外设 B 的中断状态清除。最后，CPU 会在 ISR 返回之前清除中断位锁存器。因此在整个中断处理过程中，如果外设 A 触发了中断，该中断会因 CPU 清除中断位锁存器而丢失。

### IRAM-safe 中断处理程序

`ESP_INTR_FLAG_IRAM` `flag` 注册的中断处理程序始终在 IRAM（并从 DRAM 读取其所有数据）中运行，因此在擦除和写入 flash 时无需禁用。

这对于需要保证最小执行延迟的中断来说非常有用，因为 flash 写入和擦除操作可能很慢（擦除可能需要数十毫秒或数百毫秒才能完成）。

如果中断被频繁调用，可以将中断处理程序保留在 IRAM 中，避免 flash cache 丢失。

有关更多详细信息，请参阅 [SPI flash API 相关文档](#)。

### 多个处理程序共用一个中断源

如果用 `ESP_INTR_FLAG_SHARED` `flag` 分配所有处理程序，可能将多个处理程序分配给同一个源。这些程序会被分配给与源关联的中断，并在源可用时按顺序调用。处理程序可以单独禁用和释放。如果启用了 一个或多个处理程序，则会将源关联到中断（启用），否则会取消关联。禁用的处理程序永远不会被调用，但是只要启用了源的任何一个处理程序，这个源仍然能被触发。

关联到非共享中断的源不支持此功能。

尽管支持此功能，使用时也必须 **非常小心**。通常存在两种办法可以阻止中断触发：**禁用源**或**屏蔽外设中断状态**。ESP-IDF 仅处理源本身的启用和禁用，中断源的状态位和屏蔽位须由用户操作。

**状态位须在负责该位的处理程序禁用前屏蔽，也可以在另一个启用的中断中屏蔽和处理该状态位。**

**备注：**如果不屏蔽状态位而让其处于未处理状态，同时禁用这些状态位的处理程序，就会导致无限次触发中断，引起系统崩溃。

## 排除中断分配故障

CPU 中断在大多数 Espressif SoC 上都是有限的资源。因此，一个运行的程序有可能耗尽 CPU 中断，例如初始化多个外设驱动程序的情况。这通常导致驱动程序的初始化函数返回 ESP\_ERR\_NOT\_FOUND 错误。

这种情况下，可使用 `esp_intr_dump()` 函数打印中断列表及其状态。此函数输出通常如下：

```
CPU 0 interrupt status:
Int  Level  Type   Status
0    1      Level  Reserved
1    1      Level  Reserved
2    1      Level  Used: RTC_CORE
3    1      Level  Used: TGO_LACT_LEVEL
...
```

输出列含义如下：

- **Int:** CPU 中断输入编号。通常不直接在软件中使用，仅作为参考。
- **Level:** 已分配中断的优先级级别。空闲的中断具有标记 \*。
- **Type:** 已分配中断的类型（电平或边缘中断）。空闲的中断具有标记 \*。
- **Status: 中断的可能状态：**
  - **Reserved:** 中断在硬件层面保留，或由 ESP-IDF 的某些部分保留。不能使用 `esp_intr_alloc()` 分配。
  - **Used: <source>:** 中断已分配并连接到单个外设。
  - **Shared: <source1> <source2> ...:** 中断已分配并连接到多个外设。参见本文档 [多个处理程序共用一个中断源](#) 章节。
  - **Free:** 中断未分配，可以由 `esp_intr_alloc()` 使用。

如果已确认应用程序的确用完了中断，可组合采用下列建议解决问题：

- 找到可接受更高延迟的中断，并用 `ESP_INTR_FLAG_SHARED` flag（或与 `ESP_INTR_FLAG_LOWMED` 进行 OR 运算）分配这些中断。对两个或更多外设使用此 flag 能让它们使用单个中断输入，从而为其他外设节约中断输入。参见 [多个处理程序共用一个中断源](#)。
- 检查是否有些外设驱动程序不需要一直启用，并按需将其初始化或取消初始化。这样可以减少同时分配的中断数量。

## API 参考

### Header File

- `components/esp_hw_support/include/esp_intr_types.h`
- This header file can be included with:

```
#include "esp_intr_types.h"
```

## Macros

**ESP\_INTR\_CPU\_AFFINITY\_TO\_CORE\_ID** (cpu\_affinity)

Convert esp\_intr\_cpu\_affinity\_t to CPU core ID.

## Type Definitions

typedef void (\***intr\_handler\_t**)(void \*arg)

Function prototype for interrupt handler function

typedef struct intr\_handle\_data\_t \***intr\_handle\_t**

Handle to an interrupt handler

## Enumerations

enum **esp\_intr\_cpu\_affinity\_t**

Interrupt CPU core affinity.

This type specify the CPU core that the peripheral interrupt is connected to.

*Values:*

enumerator **ESP\_INTR\_CPU\_AFFINITY\_AUTO**

Install the peripheral interrupt to ANY CPU core, decided by on which CPU the interrupt allocator is running.

enumerator **ESP\_INTR\_CPU\_AFFINITY\_0**

Install the peripheral interrupt to CPU core 0.

enumerator **ESP\_INTR\_CPU\_AFFINITY\_1**

Install the peripheral interrupt to CPU core 1.

## Header File

- [components/esp\\_hw\\_support/include/esp\\_intr\\_alloc.h](#)
- This header file can be included with:

```
#include "esp_intr_alloc.h"
```

## Functions

*esp\_err\_t* **esp\_intr\_mark\_shared** (int intno, int cpu, bool is\_in\_iram)

Mark an interrupt as a shared interrupt.

This will mark a certain interrupt on the specified CPU as an interrupt that can be used to hook shared interrupt handlers to.

### 参数

- **intno** -- The number of the interrupt (0-31)
- **cpu** -- CPU on which the interrupt should be marked as shared (0 or 1)
- **is\_in\_iram** -- Shared interrupt is for handlers that reside in IRAM and the int can be left enabled while the flash cache is disabled.

**返回** ESP\_ERR\_INVALID\_ARG if cpu or intno is invalid ESP\_OK otherwise

*esp\_err\_t* **esp\_intr\_reserve** (int intno, int cpu)

Reserve an interrupt to be used outside of this framework.

This will mark a certain interrupt on the specified CPU as reserved, not to be allocated for any reason.

**参数**

- **intno** -- The number of the interrupt (0-31)
- **cpu** -- CPU on which the interrupt should be marked as shared (0 or 1)

**返回** ESP\_ERR\_INVALID\_ARG if cpu or intno is invalid ESP\_OK otherwise

*esp\_err\_t* **esp\_intr\_alloc** (int source, int flags, *intr\_handler\_t* handler, void \*arg, *intr\_handle\_t* \*ret\_handle)

Allocate an interrupt with the given parameters.

This finds an interrupt that matches the restrictions as given in the flags parameter, maps the given interrupt source to it and hooks up the given interrupt handler (with optional argument) as well. If needed, it can return a handle for the interrupt as well.

The interrupt will always be allocated on the core that runs this function.

If ESP\_INTR\_FLAG\_IRAM flag is used, and handler address is not in IRAM or RTC\_FAST\_MEM, then ESP\_ERR\_INVALID\_ARG is returned.

**参数**

- **source** -- The interrupt source. One of the ETS\*\_INTR\_SOURCE interrupt mux sources, as defined in soc/soc.h, or one of the internal ETS\_INTERNAL\*\_INTR\_SOURCE sources as defined in this header.
- **flags** -- An ORred mask of the ESP\_INTR\_FLAG\_\* defines. These restrict the choice of interrupts that this routine can choose from. If this value is 0, it will default to allocating a non-shared interrupt of level 1, 2 or 3. If this is ESP\_INTR\_FLAG\_SHARED, it will allocate a shared interrupt of level 1. Setting ESP\_INTR\_FLAG\_INTRDISABLED will return from this function with the interrupt disabled.
- **handler** -- The interrupt handler. Must be NULL when an interrupt of level >3 is requested, because these types of interrupts aren't C-callable.
- **arg** -- Optional argument for passed to the interrupt handler
- **ret\_handle** -- Pointer to an intr\_handle\_t to store a handle that can later be used to request details or free the interrupt. Can be NULL if no handle is required.

**返回** ESP\_ERR\_INVALID\_ARG if the combination of arguments is invalid.  
ESP\_ERR\_NOT\_FOUND No free interrupt found with the specified flags ESP\_OK otherwise

*esp\_err\_t* **esp\_intr\_alloc\_intrstatus** (int source, int flags, uint32\_t intrstatusreg, uint32\_t intrstatusmask, *intr\_handler\_t* handler, void \*arg, *intr\_handle\_t* \*ret\_handle)

Allocate an interrupt with the given parameters.

This essentially does the same as esp\_intr\_alloc, but allows specifying a register and mask combo. For shared interrupts, the handler is only called if a read from the specified register, ANDed with the mask, returns non-zero. By passing an interrupt status register address and a fitting mask, this can be used to accelerate interrupt handling in the case a shared interrupt is triggered; by checking the interrupt statuses first, the code can decide which ISRs can be skipped

**参数**

- **source** -- The interrupt source. One of the ETS\*\_INTR\_SOURCE interrupt mux sources, as defined in soc/soc.h, or one of the internal ETS\_INTERNAL\*\_INTR\_SOURCE sources as defined in this header.
- **flags** -- An ORred mask of the ESP\_INTR\_FLAG\_\* defines. These restrict the choice of interrupts that this routine can choose from. If this value is 0, it will default to allocating a non-shared interrupt of level 1, 2 or 3. If this is ESP\_INTR\_FLAG\_SHARED, it will allocate a shared interrupt of level 1. Setting ESP\_INTR\_FLAG\_INTRDISABLED will return from this function with the interrupt disabled.
- **intrstatusreg** -- The address of an interrupt status register
- **intrstatusmask** -- A mask. If a read of address intrstatusreg has any of the bits that are 1 in the mask set, the ISR will be called. If not, it will be skipped.
- **handler** -- The interrupt handler. Must be NULL when an interrupt of level >3 is requested, because these types of interrupts aren't C-callable.
- **arg** -- Optional argument for passed to the interrupt handler

- **ret\_handle** -- Pointer to an `intr_handle_t` to store a handle that can later be used to request details or free the interrupt. Can be NULL if no handle is required.
- 返回 ESP\_ERR\_INVALID\_ARG if the combination of arguments is invalid.  
ESP\_ERR\_NOT\_FOUND No free interrupt found with the specified flags ESP\_OK otherwise

*esp\_err\_t* **esp\_intr\_free** (*intr\_handle\_t* handle)

Disable and free an interrupt.

Use an interrupt handle to disable the interrupt and release the resources associated with it. If the current core is not the core that registered this interrupt, this routine will be assigned to the core that allocated this interrupt, blocking and waiting until the resource is successfully released.

---

**备注:** When the handler shares its source with other handlers, the interrupt status bits it's responsible for should be managed properly before freeing it. see `esp_intr_disable` for more details. Please do not call this function in `esp_ipc_call_blocking`.

---

- 参数 **handle** -- The handle, as obtained by `esp_intr_alloc` or `esp_intr_alloc_intrstatus`  
返回 ESP\_ERR\_INVALID\_ARG the handle is NULL ESP\_FAIL failed to release this handle  
ESP\_OK otherwise

int **esp\_intr\_get\_cpu** (*intr\_handle\_t* handle)

Get CPU number an interrupt is tied to.

- 参数 **handle** -- The handle, as obtained by `esp_intr_alloc` or `esp_intr_alloc_intrstatus`  
返回 The core number where the interrupt is allocated

int **esp\_intr\_get\_intno** (*intr\_handle\_t* handle)

Get the allocated interrupt for a certain handle.

- 参数 **handle** -- The handle, as obtained by `esp_intr_alloc` or `esp_intr_alloc_intrstatus`  
返回 The interrupt number

*esp\_err\_t* **esp\_intr\_disable** (*intr\_handle\_t* handle)

Disable the interrupt associated with the handle.

---

**备注:**

- For local interrupts (ESP\_INTERNAL\_\* sources), this function has to be called on the CPU the interrupt is allocated on. Other interrupts have no such restriction.
  - When several handlers sharing a same interrupt source, interrupt status bits, which are handled in the handler to be disabled, should be masked before the disabling, or handled in other enabled interrupts properly. Miss of interrupt status handling will cause infinite interrupt calls and finally system crash.
- 

- 参数 **handle** -- The handle, as obtained by `esp_intr_alloc` or `esp_intr_alloc_intrstatus`  
返回 ESP\_ERR\_INVALID\_ARG if the combination of arguments is invalid. ESP\_OK otherwise

*esp\_err\_t* **esp\_intr\_enable** (*intr\_handle\_t* handle)

Enable the interrupt associated with the handle.

---

**备注:** For local interrupts (ESP\_INTERNAL\_\* sources), this function has to be called on the CPU the interrupt is allocated on. Other interrupts have no such restriction.

---

- 参数 **handle** -- The handle, as obtained by `esp_intr_alloc` or `esp_intr_alloc_intrstatus`  
返回 ESP\_ERR\_INVALID\_ARG if the combination of arguments is invalid. ESP\_OK otherwise

*esp\_err\_t* **esp\_intr\_set\_in\_iram** (*intr\_handle\_t* handle, bool is\_in\_iram)

Set the "in IRAM" status of the handler.

---

**备注:** Does not work on shared interrupts.

---

#### 参数

- **handle** -- The handle, as obtained by `esp_intr_alloc` or `esp_intr_alloc_intrstatus`
- **is\_in\_iram** -- Whether the handler associated with this handle resides in IRAM. Handlers residing in IRAM can be called when cache is disabled.

**返回** `ESP_ERR_INVALID_ARG` if the combination of arguments is invalid. `ESP_OK` otherwise

void **esp\_intr\_noniram\_disable** (void)

Disable interrupts that aren't specifically marked as running from IRAM.

void **esp\_intr\_noniram\_enable** (void)

Re-enable interrupts disabled by `esp_intr_noniram_disable`.

void **esp\_intr\_enable\_source** (int inum)

enable the interrupt source based on its number

**参数 inum** -- interrupt number from 0 to 31

void **esp\_intr\_disable\_source** (int inum)

disable the interrupt source based on its number

**参数 inum** -- interrupt number from 0 to 31

static inline int **esp\_intr\_flags\_to\_level** (int flags)

Get the lowest interrupt level from the flags.

**参数 flags** -- The same flags that pass to `esp_intr_alloc_intrstatus` API

static inline int **esp\_intr\_level\_to\_flags** (int level)

Get the interrupt flags from the supplied level (priority)

**参数 level** -- The interrupt priority level

*esp\_err\_t* **esp\_intr\_dump** (FILE \*stream)

Dump the status of allocated interrupts.

**参数 stream** -- The stream to dump to, if NULL then stdout is used

**返回** `ESP_OK` on success

## Macros

**ESP\_INTR\_FLAG\_LEVEL1**

Interrupt allocation flags.

These flags can be used to specify which interrupt qualities the code calling `esp_intr_alloc*` needs. Accept a Level 1 interrupt vector (lowest priority)

**ESP\_INTR\_FLAG\_LEVEL2**

Accept a Level 2 interrupt vector.

**ESP\_INTR\_FLAG\_LEVEL3**

Accept a Level 3 interrupt vector.

**ESP\_INTR\_FLAG\_LEVEL4**

Accept a Level 4 interrupt vector.



**ESP\_INTR\_FLAG\_LEVEL5**

Accept a Level 5 interrupt vector.

**ESP\_INTR\_FLAG\_LEVEL6**

Accept a Level 6 interrupt vector.

**ESP\_INTR\_FLAG\_NMI**

Accept a Level 7 interrupt vector (highest priority)

**ESP\_INTR\_FLAG\_SHARED**

Interrupt can be shared between ISRs.

**ESP\_INTR\_FLAG\_EDGE**

Edge-triggered interrupt.

**ESP\_INTR\_FLAG\_IRAM**

ISR can be called if cache is disabled.

**ESP\_INTR\_FLAG\_INTRDISABLED**

Return with this interrupt disabled.

**ESP\_INTR\_FLAG\_LOWMED**

Low and medium prio interrupts. These can be handled in C.

**ESP\_INTR\_FLAG\_HIGH**

High level interrupts. Need to be handled in assembly.

**ESP\_INTR\_FLAG\_LEVELMASK**

Mask for all level flags

**ETS\_INTERNAL\_TIMER0\_INTR\_SOURCE**

Platform timer 0 interrupt source.

The `esp_intr_alloc*` functions can allocate an int for all `ETS_*_INTR_SOURCE` interrupt sources that are routed through the interrupt mux. Apart from these sources, each core also has some internal sources that do not pass through the interrupt mux. To allocate an interrupt for these sources, pass these pseudo-sources to the functions.

**ETS\_INTERNAL\_TIMER1\_INTR\_SOURCE**

Platform timer 1 interrupt source.

**ETS\_INTERNAL\_TIMER2\_INTR\_SOURCE**

Platform timer 2 interrupt source.

**ETS\_INTERNAL\_SW0\_INTR\_SOURCE**

Software int source 1.

**ETS\_INTERNAL\_SW1\_INTR\_SOURCE**

Software int source 2.



**ETS\_INTERNAL\_PROFILING\_INTR\_SOURCE**

Int source for profiling.

**ETS\_INTERNAL\_UNUSED\_INTR\_SOURCE**

Interrupt is not assigned to any source.

**ETS\_INTERNAL\_INTR\_SOURCE\_OFF**

Provides SystemView with positive IRQ IDs, otherwise scheduler events are not shown properly

**ESP\_INTR\_ENABLE** (inum)

Enable interrupt by interrupt number

**ESP\_INTR\_DISABLE** (inum)

Disable interrupt by interrupt number

## 2.10.20 日志库

### 概述

日志库提供了三种设置日志级别的方式：

- **编译时**：在 `menuconfig` 中，使用选项 `CONFIG_LOG_DEFAULT_LEVEL` 来设置日志级别。
- 另外，还可以选择在 `menuconfig` 中使用选项 `CONFIG_LOG_MAXIMUM_LEVEL` 设置最高日志级别。这个选项默认被配置为默认级别，但这个选项也可以被配置为更高级别，将更多的可选日志编译到固件中。
- **运行时**：默认启用所有级别低于 `CONFIG_LOG_DEFAULT_LEVEL` 的日志。`esp_log_level_set()` 函数可以为各个模块分别设置不同的日志级别，可通过人类可读的 ASCII 零终止字符串标签来识别不同的模块。
- **运行时**：启用 `CONFIG_LOG_MASTER_LEVEL` 时，可以使用 `esp_log_set_level_master()` 函数设置主日志级别 (Master logging level)。该选项会为所有已编译的日志添加额外的日志级别检查。注意，使用此选项会增加应用程序大小。如果希望在运行时编译大量可选日志，同时避免在不需要日志输出时查找标签及其级别带来的性能损耗，此功能会非常有用。

以下是不同的日志级别：

- 错误 (Error, 最低级别)
- 警告 (Warning)
- 普通 (Info)
- 调试 (Debug)
- 冗余 (Verbose, 最高级别)

---

**备注：**注意，函数 `esp_log_level_set()` 无法将日志级别设置为高于 `CONFIG_LOG_MAXIMUM_LEVEL` 指定的级别。如需在编译时将特定文件的日志级别提高到此最高级别以上，请使用 `LOG_LOCAL_LEVEL` 宏 (详细信息见下文)。

---

### 如何使用日志库

在使用日志功能的所有 C 文件中，将 TAG 变量定义如下：

```
static const char* TAG = "MyModule";
```

然后使用一个日志宏进行输出，例如：

```
ESP_LOGW(TAG, "Baud rate error %.1f%%. Requested: %d baud, actual: %d baud", error_
↳ * 100, baud_req, baud_real);
```

可使用下列宏来定义不同的日志级别：

- ESP\_LOGE - 错误（最低级别）
- ESP\_LOGW - 警告
- ESP\_LOGI - 普通
- ESP\_LOGD - 调试
- ESP\_LOGV - 冗余（最高级别）

此外，上述宏还有对应的 ESP\_EARLY\_LOGx 版本，如 *ESP\_EARLY\_LOGE*。这些版本的宏必须在堆分配器和系统调用初始化之前，在早期启动代码中显式使用。通常情况下，编译引导加载程序时也可以使用普通的 ESP\_LOGx 宏，但其最终实现与 ESP\_EARLY\_LOGx 宏相同。

上述宏还有对应的 ESP\_DRAM\_LOGx 版本，如 *ESP\_DRAM\_LOGE*。在禁用中断或无法访问 flash cache 的情况下需要输出日志时，可以使用这些版本的宏。但是，应尽量避免使用这些宏版本，因为在上述情况下输出日志可能会影响性能。

**备注：**在关键部分中断被禁用，因此只能使用 ESP\_DRAM\_LOGx（首选）或 ESP\_EARLY\_LOGx 宏。尽管这样可以输出日志，但最好可以调整程序使其不用输出日志。

如需在文件或组件范围内覆盖默认的日志级别，请定义 LOG\_LOCAL\_LEVEL 宏。

在文件中，该宏应在包含 esp\_log.h 文件前进行定义，例如：

```
#define LOG_LOCAL_LEVEL ESP_LOG_VERBOSE
#include "esp_log.h"
```

在组件中，该宏应在组件的 CMakeList 中进行定义：

```
target_compile_definitions(${COMPONENT_LIB} PUBLIC "-DLOG_LOCAL_LEVEL=ESP_LOG_
↳ VERBOSE")
```

如需在运行时按模块配置日志输出，请按如下方式调用 *esp\_log\_level\_set()* 函数：

```
esp_log_level_set("", ESP_LOG_ERROR);           // 将所有组件的日志级别设置为错误_
↳ (ERROR) 级别
esp_log_level_set("wifi", ESP_LOG_WARN);       // 启用来自 WiFi 堆栈的警告 (WARN)_
↳ 日志
esp_log_level_set("dhcpc", ESP_LOG_INFO);      // 启用来自 DHCP 客户端的普通 (INFO)_
↳ 日志
```

**备注：**上文介绍的“DRAM”和“EARLY”日志宏变型不支持按照模块设置日志级别。这些宏始终以“默认”级别记录日志，且只能在运行时调用 *esp\_log\_level("", level)* 对日志级别进行更改。

即使已通过标签名称禁用日志输出，每个条目仍需约 10.9 微秒的处理时间。

**主日志级别** 要启用主日志级别功能，须启用 *CONFIG\_LOG\_MASTER\_LEVEL* 选项。该功能在调用 *esp\_log\_write()* 之前为 ESP\_LOGx 宏添加了额外的级别检查。这样就可以设置更高的 *CONFIG\_LOG\_MAXIMUM\_LEVEL*，并且不会在正常操作期间对性能造成影响（仅在指示时）。应用程序可以全局设置主日志级别 (*esp\_log\_set\_level\_master()*) 以强制执行最高日志级别。高于此级别的 ESP\_LOGx 宏将直接跳过，不会调用 *esp\_log\_write()* 并进行标签查找。建议只在顶层应用程序中使用此功能，不要在共享组件中使用，因为这将覆盖所有使用该组件的用户的全局日志级别。默认情况下，启动时主日志级别是 *CONFIG\_LOG\_DEFAULT\_LEVEL*。

注意，由于此功能为所有 ESP\_LOGx 宏添加了额外的检查，会导致应用程序的大小增加。

以下代码片段展示了主日志级别的运行方式。将主日志级别设置为 `ESP_LOG_NONE` 将在全局范围内禁用所有日志记录。`esp_log_level_set()` 目前不会影响日志记录。但在主日志级别释放后，日志将按照 `esp_log_level_set()` 中的设置打印输出。

```
// 在启动时，主日志级别为 CONFIG_LOG_DEFAULT_LEVEL，并等于 ESP_LOG_INFO
ESP_LOGI("lib_name", "用于打印的消息");           // 打印普通 (INFO) 级别消息
esp_log_level_set("lib_name", ESP_LOG_WARN);       // 启用 lib_name 的警告 (WARN)
↳ 日志

esp_log_set_level_master(ESP_LOG_NONE);           // 全局禁用所有日志。esp_log_
↳ level_set 目前没有生效

ESP_LOGW("lib_name", "用于打印的消息");           // 主日志级别阻止了打印
esp_log_level_set("lib_name", ESP_LOG_INFO);       // 启用 lib_name 的 INFO 日志
ESP_LOGI("lib_name", "用于打印的消息");           // 主日志级别阻止了打印

esp_log_set_level_master(ESP_LOG_INFO);           // 全局启用所有 INFO 日志

ESP_LOGI("lib_name", "用于打印的消息");           // 打印一条 INFO 消息
```

**通过 JTAG 将日志记录到主机** 默认情况下，日志库使用类似 `vprintf` 的函数将格式化输出写入专用 UART。通过调用一个简单的 API，即可将所有日志通过 JTAG 输出，将日志输出速度提高数倍。如需了解详情，请参阅[记录日志到主机](#)。

**线程安全** 日志字符串首先被写入内存 `buffer`，然后发送到 UART 打印。日志调用是线程安全的，即不同线程的日志不会互相冲突。

## 应用示例

大多数 ESP-IDF 组件和示例都会使用日志库。如需查看有关日志功能的应用示例，请前往 ESP-IDF 的 `examples` 目录。与日志最相关的示例如下：

- [system/ota](#)
- [storage/sd\\_card](#)
- [protocols/https\\_request](#)

## API 参考

### Header File

- [components/log/include/esp\\_log.h](#)
- This header file can be included with:

```
#include "esp_log.h"
```

### Functions

void **esp\_log\_set\_level\_master** (*esp\_log\_level\_t* level)

Master log level.

Optional master log level to check against for `ESP_LOGx` macros before calling `esp_log_write`. Allows one to set a higher `CONFIG_LOG_MAXIMUM_LEVEL` but not impose a performance hit during normal operation (only when instructed). An application may set `esp_log_set_level_master(level)` to globally enforce a maximum log level. `ESP_LOGx` macros above this level will be skipped immediately, rather than calling `esp_log_write` and doing a cache hit.

The tradeoff is increased application size.

**参数 level** -- Master log level

*esp\_log\_level\_t* **esp\_log\_get\_level\_master** (void)

Returns master log level.

返回 Master log level

void **esp\_log\_level\_set** (const char \*tag, *esp\_log\_level\_t* level)

Set log level for given tag.

If logging for given component has already been enabled, changes previous setting.

---

**备注:** Note that this function can not raise log level above the level set using CONFIG\_LOG\_MAXIMUM\_LEVEL setting in menuconfig. To raise log level above the default one for a given file, define LOG\_LOCAL\_LEVEL to one of the ESP\_LOG\_\* values, before including esp\_log.h in this file.

---

#### 参数

- **tag** -- Tag of the log entries to enable. Must be a non-NULL zero terminated string. Value "\*" resets log level for all tags to the given value.
- **level** -- Selects log level to enable. Only logs at this and lower verbosity levels will be shown.

*esp\_log\_level\_t* **esp\_log\_level\_get** (const char \*tag)

Get log level for a given tag, can be used to avoid expensive log statements.

参数 **tag** -- Tag of the log to query current level. Must be a non-NULL zero terminated string.

返回 The current log level for the given tag

*vprintf\_like\_t* **esp\_log\_set\_vprintf** (*vprintf\_like\_t* func)

Set function used to output log entries.

By default, log output goes to UART0. This function can be used to redirect log output to some other destination, such as file or network. Returns the original log handler, which may be necessary to return output to the previous destination.

---

**备注:** Please note that function callback here must be re-entrant as it can be invoked in parallel from multiple thread context.

---

参数 **func** -- new Function used for output. Must have same signature as vprintf.

返回 func old Function used for output.

uint32\_t **esp\_log\_timestamp** (void)

Function which returns timestamp to be used in log output.

This function is used in expansion of ESP\_LOGx macros. In the 2nd stage bootloader, and at early application startup stage this function uses CPU cycle counter as time source. Later when FreeRTOS scheduler start running, it switches to FreeRTOS tick count.

For now, we ignore millisecond counter overflow.

返回 timestamp, in milliseconds

char \***esp\_log\_system\_timestamp** (void)

Function which returns system timestamp to be used in log output.

This function is used in expansion of ESP\_LOGx macros to print the system time as "HH:MM:SS.sss". The system time is initialized to 0 on startup, this can be set to the correct time with an SNTP sync, or manually with standard POSIX time functions.

Currently, this will not get used in logging from binary blobs (i.e. Wi-Fi & Bluetooth libraries), these will still print the RTOS tick time.

返回 timestamp, in "HH:MM:SS.sss"

uint32\_t **esp\_log\_early\_timestamp** (void)

Function which returns timestamp to be used in log output.

This function uses HW cycle counter and does not depend on OS, so it can be safely used after application crash.

返回 timestamp, in milliseconds

void **esp\_log\_write** (*esp\_log\_level\_t* level, const char \*tag, const char \*format, ...)

Write message into the log.

This function is not intended to be used directly. Instead, use one of ESP\_LOGE, ESP\_LOGW, ESP\_LOGI, ESP\_LOGD, ESP\_LOGV macros.

This function or these macros should not be used from an interrupt.

void **esp\_log\_writew** (*esp\_log\_level\_t* level, const char \*tag, const char \*format, va\_list args)

Write message into the log, va\_list variant.

This function is provided to ease integration toward other logging framework, so that esp\_log can be used as a log sink.

参见:

esp\_log\_write()

## Macros

**ESP\_LOG\_BUFFER\_HEX\_LEVEL** (tag, buffer, buff\_len, level)

Log a buffer of hex bytes at specified level, separated into 16 bytes each line.

参数

- **tag** -- description tag
- **buffer** -- Pointer to the buffer array
- **buff\_len** -- length of buffer in bytes
- **level** -- level of the log

**ESP\_LOG\_BUFFER\_CHAR\_LEVEL** (tag, buffer, buff\_len, level)

Log a buffer of characters at specified level, separated into 16 bytes each line. Buffer should contain only printable characters.

参数

- **tag** -- description tag
- **buffer** -- Pointer to the buffer array
- **buff\_len** -- length of buffer in bytes
- **level** -- level of the log

**ESP\_LOG\_BUFFER\_HEXDUMP** (tag, buffer, buff\_len, level)

Dump a buffer to the log at specified level.

The dump log shows just like the one below:

```

W (195) log_example: 0x3ffb4280  45 53 50 33 32 20 69 73  20 67 72 65 61 74
↪2c 20 |ESP32 is great, |
W (195) log_example: 0x3ffb4290  77 6f 72 6b 69 6e 67 20  61 6c 6f 6e 67 20
↪77 69 |working along wi|
W (205) log_example: 0x3ffb42a0  74 68 20 74 68 65 20 49  44 46 2e 00
↪      |th the IDF..|

```

It is highly recommended to use terminals with over 102 text width.

参数

- **tag** -- description tag

- **buffer** -- Pointer to the buffer array
- **buff\_len** -- length of buffer in bytes
- **level** -- level of the log

**ESP\_LOG\_BUFFER\_HEX** (tag, buffer, buff\_len)

Log a buffer of hex bytes at Info level.

参见:

`esp_log_buffer_hex_level`

参数

- **tag** -- description tag
- **buffer** -- Pointer to the buffer array
- **buff\_len** -- length of buffer in bytes

**ESP\_LOG\_BUFFER\_CHAR** (tag, buffer, buff\_len)

Log a buffer of characters at Info level. Buffer should contain only printable characters.

参见:

`esp_log_buffer_char_level`

参数

- **tag** -- description tag
- **buffer** -- Pointer to the buffer array
- **buff\_len** -- length of buffer in bytes

**ESP\_EARLY\_LOGE** (tag, format, ...)

macro to output logs in startup code, before heap allocator and syscalls have been initialized. Log at `ESP_LOG_ERROR` level.

参见:

`printf,ESP_LOGE,ESP_DRAM_LOGE` In the future, we want to become compatible with clang. Hence, we provide two versions of the following macros which are using variadic arguments. The first one is using the GNU extension `##_VA_ARGS_`. The second one is using the C++20 feature `VA_OPT(,)`. This allows users to compile their code with standard C++20 enabled instead of the GNU extension. Below C++20, we haven't found any good alternative to using `##_VA_ARGS_`.

**ESP\_EARLY\_LOGW** (tag, format, ...)

macro to output logs in startup code at `ESP_LOG_WARN` level.

参见:

`ESP_EARLY_LOGE,ESP_LOGE,printf`

**ESP\_EARLY\_LOGI** (tag, format, ...)

macro to output logs in startup code at `ESP_LOG_INFO` level.

参见:

`ESP_EARLY_LOGE,ESP_LOGE,printf`

**ESP\_EARLY\_LOGD** (tag, format, ...)

macro to output logs in startup code at ESP\_LOG\_DEBUG level.

参见:

ESP\_EARLY\_LOGE, ESP\_LOGE, printf

**ESP\_EARLY\_LOGV** (tag, format, ...)

macro to output logs in startup code at ESP\_LOG\_VERBOSE level.

参见:

ESP\_EARLY\_LOGE, ESP\_LOGE, printf

**\_ESP\_LOG\_EARLY\_ENABLED** (log\_level)

**ESP\_LOG\_EARLY\_IMPL** (tag, format, log\_level, log\_tag\_letter, ...)

**ESP\_LOGE** (tag, format, ...)

**ESP\_LOGW** (tag, format, ...)

**ESP\_LOGI** (tag, format, ...)

**ESP\_LOGD** (tag, format, ...)

**ESP\_LOGV** (tag, format, ...)

**ESP\_LOG\_LEVEL** (level, tag, format, ...)

runtime macro to output logs at a specified level.

参见:

printf

参数

- **tag** -- tag of the log, which can be used to change the log level by `esp_log_level_set` at runtime.
- **level** -- level of the output log.
- **format** -- format of the output log. See `printf`
- ... -- variables to be replaced into the log. See `printf`

**ESP\_LOG\_LEVEL\_LOCAL** (level, tag, format, ...)

runtime macro to output logs at a specified level. Also check the level with `LOG_LOCAL_LEVEL`. If `CONFIG_LOG_MASTER_LEVEL` set, also check first against `esp_log_get_level_master()`.

参见:

printf, ESP\_LOG\_LEVEL

**ESP\_DRAM\_LOGE** (tag, format, ...)

Macro to output logs when the cache is disabled. Log at ESP\_LOG\_ERROR level.

Similar to

Usage: `ESP_DRAM_LOGE(DRAM_STR("my_tag"), "format", or ESP_DRAM_LOGE(TAG, "format", ...)`, where TAG is a `char*` that points to a str in the DRAM.

**参见:**

ESP\_EARLY\_LOGE, the log level cannot be changed per-tag, however `esp_log_level_set("**", level)` will set the default level which controls these log lines also.

**参见:**

`esp_rom_printf`, `ESP_LOGE`

---

**备注:** Unlike normal logging macros, it's possible to use this macro when interrupts are disabled or inside an ISR.

---

---

**备注:** Placing log strings in DRAM reduces available DRAM, so only use when absolutely essential.

---

**ESP\_DRAM\_LOGW** (tag, format, ...)

macro to output logs when the cache is disabled at `ESP_LOG_WARN` level.

**参见:**

`ESP_DRAM_LOGW`, `ESP_LOGW`, `esp_rom_printf`

**ESP\_DRAM\_LOGI** (tag, format, ...)

macro to output logs when the cache is disabled at `ESP_LOG_INFO` level.

**参见:**

`ESP_DRAM_LOGI`, `ESP_LOGI`, `esp_rom_printf`

**ESP\_DRAM\_LOGD** (tag, format, ...)

macro to output logs when the cache is disabled at `ESP_LOG_DEBUG` level.

**参见:**

`ESP_DRAM_LOGD`, `ESP_LOGD`, `esp_rom_printf`

**ESP\_DRAM\_LOGV** (tag, format, ...)

macro to output logs when the cache is disabled at `ESP_LOG_VERBOSE` level.

**参见:**

`ESP_DRAM_LOGV`, `ESP_LOGV`, `esp_rom_printf`

## Type Definitions

typedef int (**\*vprintf\_like\_t**)(const char\*, va\_list)

## Enumerations

enum **esp\_log\_level\_t**

Log level.

*Values:*



enumerator **ESP\_LOG\_NONE**

No log output

enumerator **ESP\_LOG\_ERROR**

Critical errors, software module can not recover on its own

enumerator **ESP\_LOG\_WARN**

Error conditions from which recovery measures have been taken

enumerator **ESP\_LOG\_INFO**

Information messages which describe normal flow of events

enumerator **ESP\_LOG\_DEBUG**

Extra information which is not necessary for normal use (values, pointers, sizes, etc).

enumerator **ESP\_LOG\_VERBOSE**

Bigger chunks of debugging information, or frequent messages which can potentially flood the output.

## 2.10.21 杂项系统 API

### 软件复位

函数 `esp_restart()` 用于执行芯片的软件复位。调用此函数时，程序停止执行，CPU 复位，应用程序由 bootloader 加载并重启。

函数 `esp_register_shutdown_handler()` 用于注册复位前会自动调用的例程（复位过程由 `esp_restart()` 函数触发），这与 `atexit` POSIX 函数的功能类似。

### 复位原因

ESP-IDF 应用程序启动或复位的原因有多种。调用 `esp_reset_reason()` 函数可获取最近一次复位的原因。复位的所有可能原因，请查看 `esp_reset_reason_t` 中的描述。

### 堆内存

ESP-IDF 中有两个与堆内存相关的函数：

- 函数 `esp_get_free_heap_size()` 用于查询当前可用的堆内存大小。
- 函数 `esp_get_minimum_free_heap_size()` 用于查询整个过程中可用的最小堆内存大小（例如应用程序生命周期内可用的最小堆内存大小）。

请注意，ESP-IDF 支持功能不同的多个堆。上文中函数返回的堆内存大小可使用 `malloc` 函数族来进行分配。有关堆内存的更多信息，请参阅[堆内存分配](#)。

### MAC 地址

以下 API 用于查询和自定义支持的网络接口（如 Wi-Fi、蓝牙、以太网）的 MAC 地址。

要获取特定接口（如 Wi-Fi、蓝牙、以太网）的 MAC 地址，请调用函数 `esp_read_mac()`。

在 ESP-IDF 中，各个网络接口的 MAC 地址是根据单个 **基准 MAC 地址 (Base MAC address)** 计算出来的。默认情况下使用乐鑫指定的基准 MAC 地址，该基准地址在产品生产过程中已预烧录至 ESP32-H2 eFuse。

接口	MAC 地址 (默认 4 个全局地址)	MAC 地址 (2 个全局地址)
Wi-Fi Station	base_mac	base_mac
Wi-Fi SoftAP	base_mac 最后一组字节后加 1	本地 MAC (由 Wi-Fi Station MAC 生成)
蓝牙	base_mac 最后一组字节后加 2	base_mac 最后一组字节后加 1
以太网	base_mac 最后一组字节后加 3	本地 MAC (由蓝牙 MAC 生成)

**备注：** [配置选项](#) 配置了乐鑫提供的全局 MAC 地址的数量。

**备注：** ESP32-H2 内部未集成以太网 MAC 地址，但仍可以计算得出该地址。不过，以太网 MAC 地址只能与外部以太网接口（如 SPI 以太网设备）一起使用，具体请参阅[以太网](#)。

**自定义接口 MAC** 有时用户可能需要自定义 MAC 地址，这些地址并不由基准 MAC 地址生成。如需设置自定义接口 MAC 地址，请使用 `esp_iface_mac_addr_set()` 函数。该函数用于覆盖由基准 MAC 地址设置（或尚未设置）的接口 MAC 地址。一旦设置某个接口 MAC 地址，即使更改基准 MAC 地址，也不会对其产生影响。

**自定义基准 MAC** 乐鑫已将默认的基准 MAC 地址预烧录至 eFuse BLK1 中。如需设置自定义基准 MAC 地址，请在初始化任一网络接口或调用 `esp_read_mac()` 函数前调用 `esp_base_mac_addr_set()` 函数。自定义基准 MAC 地址可以存储在任何支持的存储设备中（例如 flash、NVS）。

分配自定义基准 MAC 地址时，应避免 MAC 地址重叠。请根据上面的表格配置选项 `CONFIG_ESP32H2_UNIVERSAL_MAC_ADDRESSES`，设置可从自定义基准 MAC 地址生成的有效全局 MAC 地址。

**备注：** 也可以调用函数 `esp_netif_set_mac()`，在网络初始化后设置网络接口使用的特定 MAC。但建议使用此处介绍的自定义基准 MAC 地址的方法，以避免原始 MAC 地址在更改前短暂出现在网络上。

**eFuse 中的自定义 MAC 地址** ESP-IDF 提供了 `esp_efuse_mac_get_custom()` 函数，从 eFuse 读取自定义 MAC 地址时，调用该函数将从 eFuse BLK3 加载 MAC 地址。用户也可以调用 `esp_read_mac()` 函数，此时需使用 `ESP_MAC_EFUSE_CUSTOM` 参数。`esp_efuse_mac_get_custom()` 函数假定自定义基准 MAC 地址的存储格式如下：

字段	比特数	比特范围
MAC address	48	200:248

**备注：** eFuse BLK3 在烧写时使用 RS 编码，这意味着必须同时烧写该块中的所有 eFuse 字段。

调用 `esp_efuse_mac_get_custom()` 或 `esp_read_mac()` 函数获得自定义 eFuse MAC 地址后，请将此 MAC 地址设置为基准 MAC 地址。有以下两种方法：

1. 使用原有 API：调用 `esp_base_mac_addr_set()`。
2. 使用新 API：调用 `esp_iface_mac_addr_set()`，此时需使用 `ESP_MAC_BASE` 参数。

**本地 MAC 地址和全局 MAC 地址** 在 ESP32-H2 中，乐鑫已预烧录足够数量的有效乐鑫全局 MAC 地址，供所有内部接口使用。上文中的表格已经介绍了如何根据基准 MAC 地址计算出具体接口的 MAC 地址。

当使用自定义 MAC 地址时，可能并非所有接口都能被分配到一个全局 MAC 地址。此时，接口会被分配一个本地 MAC 地址。请注意，这些地址仅用于单个本地网络。

本地 MAC 地址和全局 MAC 地址的定义，请参见 [此处](#)。

内部调用函数 `esp_derive_local_mac()`，可从全局 MAC 地址生成本地 MAC 地址。具体流程如下：

1. 在全局 MAC 地址的第一个字节组中设置 U/L 位（位值为 0x2），创建本地 MAC 地址。
2. 如果该位已存在于全局 MAC 地址中（即现有的“全局”MAC 地址实际上已经是本地 MAC 地址），则本地 MAC 地址的第一个字节组与 0x4 异或。

## 芯片版本

`esp_chip_info()` 函数用于填充 `esp_chip_info_t` 结构体中的芯片信息，包括芯片版本、CPU 数量和芯片中已启用功能的位掩码。

## SDK 版本

调用函数 `esp_get_idf_version()` 可返回一个字符串，该字符串包含了用于编译应用程序的 ESP-IDF 版本，与构建系统中通过 `IDF_VER` 变量所获得的值相同。该版本字符串的格式即 `git describe` 命令的运行结果。

也有其它的版本宏可用于在构建过程中获取 ESP-IDF 版本，它们可根据 ESP-IDF 版本启用或禁用部分程序。

- `ESP_IDF_VERSION_MAJOR`、`ESP_IDF_VERSION_MINOR` 和 `ESP_IDF_VERSION_PATCH` 分别被定义为代表主要版本、次要版本和补丁版本的整数。
- `ESP_IDF_VERSION_VAL` 和 `ESP_IDF_VERSION` 可在确认版本时使用：

```
#include "esp_idf_version.h"

#if ESP_IDF_VERSION >= ESP_IDF_VERSION_VAL(4, 0, 0)
    // 启用 ESP-IDF v4.0 中的功能
#endif
```

## 应用程序版本

应用程序版本存储在 `esp_app_desc_t` 结构体中。该结构体位于 DROM 扇区，有一个从二进制文件头部计算的固定偏移值。该结构体位于 `esp_image_header_t` 和 `esp_image_segment_header_t` 结构体之后。字段 `Version` 类型为字符串，最大长度为 32 字节。

若需手动设置版本，需要在项目的 `CMakeLists.txt` 文件中设置 `PROJECT_VER` 变量，即在 `CMakeLists.txt` 文件中，在包含 `project.cmake` 之前添加 `set(PROJECT_VER "0.1.0.1")`。

如果设置了 `CONFIG_APP_PROJECT_VER_FROM_CONFIG` 选项，则将使用 `CONFIG_APP_PROJECT_VER` 的值。否则，如果在项目中未设置 `PROJECT_VER` 变量，则该变量将从 `$(PROJECT_PATH)/version.txt` 文件（若有）中检索，或使用 `git` 命令 `git describe` 检索。如果两者都不可用，则 `PROJECT_VER` 将被设置为“1”。应用程序可通过调用 `esp_app_get_description()` 或 `esp_ota_get_partition_description()` 函数来获取应用程序的版本信息。

## API 参考

### Header File

- `components/esp_system/include/esp_system.h`
- This header file can be included with:

```
#include "esp_system.h"
```

## Functions

`esp_err_t esp_register_shutdown_handler` (*shutdown\_handler\_t* handle)

Register shutdown handler.

This function allows you to register a handler that gets invoked before the application is restarted using `esp_restart` function.

**参数** `handle` -- function to execute on restart

**返回**

- ESP\_OK on success
- ESP\_ERR\_INVALID\_STATE if the handler has already been registered
- ESP\_ERR\_NO\_MEM if no more shutdown handler slots are available

`esp_err_t esp_unregister_shutdown_handler` (*shutdown\_handler\_t* handle)

Unregister shutdown handler.

This function allows you to unregister a handler which was previously registered using `esp_register_shutdown_handler` function.

- ESP\_OK on success
- ESP\_ERR\_INVALID\_STATE if the given handler hasn't been registered before

void `esp_restart` (void)

Restart PRO and APP CPUs.

This function can be called both from PRO and APP CPUs. After successful restart, CPU reset reason will be SW\_CPU\_RESET. Peripherals (except for Wi-Fi, BT, UART0, SPI1, and legacy timers) are not reset. This function does not return.

`esp_reset_reason_t esp_reset_reason` (void)

Get reason of last reset.

**返回** See description of `esp_reset_reason_t` for explanation of each value.

uint32\_t `esp_get_free_heap_size` (void)

Get the size of available heap.

---

**备注:** Note that the returned value may be larger than the maximum contiguous block which can be allocated.

---

**返回** Available heap size, in bytes.

uint32\_t `esp_get_free_internal_heap_size` (void)

Get the size of available internal heap.

---

**备注:** Note that the returned value may be larger than the maximum contiguous block which can be allocated.

---

**返回** Available internal heap size, in bytes.

uint32\_t `esp_get_minimum_free_heap_size` (void)

Get the minimum heap that has ever been available.

**返回** Minimum free heap ever available

void `esp_system_abort` (const char \*details)

Trigger a software abort.

**参数** `details` -- Details that will be displayed during panic handling.

## Type Definitions

typedef void (\***shutdown\_handler\_t**)(void)

Shutdown handler type

## Enumerations

enum **esp\_reset\_reason\_t**

Reset reasons.

*Values:*

enumerator **ESP\_RST\_UNKNOWN**

Reset reason can not be determined.

enumerator **ESP\_RST\_POWERON**

Reset due to power-on event.

enumerator **ESP\_RST\_EXT**

Reset by external pin (not applicable for ESP32)

enumerator **ESP\_RST\_SW**

Software reset via esp\_restart.

enumerator **ESP\_RST\_PANIC**

Software reset due to exception/panic.

enumerator **ESP\_RST\_INT\_WDT**

Reset (software or hardware) due to interrupt watchdog.

enumerator **ESP\_RST\_TASK\_WDT**

Reset due to task watchdog.

enumerator **ESP\_RST\_WDT**

Reset due to other watchdogs.

enumerator **ESP\_RST\_DEEPSLEEP**

Reset after exiting deep sleep mode.

enumerator **ESP\_RST\_BROWNOUT**

Brownout reset (software or hardware)

enumerator **ESP\_RST\_SDIO**

Reset over SDIO.

enumerator **ESP\_RST\_USB**

Reset by USB peripheral.

enumerator **ESP\_RST\_JTAG**

Reset by JTAG.

enumerator **ESP\_RST\_EFUSE**

Reset due to efuse error.

enumerator **ESP\_RST\_PWR\_GLITCH**

Reset due to power glitch detected.

enumerator **ESP\_RST\_CPU\_LOCKUP**

Reset due to CPU lock up.

### Header File

- [components/esp\\_common/include/esp\\_idf\\_version.h](#)
- This header file can be included with:

```
#include "esp_idf_version.h"
```

### Functions

const char \***esp\_get\_idf\_version** (void)

Return full IDF version string, same as 'git describe' output.

---

**备注:** If you are printing the ESP-IDF version in a log file or other information, this function provides more information than using the numerical version macros. For example, numerical version macros don't differentiate between development, pre-release and release versions, but the output of this function does.

---

**返回** constant string from IDF\_VER

### Macros

**ESP\_IDF\_VERSION\_MAJOR**

Major version number (X.x.x)

**ESP\_IDF\_VERSION\_MINOR**

Minor version number (x.X.x)

**ESP\_IDF\_VERSION\_PATCH**

Patch version number (x.x.X)

**ESP\_IDF\_VERSION\_VAL** (major, minor, patch)

Macro to convert IDF version number into an integer

To be used in comparisons, such as `ESP_IDF_VERSION >= ESP_IDF_VERSION_VAL(4, 0, 0)`

**ESP\_IDF\_VERSION**

Current IDF version, as an integer

To be used in comparisons, such as `ESP_IDF_VERSION >= ESP_IDF_VERSION_VAL(4, 0, 0)`

### Header File

- [components/esp\\_hw\\_support/include/esp\\_mac.h](#)
- This header file can be included with:

```
#include "esp_mac.h"
```

## Functions

**esp\_err\_t esp\_base\_mac\_addr\_set** (const uint8\_t \*mac)

Set base MAC address with the MAC address which is stored in BLK3 of EFUSE or external storage e.g. flash and EEPROM.

Base MAC address is used to generate the MAC addresses used by network interfaces.

If using a custom base MAC address, call this API before initializing any network interfaces. Refer to the ESP-IDF Programming Guide for details about how the Base MAC is used.

---

**备注:** Base MAC must be a unicast MAC (least significant bit of first byte must be zero).

---



---

**备注:** If not using a valid OUI, set the "locally administered" bit (bit value 0x02 in the first byte) to avoid collisions.

---

**参数 mac** -- base MAC address, length: 6 bytes. length: 6 bytes for MAC-48

**返回** ESP\_OK on success ESP\_ERR\_INVALID\_ARG If mac is NULL or is not a unicast MAC

**esp\_err\_t esp\_base\_mac\_addr\_get** (uint8\_t \*mac)

Return base MAC address which is set using esp\_base\_mac\_addr\_set.

---

**备注:** If no custom Base MAC has been set, this returns the pre-programmed Espressif base MAC address.

---

**参数 mac** -- base MAC address, length: 6 bytes. length: 6 bytes for MAC-48

**返回** ESP\_OK on success ESP\_ERR\_INVALID\_ARG mac is NULL  
ESP\_ERR\_INVALID\_MAC base MAC address has not been set

**esp\_err\_t esp\_efuse\_mac\_get\_custom** (uint8\_t \*mac)

Return base MAC address which was previously written to BLK3 of EFUSE.

Base MAC address is used to generate the MAC addresses used by the networking interfaces. This API returns the custom base MAC address which was previously written to EFUSE BLK3 in a specified format.

Writing this EFUSE allows setting of a different (non-Espressif) base MAC address. It is also possible to store a custom base MAC address elsewhere, see esp\_base\_mac\_addr\_set() for details.

---

**备注:** This function is currently only supported on ESP32.

---

**参数 mac** -- base MAC address, length: 6 bytes/8 bytes. length: 6 bytes for MAC-48 8 bytes for EUI-64(used for IEEE 802.15.4, if CONFIG\_SOC\_IEEE802154\_SUPPORTED=y)

**返回** ESP\_OK on success ESP\_ERR\_INVALID\_ARG mac is NULL  
ESP\_ERR\_INVALID\_MAC CUSTOM\_MAC address has not been set, all zeros (for esp32-xx) ESP\_ERR\_INVALID\_VERSION An invalid MAC version field was read from BLK3 of EFUSE (for esp32) ESP\_ERR\_INVALID\_CRC An invalid MAC CRC was read from BLK3 of EFUSE (for esp32)

**esp\_err\_t esp\_efuse\_mac\_get\_default** (uint8\_t \*mac)

Return base MAC address which is factory-programmed by Espressif in EFUSE.

**参数 mac** -- base MAC address, length: 6 bytes/8 bytes. length: 6 bytes for MAC-48 8 bytes for EUI-64(used for IEEE 802.15.4, if CONFIG\_SOC\_IEEE802154\_SUPPORTED=y)



返回 ESP\_OK on success ESP\_ERR\_INVALID\_ARG mac is NULL

*esp\_err\_t* **esp\_read\_mac** (uint8\_t \*mac, *esp\_mac\_type\_t* type)

Read base MAC address and set MAC address of the interface.

This function first get base MAC address using `esp_base_mac_addr_get()`. Then calculates the MAC address of the specific interface requested, refer to ESP-IDF Programming Guide for the algorithm.

The MAC address set by the `esp_iface_mac_addr_set()` function will not depend on the base MAC address.

参数

- **mac** -- base MAC address, length: 6 bytes/8 bytes. length: 6 bytes for MAC-48 8 bytes for EUI-64(used for IEEE 802.15.4, if CONFIG\_SOC\_IEEE802154\_SUPPORTED=y)
- **type** -- Type of MAC address to return

返回 ESP\_OK on success

*esp\_err\_t* **esp\_derive\_local\_mac** (uint8\_t \*local\_mac, const uint8\_t \*universal\_mac)

Derive local MAC address from universal MAC address.

This function copies a universal MAC address and then sets the "locally administered" bit (bit 0x2) in the first octet, creating a locally administered MAC address.

If the universal MAC address argument is already a locally administered MAC address, then the first octet is XORed with 0x4 in order to create a different locally administered MAC address.

参数

- **local\_mac** -- base MAC address, length: 6 bytes. length: 6 bytes for MAC-48
- **universal\_mac** -- Source universal MAC address, length: 6 bytes.

返回 ESP\_OK on success

*esp\_err\_t* **esp\_iface\_mac\_addr\_set** (const uint8\_t \*mac, *esp\_mac\_type\_t* type)

Set custom MAC address of the interface. This function allows you to overwrite the MAC addresses of the interfaces set by the base MAC address.

参数

- **mac** -- MAC address, length: 6 bytes/8 bytes. length: 6 bytes for MAC-48 8 bytes for EUI-64(used for ESP\_MAC\_IEEE802154 type, if CONFIG\_SOC\_IEEE802154\_SUPPORTED=y)
- **type** -- Type of MAC address

返回 ESP\_OK on success

size\_t **esp\_mac\_addr\_len\_get** (*esp\_mac\_type\_t* type)

Return the size of the MAC type in bytes.

If CONFIG\_SOC\_IEEE802154\_SUPPORTED is set then for these types:

- ESP\_MAC\_IEEE802154 is 8 bytes.
- ESP\_MAC\_BASE, ESP\_MAC\_EFUSE\_FACTORY and ESP\_MAC\_EFUSE\_CUSTOM the MAC size is 6 bytes.
- ESP\_MAC\_EFUSE\_EXT is 2 bytes. If CONFIG\_SOC\_IEEE802154\_SUPPORTED is not set then for all types it returns 6 bytes.

参数 **type** -- Type of MAC address

返回 0 MAC type not found (not supported) 6 bytes for MAC-48. 8 bytes for EUI-64.

## Macros

**MAC2STR** (a)

**MACSTR**



## Enumerations

enum **esp\_mac\_type\_t**

Values:

enumerator **ESP\_MAC\_WIFI\_STA**

MAC for WiFi Station (6 bytes)

enumerator **ESP\_MAC\_WIFI\_SOFTAP**

MAC for WiFi Soft-AP (6 bytes)

enumerator **ESP\_MAC\_BT**

MAC for Bluetooth (6 bytes)

enumerator **ESP\_MAC\_ETH**

MAC for Ethernet (6 bytes)

enumerator **ESP\_MAC\_IEEE802154**

if CONFIG\_SOC\_IEEE802154\_SUPPORTED=y, MAC for IEEE802154 (8 bytes)

enumerator **ESP\_MAC\_BASE**

Base MAC for that used for other MAC types (6 bytes)

enumerator **ESP\_MAC\_EFUSE\_FACTORY**

MAC\_FACTORY eFuse which was burned by Espressif in production (6 bytes)

enumerator **ESP\_MAC\_EFUSE\_CUSTOM**

MAC\_CUSTOM eFuse which can be burned by customer (6 bytes)

enumerator **ESP\_MAC\_EFUSE\_EXT**

if CONFIG\_SOC\_IEEE802154\_SUPPORTED=y, MAC\_EXT eFuse which is used as an extender for IEEE802154 MAC (2 bytes)

## Header File

- [components/esp\\_hw\\_support/include/esp\\_chip\\_info.h](#)
- This header file can be included with:

```
#include "esp_chip_info.h"
```

## Functions

void **esp\_chip\_info** (*esp\_chip\_info\_t* \*out\_info)

Fill an *esp\_chip\_info\_t* structure with information about the chip.

参数 **out\_info** -- [out] structure to be filled

## Structures

struct **esp\_chip\_info\_t**

The structure represents information about the chip.

## Public Members

### `esp_chip_model_t` **model**

chip model, one of `esp_chip_model_t`

### `uint32_t` **features**

bit mask of `CHIP_FEATURE_x` feature flags

### `uint16_t` **revision**

chip revision number (in format MXX; where M - wafer major version, XX - wafer minor version)

### `uint8_t` **cores**

number of CPU cores

## Macros

### **CHIP\_FEATURE\_EMB\_FLASH**

Chip has embedded flash memory.

### **CHIP\_FEATURE\_WIFI\_BGN**

Chip has 2.4GHz WiFi.

### **CHIP\_FEATURE\_BLE**

Chip has Bluetooth LE.

### **CHIP\_FEATURE\_BT**

Chip has Bluetooth Classic.

### **CHIP\_FEATURE\_IEEE802154**

Chip has IEEE 802.15.4.

### **CHIP\_FEATURE\_EMB\_PSRAM**

Chip has embedded psram.

## Enumerations

### enum **esp\_chip\_model\_t**

Chip models.

*Values:*

#### enumerator **CHIP\_ESP32**

ESP32.

#### enumerator **CHIP\_ESP32S2**

ESP32-S2.

#### enumerator **CHIP\_ESP32S3**

ESP32-S3.

enumerator **CHIP\_ESP32C3**

ESP32-C3.

enumerator **CHIP\_ESP32C2**

ESP32-C2.

enumerator **CHIP\_ESP32C6**

ESP32-C6.

enumerator **CHIP\_ESP32H2**

ESP32-H2.

enumerator **CHIP\_ESP32P4**

ESP32-P4.

enumerator **CHIP\_ESP32C61**

ESP32-C61.

enumerator **CHIP\_POSIX\_LINUX**

The code is running on POSIX/Linux simulator.

### Header File

- [components/esp\\_hw\\_support/include/esp\\_cpu.h](#)
- This header file can be included with:

```
#include "esp_cpu.h"
```

### Functions

void **esp\_cpu\_stall** (int core\_id)

Stall a CPU core.

**参数** **core\_id** -- The core's ID

void **esp\_cpu\_unstall** (int core\_id)

Resume a previously stalled CPU core.

**参数** **core\_id** -- The core's ID

void **esp\_cpu\_reset** (int core\_id)

Reset a CPU core.

**参数** **core\_id** -- The core's ID

void **esp\_cpu\_wait\_for\_intr** (void)

Wait for Interrupt.

This function causes the current CPU core to execute its Wait For Interrupt (WFI or equivalent) instruction. After executing this function, the CPU core will stop execution until an interrupt occurs.

int **esp\_cpu\_get\_core\_id** (void)

Get the current core's ID.

This function will return the ID of the current CPU (i.e., the CPU that calls this function).

**返回** The current core's ID [0..SOC\_CPU\_CORES\_NUM - 1]

void \***esp\_cpu\_get\_sp** (void)

Read the current stack pointer address.

**返回** Stack pointer address

*esp\_cpu\_cycle\_count\_t* **esp\_cpu\_get\_cycle\_count** (void)

Get the current CPU core's cycle count.

Each CPU core maintains an internal counter (i.e., cycle count) that increments every CPU clock cycle.

**返回** Current CPU's cycle count, 0 if not supported.

void **esp\_cpu\_set\_cycle\_count** (*esp\_cpu\_cycle\_count\_t* cycle\_count)

Set the current CPU core's cycle count.

Set the given value into the internal counter that increments every CPU clock cycle.

**参数** **cycle\_count** -- CPU cycle count

void \***esp\_cpu\_pc\_to\_addr** (uint32\_t pc)

Convert a program counter (PC) value to address.

If the architecture does not store the true virtual address in the CPU's PC or return addresses, this function will convert the PC value to a virtual address. Otherwise, the PC is just returned

**参数** **pc** -- PC value

**返回** Virtual address

void **esp\_cpu\_intr\_get\_desc** (int core\_id, int intr\_num, *esp\_cpu\_intr\_desc\_t* \*intr\_desc\_ret)

Get a CPU interrupt's descriptor.

Each CPU interrupt has a descriptor describing the interrupt's capabilities and restrictions. This function gets the descriptor of a particular interrupt on a particular CPU.

**参数**

- **core\_id** -- [in] The core's ID
- **intr\_num** -- [in] Interrupt number
- **intr\_desc\_ret** -- [out] The interrupt's descriptor

void **esp\_cpu\_intr\_set\_ivt\_addr** (const void \*ivt\_addr)

Set the base address of the current CPU's Interrupt Vector Table (IVT)

**参数** **ivt\_addr** -- Interrupt Vector Table's base address

void **esp\_cpu\_intr\_set\_type** (int intr\_num, *esp\_cpu\_intr\_type\_t* intr\_type)

Set the interrupt type of a particular interrupt.

Set the interrupt type (Level or Edge) of a particular interrupt on the current CPU.

**参数**

- **intr\_num** -- Interrupt number (from 0 to 31)
- **intr\_type** -- The interrupt's type

*esp\_cpu\_intr\_type\_t* **esp\_cpu\_intr\_get\_type** (int intr\_num)

Get the current configured type of a particular interrupt.

Get the currently configured type (i.e., level or edge) of a particular interrupt on the current CPU.

**参数** **intr\_num** -- Interrupt number (from 0 to 31)

**返回** Interrupt type

void **esp\_cpu\_intr\_set\_priority** (int intr\_num, int intr\_priority)

Set the priority of a particular interrupt.

Set the priority of a particular interrupt on the current CPU.

**参数**

- **intr\_num** -- Interrupt number (from 0 to 31)

- **intr\_priority** -- The interrupt's priority

int **esp\_cpu\_intr\_get\_priority** (int intr\_num)

Get the current configured priority of a particular interrupt.

Get the currently configured priority of a particular interrupt on the current CPU.

参数 **intr\_num** -- Interrupt number (from 0 to 31)

返回 Interrupt's priority

bool **esp\_cpu\_intr\_has\_handler** (int intr\_num)

Check if a particular interrupt already has a handler function.

Check if a particular interrupt on the current CPU already has a handler function assigned.

---

备注: This function simply checks if the IVT of the current CPU already has a handler assigned.

---

参数 **intr\_num** -- Interrupt number (from 0 to 31)

返回 True if the interrupt has a handler function, false otherwise.

void **esp\_cpu\_intr\_set\_handler** (int intr\_num, *esp\_cpu\_intr\_handler\_t* handler, void \*handler\_arg)

Set the handler function of a particular interrupt.

Assign a handler function (i.e., ISR) to a particular interrupt on the current CPU.

---

备注: This function simply sets the handler function (in the IVT) and does not actually enable the interrupt.

---

参数

- **intr\_num** -- Interrupt number (from 0 to 31)
- **handler** -- Handler function
- **handler\_arg** -- Argument passed to the handler function

void \***esp\_cpu\_intr\_get\_handler\_arg** (int intr\_num)

Get a handler function's argument of.

Get the argument of a previously assigned handler function on the current CPU.

参数 **intr\_num** -- Interrupt number (from 0 to 31)

返回 The the argument passed to the handler function

void **esp\_cpu\_intr\_enable** (uint32\_t intr\_mask)

Enable particular interrupts on the current CPU.

参数 **intr\_mask** -- Bit mask of the interrupts to enable

void **esp\_cpu\_intr\_disable** (uint32\_t intr\_mask)

Disable particular interrupts on the current CPU.

参数 **intr\_mask** -- Bit mask of the interrupts to disable

uint32\_t **esp\_cpu\_intr\_get\_enabled\_mask** (void)

Get the enabled interrupts on the current CPU.

返回 Bit mask of the enabled interrupts

void **esp\_cpu\_intr\_edge\_ack** (int intr\_num)

Acknowledge an edge interrupt.

参数 **intr\_num** -- Interrupt number (from 0 to 31)

void **esp\_cpu\_configure\_region\_protection** (void)

Configure the CPU to disable access to invalid memory regions.

*esp\_err\_t* **esp\_cpu\_set\_breakpoint** (int bp\_num, const void \*bp\_addr)

Set and enable a hardware breakpoint on the current CPU.

---

**备注:** This function is meant to be called by the panic handler to set a breakpoint for an attached debugger during a panic.

---

---

**备注:** Overwrites previously set breakpoint with same breakpoint number.

---

**参数**

- **bp\_num** -- Hardware breakpoint number [0..SOC\_CPU\_BREAKPOINTS\_NUM - 1]
- **bp\_addr** -- Address to set a breakpoint on

**返回** ESP\_OK if breakpoint is set. Failure otherwise

*esp\_err\_t* **esp\_cpu\_clear\_breakpoint** (int bp\_num)

Clear a hardware breakpoint on the current CPU.

---

**备注:** Clears a breakpoint regardless of whether it was previously set

---

**参数** **bp\_num** -- Hardware breakpoint number [0..SOC\_CPU\_BREAKPOINTS\_NUM - 1]

**返回** ESP\_OK if breakpoint is cleared. Failure otherwise

*esp\_err\_t* **esp\_cpu\_set\_watchpoint** (int wp\_num, const void \*wp\_addr, size\_t size, *esp\_cpu\_watchpoint\_trigger\_t* trigger)

Set and enable a hardware watchpoint on the current CPU.

Set and enable a hardware watchpoint on the current CPU, specifying the memory range and trigger operation. Watchpoints will break/panic the CPU when the CPU accesses (according to the trigger type) on a certain memory range.

---

**备注:** Overwrites previously set watchpoint with same watchpoint number. On RISC-V chips, this API uses method0(Exact matching) and method1(NAPOT matching) according to the riscv-debug-spec-0.13 specification for address matching. If the watch region size is 1byte, it uses exact matching (method 0). If the watch region size is larger than 1byte, it uses NAPOT matching (method 1). This mode requires the watching region start address to be aligned to the watching region size.

---

**参数**

- **wp\_num** -- Hardware watchpoint number [0..SOC\_CPU\_WATCHPOINTS\_NUM - 1]
- **wp\_addr** -- Watchpoint's base address, must be naturally aligned to the size of the region
- **size** -- Size of the region to watch. Must be one of  $2^n$  and in the range of [1 ... SOC\_CPU\_WATCHPOINT\_MAX\_REGION\_SIZE]
- **trigger** -- Trigger type

**返回** ESP\_ERR\_INVALID\_ARG on invalid arg, ESP\_OK otherwise

*esp\_err\_t* **esp\_cpu\_clear\_watchpoint** (int wp\_num)

Clear a hardware watchpoint on the current CPU.

---

**备注:** Clears a watchpoint regardless of whether it was previously set

---

**参数** `wp_num` -- Hardware watchpoint number [0..SOC\_CPU\_WATCHPOINTS\_NUM - 1]  
**返回** ESP\_OK if watchpoint was cleared. Failure otherwise.

bool `esp_cpu_dbggr_is_attached` (void)

Check if the current CPU has a debugger attached.

**返回** True if debugger is attached, false otherwise

void `esp_cpu_dbggr_break` (void)

Trigger a call to the current CPU's attached debugger.

intptr\_t `esp_cpu_get_call_addr` (intptr\_t return\_address)

Given the return address, calculate the address of the preceding call instruction This is typically used to answer the question "where was the function called from?".

**参数** `return_address` -- The value of the return address register. Typically set to the value of `__builtin_return_address(0)`.

**返回** Address of the call instruction preceding the return address.

bool `esp_cpu_compare_and_set` (volatile uint32\_t \*addr, uint32\_t compare\_value, uint32\_t new\_value)

Atomic compare-and-set operation.

**参数**

- **addr** -- Address of atomic variable
- **compare\_value** -- Value to compare the atomic variable to
- **new\_value** -- New value to set the atomic variable to

**返回** Whether the atomic variable was set or not

## Structures

struct `esp_cpu_intr_desc_t`

CPU interrupt descriptor.

Each particular CPU interrupt has an associated descriptor describing that particular interrupt's characteristics. Call `esp_cpu_intr_get_desc()` to get the descriptors of a particular interrupt.

## Public Members

int `priority`

Priority of the interrupt if it has a fixed priority, (-1) if the priority is configurable.

*esp\_cpu\_intr\_type\_t* type

Whether the interrupt is an edge or level type interrupt, ESP\_CPU\_INTR\_TYPE\_NA if the type is configurable.

uint32\_t `flags`

Flags indicating extra details.

## Macros

`ESP_CPU_INTR_DESC_FLAG_SPECIAL`

Interrupt descriptor flags of *esp\_cpu\_intr\_desc\_t*.

The interrupt is a special interrupt (e.g., a CPU timer interrupt)

`ESP_CPU_INTR_DESC_FLAG_RESVD`

The interrupt is reserved for internal use

## Type Definitions

typedef uint32\_t **esp\_cpu\_cycle\_count\_t**

CPU cycle count type.

This data type represents the CPU's clock cycle count

typedef void (\***esp\_cpu\_intr\_handler\_t**)(void \*arg)

CPU interrupt handler type.

## Enumerations

enum **esp\_cpu\_intr\_type\_t**

CPU interrupt type.

*Values:*

enumerator **ESP\_CPU\_INTR\_TYPE\_LEVEL**

enumerator **ESP\_CPU\_INTR\_TYPE\_EDGE**

enumerator **ESP\_CPU\_INTR\_TYPE\_NA**

enum **esp\_cpu\_watchpoint\_trigger\_t**

CPU watchpoint trigger type.

*Values:*

enumerator **ESP\_CPU\_WATCHPOINT\_LOAD**

enumerator **ESP\_CPU\_WATCHPOINT\_STORE**

enumerator **ESP\_CPU\_WATCHPOINT\_ACCESS**

## Header File

- [components/esp\\_app\\_format/include/esp\\_app\\_desc.h](#)
- This header file can be included with:

```
#include "esp_app_desc.h"
```

- This header file is a part of the API provided by the `esp_app_format` component. To declare that your component depends on `esp_app_format`, add the following to your `CMakeLists.txt`:

```
REQUIRES esp_app_format
```

or

```
PRIV_REQUIRES esp_app_format
```

## Functions

const [esp\\_app\\_desc\\_t](#) \***esp\_app\_get\_description** (void)

Return `esp_app_desc` structure. This structure includes app version.

Return description for running app.

**返回** Pointer to `esp_app_desc` structure.



int **esp\_app\_get\_elf\_sha256** (char \*dst, size\_t size)

Fill the provided buffer with SHA256 of the ELF file, formatted as hexadecimal, null-terminated. If the buffer size is not sufficient to fit the entire SHA256 in hex plus a null terminator, the largest possible number of bytes will be written followed by a null.

**参数**

- **dst** -- Destination buffer
- **size** -- Size of the buffer

**返回** Number of bytes written to dst (including null terminator)

char \***esp\_app\_get\_elf\_sha256\_str** (void)

Return SHA256 of the ELF file which is already formatted as hexadecimal, null-terminated included. Can be used in panic handler or core dump during when cache is disabled. The length is defined by CONFIG\_APP\_RETRIEVE\_LEN\_ELF\_SHA option.

**返回** Hexadecimal SHA256 string

## Structures

struct **esp\_app\_desc\_t**

Description about application.

### Public Members

uint32\_t **magic\_word**

Magic word ESP\_APP\_DESC\_MAGIC\_WORD

uint32\_t **secure\_version**

Secure version

uint32\_t **reserv1**[2]

reserv1

char **version**[32]

Application version

char **project\_name**[32]

Project name

char **time**[16]

Compile time

char **date**[16]

Compile date

char **idf\_ver**[32]

Version IDF

uint8\_t **app\_elf\_sha256**[32]

sha256 of elf file

uint32\_t **reserv2**[20]

reserv2

## Macros

### ESP\_APP\_DESC\_MAGIC\_WORD

The magic word for the `esp_app_desc` structure that is in DRAM.

## 2.10.22 空中升级 (OTA)

### OTA 流程概览

OTA 升级机制可以让设备在固件正常运行时根据接收数据（如通过 Wi-Fi、蓝牙或以太网）进行自我更新。

要运行 OTA 机制，需配置设备的分区表，该分区表至少包括两个 OTA 应用程序分区（即 `ota_0` 和 `ota_1`）和一个 OTA 数据分区。

OTA 功能启动后，向当前未用于启动的 OTA 应用分区写入新的应用固件镜像。镜像验证后，OTA 数据分区更新，指定在下次启动时使用该镜像。

### OTA 数据分区

所有使用 OTA 功能项目，其分区表必须包含一个 OTA 数据分区（类型为 `data`，子类型为 `ota`）。

工厂启动设置下，OTA 数据分区中应没有数据（所有字节擦写成 `0xFF`）。如果分区表中有工厂应用程序，ESP-IDF 软件引导加载程序会启动工厂应用程序。如果分区表中没有工厂应用程序，则启动第一个可用的 OTA 分区（通常是 `ota_0`）。

第一次 OTA 升级后，OTA 数据分区更新，指定下次启动哪个 OTA 应用程序分区。

OTA 数据分区的容量是 2 个 flash 扇区的大小（`0x2000` 字节），防止写入时电源故障引发问题。两个扇区单独擦除、写入匹配数据，若存在不一致，则用计数器字段判定哪个扇区为最新数据。

### 应用程序回滚

应用程序回滚的主要目的是确保设备在更新后正常工作。如果新版应用程序出现严重错误，该功能可使设备回滚到之前正常运行的应用版本。在使能回滚并且 OTA 升级应用程序至新版本后，可能出现的结果如下：

- 应用程序运行正常，`esp_ota_mark_app_valid_cancel_rollback()` 将正在运行的应用程序状态标记为 `ESP_OTA_IMG_VALID`，启动此应用程序无限制。
- 应用程序出现严重错误，无法继续工作，必须回滚到此前的版本，`esp_ota_mark_app_invalid_rollback_and_reboot()` 将正在运行的版本标记为 `ESP_OTA_IMG_INVALID` 然后复位。引导加载程序不会选取此版本，而是启动此前正常运行的版本。
- 如果 `CONFIG_BOOTLOADER_APP_ROLLBACK_ENABLE` 使能，则无需调用函数便可复位，回滚至之前的应用版本。

可使用以下代码检测 OTA 更新后应用程序的首次启动。首次启动时，应用程序会检查其状态并执行检测。如果检测成功，应用程序调用 `esp_ota_mark_app_valid_cancel_rollback()` 函数，确认应用运行成功。如果检测失败，应用程序调用 `esp_ota_mark_app_invalid_rollback_and_reboot()` 函数，回滚至之前的应用版本。

如果应用程序由于中止、重启或掉电无法启动或运行上述代码，引导加载程序在下次启动尝试中会将该应用程序的状态标记为 `ESP_OTA_IMG_INVALID`，并回滚至之前的应用版本。

```

const esp_partition_t *running = esp_ota_get_running_partition();
esp_ota_img_states_t ota_state;
if (esp_ota_get_state_partition(running, &ota_state) == ESP_OK) {
    if (ota_state == ESP_OTA_IMG_PENDING_VERIFY) {
        // run diagnostic function ...
        bool diagnostic_is_ok = diagnostic();
        if (diagnostic_is_ok) {
            ESP_LOGI(TAG, "Diagnostics completed successfully! Continuing_
→execution ...");
            esp_ota_mark_app_valid_cancel_rollback();
        } else {
            ESP_LOGE(TAG, "Diagnostics failed! Start rollback to the previous_
→version ...");
            esp_ota_mark_app_invalid_rollback_and_reboot();
        }
    }
}
}

```

请查看 [system/ota/native\\_ota\\_example](#) 获取包含上述代码片段的完整示例。

**备注：**应用程序的状态不是写到程序的二进制镜像，而是写到 otadata 分区。该分区有一个 ota\_seq 计数器，该计数器是 OTA 应用分区的指针，指向下次启动时选取应用所在的分区 (ota\_0, ota\_1, ...)。

**应用程序 OTA 状态** 状态控制了选取启动应用程序的过程：

状态	引导加载程序选取启动应用程序的限制
ESP_OTA_IMG_VALID	没有限制，可以选取。
ESP_OTA_IMG_UNDELETED	没有限制，可以选取。
ESP_OTA_IMG_INVALID	不会选取。
ESP_OTA_IMG_ABORTED	不会选取。
ESP_OTA_IMG_NEW	如使能 <a href="#">CONFIG_BOOTLOADER_APP_ROLLBACK_ENABLE</a> ，则仅会选取一次。在引导加载程序中，状态立即变为 ESP_OTA_IMG_PENDING_VERIFY。
ESP_OTA_IMG_PENDING_VERIFY	如使能 <a href="#">CONFIG_BOOTLOADER_APP_ROLLBACK_ENABLE</a> ，则不会选取，状态变为 ESP_OTA_IMG_ABORTED。

如果 [CONFIG\\_BOOTLOADER\\_APP\\_ROLLBACK\\_ENABLE](#) 没有使能（默认情况），则 `esp_ota_mark_app_valid_cancel_rollback()` 和 `esp_ota_mark_app_invalid_rollback_and_reboot()` 为可选功能，ESP\_OTA\_IMG\_NEW 和 ESP\_OTA\_IMG\_PENDING\_VERIFY 不会使用。

Kconfig 中的 [CONFIG\\_BOOTLOADER\\_APP\\_ROLLBACK\\_ENABLE](#) 可以帮助用户追踪新版应用程序的第一次启动。应用程序需调用 `esp_ota_mark_app_valid_cancel_rollback()` 函数确认可以运行，否则将会在重启时回滚至旧版本。该功能可让用户在启动阶段控制应用程序的可操作性。新版应用程序仅有一次机会尝试是否能成功启动。

**回滚过程** [CONFIG\\_BOOTLOADER\\_APP\\_ROLLBACK\\_ENABLE](#) 使能时，回滚过程如下：

- 新版应用程序下载成功，`esp_ota_set_boot_partition()` 函数将分区设为可启动，状态设为 ESP\_OTA\_IMG\_NEW。该状态表示应用程序为新版本，第一次启动需要监测。
- 重新启动 `esp_restart()`。
- 引导加载程序检查 ESP\_OTA\_IMG\_PENDING\_VERIFY 状态，如有设置，则将其写入 ESP\_OTA\_IMG\_ABORTED。
- 引导加载程序选取一个新版应用程序来引导，这样应用程序状态就不会设置为 ESP\_OTA\_IMG\_INVALID 或 ESP\_OTA\_IMG\_ABORTED。
- 引导加载程序检查所选取的新版应用程序，若状态设置为 ESP\_OTA\_IMG\_NEW，则写入 ESP\_OTA\_IMG\_PENDING\_VERIFY。该状态表示，需确认应用程序的可操作性，如不确认，发

生重启，则状态会重写为 `ESP_OTA_IMG_ABORTED`（见上文），该应用程序不可再启动，将回滚至上一版本。

- 新版应用程序启动，应进行自测。
- 若通过自测，则必须调用函数 `esp_ota_mark_app_valid_cancel_rollback()`，因为新版应用程序在等待确认其可操作性（`ESP_OTA_IMG_PENDING_VERIFY` 状态）。
- 若未通过自测，则调用函数 `esp_ota_mark_app_invalid_rollback_and_reboot()`，回滚至之前能正常工作的应用程序版本，同时将无效的新版本应用程序设置为 `ESP_OTA_IMG_INVALID`。
- 如果新版应用程序可操作性没有确认，则状态一直为 `ESP_OTA_IMG_PENDING_VERIFY`。下一次启动时，状态变更为 `ESP_OTA_IMG_ABORTED`，阻止其再次启动，之后回滚到之前的版本。

**意外复位** 如果在新版应用第一次启动时发生断电或意外崩溃，则会回滚至之前正常运行的版本。

建议：尽快完成自测，防止因断电回滚。

只有 OTA 分区可以回滚。工厂分区不会回滚。

**启动无效/中止的应用程序** 用户可以启动此前设置为 `ESP_OTA_IMG_INVALID` 或 `ESP_OTA_IMG_ABORTED` 的应用程序：

- 获取最后一个无效应用分区 `esp_ota_get_last_invalid_partition()`。
- 将获取的分区传递给 `esp_ota_set_boot_partition()`，更新 otadata。
- 重启 `esp_restart()`。引导加载程序会启动指定应用程序。

要确定是否在应用程序启动时进行自测，可以调用 `esp_ota_get_state_partition()` 函数。如果结果为 `ESP_OTA_IMG_PENDING_VERIFY`，则需要自测，后续确认应用程序的可操作性。

**如何设置状态** 下文简单描述了如何设置应用程序状态：

- `ESP_OTA_IMG_VALID` 由函数 `esp_ota_mark_app_valid_cancel_rollback()` 设置。
- 如果 `CONFIG_BOOTLOADER_APP_ROLLBACK_ENABLE` 没有使能，`ESP_OTA_IMG_UNDEFINED` 由函数 `esp_ota_set_boot_partition()` 设置。
- 如果 `CONFIG_BOOTLOADER_APP_ROLLBACK_ENABLE` 使能，`ESP_OTA_IMG_NEW` 由函数 `esp_ota_set_boot_partition()` 设置。
- `ESP_OTA_IMG_INVALID` 由函数 `esp_ota_mark_app_invalid_rollback_and_reboot()` 设置。
- 如果应用程序的可操作性无法确认，发生重启（`CONFIG_BOOTLOADER_APP_ROLLBACK_ENABLE` 使能），则设置 `ESP_OTA_IMG_ABORTED`。
- 如果 `CONFIG_BOOTLOADER_APP_ROLLBACK_ENABLE` 使能，选取的应用程序状态为 `ESP_OTA_IMG_NEW`，则在引导加载程序中设置 `ESP_OTA_IMG_PENDING_VERIFY`。

## 防回滚

防回滚机制可以防止回滚到安全版本号低于芯片 eFuse 中烧录程序的应用程序版本。

设置 `CONFIG_BOOTLOADER_APP_ANTI_ROLLBACK`，启动防回滚机制。在引导加载程序中选取可启动的应用程序，会额外检查芯片和应用程序镜像的安全版本号。可启动固件中的应用安全版本号必须等于或高于芯片中的应用安全版本号。

`CONFIG_BOOTLOADER_APP_ANTI_ROLLBACK` 和 `CONFIG_BOOTLOADER_APP_ROLLBACK_ENABLE` 一起使用。此时，只有安全版本号等于或高于芯片中的应用安全版本号时才会回滚。

## 典型的防回滚机制

- 新发布的固件解决了此前版本的安全问题。
- 开发者在确保固件可以运行之后，增加安全版本号，发布固件。
- 下载新版应用程序。
- 运行函数 `esp_ota_set_boot_partition()`，将新版应用程序设为可启动。如果新版应用程序的安全版本号低于芯片中的应用安全版本号，新版应用程序会被擦除，无法更新到新固件。

- 重新启动。
- 在引导加载程序中选取安全版本号等于或高于芯片中应用安全版本号的应用程序。如果 otadata 处于初始阶段，通过串行通道加载了安全版本号高于芯片中应用安全版本的固件，则引导加载程序中 eFuse 的安全版本号会立即更新。
- 新版应用程序启动，之后进行可操作性检测，如果通过检测，则调用函数 `esp_ota_mark_app_valid_cancel_rollback()`，将应用程序标记为 `ESP_OTA_IMG_VALID`，更新芯片中应用程序的安全版本号。注意，如果调用函数 `esp_ota_mark_app_invalid_rollback_and_reboot()`，可能会因为设备中没有可启动的应用程序而回滚失败，返回 `ESP_ERR_OTA_ROLLBACK_FAILED` 错误，应用程序状态一直为 `ESP_OTA_IMG_PENDING_VERIFY`。
- 如果运行的应用程序处于 `ESP_OTA_IMG_VALID` 状态，则可再次更新。

建议：

如果想避免因服务器应用程序的安全版本号低于运行的应用程序，造成不必要的下载和擦除，必须从镜像的第一个包中获取 `new_app_info.secure_version`，和 eFuse 的安全版本号比较。如果 `esp_efuse_check_secure_version(new_app_info.secure_version)` 函数为真，则下载继续，反之则中断。

```

....
bool image_header_was_checked = false;
while (1) {
    int data_read = esp_http_client_read(client, ota_write_data, BUFFSIZE);
    ...
    if (data_read > 0) {
        if (image_header_was_checked == false) {
            esp_app_desc_t new_app_info;
            if (data_read > sizeof(esp_image_header_t) + sizeof(esp_image_segment_
↪header_t) + sizeof(esp_app_desc_t)) {
                // check current version with downloading
                if (esp_efuse_check_secure_version(new_app_info.secure_version) ==_
↪false) {
                    ESP_LOGE(TAG, "This a new app can not be downloaded due to a_
↪secure version is lower than stored in efuse.");
                    http_cleanup(client);
                    task_fatal_error();
                }

                image_header_was_checked = true;

                esp_ota_begin(update_partition, OTA_SIZE_UNKNOWN, &update_handle);
            }
        }
        esp_ota_write( update_handle, (const void *)ota_write_data, data_read);
    }
}
....

```

限制：

- `secure_version` 字段最多有 16 位。也就是说，防回滚最多可以做 16 次。用户可以使用 `CONFIG_BOOTLOADER_APP_SEC_VER_SIZE_EFUSE_FIELD` 减少该 eFuse 字段的长度。
- 防回滚不支持工厂和测试分区，因此分区表中不应有设置为 工厂或 测试的分区。

`security_version`:

- 存储在应用程序镜像中的 `esp_app_desc` 里。版本号用 `CONFIG_BOOTLOADER_APP_SECURE_VERSION` 设置。

## 没有安全启动的安全 OTA 升级

即便硬件安全启动没有使能，也可验证已签名的 OTA 升级。可通过设置 `CONFIG_SECURE_SIGNED_APPS_NO_SECURE_BOOT` 和 `CONFIG_SECURE_SIGNED_ON_UPDATE_NO_SECURE_BOOT` 实现。

### OTA 工具 `otatool.py`

`app_update` 组件中有 `app_update/otatool.py` 工具，用于在目标设备上完成下列 OTA 分区相关操作：

- 读取 `otadata` 分区 (`read_otadata`)
- 擦除 `otadata` 分区，将设备复位至工厂应用程序 (`erase_otadata`)
- 切换 OTA 分区 (`switch_ota_partition`)
- 擦除 OTA 分区 (`erase_ota_partition`)
- 写入 OTA 分区 (`write_ota_partition`)
- 读取 OTA 分区 (`read_ota_partition`)

用户若想通过编程方式完成相关操作，可从另一个 Python 脚本导入并使用该 OTA 工具，或者从 Shell 脚本调用该 OTA 工具。前者可使用工具的 Python API，后者可使用命令行界面。

**Python API** 首先，确保已导入 `otatool` 模块。

```
import sys
import os

idf_path = os.environ["IDF_PATH"] # 从环境中获取 IDF_PATH 的值
otatool_dir = os.path.join(idf_path, "components", "app_update") # otatool.py_
↳ 位于 $IDF_PATH/components/app_update 下

sys.path.append(otatool_dir) # 使能 Python 寻找 otatool 模块
from otatool import * # 导入 otatool 模块内的所有名称
```

要使用 OTA 工具的 Python API，第一步是创建 `OtatoolTarget` 对象：

```
# 创建 parttool.py 的目标设备，并将目标设备连接到串行端口 /dev/ttyUSB1
target = OtatoolTarget("/dev/ttyUSB1")
```

现在，可使用创建的 `OtatoolTarget` 在目标设备上完成操作：

```
# 擦除 otadata，将设备复位至工厂应用程序
target.erase_otadata()

# 擦除 OTA 应用程序分区 0
target.erase_ota_partition(0)

# 将启动分区切换至 OTA 应用程序分区 1
target.switch_ota_partition(1)

# 读取 OTA 分区 'ota_3'，将内容保存至文件 'ota_3.bin'
target.read_ota_partition("ota_3", "ota_3.bin")
```

要操作的 OTA 分区通过应用程序分区序号或分区名称指定。

更多关于 Python API 的信息，请查看 OTA 工具的代码注释。

**命令行界面** `otatool.py` 的命令行界面具有如下结构：



```
otatool.py [command-args] [subcommand] [subcommand-args]
```

- command-args - 执行主命令 (otatool.py) 所需的实际参数, 多与目标设备有关
- subcommand - 要执行的操作
- subcommand-args - 所选操作的实际参数

```
# 擦除 otadata, 将设备复位至工厂应用程序
otatool.py --port "/dev/ttyUSB1" erase_otadata

# 擦除 OTA 应用程序分区 0
otatool.py --port "/dev/ttyUSB1" erase_ota_partition --slot 0

# 将启动分区切换至 OTA 应用程序分区 1
otatool.py --port "/dev/ttyUSB1" switch_ota_partition --slot 1

# 读取 OTA 分区 'ota_3', 将内容保存至文件 'ota_3.bin'
otatool.py --port "/dev/ttyUSB1" read_ota_partition --name=ota_3 --output=ota_3.bin
```

更多信息可用 `--help` 指令查看:

```
# 显示可用的子命令和主命令描述
otatool.py --help

# 显示子命令的描述
otatool.py [subcommand] --help
```

## 相关文档

- [分区表](#)
- [分区 API](#)
- [SPI flash API](#)
- [ESP HTTPS OTA 升级](#)

## 应用程序示例

端对端的 OTA 固件升级示例请参考 [system/ota](#)。

## API 参考

### Header File

- [components/app\\_update/include/esp\\_ota\\_ops.h](#)
- This header file can be included with:

```
#include "esp_ota_ops.h"
```

- This header file is a part of the API provided by the `app_update` component. To declare that your component depends on `app_update`, add the following to your `CMakeLists.txt`:

```
REQUIRES app_update
```

or

```
PRIV_REQUIRES app_update
```

## Functions

const *esp\_app\_desc\_t* \***esp\_ota\_get\_app\_description** (void)

Return *esp\_app\_desc* structure. This structure includes app version.

Return description for running app.

---

**备注:** This API is present for backward compatibility reasons. Alternative function with the same functionality is *esp\_app\_get\_description*

---

**返回** Pointer to *esp\_app\_desc* structure.

int **esp\_ota\_get\_app\_elf\_sha256** (char \*dst, size\_t size)

Fill the provided buffer with SHA256 of the ELF file, formatted as hexadecimal, null-terminated. If the buffer size is not sufficient to fit the entire SHA256 in hex plus a null terminator, the largest possible number of bytes will be written followed by a null.

---

**备注:** This API is present for backward compatibility reasons. Alternative function with the same functionality is *esp\_app\_get\_elf\_sha256*

---

#### 参数

- **dst** -- Destination buffer
- **size** -- Size of the buffer

**返回** Number of bytes written to dst (including null terminator)

*esp\_err\_t* **esp\_ota\_begin** (const *esp\_partition\_t* \*partition, size\_t image\_size, *esp\_ota\_handle\_t* \*out\_handle)

Commence an OTA update writing to the specified partition.

The specified partition is erased to the specified image size.

If image size is not yet known, pass `OTA_SIZE_UNKNOWN` which will cause the entire partition to be erased.

On success, this function allocates memory that remains in use until *esp\_ota\_end*() is called with the returned handle.

Note: If the rollback option is enabled and the running application has the `ESP_OTA_IMG_PENDING_VERIFY` state then it will lead to the `ESP_ERR_OTA_ROLLBACK_INVALID_STATE` error. Confirm the running app before to run download a new app, use *esp\_ota\_mark\_app\_valid\_cancel\_rollback*() function for it (this should be done as early as possible when you first download a new application).

#### 参数

- **partition** -- Pointer to info for partition which will receive the OTA update. Required.
- **image\_size** -- Size of new OTA app image. Partition will be erased in order to receive this size of image. If 0 or `OTA_SIZE_UNKNOWN`, the entire partition is erased.
- **out\_handle** -- On success, returns a handle which should be used for subsequent *esp\_ota\_write*() and *esp\_ota\_end*() calls.

#### 返回

- `ESP_OK`: OTA operation commenced successfully.
- `ESP_ERR_INVALID_ARG`: partition or out\_handle arguments were NULL, or partition doesn't point to an OTA app partition.
- `ESP_ERR_NO_MEM`: Cannot allocate memory for OTA operation.
- `ESP_ERR_OTA_PARTITION_CONFLICT`: Partition holds the currently running firmware, cannot update in place.
- `ESP_ERR_NOT_FOUND`: Partition argument not found in partition table.
- `ESP_ERR_OTA_SELECT_INFO_INVALID`: The OTA data partition contains invalid data.
- `ESP_ERR_INVALID_SIZE`: Partition doesn't fit in configured flash size.



- `ESP_ERR_FLASH_OP_TIMEOUT` or `ESP_ERR_FLASH_OP_FAIL`: Flash write failed.
- `ESP_ERR_OTA_ROLLBACK_INVALID_STATE`: If the running app has not confirmed state. Before performing an update, the application must be valid.

*esp\_err\_t* `esp_ota_write` (*esp\_ota\_handle\_t* handle, const void \*data, size\_t size)

Write OTA update data to partition.

This function can be called multiple times as data is received during the OTA operation. Data is written sequentially to the partition.

#### 参数

- **handle** -- Handle obtained from `esp_ota_begin`
- **data** -- Data buffer to write
- **size** -- Size of data buffer in bytes.

#### 返回

- `ESP_OK`: Data was written to flash successfully, or size = 0
- `ESP_ERR_INVALID_ARG`: handle is invalid.
- `ESP_ERR_OTA_VALIDATE_FAILED`: First byte of image contains invalid app image magic byte.
- `ESP_ERR_FLASH_OP_TIMEOUT` or `ESP_ERR_FLASH_OP_FAIL`: Flash write failed.
- `ESP_ERR_OTA_SELECT_INFO_INVALID`: OTA data partition has invalid contents

*esp\_err\_t* `esp_ota_write_with_offset` (*esp\_ota\_handle\_t* handle, const void \*data, size\_t size, uint32\_t offset)

Write OTA update data to partition at an offset.

This function can write data in non-contiguous manner. If flash encryption is enabled, data should be 16 bytes aligned.

---

**备注:** While performing OTA, if the packets arrive out of order, `esp_ota_write_with_offset()` can be used to write data in non-contiguous manner. Use of `esp_ota_write_with_offset()` in combination with `esp_ota_write()` is not recommended.

---

#### 参数

- **handle** -- Handle obtained from `esp_ota_begin`
- **data** -- Data buffer to write
- **size** -- Size of data buffer in bytes
- **offset** -- Offset in flash partition

#### 返回

- `ESP_OK`: Data was written to flash successfully.
- `ESP_ERR_INVALID_ARG`: handle is invalid.
- `ESP_ERR_OTA_VALIDATE_FAILED`: First byte of image contains invalid app image magic byte.
- `ESP_ERR_FLASH_OP_TIMEOUT` or `ESP_ERR_FLASH_OP_FAIL`: Flash write failed.
- `ESP_ERR_OTA_SELECT_INFO_INVALID`: OTA data partition has invalid contents

*esp\_err\_t* `esp_ota_end` (*esp\_ota\_handle\_t* handle)

Finish OTA update and validate newly written app image.

---

**备注:** After calling `esp_ota_end()`, the handle is no longer valid and any memory associated with it is freed (regardless of result).

---

**参数** **handle** -- Handle obtained from `esp_ota_begin()`.

#### 返回

- ESP\_OK: Newly written OTA app image is valid.
- ESP\_ERR\_NOT\_FOUND: OTA handle was not found.
- ESP\_ERR\_INVALID\_ARG: Handle was never written to.
- ESP\_ERR\_OTA\_VALIDATE\_FAILED: OTA image is invalid (either not a valid app image, or - if secure boot is enabled - signature failed to verify.)
- ESP\_ERR\_INVALID\_STATE: If flash encryption is enabled, this result indicates an internal error writing the final encrypted bytes to flash.

*esp\_err\_t* **esp\_ota\_abort** (*esp\_ota\_handle\_t* handle)

Abort OTA update, free the handle and memory associated with it.

**参数 handle** -- obtained from esp\_ota\_begin().

**返回**

- ESP\_OK: Handle and its associated memory is freed successfully.
- ESP\_ERR\_NOT\_FOUND: OTA handle was not found.

*esp\_err\_t* **esp\_ota\_set\_boot\_partition** (const *esp\_partition\_t* \*partition)

Configure OTA data for a new boot partition.

---

**备注:** If this function returns ESP\_OK, calling esp\_restart() will boot the newly configured app partition.

---

**参数 partition** -- Pointer to info for partition containing app image to boot.

**返回**

- ESP\_OK: OTA data updated, next reboot will use specified partition.
- ESP\_ERR\_INVALID\_ARG: partition argument was NULL or didn't point to a valid OTA partition of type "app".
- ESP\_ERR\_OTA\_VALIDATE\_FAILED: Partition contained invalid app image. Also returned if secure boot is enabled and signature validation failed.
- ESP\_ERR\_NOT\_FOUND: OTA data partition not found.
- ESP\_ERR\_FLASH\_OP\_TIMEOUT or ESP\_ERR\_FLASH\_OP\_FAIL: Flash erase or write failed.

const *esp\_partition\_t* \***esp\_ota\_get\_boot\_partition** (void)

Get partition info of currently configured boot app.

If esp\_ota\_set\_boot\_partition() has been called, the partition which was set by that function will be returned.

If esp\_ota\_set\_boot\_partition() has not been called, the result is usually the same as esp\_ota\_get\_running\_partition(). The two results are not equal if the configured boot partition does not contain a valid app (meaning that the running partition will be an app that the bootloader chose via fallback).

If the OTA data partition is not present or not valid then the result is the first app partition found in the partition table. In priority order, this means: the factory app, the first OTA app slot, or the test app partition.

Note that there is no guarantee the returned partition is a valid app. Use esp\_image\_verify(ESP\_IMAGE\_VERIFY, ...) to verify if the returned partition contains a bootable image.

**返回** Pointer to info for partition structure, or NULL if partition table is invalid or a flash read operation failed. Any returned pointer is valid for the lifetime of the application.

const *esp\_partition\_t* \***esp\_ota\_get\_running\_partition** (void)

Get partition info of currently running app.

This function is different to esp\_ota\_get\_boot\_partition() in that it ignores any change of selected boot partition caused by esp\_ota\_set\_boot\_partition(). Only the app whose code is currently running will have its partition information returned.

The partition returned by this function may also differ from esp\_ota\_get\_boot\_partition() if the configured boot partition is somehow invalid, and the bootloader fell back to a different app partition at boot.

**返回** Pointer to info for partition structure, or NULL if no partition is found or flash read operation failed. Returned pointer is valid for the lifetime of the application.

`const esp_partition_t *esp_ota_get_next_update_partition (const esp_partition_t *start_from)`

Return the next OTA app partition which should be written with a new firmware.

Call this function to find an OTA app partition which can be passed to `esp_ota_begin()`.

Finds next partition round-robin, starting from the current running partition.

**参数** `start_from` -- If set, treat this partition info as describing the current running partition. Can be NULL, in which case `esp_ota_get_running_partition()` is used to find the currently running partition. The result of this function is never the same as this argument.

**返回** Pointer to info for partition which should be updated next. NULL result indicates invalid OTA data partition, or that no eligible OTA app slot partition was found.

`esp_err_t esp_ota_get_partition_description (const esp_partition_t *partition, esp_app_desc_t *app_desc)`

Returns `esp_app_desc` structure for app partition. This structure includes app version.

Returns a description for the requested app partition.

**参数**

- **partition** -- **[in]** Pointer to app partition. (only app partition)
- **app\_desc** -- **[out]** Structure of info about app.

**返回**

- ESP\_OK Successful.
- ESP\_ERR\_NOT\_FOUND `app_desc` structure is not found. Magic word is incorrect.
- ESP\_ERR\_NOT\_SUPPORTED Partition is not application.
- ESP\_ERR\_INVALID\_ARG Arguments is NULL or if partition's offset exceeds partition size.
- ESP\_ERR\_INVALID\_SIZE Read would go out of bounds of the partition.
- or one of error codes from lower-level flash driver.

`esp_err_t esp_ota_get_bootloader_description (const esp_partition_t *bootloader_partition, esp_bootloader_desc_t *desc)`

Returns the description structure of the bootloader.

**参数**

- **bootloader\_partition** -- **[in]** Pointer to bootloader partition. If NULL, then the current bootloader is used (the default location).  
offset = CONFIG\_BOOTLOADER\_OFFSET\_IN\_FLASH,  
size = CONFIG\_PARTITION\_TABLE\_OFFSET - CONFIG\_BOOTLOADER\_OFFSET\_IN\_FLASH,
- **desc** -- **[out]** Structure of info about bootloader.

**返回**

- ESP\_OK Successful.
- ESP\_ERR\_NOT\_FOUND Description structure is not found in the bootloader image. Magic byte is incorrect.
- ESP\_ERR\_INVALID\_ARG Arguments is NULL.
- ESP\_ERR\_INVALID\_SIZE Read would go out of bounds of the partition.
- or one of error codes from lower-level flash driver.

`uint8_t esp_ota_get_app_partition_count (void)`

Returns number of ota partitions provided in partition table.

**返回**

- Number of OTA partitions

`esp_err_t esp_ota_mark_app_valid_cancel_rollback (void)`

This function is called to indicate that the running app is working well.

**返回**

- ESP\_OK: if successful.

*esp\_err\_t* **esp\_ota\_mark\_app\_invalid\_rollback\_and\_reboot** (void)

This function is called to roll back to the previously workable app with reboot.

If rollback is successful then device will reset else API will return with error code. Checks applications on a flash drive that can be booted in case of rollback. If the flash does not have at least one app (except the running app) then rollback is not possible.

返回

- ESP\_FAIL: if not successful.
- ESP\_ERR\_OTA\_ROLLBACK\_FAILED: The rollback is not possible due to flash does not have any apps.

const *esp\_partition\_t* \***esp\_ota\_get\_last\_invalid\_partition** (void)

Returns last partition with invalid state (ESP\_OTA\_IMG\_INVALID or ESP\_OTA\_IMG\_ABORTED).

返回 partition.

*esp\_err\_t* **esp\_ota\_get\_state\_partition** (const *esp\_partition\_t* \*partition, *esp\_ota\_img\_states\_t* \*ota\_state)

Returns state for given partition.

参数

- **partition** -- [in] Pointer to partition.
- **ota\_state** -- [out] state of partition (if this partition has a record in otadata).

返回

- ESP\_OK: Successful.
- ESP\_ERR\_INVALID\_ARG: partition or ota\_state arguments were NULL.
- ESP\_ERR\_NOT\_SUPPORTED: partition is not ota.
- ESP\_ERR\_NOT\_FOUND: Partition table does not have otadata or state was not found for given partition.

*esp\_err\_t* **esp\_ota\_erase\_last\_boot\_app\_partition** (void)

Erase previous boot app partition and corresponding otadata select for this partition.

When current app is marked to as valid then you can erase previous app partition.

返回

- ESP\_OK: Successful, otherwise ESP\_ERR.

bool **esp\_ota\_check\_rollback\_is\_possible** (void)

Checks applications on the slots which can be booted in case of rollback.

These applications should be valid (marked in otadata as not UNDEFINED, INVALID or ABORTED and crc is good) and be able booted, and secure\_version of app >= secure\_version of efuse (if anti-rollback is enabled).

返回

- True: Returns true if the slots have at least one app (except the running app).
- False: The rollback is not possible.

*esp\_err\_t* **esp\_ota\_revoke\_secure\_boot\_public\_key** (*esp\_ota\_secure\_boot\_public\_key\_index\_t* index)

Revokes the signature digest denoted by the given index. This should be called in the application only after the rollback logic otherwise the device may end up in unrecoverable state.

Relevant for Secure boot v2 on ESP32-S2, ESP32-S3, ESP32-C3, ESP32-C6, ESP32-H2 where up to 3 key digests can be stored (Key #N-1, Key #N, Key #N+1). When a key used to sign an app is invalidated, an OTA update is to be sent with an app signed with at least one of the other two keys which has not been revoked already. After successfully booting the OTA app should call this function to revoke Key #N-1.

参数 **index** -- - The index of the signature block to be revoked

返回

- ESP\_OK: If revocation is successful.
- ESP\_ERR\_INVALID\_ARG: If the index of the public key to be revoked is incorrect.

- `ESP_FAIL`: If secure boot v2 has not been enabled.

## Macros

### `OTA_SIZE_UNKNOWN`

Used for `esp_ota_begin()` if new image size is unknown

### `OTA_WITH_SEQUENTIAL_WRITES`

Used for `esp_ota_begin()` if new image size is unknown and erase can be done in incremental manner (assuming write operation is in continuous sequence)

### `ESP_ERR_OTA_BASE`

Base error code for `ota_ops` api

### `ESP_ERR_OTA_PARTITION_CONFLICT`

Error if request was to write or erase the current running partition

### `ESP_ERR_OTA_SELECT_INFO_INVALID`

Error if OTA data partition contains invalid content

### `ESP_ERR_OTA_VALIDATE_FAILED`

Error if OTA app image is invalid

### `ESP_ERR_OTA_SMALL_SEC_VER`

Error if the firmware has a secure version less than the running firmware.

### `ESP_ERR_OTA_ROLLBACK_FAILED`

Error if flash does not have valid firmware in passive partition and hence rollback is not possible

### `ESP_ERR_OTA_ROLLBACK_INVALID_STATE`

Error if current active firmware is still marked in pending validation state (`ESP_OTA_IMG_PENDING_VERIFY`), essentially first boot of firmware image post upgrade and hence firmware upgrade is not possible

## Type Definitions

```
typedef uint32_t esp_ota_handle_t
```

Opaque handle for an application OTA update.

`esp_ota_begin()` returns a handle which is then used for subsequent calls to `esp_ota_write()` and `esp_ota_end()`.

## Enumerations

```
enum esp_ota_secure_boot_public_key_index_t
```

Secure Boot V2 public key indexes.

*Values:*

```
enumerator SECURE_BOOT_PUBLIC_KEY_INDEX_0
```

Points to the 0th index of the Secure Boot v2 public key

enumerator `SECURE_BOOT_PUBLIC_KEY_INDEX_1`

Points to the 1st index of the Secure Boot v2 public key

enumerator `SECURE_BOOT_PUBLIC_KEY_INDEX_2`

Points to the 2nd index of the Secure Boot v2 public key

## OTA 升级失败排查



图 38: OTA 升级失败时如何排查 (点击放大)

## 2.10.23 电源管理

### 概述

ESP-IDF 中集成的电源管理算法可以根据应用程序组件的需求, 调整外围总线 (APB) 频率和 CPU 频率, 并使芯片进入 Light-sleep 模式, 尽可能减少运行应用程序的功耗。

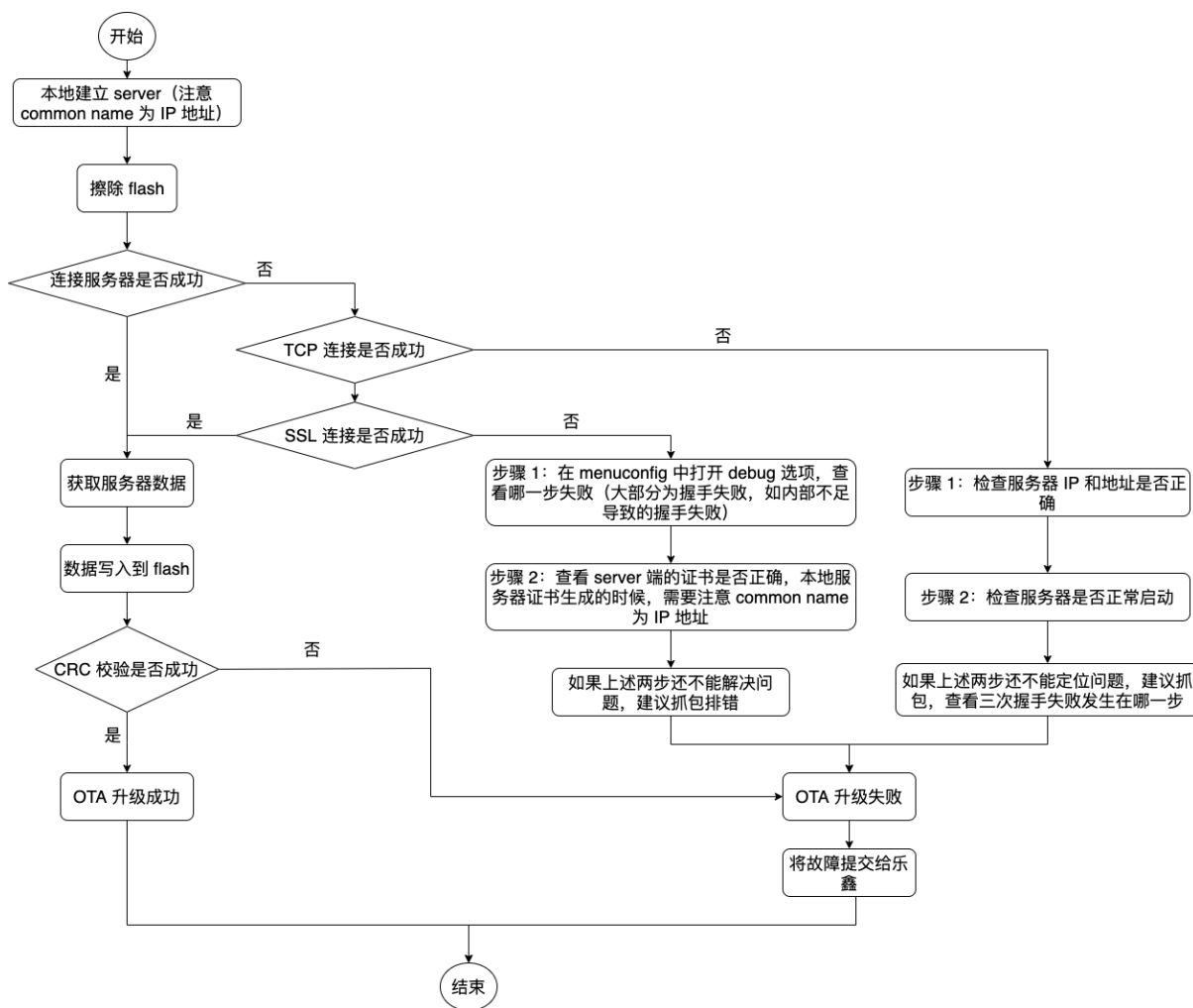
应用程序组件可以通过创建和获取电源管理锁来控制功耗。

例如:

- 对于从 APB 获得时钟频率的外设，其驱动可以要求在使用该外设时，将 APB 频率设置为 80 MHz。
- RTOS 可以要求 CPU 在有任务准备开始运行时以最高配置频率工作。
- 一些外设可能需要中断才能启用，因此其驱动也会要求禁用 Light-sleep 模式。

请求较高的 APB 频率或 CPU 频率以及禁用 Light-sleep 模式会增加功耗，因此请将组件使用的电源管理锁降到最少。

## 电源管理配置

编译时可使用 `CONFIG_PM_ENABLE` 选项启用电源管理功能。

启用电源管理功能将会增加中断延迟。额外延迟与多个因素有关，例如：CPU 频率、单/双核模式、是否需要进行频率切换等。CPU 频率为 240 MHz 且未启用频率调节时，最小额外延迟为 0.2 us；如果启用频率调节，且在中断入口将频率由 40 MHz 调节至 80 MHz，则最大额外延迟为 40 us。

通过调用 `esp_pm_configure()` 函数可以在应用程序中启用动态调频 (DFS) 功能和自动 Light-sleep 模式。此函数的参数 `esp_pm_config_t` 定义了频率调节的相关设置。在此参数结构中，需要初始化以下三个字段：

- `max_freq_mhz`：最大 CPU 频率 (MHz)，即获取 `ESP_PM_CPU_FREQ_MAX` 锁后所使用的频率。该字段通常设置为 `CONFIG_ESP_DEFAULT_CPU_FREQ_MHZ`。
- `min_freq_mhz`：最小 CPU 频率 (MHz)，即未持有电源管理锁时所使用的频率。
  - `light_sleep_enable`：没有获取任何管理锁时，决定系统是否需要自动进入 Light-sleep 状态 (true/false)。

如果在 `menuconfig` 中启用了 `CONFIG_PM_DFS_INIT_AUTO` 选项，最大 CPU 频率将由 `CONFIG_ESP_DEFAULT_CPU_FREQ_MHZ` 设置决定，最小 CPU 频率将锁定为 XTAL 频率。

**备注：** 自动 Light-sleep 模式基于 FreeRTOS Tickless Idle 功能，因此如果在 `menuconfig` 中没有启用 `CONFIG_FREERTOS_USE_TICKLESS_IDLE` 选项，在请求自动 Light-sleep 时，`esp_pm_configure()` 将会返回 `ESP_ERR_NOT_SUPPORTED` 错误。

**备注：** Light-sleep 状态下，外设有有时钟门控，不会产生来自 GPIO 和内部外设的中断。[睡眠模式](#) 文档中所提到的唤醒源可用于从 Light-sleep 状态触发唤醒。

例如，EXT0 和 EXT1 唤醒源可以通过 GPIO 唤醒芯片。

## 电源管理锁

应用程序可以通过获取或释放管理锁来控制电源管理算法。应用程序获取电源管理锁后，电源管理算法的操作将受到下面的限制。释放电源管理锁后，限制解除。

电源管理锁设有获取/释放计数器，如果已多次获取电源管理锁，则需要将电源管理锁释放相同次数以解除限制。

ESP32-H2 支持下表中三种电源管理锁。

电源管理锁	描述
<code>ESP_PM_CPU_FREQ_MAX</code>	请求使用 <code>esp_pm_configure()</code> 将 CPU 频率设置为最大值。ESP32-H2 可以将该值设置为 Not updated yet。
<code>ESP_PM_APB_FREQ_MAX</code>	请求将 APB 频率设置为最大值，ESP32-H2 支持的最大频率为 80 MHz。
<code>ESP_PM_NO_LIGHT_SLEEP</code>	禁止自动切换至 Light-sleep 模式。



**ESP32-H2 电源管理算法**

下表列出了启用动态调频时如何切换 CPU 频率和 APB 频率。可以使用 `esp_pm_configure()` 或 `CONFIG_ESP_DEFAULT_CPU_FREQ_MHZ` 指定 CPU 最大频率。

CPU 最高频率	电源管理锁获取情况	APB 频率和 CPU 频率
96	获取 ESP_PM_CPU_FREQ_MAX	CPU: 96 MHz APB: 32 Mhz
	获取 ESP_PM_APB_FREQ_MAX, 未获得 ESP_PM_CPU_FREQ_MAX	CPU: 32 MHz APB: 32 Mhz
	无	使用 <code>esp_pm_configure()</code> 为二者设置最小值
64	获取 ESP_PM_CPU_FREQ_MAX	CPU: 64 MHz APB: 32 Mhz
	获取 ESP_PM_APB_FREQ_MAX, 未获得 ESP_PM_CPU_FREQ_MAX	CPU: 32 MHz APB: 32 Mhz
	无	使用 <code>esp_pm_configure()</code> 为二者设置最小值
48	获取 ESP_PM_CPU_FREQ_MAX	CPU: 48 MHz APB: 32 Mhz
	获取 ESP_PM_APB_FREQ_MAX, 未获得 ESP_PM_CPU_FREQ_MAX	CPU: 32 MHz APB: 32 Mhz
	无	使用 <code>esp_pm_configure()</code> 为二者设置最小值

如果没有获取任何管理锁，调用 `esp_pm_configure()` 将启动 Light-sleep 模式。Light-sleep 模式持续时间由以下因素决定：

- 处于阻塞状态的 FreeRTOS 任务数（有限超时）
- 高分辨率定时器 API 注册的计数器数量

也可以设置 Light-sleep 模式在最近事件（任务解除阻塞，或计时器超时）之前的持续时间，在持续时间结束后再唤醒芯片。

为了跳过不必要的唤醒，可以将 `skip_unhandled_events` 选项设置为 `true` 来初始化 `esp_timer`。带有此标志的定时器不会唤醒系统，有助于减少功耗。



## 动态调频和外设驱动

启用动态调频后，APB 频率可在一个 RTOS 滴答周期内多次更改。有些外设不受 APB 频率变更的影响，但有些外设可能会出现。例如，Timer Group 外设定时器会继续计数，但定时器计数的速度将随 APB 频率的变更而变更。

时钟频率不受 APB 频率影响的外设时钟源通常有 REF\_TICK, XTAL, RC\_FAST (i.e., RTC\_8M)。因此，为了保证外设在 DFS 期间的行为一致，建议在上述时钟中选择其一作为外设的时钟源。如果想要了解更多详情可以浏览每个外设” API 参考 > 外设 API “页面的“电源管理”章节。

目前以下外设驱动程序可感知动态调频，并在调频期间使用 ESP\_PM\_APB\_FREQ\_MAX 锁：

- SPI master
- I2C
- I2S（如果 APLL 锁在使用中，I2S 则会启用 ESP\_PM\_NO\_LIGHT\_SLEEP 锁）
- SDMMC

启用以下驱动程序时，将占用 ESP\_PM\_APB\_FREQ\_MAX 锁：

- **SPI slave**：从调用 `spi_slave_initialize()` 至 `spi_slave_free()` 期间。
- **GPTimer**：从调用 `gptimer_enable()` 至 `gptimer_disable()` 期间。
- **Ethernet**：从调用 `esp_eth_driver_install()` 至 `esp_eth_driver_uninstall()` 期间。
- **WiFi**：从调用 `esp_wifi_start()` 至 `esp_wifi_stop()` 期间。如果启用了调制解调器睡眠模式，广播关闭时将释放此管理锁。
- **TWAI**：从调用 `twai_driver_install()` 至 `twai_driver_uninstall()` 期间（只有在 TWAI 时钟源选择为 TWAI\_CLK\_SRC\_APB 的时候生效）。
- **Bluetooth**：从调用 `esp_bt_controller_enable()` 至 `esp_bt_controller_disable()` 期间。如果启用了蓝牙调制解调器，广播关闭时将释放此管理锁。但依然占用 ESP\_PM\_NO\_LIGHT\_SLEEP 锁。

以下外设驱动程序无法感知动态调频，应用程序需自己获取/释放管理锁：

- PCNT
- Sigma-delta
- 旧版定时器驱动 (Timer Group)
- MCPWM

## Light-sleep 外设下电

ESP32-H2 支持在 Light-sleep 时掉电外设的电源域。

如果在 menuconfig 中启用了 `CONFIG_PM_POWER_DOWN_PERIPHERAL_IN_LIGHT_SLEEP`，在初始化外设时，驱动会将外设工作的寄存器上下文注册到休眠备份链表中，在进入休眠前，REG\_DMA 外设会读取休眠备份链表中的配置，根据链表中的配置将外设的寄存器上下文备份至内存，REG\_DMA 也会在唤醒时将上下文从内存恢复到外设寄存器中。

目前 IDF 支持以下外设的 Light-sleep 上下文备份：- INT\_MTX - TEE/APM - IO\_MUX / GPIO - UART0 - TIMG0 - SPI0/1 - SYSTIMER

以下外设尚未支持：- ETM - TIMG1 - ASSIST\_DEBUG - Trace - Crypto: AES/ECC/HMAC/RSA/SHA/DS/XTA\_AES/ECDSA - SPI2 - I2S - PCNT - USB-Serial-JTAG - TWAI - LEDC - MCPWM - RMT - SARADC - SDIO - PARL\_IO - UART1

对于未支持 Light-sleep 上下文备份的外设，若启用了电源管理功能，应在外设工作时持有 ESP\_PM\_NO\_LIGHT\_SLEEP 锁以避免进入休眠导致外设工作上下文丢失。

**备注：** 当外设电源域在睡眠期间断电时，IO\_MUX 和 GPIO 模块都处于下电状态，这意味着芯片引脚的状态不会受这些模块控制。要在休眠期间保持 IO 的状态，需要在配置 GPIO 状态前后调

用 `gpio_hold_dis()` 和 `gpio_hold_en()`。此操作可确保 IO 配置被锁存，防止 IO 在睡眠期间浮空。

## API 参考

### Header File

- `components/esp_pm/include/esp_pm.h`
- This header file can be included with:

```
#include "esp_pm.h"
```

- This header file is a part of the API provided by the `esp_pm` component. To declare that your component depends on `esp_pm`, add the following to your `CMakeLists.txt`:

```
REQUIRES esp_pm
```

or

```
PRIV_REQUIRES esp_pm
```

### Functions

*esp\_err\_t* **esp\_pm\_configure** (const void \*config)

Set implementation-specific power management configuration.

**参数 config** -- pointer to implementation-specific configuration structure (e.g. `esp_pm_config_esp32`)

**返回**

- `ESP_OK` on success
- `ESP_ERR_INVALID_ARG` if the configuration values are not correct
- `ESP_ERR_NOT_SUPPORTED` if certain combination of values is not supported, or if `CONFIG_PM_ENABLE` is not enabled in `sdkconfig`

*esp\_err\_t* **esp\_pm\_get\_configuration** (void \*config)

Get implementation-specific power management configuration.

**参数 config** -- pointer to implementation-specific configuration structure (e.g. `esp_pm_config_esp32`)

**返回**

- `ESP_OK` on success
- `ESP_ERR_INVALID_ARG` if the pointer is null

*esp\_err\_t* **esp\_pm\_lock\_create** (*esp\_pm\_lock\_type\_t* lock\_type, int arg, const char \*name, *esp\_pm\_lock\_handle\_t* \*out\_handle)

Initialize a lock handle for certain power management parameter.

When lock is created, initially it is not taken. Call `esp_pm_lock_acquire` to take the lock.

This function must not be called from an ISR.

---

**备注:** If the `lock_type` argument is not valid, it will cause an abort.

---

**参数**

- **lock\_type** -- Power management constraint which the lock should control
- **arg** -- argument, value depends on `lock_type`, see `esp_pm_lock_type_t`
- **name** -- arbitrary string identifying the lock (e.g. "wifi" or "spi"). Used by the `esp_pm_dump_locks` function to list existing locks. May be set to `NULL`. If not set to `NULL`, must point to a string which is valid for the lifetime of the lock.

- **out\_handle** -- [out] handle returned from this function. Use this handle when calling `esp_pm_lock_delete`, `esp_pm_lock_acquire`, `esp_pm_lock_release`. Must not be NULL.

**返回**

- ESP\_OK on success
- ESP\_ERR\_NO\_MEM if the lock structure can not be allocated
- ESP\_ERR\_INVALID\_ARG if out\_handle is NULL
- ESP\_ERR\_NOT\_SUPPORTED if CONFIG\_PM\_ENABLE is not enabled in sdkconfig

*esp\_err\_t* **esp\_pm\_lock\_acquire** (*esp\_pm\_lock\_handle\_t* handle)

Take a power management lock.

Once the lock is taken, power management algorithm will not switch to the mode specified in a call to `esp_pm_lock_create`, or any of the lower power modes (higher numeric values of 'mode').

The lock is recursive, in the sense that if `esp_pm_lock_acquire` is called a number of times, `esp_pm_lock_release` has to be called the same number of times in order to release the lock.

This function may be called from an ISR.

This function is not thread-safe w.r.t. calls to other `esp_pm_lock_*` functions for the same handle.

**参数 handle** -- handle obtained from `esp_pm_lock_create` function

**返回**

- ESP\_OK on success
- ESP\_ERR\_INVALID\_ARG if the handle is invalid
- ESP\_ERR\_NOT\_SUPPORTED if CONFIG\_PM\_ENABLE is not enabled in sdkconfig

*esp\_err\_t* **esp\_pm\_lock\_release** (*esp\_pm\_lock\_handle\_t* handle)

Release the lock taken using `esp_pm_lock_acquire`.

Call to this functions removes power management restrictions placed when taking the lock.

Locks are recursive, so if `esp_pm_lock_acquire` is called a number of times, `esp_pm_lock_release` has to be called the same number of times in order to actually release the lock.

This function may be called from an ISR.

This function is not thread-safe w.r.t. calls to other `esp_pm_lock_*` functions for the same handle.

**参数 handle** -- handle obtained from `esp_pm_lock_create` function

**返回**

- ESP\_OK on success
- ESP\_ERR\_INVALID\_ARG if the handle is invalid
- ESP\_ERR\_INVALID\_STATE if lock is not acquired
- ESP\_ERR\_NOT\_SUPPORTED if CONFIG\_PM\_ENABLE is not enabled in sdkconfig

*esp\_err\_t* **esp\_pm\_lock\_delete** (*esp\_pm\_lock\_handle\_t* handle)

Delete a lock created using `esp_pm_lock`.

The lock must be released before calling this function.

This function must not be called from an ISR.

**参数 handle** -- handle obtained from `esp_pm_lock_create` function

**返回**

- ESP\_OK on success
- ESP\_ERR\_INVALID\_ARG if the handle argument is NULL
- ESP\_ERR\_INVALID\_STATE if the lock is still acquired
- ESP\_ERR\_NOT\_SUPPORTED if CONFIG\_PM\_ENABLE is not enabled in sdkconfig

*esp\_err\_t* **esp\_pm\_dump\_locks** (FILE \*stream)

Dump the list of all locks to stderr

This function dumps debugging information about locks created using `esp_pm_lock_create` to an output stream.

This function must not be called from an ISR. If `esp_pm_lock_acquire/release` are called while this function is running, inconsistent results may be reported.

**参数** `stream` -- stream to print information to; use `stdout` or `stderr` to print to the console; use `fmemopen/open_memstream` to print to a string buffer.

**返回**

- `ESP_OK` on success
- `ESP_ERR_NOT_SUPPORTED` if `CONFIG_PM_ENABLE` is not enabled in `sdkconfig`

## Structures

struct `esp_pm_config_t`

Power management config.

Pass a pointer to this structure as an argument to `esp_pm_configure` function.

## Public Members

int `max_freq_mhz`

Maximum CPU frequency, in MHz

int `min_freq_mhz`

Minimum CPU frequency to use when no locks are taken, in MHz

bool `light_sleep_enable`

Enter light sleep when no locks are taken

## Type Definitions

typedef `esp_pm_config_t` `esp_pm_config_esp32_t`

backward compatibility newer chips no longer require this typedef

typedef `esp_pm_config_t` `esp_pm_config_esp32s2_t`

typedef `esp_pm_config_t` `esp_pm_config_esp32s3_t`

typedef `esp_pm_config_t` `esp_pm_config_esp32c3_t`

typedef `esp_pm_config_t` `esp_pm_config_esp32c2_t`

typedef `esp_pm_config_t` `esp_pm_config_esp32c6_t`

typedef struct `esp_pm_lock` \*`esp_pm_lock_handle_t`

Opaque handle to the power management lock.

## Enumerations

enum `esp_pm_lock_type_t`

Power management constraints.

*Values:*

enumerator **ESP\_PM\_CPU\_FREQ\_MAX**

Require CPU frequency to be at the maximum value set via `esp_pm_configure`. Argument is unused and should be set to 0.

enumerator **ESP\_PM\_APB\_FREQ\_MAX**

Require APB frequency to be at the maximum value supported by the chip. Argument is unused and should be set to 0.

enumerator **ESP\_PM\_NO\_LIGHT\_SLEEP**

Prevent the system from going into light sleep. Argument is unused and should be set to 0.

enumerator **ESP\_PM\_LOCK\_MAX**

## 2.10.24 POSIX Thread

### 概述

ESP-IDF 基于 FreeRTOS，但提供了一系列与 POSIX 兼容的 API，以便轻松移植第三方代码，例如支持 pthread 常用的 pthread API。

在 ESP-IDF 中，pthread 对 FreeRTOS 中的等效功能进行了包装。pthread API 所需的运行内存或性能开销很低，但 pthread 或 FreeRTOS 的可用功能并非都可以通过 ESP-IDF 的 pthread 支持来实现。

添加标准 pthread.h 头文件后可以在 ESP-IDF 中使用 pthread，该头文件已包含在工具链 libc 中。还有另一个专用于 ESP-IDF 的头文件 esp\_pthread.h，其中提供了一些额外的非 POSIX API，以便通过 pthread 使用一些 ESP-IDF 功能。

C++ 标准库中的 `std::thread`、`std::mutex`、`std::condition_variable` 等功能也是通过 pthread (利用 GCC libstdc++) 实现的。因此，本文档提到的限制条件也同样适用于 C++ 标准库中等效功能。

### RTOS 集成

与许多使用 pthread 的操作系统不同，ESP-IDF 是一个实时操作系统，具有实时调度程序。这意味着只有当一个更高优先级的任务准备就绪、线程在 OS 同步结构（如 mutex）上发生阻塞、或者线程调用 `sleep`、`vTaskDelay()`、`usleep` 等函数时，线程才会停止运行。

---

**备注：** 如果调用 C 标准库或 C++ `sleep` 函数，例如在 `unistd.h` 中定义的 `usleep`，那么只有当睡眠时间超过一个 *FreeRTOS 滴答周期* 时，任务才会阻塞并让出内核。如果时间较短，线程将处于忙等待状态，不会让步给另一个 RTOS 任务。

---

默认情况下，所有 pthread 具有相同的 RTOS 优先级，但可以通过调用 *ESP-IDF 提供的扩展 API* 对此优先级进行更改。

### 标准功能

ESP-IDF 中实现了以下标准 API。

请参考 [标准 pthread 文档](#) 或 `pthread.h`，了解每个函数标准参数和行为的详细信息。下文还列出了 pthread API 与标准 API 相比的差异或局限性。

## 线程 API

- **pthread\_create()**
  - attr 参数仅支持设置堆栈大小和分离状态，其他属性字段将被忽略。
  - 与 FreeRTOS 任务函数不同，start\_routine 函数允许返回。如果函数返回，分离类型的线程会被自动删除。而默认的可连接类型线程将被挂起，直到调用 pthread\_join()。
- pthread\_join()
- pthread\_detach()
- pthread\_exit()
- sched\_yield()
- **pthread\_self()**
  - 如果从不是 pthread 的 FreeRTOS 任务中调用此函数，断言会失败。
- pthread\_equal()

## 线程属性

- pthread\_attr\_init()
- **pthread\_attr\_destroy()**
  - 此函数不需要释放任何资源，而是将 attr 结构体重置为默认值。其实现与 pthread\_attr\_init() 相同。
- pthread\_attr\_getstacksize() / pthread\_attr\_setstacksize()
- pthread\_attr\_getdetachstate() / pthread\_attr\_setdetachstate()

## Once

- pthread\_once()

支持静态初始化常量 PTHREAD\_ONCE\_INIT。

---

**备注：** 在使用 pthread 或 FreeRTOS API 创建的任务中都可以调用此函数。

---

**互斥锁** POSIX 互斥锁被实现为 FreeRTOS 互斥信号量（普通类型用于“快速”或“错误检查”互斥锁，递归类型用于“递归”互斥锁），因此与使用 xSemaphoreCreateMutex() 创建的互斥锁具有相同的优先级继承行为。

- pthread\_mutex\_init()
- pthread\_mutex\_destroy()
- pthread\_mutex\_lock()
- pthread\_mutex\_timedlock()
- pthread\_mutex\_trylock()
- pthread\_mutex\_unlock()
- pthread\_mutexattr\_init()
- pthread\_mutexattr\_destroy()
- pthread\_mutexattr\_gettype() / pthread\_mutexattr\_settype()

支持静态初始化常量 PTHREAD\_MUTEX\_INITIALIZER，但不支持其他互斥锁类型的非标准静态初始化常量。

---

**备注：** 在使用 pthread 或 FreeRTOS API 创建的任务中都可以调用这些函数。

---

## 条件变量

- **pthread\_cond\_init()**
  - attr 参数未实现，将被忽略。
- pthread\_cond\_destroy()
- pthread\_cond\_signal()

- `pthread_cond_broadcast()`
- `pthread_cond_wait()`
- `pthread_cond_timedwait()`

支持静态初始化常量 `PTHREAD_COND_INITIALIZER`。

- `pthread_cond_timedwait()` 超时的分辨率为 RTOS 滴答周期（参见 [CONFIG\\_FREERTOS\\_HZ](#)）。在请求超时后，超时最多会延迟一个滴答周期。

---

**备注：** 在使用 `pthread` 或 `FreeRTOS` API 创建的任务中都可以调用这些函数。

---

**信号量** ESP-IDF 中实现了 POSIX 未命名信号量，下文介绍了可访问的 API。除非另有说明，否则 ESP-IDF 中未命名信号量的实现遵循 [POSIX 标准规定的信号量](#)。

- `sem_init()`
- `sem_destroy()`
  - `pshared` 被忽略。信号量始终可以在 `FreeRTOS` 任务之间共享。
- `sem_post()`
  - 如果信号量的值已经是 `SEM_VALUE_MAX`，则返回 `-1`，并将 `errno` 设置为 `EAGAIN`。
- `sem_wait()`
- `sem_trywait()`
- `sem_timedwait()`
  - 通过 `abstime` 传递的时间值将被向上舍入到下一个 `FreeRTOS` 时钟滴答。
  - 超时实际发生在被舍入到的滴答之后，下一个滴答之前。
  - 在计算超时后，任务有可能被立即抢占（可能性较小），从而延迟下一个阻塞操作系统调用的超时，延迟的时间等于抢占的持续时间。
- `sem_getvalue()`

**读/写锁** ESP-IDF 中实现了 POSIX 读写锁规范的以下 API 函数：

- `pthread_rwlock_init()`
  - `attr` 参数未实现，将被忽略。
- `pthread_rwlock_destroy()`
- `pthread_rwlock_rdlock()`
- `pthread_rwlock_tryrdlock()`
- `pthread_rwlock_wrlock()`
- `pthread_rwlock_trywrlock()`
- `pthread_rwlock_unlock()`

支持静态初始化器常量 `PTHREAD_RWLOCK_INITIALIZER`。

---

**备注：** 在 `pthread` 或 `FreeRTOS` API 创建的任务中都可以调用此函数。

---

### 线程特定数据

- `pthread_key_create()`
  - 支持 `destr_function` 参数。如果线程函数正常退出并调用 `pthread_exit()`，此参数就会被调用，或者在使用 `FreeRTOS` 函数 `vTaskDelete()` 直接删除了底层任务时被调用。
- `pthread_key_delete()`
- `pthread_setspecific()` / `pthread_getspecific()`

---

**备注：** 在 `pthread` 或 `FreeRTOS` API 创建的任务中都可以调用此函数。当从 `FreeRTOS` API 创建的任务中调用这些函数时，必须先启用 [CONFIG\\_FREERTOS\\_TLS\\_DELETE\\_CALLBACKS](#) 配置选项，以确保在删除任务之前清理线程数据。

---



---

**备注：**ESP-IDF 中还有其他的线程本地存储选项，包括性能更高的选项。参见[线程局部存储](#)。

---

## 未实现 API

`pthread.h` 头文件是一个标准头文件，包含了在 ESP-IDF 中未实现的额外 API 和功能，包括：

- 如果调用 `pthread_cancel()`，返回 `ENOSYS`。
- `pthread_condattr_init()` 如果被调用，返回 `ENOSYS`。

其他未列出的 `pthread` 函数未在 ESP-IDF 中实现，如果从 ESP-IDF 应用程序中直接引用，将产生编译器错误或链接器错误。如果希望 ESP-IDF 支持某个尚未实现的 API，请在 [GitHub](#) 上发起功能请求并提供详细信息。

## ESP-IDF 扩展

在 `esp_pthreads.h` 头文件中定义的 API `esp_pthread_set_cfg()` 提供了自定义扩展，能够对后续 `pthread_create()` 的调用行为进行控制。目前提供以下配置：

- 如果调用 `pthread_create()` 时未指定默认堆栈大小，可设置新线程的默认堆栈大小（覆盖 `CONFIG_PTHREAD_TASK_STACK_SIZE_DEFAULT`）。
- 堆栈内存属性决定用于分配 `pthread` 堆栈的内存类型。该字段使用 ESP-IDF 堆属性标志，这一标志在 `heap/include/esp_heap_caps.h` 文件中定义。为了确保分配的内存能够通过 8 位地址访问 (`MALLOC_CAP_8BIT`)，用户必须设置相应的标志，此外也可添加其他自定义标志。用户应当确保选择了正确的堆栈内存属性。了解内存位置的更多信息，请参考[内存属性](#)文档。
- 新线程的 RTOS 优先级（覆盖 `CONFIG_PTHREAD_TASK_PRIO_DEFAULT`）。
- 新线程的 FreeRTOS 任务名称（覆盖 `CONFIG_PTHREAD_TASK_NAME_DEFAULT`）。

此配置的作用范围是调用线程或 FreeRTOS 任务，这意味着 `esp_pthread_set_cfg()` 可以在不同的线程或任务中独立调用。如果在当前配置中设置了 `inherit_cfg` 标志，那么当一个线程递归调用 `pthread_create()` 时，任何新创建的线程都会继承该线程的配置，否则新线程将采用默认配置。

## 示例

- [system/pthread](#) 演示了如何使用 `pthread` API 创建线程。
- [cxx/pthread](#) 演示了如何通过线程使用 C++ 标准库函数。

## API 参考

### Header File

- [components/pthread/include/esp\\_pthread.h](#)
- This header file can be included with:

```
#include "esp_pthread.h"
```

- This header file is a part of the API provided by the `pthread` component. To declare that your component depends on `pthread`, add the following to your `CMakeLists.txt`:

```
REQUIRES pthread
```

or

```
PRIV_REQUIRES pthread
```



## Functions

*esp\_thread\_cfg\_t* **esp\_thread\_get\_default\_config** (void)

Creates a default pthread configuration based on the values set via menuconfig.

**返回** A default configuration structure.

*esp\_err\_t* **esp\_thread\_set\_cfg** (const *esp\_thread\_cfg\_t* \*cfg)

Configure parameters for creating pthread.

This API allows you to configure how the subsequent pthread\_create() call will behave. This call can be used to setup configuration parameters like stack size, priority, configuration inheritance etc.

If the 'inherit' flag in the configuration structure is enabled, then the same configuration is also inherited in the thread subtree.

---

**备注:** If `cfg->stack_alloc_caps` is 0, it is automatically set to valid default stack memory capabilities. If `cfg->stack_alloc_caps` is non-zero, the developer is responsible for its correctness. This function only checks that the capabilities are `MALLOC_CAP_8BIT`, the rest is unchecked.

---

---

**备注:** Passing non-NULL attributes to pthread\_create() will override the `stack_size` parameter set using this API

---

**参数** `cfg` -- The pthread config parameters

**返回**

- `ESP_OK` if configuration was successfully set
- `ESP_ERR_NO_MEM` if out of memory
- `ESP_ERR_INVALID_ARG` if `stack_size` is less than `PTHREAD_STACK_MIN`
- `ESP_ERR_INVALID_ARG` if `stack_alloc_caps` does not include `MALLOC_CAP_8BIT`

*esp\_err\_t* **esp\_thread\_get\_cfg** (*esp\_thread\_cfg\_t* \*p)

Get current pthread creation configuration.

This will retrieve the current configuration that will be used for creating threads.

**参数** `p` -- Pointer to the pthread config structure that will be updated with the currently configured parameters

**返回**

- `ESP_OK` if the configuration was available
- `ESP_ERR_NOT_FOUND` if a configuration wasn't previously set

*esp\_err\_t* **esp\_thread\_init** (void)

Initialize pthread library.

## Structures

struct **esp\_thread\_cfg\_t**

pthread configuration structure that influences pthread creation

### Public Members

size\_t **stack\_size**

The stack size of the pthread

size\_t **prio**

The thread's priority

bool **inherit\_cfg**

Inherit this configuration further

const char \***thread\_name**

The thread name.

int **pin\_to\_core**

The core id to pin the thread to. Has the same value range as xCoreId argument of xTaskCreatePinnedToCore.

uint32\_t **stack\_alloc\_caps**

A bit mask of memory capabilities (MALLOC\_CAPS\*) to use when allocating the stack. The memory must be 8 bit accessible (MALLOC\_CAP\_8BIT). The developer is responsible for the correctness of stack\_alloc\_caps.

## Macros

**PTHREAD\_STACK\_MIN**

## 2.10.25 随机数发生器

ESP32-H2 中包含一个硬件随机数发生器 (RNG)，可以调用 API `esp_random()` 和 `esp_fill_random()` 从中获取随机数值。

满足下列任意一个或多个条件时，硬件 RNG 会产生真随机数：

- RF 子系统已启用，即蓝牙或 802.15.4 Thread/Zigbee 已启用。
- 调用 `bootloader_random_enable()` 启用了内部熵源，并且熵源尚未被 `bootloader_random_disable()` 禁用。
- 在 ESP-IDF 二级引导程序运行时。这是因为默认的 ESP-IDF 引导加载程序启动时会调用 `bootloader_random_enable()`，并在执行应用程序前调用 `bootloader_random_disable()`。

当上述任一条件为真时，物理噪声样本会连续混合到内部硬件 RNG 状态中来提供熵。如需了解详情，请参阅 [ESP32-H2 技术参考手册 > 随机数发生器 \(RNG\) \[PDF\]](#) 章节。

如果上述条件都不满足，那么 RNG 的输出仅应被看作伪随机数。

### 启动

在启动过程中，ESP-IDF 引导加载程序暂时会启用一个非 RF 熵源（内部参考电压噪声），为首次生成的启动密钥提供熵。当应用程序开始执行后，一直到蓝牙或 802.15.4 Thread/Zigbee 初始化完成前，通常只有伪随机数可用。

如需在应用程序启动期间临时重启熵源，或为不使用蓝牙或 802.15.4 Thread/Zigbee 的应用程序临时重启熵源，请调用函数 `bootloader_random_enable()` 重启内部熵源。在使用 ADC、或使用蓝牙或 802.15.4 Thread/Zigbee 前，必须调用函数 `bootloader_random_disable()` 以禁用熵源。

---

**备注：**ESP-IDF 第二阶段引导加载程序在启动过程中启用的熵源会用熵来初始化内部 RNG 状态。但是，内部硬件 RNG 状态的大小并不足以提供连续的真随机数流。因此，在需要真随机数时必须启用连续的熵源。

---

---

**备注：** 如果应用程序需要真随机数源，但无法永久性地启用硬件熵源，可以考虑使用软件 DRBG（确定性随机数发生器）来实现，如 mbedTLS CTR-DRBG 或 HMAC-DRBG，并使用来自硬件 RNG 真随机数来获取初始熵。

---

## 二级熵源

ESP32-H2 RNG 包含一个基于异步 8 MHz 内部振荡器采样的二级熵源（详情请参阅技术参考手册）。该熵源在 ESP-IDF 中始终处于启用状态，并通过硬件持续混合到 RNG 状态中。在测试中，即使在不启用主熵源时，这个二级熵源也足以通过 Dieharder 随机数测试套件（测试输入数据是通过连续重置 ESP32-H2 生成短样本并将其拼接来创建的）。但是，目前只有在同时启用上文所述的主熵源时，才能保证产生真随机数。

## API 参考

### Header File

- [components/esp\\_hw\\_support/include/esp\\_random.h](#)
- This header file can be included with:

```
#include "esp_random.h"
```

### Functions

uint32\_t **esp\_random** (void)

Get one random 32-bit word from hardware RNG.

If Wi-Fi or Bluetooth are enabled, this function returns true random numbers. In other situations, if true random numbers are required then consult the ESP-IDF Programming Guide "Random Number Generation" section for necessary prerequisites.

This function automatically busy-waits to ensure enough external entropy has been introduced into the hardware RNG state, before returning a new random number. This delay is very short (always less than 100 CPU cycles).

**返回** Random value between 0 and UINT32\_MAX

void **esp\_fill\_random** (void \*buf, size\_t len)

Fill a buffer with random bytes from hardware RNG.

---

**备注：** This function is implemented via calls to esp\_random(), so the same constraints apply.

---

### 参数

- **buf** -- Pointer to buffer to fill with random numbers.
- **len** -- Length of buffer in bytes

### Header File

- [components/bootloader\\_support/include/bootloader\\_random.h](#)
- This header file can be included with:

```
#include "bootloader_random.h"
```

- This header file is a part of the API provided by the bootloader\_support component. To declare that your component depends on bootloader\_support, add the following to your CMakeLists.txt:

```
REQUIRES bootloader_support
```

or

```
PRIV_REQUIRES bootloader_support
```

## Functions

void **bootloader\_random\_enable** (void)

Enable an entropy source for RNG if RF subsystem is disabled.

The exact internal entropy source mechanism depends on the chip in use but all SoCs use the SAR ADC to continuously mix random bits (an internal noise reading) into the HWRNG. Consult the SoC Technical Reference Manual for more information.

Can also be called from app code, if true random numbers are required without initialized RF subsystem. This might be the case in early startup code of the application when the RF subsystem has not started yet or if the RF subsystem should not be enabled for power saving.

Consult ESP-IDF Programming Guide "Random Number Generation" section for details.

**警告:** This function is not safe to use if any other subsystem is accessing the RF subsystem or the ADC at the same time!

void **bootloader\_random\_disable** (void)

Disable entropy source for RNG.

Disables internal entropy source. Must be called after `bootloader_random_enable()` and before RF subsystem features, ADC, or I2S (ESP32 only) are initialized.

Consult the ESP-IDF Programming Guide "Random Number Generation" section for details.

void **bootloader\_fill\_random** (void \*buffer, size\_t length)

Fill buffer with 'length' random bytes.

**备注:** If this function is being called from app code only, and never from the bootloader, then it's better to call `esp_fill_random()`.

### 参数

- **buffer** -- Pointer to buffer
- **length** -- This many bytes of random data will be copied to buffer

## getrandom()

为方便移植，还提供了与 Linux 的 `getrandom()` 函数兼容的版本：

```
#include <sys/random.h>

ssize_t getrandom(void *buf, size_t buflen, unsigned int flags);
```

此函数通过内部调用 `esp_fill_random()` 来实现。

`flags` 参数将被忽略。该函数始终是非阻塞的，但随机数的强度取决于本文档所述条件。

如果 `buf` 参数为 `NULL`，返回值为 `-1`，并将 `errno` 设置为 `EFAULT`。否则返回 `buflen`。

## getentropy()

为了便于移植，还提供了与 Linux 的 `getentropy()` 函数兼容的版本：

```
#include <unistd.h>

int getentropy(void *buffer, size_t length);
```

此函数通过内部调用 `getrandom()` 实现。

随机数强度取决于本文档所述条件。

如果执行成功则返回 0，否则返回 -1，同时：

- 如果 `buffer` 参数为 NULL，`errno` 设置为 EFAULT。
- 如果 `length` 超过 256，`errno` 设置为 EIO。

## 2.10.26 睡眠模式

### 概述

ESP32-H2 具有 Light-sleep 和 Deep-sleep 两种睡眠节能模式。根据应用所使用的功能，还有一些细分的子睡眠模式。关于这些睡眠模式和其子模式，参见[睡眠节能模式](#)。另外，还可以配置一些断电选项来进一步减少功耗，请参见[断电选项](#)。

睡眠模式有多种唤醒源。这些唤醒源也可以组合在一起，此时任何一个唤醒源都可以触发唤醒。[唤醒源](#)详细描述了这些唤醒源，以及配置 API。

断电选项和唤醒源的配置不是必要的，并且可以在进入睡眠模式前的任意时候进行。

最后，应用通过调用开始睡眠的 API 来使芯片进入其中一种睡眠模式，更多详情请参见[进入睡眠模式](#)。当唤醒条件满足，芯片就会从睡眠中被唤醒。关于如何获取唤醒原因，请参见[检查睡眠唤醒原因](#)。关于醒来后如何处理唤醒源，请参见[禁用睡眠模式唤醒源](#)。

### 睡眠节能模式

在 Light-sleep 模式下，数字外设、CPU、以及大部分 RAM 都使用时钟门控，同时其供电电压降低。退出该模式后，数字外设、CPU 和 RAM 恢复运行，并且内部状态将被保留。

在 Deep-sleep 模式下，CPU、大部分 RAM、以及所有由时钟 APB\_CLK 驱动的数字外设都会被断电。芯片上继续处于供电状态的部分仅包括：

- RTC 控制器
- RTC 高速内存

**睡眠模式下的 Wi-Fi 和 Bluetooth 功能** 在 Light-sleep 和 Deep-sleep 模式下，无线外设会被断电。因此，在进入这两种睡眠模式前，应用程序必须调用恰当的函数 (`nimble_port_stop()`、`nimble_port_deinit()`、`esp_bluedroid_disable()`、`esp_bluedroid_deinit()`、`esp_bt_controller_disable()`、`esp_bt_controller_deinit()` 或 `esp_wifi_stop()`) 来禁用 Wi-Fi 和 Bluetooth。在 Light-sleep 或 Deep-sleep 模式下，即使不调用这些函数也无法连接 Wi-Fi 和 Bluetooth。

如需保持 Wi-Fi 和 Bluetooth 连接，请启用 Wi-Fi 和 Bluetooth Modem-sleep 模式和自动 Light-sleep 模式（请参阅[电源管理 API](#)）。在这两种模式下，Wi-Fi 和 Bluetooth 驱动程序发出请求时，系统将自动从睡眠中被唤醒，从而保持连接。

## 唤醒源

通过 API `esp_sleep_enable_x_wakeup` 可启用唤醒源。唤醒源在芯片被唤醒后并不会被禁用，若你不再需要某些唤醒源，可通过 API `esp_sleep_disable_wakeup_source()` 将其禁用，详见[禁用睡眠模式唤醒源](#)。

以下是 ESP32-H2 所支持的唤醒源。

**定时器** RTC 控制器中内嵌定时器，可用于在预定义的时间到达后唤醒芯片。时间精度为微秒，但其实际分辨率依赖于为 `RTC_SLOW_CLK` 所选择的时钟源。

在这种唤醒模式下，无需为睡眠模式中的 RTC 外设或内存供电。

调用 `esp_sleep_enable_timer_wakeup()` 函数可启用使用定时器唤醒睡眠模式。

**外部唤醒 (ext1)** RTC 控制器中包含使用多个 RTC GPIO 触发唤醒的逻辑。从以下两个逻辑函数中任选其一，均可触发 ext1 唤醒：

- 当任意一个所选管脚为高电平时唤醒 (`ESP_EXT1_WAKEUP_ANY_HIGH`)
- 当任意一个所选管脚为低电平时唤醒 (`ESP_EXT1_WAKEUP_ANY_LOW`)

此唤醒源由 RTC 控制器实现。区别于 ext0 唤醒源，在 RTC 外设断电的情况下此唤醒源同样支持唤醒。虽然睡眠期间 RTC IO 所在的 RTC 外设电源域将会断电，但是 ESP-IDF 会自动在系统进入睡眠前锁定唤醒管脚的状态并在退出睡眠时解除锁定，所以仍然可为唤醒管脚配置内部上拉或下拉电阻：

```
esp_sleep_pd_config(ESP_PD_DOMAIN_RTC_PERIPH, ESP_PD_OPTION_ON);
gpio_pullup_dis(gpio_num);
gpiopulldown_en(gpio_num);
```

如果我们关闭 `RTC_PERIPH` 域，我们将使用 `HOLD` 功能在睡眠期间维持管脚上的上拉和下拉电阻。所选管脚的 `HOLD` 功能会在系统真正进入睡眠前被开启，这有助于进一步减小睡眠时的功耗：

```
rtc_gpio_pullup_dis(gpio_num);
rtc_gpio_pulldown_en(gpio_num);
```

如果某些芯片缺少 `RTC_PERIPH` 域，我们只能使用 `HOLD` 功能来在睡眠期间维持管脚上的上拉和下拉电阻：

```
gpio_pullup_dis(gpio_num);
gpiopulldown_en(gpio_num);
```

可调用 `esp_sleep_enable_ext1_wakeup_io()` 函数可用于增加 ext1 唤醒 IO 并设置相应的唤醒电平。

可调用 `esp_sleep_disable_ext1_wakeup_io()` 函数可用于移除 ext1 唤醒 IO。

当前的 RTC 控制器也包含更强大的逻辑，允许配置的 IO 同时使用不同的唤醒电平。这可以通过 `esp_sleep_enable_ext1_wakeup_io()` 函数来进行配置。

### 警告：

- 使用 EXT1 唤醒源时，用于唤醒的 IO pad 将被配置为 RTC IO。因此，在将该 pad 用作数字 GPIO 之前，请调用 `rtc_gpio_deinit()` 函数对其进行重新配置。
- RTC 外设默认情况下配置为断电，此时，唤醒 IO 在进入睡眠状态前将被设置为保持状态。因此，从 Light-sleep 状态唤醒芯片后，请调用 `rtc_gpio_hold_dis` 来禁用保持功能，以便对管脚进行重新配置。对于 Deep-sleep 唤醒，此问题已经在应用启动阶段解决。



**GPIO 唤醒** 任何一个 IO 都可以用作外部输入管脚，将芯片从 Light-sleep 状态唤醒。调用 `gpio_wakeup_enable()` 函数可以将任意管脚单独配置为在高电平或低电平触发唤醒。此后，应调用 `esp_sleep_enable_gpio_wakeup()` 函数来启用此唤醒源。

此外，可将由 VDD3P3\_RTC 电源域供电的 IO 用于芯片的 Deep-sleep 唤醒。调用 `esp_deep_sleep_enable_gpio_wakeup()` 函数可以配置相应的唤醒管脚和唤醒触发电平，该函数用于启用相应管脚的 Deep-sleep 唤醒功能。

---

**备注:**

---

**UART 唤醒 (仅适用于 Light-sleep 模式)** 当 ESP32-H2 从外部设备接收 UART 输入时，通常需要在输入数据可用时唤醒芯片。UART 外设支持在 RX 管脚上观测到一定数量的上升沿时，将芯片从 Light-sleep 模式中唤醒。调用 `uart_set_wakeup_threshold()` 函数可设置被观测上升沿的数量。请注意，触发唤醒的字符（及该字符前的所有字符）在唤醒后不会被 UART 接收，因此在发送数据之前，外部设备通常需要首先向 ESP32-H2 额外发送一个字符以触发唤醒。

可调用 `esp_sleep_enable_uart_wakeup()` 函数来启用此唤醒源。

使用 UART 唤醒之后，在芯片 Active 模式下需要让 UART 接受一些数据用来清零内部的唤醒指示信号。不然的话，下一次 UART 唤醒的触发将只需要比配置的阈值少两个上升沿的数量。

---

**备注:** 在 Light-sleep 模式下,设置 Kconfig 选项 `CONFIG_PM_POWER_DOWN_PERIPHERAL_IN_LIGHT_SLEEP` 将使 UART 唤醒失效。

---

**禁用睡眠模式唤醒源** 调用 API `esp_sleep_disable_wakeup_source()` 可以禁用给定唤醒源的触发器，从而禁用该唤醒源。此外，如果将参数设置为 `ESP_SLEEP_WAKEUP_ALL`，该函数可用于禁用所有触发器。

## 断电选项

应用程序可以使用 API `esp_sleep_pd_config()` 强制 RTC 外设和 RTC 内存进入特定断电模式。在 Deep-sleep 模式下，你还可以通过隔离一些 IO 来进一步降低功耗。

**RTC 外设和内存断电** 默认情况下，调用函数 `esp_deep_sleep_start()` 和 `esp_light_sleep_start()` 后，所有唤醒源不需要的 RTC 电源域都会被断电。可调用函数 `esp_sleep_pd_config()` 来修改这一设置。

ESP32-H2 中只有 RTC 高速内存，因此，如果程序中的某些值被标记为 `RTC_DATA_ATTR`、`RTC_SLOW_ATTR` 或 `RTC_FAST_ATTR` 属性，那么所有这些值都将被存入 RTC 高速内存，默认情况下保持供电。如有需要，也可以使用函数 `esp_sleep_pd_config()` 对其进行修改。

**flash 断电** 默认情况下，调用函数 `esp_light_sleep_start()` 后，flash 不会断电，因为在 sleep 过程中断电 flash 存在风险。具体而言，flash 断电需要时间，但是在此期间，系统有可能被唤醒，导致 flash 重新被上电。此时，断电尚未完成又重新上电的硬件行为有可能导致 flash 无法正常工作。

理论上讲，在 flash 完全断电后可以仅唤醒系统，然而现实情况是 flash 断电所需的时间很难预测。如果用户为 flash 供电电路添加了滤波电容，断电所需时间可能会更长。此外，即使可以预知 flash 彻底断电所需的时间，有时也不能通过设置足够长的睡眠时间来确保 flash 断电的安全（比如，突发的异步唤醒源会使得实际的睡眠时间不可控）。

**警告:** 如果在 flash 的供电电路上添加了滤波电容，那么应当尽一切可能避免 flash 断电。

因为这些不可控的因素，ESP-IDF 很难保证 flash 断电的绝对安全。因此 ESP-IDF 不推荐用户断电 flash。对于一些功耗敏感型应用，可以通过设置 Kconfig 配置项 `CONFIG_ESP_SLEEP_FLASH_LEAKAGE_WORKAROUND` 来减少 Light-sleep 期间 flash 的功耗。这种方式在几乎所有场景下都要比断电 flash 更好，兼顾了安全性和功耗。

考虑到有些用户能够充分评估断电 flash 的风险，并希望通过断电 flash 来获得更低的功耗，因此 ESP-IDF 提供了两种断电 flash 的机制：

- 设置 Kconfig 配置项 `CONFIG_ESP_SLEEP_POWER_DOWN_FLASH` 将使 ESP-IDF 以一个严格的条件来断电 flash。严格的条件具体指的是，RTC timer 是唯一的唤醒源且睡眠时间比 flash 彻底断电所需时间更长。
- 调用函数 `esp_sleep_pd_config(ESP_PD_DOMAIN_VDDSDIO, ESP_PD_OPTION_OFF)` 将使 ESP-IDF 以一个宽松的条件来断电 flash。宽松的条件具体指的是 RTC timer 唤醒源未被使能或睡眠时间比 flash 彻底断电所需时间更长。

---

#### 备注：

- Light-sleep 模式下，ESP-IDF 没有提供保证 flash 一定会被断电的机制。
  - 不管用户的配置如何，函数 `esp_deep_sleep_start()` 都会强制断电 flash。
- 

**配置 IO (仅适用于 Deep-sleep)** 一些 ESP32-H2 IO 在默认情况下启用内部上拉或下拉电阻。如果这些管脚在 Deep-sleep 模式下中受外部电路驱动，电流流经这些上下拉电阻时，可能会增加电流消耗。

#### 进入睡眠模式

应用程序通过 API `esp_light_sleep_start()` 或 `esp_deep_sleep_start()` 进入 Light-sleep 或 Deep-sleep 模式。此时，系统将按照被请求的唤醒源和断电选项配置有关的 RTC 控制器参数。

允许在未配置唤醒源的情况下进入睡眠模式。在此情况下，芯片将一直处于睡眠模式，直到从外部被复位。

**UART 输出处理** 在进入睡眠模式之前，调用函数 `esp_deep_sleep_start()` 会冲刷掉 UART FIFO 缓存。

当使用函数 `esp_light_sleep_start()` 进入 Light-sleep 模式时，UART FIFO 将不会被冲刷。与之相反，UART 输出将被暂停，FIFO 中的剩余字符将在 Light-sleep 唤醒后被发送。

#### 检查睡眠唤醒原因

`esp_sleep_get_wakeup_cause()` 函数可用于检测是何种唤醒源在睡眠期间被触发。

对于 ext1 唤醒源，可以调用函数 `esp_sleep_get_ext1_wakeup_status()` 来确认触发唤醒的触摸管脚。

#### 应用程序示例

- `protocols/sntp`：如何实现 Deep-sleep 模式的基本功能，周期性唤醒 ESP 模块，以从 NTP 服务器获取时间。
- `wifi/power_save`：如何通过 Wi-Fi Modem-sleep 模式和自动 Light-sleep 模式保持 Wi-Fi 连接。
- `bluetooth/nimble/power_save`：如何通过 Bluetooth Modem-sleep 模式和自动 Light-sleep 模式保持 Bluetooth 连接。
- `system/deep_sleep`：如何通过多种芯片支持的唤醒源，如 RTC 定时器，GPIO，EXT0，EXT1，触摸传感器等，触发 Deep-sleep 唤醒。



- [system/light\\_sleep](#): 如何使用多种芯片支持的唤醒源, 如定时器, GPIO, 触摸传感器等, 触发 Light-sleep 唤醒。

## API 参考

### Header File

- [components/esp\\_hw\\_support/include/esp\\_sleep.h](#)
- This header file can be included with:

```
#include "esp_sleep.h"
```

### Functions

*esp\_err\_t* [esp\\_sleep\\_disable\\_wakeup\\_source](#) (*esp\_sleep\_source\_t* source)

Disable wakeup source.

This function is used to deactivate wake up trigger for source defined as parameter of the function.

See docs/sleep-modes.rst for details.

---

**备注:** This function does not modify wake up configuration in RTC. It will be performed in [esp\\_deep\\_sleep\\_start](#)/[esp\\_light\\_sleep\\_start](#) function.

---

**参数** **source** -- - number of source to disable of type [esp\\_sleep\\_source\\_t](#)

**返回**

- ESP\_OK on success
- ESP\_ERR\_INVALID\_STATE if trigger was not active

*esp\_err\_t* [esp\\_sleep\\_enable\\_timer\\_wakeup](#) (uint64\_t time\_in\_us)

Enable wakeup by timer.

**参数** **time\_in\_us** -- time before wakeup, in microseconds

**返回**

- ESP\_OK on success
- ESP\_ERR\_INVALID\_ARG if value is out of range (TBD)

bool [esp\\_sleep\\_is\\_valid\\_wakeup\\_gpio](#) (gpio\_num\_t gpio\_num)

Returns true if a GPIO number is valid for use as wakeup source.

---

**备注:** For SoCs with RTC IO capability, this can be any valid RTC IO input pin.

---

**参数** **gpio\_num** -- Number of the GPIO to test for wakeup source capability

**返回** True if this GPIO number will be accepted as a sleep wakeup source.

*esp\_err\_t* [esp\\_sleep\\_enable\\_ext1\\_wakeup](#) (uint64\_t io\_mask, [esp\\_sleep\\_ext1\\_wakeup\\_mode\\_t](#) level\_mode)

Enable wakeup using multiple pins.

This function uses external wakeup feature of RTC controller. It will work even if RTC peripherals are shut down during sleep.

This feature can monitor any number of pins which are in RTC IOs. Once selected pins go into the state given by level\_mode argument, the chip will be woken up.

---

**备注:** This function does not modify pin configuration. The pins are configured in `esp_deep_sleep_start/esp_light_sleep_start`, immediately before entering sleep mode.

---

**备注:** Internal pullups and pulldowns don't work when RTC peripherals are shut down. In this case, external resistors need to be added. Alternatively, RTC peripherals (and pullups/pulldowns) may be kept enabled using `esp_sleep_pd_config` function. If we turn off the `RTC_PERIPH` domain or certain chips lack the `RTC_PERIPH` domain, we will use the HOLD feature to maintain the pull-up and pull-down on the pins during sleep. HOLD feature will be acted on the pin internally before the system entering sleep, and this can further reduce power consumption.

---

**备注:** Call this func will reset the previous ext1 configuration.

---

**备注:** This function will be deprecated in release/v6.0. Please switch to use `esp_sleep_enable_ext1_wakeup_io` and `esp_sleep_disable_ext1_wakeup_io`

---

### 参数

- **io\_mask** -- Bit mask of GPIO numbers which will cause wakeup. Only GPIOs which have RTC functionality can be used in this bit map. For different SoCs, the related GPIOs are:
  - ESP32: 0, 2, 4, 12-15, 25-27, 32-39
  - ESP32-S2: 0-21
  - ESP32-S3: 0-21
  - ESP32-C6: 0-7
  - ESP32-H2: 7-14
- **level\_mode** -- Select logic function used to determine wakeup condition: When target chip is ESP32:
  - `ESP_EXT1_WAKEUP_ALL_LOW`: wake up when all selected GPIOs are low
  - `ESP_EXT1_WAKEUP_ANY_HIGH`: wake up when any of the selected GPIOs is high
 When target chip is ESP32-S2, ESP32-S3, ESP32-C6 or ESP32-H2:
  - `ESP_EXT1_WAKEUP_ANY_LOW`: wake up when any of the selected GPIOs is low
  - `ESP_EXT1_WAKEUP_ANY_HIGH`: wake up when any of the selected GPIOs is high

### 返回

- `ESP_OK` on success
- `ESP_ERR_INVALID_ARG` if `io_mask` is zero,, or `mode` is invalid

`esp_err_t esp_sleep_enable_ext1_wakeup_io` (uint64\_t io\_mask, `esp_sleep_ext1_wakeup_mode_t` level\_mode)

Enable ext1 wakeup pins with IO masks.

This will append selected IOs to the wakeup IOs, it will not reset previously enabled IOs. To reset specific previously enabled IOs, call `esp_sleep_disable_ext1_wakeup_io` with the `io_mask`. To reset all the enabled IOs, call `esp_sleep_disable_ext1_wakeup_io(0)`.

This function uses external wakeup feature of RTC controller. It will work even if RTC peripherals are shut down during sleep.

This feature can monitor any number of pins which are in RTC IOs. Once selected pins go into the state given by `level_mode` argument, the chip will be woken up.

---

**备注:** This function does not modify pin configuration. The pins are configured in `esp_deep_sleep_start/esp_light_sleep_start`, immediately before entering sleep mode.

---

---

**备注:** Internal pullups and pulldowns don't work when RTC peripherals are shut down. In this case, external resistors need to be added. Alternatively, RTC peripherals (and pullups/pulldowns) may be kept enabled using `esp_sleep_pd_config` function. If we turn off the `RTC_PERIPH` domain or certain chips lack the `RTC_PERIPH` domain, we will use the HOLD feature to maintain the pull-up and pull-down on the pins during sleep. HOLD feature will be acted on the pin internally before the system entering sleep, and this can further reduce power consumption.

---

**参数**

- **io\_mask** -- Bit mask of GPIO numbers which will cause wakeup. Only GPIOs which have RTC functionality can be used in this bit map. For different SoCs, the related GPIOs are:
  - ESP32: 0, 2, 4, 12-15, 25-27, 32-39
  - ESP32-S2: 0-21
  - ESP32-S3: 0-21
  - ESP32-C6: 0-7
  - ESP32-H2: 7-14
- **level\_mode** -- Select logic function used to determine wakeup condition: When target chip is ESP32:
  - `ESP_EXT1_WAKEUP_ALL_LOW`: wake up when all selected GPIOs are low
  - `ESP_EXT1_WAKEUP_ANY_HIGH`: wake up when any of the selected GPIOs is high
 When target chip is ESP32-S2, ESP32-S3, ESP32-C6 or ESP32-H2:
  - `ESP_EXT1_WAKEUP_ANY_LOW`: wake up when any of the selected GPIOs is low
  - `ESP_EXT1_WAKEUP_ANY_HIGH`: wake up when any of the selected GPIOs is high

**返回**

- `ESP_OK` on success
- `ESP_ERR_INVALID_ARG` if any of the selected GPIOs is not an RTC GPIO, or mode is invalid
- `ESP_ERR_NOT_ALLOWED` when wakeup level will become different between ext1 IOs if `!SOC_PM_SUPPORT_EXT1_WAKEUP_MODE_PER_PIN`

*esp\_err\_t* `esp_sleep_disable_ext1_wakeup_io` (uint64\_t io\_mask)

Disable ext1 wakeup pins with IO masks. This will remove selected IOs from the wakeup IOs.

**参数** **io\_mask** -- Bit mask of GPIO numbers which will cause wakeup. Only GPIOs which have RTC functionality can be used in this bit map. If value is zero, this func will remove all previous ext1 configuration. For different SoCs, the related GPIOs are:

- ESP32: 0, 2, 4, 12-15, 25-27, 32-39
- ESP32-S2: 0-21
- ESP32-S3: 0-21
- ESP32-C6: 0-7
- ESP32-H2: 7-14

**返回**

- `ESP_OK` on success
- `ESP_ERR_INVALID_ARG` if any of the selected GPIOs is not an RTC GPIO.

*esp\_err\_t* `esp_sleep_enable_ext1_wakeup_with_level_mask` (uint64\_t io\_mask, uint64\_t level\_mask)

Enable wakeup using multiple pins, allows different trigger mode per pin.

This function uses external wakeup feature of RTC controller. It will work even if RTC peripherals are shut down during sleep.

This feature can monitor any number of pins which are in RTC IOs. Once selected pins go into the state given by `level_mode` argument, the chip will be woken up.

---

**备注:** This function does not modify pin configuration. The pins are configured in

`esp_deep_sleep_start/esp_light_sleep_start`, immediately before entering sleep mode.

---

**备注:** Internal pullups and pulldowns don't work when RTC peripherals are shut down. In this case, external resistors need to be added. Alternatively, RTC peripherals (and pullups/pulldowns) may be kept enabled using `esp_sleep_pd_config` function. If we turn off the `RTC_PERIPH` domain or certain chips lack the `RTC_PERIPH` domain, we will use the HOLD feature to maintain the pull-up and pull-down on the pins during sleep. HOLD feature will be acted on the pin internally before the system entering sleep, and this can further reduce power consumption.

---

#### 参数

- **io\_mask** -- Bit mask of GPIO numbers which will cause wakeup. Only GPIOs which have RTC functionality can be used in this bit map. For different SoCs, the related GPIOs are:
  - ESP32-C6: 0-7.
  - ESP32-H2: 7-14.
- **level\_mask** -- Select logic function used to determine wakeup condition per pin. Each bit of the `level_mask` corresponds to the respective GPIO. Each bit's corresponding position is set to 0, the wakeup level will be low, on the contrary, each bit's corresponding position is set to 1, the wakeup level will be high.

#### 返回

- ESP\_OK on success
- ESP\_ERR\_INVALID\_ARG if any of the selected GPIOs is not an RTC GPIO, or mode is invalid

*esp\_err\_t* `esp_sleep_enable_gpio_wakeup` (void)

Enable wakeup from light sleep using GPIOs.

Each GPIO supports wakeup function, which can be triggered on either low level or high level. Unlike EXT0 and EXT1 wakeup sources, this method can be used both for all IOs: RTC IOs and digital IOs. It can only be used to wakeup from light sleep though.

To enable wakeup, first call `gpio_wakeup_enable`, specifying gpio number and wakeup level, for each GPIO which is used for wakeup. Then call this function to enable wakeup feature.

---

**备注:** On ESP32, GPIO wakeup source can not be used together with touch or ULP wakeup sources.

---

#### 返回

- ESP\_OK on success
- ESP\_ERR\_INVALID\_STATE if wakeup triggers conflict

*esp\_err\_t* `esp_sleep_enable_uart_wakeup` (int uart\_num)

Enable wakeup from light sleep using UART.

Use `uart_set_wakeup_threshold` function to configure UART wakeup threshold.

Wakeup from light sleep takes some time, so not every character sent to the UART can be received by the application.

---

**备注:** ESP32 does not support wakeup from UART2.

---

参数 **uart\_num** -- UART port to wake up from

#### 返回

- ESP\_OK on success
- ESP\_ERR\_INVALID\_ARG if wakeup from given UART is not supported

*esp\_err\_t* **esp\_sleep\_enable\_bt\_wakeup** (void)

Enable wakeup by bluetooth.

返回

- ESP\_OK on success
- ESP\_ERR\_NOT\_SUPPORTED if wakeup from bluetooth is not supported

*esp\_err\_t* **esp\_sleep\_disable\_bt\_wakeup** (void)

Disable wakeup by bluetooth.

返回

- ESP\_OK on success
- ESP\_ERR\_NOT\_SUPPORTED if wakeup from bluetooth is not supported

*esp\_err\_t* **esp\_sleep\_enable\_wifi\_wakeup** (void)

Enable wakeup by WiFi MAC.

返回

- ESP\_OK on success

*esp\_err\_t* **esp\_sleep\_disable\_wifi\_wakeup** (void)

Disable wakeup by WiFi MAC.

返回

- ESP\_OK on success

*esp\_err\_t* **esp\_sleep\_enable\_wifi\_beacon\_wakeup** (void)

Enable beacon wakeup by WiFi MAC, it will wake up the system into modem state.

返回

- ESP\_OK on success

*esp\_err\_t* **esp\_sleep\_disable\_wifi\_beacon\_wakeup** (void)

Disable beacon wakeup by WiFi MAC.

返回

- ESP\_OK on success

uint64\_t **esp\_sleep\_get\_ext1\_wakeup\_status** (void)

Get the bit mask of GPIOs which caused wakeup (ext1)

If wakeup was caused by another source, this function will return 0.

返回 bit mask, if GPIO n caused wakeup, BIT(n) will be set

*esp\_err\_t* **esp\_sleep\_pd\_config** (*esp\_sleep\_pd\_domain\_t* domain, *esp\_sleep\_pd\_option\_t* option)

Set power down mode for an RTC power domain in sleep mode.

If not set using this API, all power domains default to ESP\_PD\_OPTION\_AUTO.

参数

- **domain** -- power domain to configure
- **option** -- power down option (ESP\_PD\_OPTION\_OFF, ESP\_PD\_OPTION\_ON, or ESP\_PD\_OPTION\_AUTO)

返回

- ESP\_OK on success
- ESP\_ERR\_INVALID\_ARG if either of the arguments is out of range

*esp\_err\_t* **esp\_deep\_sleep\_try\_to\_start** (void)

Enter deep sleep with the configured wakeup options.

The reason for the rejection can be such as a short sleep time.

---

**备注:** In general, the function does not return, but if the sleep is rejected, then it returns from it.

---

**返回**

- No return - If the sleep is not rejected.
- ESP\_ERR\_SLEEP\_REJECT sleep request is rejected(wakeup source set before the sleep request)

void **esp\_deep\_sleep\_start** (void)

Enter deep sleep with the configured wakeup options.

---

**备注:** The function does not do a return (no rejection). Even if wakeup source set before the sleep request it goes to deep sleep anyway.

---

*esp\_err\_t* **esp\_light\_sleep\_start** (void)

Enter light sleep with the configured wakeup options.

**返回**

- ESP\_OK on success (returned after wakeup)
- ESP\_ERR\_SLEEP\_REJECT sleep request is rejected(wakeup source set before the sleep request)
- ESP\_ERR\_SLEEP\_TOO\_SHORT\_SLEEP\_DURATION after deducting the sleep flow overhead, the final sleep duration is too short to cover the minimum sleep duration of the chip, when rtc timer wakeup source enabled

*esp\_err\_t* **esp\_deep\_sleep\_try** (uint64\_t time\_in\_us)

Enter deep-sleep mode.

The device will automatically wake up after the deep-sleep time Upon waking up, the device calls deep sleep wake stub, and then proceeds to load application.

Call to this function is equivalent to a call to esp\_deep\_sleep\_enable\_timer\_wakeup followed by a call to esp\_deep\_sleep\_start.

The reason for the rejection can be such as a short sleep time.

---

**备注:** In general, the function does not return, but if the sleep is rejected, then it returns from it.

---

**参数** **time\_in\_us** -- deep-sleep time, unit: microsecond

**返回**

- No return - If the sleep is not rejected.
- ESP\_ERR\_SLEEP\_REJECT sleep request is rejected(wakeup source set before the sleep request)

void **esp\_deep\_sleep** (uint64\_t time\_in\_us)

Enter deep-sleep mode.

The device will automatically wake up after the deep-sleep time Upon waking up, the device calls deep sleep wake stub, and then proceeds to load application.

Call to this function is equivalent to a call to esp\_deep\_sleep\_enable\_timer\_wakeup followed by a call to esp\_deep\_sleep\_start.

---

**备注:** The function does not do a return (no rejection).. Even if wakeup source set before the sleep request it goes to deep sleep anyway.

---

**参数** `time_in_us` -- deep-sleep time, unit: microsecond

`esp_err_t esp_deep_sleep_register_hook(esp_deep_sleep_cb_t new_dslp_cb)`

Register a callback to be called from the deep sleep prepare.

**警告:** deepsleep callbacks should without parameters, and MUST NOT, UNDER ANY CIRCUMSTANCES, CALL A FUNCTION THAT MIGHT BLOCK.

**参数** `new_dslp_cb` -- Callback to be called

**返回**

- ESP\_OK: Callback registered to the deepsleep misc\_modules\_sleep\_prepare
- ESP\_ERR\_NO\_MEM: No more hook space for register the callback

void `esp_deep_sleep_deregister_hook(esp_deep_sleep_cb_t old_dslp_cb)`

Unregister an deepsleep callback.

**参数** `old_dslp_cb` -- Callback to be unregistered

`esp_sleep_wakeup_cause_t esp_sleep_get_wakeup_cause` (void)

Get the wakeup source which caused wakeup from sleep.

**返回** cause of wake up from last sleep (deep sleep or light sleep)

void `esp_wake_deep_sleep` (void)

Default stub to run on wake from deep sleep.

Allows for executing code immediately on wake from sleep, before the software bootloader or ESP-IDF app has started up.

This function is weak-linked, so you can implement your own version to run code immediately when the chip wakes from sleep.

See docs/deep-sleep-stub.rst for details.

void `esp_set_deep_sleep_wake_stub(esp_deep_sleep_wake_stub_fn_t new_stub)`

Install a new stub at runtime to run on wake from deep sleep.

If implementing `esp_wake_deep_sleep()` then it is not necessary to call this function.

However, it is possible to call this function to substitute a different deep sleep stub. Any function used as a deep sleep stub must be marked `RTC_IRAM_ATTR`, and must obey the same rules given for `esp_wake_deep_sleep()`.

void `esp_set_deep_sleep_wake_stub_default_entry` (void)

Set wake stub entry to default `esp_wake_stub_entry`

`esp_deep_sleep_wake_stub_fn_t esp_get_deep_sleep_wake_stub` (void)

Get current wake from deep sleep stub.

**返回** Return current wake from deep sleep stub, or NULL if no stub is installed.

void `esp_default_wake_deep_sleep` (void)

The default esp-idf-provided `esp_wake_deep_sleep()` stub.

See docs/deep-sleep-stub.rst for details.

void **esp\_deep\_sleep\_disable\_rom\_logging** (void)

Disable logging from the ROM code after deep sleep.

Using LSB of RTC\_STORE4.

*esp\_err\_t* **esp\_sleep\_cpu\_retention\_init** (void)

CPU Power down initialize.

返回

- ESP\_OK on success
- ESP\_ERR\_NO\_MEM not enough retention memory

*esp\_err\_t* **esp\_sleep\_cpu\_retention\_deinit** (void)

CPU Power down de-initialize.

Release system retention memory.

返回

- ESP\_OK on success

void **esp\_sleep\_config\_gpio\_isolate** (void)

Configure to isolate all GPIO pins in sleep state.

void **esp\_sleep\_enable\_gpio\_switch** (bool enable)

Enable or disable GPIO pins status switching between slept status and waked status.

参数 **enable** -- decide whether to switch status or not

## Macros

**ESP\_PD\_DOMAIN\_RTC8M**

**ESP\_SLEEP\_POWER\_DOWN\_CPU**

## Type Definitions

typedef void (\***esp\_deep\_sleep\_cb\_t**)(void)

typedef *esp\_sleep\_source\_t* **esp\_sleep\_wakeup\_cause\_t**

typedef void (\***esp\_deep\_sleep\_wake\_stub\_fn\_t**)(void)

Function type for stub to run on wake from sleep.

## Enumerations

enum **esp\_sleep\_ext1\_wakeup\_mode\_t**

Logic function used for EXT1 wakeup mode.

*Values:*

enumerator **ESP\_EXT1\_WAKEUP\_ANY\_LOW**

Wake the chip when any of the selected GPIOs go low.

enumerator **ESP\_EXT1\_WAKEUP\_ANY\_HIGH**

Wake the chip when any of the selected GPIOs go high.



enumerator **ESP\_EXT1\_WAKEUP\_ALL\_LOW**

enum **esp\_sleep\_pd\_domain\_t**

Power domains which can be powered down in sleep mode.

*Values:*

enumerator **ESP\_PD\_DOMAIN\_XTAL**

XTAL oscillator.

enumerator **ESP\_PD\_DOMAIN\_XTAL32K**

External 32 kHz XTAL oscillator.

enumerator **ESP\_PD\_DOMAIN\_RC32K**

Internal 32 kHz RC oscillator.

enumerator **ESP\_PD\_DOMAIN\_RC\_FAST**

Internal Fast oscillator.

enumerator **ESP\_PD\_DOMAIN\_CPU**

CPU core.

enumerator **ESP\_PD\_DOMAIN\_VDDSDIO**

VDD\_SDIO.

enumerator **ESP\_PD\_DOMAIN\_MODEM**

MODEM, includes WiFi, Bluetooth and IEEE802.15.4.

enumerator **ESP\_PD\_DOMAIN\_TOP**

SoC TOP.

enumerator **ESP\_PD\_DOMAIN\_MAX**

Number of domains.

enum **esp\_sleep\_pd\_option\_t**

Power down options.

*Values:*

enumerator **ESP\_PD\_OPTION\_OFF**

Power down the power domain in sleep mode.

enumerator **ESP\_PD\_OPTION\_ON**

Keep power domain enabled during sleep mode.

enumerator **ESP\_PD\_OPTION\_AUTO**

Keep power domain enabled in sleep mode, if it is needed by one of the wakeup options. Otherwise power it down.

enum **esp\_sleep\_source\_t**

Sleep wakeup cause.

*Values:*

enumerator **ESP\_SLEEP\_WAKEUP\_UNDEFINED**

In case of deep sleep, reset was not caused by exit from deep sleep.

enumerator **ESP\_SLEEP\_WAKEUP\_ALL**

Not a wakeup cause, used to disable all wakeup sources with `esp_sleep_disable_wakeup_source`.

enumerator **ESP\_SLEEP\_WAKEUP\_EXT0**

Wakeup caused by external signal using `RTC_IO`.

enumerator **ESP\_SLEEP\_WAKEUP\_EXT1**

Wakeup caused by external signal using `RTC_CNTL`.

enumerator **ESP\_SLEEP\_WAKEUP\_TIMER**

Wakeup caused by timer.

enumerator **ESP\_SLEEP\_WAKEUP\_TOUCHPAD**

Wakeup caused by touchpad.

enumerator **ESP\_SLEEP\_WAKEUP\_ULP**

Wakeup caused by ULP program.

enumerator **ESP\_SLEEP\_WAKEUP\_GPIO**

Wakeup caused by GPIO (light sleep only on ESP32, S2 and S3)

enumerator **ESP\_SLEEP\_WAKEUP\_UART**

Wakeup caused by UART (light sleep only)

enumerator **ESP\_SLEEP\_WAKEUP\_WIFI**

Wakeup caused by WIFI (light sleep only)

enumerator **ESP\_SLEEP\_WAKEUP\_COCPU**

Wakeup caused by COCPU int.

enumerator **ESP\_SLEEP\_WAKEUP\_COCPU\_TRAP\_TRIG**

Wakeup caused by COCPU crash.

enumerator **ESP\_SLEEP\_WAKEUP\_BT**

Wakeup caused by BT (light sleep only)

enum **esp\_sleep\_mode\_t**

Sleep mode.

*Values:*

enumerator **ESP\_SLEEP\_MODE\_LIGHT\_SLEEP**

light sleep mode

enumerator **ESP\_SLEEP\_MODE\_DEEP\_SLEEP**

deep sleep mode

enum [**anonymous**]

*Values:*

enumerator **ESP\_ERR\_SLEEP\_REJECT**

enumerator **ESP\_ERR\_SLEEP\_TOO\_SHORT\_SLEEP\_DURATION**

### 2.10.27 SoC 功能

此文档介绍了 ESP32-H2 SoC 硬件功能的宏定义。ESP-IDF 中的条件编译指令通常使用这些宏来确定哪些依赖于硬件的功能受到支持，从而控制需编译的代码内容。

---

**备注：**目前，这些宏定义不属于公共 API，未来可能发生重大更改。如需了解详情，请前往[ESP-IDF 版本简介](#)。

---

## API 参考

### Header File

- [components/soc/esp32h2/include/soc/soc\\_caps.h](#)
- This header file can be included with:

```
#include "soc/soc_caps.h"
```

### Macros

**SOC\_ADC\_SUPPORTED**

**SOC\_ANA\_CMPR\_SUPPORTED**

**SOC\_DEDICATED\_GPIO\_SUPPORTED**

**SOC\_UART\_SUPPORTED**

**SOC\_GDMA\_SUPPORTED**

**SOC\_AHB\_GDMA\_SUPPORTED**

**SOC\_ASYNC\_MEMCPY\_SUPPORTED**

SOC\_PCNT\_SUPPORTED

SOC\_MCPWM\_SUPPORTED

SOC\_TWAI\_SUPPORTED

SOC\_PHY\_SUPPORTED

SOC\_BT\_SUPPORTED

SOC\_GPTIMER\_SUPPORTED

SOC\_IEEE802154\_SUPPORTED

SOC\_IEEE802154\_BLE\_ONLY

SOC\_USB\_SERIAL\_JTAG\_SUPPORTED

SOC\_TEMP\_SENSOR\_SUPPORTED

SOC\_SUPPORTS\_SECURE\_DL\_MODE

SOC\_EFUSE\_KEY\_PURPOSE\_FIELD

SOC\_EFUSE\_SUPPORTED

SOC\_RTC\_FAST\_MEM\_SUPPORTED

SOC\_RTC\_MEM\_SUPPORTED

SOC\_I2S\_SUPPORTED

SOC\_SDM\_SUPPORTED

SOC\_ETM\_SUPPORTED

SOC\_RMT\_SUPPORTED

SOC\_PARLIO\_SUPPORTED

SOC\_GPSPI\_SUPPORTED

SOC\_LEDC\_SUPPORTED

SOC\_I2C\_SUPPORTED

SOC\_SYSTIMER\_SUPPORTED

SOC\_SUPPORT\_COEXISTENCE

SOC\_AES\_SUPPORTED

SOC\_MPI\_SUPPORTED

SOC\_SHA\_SUPPORTED

SOC\_HMAC\_SUPPORTED

SOC\_DIG\_SIGN\_SUPPORTED

SOC\_ECC\_SUPPORTED

SOC\_ECC\_EXTENDED\_MODES\_SUPPORTED

SOC\_ECDSA\_SUPPORTED

SOC\_FLASH\_ENC\_SUPPORTED

SOC\_SECURE\_BOOT\_SUPPORTED

SOC\_BOD\_SUPPORTED

SOC\_APM\_SUPPORTED

SOC\_APM\_CTRL\_FILTER\_SUPPORTED

SOC\_PMU\_SUPPORTED

SOC\_LP\_TIMER\_SUPPORTED

SOC\_LP\_AON\_SUPPORTED

SOC\_PAU\_SUPPORTED

SOC\_CLK\_TREE\_SUPPORTED

SOC\_ASSIST\_DEBUG\_SUPPORTED

SOC\_WDT\_SUPPORTED

SOC\_SPI\_FLASH\_SUPPORTED

**SOC\_RNG\_SUPPORTED**

**SOC\_LIGHT\_SLEEP\_SUPPORTED**

**SOC\_DEEP\_SLEEP\_SUPPORTED**

**SOC\_MODEM\_CLOCK\_SUPPORTED**

**SOC\_PM\_SUPPORTED**

**SOC\_XTAL\_SUPPORT\_32M**

**SOC\_AES\_SUPPORT\_DMA**

**SOC\_AES\_GDMA**

**SOC\_AES\_SUPPORT\_AES\_128**

**SOC\_AES\_SUPPORT\_AES\_256**

**SOC\_ADC\_DIG\_CTRL\_SUPPORTED**

< SAR ADC Module

**SOC\_ADC\_DIG\_IIR\_FILTER\_SUPPORTED**

**SOC\_ADC\_MONITOR\_SUPPORTED**

**SOC\_ADC\_DIG\_SUPPORTED\_UNIT (UNIT)**

**SOC\_ADC\_DMA\_SUPPORTED**

**SOC\_ADC\_PERIPH\_NUM**

**SOC\_ADC\_CHANNEL\_NUM (PERIPH\_NUM)**

**SOC\_ADC\_MAX\_CHANNEL\_NUM**

**SOC\_ADC\_ATTEN\_NUM**

Digital

**SOC\_ADC\_DIGI\_CONTROLLER\_NUM**

**SOC\_ADC\_PATT\_LEN\_MAX**

One pattern table, each contains 8 items. Each item takes 1 byte

**SOC\_ADC\_DIGI\_MAX\_BITWIDTH**

**SOC\_ADC\_DIGI\_MIN\_BITWIDTH**

**SOC\_ADC\_DIGI\_IIR\_FILTER\_NUM**

**SOC\_ADC\_DIGI\_MONITOR\_NUM**

**SOC\_ADC\_DIGI\_RESULT\_BYTES**

**SOC\_ADC\_DIGI\_DATA\_BYTES\_PER\_CONV**

$F_{\text{sample}} = F_{\text{digi\_con}} / 2 / \text{interval}$ .  $F_{\text{digi\_con}} = 5\text{M}$  for now.  $30 \leq \text{interval} \leq 4095$

**SOC\_ADC\_SAMPLE\_FREQ\_THRES\_HIGH**

**SOC\_ADC\_SAMPLE\_FREQ\_THRES\_LOW**

RTC

**SOC\_ADC\_RTC\_MIN\_BITWIDTH**

**SOC\_ADC\_RTC\_MAX\_BITWIDTH**

Calibration

**SOC\_ADC\_CALIBRATION\_V1\_SUPPORTED**

support HW offset calibration version 1

**SOC\_ADC\_SELF\_HW\_CALI\_SUPPORTED**

support HW offset self calibration

**SOC\_ADC\_CALIB\_CHAN\_COMPENS\_SUPPORTED**

support channel compensation to the HW offset calibration Interrupt

**SOC\_ADC\_TEMPERATURE\_SHARE\_INTR**

ADC power control is shared by PWDET

**SOC\_ADC\_SHARED\_POWER**

**SOC\_APB\_BACKUP\_DMA**

**SOC\_BROWNOUT\_RESET\_SUPPORTED**

**SOC\_SHARED\_IDCACHE\_SUPPORTED**

**SOC\_CACHE\_FREEZE\_SUPPORTED**

**SOC\_CPU\_CORES\_NUM**

**SOC\_CPU\_INTR\_NUM**

**SOC\_CPU\_HAS\_FLEXIBLE\_INTC**

**SOC\_INT\_PLIC\_SUPPORTED**

**SOC\_CPU\_HAS\_CSR\_PC**

**SOC\_CPU\_BREAKPOINTS\_NUM**

**SOC\_CPU\_WATCHPOINTS\_NUM**

**SOC\_CPU\_WATCHPOINT\_MAX\_REGION\_SIZE**

**SOC\_CPU\_HAS\_PMA**

**SOC\_CPU\_IDRAM\_SPLIT\_USING\_PMP**

**SOC\_MMU\_PAGE\_SIZE\_CONFIGURABLE**

**SOC\_MMU\_PERIPH\_NUM**

**SOC\_MMU\_LINEAR\_ADDRESS\_REGION\_NUM**

**SOC\_MMU\_DI\_VADDR\_SHARED**

D/I vaddr are shared

**SOC\_DS\_SIGNATURE\_MAX\_BIT\_LEN**

The maximum length of a Digital Signature in bits.

**SOC\_DS\_KEY\_PARAM\_MD\_IV\_LENGTH**

Initialization vector (IV) length for the RSA key parameter message digest (MD) in bytes.

**SOC\_DS\_KEY\_CHECK\_MAX\_WAIT\_US**

Maximum wait time for DS parameter decryption key. If overdue, then key error. See TRM DS chapter for more details

**SOC\_AHB\_GDMA\_VERSION**

**SOC\_GDMA\_NUM\_GROUPS\_MAX**

**SOC\_GDMA\_PAIRS\_PER\_GROUP\_MAX**

**SOC\_GDMA\_SUPPORT\_ETM**

**SOC\_GDMA\_SUPPORT\_SLEEP\_RETENTION**

**SOC\_ETM\_GROUPS**



SOC\_ETM\_CHANNELS\_PER\_GROUP

SOC\_GPIO\_PORT

SOC\_GPIO\_PIN\_COUNT

SOC\_GPIO\_SUPPORT\_PIN\_GLITCH\_FILTER

SOC\_GPIO\_FLEX\_GLITCH\_FILTER\_NUM

SOC\_GPIO\_SUPPORT\_PIN\_HYS\_FILTER

SOC\_GPIO\_SUPPORT\_PIN\_HYS\_CTRL\_BY\_EFUSE

SOC\_GPIO\_SUPPORT\_ETM

SOC\_GPIO\_SUPPORT\_RTC\_INDEPENDENT

SOC\_LP\_IO\_CLOCK\_IS\_INDEPENDENT

SOC\_GPIO\_VALID\_GPIO\_MASK

SOC\_GPIO\_VALID\_OUTPUT\_GPIO\_MASK

SOC\_GPIO\_IN\_RANGE\_MAX

SOC\_GPIO\_OUT\_RANGE\_MAX

SOC\_GPIO\_VALID\_DIGITAL\_IO\_PAD\_MASK

SOC\_GPIO\_SUPPORT\_FORCE\_HOLD

SOC\_GPIO\_SUPPORT\_HOLD\_SINGLE\_IO\_IN\_DSLP

SOC\_GPIO\_CLOCKOUT\_BY\_GPIO\_MATRIX

SOC\_CLOCKOUT\_HAS\_SOURCE\_GATE

SOC\_GPIO\_CLOCKOUT\_CHANNEL\_NUM

SOC\_RTCIO\_PIN\_COUNT

SOC\_RTCIO\_HOLD\_SUPPORTED

SOC\_RTCIO\_VALID\_RTCIO\_MASK

**SOC\_DEDIC\_GPIO\_OUT\_CHANNELS\_NUM**

8 outward channels on each CPU core

**SOC\_DEDIC\_GPIO\_IN\_CHANNELS\_NUM**

8 inward channels on each CPU core

**SOC\_DEDIC\_PERIPH\_ALWAYS\_ENABLE**

The dedicated GPIO (a.k.a. fast GPIO) is featured by some customized CPU instructions, which is always enabled

**SOC\_ANA\_CMPR\_NUM**

**SOC\_ANA\_CMPR\_INTR\_SHARE\_WITH\_GPIO**

**SOC\_I2C\_NUM**

**SOC\_HP\_I2C\_NUM**

**SOC\_I2C\_FIFO\_LEN**

I2C hardware FIFO depth

**SOC\_I2C\_CMD\_REG\_NUM**

Number of I2C command registers

**SOC\_I2C\_SUPPORT\_SLAVE**

**SOC\_I2C\_SUPPORT\_HW\_FSM\_RST**

**SOC\_I2C\_SUPPORT\_HW\_CLR\_BUS**

**SOC\_I2C\_SUPPORT\_XTAL**

**SOC\_I2C\_SUPPORT\_RTC**

**SOC\_I2C\_SUPPORT\_10BIT\_ADDR**

**SOC\_I2C\_SLAVE\_SUPPORT\_BROADCAST**

**SOC\_I2C\_SLAVE\_CAN\_GET\_STRETCH\_CAUSE**

**SOC\_I2C\_SLAVE\_SUPPORT\_I2CRAM\_ACCESS**

**SOC\_I2C\_SLAVE\_SUPPORT\_SLAVE\_UNMATCH**

**SOC\_I2C\_SUPPORT\_SLEEP\_RETENTION**

SOC\_I2S\_NUM

SOC\_I2S\_HW\_VERSION\_2

SOC\_I2S\_SUPPORTS\_XTAL

SOC\_I2S\_SUPPORTS\_PLL\_F96M

SOC\_I2S\_SUPPORTS\_PLL\_F64M

SOC\_I2S\_SUPPORTS\_PCM

SOC\_I2S\_SUPPORTS\_PDM

SOC\_I2S\_SUPPORTS\_PDM\_TX

SOC\_I2S\_PDM\_MAX\_TX\_LINES

SOC\_I2S\_SUPPORTS\_TDM

SOC\_I2S\_TDM\_FULL\_DATA\_WIDTH

No limitation to data bit width when using multiple slots

SOC\_LEDC\_SUPPORT\_PLL\_DIV\_CLOCK

SOC\_LEDC\_SUPPORT\_XTAL\_CLOCK

SOC\_LEDC\_CHANNEL\_NUM

SOC\_LEDC\_TIMER\_BIT\_WIDTH

SOC\_LEDC\_SUPPORT\_FADE\_STOP

SOC\_LEDC\_GAMMA\_CURVE\_FADE\_SUPPORTED

SOC\_LEDC\_GAMMA\_CURVE\_FADE\_RANGE\_MAX

SOC\_LEDC\_FADE\_PARAMS\_BIT\_WIDTH

SOC\_MPU\_CONFIGURABLE\_REGIONS\_SUPPORTED

SOC\_MPU\_MIN\_REGION\_SIZE

SOC\_MPU\_REGIONS\_MAX\_NUM

**SOC\_MPU\_REGION\_RO\_SUPPORTED**

**SOC\_MPU\_REGION\_WO\_SUPPORTED**

**SOC\_PCNT\_GROUPS**

**SOC\_PCNT\_UNITS\_PER\_GROUP**

**SOC\_PCNT\_CHANNELS\_PER\_UNIT**

**SOC\_PCNT\_THRES\_POINT\_PER\_UNIT**

**SOC\_PCNT\_SUPPORT\_RUNTIME\_THRES\_UPDATE**

**SOC\_RMT\_GROUPS**

One RMT group

**SOC\_RMT\_TX\_CANDIDATES\_PER\_GROUP**

Number of channels that capable of Transmit

**SOC\_RMT\_RX\_CANDIDATES\_PER\_GROUP**

Number of channels that capable of Receive

**SOC\_RMT\_CHANNELS\_PER\_GROUP**

Total 4 channels

**SOC\_RMT\_MEM\_WORDS\_PER\_CHANNEL**

Each channel owns 48 words memory (1 word = 4 Bytes)

**SOC\_RMT\_SUPPORT\_RX\_PINGPONG**

Support Ping-Pong mode on RX path

**SOC\_RMT\_SUPPORT\_RX\_DEMODULATION**

Support signal demodulation on RX path (i.e. remove carrier)

**SOC\_RMT\_SUPPORT\_TX\_ASYNC\_STOP**

Support stop transmission asynchronously

**SOC\_RMT\_SUPPORT\_TX\_LOOP\_COUNT**

Support transmit specified number of cycles in loop mode

**SOC\_RMT\_SUPPORT\_TX\_LOOP\_AUTO\_STOP**

Hardware support of auto-stop in loop mode

**SOC\_RMT\_SUPPORT\_TX\_SYNCHRO**

Support coordinate a group of TX channels to start simultaneously

**SOC\_RMT\_SUPPORT\_TX\_CARRIER\_DATA\_ONLY**

TX carrier can be modulated to data phase only

**SOC\_RMT\_SUPPORT\_XTAL**

Support set XTAL clock as the RMT clock source

**SOC\_RMT\_SUPPORT\_RC\_FAST**

Support set RC\_FAST as the RMT clock source

**SOC\_MCPWM\_GROUPS**

1 MCPWM groups on the chip (i.e., the number of independent MCPWM peripherals)

**SOC\_MCPWM\_TIMERS\_PER\_GROUP**

The number of timers that each group has.

**SOC\_MCPWM\_OPERATORS\_PER\_GROUP**

The number of operators that each group has.

**SOC\_MCPWM\_COMPARATORS\_PER\_OPERATOR**

The number of comparators that each operator has.

**SOC\_MCPWM\_GENERATORS\_PER\_OPERATOR**

The number of generators that each operator has.

**SOC\_MCPWM\_TRIGGERS\_PER\_OPERATOR**

The number of triggers that each operator has.

**SOC\_MCPWM\_GPIO\_FAULTS\_PER\_GROUP**

The number of fault signal detectors that each group has.

**SOC\_MCPWM\_CAPTURE\_TIMERS\_PER\_GROUP**

The number of capture timers that each group has.

**SOC\_MCPWM\_CAPTURE\_CHANNELS\_PER\_TIMER**

The number of capture channels that each capture timer has.

**SOC\_MCPWM\_GPIO\_SYNCHROS\_PER\_GROUP**

The number of GPIO synchros that each group has.

**SOC\_MCPWM\_SWSYNC\_CAN\_PROPAGATE**

Software sync event can be routed to its output.

**SOC\_MCPWM\_SUPPORT\_ETM**

Support ETM (Event Task Matrix)

**SOC\_MCPWM\_CAPTURE\_CLK\_FROM\_GROUP**

Capture timer shares clock with other PWM timers.

**SOC\_PARLIO\_GROUPS**

Number of parallel IO peripherals

**SOC\_PARLIO\_TX\_UNITS\_PER\_GROUP**

number of TX units in each group

**SOC\_PARLIO\_RX\_UNITS\_PER\_GROUP**

number of RX units in each group

**SOC\_PARLIO\_TX\_UNIT\_MAX\_DATA\_WIDTH**

Number of data lines of the TX unit

**SOC\_PARLIO\_RX\_UNIT\_MAX\_DATA\_WIDTH**

Number of data lines of the RX unit

**SOC\_PARLIO\_TX\_CLK\_SUPPORT\_GATING**

Support gating TX clock

**SOC\_PARLIO\_RX\_CLK\_SUPPORT\_GATING**

Support gating RX clock

**SOC\_PARLIO\_RX\_CLK\_SUPPORT\_OUTPUT**

Support output RX clock to a GPIO

**SOC\_PARLIO\_TRANS\_BIT\_ALIGN**

Support bit alignment in transaction

**SOC\_MPI\_MEM\_BLOCKS\_NUM**

**SOC\_MPI\_OPERATIONS\_NUM**

**SOC\_RSA\_MAX\_BIT\_LEN**

**SOC\_SHA\_DMA\_MAX\_BUFFER\_SIZE**

**SOC\_SHA\_SUPPORT\_DMA**

**SOC\_SHA\_SUPPORT\_RESUME**

**SOC\_SHA\_GDMA**

**SOC\_SHA\_SUPPORT\_SHA1**

**SOC\_SHA\_SUPPORT\_SHA224**

**SOC\_SHA\_SUPPORT\_SHA256**

SOC\_SDM\_GROUPS

SOC\_SDM\_CHANNELS\_PER\_GROUP

SOC\_SDM\_CLK\_SUPPORT\_PLL\_F48M

SOC\_SDM\_CLK\_SUPPORT\_XTAL

SOC\_SPI\_PERIPH\_NUM

SOC\_SPI\_PERIPH\_CS\_NUM (i)

SOC\_SPI\_MAX\_CS\_NUM

SOC\_SPI\_MAXIMUM\_BUFFER\_SIZE

SOC\_SPI\_SUPPORT\_DDRCLK

SOC\_SPI\_SLAVE\_SUPPORT\_SEG\_TRANS

SOC\_SPI\_SUPPORT\_CD\_SIG

SOC\_SPI\_SUPPORT\_CONTINUOUS\_TRANS

SOC\_SPI\_SUPPORT\_SLAVE\_HD\_VER2

SOC\_SPI\_SUPPORT\_CLK\_XTAL

SOC\_SPI\_SUPPORT\_CLK\_PLL\_F48M

SOC\_SPI\_SUPPORT\_CLK\_RC\_FAST

SOC\_SPI\_PERIPH\_SUPPORT\_MULTILINE\_MODE (host\_id)

SOC\_SPI\_SCT\_SUPPORTED

SOC\_SPI\_SCT\_SUPPORTED\_PERIPH (PERIPH\_NUM)

SOC\_SPI\_SCT\_REG\_NUM

SOC\_SPI\_SCT\_BUFFER\_NUM\_MAX

SOC\_SPI\_SCT\_CONF\_BITLEN\_MAX

SOC\_MEMSPI\_IS\_INDEPENDENT

SOC\_SPI\_MAX\_PRE\_DIVIDER

SOC\_SPI\_MEM\_SUPPORT\_AUTO\_WAIT\_IDLE

SOC\_SPI\_MEM\_SUPPORT\_AUTO\_SUSPEND

SOC\_SPI\_MEM\_SUPPORT\_AUTO\_RESUME

SOC\_SPI\_MEM\_SUPPORT\_IDLE\_INTR

SOC\_SPI\_MEM\_SUPPORT\_SW\_SUSPEND

SOC\_SPI\_MEM\_SUPPORT\_CHECK\_SUS

SOC\_SPI\_MEM\_SUPPORT\_WRAP

SOC\_MEMSPI\_SRC\_FREQ\_64M\_SUPPORTED

SOC\_MEMSPI\_SRC\_FREQ\_32M\_SUPPORTED

SOC\_MEMSPI\_SRC\_FREQ\_16M\_SUPPORTED

SOC\_MEMSPI\_FLASH\_CLK\_SRC\_IS\_INDEPENDENT

SOC\_SYSTIMER\_COUNTER\_NUM

SOC\_SYSTIMER\_ALARM\_NUM

SOC\_SYSTIMER\_BIT\_WIDTH\_LO

SOC\_SYSTIMER\_BIT\_WIDTH\_HI

SOC\_SYSTIMER\_FIXED\_DIVIDER

SOC\_SYSTIMER\_SUPPORT\_RC\_FAST

SOC\_SYSTIMER\_INT\_LEVEL

SOC\_SYSTIMER\_ALARM\_MISS\_COMPENSATE

SOC\_SYSTIMER\_SUPPORT\_ETM

SOC\_LP\_TIMER\_BIT\_WIDTH\_LO

SOC\_LP\_TIMER\_BIT\_WIDTH\_HI

SOC\_TIMER\_GROUPS



SOC\_TIMER\_GROUP\_TIMERS\_PER\_GROUP

SOC\_TIMER\_GROUP\_COUNTER\_BIT\_WIDTH

SOC\_TIMER\_GROUP\_SUPPORT\_XTAL

SOC\_TIMER\_GROUP\_SUPPORT\_RC\_FAST

SOC\_TIMER\_GROUP\_TOTAL\_TIMERS

SOC\_TIMER\_SUPPORT\_ETM

SOC\_TIMER\_SUPPORT\_SLEEP\_RETENTION

SOC\_MWDT\_SUPPORT\_XTAL

SOC\_TWAI\_CONTROLLER\_NUM

SOC\_TWAI\_CLK\_SUPPORT\_XTAL

SOC\_TWAI\_BRP\_MIN

SOC\_TWAI\_BRP\_MAX

SOC\_TWAI\_SUPPORTS\_RX\_STATUS

SOC\_EFUSE\_DIS\_PAD\_JTAG

SOC\_EFUSE\_DIS\_USB\_JTAG

SOC\_EFUSE\_DIS\_DIRECT\_BOOT

SOC\_EFUSE\_SOFT\_DIS\_JTAG

SOC\_EFUSE\_DIS\_ICACHE

SOC\_EFUSE\_BLOCK9\_KEY\_PURPOSE QUIRK

SOC\_EFUSE\_ECDSA\_USE\_HARDWARE\_K

SOC\_EFUSE\_ECDSA\_KEY

SOC\_SECURE\_BOOT\_V2\_RSA

SOC\_SECURE\_BOOT\_V2\_ECC

**SOC\_EFUSE\_SECURE\_BOOT\_KEY\_DIGESTS**

**SOC\_EFUSE\_REVOKE\_BOOT\_KEY\_DIGESTS**

**SOC\_SUPPORT\_SECURE\_BOOT\_REVOKE\_KEY**

**SOC\_FLASH\_ENCRYPTED\_XTS\_AES\_BLOCK\_MAX**

**SOC\_FLASH\_ENCRYPTION\_XTS\_AES**

**SOC\_FLASH\_ENCRYPTION\_XTS\_AES\_128**

**SOC\_CRYPTO\_DPA\_PROTECTION\_SUPPORTED**

**SOC\_ECDSA\_USES\_MPI**

**SOC\_UART\_NUM**

**SOC\_UART\_HP\_NUM**

**SOC\_UART\_FIFO\_LEN**

The UART hardware FIFO length

**SOC\_UART\_BITRATE\_MAX**

Max bit rate supported by UART

**SOC\_UART\_SUPPORT\_RTC\_CLK**

Support RTC clock as the clock source

**SOC\_UART\_SUPPORT\_XTAL\_CLK**

Support XTAL clock as the clock source

**SOC\_UART\_SUPPORT\_WAKEUP\_INT**

Support UART wakeup interrupt

**SOC\_UART\_SUPPORT\_FSM\_TX\_WAIT\_SEND**

**SOC\_UART\_SUPPORT\_SLEEP\_RETENTION**

Support back up registers before sleep

**SOC\_COEX\_HW\_PTI**

**SOC\_EXTERNAL\_COEX\_ADVANCE**

HARDWARE ADVANCED EXTERNAL COEXISTENCE CAPS

**SOC\_EXTERNAL\_COEX\_LEADER\_TX\_LINE**

EXTERNAL COEXISTENCE TX LINE CAPS

**SOC\_PHY\_DIG\_REGS\_MEM\_SIZE**

**SOC\_PM\_SUPPORT\_BT\_WAKEUP**

**SOC\_PM\_SUPPORT\_EXT1\_WAKEUP**

**SOC\_PM\_SUPPORT\_EXT1\_WAKEUP\_MODE\_PER\_PIN**

Supports one bit per pin to configure the EXT1 trigger level

**SOC\_PM\_SUPPORT\_CPU\_PD**

**SOC\_PM\_SUPPORT\_MODEM\_PD**

modem includes BLE and 15.4

**SOC\_PM\_SUPPORT\_XTAL32K\_PD**

**SOC\_PM\_SUPPORT\_RC32K\_PD**

**SOC\_PM\_SUPPORT\_RC\_FAST\_PD**

**SOC\_PM\_SUPPORT\_VDDSDIO\_PD**

**SOC\_PM\_SUPPORT\_TOP\_PD**

**SOC\_PM\_PAU\_LINK\_NUM**

**SOC\_PM\_CPU\_RETENTION\_BY\_SW**

**SOC\_PM\_MODEM\_RETENTION\_BY\_REGDMA**

**SOC\_PM\_SUPPORT\_DEEPSLEEP\_CHECK\_STUB\_ONLY**

Supports CRC only the stub code in RTC memory

**SOC\_PM\_RETENTION\_SW\_TRIGGER\_REGDMA**

In esp32H2, regdma will power off when entering sleep

**SOC\_CLK\_RC\_FAST\_SUPPORT\_CALIBRATION**

**SOC\_CLK\_XTAL32K\_SUPPORTED**

Support to connect an external low frequency crystal

**SOC\_CLK\_OSC\_SLOW\_SUPPORTED**

Support to connect an external oscillator, not a crystal

**SOC\_CLK\_RC32K\_SUPPORTED**

Support an internal 32kHz RC oscillator

**SOC\_CLK\_LP\_FAST\_SUPPORT\_LP\_PLL**

Support LP\_PLL clock as the LP\_FAST clock source

**SOC\_MODEM\_CLOCK\_IS\_INDEPENDENT**

**SOC\_RCC\_IS\_INDEPENDENT**

Reset and Clock Control is independent, thanks to the PCR registers

**SOC\_TEMPERATURE\_SENSOR\_SUPPORT\_FAST\_RC**

**SOC\_TEMPERATURE\_SENSOR\_SUPPORT\_XTAL**

**SOC\_TEMPERATURE\_SENSOR\_INTR\_SUPPORT**

**SOC\_TEMPERATURE\_SENSOR\_SUPPORT\_ETM**

**SOC\_RNG\_CLOCK\_IS\_INDEPENDENT**

**SOC\_BLE\_SUPPORTED**

Support Bluetooth Low Energy hardware

**SOC\_BLE\_MESH\_SUPPORTED**

Support BLE MESH

**SOC\_ESP\_NIMBLE\_CONTROLLER**

Support BLE EMBEDDED controller V1

**SOC\_BLE\_50\_SUPPORTED**

Support Bluetooth 5.0

**SOC\_BLE\_DEVICE\_PRIVACY\_SUPPORTED**

Support BLE device privacy mode

**SOC\_BLE\_POWER\_CONTROL\_SUPPORTED**

Support Bluetooth Power Control

**SOC\_BLE\_MULTI\_CONN\_OPTIMIZATION**

Support multiple connections optimization

**SOC\_BLE\_PERIODIC\_ADV\_ENH\_SUPPORTED**

Support For BLE Periodic Adv Enhancements

## 2.10.28 系统时间

## 概述

ESP32-H2 使用两种硬件时钟源建立和保持系统时间。根据应用目的及对系统时间的精度要求，既可以仅使用其中一种时钟源，也可以同时使用两种时钟源。这两种硬件时钟源为：

- **RTC 定时器**：RTC 定时器在任何睡眠模式下及在任何复位后均可保持系统时间（上电复位除外，因为上电复位会重置 RTC 定时器）。时钟频率偏差取决于 **RTC 定时器时钟源**，该偏差只会在睡眠模式下影响时间精度。睡眠模式下，时间分辨率为 6.667  $\mu\text{s}$ 。
- **高分辨率定时器**：高分辨率定时器在睡眠模式下及在复位后不可用，但其时间精度更高。该定时器使用 APB\_CLK 时钟源（通常为 80 MHz），时钟频率偏差小于  $\pm 10$  ppm，时间分辨率为 1  $\mu\text{s}$ 。

可供选择的硬件时钟源组合如下所示：

- RTC 和高分辨率定时器（默认）
- RTC
- 高分辨率定时器
- 无

默认时钟源的时间精度最高，建议使用该配置。此外，用户也可以通过配置选项 `CONFIG_NEWLIB_TIME_SYSCALL` 来选择其他时钟源。

## RTC 定时器时钟源

RTC 定时器有以下时钟源：

- 内置 136 kHz RC 振荡器（默认）：Deep-sleep 模式下电流消耗最低，不依赖任何外部元件。但由于温度波动会影响该时钟源的频率稳定性，在 Deep-sleep 和 Light-sleep 模式下都有可能发生时间偏移。
- 外置 32 kHz 晶振：需要将一个 32 kHz 晶振连接到 XTAL\_32K\_P 和 XTAL\_32K\_N 管脚。频率稳定性更高，但在 Deep-sleep 模式下电流消耗略高（比默认模式高 1  $\mu\text{A}$ ）。
- 管脚 XTAL\_32K\_P 外置 32 kHz 振荡器：允许使用由外部电路产生的 32 kHz 时钟。外部时钟信号必须连接到管脚 XTAL\_32K\_P。正弦波信号的振幅应小于 1.2 V，方波信号的振幅应小于 1 V。正常模式下，电压范围应为  $0.1 < V_{\text{cm}} < 0.5 \times V_{\text{amp}}$ ，其中  $V_{\text{amp}}$  代表信号振幅。使用此时钟源时，管脚 XTAL\_32K\_P 无法用作 GPIO 管脚。
- 内置 32 kHz RC 振荡器

时钟源的选择取决于系统时间精度要求和睡眠模式下的功耗要求。要修改 RTC 时钟源，请在项目配置中设置 `CONFIG_RTC_CLK_SRC`。

想要了解外置晶振或外置振荡器的更多布线要求，请参考 [硬件设计指南](#)。

## 获取当前时间

要获取当前时间，请使用 POSIX 函数 `gettimeofday()`。此外，也可以使用以下标准 C 库函数来获取时间并对其进行操作：

```
gettimeofday
time
asctime
clock
ctime
difftime
gmtime
localtime
mktime
strftime
adjtime*
```

如需立即更新当前时间，并暂停平滑时间校正，请使用 POSIX 函数 `settimeofday()`。

若要求时间的分辨率为 1 s，请使用以下代码片段：

```
time_t now;
char strftime_buf[64];
struct tm timeinfo;

time(&now);
// 将时区设置为中国标准时间
setenv("TZ", "CST-8", 1);
tzset();

localtime_r(&now, &timeinfo);
strftime(strftime_buf, sizeof(strftime_buf), "%c", &timeinfo);
ESP_LOGI(TAG, "The current date/time in Shanghai is: %s", strftime_buf);
```

若要求时间的分辨率为 1  $\mu$ s，请使用以下代码片段：

```
struct timeval tv_now;
gettimeofday(&tv_now, NULL);
int64_t time_us = (int64_t)tv_now.tv_sec * 1000000L + (int64_t)tv_now.tv_usec;
```

## SNTP 时间同步

要设置当前时间，可以使用 POSIX 函数 `settimeofday()` 和 `adjtime()`。lwIP 中的 SNTP 库会在收到 NTP 服务器的响应报文后，调用这两个函数以更新当前的系统时间。当然，用户可以在 lwIP SNTP 库之外独立地使用这两个函数。

包括 SNTP 函数在内的一些 lwIP API 并非线程安全，因此建议在与 SNTP 模块交互时使用 *esp\_netif component*。

要初始化特定的 SNTP 服务器并启动 SNTP 服务，只需创建有特定服务器名称的默认 SNTP 服务器配置，然后调用 `esp_netif_sntp_init()` 注册该服务器并启动 SNTP 服务。

```
esp_sntp_config_t config = ESP_NETIF_SNTP_DEFAULT_CONFIG("pool.ntp.org");
esp_netif_sntp_init(&config);
```

一旦收到 SNTP 服务器的响应，此代码会自动执行时间同步。有时等待时间同步很有意义，调用 `esp_netif_sntp_sync_wait()` 可实现此目的：

```
if (esp_netif_sntp_sync_wait(pdMS_TO_TICKS(10000)) != ESP_OK) {
    printf("Failed to update system time within 10s timeout");
}
```

要配置多个 NTP 服务器（或使用更高级的设置，例如 DHCP 提供的 NTP 服务器），请参考 *esp\_netif* 文档 *SNTP API* 中的详细说明。

lwIP SNTP 库可在下列任一同步模式下工作：

- *SNTP\_SYNC\_MODE\_IMMED*（默认）：使用 `settimeofday()`，收到 SNTP 服务器响应后立即更新系统时间。
- *SNTP\_SYNC\_MODE\_SMOOTH*：使用函数 `adjtime()` 逐渐减少时间误差以平滑更新时间。如果 SNTP 响应时间和系统时间之差超过 35 分钟，请立即使用 `settimeofday()` 更新系统时间。

如要选择 *SNTP\_SYNC\_MODE\_SMOOTH* 模式，请将 SNTP 配置结构体中的 `esp_sntp_config::smooth` 设置为 `true`，否则将默认使用 *SNTP\_SYNC\_MODE\_IMMED* 模式。

设置时间同步时的回调函数，请使用配置结构体中的 `esp_sntp_config::sync_cb` 字段。

添加此初始化代码后，应用程序将定期同步时间。时间同步周期由 `CONFIG_LWIP_SNTP_UPDATE_DELAY` 设置（默认为一小时）。如需修改，请在项目配置中设置 `CONFIG_LWIP_SNTP_UPDATE_DELAY`。

如需查看示例代码，请前往 `protocols/sntp` 目录。该目录下的示例展示了如何基于 lwIP SNTP 库实现时间同步。

也可以直接使用 lwIP API，但请务必注意线程安全。线程安全的 API 如下：

- `sntp_set_time_sync_notification_cb()` 用于设置通知时间同步过程的回调函数。
- `sntp_get_sync_status()` 和 `sntp_set_sync_status()` 用于获取/设置时间同步状态。
- `sntp_set_sync_mode()` 用于设置同步模式。
- `esp_sntp_setoperatingmode()` 用于设置首选操作模式。`ESP_SNTP_OPMODE_POLL` 和 `esp_sntp_init()` 可初始化 SNTP 模块。
- `esp_sntp_setservername()` 用于配置特定 SNTP 服务器。

## 时区

要设置本地时区，请使用以下 POSIX 函数：

1. 调用 `setenv()`，将 TZ 环境变量根据设备位置设置为正确的值。时间字符串的格式与 GNU libc 文档中描述的相同（但实现方式不同）。
2. 调用 `tzset()`，为新的时区更新 C 库的运行数据。

完成上述步骤后，请调用标准 C 库函数 `localtime()`。该函数将返回排除时区偏差和夏令时干扰后的准确本地时间。

## 2036 年和 2038 年溢出问题

**SNTP/NTP 2036 年溢出问题** SNTP/NTP 时间戳为 64 位无符号定点数，其中前 32 位表示整数部分，后 32 位表示小数部分。该 64 位无符号定点数代表从 1900 年 1 月 1 日 00:00 起经过的秒数，因此 SNTP/NTP 时间将在 2036 年溢出。

为了解决这一问题，可以使用整数部分的 MSB（惯例为位 0）来表示 1968 年到 2104 年之间的时间范围（查看 RFC2030 了解更多信息），这一惯例将使得 SNTP/NTP 时间戳的生命周期延长。该惯例会在 lwIP 库的 SNTP 模块中实现，因此 ESP-IDF 中 SNTP 相关功能在 2104 年之前能够经受住时间的考验。

**Unix 时间 2038 年溢出问题** Unix 时间（类型 `time_t`）此前为有符号的 32 位整数，因此将于 2038 年溢出（即 Y2K38 问题）。为了解决 Y2K38 问题，ESP-IDF 从 v5.0 版本起开始使用有符号的 64 位整数来表示 `time_t`，从而将 `time_t` 溢出推迟 2920 亿年。

## API 参考

### Header File

- `components/lwip/include/apps/esp_sntp.h`
- This header file can be included with:

```
#include "esp_sntp.h"
```

- This header file is a part of the API provided by the `lwip` component. To declare that your component depends on `lwip`, add the following to your `CMakeLists.txt`:

```
REQUIRES lwip
```

or

```
PRIV_REQUIRES lwip
```

## Functions

void **sntp\_sync\_time** (struct timeval \*tv)

This function updates the system time.

This is a weak-linked function. It is possible to replace all SNTP update functionality by placing a `sntp_sync_time()` function in the app firmware source. If the default implementation is used, calling `sntp_set_sync_mode()` allows the time synchronization mode to be changed to instant or smooth. If a callback function is registered via `sntp_set_time_sync_notification_cb()`, it will be called following time synchronization.

**参数 tv** -- Time received from SNTP server.

void **sntp\_set\_sync\_mode** (*sntp\_sync\_mode\_t* sync\_mode)

Set the sync mode.

Modes allowed: SNTP\_SYNC\_MODE\_IMMED and SNTP\_SYNC\_MODE\_SMOOTH.

**参数 sync\_mode** -- Sync mode.

*sntp\_sync\_mode\_t* **sntp\_get\_sync\_mode** (void)

Get set sync mode.

**返回** SNTP\_SYNC\_MODE\_IMMED: Update time immediately.  
SNTP\_SYNC\_MODE\_SMOOTH: Smooth time updating.

*sntp\_sync\_status\_t* **sntp\_get\_sync\_status** (void)

Get status of time sync.

After the update is completed, the status will be returned as SNTP\_SYNC\_STATUS\_COMPLETED. After that, the status will be reset to SNTP\_SYNC\_STATUS\_RESET. If the update operation is not completed yet, the status will be SNTP\_SYNC\_STATUS\_RESET. If a smooth mode was chosen and the synchronization is still continuing (adjtime works), then it will be SNTP\_SYNC\_STATUS\_IN\_PROGRESS.

**返回** SNTP\_SYNC\_STATUS\_RESET: Reset status. SNTP\_SYNC\_STATUS\_COMPLETED: Time is synchronized. SNTP\_SYNC\_STATUS\_IN\_PROGRESS: Smooth time sync in progress.

void **sntp\_set\_sync\_status** (*sntp\_sync\_status\_t* sync\_status)

Set status of time sync.

**参数 sync\_status** -- status of time sync (see `sntp_sync_status_t`)

void **sntp\_set\_time\_sync\_notification\_cb** (*sntp\_sync\_time\_cb\_t* callback)

Set a callback function for time synchronization notification.

**参数 callback** -- a callback function

void **sntp\_set\_sync\_interval** (uint32\_t interval\_ms)

Set the sync interval of SNTP operation.

Note: SNTPv4 RFC 4330 enforces a minimum sync interval of 15 seconds. This sync interval will be used in the next attempt update time through SNTP. To apply the new sync interval call the `sntp_restart()` function, otherwise, it will be applied after the last interval expired.

**参数 interval\_ms** -- The sync interval in ms. It cannot be lower than 15 seconds, otherwise 15 seconds will be set.

uint32\_t **sntp\_get\_sync\_interval** (void)

Get the sync interval of SNTP operation.

**返回** the sync interval

bool **sntp\_restart** (void)

Restart SNTP.

**返回** True - Restart False - SNTP was not initialized yet



void **esp\_sntp\_setoperatingmode** (*esp\_sntp\_operatingmode\_t* operating\_mode)

Sets SNTP operating mode. The mode has to be set before init.

**参数** **operating\_mode** -- Desired operating mode

void **esp\_sntp\_init** (void)

Init and start SNTP service.

void **esp\_sntp\_stop** (void)

Stops SNTP service.

void **esp\_sntp\_setserver** (u8\_t idx, const ip\_addr\_t \*addr)

Sets SNTP server address.

**参数**

- **idx** -- Index of the server
- **addr** -- IP address of the server

void **esp\_sntp\_setservername** (u8\_t idx, const char \*server)

Sets SNTP hostname.

**参数**

- **idx** -- Index of the server
- **server** -- Name of the server

const char \***esp\_sntp\_getservername** (u8\_t idx)

Gets SNTP server name.

**参数** **idx** -- Index of the server

**返回** Name of the server

const ip\_addr\_t \***esp\_sntp\_getserver** (u8\_t idx)

Get SNTP server IP.

**参数** **idx** -- Index of the server

**返回** IP address of the server

bool **esp\_sntp\_enabled** (void)

Checks if sntp is enabled.

**返回** true if sntp module is enabled

uint8\_t **esp\_sntp\_getreachability** (uint8\_t idx)

Gets the server reachability shift register as described in RFC 5905.

**参数** **idx** -- Index of the SNTP server

**返回** reachability shift register

*esp\_sntp\_operatingmode\_t* **esp\_sntp\_getoperatingmode** (void)

Get the configured operating mode.

**返回** operating mode enum

static inline void **sntp\_setoperatingmode** (u8\_t operating\_mode)

if not build within lwip, provide translating inlines, that will warn about thread safety

static inline void **sntp\_servermode\_dhcp** (int set\_servers\_from\_dhcp)

static inline void **sntp\_setservername** (u8\_t idx, const char \*server)

static inline void **sntp\_init** (void)

static inline const char \***sntp\_getservername** (u8\_t idx)

static inline const ip\_addr\_t \***sntp\_getserver** (u8\_t idx)

```
static inline uint8_t sntp_getreachability (uint8_t idx)
```

```
static inline esp_sntp_operatingmode_t sntp_getoperatingmode (void)
```

## Macros

**esp\_sntp\_sync\_time**

Aliases for esp\_sntp prefixed API (inherently thread safe)

**esp\_sntp\_set\_sync\_mode**

**esp\_sntp\_get\_sync\_mode**

**esp\_sntp\_get\_sync\_status**

**esp\_sntp\_set\_sync\_status**

**esp\_sntp\_set\_time\_sync\_notification\_cb**

**esp\_sntp\_set\_sync\_interval**

**esp\_sntp\_get\_sync\_interval**

**esp\_sntp\_restart**

**SNTP\_OPMODE\_POLL**

## Type Definitions

```
typedef void (*sntp_sync_time_cb_t)(struct timeval *tv)
```

SNTP callback function for notifying about time sync event.

**Param tv** Time received from SNTP server.

## Enumerations

```
enum sntp_sync_mode_t
```

SNTP time update mode.

*Values:*

enumerator **SNTP\_SYNC\_MODE\_IMMED**

Update system time immediately when receiving a response from the SNTP server.

enumerator **SNTP\_SYNC\_MODE\_SMOOTH**

Smooth time updating. Time error is gradually reduced using adjtime function. If the difference between SNTP response time and system time is large (more than 35 minutes) then update immediately.

```
enum sntp_sync_status_t
```

SNTP sync status.

*Values:*

enumerator **SNTP\_SYNC\_STATUS\_RESET**

enumerator **SNTP\_SYNC\_STATUS\_COMPLETED**

enumerator **SNTP\_SYNC\_STATUS\_IN\_PROGRESS**

enum **esp\_sntp\_operatingmode\_t**

SNTP operating modes per lwip SNTP module.

*Values:*

enumerator **ESP\_SNTP\_OPMODE\_POLL**

enumerator **ESP\_SNTP\_OPMODE\_LISTENONLY**

## 2.10.29 异步内存复制

### 概述

ESP32-H2 有一个 DMA 引擎，能够以异步方式帮助 CPU 完成内部内存复制操作。

异步 memcpy API 中封装了所有 DMA 配置和操作，`esp_async_memcpy()` 的签名与标准 C 库的 memcpy 函数基本相同。

DMA 允许多个内存复制请求在首个请求完成之前排队，即允许计算和内存复制的重叠。此外，通过注册事件回调函数，还可以知道内存复制请求完成的准确时间。

### 配置并安装驱动

安装异步 memcpy 驱动的方法取决于底层 DMA 引擎：

- `esp_async_memcpy_install_gdma_ahb()` 用于安装基于 AHB GDMA 引擎的异步 memcpy 驱动。
- `esp_async_memcpy_install()` 是一个通用 API，用于安装带有默认 DMA 引擎的异步 memcpy 驱动。如果 SoC 具有 CP DMA 引擎，则默认 DMA 引擎为 CP DMA，否则，默认 DMA 引擎为 AHB GDMA。

在 `async_memcpy_config_t` 中设置驱动配置：

- `backlog`：此项用于配置首个请求完成前可以排队的最大内存复制事务数量。如果将此字段设置为零，会应用默认值 4。
- `dma_burst_size`：设置单次 DMA 传输中突发数据量的大小。
- `flags`：此项可以启用一些特殊的驱动功能。

```

async_memcpy_config_t config = ASYNC_MEMCPY_DEFAULT_CONFIG();
// 更新底层 DMA 引擎支持的最大数据流
config.backlog = 8;
async_memcpy_handle_t driver = NULL;
ESP_ERROR_CHECK(esp_async_memcpy_install(&config, &driver)); // 使用默认 DMA_
↳引擎安装驱动

```

## 发送内存复制请求

使用 `esp_async_memcpy()` API 将内存复制请求发送到 DMA 引擎。在驱动程序成功安装后才能调用该 API。此 API 是线程安全的，因此可以从不同的任务中调用。

与 `libc` 版本的 `memcpy` 不同，你可以选择给 `esp_async_memcpy()` 设置一个回调函数，以便在内存复制完成时收到通知。注意，回调是在 `ISR` 上下文中执行的，请不要在回调中调用任何阻塞函数。

回调函数的原型是 `async_memcpy_isr_cb_t`。回调函数只有在借助 RTOS API (如 `xSemaphoreGiveFromISR()`) 唤醒了高优先级任务后才能返回 `true`。

```
// 回调实现，在 ISR 上下文中运行
static bool my_async_memcpy_cb(async_memcpy_handle_t mcp_hdl, async_memcpy_event_t
↳*event, void *cb_args)
{
    SemaphoreHandle_t sem = (SemaphoreHandle_t)cb_args;
    BaseType_t high_task_wakeup = pdFALSE;
    xSemaphoreGiveFromISR(sem, &high_task_wakeup); //↳
↳如果解锁了一些高优先级任务，则将 high_task_wakeup 设置为 pdTRUE
    return high_task_wakeup == pdTRUE;
}

// 创建一个信号量，在异步 memcpy 完成时进行报告
SemaphoreHandle_t semphr = xSemaphoreCreateBinary();

// 从用户的上下文中调用
ESP_ERROR_CHECK(esp_async_memcpy(driver_handle, to, from, copy_len, my_async_
↳memcpy_cb, my_semaphore));
// 其他事项
xSemaphoreTake(my_semaphore, portMAX_DELAY); // 等待 buffer 复制完成
```

## 卸载驱动

使用 `esp_async_memcpy_uninstall()` 卸载异步 `memcpy` 驱动。无需在每次 `memcpy` 操作后手动卸载。如果你的应用程序不再需要此驱动，此 API 可以帮助回收内存和其他硬件资源。

## ETM 事件

在异步 `memcpy` 操作完成时会生成一个事件，此事件能够与 `ETM` 模块进行交互。可以调用 `esp_async_memcpy_new_etm_event()` 获取 ETM 事件句柄。

如需了解如何将此事件连接到 ETM 通道，请参考文档 [ETM](#)。

## API 参考

### Header File

- [components/esp\\_hw\\_support/include/esp\\_async\\_memcpy.h](#)
- This header file can be included with:

```
#include "esp_async_memcpy.h"
```

### Functions

`esp_err_t esp_async_memcpy_install_gdma_ahb` (const `async_memcpy_config_t` \*config, `async_memcpy_handle_t` \*mcp)

Install async memcpy driver, with AHB-GDMA as the backend.

### 参数

- **config** -- **[in]** Configuration of async memcpy
- **mcp** -- **[out]** Returned driver handle

**返回**

- ESP\_OK: Install async memcpy driver successfully
- ESP\_ERR\_INVALID\_ARG: Install async memcpy driver failed because of invalid argument
- ESP\_ERR\_NO\_MEM: Install async memcpy driver failed because out of memory
- ESP\_FAIL: Install async memcpy driver failed because of other error

*esp\_err\_t* **esp\_async\_memcpy\_install** (const *async\_memcpy\_config\_t* \*config, *async\_memcpy\_handle\_t* \*mcp)

Install async memcpy driver with the default DMA backend.

---

**备注:** On chip with CPDMA support, CPDMA is the default choice. On chip with AHB-GDMA support, AHB-GDMA is the default choice.

---

**参数**

- **config** -- **[in]** Configuration of async memcpy
- **mcp** -- **[out]** Returned driver handle

**返回**

- ESP\_OK: Install async memcpy driver successfully
- ESP\_ERR\_INVALID\_ARG: Install async memcpy driver failed because of invalid argument
- ESP\_ERR\_NO\_MEM: Install async memcpy driver failed because out of memory
- ESP\_FAIL: Install async memcpy driver failed because of other error

*esp\_err\_t* **esp\_async\_memcpy\_uninstall** (*async\_memcpy\_handle\_t* mcp)

Uninstall async memcpy driver.

**参数** **mcp** -- **[in]** Handle of async memcpy driver that returned from `esp_async_memcpy_install`

**返回**

- ESP\_OK: Uninstall async memcpy driver successfully
- ESP\_ERR\_INVALID\_ARG: Uninstall async memcpy driver failed because of invalid argument
- ESP\_FAIL: Uninstall async memcpy driver failed because of other error

*esp\_err\_t* **esp\_async\_memcpy** (*async\_memcpy\_handle\_t* mcp, void \*dst, void \*src, size\_t n, *async\_memcpy\_isr\_cb\_t* cb\_isr, void \*cb\_args)

Send an asynchronous memory copy request.

---

**备注:** The callback function is invoked in interrupt context, never do blocking jobs in the callback.

---

**参数**

- **mcp** -- **[in]** Handle of async memcpy driver that returned from `esp_async_memcpy_install`
- **dst** -- **[in]** Destination address (copy to)
- **src** -- **[in]** Source address (copy from)
- **n** -- **[in]** Number of bytes to copy
- **cb\_isr** -- **[in]** Callback function, which got invoked in interrupt context. Set to NULL can bypass the callback.
- **cb\_args** -- **[in]** User defined argument to be passed to the callback function

**返回**

- ESP\_OK: Send memory copy request successfully
- ESP\_ERR\_INVALID\_ARG: Send memory copy request failed because of invalid argument

- `ESP_FAIL`: Send memory copy request failed because of other error

`esp_err_t esp_async_memcpy_new_etm_event` (*async\_memcpy\_handle\_t* mcp,  
*async\_memcpy\_etm\_event\_t* event\_type,  
*esp\_etm\_event\_handle\_t* \*out\_event)

Get the ETM event handle for async memcpy done signal.

---

**备注:** The created ETM event object can be deleted later by calling `esp_etm_del_event`

---

#### 参数

- **mcp** -- **[in]** Handle of async memcpy driver that returned from `esp_async_memcpy_install`
- **event\_type** -- **[in]** ETM event type
- **out\_event** -- **[out]** Returned ETM event handle

#### 返回

- `ESP_OK`: Get ETM event successfully
- `ESP_ERR_INVALID_ARG`: Get ETM event failed because of invalid argument
- `ESP_ERR_NOT_SUPPORTED`: Get ETM event failed because the DMA hardware doesn't support ETM submodule
- `ESP_FAIL`: Get ETM event failed because of other error

## Structures

struct **async\_memcpy\_event\_t**  
Async memory copy event data.

#### Public Members

void \***data**  
Event data

struct **async\_memcpy\_config\_t**  
Type of async memcpy configuration.

#### Public Members

uint32\_t **backlog**  
Maximum number of transactions that can be prepared in the background

size\_t **sram\_trans\_align**  
DMA transfer alignment (both in size and address) for SRAM memory

size\_t **psram\_trans\_align**  
DMA transfer alignment (both in size and address) for PSRAM memory

size\_t **dma\_burst\_size**  
DMA transfer burst size, in bytes

uint32\_t **flags**  
Extra flags to control async memcpy feature

## Macros

**ASYNC\_MEMCPY\_DEFAULT\_CONFIG()**

Default configuration for async memcpy.

## Type Definitions

```
typedef struct async_memcpy_context_t *async_memcpy_handle_t
```

Async memory copy driver handle.

```
typedef bool (*async_memcpy_isr_cb_t)(async_memcpy_handle_t mcp_hdl, async_memcpy_event_t *event, void *cb_args)
```

Type of async memcpy interrupt callback function.

---

**备注:** User can call OS primitives (semaphore, mutex, etc) in the callback function. Keep in mind, if any OS primitive wakes high priority task up, the callback should return true.

---

**Param mcp\_hdl** Handle of async memcpy

**Param event** Event object, which contains related data, reserved for future

**Param cb\_args** User defined arguments, passed from `esp_async_memcpy` function

**Return** Whether a high priority task is woken up by the callback function

## Enumerations

```
enum async_memcpy_etm_event_t
```

Async memory copy specific events that supported by the ETM module.

*Values:*

```
enumerator ASYNC_MEMCPY_ETM_EVENT_COPY_DONE
```

memory copy finished

### 2.10.30 看门狗

#### 概述

ESP-IDF 支持以下类型的看门狗定时器：

- 硬件看门狗定时器
- 中断看门狗定时器 (IWDT)
- 任务看门狗定时器 (TWDT)

中断看门狗负责确保 ISR（中断服务程序）不被长时间阻塞，TWDT 负责检测任务长时间运行而不让步的情况。

通过[项目配置菜单](#)可启用各种看门狗定时器。其中，TWDT 也可以在程序运行时启用。

#### 硬件看门狗定时器

芯片有两组看门狗定时器：

- 主系统看门狗定时器 (MWDT\_WDT) - 用于中断看门狗定时器 (IWDT) 和任务看门狗定时器 (TWDT)。
- RTC 看门狗定时器 (RTC\_WDT) - 用于跟踪从上电到执行用户主函数的启动时间（默认情况下，RTC 看门狗在执行用户主函数之前会被立即禁用）。

请参阅[看门狗](#)小节，了解如何在引导加载程序中使用看门狗。

用户可以调整应用程序行为，使 RTC 看门狗在应用程序启动后保持启用状态。应用程序需要显式重置（即喂狗）或禁用看门狗，以避免芯片重置。具体而言，用户可设置 `CONFIG_BOOTLOADER_WDT_DISABLE_IN_USER_CODE` 选项，根据需要修改应用程序并重新编译。此过程中应使用以下 API：

- `wdt_hal_disable()`：参考[禁用 RTC\\_WDT](#)
- `wdt_hal_feed()`：参考[重置 RTC\\_WDT 计数器](#)

如果未能及时重置或禁用 RTC\_WDT，芯片将自动重置。请参阅[RTC 看门狗超时](#)了解更多信息。

### 中断看门狗定时器 (IWDT)

IWDT 的目的是，确保中断服务例程 (ISR) 运行不会受到长时间阻塞（即 IWDT 超时）。阻塞 ISR 及时运行会增加 ISR 延迟，也会阻止任务切换（因为任务切换是从 ISR 执行的）。阻止 ISR 运行的事项包括：

- 禁用中断
- 临界区（也会禁用中断）
- 其他相同或更高优先级的 ISR，在完成前会阻止相同或较低优先级的 ISR

IWDT 利用定时器组 1 中的 MWDT\_WDT 看门狗定时器作为其底层硬件定时器，并在每个 CPU 上使用 FreeRTOS 时钟滴答中断，即 tick 中断。如果某个 CPU 上的 tick 中断没有在 IWDT 超时前运行，就表明该 CPU 上的 ISR 运行受阻（参见上文原因列表）。

当 IWDT 超时后，默认操作是调用紧急处理程序 (Panic Handler)，并显示出错原因 (Interrupt wdt timeout on CPU0 或 Interrupt wdt timeout on CPU1，视情况而定)。根据紧急处理程序的配置行为（参见 `CONFIG_ESP_SYSTEM_PANIC`），用户可通过回溯、OpenOCD、gdbstub 等来调试 IWDT 超时问题，也可以重置芯片（这在生产环境中可能是首选）。

如果出于某种原因，IWDT 超时后紧急处理程序无法运行，IWDT 还可以通过其二阶段超时而硬重置芯片（即系统重置）。

### 配置

- IWDT 默认通过 `CONFIG_ESP_INT_WDT` 选项启用。
- 通过 `CONFIG_ESP_INT_WDT_TIMEOUT_MS` 选项设置 IWDT 超时。
  - 注意，如果启用了 PSRAM 支持，那么默认的超时时间会更长，因为在某些情况下，临界区或中断例程访问大量 PSRAM 需要更长时间。
  - 超时时间至少应是 FreeRTOS tick 周期的两倍时长（参见 `CONFIG_FREERTOS_HZ`）。

**调优** 如果 IWDT 超时是中断或临界区运行超时导致的，可以考虑重写代码：

- 临界区应尽可能短。任何非关键的代码或计算都应放在临界区外。
- 中断处理程序也应尽可能减少计算量。考虑让 ISR 使用队列向任务推送数据，从而将计算推迟到任务中进行。

临界区或中断处理程序都不应阻塞其他事件。如果不能或不希望通过更改代码减少处理时间，可以通过设置 `CONFIG_ESP_INT_WDT_TIMEOUT_MS` 延长超时时间。

### 任务看门狗定时器 (TWDT)

任务看门狗定时器 (TWDT) 用于监视特定任务，确保任务在配置的超时时间内执行。TWDT 主要监视每个 CPU 的空闲任务，但其他任务也可以订阅 TWDT 监视。通过监视每个 CPU 的空闲任务，TWDT 可以



检测到任务长时间运行没有让出的情况。这可能表明代码编写不当，在外设上自旋循环，或者任务陷入了无限循环。

TWDT 是基于定时器组 0 中的 MWDT\_WDT 看门狗定时器构建的。超时发生时触发中断。

可以在用户代码中定义函数 `esp_task_wdt_isr_user_handler` 来接收超时事件，并扩展默认行为。

**使用** 调用以下函数，用 TWDT 监视任务：

- `esp_task_wdt_init()` 初始化 TWDT 并订阅空闲任务。
- `esp_task_wdt_add()` 为其他任务订阅 TWDT。
- 订阅后，应从任务中调用 `esp_task_wdt_reset()` 来喂 TWDT。
- `esp_task_wdt_delete()` 可以取消之前订阅的任务。
- `esp_task_wdt_deinit()` 取消订阅空闲任务并反初始化 TWDT。

在需要更细粒度级别监视的情况下（即确保调用特定的函数、存根、代码路径），TWDT 允许订阅 users。

- `esp_task_wdt_add_user()` 订阅 TWDT 的任意用户。此函数返回添加用户的用户句柄。
- 必须使用用户句柄调用 `esp_task_wdt_reset_user()`，防止 TWDT 超时。
- `esp_task_wdt_delete_user()` 取消订阅 TWDT 的任意用户。

**配置** TWDT 的默认超时时间可以通过 `CONFIG_ESP_TASK_WDT_TIMEOUT_S` 配置项进行设置，并应至少设置为任何单个任务预计需要独占 CPU 的时长，例如某应用程序将进行长时间的密集计算且不让位给其他任务时的预计时长。也可以调用 `esp_task_wdt_init()`，在运行时更改此时间。

**备注：** 擦除较大的 flash 区域可能会非常耗时，并可能导致任务连续运行，触发 TWDT 超时。以下两种方法可以避免这种情况：

- 在 `menuconfig` 中增加 `CONFIG_ESP_TASK_WDT_TIMEOUT_S`，延长看门狗超时时间。
- 在擦除 flash 区域前，调用 `esp_task_wdt_init()` 增加看门狗超时时间。

如需了解更多信息，请参考 [SPI flash API](#)。

以下配置选项控制 TWDT 配置，默认情况下全部启用：

- `CONFIG_ESP_TASK_WDT_EN` - 启用 TWDT 功能。如果禁用此选项，TWDT 即使运行时已初始化也无法使用。
- `CONFIG_ESP_TASK_WDT_INIT` - TWDT 在启动期间自动初始化。禁用此选项时，仍可以调用 `esp_task_wdt_init()` 在运行时初始化 TWDT。
- `CONFIG_ESP_TASK_WDT_CHECK_IDLE_TASK_CPU0` - 空闲任务在启动时订阅了 TWDT。如果此选项被禁用，仍可以调用 `esp_task_wdt_init()` 再次订阅。

**备注：** 如果 TWDT 超时，会默认在继续运行应用程序前打印警告和回溯。如希望超时触发系统严重错误和系统重置，可以通过 `CONFIG_ESP_TASK_WDT_PANIC` 进行配置。

## JTAG & 看门狗

在使用 OpenOCD 进行调试时，CPU 会在每次达到断点时停止运行。然而，如果遇到断点后看门狗定时器继续运行，就会最终触发复位，为调试代码带来巨大的困难。因此，OpenOCD 会在每个断点处禁用中断和任务的看门狗的硬件定时器。此外，在离开断点时，OpenOCD 也不会重新启用定时器，也就是说，中断看门狗和任务看门狗实际上被禁用。当 ESP32-H2 通过 JTAG 连接到 OpenOCD 时，看门狗不会打印任何警告或出现严重错误。

## API 参考

**任务看门狗** 在 ESP-IDF 中使用任务看门狗的完整示例: [system/task\\_watchdog](#)

### Header File

- `components/esp_system/include/esp_task_wdt.h`
- This header file can be included with:

```
#include "esp_task_wdt.h"
```

### Functions

`esp_err_t esp_task_wdt_init` (const `esp_task_wdt_config_t` \*config)

Initialize the Task Watchdog Timer (TWDT)

This function configures and initializes the TWDT. This function will subscribe the idle tasks if configured to do so. For other tasks, users can subscribe them using `esp_task_wdt_add()` or `esp_task_wdt_add_user()`. This function won't start the timer if no task have been registered yet.

---

**备注:** `esp_task_wdt_init()` must only be called after the scheduler is started. Moreover, it must not be called by multiple tasks simultaneously.

---

**参数** `config` -- [in] Configuration structure

**返回**

- ESP\_OK: Initialization was successful
- ESP\_ERR\_INVALID\_STATE: Already initialized
- Other: Failed to initialize TWDT

`esp_err_t esp_task_wdt_reconfigure` (const `esp_task_wdt_config_t` \*config)

Reconfigure the Task Watchdog Timer (TWDT)

The function reconfigures the running TWDT. It must already be initialized when this function is called.

---

**备注:** `esp_task_wdt_reconfigure()` must not be called by multiple tasks simultaneously.

---

**参数** `config` -- [in] Configuration structure

**返回**

- ESP\_OK: Reconfiguring was successful
- ESP\_ERR\_INVALID\_STATE: TWDT not initialized yet
- Other: Failed to initialize TWDT

`esp_err_t esp_task_wdt_deinit` (void)

Deinitialize the Task Watchdog Timer (TWDT)

This function will deinitialize the TWDT, and unsubscribe any idle tasks. Calling this function whilst other tasks are still subscribed to the TWDT, or when the TWDT is already deinitialized, will result in an error code being returned.

---

**备注:** `esp_task_wdt_deinit()` must not be called by multiple tasks simultaneously.

---

**返回**

- ESP\_OK: TWDT successfully deinitialized
- Other: Failed to deinitialize TWDT

*esp\_err\_t* **esp\_task\_wdt\_add** (*TaskHandle\_t* task\_handle)

Subscribe a task to the Task Watchdog Timer (TWDT)

This function subscribes a task to the TWDT. Each subscribed task must periodically call `esp_task_wdt_reset()` to prevent the TWDT from elapsing its timeout period. Failure to do so will result in a TWDT timeout.

**参数** **task\_handle** -- Handle of the task. Input NULL to subscribe the current running task to the TWDT

**返回**

- ESP\_OK: Successfully subscribed the task to the TWDT
- Other: Failed to subscribe task

*esp\_err\_t* **esp\_task\_wdt\_add\_user** (const char \*user\_name, *esp\_task\_wdt\_user\_handle\_t* \*user\_handle\_ret)

Subscribe a user to the Task Watchdog Timer (TWDT)

This function subscribes a user to the TWDT. A user of the TWDT is usually a function that needs to run periodically. Each subscribed user must periodically call `esp_task_wdt_reset_user()` to prevent the TWDT from elapsing its timeout period. Failure to do so will result in a TWDT timeout.

**参数**

- **user\_name** -- **[in]** String to identify the user
- **user\_handle\_ret** -- **[out]** Handle of the user

**返回**

- ESP\_OK: Successfully subscribed the user to the TWDT
- Other: Failed to subscribe user

*esp\_err\_t* **esp\_task\_wdt\_reset** (void)

Reset the Task Watchdog Timer (TWDT) on behalf of the currently running task.

This function will reset the TWDT on behalf of the currently running task. Each subscribed task must periodically call this function to prevent the TWDT from timing out. If one or more subscribed tasks fail to reset the TWDT on their own behalf, a TWDT timeout will occur.

**返回**

- ESP\_OK: Successfully reset the TWDT on behalf of the currently running task
- Other: Failed to reset

*esp\_err\_t* **esp\_task\_wdt\_reset\_user** (*esp\_task\_wdt\_user\_handle\_t* user\_handle)

Reset the Task Watchdog Timer (TWDT) on behalf of a user.

This function will reset the TWDT on behalf of a user. Each subscribed user must periodically call this function to prevent the TWDT from timing out. If one or more subscribed users fail to reset the TWDT on their own behalf, a TWDT timeout will occur.

**参数** **user\_handle** -- **[in]** User handle

- ESP\_OK: Successfully reset the TWDT on behalf of the user
- Other: Failed to reset

*esp\_err\_t* **esp\_task\_wdt\_delete** (*TaskHandle\_t* task\_handle)

Unsubscribes a task from the Task Watchdog Timer (TWDT)

This function will unsubscribe a task from the TWDT. After being unsubscribed, the task should no longer call `esp_task_wdt_reset()`.

**参数** **task\_handle** -- **[in]** Handle of the task. Input NULL to unsubscribe the current running task.

**返回**

- ESP\_OK: Successfully unsubscribed the task from the TWDT
- Other: Failed to unsubscribe task

*esp\_err\_t* **esp\_task\_wdt\_delete\_user** (*esp\_task\_wdt\_user\_handle\_t* user\_handle)

Unsubscribes a user from the Task Watchdog Timer (TWDT)

This function will unsubscribe a user from the TWDT. After being unsubscribed, the user should no longer call `esp_task_wdt_reset_user()`.

**参数** `user_handle` -- [in] User handle

**返回**

- `ESP_OK`: Successfully unsubscribed the user from the TWDT
- Other: Failed to unsubscribe user

*esp\_err\_t* `esp_task_wdt_status` (*TaskHandle\_t* task\_handle)

Query whether a task is subscribed to the Task Watchdog Timer (TWDT)

This function will query whether a task is currently subscribed to the TWDT, or whether the TWDT is initialized.

**参数** `task_handle` -- [in] Handle of the task. Input NULL to query the current running task.

**返回** :

- `ESP_OK`: The task is currently subscribed to the TWDT
- `ESP_ERR_NOT_FOUND`: The task is not subscribed
- `ESP_ERR_INVALID_STATE`: TWDT was never initialized

void `esp_task_wdt_isr_user_handler` (void)

User ISR callback placeholder.

This function is called by `task_wdt_isr` function (ISR for when TWDT times out). It can be defined in user code to handle TWDT events.

---

**备注:** It has the same limitations as the interrupt function. Do not use `ESP_LOGx` functions inside.

---

*esp\_err\_t* `esp_task_wdt_print_triggered_tasks` (*task\_wdt\_msg\_handler* msg\_handler, void \*opaque, int \*cpus\_fail)

Prints or retrieves information about tasks/users that triggered the Task Watchdog Timeout.

This function provides various operations to handle tasks/users that did not reset the Task Watchdog in time. It can print detailed information about these tasks/users, such as their names, associated CPUs, and whether they have been reset. Additionally, it can retrieve the total length of the printed information or the CPU affinity of the failing tasks.

---

**备注:**

- If `msg_handler` is not provided, the information will be printed to console using `ESP_EARLY_LOGE`.
  - If `msg_handler` is provided, the function will send the printed information to the provided message handler function.
  - If `cpus_fail` is provided, the function will store the CPU affinity of the failing tasks in the provided integer.
  - During the execution of this function, logging is allowed in critical sections, as TWDT timeouts are considered fatal errors.
- 

**参数**

- **msg\_handler** -- [in] Optional message handler function that will be called for each printed line.
- **opaque** -- [in] Optional pointer to opaque data that will be passed to the message handler function.
- **cpus\_fail** -- [out] Optional pointer to an integer where the CPU affinity of the failing tasks will be stored.

**返回**

- `ESP_OK`: The function executed successfully.
- `ESP_FAIL`: No triggered tasks were found, and thus no information was printed or retrieved.

## Structures

struct **esp\_task\_wdt\_config\_t**

Task Watchdog Timer (TWDT) configuration structure.

## Public Members

uint32\_t **timeout\_ms**

TWDT timeout duration in milliseconds

uint32\_t **idle\_core\_mask**

Bitmask of the core whose idle task should be subscribed on initialization where  $1 \ll i$  means that core  $i$ 's idle task will be monitored by the TWDT

bool **trigger\_panic**

Trigger panic when timeout occurs

## Type Definitions

typedef struct esp\_task\_wdt\_user\_handle\_s \***esp\_task\_wdt\_user\_handle\_t**

Task Watchdog Timer (TWDT) user handle.

typedef void (\***task\_wdt\_msg\_handler**)(void \*opaque, const char \*msg)

此部分 API 代码示例存放在 ESP-IDF 示例项目的 [system](#) 目录下。

## Chapter 3

### H/W 硬件参考



## Chapter 4

# API 指南

## 4.1 应用层跟踪库

### 4.1.1 概述

ESP-IDF 中提供了应用层跟踪功能，用于分析应用程序的行为。这一功能在相应的库中实现，可以通过 `menuconfig` 开启。此功能允许用户在程序运行开销很小的前提下，通过 JTAG、UART 或 USB 接口在主机和 ESP32-H2 之间传输任意数据。用户也可同时使用 JTAG 和 UART 接口。UART 接口主要用于连接 SEGGER SystemView 工具（参见 [SystemView](#)）。

开发人员可以使用这一功能库将应用程序的运行状态发送给主机，在运行时接收来自主机的命令或者其他类型的信息。该库的主要使用场景有：

1. 收集来自特定应用程序的数据。具体请参阅[特定应用程序的跟踪](#)。
2. 记录到主机的轻量级日志。具体请参阅[记录日志到主机](#)。
3. 系统行为分析。具体请参阅[基于 SEGGER SystemView 的系统行为分析](#)。
4. 获取源代码覆盖率。具体请参阅[Gcov（源代码覆盖）](#)。

使用 JTAG 接口的跟踪组件工作示意图如下所示：

### 4.1.2 运行模式

该库支持两种运行模式：

**后验模式：**后验模式为默认模式，该模式不需要和主机进行交互。在这种模式下，跟踪模块不会检查主机是否已经从 `HW UP BUFFER` 缓冲区读走所有数据，而是直接使用新数据覆盖旧数据。如果用户仅对最新的跟踪数据感兴趣，例如想要分析程序在崩溃之前的行为，则推荐使用该模式。主机可以稍后根据用户的请求来读取数据，例如在使用 JTAG 接口的情况下，通过特殊的 `OpenOCD` 命令进行读取。

**流模式：**当主机连接到 ESP32-H2 时，跟踪模块会进入此模式。在这种模式下，跟踪模块在新数据写入 `HW UP BUFFER` 之前会检查其中是否有足够的空间，并在必要的时候等待主机读取数据并释放足够的内存。最大等待时间是由用户传递给相应 API 函数的超时时间参数决定的。因此当应用程序尝试使用有限的最大等待时间值来将数据写入跟踪缓冲区时，这些数据可能会被丢弃。尤其需要注意的是，如果在对时效要求严格的代码中（如中断处理函数、操作系统调度等）指定了无限的超时时间，将会导致系统故障。为了避免丢失此类关键数据，开发人员可以在 `menuconfig` 中开启 `CONFIG_APPTRACE_PENDING_DATA_SIZE_MAX` 选项，以启用额外的数据缓冲区。此宏还指定了在上述条件下可以缓冲的数据大小，它有助于缓解由于 USB 总线拥塞等原因导致的向主机传输数据间歇性减缓的状况。但是，当跟踪数据流的平均比特率超出硬件接口的能力时，该选项无法发挥作用。





图 1: 使用 JTAG 接口的跟踪组件

### 4.1.3 配置选项与依赖项

使用此功能需要在主机端和目标端进行以下配置：

1. **主机端：**应用程序跟踪通过 JTAG 来完成，因此需要在主机上安装并运行 OpenOCD。详细信息请参阅 [JTAG 调试](#)。
2. **目标端：**在 `menuconfig` 中开启应用程序跟踪功能。前往 `Component config > Application Level Tracing` 菜单，选择跟踪数据的传输目标（具体用于传输的硬件接口：JTAG 和/或 UART），选择任一非 `None` 的目标都会自动开启 `CONFIG_APPTRACE_ENABLE` 这个选项。对于 UART 接口，用户必须定义波特率、TX 和 RX 管脚及其他相关参数。

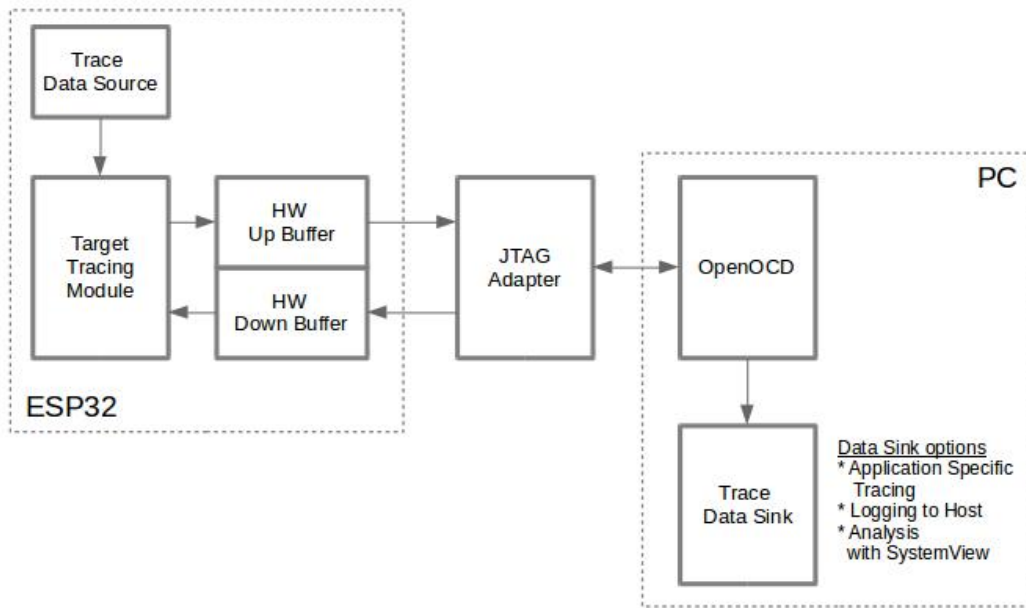
**备注：**为了实现更高的数据速率并降低丢包率，建议优化 JTAG 的时钟频率，使其达到能够稳定运行的最大值。详细信息请参阅 [优化 JTAG 的速度](#)。

以下为前述未提及的另外两个 `menuconfig` 选项：

1. *Threshold for flushing last trace data to host on panic* (`CONFIG_APPTRACE_POSTMORTEM_FLUSH_THRESH`)。使用 JTAG 接口时，此选项是必选项。在该模式下，跟踪数据以 16 KB 数据块的形式暴露给主机。在后验模式中，一个块被填充后会被暴露给主机，同时之前的块不再可用。也就是说，跟踪数据以 16 KB 的粒度进行覆盖。发生 Panic 时，当前输入块的最新数据将会被暴露给主机，主机可以读取数据以进行后续分析。如果系统发生 Panic 时，仍有少量数据还没来得及暴露给主机，那么之前收集的 16 KB 数据将丢失，主机只能获取少部分的最新跟踪数据，从而可能无法诊断问题。此 `menuconfig` 选项有助于避免此类情况，它可以控制发生 Panic 时刷新数据的阈值。例如，用户可以设置需要不少于 512 字节的最新跟踪数据，如果在发生 Panic 时待处理的数据少于 512 字节，则数据不会被刷新，也不会覆盖之前的 16 KB 数据。该选项仅在后验模式和使用 JTAG 工作时可发挥作用。
2. *Timeout for flushing last trace data to host on panic* (`CONFIG_APPTRACE_ONPANIC_HOST_FLUSH_TMO`)。该选项仅在流模式下才可发挥作用，它可用于控制跟踪模块在发生 Panic 时等待主机读取最新数据的最长时间。
3. *UART RX/TX ring buffer size* (`CONFIG_APPTRACE_UART_TX_BUFF_SIZE`)。缓冲区的大小取决于通过 UART 传输的数据量。

4. *UART TX message size* (: `ref:CONFIG_APPTRACE_UART_TX_MSG_size`)。要传输的单条消息的最大尺寸。

#### 4.1.4 如何使用此库

该库提供了用于在主机和 ESP32-H2 之间传输任意数据的 API。在 `menuconfig` 中启用该库后，目标应用程序的跟踪模块会在系统启动时自动初始化。因此，用户需要做的就是调用相应的 API 来发送、接收或者刷新数据。

##### 特定应用程序的跟踪

通常，用户需要决定在每个方向上待传输数据的类型以及如何解析（处理）这些数据。要想在目标和主机之间传输数据，则需执行以下几个步骤：

1. 在目标端，用户需要实现将跟踪数据写入主机的算法。下面的代码片段展示了如何执行此操作。

```
#include "esp_app_trace.h"
...
char buf[] = "Hello World!";
esp_err_t res = esp_apptrace_write(ESP_APPTRACE_DEST_TRAX, buf, strlen(buf),
↳ESP_APPTRACE_TMO_INFINITE);
if (res != ESP_OK) {
    ESP_LOGE(TAG, "Failed to write data to host!");
    return res;
}
```

`esp_apptrace_write()` 函数使用 `memcpy` 把用户数据复制到内部缓存中。在某些情况下，使用 `esp_apptrace_buffer_get()` 和 `esp_apptrace_buffer_put()` 函数会更加理想，它们允许开发人员自行分配缓冲区并填充。下面的代码片段展示了如何执行此操作。

```
#include "esp_app_trace.h"
...
int number = 10;
char *ptr = (char *)esp_apptrace_buffer_get(ESP_APPTRACE_DEST_TRAX, 32, 100/
↳*tmo in us*/);
if (ptr == NULL) {
    ESP_LOGE(TAG, "Failed to get buffer!");
    return ESP_FAIL;
}
sprintf(ptr, "Here is the number %d", number);
esp_err_t res = esp_apptrace_buffer_put(ESP_APPTRACE_DEST_TRAX, ptr, 100/*tmo.
↳in us*/);
if (res != ESP_OK) {
    /* in case of error host tracing tool (e.g. OpenOCD) will report
↳incomplete user buffer */
    ESP_LOGE(TAG, "Failed to put buffer!");
    return res;
}
```

另外，根据实际项目的需要，用户可能希望从主机接收数据。下面的代码片段展示了如何执行此操作。

```
#include "esp_app_trace.h"
...
char buf[32];
char down_buf[32];
size_t sz = sizeof(buf);

/* config down buffer */
esp_apptrace_down_buffer_config(down_buf, sizeof(down_buf));
/* check for incoming data and read them if any */
```

(下页继续)

(续上页)

```

esp_err_t res = esp_appttrace_read(ESP_APPTRACE_DEST_TRAX, buf, &sz, 0/*do not
↳wait*/);
if (res != ESP_OK) {
    ESP_LOGE(TAG, "Failed to read data from host!");
    return res;
}
if (sz > 0) {
    /* we have data, process them */
    ...
}

```

esp\_appttrace\_read() 函数使用 memcopy 把主机端的数据复制到用户缓存区。在某些情况下, 使用 esp\_appttrace\_down\_buffer\_get() 和 esp\_appttrace\_down\_buffer\_put() 函数可能更为理想。它们允许开发人员占用一块读缓冲区并就地地进行有关处理操作。下面的代码片段展示了如何执行此操作。

```

#include "esp_app_trace.h"
...
char down_buf[32];
uint32_t *number;
size_t sz = 32;

/* config down buffer */
esp_appttrace_down_buffer_config(down_buf, sizeof(down_buf));
char *ptr = (char *)esp_appttrace_down_buffer_get(ESP_APPTRACE_DEST_TRAX, &sz,
↳100/*tmo in us*/);
if (ptr == NULL) {
    ESP_LOGE(TAG, "Failed to get buffer!");
    return ESP_FAIL;
}
if (sz > 4) {
    number = (uint32_t *)ptr;
    printf("Here is the number %d", *number);
} else {
    printf("No data");
}
esp_err_t res = esp_appttrace_down_buffer_put(ESP_APPTRACE_DEST_TRAX, ptr, 100/
↳tmo in us*/);
if (res != ESP_OK) {
    /* in case of error host tracing tool (e.g. OpenOCD) will report
↳incomplete user buffer */
    ESP_LOGE(TAG, "Failed to put buffer!");
    return res;
}

```

2. 下一步是编译应用程序的镜像, 并将其下载到目标板上。这一步可以参考文档[构建并烧写](#)。
3. 运行 OpenOCD (参见[JTAG 调试](#))。
4. 连接到 OpenOCD 的 telnet 服务器。用户可在终端执行命令 telnet <oocd\_host> 4444。如果用户是在运行 OpenOCD 的同一台机器上打开 telnet 会话, 可以使用 localhost 替换上面命令中的 <oocd\_host>。
5. 使用特殊的 OpenOCD 命令开始收集待跟踪的命令。此命令将传输跟踪数据并将其重定向到指定的文件或套接字 (当前仅支持文件作为跟踪数据目标)。相关命令的说明, 请参阅[启动调试器](#)。
6. 最后, 处理接收到的数据。由于数据格式由用户自己定义, 本文档中省略数据处理的具体流程。数据处理的范例可以参考位于 \$IDF\_PATH/tools/esp\_app\_trace 下的 Python 脚本 apptrace\_proc.py (用于功能测试) 和 logtrace\_proc.py (请参阅[记录日志到主机](#)章节中的详细信息)。

**OpenOCD 应用程序跟踪命令** HW UP BUFFER 在用户数据块之间共享, 并且会代替 API 调用者 (在任务或者中断上下文中) 填充分配到的内存。在多线程环境中, 正在填充缓冲区的任务/中断可能会被另一个高优先级的任务/中断抢占, 因此主机可能会读取到还未准备好的用户数据。对此, 跟踪模块在所有用户数据块之前添加一个数据头, 其中包含有分配的用户缓冲区的大小 (2 字节) 和实际写入的数据长度

(2 字节)，也就是说数据头总共长 4 字节。负责读取跟踪数据的 OpenOCD 命令在读取到不完整的用户数据块时会报错，但是无论如何，它都会将整个用户数据块（包括还未填充的区域）的内容放到输出文件中。

下文介绍了如何使用 OpenOCD 应用程序跟踪命令。

---

**备注：**目前，OpenOCD 还不支持将任意用户数据发送到目标的命令。

---

命令用法：

```
esp appttrace [start <options>] | [stop] | [status] | [dump <cores_num>
<outfile>]
```

子命令：

**start** 开始跟踪（连续流模式）。

**stop** 停止跟踪。

**status** 获取跟踪状态。

**dump** 转储所有后验模式的数据。

Start 子命令的语法：

```
start <outfile> [poll_period [trace_size [stop_tmo [wait4halt
[skip_size]]]]]
```

**outfile** 用于保存来自两个 CPU 的数据文件的路径，该参数需要具有以下格式：file://path/to/file。

**poll\_period** 轮询跟踪数据的周期（单位：毫秒），如果大于 0 则以非阻塞模式运行。默认为 1 毫秒。

**trace\_size** 最多要收集的数据量（单位：字节），接收到指定数量的数据后将会停止跟踪。默认为 -1（禁用跟踪大小停止触发器）。

**stop\_tmo** 空闲超时（单位：秒），如果指定的时间段内都没有数据就会停止跟踪。默认为 -1（禁用跟踪超时停止触发器）。还可以将其设置为比目标跟踪命令之间的最长暂停值更长的值（可选）。

**wait4halt** 如果设置为 0 则立即开始跟踪，否则命令会先等待目标停止（复位、打断点等），然后对其进行自动恢复并开始跟踪。默认值为 0。

**skip\_size** 开始时要跳过的字节数，默认为 0。

---

**备注：**如果 poll\_period 为 0，则在跟踪停止之前，OpenOCD 的 telnet 命令将不可用。必须通过复位电路板或者在 OpenOCD 的窗口中（非 telnet 会话窗口）使用快捷键 Ctrl+C。另一种选择是设置 trace\_size 并等待，当收集到指定数据量时，跟踪会自动停止。

---

命令使用示例：

1. 将 2048 个字节的跟踪数据收集到 trace.log 文件中，该文件将保存在 openocd-esp32 目录中。

```
esp appttrace start file://trace.log 1 2048 5 0 0
```

跟踪数据会被检索并以非阻塞的模式保存到文件中，如果收集满 2048 字节的数据或者在 5 秒内都没有新的数据，那么该过程就会停止。

.. note::

在将数据提供给 OpenOCD 之前，会对其进行缓冲。如果看到 “Data timeout!” 的消息，则表示目标可能在超时之前没有向 OpenOCD 发送足够的数以清空缓冲区。要解决这个问题，可以增加超时时间或者使用函数 `esp_appttrace_flush()` 以特定间隔刷新数据。

2. 在非阻塞模式下无限地检索跟踪数据。

```
esp appttrace start file://trace.log 1 -1 -1 0 0
```

对收集数据的大小没有限制，也不设置超时时间。要停止此过程，可以在 OpenOCD 的 telnet 会话窗口中发送 `esp appttrace stop` 命令，或者在 OpenOCD 窗口中使用快捷键 Ctrl+C。

(下页继续)

3. 检索跟踪数据并无限期保存。

```
esp apptrace start file://trace.log 0 -1 -1 0 0
```

在跟踪停止之前，OpenOCD 的 telnet 会话窗口将不可用。要停止跟踪，请在 OpenOCD 的窗口中使用快捷键 Ctrl+C。

4. 等待目标停止，然后恢复目标的操作并开始检索数据。当收集满 2048 字节的数据后就停止：

```
esp apptrace start file://trace.log 0 2048 -1 1 0
```

想要复位后立即开始跟踪，请使用 OpenOCD 的 ``reset halt`` 命令。

## 记录日志到主机

记录日志到主机是 ESP-IDF 中一个非常实用的功能：通过应用层跟踪库将日志保存到主机端。某种程度上，这也算是一种半主机 (semihosting) 机制，相较于调用 ESP\_LOGx 将待打印的字符串发送到 UART 的日志记录方式，此功能将大部分工作转移到了主机端，从而减少了本地工作量。

ESP-IDF 的日志库会默认使用类 vprintf 的函数将格式化的字符串输出到专用的 UART，一般来说涉及以下几个步骤：

1. 解析格式字符串以获取每个参数的类型。
2. 根据其类型，将每个参数都转换为字符串。
3. 格式字符串与转换后的参数一起发送到 UART。

虽然可以对类 vprintf 函数进行一定程度的优化，但由于在任何情况下都必须执行上述步骤，并且每个步骤都会消耗一定的时间（尤其是步骤 3），所以经常会发生以下这种情况：向程序中添加额外的打印信息以诊断问题，却改变了应用程序的行为，使得问题无法复现。在最严重的情况下，程序无法正常工作，最终导致报错甚至挂起。

想要解决此类问题，可以使用更高的波特率或者其他更快的接口，并将字符串格式化的工作转移到主机端。

通过应用层跟踪库的 esp\_appttrace\_vprintf 函数，可以将日志信息发送到主机，该函数不执行格式字符串和参数的完全解析，而仅仅计算传递参数的数量，并将它们与格式字符串地址一起发送给主机。主机端会通过一个特殊的 Python 脚本来处理并打印接收到的日志数据。

**局限** 目前通过 JTAG 实现记录日志还存在以下几点局限：

1. 不支持使用 ESP\_EARLY\_LOGx 宏进行跟踪。
2. 不支持大小超过 4 字节的 printf 参数（例如 double 和 uint64\_t）。
3. 仅支持 .rodata 段中的格式字符串和参数。
4. 最多支持 256 个 printf 参数。

**如何使用** 为了使用跟踪模块来记录日志，用户需要执行以下步骤：

1. 在目标端，需要安装特殊的类 vprintf 函数 esp\_appttrace\_vprintf()，该函数负责将日志数据发送给主机，使用方法为 esp\_log\_set\_vprintf(esp\_appttrace\_vprintf)；。如需将日志数据再次重定向给 UART，请使用 esp\_log\_set\_vprintf(vprintf)；。
2. 按照 [特定应用程序的跟踪](#) 章节中的第 2-5 步进行操作。
3. 打印接收到的日志记录，请在终端运行以下命令：\$IDF\_PATH/tools/esp\_app\_trace/logtrace\_proc.py /path/to/trace/file /path/to/program/elf/file。

**Log Trace Processor 命令选项** 命令用法：

```
logtrace_proc.py [-h] [--no-errors] <trace_file> <elf_file>
```

位置参数 (必要)：



**trace\_file** 日志跟踪文件的路径。  
**elf\_file** 程序 ELF 文件的路径。

可选参数:

**-h, --help** 显示此帮助信息并退出。  
**--no-errors, -n** 不打印错误信息。

### 基于 SEGGER SystemView 的系统行为分析

ESP-IDF 中另一个基于应用层跟踪库的实用功能是系统级跟踪，它会生成与 SEGGER SystemView 工具相兼容的跟踪信息。SEGGER SystemView 是一款实时记录和可视化工具，用来分析应用程序运行时的行为，可通过 UART 接口实时查看事件。

**如何使用** 若需使用这个功能，需要在 menuconfig 中开启 `CONFIG_APPTRACE_SV_ENABLE` 选项，具体路径为 Component config > Application Level Tracing > FreeRTOS SystemView Tracing。同一菜单栏下还开启了其它几个选项：

1. *SystemView destination*。选择需要使用的接口：JTAG 或 UART。使用 UART 接口时，可以将 SystemView 应用程序直接连接到 ESP32-H2 并实时接收数据。
2. *ESP32-H2 timer to use as SystemView timestamp source* (`CONFIG_APPTRACE_SV_TS_SOURCE`)。选择 SystemView 事件使用的时间戳来源。在单核模式下，使用 ESP32-H2 内部的循环计数器生成时间戳，其最大的工作频率是 240 MHz（时间戳粒度大约为 4 ns）。在双核模式下，使用工作在 40 MHz 的外部定时器，因此时间戳粒度为 25 ns。
3. 可以单独启用或禁用的 SystemView 事件集合 (`CONFIG_APPTRACE_SV_EVT_XXX`):
  - Trace Buffer Overflow Event
  - ISR Enter Event
  - ISR Exit Event
  - ISR Exit to Scheduler Event
  - Task Start Execution Event
  - Task Stop Execution Event
  - Task Start Ready State Event
  - Task Stop Ready State Event
  - Task Create Event
  - Task Terminate Event
  - System Idle Event
  - Timer Enter Event
  - Timer Exit Event

ESP-IDF 中已经包含了所有用于生成兼容 SystemView 跟踪信息的代码，用户只需配置必要的项目选项（如上所示），然后构建、烧写映像到目标板，接着参照前面的介绍，使用 OpenOCD 收集数据。

4. 想要通过 UART 接口进行实时跟踪，请在菜单配置选项 Component config > Application Level Tracing > FreeRTOS SystemView Tracing 中选择 Pro 或 App CPU。

### OpenOCD SystemView 跟踪命令选项 命令用法：

```
esp sysview [start <options>] | [stop] | [status]
```

子命令：

**start** 开启跟踪（连续流模式）。

**stop** 停止跟踪。

**status** 获取跟踪状态。

Start 子命令语法：

```
start <outfile1> [outfile2] [poll_period [trace_size [stop_tmo]]]
```

**outfile1** 保存 PRO CPU 数据的文件路径。此参数需要具有如下格式：file://path/to/file。

**outfile2** 保存 APP CPU 数据的文件路径。此参数需要具有如下格式：file://path/to/file。

**poll\_period** 跟踪数据的轮询周期（单位：毫秒）。如果该值大于 0，则命令以非阻塞的模式运行。默认为 1 毫秒。

**trace\_size** 最多要收集的数据量（单位：字节）。当收到指定数量的数据后，将停止跟踪。默认值是 -1（禁用跟踪大小停止触发器）。

**stop\_tmo** 空闲超时（单位：秒）。如果指定的时间内没有数据，将停止跟踪。默认值是 -1（禁用跟踪超时停止触发器）。

---

**备注：** 如果 `poll_period` 为 0，则在跟踪停止之前，OpenOCD 的 `telnet` 命令行将不可用。你需要复位板卡，或者在 OpenOCD 的窗口（非 `telnet` 会话窗口）输入 `Ctrl+C` 命令，手动停止跟踪。另一个办法是设置 `trace_size`，等到收集满指定数量的数据后自动停止跟踪。

---

命令使用示例：

1. 将 SystemView 跟踪数据收集到文件 `pro-cpu.SVdat` 和 `app-cpu.SVdat` 中。这些文件会被保存在 `openocd-esp32` 目录中。

```
esp sysview start file://pro-cpu.SVdat file://app-cpu.SVdat
```

跟踪数据被检索并以非阻塞的方式保存。要停止此过程，需要在 OpenOCD 的 `telnet` 会话窗口输入 `esp sysview stop` 命令，也可以在 OpenOCD 窗口中按下快捷键 `Ctrl+C`。

2. 检索跟踪数据并无限保存。

```
esp32 sysview start file://pro-cpu.SVdat file://app-cpu.SVdat 0 -1 -1
```

OpenOCD 的 `telnet` 命令行在跟踪停止前会无法使用，要停止跟踪，请在 OpenOCD 窗口使用 `Ctrl+C` 快捷键。

**数据可视化** 收集到跟踪数据后，用户可以使用特殊的工具对结果进行可视化并分析程序行为。

在工具中单独分析每个核的跟踪数据是比较棘手的，但是 Eclipse 提供了 *Impulse* 插件，该插件可以加载多个跟踪文件，并且可以在同一视图中检查来自两个内核的事件。此外，与免费版的 SystemView 相比，此插件没有 1,000,000 个事件的限制。

关于如何安装、配置 *Impulse* 并使用它来可视化来自单个核心的跟踪数据，请参阅 [官方教程](#)。

---

**备注：** ESP-IDF 使用自己的 SystemView FreeRTOS 事件 ID 映射，因此用户需要将 `$(SYSVIEW_INSTALL_DIR)/Description/SYSVIEW_FreeRTOS.txt` 替换成 `$(IDF_PATH)/tools/esp_app_trace/SYSVIEW_FreeRTOS.txt`。在使用上述链接配置 SystemView 序列化程序时，也应该使用该特定文件的内容。

---

## Gcov（源代码覆盖）

**Gcov 和 Gcovr 简介** 源代码覆盖率显示程序运行时间内执行的每一条程序执行路径的数量和频率。**Gcov** 是一款 GCC 工具，与编译器协同使用时，可生成日志文件，显示源文件每行的执行次数。**Gcovr** 是管理 Gcov 和生成代码覆盖率总结的工具。

一般来说，使用 Gcov 在主机上编译和运行程序会经过以下步骤：

1. 使用 GCC 以及 `--coverage` 选项编译源代码。编译器会在编译过程中生成一个 `.gcno` 注释文件，该文件包含重建执行路径块图以及将每个块映射到源代码行号等信息。每个用 `--coverage` 选项编译的源文件都会生成自己的同名 `.gcno` 文件（如 `main.c` 在编译时会生成 `main.gcno`）。
2. 执行程序。在执行过程中，程序会生成 `.gcda` 数据文件。这些数据文件包含了执行路径的计数统计。程序将为每个用 `--coverage` 选项编译的源文件生成一个 `.gcda` 文件（如 `main.c` 将生成 `main.gcda`）。
3. Gcov 或 Gcovr 可用于生成基于 `.gcno`、`.gcda` 和源文件的代码覆盖。Gcov 将以 `.gcov` 文件的形式为每个源文件生成基于文本的覆盖报告，而 Gcovr 将以 HTML 格式生成覆盖报告。

**ESP-IDF 中的 Gcov 和 Gcovr 应用** 在 ESP-IDF 中使用 Gcov 的过程比较复杂，因为程序不在主机上运行，而在目标机上运行。代码覆盖率数据（即 .gcda 文件）最初存储在目标机上，OpenOCD 在运行时通过 JTAG 将代码覆盖率数据从目标机转储到主机上。在 ESP-IDF 中使用 Gcov 可以分为以下几个步骤：

1. 为 Gcov 设置项目
2. 转储代码覆盖数据
3. 生成代码覆盖报告

## 为 Gcov 设置项目

**编译器选项** 为了获取项目中的代码覆盖率数据，必须用 `--coverage` 选项编译项目中的一个或多个源文件。在 ESP-IDF 中，这可以在组件级或单个源文件级实现：

- 在组件的 CMakeLists.txt 文件中添加 `target_compile_options(${COMPONENT_LIB} PRIVATE --coverage)` 可确保使用 `--coverage` 选项编译组件中的所有源文件。
- 在组件的 CMakeLists.txt 文件中添加 `set_source_files_properties(source1.c source2.c PROPERTIES COMPILE_FLAGS --coverage)` 可确保使用 `--coverage` 选项编译同一组件中选定的某些源文件（如 source1.c 和 source2.c）。

当一个源文件用 `--coverage` 选项编译时（例如 `gcov_example.c`），编译器会在项目的构建目录下生成 `gcov_example.gcno` 文件。

**项目配置** 在构建有源代码覆盖的项目之前，请运行 `idf.py menuconfig` 以启用以下项目配置选项。

- 通过 `CONFIG_APPTRACE_DESTINATION1` 选项选择 Trace Memory 来启用应用程序跟踪模块。
- 通过 `CONFIG_APPTRACE_GCOV_ENABLE` 选项启用 Gcov 主机。

**转储代码覆盖数据** 一旦项目使用 `--coverage` 选项编译并烧录到目标机上，在应用程序运行时，代码覆盖数据将存储在目标机内部（即在跟踪存储器中）。将代码覆盖率数据从目标机转移到主机上的过程称为转储。

覆盖率数据的转储通过 OpenOCD 进行（关于如何设置和运行 OpenOCD，请参考 [JTAG 调试](#)）。由于该过程需要通过向 OpenOCD 发出命令来触发转储，因此必须打开 telnet 会话，以向 OpenOCD 发出这些命令（运行 `telnet localhost 4444`）。GDB 也可以代替 telnet 来向 OpenOCD 发出命令，但是所有从 GDB 发出的命令都需要以 `mon <ocd_command>` 为前缀。

当目标机转储代码覆盖数据时，.gcda 文件存储在项目的构建目录中。例如，如果 main 组件的 `gcov_example_main.c` 在编译时使用了 `--coverage` 选项，那么转储代码覆盖数据将在 `build/esp-idf/main/CMakeFiles/__idf_main.dir/gcov_example_main.c.gcda` 中生成 `gcov_example_main.gcda` 文件。注意，编译过程中产生的 .gcno 文件也放在同一目录下。

代码覆盖数据的转储可以在应用程序的整个生命周期内多次进行。每次转储都会用最新的代码覆盖信息更新 .gcda 文件。代码覆盖数据是累积的，因此最新的数据将包含应用程序整个生命周期中每个代码路径的总执行次数。

ESP-IDF 支持两种将代码覆盖数据从目标机转储到主机的方法：

- 运行中实时转储
- 硬编码转储

**运行中实时转储** 通过 telnet 会话调用 OpenOCD 命令 `ESP32-H2 gcov` 来触发运行时的实时转储。一旦被调用，OpenOCD 将立即抢占 ESP32-H2 的当前状态，并执行内置的 ESP-IDF Gcov 调试存根函数。调试存根函数将数据转储到主机。完成后，ESP32-H2 将恢复当前状态。

**硬编码转储** 硬编码转储是由应用程序本身从程序内部调用 `esp_gcov_dump()` 函数触发的。在调用时，应用程序将停止并等待 OpenOCD 连接，同时检索代码覆盖数据。一旦 `esp_gcov_dump()` 函数被调用，主机将通过 telnet 会话执行 `esp gcov dump` OpenOCD 命令，该命令会将 OpenOCD 连接到 ESP32-H2，



检索代码覆盖数据，然后断开与 ESP32-H2 的连接，从而恢复应用程序。在应用程序的生命周期中可多次触发硬编码转储。

在必要时（如应用程序初始化后或是应用程序主循环的每次迭代期间）放置 `esp_gcov_dump()`，当应用程序在生命周期的某刻需要代码覆盖率数据时，硬编码转储会非常有用。

GDB 可以用来在 `esp_gcov_dump()` 上设置断点，然后使用 `gdbinit` 脚本自动调用 `mon esp gcov dump`（关于 GDB 的使用可参考[使用命令行调试](#)）。

以下 GDB 脚本将在 `esp_gcov_dump()` 处添加一个断点，然后调用 `mon esp gcov dump OpenOCD` 命令。

```
b esp_gcov_dump
commands
mon esp gcov dump
end
```

**备注：**注意，所有的 OpenOCD 命令都应该在 GDB 中以 `mon <occd_command>` 方式调用。

**生成代码覆盖报告** 一旦代码覆盖数据被转储，`.gcno`、`.gcda` 和源文件可以用来生成代码覆盖报告。该报告会显示源文件中每行被执行的次数。

`Gcov` 和 `Gcovr` 都可以用来生成代码覆盖报告。安装 Xtensa 工具链时会一起安装 `Gcov`，但 `Gcovr` 可能需要单独安装。关于如何使用 `Gcov` 或 `Gcovr`，请参考[Gcov 文档](#)和[Gcovr 文档](#)。

**在工程中添加 Gcovr 构建目标** 用户可以在自己的工程中定义额外的构建目标，从而通过一个简单的构建命令即可更方便地生成报告。

请在工程的 `CMakeLists.txt` 文件中添加以下内容：

```
include($ENV{IDF_PATH}/tools/cmake/gcov.cmake)
idf_create_coverage_report(${CMAKE_CURRENT_BINARY_DIR}/coverage_report)
idf_clean_coverage_report(${CMAKE_CURRENT_BINARY_DIR}/coverage_report)
```

可使用以下命令：

- `cmake --build build/ --target gcovr-report:` 在 `$(BUILD_DIR_BASE)/coverage_report/html` 目录下生成 HTML 格式代码覆盖报告。
- `cmake --build build/ --target cov-data-clean:` 删除所有代码覆盖数据文件。

## 4.2 应用程序的启动流程

本文将介绍 ESP32-H2 从上电到运行 `app_main` 函数中间所经历的步骤（即启动流程）。

宏观上，该启动流程可以分为如下 3 个步骤：

1. **一级引导程序** 被固化在了 ESP32-H2 内部的 ROM 中，它会从 flash 的 0x0 偏移地址处加载二级引导程序至 RAM (IRAM & DRAM) 中。
2. **二级引导程序** 从 flash 中加载分区表和主程序镜像至内存中，主程序中包含了 RAM 段和通过 flash 高速缓存映射的只读段。
3. **应用程序启动阶段** 运行，这时第二个 CPU 和 RTOS 的调度器启动。

下面会对上述过程进行更为详细的阐述。

### 4.2.1 一级引导程序

SoC 复位后，CPU 会立即开始运行，执行所有的初始化操作。复位向量代码位于 ESP32-H2 芯片掩膜 ROM 处，且不能被修改。

复位向量调用的启动代码会根据 GPIO\_STRAP\_REG 寄存器的值来确定 ESP32-H2 的启动模式，该寄存器保存着复位后 bootstrap 引脚的电平状态。根据不同的复位原因，程序会执行如下操作：

1. 从深度睡眠模式复位：如果 RTC\_CNTL\_STORE6\_REG 寄存器的值非零，且 RTC\_CNTL\_STORE7\_REG 寄存器中的 RTC 内存的 CRC 校验值有效，那么程序会使用 RTC\_CNTL\_STORE6\_REG 寄存器的值作为入口地址，并立即跳转到该地址运行。如果 RTC\_CNTL\_STORE6\_REG 的值为零，或 RTC\_CNTL\_STORE7\_REG 中的 CRC 校验值无效，又或通过 RTC\_CNTL\_STORE6\_REG 调用的代码返回，那么则像上电复位一样继续启动。**注意：**如果想在这里运行自定义的代码，可以参考[深度睡眠](#)文档里面介绍的深度睡眠存根机制方法。
2. 上电复位、软件 SoC 复位、看门狗 SoC 复位：检查 GPIO\_STRAP\_REG 寄存器，判断是否请求自定义启动模式，如 UART 下载模式。如果是，ROM 会执行此自定义加载模式，否则会像软件 CPU 复位一样继续启动。请参考 ESP32-H2 技术规格书了解 SoC 启动模式以及具体执行过程。
3. 软件 CPU 复位、看门狗 CPU 复位：根据 EFUSE 中的值配置 SPI flash，然后尝试从 flash 中加载代码，这部分将会在后面一小节详细介绍。

---

**备注：**正常启动模式下会使能 RTC 看门狗，因此，如果进程中断或停止，看门狗将自动重置 SOC 并重新启动过程。如果 strapping GPIOs 已更改，则可能导致 SoC 陷入新的启动模式。

---

### 4.2.2 二级引导程序

在 ESP-IDF 中，存放在 flash 的 0x0 偏移地址处的二进制镜像就是二级引导程序。二级引导程序的源码可以在 ESP-IDF 的 [components/bootloader](#) 目录下找到。ESP-IDF 使用二级引导程序可以增加 flash 分区的灵活性（使用分区表），并且方便实现 flash 加密，安全引导和空中升级 (OTA) 等功能。

当一级引导程序校验并加载完二级引导程序后，它会从二进制镜像的头部找到二级引导程序的入口点，并跳转过去运行。

二级引导程序默认从 flash 的 0x8000 偏移地址处（可配置的值）读取分区表。请参考[分区表](#)获取详细信息。引导程序会寻找工厂分区和 OTA 应用程序分区。如果在分区表中找到了 OTA 应用程序分区，引导程序将查询 otadata 分区以确定应引导哪个分区。更多信息请参考[空中升级 \(OTA\)](#)。

关于 ESP-IDF 引导程序可用的配置选项，请参考[引导加载程序 \(Bootloader\)](#)。

对于选定的分区，二级引导程序将从 flash 逐段读取二进制镜像：

- 对于在内部 *IRAM*（指令 RAM）或 *DRAM*（数据 RAM）中具有加载地址的段，将把数据从 flash 复制到它们的加载地址处。
- 对于一些加载地址位于 *DROM*（数据存储在 flash 中）或 *IROM*（代码从 flash 中运行）区域的段，通过配置 flash MMU，可为从 flash 到加载地址提供正确的映射。

一旦处理完所有段（即加载了代码并设置了 flash MMU），二级引导程序将验证应用程序的完整性，并从二进制镜像文件的头部寻找入口地址，然后跳转到该地址处运行。

### 4.2.3 应用程序启动阶段

应用程序启动包含了从应用程序开始执行到 app\_main 函数在任务内部运行前的所有过程。可分为三个阶段：

- 硬件和基本 C 语言运行环境的端口初始化。
- 软件服务和 FreeRTOS 的系统初始化。
- 运行主任务并调用 app\_main。

---

**备注：**通常不需要了解 ESP-IDF 应用程序初始化的所有阶段。如果需要仅从应用程序开发人员的角度了解初始化，请跳至[运行主任务](#)。

---

## 端口初始化

ESP-IDF 应用程序的入口是 `components/esp_system/port/cpu_start.c` 文件中的 `call_start_cpu0` 函数。这个函数由二级引导加载程序执行，并且从不返回。

该端口层的初始化功能会初始化基本的 C 运行环境（“CRT”），并对 SoC 的内部硬件进行了初始配置。

- 为应用程序重新配置 CPU 异常（允许应用程序中断处理程序运行，并使用为应用程序配置的选项来处理**严重错误**，而不是使用 ROM 提供的简易版错误处理程序处理）。
- 如果没有设置选项 `CONFIG_BOOTLOADER_WDT_ENABLE`，则不使能 RTC 看门狗定时器。
- 初始化内部存储器（数据和 `bss`）。
- 完成 MMU 高速缓存配置。
- 将 CPU 时钟设置为项目配置的频率。

`call_start_cpu0` 完成运行后，将调用在 `components/esp_system/startup.c` 中找到的“系统层”初始化函数 `start_cpu0`。

## 系统初始化

主要的系统初始化函数是 `start_cpu0`。默认情况下，这个函数与 `start_cpu0_default` 函数弱链接。这意味着可以覆盖这个函数，增加一些额外的初始化步骤。

主要的系统初始化阶段包括：

- 如果默认的日志级别允许，则记录该应用程序的相关信息（项目名称、[应用程序版本](#)等）。
- 初始化堆分配器（在这之前，所有分配必须是静态的或在堆栈上）。
- 初始化 `newlib` 组件的系统调用和时间函数。
- 配置断电检测器。
- 根据[串行控制台配置](#)设置 `libc` `stdin`、`stdout`、和 `stderr`。
- 执行与安全有关的检查，包括为该配置烧录 `efuse`（包括[永久限制 ROM 下载模式](#)）。
- 初始化 SPI flash API 支持。
- 调用全局 C++ 构造函数和任何标有 `__attribute__((constructor))` 的 C 函数。

二级系统初始化允许单个组件被初始化。如果一个组件有一个用 `ESP_SYSTEM_INIT_FN` 宏注释的初始化函数，它将作为二级初始化的一部分被调用。

## 运行主任务

在所有其他组件都初始化后，主任务会被创建，FreeRTOS 调度器开始运行。

做完一些初始化任务后（需要启动调度器），主任务在固件中运行应用程序提供的函数 `app_main`。

运行 `app_main` 的主任务有一个固定的 RTOS 优先级（比最小值高）和一个[可配置的堆栈大小](#)。

与普通的 FreeRTOS 任务（或嵌入式 C 的 `main` 函数）不同，`app_main` 任务可以返回。如果 `app_main` 函数返回，那么主任务将会被删除。系统将继续运行其他的 RTOS 任务。因此可以将 `app_main` 实现为一个创建其他应用任务然后返回的函数，或主应用任务本身。

## 4.3 Bluetooth® Overview

This document provides an architecture overview of the Bluetooth stack in ESP-IDF and some quick links to related documents and application examples.

ESP32-H2 supports Bluetooth 5.0 (LE) and is certified for Bluetooth LE 5.3.

The Bluetooth stack in ESP-IDF is a layered architecture that enables Bluetooth functionality on ESP32-H2 chip series. The table below shows its architecture.



图 2: ESP32-H2 Bluetooth Stack Architecture

The table below shows whether the Bluetooth modules are supported in a specific chip series.

Chip Series	Controller	ESP-Bluedroid	ESP-NimBLE	ESP-BLE-MESH	BluFi
ESP32	Y	Y	Y	Y	Y
ESP32-S2	–	–	–	–	–
ESP32-S3	Y	Y	Y	Y	Y
ESP32-C2	Y	Y	Y	–	Y
ESP32-C3	Y	Y	Y	Y	Y
ESP32-C6	Y	Y	Y	Y	Y
ESP32-H2	Y	Y	Y	Y	–

The following sections briefly describe each layer and provide quick links to the related documents and application examples.

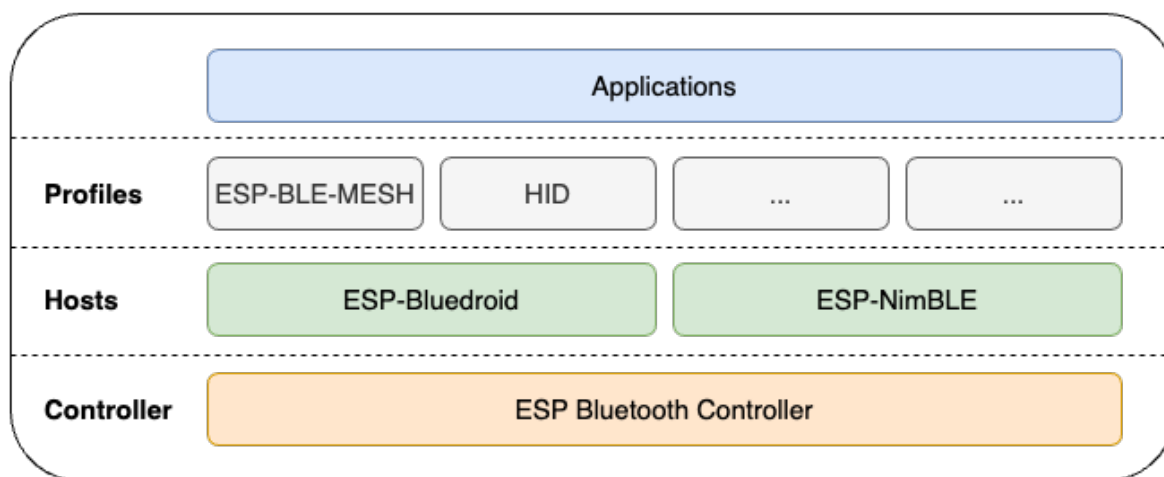
### 4.3.1 ESP Bluetooth Controller

At the bottom layer is ESP Bluetooth Controller, which encompasses various modules such as PHY, Baseband, Link Controller, Link Manager, Device Manager, and HCI. It handles hardware interface management and link management. It provides functions in the form of libraries and is accessible through APIs. This layer directly interacts with the hardware and low-level Bluetooth protocols.

- [API reference](#)
- [Application examples](#)

### 4.3.2 Hosts

There are two hosts, ESP-Bluedroid and ESP-NimBLE. The major difference between them is as follows:

- Although both support Bluetooth LE, ESP-NimBLE requires less heap and flash size.

### ESP-Bluedroid

ESP-Bluedroid is a modified version of the native Android Bluetooth stack, Bluedroid. It consists of two layers: the Bluetooth Upper Layer (BTU) and the Bluetooth Transport Controller layer (BTC). The BTU layer is responsible for processing bottom layer Bluetooth protocols such as L2CAP, GATT/ATT, SMP, GAP, and other profiles. The BTU layer provides an interface prefixed with "bta". The BTC layer is mainly responsible for providing a supported interface, prefixed with "esp", to the application layer, processing GATT-based profiles and handling miscellaneous tasks. All the APIs are located in the ESP\_API layer. Developers should use the Bluetooth APIs prefixed with "esp".

ESP-Bluedroid for ESP32-H2 supports Bluetooth LE only. Classic Bluetooth is not supported.

- API references
  - [Bluetooth® Common](#)
  - [Bluetooth LE](#)
- [Application examples](#)

### ESP-NimBLE

ESP-NimBLE is a host stack built on top of the NimBLE host stack developed by Apache Mynewt. The NimBLE host stack is ported for ESP32-H2 chip series and FreeRTOS. The porting layer is kept clean by maintaining all the existing APIs of NimBLE along with a single ESP-NimBLE API for initialization, making it simpler for the application developers.

ESP-NimBLE supports Bluetooth LE only. Classic Bluetooth is not supported.

- [Apache Mynewt NimBLE User Guide](#)
- API references
  - [NimBLE API references](#)
  - [ESP-NimBLE API references for initialization](#)
- [Application examples](#)

### 4.3.3 Profiles

Above the host stacks are the profile implementations by Espressif and some common profiles. Depending on your configuration, these profiles can run on ESP-Bluedroid or ESP-NimBLE.

### ESP-BLE-MESH

Built on top of Zephyr Bluetooth Mesh stack, the ESP-BLE-MESH implementation supports device provisioning and node control. It also supports such node features as Proxy, Relay, Low power and Friend.

- [ESP-BLE-MESH documentation](#): feature list, get started, architecture, description of application examples, frequently asked questions, etc.
- [Application examples](#)

### 4.3.4 Applications

At the uppermost layer are applications. You can build your own applications on top of the ESP-Bluedroid and ESP-NimBLE stacks, leveraging the provided APIs and profiles to create Bluetooth-enabled applications tailored to specific use cases.

## 4.4 引导加载程序 (Bootloader)

ESP-IDF 软件引导加载程序 (Bootloader) 主要执行以下任务：

1. 内部模块的最小化初始配置；
2. 如果配置了 *flash 加密* 和/或 *Secure*，则对其进行初始化。
3. 根据分区表和 *ota\_data*（如果存在）选择需要引导的应用程序 (app) 分区；
4. 将此应用程序镜像加载到 RAM (IRAM 和 DRAM) 中，最后把控制权转交给此应用程序。

引导加载程序位于 flash 的 0x0 偏移地址处。

关于启动过程以及 ESP-IDF 引导加载程序的更多信息，请参考[应用程序的启动流程](#)。

### 4.4.1 引导加载程序兼容性

建议使用最新发布的 *ESP-IDF* 版本。OTA（空中升级）更新可以在现场烧录新的应用程序，但不能烧录一个新的引导加载程序。因此，引导加载程序支持引导从 ESP-IDF 新版本中构建的应用程序。

但不支持引导从 ESP-IDF 旧版本中构建的程序。如果现有产品可能需要将应用程序降级到旧版本，那么在手动更新 ESP-IDF 时，请继续使用旧版本 ESP-IDF 引导加载程序的二进制文件。

---

**备注：**如果在生产中测试现有产品的 OTA 更新，请确保测试中使用的 ESP-IDF 引导加载程序二进制文件与生产中部署的相同。

---

### 配置 SPI flash

每个 ESP-IDF 应用程序或引导加载程序的二进制文件中都包含一个文件头，其中内置了 *CONFIG\_ESPTOOLPY\_FLASHMODE*、*CONFIG\_ESPTOOLPY\_FLASHFREQ*、和 *CONFIG\_ESPTOOLPY\_FLASHSIZE*。这些是用于在启动时配置 SPI flash。

ROM 中的一级引导程序从 flash 中读取二级引导程序文件头中的配置信息，并使用这些信息来加载剩余的二级引导程序。然而，此时系统的时钟速度低于其被配置的速度，并且在这个阶段，只支持部分 flash 模式。因此，当二级引导程序运行时，它会从当前应用程序的二进制文件头中读取数据（而不是从引导加载程序的文件头中读取数据），并使用这些数据重新配置 flash。这样的配置流程可让 OTA 更新去更改当前使用的 SPI flash 的配置。

### 4.4.2 日志级别

引导加载程序日志的级别默认为“Info”。通过设置 *CONFIG\_BOOTLOADER\_LOG\_LEVEL* 选项，可以增加或减少这个等级。这个日志级别与应用程序中使用的日志级别是分开的（见[日志库](#)）。

降低引导加载程序日志的详细程度可以稍微缩短整个项目的启动时间。

### 4.4.3 恢复出厂设置

在更新出现问题时，最好能有一种方法让设备回到已知的正常状态，这时可选择恢复出厂设置。

要回到原始出厂设置并清除所有用户设置，请在引导加载程序中配置 *CONFIG\_BOOTLOADER\_FACTORY\_RESET*。

以下两种方式可以将设备恢复出厂设置。

- 清除一个或多个数据分区。 *CONFIG\_BOOTLOADER\_DATA\_FACTORY\_RESET* 选项允许用户选择哪些数据分区在恢复出厂设置时需要被擦除。用户可以使用以逗号分隔的列表形式指定分区的名称，为了提高可读性，可以选择添加空格（如： *nvs*, *phy\_init*, *nvs\_custom*）。



请确保选项里指定的分区名称和分区表中的名称相同。此处不能指定“app”类型的分区。

- 从“工厂”应用分区启动。当启用 `CONFIG_BOOTLOADER_OTA_DATA_ERASE` 选项，恢复出厂设置后，设备将从默认的“工厂”应用分区启动（如果分区表中没有“工厂”应用分区，则从默认的 OTA 应用分区启动）。这个恢复过程是通过擦除 OTA 数据分区来完成的，OTA 数据分区中保存了当前选择的 OTA 分区槽。“工厂”应用分区槽（如果存在）永远不会通过 OTA 更新，因此重置为从“工厂”应用分区启动则意味着让固件应用程序恢复正常状态。

这两个配置选项都可以独立启用。

此外，以下配置选项用于配置触发恢复出厂设置的条件：

- `CONFIG_BOOTLOADER_NUM_PIN_FACTORY_RESET` - 输入管脚 (GPIO) 的编号，该管脚用于触发恢复出厂设置。必须在重置时将此管脚拉低或拉高（可配置）才能触发出厂重置事件。
- `CONFIG_BOOTLOADER_HOLD_TIME_GPIO` - 管脚电平保持时间（默认为 5 秒）。设备重置后，管脚电平必须保持该设定的时间，才能执行恢复出厂设置或引导测试分区（如适用）。
- `CONFIG_BOOTLOADER_FACTORY_RESET_PIN_LEVEL` - 设置管脚电平高低。设备重置后，根据此设置将管脚拉高或拉低，才能触发出厂重置事件。如果管脚具有内部上拉，则上拉会在管脚采样前生效。有关管脚内部上拉的详细信息，请参考 ESP32-H2 的技术规格书。

如果应用程序需要知道设备是否触发了出厂重置，可以通过调用 `bootloader_common_get_rtc_retain_mem_factory_reset_state()` 函数来确定：

- 如果读取到设备出厂重置状态为 `true`，会返回状态 `true`，说明设备已经触发出厂重置。此后会重置状态为 `false`，以便后续的出厂重置触发判断。
- 如果读取到设备出厂重置状态为 `false`，会返回状态 `false`，说明设备并未触发出厂重置，或者保存此状态的内存区域已失效。

同时需要注意该功能需要占用部分 RTC FAST 内存（占用的内存与 `CONFIG_BOOTLOADER_SKIP_VALIDATE_IN_DEEP_SLEEP` 大小相同）。

#### 4.4.4 从测试固件启动

用户可以编写特殊固件用于生产环境中测试，并在需要的时候运行。此时需要在项目分区表中专门申请一块分区用于保存该测试固件，其类型为 `app`，子类型为 `test`（详情请参考分区表）。

实现该测试应用固件需要为测试应用创建一个完全独立的 ESP-IDF 项目（ESP-IDF 中的每个项目仅构建一个应用）。该测试应用可以独立于主项目进行开发和测试，然后在生成测试时作为一个预编译 `.bin` 文件集成到主项目的测试应用程序分区的地址。

要在主项目的引导加载程序中支持这个功能，请设置 `CONFIG_BOOTLOADER_APP_TEST` 并配置以下三个选项：

- `CONFIG_BOOTLOADER_NUM_PIN_APP_TEST` - 设置启动 TEST 分区的管脚编号，该管脚将被配置为输入并启用内部上拉。要触发测试应用，必须在重置时将此管脚拉低或拉高（可配置）。  
释放管脚输入并重启设备后，将重新启用默认的启动顺序，即启动工厂分区或任意 OTA 应用分区槽。
- `CONFIG_BOOTLOADER_HOLD_TIME_GPIO` - 设置 GPIO 电平保持的时间，默认为 5 秒。设备重置后，管脚电平必须保持该设定的时间，才能执行恢复出厂设置或引导测试分区（如适用）。
- `CONFIG_BOOTLOADER_APP_TEST_PIN_LEVEL` - 配置应在 GPIO 的高电平还是低电平上触发测试分区启动。若 GPIO 有内部上拉，则该功能在采样管脚前就会被启用。关于管脚内部上拉的详细信息，请参考 ESP32-H2 数据规格书。

#### 4.4.5 回滚

回滚和反回滚功能也必须在引导程序中配置。

请参考 [OTA API 参考文档](#) 中的 [应用程序回滚](#) 和 [防回滚](#) 章节。

## 4.4.6 看门狗

芯片配备两组看门狗定时器：主系统看门狗定时器 (MWDT\_WDT) 和 RTC 看门狗定时器 (RTC\_WDT)。芯片上电时，两组看门狗定时器都会被启用，但在引导加载程序中，两组看门狗定时器都会被禁用。设置 `CONFIG_BOOTLOADER_WDT_ENABLE`（默认设置）可以重新启用 RTC 看门狗定时器，用于跟踪从启用引导加载程序到调用用户主函数的时间。此期间内 RTC 看门狗定时器始终可用，并且如果在 9 秒内没有应用程序成功启动，则 RTC 看门狗定时器会自动重置芯片。这一功能可以有效防止启动过程中由于电源不稳定而导致的死机。

- 可以通过设置 `CONFIG_BOOTLOADER_WDT_TIME_MS` 并重新编译引导加载程序来调整超时时间。
- 通过禁用 `CONFIG_BOOTLOADER_WDT_ENABLE` 设置并重新编译引导加载程序，可以在引导加载程序中禁用 RTC 看门狗，但并不建议这样做。
- 请参阅 [硬件看门狗定时器](#)，了解如何在应用程序中使用 RTC\_WDT。

## 4.4.7 引导加载程序大小

当需要启用额外的引导加载程序功能，包括 [flash 加密](#) 或安全启动，尤其是设置高级别 `CONFIG_BOOTLOADER_LOG_LEVEL` 时，监控引导加载程序 .bin 文件的大小变得非常重要。

当使用默认的 `CONFIG_PARTITION_TABLE_OFFSET` 值 0x8000 时，二进制文件最大可为 0x8000 字节。

如果引导加载程序二进制文件过大，则引导加载程序会构建将失败并显示“Bootloader binary size [..] is too large for partition table offset”的错误。如果此二进制文件已经被烧录，那么 ESP32-H2 将无法启动 - 日志中将记录无效分区表或无效引导加载程序校验和的错误。

可以使用如下方法解决此问题：

- 将 [bootloader 编译器优化](#) 重新设置回默认值 “Size”。
- 降低 [引导加载程序日志级别](#)。将日志级别设置为 Warning, Error 或 None 都会显著减少最终二进制文件的大小（但也可能会让调试变得更加困难）。
- 将 `CONFIG_PARTITION_TABLE_OFFSET` 设置为高于 0x8000 的值，以便稍后将分区表放置在 flash 中，这样可以增加引导加载程序的可用空间。如果 [分区表](#) 的 CSV 文件包含明确的分区偏移量，则需要修改这些偏移量，从而保证没有分区的偏移量低于 `CONFIG_PARTITION_TABLE_OFFSET + 0x1000`。（这包括随 ESP-IDF 提供的默认分区 CSV 文件）

当启用 Secure Boot V2 时，由于引导加载程序最先加载到固定大小的缓冲区中进行验证，对二进制文件大小的绝对限制为 64 KB (0x10000 bytes)（不包括 4 KB 签名）。

## 4.4.8 从深度睡眠中快速启动

引导加载程序有 `CONFIG_BOOTLOADER_SKIP_VALIDATE_IN_DEEP_SLEEP` 选项，可以减少从深度睡眠中唤醒的时间（有利于降低功耗）。当 `CONFIG_SECURE_BOOT` 选项禁用时，该选项可用。由于无需镜像校验，唤醒时间减少。在第一次启动时，引导加载程序将启动的应用程序的地址存储在 RTC FAST 存储器中。而在唤醒过程中，这个地址用于启动而无需任何检查，从而实现了快速加载。

## 4.4.9 自定义引导加载程序

用户可以扩展或修改当前的引导加载程序，具体有两种方法：使用钩子实现或重写覆盖当前程序。这两种方法在 ESP-IDF 示例的 `custom_bootloader` 文件夹中都有呈现。

- `bootloader_hooks` 介绍了如何将钩子与引导加载程序初始化连接。
- `bootloader_override` 介绍了如何覆盖引导加载程序的实现。

在引导加载程序的代码中，用户不能使用其他组件提供的驱动和函数，如果确实需要，请将该功能的实现部分放在项目的 `bootloader_components` 目录中（注意，这会增加引导加载程序的大小）。

如果引导加载程序过大，则可能与内存中的分区表重叠，分区表默认烧录在偏移量 0x8000 处。增加 [分区表偏移量](#)，将分区表放在 flash 中靠后的区域，这样可以增加引导程序的可用空间。



## 4.5 构建系统

本文档主要介绍 ESP-IDF 构建系统的实现原理以及 组件等相关概念。如需了解如何组织和构建新的 ESP-IDF 项目或组件，请阅读本文档。

### 4.5.1 概述

一个 ESP-IDF 项目可以看作是多个不同组件的集合，例如一个显示当前湿度的网页服务器会包含以下组件：

- ESP-IDF 基础库，包括 `libc`、`ROM bindings` 等
- Wi-Fi 驱动
- TCP/IP 协议栈
- FreeRTOS 操作系统
- 网页服务器
- 湿度传感器的驱动
- 负责将上述组件整合到一起的主程序

ESP-IDF 可以显式地指定和配置每个组件。在构建项目的时候，构建系统会前往 ESP-IDF 目录、项目目录和用户自定义组件目录（可选）中查找所有组件，允许用户通过文本菜单系统配置 ESP-IDF 项目中用到的每个组件。在所有组件配置结束后，构建系统开始编译整个项目。

#### 概念

- 项目特指一个目录，其中包含了构建可执行应用程序所需的全部文件和配置，以及其他支持型文件，例如分区表、数据/文件系统分区和引导程序。
- 项目配置保存在项目根目录下名为 `sdkconfig` 的文件中，可以通过 `idf.py menuconfig` 进行修改，且一个项目只能包含一个项目配置。
- 应用程序是由 ESP-IDF 构建得到的可执行文件。一个项目通常会构建两个应用程序：项目应用程序（可执行的主文件，即用户自定义的固件）和引导程序（启动并初始化项目应用程序）。
- 组件是模块化且独立的代码，会被编译成静态库（.a 文件）并链接到应用程序。部分组件由 ESP-IDF 官方提供，其他组件则来源于其它开源项目。
- 目标特指运行构建后应用程序的硬件设备。运行 `idf.py --list-targets` 可以查看当前 ESP-IDF 版本中支持目标的完整列表。

请注意，以下内容并不属于项目的组成部分：

- ESP-IDF 并不是项目的一部分，它独立于项目，通过 `IDF_PATH` 环境变量（保存 `esp-idf` 目录的路径）链接到项目，从而将 IDF 框架与项目分离。
- 交叉编译工具链并不是项目的组成部分，它应该被安装在系统 `PATH` 环境变量中。

### 4.5.2 使用构建系统

#### idf.py

`idf.py` 命令行工具提供了一个前端，可以帮助你轻松管理项目的构建过程，它管理了以下工具：

- `CMake`，配置待构建的项目
- `Ninja`，用于构建项目
- `esptool.py`，烧录目标硬件设备

可通过 `idf.py` 配置构建系统，具体可参考[相关文档](#)。

## 直接使用 CMake

为了方便，`idf.py` 已经封装了 CMake 命令，但是你愿意，也可以直接调用 CMake。

当 `idf.py` 在执行某些操作时，它会打印出其运行的每条命令以便参考。例如运行 `idf.py build` 命令与在 `bash shell`（或者 Windows Command Prompt）中运行以下命令是相同的：

```
mkdir -p build
cd build
cmake .. -G Ninja # 或者 'Unix Makefiles'
ninja
```

在上面的命令列表中，`cmake` 命令对项目进行配置，并生成用于最终构建工具的构建文件。在这个例子中，最终构建工具是 **Ninja**：运行 `ninja` 来构建项目。

没有必要多次运行 `cmake`。第一次构建后，往后每次只需运行 `ninja` 即可。如果项目需要重新配置，`ninja` 会自动重新调用 `cmake`。

若在 CMake 中使用 `ninja` 或 `make`，则多数 `idf.py` 子命令也会有其对应的目标，例如在构建目录下运行 `make menuconfig` 或 `ninja menuconfig` 与运行 `idf.py menuconfig` 是相同的。

---

**备注：**如果你已经熟悉了 CMake，那么可能会发现 ESP-IDF 的 CMake 构建系统不同寻常，为了减少样板文件，该系统封装了 CMake 的许多功能。请参考 [编写纯 CMake 组件](#) 以编写更多“CMake 风格”的组件。

---

**使用 Ninja/Make 来烧录** 可以直接使用 `ninja` 或 `make` 运行如下命令来构建项目并烧录：

```
ninja flash
```

或：

```
make app-flash
```

可用的目标还包括：`flash`、`app-flash`（仅用于 `app`）、`bootloader-flash`（仅用于 `bootloader`）。

以这种方式烧录时，可以通过设置 `ESPPORT` 和 `ESPBAUD` 环境变量来指定串口设备和波特率。可以在操作系统或 IDE 项目中设置该环境变量，或者直接在命令行中进行设置：

```
ESPPORT=/dev/ttyUSB0 ninja flash
```

---

**备注：**在命令的开头为环境变量赋值属于 Bash shell 的语法，可在 Linux、macOS 和 Windows 的类 Bash shell 中运行，但在 Windows Command Prompt 中无法运行。

---

或：

```
make -j3 app-flash ESPPORT=COM4 ESPBAUD=2000000
```

---

**备注：**在命令末尾为变量赋值属于 `make` 的语法，适用于所有平台的 `make`。

---

## 在 IDE 中使用 CMake

还可以使用集成了 CMake 的 IDE，仅需将项目 `CMakeLists.txt` 文件的路径告诉 IDE 即可。集成 CMake 的 IDE 通常会有自己的构建工具（CMake 称之为“生成器”），它是组成 IDE 的一部分，用来构建源文件。

向 IDE 中添加除 `build` 目标以外的自定义目标（如添加“`flash`”目标到 IDE）时，建议调用 `idf.py` 命令来执行这些“特殊”的操作。

有关将 ESP-IDF 同 CMake 集成到 IDE 中的详细信息，请参阅[构建系统的元数据](#)。

## 设置 Python 解释器

ESP-IDF 适用于 Python 3.8 以上版本。

`idf.py` 和其他的 Python 脚本会使用默认的 Python 解释器运行，如 `python`。你可以通过 `python3 $IDF_PATH/tools/idf.py ...` 命令切换到别的 Python 解释器，或者通过设置 `shell` 别名或其他脚本来简化该命令。

如果直接使用 CMake，运行 `cmake -D PYTHON=python3 ...`，CMake 会使用传入的值覆盖默认的 Python 解释器。

如果使用集成 CMake 的 IDE，可以在 IDE 的图形用户界面中给名为 `PYTHON` 的 CMake cache 变量设置新的值来覆盖默认的 Python 解释器。

如果想在命令行中更优雅地管理 Python 的各个版本，请查看 [pyenv](#) 或 [virtualenv](#) 工具，它们会帮助你更改默认的 `python` 版本。

## 4.5.3 示例项目

示例项目的目录树结构可能如下所示：

```

- myProject/
  - CMakeLists.txt
  - sdkconfig
  - bootloader_components/ - boot_component/ - CMakeLists.txt
                                     - Kconfig
                                     - src1.c
  - components/ - component1/ - CMakeLists.txt
                                     - Kconfig
                                     - src1.c
                                     - component2/ - CMakeLists.txt
                                               - Kconfig
                                               - src1.c
                                               - include/ - component2.h
  - main/ - CMakeLists.txt
          - src1.c
          - src2.c
  - build/

```

该示例项目“myProject”包含以下组成部分：

- 顶层项目 `CMakeLists.txt` 文件，这是 CMake 用于学习如何构建项目的主要文件，可以在这个文件中设置项目全局的 CMake 变量。顶层项目 `CMakeLists.txt` 文件会导入 `/tools/cmake/project.cmake` 文件，由它负责实现构建系统的其余部分。该文件最后会设置项目的名称，并定义该项目。
- “`sdkconfig`”项目配置文件，执行 `idf.py menuconfig` 时会创建或更新此文件，文件中保存了项目中所有组件（包括 ESP-IDF 本身）的配置信息。`sdkconfig` 文件可能会也可能不会被添加到项目的源码管理系统中。
- 可选的“`bootloader_components`”目录中包含了需要在引导加载项目中进行编译和链接的组件。并不是每个项目都需要这种自定义组件，但此类组件在引导加载程序需要修改以嵌入新功能时可能很有用。
- 可选的“`components`”目录中包含了项目的部分自定义组件，并不是每个项目都需要这种自定义组件，但它有助于构建可复用的代码或者导入第三方（不属于 ESP-IDF）的组件。或者，你也可以在顶层 `CMakeLists.txt` 中设置 `EXTRA_COMPONENT_DIRS` 变量以查找其他指定位置处的组件。
- “`main`”目录是一个特殊的组件，它包含项目本身的源代码。“`main`”是默认名称，CMake 变量 `COMPONENT_DIRS` 默认包含此组件，但你可以修改此变量。有关详细信息，请参阅[重命名 main 组件](#)。如果项目中源文件较多，建议将其归于组件中，而不是全部放在“`main`”中。

- “build” 目录是存放构建输出的地方，如果没有此目录，idf.py 会自动创建。CMake 会配置项目，并在此目录下生成临时的构建文件。随后，在主构建进程的运行期间，该目录还会保存临时目标文件、库文件以及最终输出的二进制文件。此目录通常不会添加到项目的源码管理系统中，也不会随项目源码一同发布。

每个组件目录都包含一个 CMakeLists.txt 文件，里面会定义一些变量以控制该组件的构建过程，以及其与整个项目的集成。更多详细信息请参阅[组件 CMakeLists 文件](#)。

每个组件还可以包含一个 Kconfig 文件，它用于定义 menuconfig 时展示的[组件配置](#)选项。某些组件可能还会包含 Kconfig.projbuild 和 project\_include.cmake 特殊文件，它们用于[覆盖项目的部分设置](#)。

#### 4.5.4 项目 CMakeLists 文件

每个项目都有一个顶层 CMakeLists.txt 文件，包含整个项目的构建设置。默认情况下，项目 CMakeLists 文件会非常小。

##### 最小 CMakeLists 文件示例

最小项目：

```
cmake_minimum_required(VERSION 3.16)
include($ENV{IDF_PATH}/tools/cmake/project.cmake)
project(myProject)
```

##### 必要部分

每个项目都要按照上面显示的顺序添加上述三行代码：

- cmake\_minimum\_required(VERSION 3.16) 必须放在 CMakeLists.txt 文件的第一行，它会告诉 CMake 构建该项目所需要的最小版本号。ESP-IDF 支持 CMake 3.16 或更高的版本。
- include(\$ENV{IDF\_PATH}/tools/cmake/project.cmake) 会导入 CMake 的其余功能来完成配置项目、检索组件等任务。
- project(myProject) 会创建项目本身，并指定项目名称。该名称会作为最终输出的二进制文件的名称，即 myProject.elf 和 myProject.bin。每个 CMakeLists 文件只能定义一个项目。

##### 可选的项目变量

以下这些变量都有默认值，用户可以覆盖这些变量值以自定义构建行为。更多实现细节，请参阅[tools/cmake/project.cmake](#) 文件。

- COMPONENT\_DIRS: 组件的搜索目录，默认为 IDF\_PATH/components、PROJECT\_DIR/components、和 EXTRA\_COMPONENT\_DIRS。如果你不想在这些位置搜索组件，请覆盖此变量。
- EXTRA\_COMPONENT\_DIRS: 用于搜索组件的其它可选目录列表。路径可以是相对于项目目录的相对路径，也可以是绝对路径。
- COMPONENTS: 要构建进项目中的组件名称列表，默认为 COMPONENT\_DIRS 目录下检索到的所有组件。使用此变量可以“精简”项目以缩短构建时间。请注意，如果一个组件通过 COMPONENT\_REQUIRES 指定了它依赖的另一个组件，则会自动将其添加到 COMPONENTS 中，所以 COMPONENTS 列表可能会非常短。
- BOOTLOADER\_IGNORE\_EXTRA\_COMPONENT: 引导加载程序编译时应忽略的组件列表，位于 bootloader\_components/ 目录中。使用这一变量可以将一个组件有条件地包含在项目中。

以上变量中的路径可以是绝对路径，或者是相对于项目目录的相对路径。

请使用 `cmake` 中的 `set` 命令来设置这些变量，如 `set(VARIABLE "VALUE")`。请注意，`set()` 命令需放在 `include(...)` 之前，`cmake_minimum(...)` 之后。

## 重命名 main 组件

构建系统会对 main 组件进行特殊处理。假如 main 组件位于预期的位置（即 `/${PROJECT_PATH}/main`），那么它会被自动添加到构建系统中。其他组件也会作为其依赖项被添加到构建系统中，这使用户免于处理依赖关系，并提供即时可用的构建功能。重命名 main 组件会减轻上述这些幕后工作量，但要求用户指定重命名后的组件位置，并手动为其添加依赖项。重命名 main 组件的步骤如下：

1. 重命名 main 目录。
2. 在项目 `CMakeLists.txt` 文件中设置 `EXTRA_COMPONENT_DIRS`，并添加重命名后的 main 目录。
3. 在组件的 `CMakeLists.txt` 文件中设置 `COMPONENT_REQUIRES` 或 `COMPONENT_PRIV_REQUIRES` 以指定依赖项。

## 覆盖默认的构建规范

构建系统设置了一些全局的构建规范（编译标志、定义等），这些规范可用于编译来自所有组件的所有源文件。

例如，其中一个默认的构建规范是编译选项 `Wextra`。假设一个用户想用 `Wno-extra` 来覆盖这个选项，应在 `project()` 之后进行：

```
cmake_minimum_required(VERSION 3.16)
include($ENV{IDF_PATH}/tools/cmake/project.cmake)
project(myProject)

idf_build_set_property(COMPILER_OPTIONS "-Wno-error" APPEND)
```

这确保了用户设置的编译选项不会被默认的构建规范所覆盖，因为默认的构建规范是在 `project()` 内设置的。

### 4.5.5 组件 CMakeLists 文件

每个项目都包含一个或多个组件，这些组件可以是 ESP-IDF 的一部分，可以是项目自身组件目录的一部分，也可以从自定义组件目录添加（见上文）。

组件是 `COMPONENT_DIRS` 列表中包含 `CMakeLists.txt` 文件的任何目录。

## 搜索组件

搜索 `COMPONENT_DIRS` 中的目录列表以查找项目的组件，此列表中的目录可以是组件自身（即包含 `CMakeLists.txt` 文件的目录），也可以是子目录为组件的顶级目录。

当 CMake 运行项目配置时，它会记录本次构建包含的组件列表，它可用于调试某些组件的添加/排除。

## 同名组件

ESP-IDF 在搜索所有待构建的组件时，会按照 `COMPONENT_DIRS` 指定的顺序依次进行，这意味着在默认情况下，首先搜索 ESP-IDF 内部组件（`IDF_PATH/components`），然后是 `EXTRA_COMPONENT_DIRS` 中的组件，最后是项目组件（`PROJECT_DIR/components`）。如果这些目录中的两个或者多个包含具有相同名字的组件，则使用搜索到的最后一个位置的组件。这就允许将组件复制到项目目录中再修改以覆盖 ESP-IDF 组件，如果使用这种方式，ESP-IDF 目录本身可以保持不变。

---

**备注：**如果在现有项目中通过将组件移动到一个新位置来覆盖它，项目不会自动看到新组件的路径。请运行 `idf.py reconfigure` 命令后（或删除项目构建文件夹）再重新构建。

---



## 最小组件 CMakeLists 文件

最小组件 CMakeLists.txt 文件通过使用 `idf_component_register` 将组件添加到构建系统中。

```
idf_component_register(SRCS "foo.c" "bar.c" INCLUDE_DIRS "include" REQUIRES mbedtls)
```

- SRCS 是源文件列表 (\*.c、\*.cpp、\*.cc、\*.s)，里面所有的源文件都将会编译进组件库中。
- INCLUDE\_DIRS 是目录列表，里面的路径会被添加到所有需要该组件的组件（包括 main 组件）全局 include 搜索路径中。
- REQUIRES 实际上并不是必需的，但通常需要它来声明该组件需要使用哪些其它组件，请参考[组件依赖](#)。

上述命令会构建生成与组件同名的库，并最终被链接到应用程序中。

上述目录通常设置为相对于 CMakeLists.txt 文件的相对路径，当然也可以设置为绝对路径。

还有其它参数可以传递给 `idf_component_register`，具体可参考[here](#)。

有关更完整的 CMakeLists.txt 示例，请参阅[组件依赖示例](#)和[组件 CMakeLists 示例](#)。

## 预设的组件变量

以下专用于组件的变量可以在组件 CMakeLists 中使用，但不建议修改：

- COMPONENT\_DIR: 组件目录，即包含 CMakeLists.txt 文件的绝对路径，它与 CMAKE\_CURRENT\_SOURCE\_DIR 变量一样，路径中不能包含空格。
- COMPONENT\_NAME: 组件名，与组件目录名相同。
- COMPONENT\_ALIAS: 库别名，由构建系统在内部为组件创建。
- COMPONENT\_LIB: 库名，由构建系统在内部为组件创建。

以下变量在项目级别中被设置，但可在组件 CMakeLists 中使用：

- CONFIG\_\*: 项目配置中的每个值在 `cmake` 中都对应一个以 CONFIG\_ 开头的变量。更多详细信息请参阅[Kconfig](#)。
- ESP\_PLATFORM: ESP-IDF 构建系统处理 CMake 文件时，其值设为 1。

## 构建/项目变量

以下是可作为构建属性的构建/项目变量，可通过组件 CMakeLists.txt 中的 `idf_build_get_property` 查询其变量值。

- PROJECT\_NAME: 项目名，在项目 CMakeLists.txt 文件中设置。
- PROJECT\_DIR: 项目目录（包含项目 CMakeLists 文件）的绝对路径，与 CMAKE\_SOURCE\_DIR 变量相同。
- COMPONENTS: 此次构建中包含的所有组件的名称，具体格式为用分号分隔的 CMake 列表。
- IDF\_VER: ESP-IDF 的 git 版本号，由 `git describe` 命令生成。
- IDF\_VERSION\_MAJOR、IDF\_VERSION\_MINOR、IDF\_VERSION\_PATCH: ESP-IDF 的组件版本，可用于条件表达式。请注意这些信息的精确度不如 IDF\_VER 变量，版本号 v4.0-dev-\*, v4.0-beta1, v4.0-rc1 和 v4.0 对应的 IDF\_VERSION\_\* 变量值是相同的，但是 IDF\_VER 的值是不同的。
- IDF\_TARGET: 项目的硬件目标名称。
- PROJECT\_VER: 项目版本号。
  - 如果设置 `CONFIG_APP_PROJECT_VER_FROM_CONFIG` 选项，将会使用 `CONFIG_APP_PROJECT_VER` 的值。
  - 或者，如果在项目 CMakeLists.txt 文件中设置了 PROJECT\_VER 变量，则该变量值可以使用。
  - 或者，如果 PROJECT\_DIR/version.txt 文件存在，其内容会用作 PROJECT\_VER 的值。
  - 或者，如果在 CMakeLists.txt 文件中将 VERSION 参数传递给 `project()` 调用，形式为 `project(... VERSION x.y.z.w)`，那么 VERSION 参数将用作为 PROJECT\_VER 的值。VERSION 参数必须符合 [cmake 标准](#)。
  - 或者，如果项目位于某个 Git 仓库中，则使用 `git describe` 命令的输出作为 PROJECT\_VER 的值。

- 否则，PROJECT\_VER 的值为 1。
- EXTRA\_PARTITION\_SUBTYPES: CMake 列表，用于创建额外的分区子类型。子类型的描述由字符串组成，以逗号为分隔，格式为 `type_name, subtype_name, numeric_value`。组件可通过此列表，添加新的子类型。

其它与构建属性有关的信息请参考[这里](#)。

### 组件编译控制

在编译特定组件的源文件时，可以使用 `target_compile_options` 函数来传递编译器选项：

```
target_compile_options(${COMPONENT_LIB} PRIVATE -Wno-unused-variable)
```

如果给单个源文件指定编译器标志，可以使用 CMake 的 `set_source_files_properties` 命令：

```
set_source_files_properties(mysrc.c
    PROPERTIES COMPILE_FLAGS
        -Wno-unused-variable
)
```

如果上游代码在编译的时候发出了警告，那这么做可能会很有效。

---

**备注：** 如已借助 `idf_component_register` 中的 `SRC_DIRS` 变量填充源文件，CMake `set_source_files_properties` 命令将无法使用，详情请参考[文件通配 & 增量构建](#)。

---

请注意，上述两条命令只能在组件 CMakeLists 文件的 `idf_component_register` 命令之后调用。

### 4.5.6 组件配置

每个组件都可以包含一个 Kconfig 文件，和 CMakeLists.txt 放在同一目录下。Kconfig 文件中包含要添加到该组件配置菜单中的一些配置设置信息。

运行 `menuconfig` 时，可以在 Component Settings 菜单栏下找到这些设置。

创建一个组件的 Kconfig 文件，最简单的方法就是使用 ESP-IDF 中现有的 Kconfig 文件作为模板，在此基础上进行修改。

有关示例请参阅[添加条件配置](#)。

### 4.5.7 预处理器定义

ESP-IDF 构建系统会在命令行中添加以下 C 预处理器定义：

- ESP\_PLATFORM: 可以用来检测在 ESP-IDF 内发生了构建行为。
- IDF\_VER: 定义 git 版本字符串，例如: `v2.0` 用于标记已发布的版本，`v1.0-275-g0efaa4f` 则用于标记任意某次的提交记录。

### 4.5.8 组件依赖

编译各个组件时，ESP-IDF 系统会递归评估其依赖项。这意味着每个组件都需要声明它所依赖的组件，即 “requires”。

### 编写组件

```
idf_component_register(...
    REQUIRES mbedtls
    PRIV_REQUIRES console spiffs)
```

- REQUIRES 需要包含所有在当前组件的公共头文件里 `#include` 的头文件所在的组件。
- PRIV\_REQUIRES 需要包含被当前组件的源文件 `#include` 的头文件所在的组件（除非已经被设置在了 REQUIRES 中）。以及是当前组件正常工作必须要链接的组件。
- REQUIRES 和 PRIV\_REQUIRES 的值不能依赖于任何配置选项（CONFIG\_XXX 宏）。这是因为在配置加载之前，依赖关系就已经被展开。其它组件变量（比如包含路径或源文件）可以依赖配置选择。
- 如果当前组件除了通用组件依赖项中设置的通用组件（比如 RTOS、libc 等）外，并不依赖其它组件，那么对于上述两个 REQUIRES 变量，可以选择其中一个或是两个都不设置。

如果组件仅支持某些硬件目标（IDF\_TARGET 的值），则可以在 `idf_component_register` 中指定 `REQUIRED_IDF_TARGETS` 来声明这个需求。在这种情况下，如果构建系统导入了不支持当前硬件目标的组件时就会报错。

**备注：**在 CMake 中，REQUIRES 和 PRIV\_REQUIRES 是 CMake 函数 `target_link_libraries(... PUBLIC ...)` 和 `target_link_libraries(... PRIVATE ...)` 的近似包装。

### 组件依赖示例

假设现在有一个 `car` 组件，它需要使用 `engine` 组件，而 `engine` 组件需要使用 `spark_plug` 组件：

```
- autoProject/
  - CMakeLists.txt
  - components/ - car/ - CMakeLists.txt
    - car.c
    - car.h
  - engine/ - CMakeLists.txt
    - engine.c
    - include/ - engine.h
  - spark_plug/ - CMakeLists.txt
    - spark_plug.c
    - spark_plug.h
```

**Car 组件** `car.h` 头文件是 `car` 组件的公共接口。该头文件直接包含了 `engine.h`，这是因为它需要使用 `engine.h` 中的一些声明：

```
/* car.h */
#include "engine.h"

#ifdef ENGINE_IS_HYBRID
#define CAR_MODEL "Hybrid"
#endif
```

同时 `car.c` 也包含了 `car.h`：

```
/* car.c */
#include "car.h"
```

这代表文件 `car/CMakeLists.txt` 需要声明 `car` 需要 `engine`：

```
idf_component_register(SRCS "car.c"
    INCLUDE_DIRS "."
    REQUIRES engine)
```

- SRCS 提供 `car` 组件中源文件列表。



- INCLUDE\_DIRS 提供该组件公共头文件目录列表，由于 car.h 是公共接口，所以这里列出了所有包含了 car.h 的目录。
- REQUIRES 给出该组件的公共接口所需的组件列表。由于 car.h 是一个公共头文件并且包含了来自 engine 的头文件，所以我们这里包含 engine。这样可以确保任何包含 car.h 的其他组件也能递归地包含所需的 engine.h。

**Engine 组件** engine 组件也有一个公共头文件 include/engine.h，但这个头文件更为简单：

```
/* engine.h */
#define ENGINE_IS_HYBRID

void engine_start(void);
```

在 engine.c 中执行：

```
/* engine.c */
#include "engine.h"
#include "spark_plug.h"

...
```

在该组件中，engine 依赖于 spark\_plug，但这是私有依赖关系。编译 engine.c 需要 spark\_plug.h 但不需要包含 engine.h。

这代表文件 engine/CMakeLists.txt 可以使用 PRIV\_REQUIRES：

```
idf_component_register(SRCS "engine.c"
                      INCLUDE_DIRS "include"
                      PRIV_REQUIRES spark_plug)
```

因此，car 组件中的源文件不需要在编译器搜索路径中添加 spark\_plug include 目录。这可以加快编译速度，避免编译器命令行过于的冗长。

**Spark Plug 组件** spark\_plug 组件没有依赖项，它有一个公共头文件 spark\_plug.h，但不包含其他组件的头文件。

这代表 spark\_plug/CMakeLists.txt 文件不需要任何 REQUIRES 或 PRIV\_REQUIRES：

```
idf_component_register(SRCS "spark_plug.c"
                      INCLUDE_DIRS ".")
```

## 源文件 Include 目录

每个组件的源文件都是用这些 Include 路径目录编译的，这些路径在传递给 idf\_component\_register 的参数中指定：

```
idf_component_register(..
                      INCLUDE_DIRS "include"
                      PRIV_INCLUDE_DIRS "other")
```

- 当前组件的 INCLUDE\_DIRS 和 PRIV\_INCLUDE\_DIRS。
- REQUIRES 和 PRIV\_REQUIRES 参数指定的所有其他组件（即当前组件的所有公共和私有依赖项）所设置的 INCLUDE\_DIRS。
- 递归列出所有组件 REQUIRES 列表中 INCLUDE\_DIRS 目录（如递归展开这个组件的所有公共依赖项）。

## 主要组件依赖项

main 组件比较特别，因为它在构建过程中自动依赖所有其他组件。所以不需要向这个组件传递 REQUIRES 或 PRIV\_REQUIRES。有关不再使用 main 组件时需要更改哪些内容，请参考[重命名 main 组件](#)。

## 通用组件依赖项

为避免重复性工作，各组件都用自动依赖一些“通用”IDF 组件，即使它们没有被明确提及。这些组件的头文件会一直包含在构建系统中。

通用组件包括：cxx、newlib、freertos、esp\_hw\_support、heap、log、soc、hal、esp\_rom、esp\_common、esp\_system。

## 在构建中导入组件

- 默认情况下，每个组件都会包含在构建系统中。
- 如果将 COMPONENTS 变量设置为项目直接使用的最小组件列表，那么构建系统会扩展到包含所有组件。完整的组件列表为：
  - COMPONENTS 中明确提及的组件。
  - 这些组件的依赖项（以及递归运算后的组件）。
  - 每个组件都依赖的通用组件。
- 将 COMPONENTS 设置为所需组件的最小列表，可以显著减少项目的构建时间。

## 循环依赖

一个项目中可能包含组件 A 和组件 B，而组件 A 依赖（REQUIRES 或 PRIV\_REQUIRES）组件 B，组件 B 又依赖组件 A。这就是所谓的依赖循环或循环依赖。

CMake 通常会在链接器命令行上重复两次组件库名称来自动处理循环依赖。然而这种方法并不总是有效，还是可能构建失败并出现关于“Undefined reference to ...”的链接器错误，这通常是由于引用了循环依赖中某一组件中定义的符号。如果存在较大的循环依赖关系，即 A->B->C->D->A，这种情况极有可能发生。

最好的解决办法是重构组件以消除循环依赖关系。在大多数情况下，没有循环依赖的软件架构具有模块化和分层清晰的特性，并且从长远来看更容易维护。然而，移除循环依赖关系并不容易做到。

要绕过由循环依赖引起的链接器错误，最简单的解决方法是增加其中一个组件库的 CMake LINK\_INTERFACE\_MULTIPLICITY 属性。这会让 CMake 在链接器命令行上对此库及其依赖项重复两次以上。

例如：

```
set_property(TARGET ${COMPONENT_LIB} APPEND PROPERTY LINK_INTERFACE_MULTIPLICITY 3)
```

- 这一行应该放在组件 CMakeLists.txt 文件 idf\_component\_register 之后。
- 可以的话，将此行放置在因依赖其他组件而造成循环依赖的组件中。实际上，该行可以放在循环内的任何一个组件中，但建议将其放置在拥有链接器错误提示信息中显示的源文件的组件中，或是放置在定义了链接器错误提示信息中所提到的符号的组件，先从这些组件开始是个不错的选择。
- 通常将值增加到 3（默认值是 2）就足够了，但如果不起作用，可以尝试逐步增加这个数字。
- 注意，增加这个选项会使链接器的命令行变长，链接阶段变慢。

**高级解决方法：未定义符号** 如果只有一两个符号导致循环依赖，而所有其他依赖都是线性的，那么有一种替代方法可以避免链接器错误：在链接时将“反向”依赖所需的特定符号指定为未定义符号。

例如，如果组件 A 依赖于组件 B，但组件 B 也需要引用组件 A 的 reverse\_ops（但不依赖组件 A 中的其他内容），那么你可以在组件 B 的 CMakeLists.txt 中添加如下一行，以在链接时避免这出现循环。

```
# 该符号是由“组件 A”在链接时提供
target_link_libraries(${COMPONENT_LIB} INTERFACE "-u reverse_ops")
```

- `-u` 参数意味着链接器将始终在链接中包含此符号，而不管依赖项顺序如何。
- 该行应该放在组件 `CMakeLists.txt` 文件中的 `idf_component_register` 之后。
- 如果“组件 B”不需要访问“组件 A”的任何头文件，只需链接几个符号，那么这一行可以用来代替 B 对 A 的任何“REQUIRES”。这样则进一步简化了构建系统中的组件结构。

请参考 [target\\_link\\_libraries](#) 文档以了解更多关于此 CMake 函数的信息。

### 构建系统中依赖处理的实现细节

- 在 CMake 配置进程的早期阶段会运行 `expand_requirements.cmake` 脚本。该脚本会对所有组件的 `CMakeLists.txt` 文件进行局部的运算，得到一张组件依赖关系图（此图可能会有闭环）。此图用于在构建目录中生成 `component_depends.cmake` 文件。
- CMake 主进程会导入该文件，并以此来确定要包含到构建系统中的组件列表（内部使用的 `BUILD_COMPONENTS` 变量）。`BUILD_COMPONENTS` 变量已排好序，依赖组件会排在前面。由于组件依赖关系图中可能存在闭环，因此不能保证每个组件都满足该排序规则。如果给定相同的组件集和依赖关系，那么最终的排序结果应该是确定的。
- CMake 会将 `BUILD_COMPONENTS` 的值以“Component names:”的形式打印出来。
- 然后执行构建系统中包含的每个组件的配置。
- 每个组件都被正常包含在构建系统中，然后再次执行 `CMakeLists.txt` 文件，将组件库加入构建系统。

**组件依赖顺序** `BUILD_COMPONENTS` 变量中组件的顺序决定了构建过程中的其它顺序，包括：

- 项目导入 `project_include.cmake` 文件的顺序。
- 生成用于编译（通过 `-I` 参数）的头文件路径列表的顺序。请注意，对于给定组件的源文件，仅需将该组件的依赖组件的头文件路径告知编译器。

**添加链接时依赖项** ESP-IDF 的 CMake 辅助函数 `idf_component_add_link_dependency` 可以在组件之间添加仅作用于链接时的依赖关系。绝大多数情况下，我们都建议你使用 `idf_component_register` 中的 `PRIV_REQUIRES` 功能来构建依赖关系。然而在某些情况下，还是有必要添加另一个组件对当前组件的链接时依赖，即反转 `PRIV_REQUIRES` 中的依赖关系（参考示例：[Overriding Default Chip Drivers](#)）。

要使另一个组件在链接时依赖于这个组件：

```
idf_component_add_link_dependency (FROM other_component)
```

请将上述行置于 `idf_component_register` 行之后。

也可以通过名称指定两个组件：

```
idf_component_add_link_dependency (FROM other_component TO that_component)
```

## 4.5.9 覆盖项目的部分设置

### `project_include.cmake`

如果组件的某些构建行为需要在组件 `CMakeLists` 文件之前被执行，你可以在组件目录下创建名为 `project_include.cmake` 的文件，`project.cmake` 在运行过程中会导入此 CMake 文件。

`project_include.cmake` 文件在 ESP-IDF 内部使用，以定义项目范围内的构建功能，比如 `esptool.py` 的命令行参数和 `bootloader` 这个特殊的应用程序。

与组件 `CMakeLists.txt` 文件有所不同，在导入 `project_include.cmake` 文件的时候，当前源文件目录（即 `CMAKE_CURRENT_SOURCE_DIR` 和工作目录）为项目目录。如果想获得当前组件的绝对路径，可以使用 `COMPONENT_PATH` 变量。

请注意，`project_include.cmake` 对于大多数常见的组件并不是必需的。例如给项目添加 `include` 搜索目录，给最终的链接步骤添加 `LDFLAGS` 选项等等都可以通过 `CMakeLists.txt` 文件来自定义。详细信息请参考[可选的项目变量](#)。

`project_include.cmake` 文件会按照 `BUILD_COMPONENTS` 变量中组件的顺序（由 CMake 记录）依次导入。即只有在当前组件所有依赖组件的 `project_include.cmake` 文件都被导入后，当前组件的 `project_include.cmake` 文件才会被导入，除非两个组件在同一个依赖闭环中。如果某个 `project_include.cmake` 文件依赖于另一组件设置的变量，则要特别注意上述情况。更多详情请参阅[构建系统中依赖处理的实现细节](#)。

在 `project_include.cmake` 文件中设置变量或目标时要格外小心，这些值被包含在项目的顶层 CMake 文件中，因此他们会影响或破坏所有组件的功能。

### KConfig.projbuild

与 `project_include.cmake` 类似，也可以为组件定义一个 KConfig 文件以实现全局的[组件配置](#)。如果要在 `menuconfig` 的顶层添加配置选项，而不是在“Component Configuration”子菜单中，则可以在 `CMakeLists.txt` 文件所在目录的 `KConfig.projbuild` 文件中定义这些选项。

在此文件中添加配置时要小心，因为这些配置会包含在整个项目配置中。在可能的情况下，请为[组件配置](#)创建 KConfig 文件。

### 通过封装对现有函数进行重新定义或扩展

链接器具有封装功能，可以重新定义或扩展现有 ESP-IDF 函数的行为。如需封装函数，你需要在项目的 `CMakeLists.txt` 文件中提供以下 CMake 声明：

```
target_link_libraries(${COMPONENT_LIB} INTERFACE "-Wl,--wrap=function_to_redefine")
```

其中，`function_to_redefine` 为需要被重新定义或扩展的函数名称。启用此选项后，链接器将把二进制库中所有对 `function_to_redefine` 函数的调用改为对 `__wrap_function_to_redefine` 函数的调用。因此，你必须在应用程序中定义这一符号。

链接器会提供一个名为 `__real_function_to_redefine` 的新符号，指向将被重新定义的函数的原有实现。由此，可以从新的实现中调用该函数，从而对原有实现进行扩展。

请参考 [build\\_system/wrappers](#) 示例，了解其详细原理。更多细节请参阅 [examples/build\\_system/wrappers/README.md](#)。

### 覆盖默认引导加载程序

由于 ESP-IDF 中存在可选目录 `bootloader_components`，因此可以覆盖默认的 ESP-IDF 引导加载程序。覆盖前，应定义一个 `bootloader_components/main` 组件，使项目目录如下所示：

- **myProject/**
  - CMakeLists.txt
  - sdkconfig
  - **bootloader\_components/ - main/ - CMakeLists.txt**
    - \* Kconfig
    - \* my\_bootloader.c
  - **main/ - CMakeLists.txt**
    - \* app\_main.c
  - build/

此处的 `my_bootloader.c` 文件会成为新引导加载程序的源代码，这意味着它需要执行所有必要的操作来设置并从 flash 中加载 main 应用程序。

还可以根据特定的条件来替换引导加载程序，例如替换指定目标芯片的引导加载程序。这可以通过 `BOOTLOADER_IGNORE_EXTRA_COMPONENT` CMake 变量实现，该列表会让 ESP-IDF 引导加载项目忽略 `bootloader_components` 中的指定组件，不对其进行编译。例如，如果希望使用 ESP32 目标芯片的默认引导加载程序，`myProject/CMakeLists.txt` 应如下所示：

```
include($ENV{IDF_PATH}/tools/cmake/project.cmake)

if(${IDF_TARGET} STREQUAL "esp32")
    set(BOOTLOADER_IGNORE_EXTRA_COMPONENT "main")
endif()

project(main)
```

值得注意的是，这还可以用于除 main 之外的其他引导加载程序组件。在任何情况下，都不能指定前缀 `bootloader_component`。

请参考 [custom\\_bootloader/bootloader\\_override](#) 查看覆盖默认引导加载程序的示例。

### 4.5.10 仅配置组件

仅配置组件是一类不包含源文件的特殊组件，仅包含 `Kconfig.projbuild`、`KConfig` 和 `CMakeLists.txt` 文件，该 `CMakeLists.txt` 文件仅有一行代码，调用了 `idf_component_register()` 函数。此函数会将组件导入到项目构建中，但不会构建任何库，也不会将头文件添加到任何 `include` 搜索路径中。

### 4.5.11 CMake 调试

请查看 [CMake v3.16 官方文档](#) 获取更多关于 `CMake` 和 `CMake` 命令的信息。

调试 ESP-IDF `CMake` 构建系统的一些技巧：

- `CMake` 运行时，会打印大量诊断信息，包括组件列表和组件路径。
- 运行 `cmake -DDEBUG=1`，IDF 构建系统会生成更详细的诊断输出。
- 运行 `cmake` 时指定 `--trace` 或 `--trace-expand` 选项会提供大量有关控制流信息。详情请参考 [CMake 命令行文档](#)。

当从项目 `CMakeLists` 文件导入时，`project.cmake` 文件会定义工具模块和全局变量，并在系统环境中没有设置 `IDF_PATH` 时设置 `IDF_PATH`。

同时还定义了一个自定义版本的内置 `CMake` `project` 函数，这个函数被覆盖，以添加所有 ESP-IDF 特定的项目功能。

### 警告未定义的变量

默认情况下，警告未定义的变量这一功能是关闭的。

可通过将 `--warn-uninitialized` 标志传递给 `CMake` 或通过向 `idf.py` 传递 `--cmake-warn-uninitialized` 来使能这一功能。这样，如果在构建的过程中引用了未定义的变量，`CMake` 会打印警告。这对查找有错误的 `CMake` 文件非常有用。

更多信息，请参考文件 `/tools/cmake/project.cmake` 以及 `/tools/cmake/` 中支持的函数。

### 4.5.12 组件 CMakeLists 示例

因为构建环境试图设置大多数情况都能工作的合理默认值，所以组件 `CMakeLists.txt` 文件可能非常小，甚至是空的，请参考 [最小组件 CMakeLists 文件](#)。但有些功能往往需要覆盖预设的组件变量才能实现。

以下是组件 `CMakeLists` 文件的更高级的示例。

## 添加条件配置

配置系统可用于根据项目配置中选择的选项有条件地编译某些文件。

Kconfig:

```
config FOO_ENABLE_BAR
    bool "Enable the BAR feature."
    help
        This enables the BAR feature of the FOO component.
```

CMakeLists.txt:

```
set(srcs "foo.c" "more_foo.c")

if(CONFIG_FOO_ENABLE_BAR)
    list(APPEND srcs "bar.c")
endif()

idf_component_register(SRCS "${srcs}"
    ...)
```

上述示例使用了 CMake 的 `if` 函数和 `list APPEND` 函数。

也可用于选择或删除某一实现，如下所示：

Kconfig:

```
config ENABLE_LCD_OUTPUT
    bool "Enable LCD output."
    help
        Select this if your board has a LCD.

config ENABLE_LCD_CONSOLE
    bool "Output console text to LCD"
    depends on ENABLE_LCD_OUTPUT
    help
        Select this to output debugging output to the lcd

config ENABLE_LCD_PLOT
    bool "Output temperature plots to LCD"
    depends on ENABLE_LCD_OUTPUT
    help
        Select this to output temperature plots
```

CMakeLists.txt:

```
if(CONFIG_ENABLE_LCD_OUTPUT)
    set(srcs lcd-real.c lcd-spi.c)
else()
    set(srcs lcd-dummy.c)
endif()

# 如果启用了控制台或绘图功能，则需要加入字体
if(CONFIG_ENABLE_LCD_CONSOLE OR CONFIG_ENABLE_LCD_PLOT)
    list(APPEND srcs "font.c")
endif()

idf_component_register(SRCS "${srcs}"
    ...)
```



## 硬件目标的条件判断

CMake 文件可以使用 `IDF_TARGET` 变量来获取当前的硬件目标。

此外，如果当前的硬件目标是 `xyz`（即 `IDF_TARGET=xyz`），那么 `Kconfig` 变量 `CONFIG_IDF_TARGET_XYZ` 同样也会被设置。

请注意，组件可以依赖 `IDF_TARGET` 变量，但不能依赖这个 `Kconfig` 变量。同样也不可在 CMake 文件的 `include` 语句中使用 `Kconfig` 变量，在这种上下文中可以使用 `IDF_TARGET`。

## 生成源代码

有些组件的源文件可能并不是由组件本身提供，而必须从另外的文件生成。假设组件需要一个头文件，该文件由 BMP 文件转换后（使用 `bmp2h` 工具）的二进制数据组成，然后将头文件包含在名为 `graphics_lib.c` 的文件中：

```
add_custom_command(OUTPUT logo.h
    COMMAND bmp2h -i ${COMPONENT_DIR}/logo.bmp -o log.h
    DEPENDS ${COMPONENT_DIR}/logo.bmp
    VERBATIM)

add_custom_target(logo DEPENDS logo.h)
add_dependencies(${COMPONENT_LIB} logo)

set_property(DIRECTORY "${COMPONENT_DIR}" APPEND PROPERTY
    ADDITIONAL_MAKE_CLEAN_FILES logo.h)
```

这个示例改编自 [CMake 的一则 FAQ](#)，其中还包含了一些同样适用于 ESP-IDF 构建系统的示例。

这个示例会在当前目录（构建目录）中生成 `logo.h` 文件，而 `logo.bmp` 会随组件一起提供在组件目录中。因为 `logo.h` 是一个新生成的文件，一旦项目需要清理，该文件也应该要被清除。因此，要将该文件添加到 `ADDITIONAL_MAKE_CLEAN_FILES` 属性中。

**备注：** 如果需要生成文件作为项目 `CMakeLists.txt` 的一部分，而不是作为组件 `CMakeLists.txt` 的一部分，此时需要使用 `${PROJECT_PATH}` 替代 `${COMPONENT_DIR}`，使用 `${PROJECT_NAME}.elf` 替代 `${COMPONENT_LIB}`。

如果某个源文件是从其他组件中生成，且包含 `logo.h` 文件，则需要调用 `add_dependencies`，在这两个组件之间添加一个依赖项，以确保组件源文件按照正确顺序进行编译。

## 嵌入二进制数据

有时你的组件希望使用一个二进制文件或者文本文件，但是你不希望将它们重新格式化为 C 源文件。

这时，你可以在组件注册中指定 `EMBED_FILES` 参数，用空格分隔要嵌入的文件名称：

```
idf_component_register(...
    EMBED_FILES server_root_cert.der)
```

或者，如果文件是字符串，则可以使用 `EMBED_TXTFILES` 变量，把文件的内容转成以 `null` 结尾的字符串嵌入：

```
idf_component_register(...
    EMBED_TXTFILES server_root_cert.pem)
```

文件的内容会被添加到 `flash` 的 `.rodata` 段，用户可以通过符号名来访问，如下所示：

```
extern const uint8_t server_root_cert_pem_start[] asm("_binary_server_root_cert_
↪pem_start");
extern const uint8_t server_root_cert_pem_end[]   asm("_binary_server_root_cert_
↪pem_end");
```

符号名会根据文件全名生成，如 `EMBED_FILES` 中所示，字符 `/`、`.` 等都会被下划线替代。符号名称中的 `_binary` 前缀由 `objcopy` 命令添加，对文本文件和二进制文件都是如此。

如果要将文件嵌入到项目中，而非组件中，可以调用 `target_add_binary_data` 函数：

```
target_add_binary_data(myproject.elf "main/data.bin" TEXT)
```

并将这行代码放在项目 `CMakeLists.txt` 的 `project()` 命令之后，修改 `myproject.elf` 为你自己的项目名。如果最后一个参数是 `TEXT`，那么构建系统会嵌入以 `null` 结尾的字符串，如果最后一个参数被设置为 `BINARY`，则将文件内容按照原样嵌入。

有关使用此技术的示例，请查看 `file_serving` 示例 `protocols/http_server/file_serving/main/CMakeLists.txt` 中的 `main` 组件，两个文件会在编译时加载并链接到固件中。

也可以嵌入生成的文件：

```
add_custom_command(OUTPUT my_processed_file.bin
                    COMMAND my_process_file_cmd my_unprocessed_file.bin)
target_add_binary_data(my_target "my_processed_file.bin" BINARY)
```

上述示例中，`my_processed_file.bin` 是通过命令 `my_process_file_cmd` 从文件 `my_unprocessed_file.bin` 中生成，然后嵌入到目标中。

使用 `DEPENDS` 参数来指明对目标的依赖性：

```
add_custom_target(my_process COMMAND ...)
target_add_binary_data(my_target "my_embed_file.bin" BINARY DEPENDS my_process)
```

`target_add_binary_data` 的 `DEPENDS` 参数确保目标首先执行。

## 代码和数据的存放

ESP-IDF 还支持自动生成链接脚本，它允许组件通过链接片段文件定义其代码和数据在内存中的存放位置。构建系统会处理这些链接片段文件，并将处理后的结果扩充进链接脚本，从而指导应用程序二进制文件的链接过程。更多详细信息与快速上手指南，请参阅[链接脚本生成机制](#)。

## 完全覆盖组件的构建过程

当然，在有些情况下，上面提到的方法不一定够用。如果组件封装了另一个第三方组件，而这个第三方组件并不能直接在 ESP-IDF 的构建系统中工作，在这种情况下，就需要放弃 ESP-IDF 的构建系统，改为使用 CMake 的 `ExternalProject` 功能。组件 CMakeLists 示例如下：

```
# 用于 quirc 的外部构建过程，在源目录中运行
# 并生成 libquirc.a
externalproject_add(quirc_build
    PREFIX ${COMPONENT_DIR}
    SOURCE_DIR ${COMPONENT_DIR}/quirc
    CONFIGURE_COMMAND ""
    BUILD_IN_SOURCE 1
    BUILD_COMMAND make CC=${CMAKE_C_COMPILER} libquirc.a
    INSTALL_COMMAND ""
)

# 将 libquirc.a 添加到构建系统中
add_library(quirc STATIC IMPORTED GLOBAL)
```

(下页继续)



```

add_dependencies(quirc quirc_build)

set_target_properties(quirc PROPERTIES IMPORTED_LOCATION
    ${COMPONENT_DIR}/quirc/libquirc.a)
set_target_properties(quirc PROPERTIES INTERFACE_INCLUDE_DIRECTORIES
    ${COMPONENT_DIR}/quirc/lib)

set_directory_properties( PROPERTIES ADDITIONAL_MAKE_CLEAN_FILES
    "${COMPONENT_DIR}/quirc/libquirc.a")

```

(上述 CMakeLists.txt 可用于创建名为 quirc 的组件，该组件使用自己的 Makefile 构建 quirc 项目。)

- `externalproject_add` 定义了一个外部构建系统。
  - 设置 `SOURCE_DIR`、`CONFIGURE_COMMAND`、`BUILD_COMMAND` 和 `INSTALL_COMMAND`。如果外部构建系统没有配置这一步骤，可以将 `CONFIGURE_COMMAND` 设置为空字符串。在 ESP-IDF 的构建系统中，一般会将 `INSTALL_COMMAND` 变量设置为空。
  - 设置 `BUILD_IN_SOURCE`，即构建目录与源目录相同。否则，你也可以设置 `BUILD_DIR` 变量。
  - 有关 `externalproject_add()` 命令的详细信息，请参阅 [ExternalProject](#)。
- 第二组命令添加了一个目标库，指向外部构建系统生成的库文件。为了添加 `include` 目录，并告知 CMake 该文件的位置，需要再设置一些属性。
- 最后，生成的库被添加到 `ADDITIONAL_MAKE_CLEAN_FILES` 中。即执行 `make clean` 后会删除该库。请注意，构建系统中的其他目标文件不会被删除。

**ExternalProject 的依赖与构建清理** 对于外部项目的构建，CMake 会有一些不同寻常的行为：

- `ADDITIONAL_MAKE_CLEAN_FILES` 仅在使用 `Make` 或 `Ninja` 构建系统时有效。如果使用 IDE 自带的构建系统，执行项目清理时，这些文件不会被删除。
- `ExternalProject` 会在 `clean` 运行后自动重新运行配置和构建命令。
- 可以采用以下两种方法来配置外部构建命令：
  1. 将外部 `BUILD_COMMAND` 命令设置为对所有源代码完整的重新编译。如果传递给 `externalproject_add` 命令的 `DEPENDS` 的依赖项发生了改变，或者当前执行的是项目清理操作（即运行了 `idf.py clean`、`ninja clean` 或者 `make clean`），那么就会执行该命令。
  2. 将外部 `BUILD_COMMAND` 命令设置为增量式构建命令，并给 `externalproject_add` 传递 `BUILD_ALWAYS 1` 参数。即不管实际的依赖情况，每次构建时，都会构建外部项目。这种方式仅当外部构建系统具备增量式构建的能力，且运行时间不会很长时才推荐。

构建外部项目的最佳方法取决于项目本身、其构建系统，以及是否需要频繁重新编译项目。

### 4.5.13 自定义 sdkconfig 的默认值

对于示例工程或者其他你不想指定完整 `sdkconfig` 配置的项目，但是你确实希望覆盖 ESP-IDF 默认值中的某些键值，则可以在项目中创建 `sdkconfig.defaults` 文件。重新创建新配置时将会用到此文件，另外在 `sdkconfig` 没有设置新配置值时，上述文件也会被用到。

如若需要覆盖此文件的名称或指定多个文件，请设置 `SDKCONFIG_DEFAULTS` 环境变量或在顶层 `CMakeLists.txt` 文件中设置 `SDKCONFIG_DEFAULTS`。非绝对路径的文件名将以当前项目的相对路径来解析。

在指定多个文件时，使用分号作为分隔符。先列出的文件将会先应用。如果某个键值在多个文件里定义，后面文件的定义会覆盖前面文件的定义。

一些 IDF 示例中包含了 `sdkconfig.ci` 文件。该文件是 CI（持续集成）测试框架的一部分，在正常构建过程中会被忽略。

### 依赖于硬件目标的 sdkconfig 默认值

当且仅当 `sdkconfig.defaults` 文件存在时，构建系统还将尝试从 `sdkconfig.defaults.TARGET_NAME` 文件中加载默认值，其中 `IDF_TARGET` 的值为 `TARGET_NAME`。例如，对于 `esp32` 这个目标芯片，`sdkconfig` 的默认值会首先从 `sdkconfig.defaults` 获取，然后再从 `sdkconfig.defaults.esp32` 获取。当没有通用的默认设置时，仍需创建一个空的 `sdkconfig.defaults` 文件，以便构建系统可以识别任何其他与目标芯片相关的 `sdkconfig.defaults.TARGET_NAME` 文件。

如果使用 `SDKCONFIG_DEFAULTS` 覆盖默认文件的名称，则硬件目标的默认文件名也会从 `SDKCONFIG_DEFAULTS` 值中派生。如果 `SDKCONFIG_DEFAULTS` 中有多个文件，硬件目标文件会在引入该硬件目标文件的文件之后应用，而 `SDKCONFIG_DEFAULTS` 中所有其它后续文件则会在硬件目标文件之后应用。

例如，如果 `SDKCONFIG_DEFAULTS="sdkconfig.defaults;sdkconfig_devkit1"`，并且在同一文件夹中有一个 `sdkconfig.defaults.esp32` 文件，那么这些文件将按以下顺序应用：(1) `sdkconfig.defaults` (2) `sdkconfig.defaults.esp32` (3) `sdkconfig_devkit1`。

### 4.5.14 flash 参数

有些情况下，我们希望在没有 IDF 时也能烧写目标板，为此，我们希望可以保存已构建的二进制文件、`esptool.py` 和 `esptool write_flash` 命令的参数。可以通过编写一段简单的脚本来保存二进制文件和 `esptool.py`。

运行项目构建之后，构建目录将包含项目二进制输出文件（.bin 文件），同时也包含以下烧录数据文件：

- `flash_project_args` 包含烧录整个项目的参数，包括应用程序 (app)、引导程序 (bootloader)、分区表，如果设置了 PHY 数据，也会包含此数据。
- `flash_app_args` 只包含烧录应用程序的参数。
- `flash_bootloader_args` 只包含烧录引导程序的参数。

你可以参照如下命令将任意烧录参数文件传递给 `esptool.py`：

```
python esptool.py --chip esp32h2 write_flash @build/flash_project_args
```

也可以手动复制参数文件中的数据到命令行中执行。

构建目录中还包含生成的 `flasher_args.json` 文件，此文件包含 JSON 格式的项目烧录信息，可用于 `idf.py` 和其它需要项目构建信息的工具。

### 4.5.15 构建 Bootloader

引导程序是 `/components/bootloader/subproject` 内部独特的“子项目”，它有自己的项目 `CMakeLists.txt` 文件，能够构建独立于主项目的 .ELF 和 .BIN 文件，同时它又与主项目共享配置和构建目录。

子项目通过 `/components/bootloader/project_include.cmake` 文件作为外部项目插入到项目的顶层，主构建进程会运行子项目的 CMake，包括查找组件（主项目使用的组件的子集），生成引导程序专用的配置文件（从主 `sdkconfig` 文件中派生）。

### 4.5.16 编写纯 CMake 组件

ESP-IDF 构建系统用“组件”的概念“封装”了 CMake，并提供了很多帮助函数来自动将这些组件集成到项目构建当中。

然而，“组件”概念的背后是一个完整的 CMake 构建系统，因此可以制作纯 CMake 组件。

下面是使用纯 CMake 语法为 json 组件编写的最小 `CMakeLists` 文件的示例：

```
add_library(json STATIC
cJSON/cJSON.c
cJSON/cJSON_Utils.c)
```

(下页继续)

```
target_include_directories(json PUBLIC cJSON)
```

- 这实际上与 IDF 中的 `json` 组件是等效的。
- 因为组件中的源文件不多，所以这个 `CMakeLists` 文件非常简单。对于具有大量源文件的组件而言，ESP-IDF 支持的组件通配符，可以简化组件 `CMakeLists` 的样式。
- 每当组件中新增一个与组件同名的库目标时，ESP-IDF 构建系统会自动将其添加到构建中，并公开公共的 `include` 目录。如果组件想要添加一个与组件不同名的库目标，就需要使用 `CMake` 命令手动添加依赖关系。

#### 4.5.17 组件中使用第三方 CMake 项目

`CMake` 在许多开源的 C/C++ 项目中广泛使用，用户可以在自己的应用程序中使用开源代码。`CMake` 构建系统的一大好处就是可以导入这些第三方的项目，有时候甚至不用做任何改动。这就允许用户使用当前 ESP-IDF 组件尚未提供的功能，或者使用其它库来实现相同的功能。

假设 `main` 组件需要导入一个假想库 `foo`，相应的组件 `CMakeLists` 文件如下所示：

```
# 注册组件
idf_component_register(...)

# 设置 `foo` 项目中的一些 CMake 变量，以控制 `foo` 的构建过程
set(FOO_BUILD_STATIC OFF)
set(FOO_BUILD_TESTS OFF)

# 创建并导入第三方库目标
add_subdirectory(foo)

# 将 `foo` 目标公开链接至 `main` 组件
target_link_libraries(main PUBLIC foo)
```

实际的案例请参考 [build\\_system/cmake/import\\_lib](#)。请注意，导入第三方库所需要做的工作可能会因库的不同而有所差异。建议仔细阅读第三方库的文档，了解如何将其导入到其它项目中。阅读第三方库的 `CMakeLists.txt` 文件以及构建结构也会有所帮助。

用这种方式还可以将第三方库封装成 ESP-IDF 的组件。例如 `mbdts` 组件就是封装了 `mbdts` 项目得到的。详情请参考 [mbdts 组件的 CMakeLists.txt 文件](#)。

每当使用 ESP-IDF 构建系统时，`CMake` 变量 `ESP_PLATFORM` 都会被设置为 1。如果要在通用的 `CMake` 代码加入 IDF 特定的代码时，可以采用 `if (ESP_PLATFORM)` 的形式加以分隔。

#### 外部库中使用 ESP-IDF 组件

上述示例中假设的是外部库 `foo`（或 `import_lib` 示例中的 `tinyclib` 库）除了常见的 API 如 `libc`、`libstdc++` 等外不需要使用其它 ESP-IDF API。如果外部库需要使用其它 ESP-IDF 组件提供的 API，则需要在外部 `CMakeLists.txt` 文件中通过添加对库目标 `idf::<componentname>` 的依赖关系。

例如，在 `foo/CMakeLists.txt` 文件：

```
add_library(foo bar.c fizz.cpp buzz.cpp)

if(ESP_PLATFORM)
  # 在 ESP-IDF 中，bar.c 需要包含 spi_flash 组件中的 esp_flash.h
  target_link_libraries(foo PRIVATE idf::spi_flash)
endif()
```

### 4.5.18 组件中使用预建库

还有一种情况是你有一个由其它构建过程生成预建静态库（.a 文件）。

ESP-IDF 构建系统为用户提供了一个实用函数 `add_prebuilt_library`，能够轻松导入并使用预建库：

```
add_prebuilt_library(target_name lib_path [REQUIRES req1 req2 ...] [PRIV_REQUIRES_
→req1 req2 ...])
```

其中：

- `target_name`- 用于引用导入库的名称，如链接到其它目标时
- `lib_path`- 预建库的路径，可以是绝对路径或是相对于组件目录的相对路径

可选参数 `REQUIRES` 和 `PRIV_REQUIRES` 指定对其它组件的依赖性。这些参数与 `idf_component_register` 的参数的意义相同。

注意预建库的编译目标需与目前的项目相同。预建库的相关参数也要匹配。如果不特别注意，这两个因素可能会导致应用程序中出现 `bug`。

请查看示例 `build_system/cmake/import_prebuilt`。

### 4.5.19 在自定义 CMake 项目中使用 ESP-IDF

ESP-IDF 提供了一个模板 CMake 项目，可以基于此轻松创建应用程序。然而在有些情况下，用户可能已有一个现成的 CMake 项目，或者想自己创建一个 CMake 项目，此时就希望将 IDF 中的组件以库的形式链接到用户目标（库/可执行文件）。

可以通过 `tools/cmake/idf.cmake` 提供的 *build system APIs* 实现该目标。例如：

```
cmake_minimum_required(VERSION 3.16)
project(my_custom_app C)

# 导入提供 ESP-IDF CMake 构建系统 API 的 CMake 文件
include(${ENV{IDF_PATH}}/tools/cmake/idf.cmake)

# 在构建中导入 ESP-IDF 组件，可以视作等同 add_subdirectory()
# 但为 ESP-IDF 构建增加额外的构建过程
# 具体构建过程
idf_build_process(esp32)

# 创建项目可执行文件
# 使用其别名 idf::newlib 将其链接到 newlib 组件
add_executable(${CMAKE_PROJECT_NAME}.elf main.c)
target_link_libraries(${CMAKE_PROJECT_NAME}.elf idf::newlib)

# 让构建系统知道项目到可执行文件是什么，从而添加更多的目标以及依赖关系等
idf_build_executable(${CMAKE_PROJECT_NAME}.elf)
```

`build_system/cmake/idf_as_lib` 中的示例演示了如何在自定义的 CMake 项目创建一个类似于 `Hello World` 的应用程序。

### 4.5.20 ESP-IDF CMake 构建系统 API

#### ESP-IDF 构建命令

```
idf_build_get_property(var property [GENERATOR_EXPRESSION])
```

检索一个构建属性 *property*，并将其存储在当前作用域可访问的 `var` 中。特定 `GENERATOR_EXPRESSION` 将检索该属性的生成器表达式字符串（不是实际值），它可与支持生成器表达式的 CMake 命令一起使用。

```
idf_build_set_property(property val [APPEND])
```

设置构建属性 *property* 的值为 *val*。特定 *APPEND* 将把指定的值附加到属性当前值之后。如果该属性之前不存在或当前为空，则指定的值将变为第一个元素/成员。

```
idf_build_component(component_dir)
```

向构建系统提交一个包含组件的 *component\_dir* 目录。相对路径会被转换为相对于当前目录的绝对路径。所有对该命令的调用必须在 `idf_build_process` 之前执行。

该命令并不保证组件在构建过程中会被处理（参见 *idf\_build\_process* 中 *COMPONENTS* 参数说明）

```
idf_build_process(target
    [PROJECT_DIR project_dir]
    [PROJECT_VER project_ver]
    [PROJECT_NAME project_name]
    [SDKCONFIG sdkconfig]
    [SDKCONFIG_DEFAULTS sdkconfig_defaults]
    [BUILD_DIR build_dir]
    [COMPONENTS component1 component2 ...])
```

为导入 ESP-IDF 组件执行大量的幕后工作，包括组件配置、库创建、依赖性扩展和解析。在这些功能中，对于用户最重要的可能是通过调用每个组件的 `idf_component_register` 来创建库。该命令为每个组件创建库，这些库可以使用别名来访问，其形式为 `idf::component_name`。这些别名可以用来将组件链接到用户自己的目标、库或可执行文件上。

该调用要求用 *target* 参数指定目标芯片。调用的可选参数包括：

- **PROJECT\_DIR** - 项目目录，默认为 `CMAKE_SOURCE_DIR`。
- **PROJECT\_NAME** - 项目名称，默认为 `CMAKE_PROJECT_NAME`。
- **PROJECT\_VER** - 项目的版本/版本号，默认为“1”。
- **SDKCONFIG** - 生成的 `sdkconfig` 文件的输出路径，根据是否设置 `PROJECT_DIR`，默认为 `PROJECT_DIR/sdkconfig` 或 `CMAKE_SOURCE_DIR/sdkconfig`。
- **SDKCONFIG\_DEFAULTS** - 包含默认配置的文件列表（列表中必须包含完整的路径），默认为空；对于列表中的每个值 *filename*，如果存在的话，也会加载文件 *filename.target* 中的配置。对于列表中的 *filename* 的每一个值，也会加载文件 *filename.target*（如果存在的话）中的配置。
- **BUILD\_DIR** - 用于放置 ESP-IDF 构建相关工具的目录，如生成的二进制文件、文本文件、组件；默认为 `CMAKE_BINARY_DIR`。
- **COMPONENTS** - 从构建系统已知的组件中选择要处理的组件（通过 `idf_build_component` 添加）。这个参数用于精简构建过程。如果在依赖链中需要其它组件，则会自动添加，即自动添加这个列表中组件的公共和私有依赖项，进而添加这些依赖项的公共和私有依赖，以此类推。如果不指定，则会处理构建系统已知的所有组件。

```
idf_build_executable(executable)
```

指定 ESP-IDF 构建的可执行文件 *executable*。这将添加额外的目标，如与 `flash` 相关的依赖关系，生成额外的二进制文件等。应在 `idf_build_process` 之后调用。

```
idf_build_get_config(var config [GENERATOR_EXPRESSION])
```

获取指定配置的值。就像构建属性一样，特定 *GENERATOR\_EXPRESSION* 将检索该配置的生成器表达式字符串，而不是实际值，即可以与支持生成器表达式的 CMake 命令一起使用。然而，实际的配置值只有在调用 `idf_build_process` 后才能知道。

### ESP-IDF 构建属性

可以通过使用构建命令 `idf_build_get_property` 来获取构建属性的值。例如，以下命令可以获取构建过程中使用的 Python 解释器的相关信息。



```
idf_build_get_property(python PYTHON)
message(STATUS "The Python interpreter is: ${python}")
```

- **BUILD\_DIR** - 构建目录; 由 `idf_build_process` 的 **BUILD\_DIR** 参数设置。
- **BUILD\_COMPONENTS** - 包含在构建中的组件列表; 由 `idf_build_process` 设置。
- **BUILD\_COMPONENT\_ALIASES** - 包含在构建中的组件的库别名列表; 由 `idf_build_process` 设置。
- **C\_COMPILE\_OPTIONS** - 适用于所有组件的 C 源代码文件的编译选项。
- **COMPILE\_OPTIONS** - 适用于所有组件的源文件 (无论是 C 还是 C++) 的编译选项。
- **COMPILE\_DEFINITIONS** - 适用于所有组件源文件的编译定义。
- **CXX\_COMPILE\_OPTIONS** - 适用于所有组件的 C++ 源文件的编译选项。
- **EXECUTABLE** - 项目可执行文件; 通过调用 `idf_build_executable` 设置。
- **DEPENDENCIES\_LOCK** - 组件管理器使用的依赖关系锁定文件的路径。默认值为项目路径下的 `dependencies.lock`。
- **EXECUTABLE\_NAME** - 不含扩展名的项目可执行文件的名称; 通过调用 `idf_build_executable` 设置。
- **EXECUTABLE\_DIR** - 输出的可执行文件的路径
- **IDF\_COMPONENT\_MANAGER** - 默认启用组件管理器, 但如果设置这个属性为 0, 则会被 **IDF\_COMPONENT\_MANAGER** 环境变量禁用。
- **IDF\_PATH** - ESP-IDF 路径; 由 **IDF\_PATH** 环境变量设置, 或者从 `idf.cmake` 的位置推断。
- **IDF\_TARGET** - 构建的目标芯片; 由 `idf_build_process` 的目标参数设置。
- **IDF\_VER** - ESP-IDF 版本; 由版本文件或 **IDF\_PATH** 仓库的 Git 版本设置。
- **INCLUDE\_DIRECTORIES** - 包含所有组件源文件的目录。
- **KCONFIGS** - 构建过程中组件里的 **Kconfig** 文件的列表; 由 `idf_build_process` 设置。
- **KCONFIG\_PROJBUILDS** - 构建过程中组件中的 **Kconfig.projbuild** 文件的列表; 由 `idf_build_process` 设置。
- **PROJECT\_NAME** - 项目名称; 由 `idf_build_process` 的 **PROJECT\_NAME** 参数设置。
- **PROJECT\_DIR** - 项目的目录; 由 `idf_build_process` 的 **PROJECT\_DIR** 参数设置。
- **PROJECT\_VER** - 项目的版本; 由 `idf_build_process` 的 **PROJECT\_VER** 参数设置。
- **PYTHON** - 用于构建的 Python 解释器; 如果有则从 **PYTHON** 环境变量中设置, 如果没有, 则使用 "python"。
- **SDKCONFIG** - 输出的配置文件的完整路径; 由 `idf_build_process` **SDKCONFIG** 参数设置。
- **SDKCONFIG\_DEFAULTS** - 包含默认配置的文件列表; 由 `idf_build_process` **SDKCONFIG\_DEFAULTS** 参数设置。
- **SDKCONFIG\_HEADER** - 包含组件配置的 C/C++ 头文件的完整路径; 由 `idf_build_process` 设置。
- **SDKCONFIG\_CMAKE** - 包含组件配置的 CMake 文件的完整路径; 由 `idf_build_process` 设置。
- **SDKCONFIG\_JSON** - 包含组件配置的 JSON 文件的完整路径; 由 `idf_build_process` 设置。
- **SDKCONFIG\_JSON\_MENUS** - 包含配置菜单的 JSON 文件的完整路径; 由 `idf_build_process` 设置。

### ESP-IDF 组件命令

```
idf_component_get_property(var component property [GENERATOR_EXPRESSION])
```

检索一个指定的 *component* 的 **组件属性** *property*, 并将其存储在当前作用域可访问的 *var* 中。指定 **GENERATOR\_EXPRESSION** 将检索该属性的生成器表达式字符串 (不是实际值), 它可以在支持生成器表达式的 CMake 命令中使用。

```
idf_component_set_property(component property val [APPEND])
```

设置指定的 *component* 的 **组件属性**, *property* 的值为 *val*。特定 **APPEND** 将把指定的值追加到属性的当前值后。如果该属性之前不存在或当前为空, 指定的值将成为第一个元素/成员。

```
idf_component_register([[SRCS src1 src2 ...] | [[SRC_DIRS dir1 dir2 ...] [EXCLUDE_
↪SRCS src1 src2 ...]]
                        [INCLUDE_DIRS dir1 dir2 ...]]
```

(下页继续)

```
[PRIV_INCLUDE_DIRS dir1 dir2 ...]
[REQUIRES component1 component2 ...]
[PRIV_REQUIRES component1 component2 ...]
[LDFRAGMENTS ldfragment1 ldfragment2 ...]
[REQUIRED_IDF_TARGETS target1 target2 ...]
[EMBED_FILES file1 file2 ...]
[EMBED_TXTFILES file1 file2 ...]
[KCONFIG kconfig]
[KCONFIG_PROJBUILD kconfig_projbuild]
[WHOLE_ARCHIVE])
```

将一个组件注册到构建系统中。就像 `project()` CMake 命令一样，该命令应该直接从组件的 `CMakeLists.txt` 中调用（而不是通过函数或宏），且建议在其他命令之前调用该命令。下面是一些关于在 `idf_component_register` 之前不能调用哪些命令的指南：

- 在 CMake 脚本模式下无效的命令。
- 在 `project_include.cmake` 中定义的自定义命令。
- 除了 `idf_build_get_property` 之外，构建系统的 API 命令；但要考虑该属性是否有被设置。

对变量进行设置和操作的命令，一般可在 `idf_component_register` 之前调用。

`idf_component_register` 的参数包括：

- `SRCS` - 组件的源文件，用于为组件创建静态库；如果没有指定，组件将被视为仅配置组件，从而创建接口库。
- `SRC_DIRS`、`EXCLUDE_SRCS` - 用于通过指定目录来 `glob` 源文件 (.c、.cpp、.S)，而不是通过 `SRCS` 手动指定源文件。请注意，这受 *CMake* 中通配符的限制。在 `EXCLUDE_SRCS` 中指定的源文件会从被 `glob` 的文件中移除。
- `INCLUDE_DIRS` - 相对于组件目录的路径，该路径将被添加到需要当前组件的所有其他组件的 `include` 搜索路径中。
- `PRIV_INCLUDE_DIRS` - 必须是相对于组件目录的目录路径，它仅被添加到这个组件源文件的 `include` 搜索路径中。
- `REQUIRES` - 组件的公共组件依赖项。
- `PRIV_REQUIRES` - 组件的私有组件依赖项；在仅用于配置的组件上会被忽略。
- `LDFRAGMENTS` - 组件链接器片段文件。
- `REQUIRED_IDF_TARGETS` - 指定该组件唯一支持的目标。
- `KCONFIG` - 覆盖默认的 `Kconfig` 文件。
- `KCONFIG_PROJBUILD` - 覆盖默认的 `Kconfig.projbuild` 文件。
- `WHOLE_ARCHIVE` - 如果指定了此参数，链接时会在组件库的前后分别添加 `-Wl,--whole-archive` 和 `-Wl,--no-whole-archive`。这与设置 `WHOLE_ARCHIVE` 组件属性的效果一致。

以下内容用于将数据嵌入到组件中，并在确定组件是否仅用于配置时被视为源文件。这意味着，即使组件没有指定源文件，如果组件指定了以下其中之一，仍然会在内部为组件创建一个静态库。

- `EMBED_FILES` - 嵌入组件的二进制文件
- `EMBED_TXTFILES` - 嵌入组件的文本文件

### ESP-IDF 组件属性

组件的属性值可以通过使用构建命令 `idf_component_get_property` 来获取。例如，以下命令可以获取 `freertos` 组件的目录。

```
idf_component_get_property(dir freertos COMPONENT_DIR)
message(STATUS "The 'freertos' component directory is: ${dir}")
```

- `COMPONENT_ALIAS` - `COMPONENT_LIB` 的别名，用于将组件链接到外部目标；由 `idf_build_component` 设置，别名库本身由 `idf_component_register` 创建。
- `COMPONENT_DIR` - 组件目录；由 `idf_build_component` 设置。
- `COMPONENT_OVERRIDEN_DIR` - 如果这个组件覆盖了另一个组件，则包含原组件的目录。

- **COMPONENT\_LIB** - 所创建的组件静态/接口库的名称；由 `idf_build_component` 设置，库本身由 `idf_component_register` 创建。
- **COMPONENT\_NAME** - 组件的名称；由 `idf_build_component` 根据组件的目录名设置。
- **COMPONENT\_TYPE** - 组件的类型 (**LIBRARY** 或 **CONFIG\_ONLY**)。如果一个组件指定了源文件或嵌入了一个文件，那么它的类型就是 **LIBRARY**。
- **EMBED\_FILES** - 要嵌入组件的文件列表；由 `idf_component_register` **EMBED\_FILES** 参数设置。
- **EMBED\_TXTFILES** - 要嵌入组件的文本文件列表；由 `idf_component_register` **EMBED\_TXTFILES** 参数设置。
- **INCLUDE\_DIRS** - 组件 `include` 目录列表；由 `idf_component_register` **INCLUDE\_DIRS** 参数设置。
- **KCONFIG** - 组件 `Kconfig` 文件；由 `idf_build_component` 设置。
- **KCONFIG\_PROJBUILD** - 组件 `Kconfig.projbuild`；由 `idf_build_component` 设置。
- **LDFRAGMENTS** - 组件链接器片段文件列表；由 `idf_component_register` **LDFRAGMENTS** 参数设置。
- **MANAGED\_PRIV\_REQUIRES** - IDF 组件管理器从 `idf_component.yml` 清单文件中的依赖关系中添加的私有组件依赖关系列表。
- **MANAGED\_REQUIRES** - IDF 组件管理器从 `idf_component.yml` 清单文件的依赖关系中添加的公共组件依赖关系列表。
- **PRIV\_INCLUDE\_DIRS** - 组件私有 `include` 目录列表；在 **LIBRARY** 类型的组件 `idf_component_register` **PRIV\_INCLUDE\_DIRS** 参数中设置。
- **PRIV\_REQUIRES** - 私有组件依赖关系列表；根据 `idf_component_register` **PRIV\_REQUIRES** 参数的值以及 `idf_component.yml` 清单文件中的依赖关系设置。
- **REQUIRED\_IDF\_TARGETS** - 组件支持的目标列表；由 `idf_component_register` **REQUIRED\_IDF\_TARGETS** 参数设置。
- **REQUIRES** - 公共组件依赖关系列表；根据 `idf_component_register` **REQUIRES** 参数的值以及 `idf_component.yml` 清单文件中的依赖关系设置。
- **SRCES** - 组件源文件列表；由 `idf_component_register` 的 **SRCES** 或 **SRC\_DIRS/EXCLUDE\_SRCES** 参数设置。
- **WHOLE\_ARCHIVE** - 如果该属性被设置为 **TRUE** (或是其他 CMake 布尔“真”值: **1, ON, YES, Y** 等), 链接时会在组件库的前后分别添加 `-Wl, --whole-archive` 和 `-Wl, --no-whole-archive` 选项。这可以强制链接器将每个目标文件包含到可执行文件中, 即使该目标文件没有解析来自应用程序其余部分的任何引用。当组件中包含依赖链接时注册的插件或模块时, 通常会使用该方法。默认情况下, 此属性为 **FALSE**。可以从组件的 `CMakeLists.txt` 文件中将其设置为 **TRUE**。

### 4.5.21 文件通配 & 增量构建

在 ESP-IDF 组件中添加源文件的首选方法是在 `COMPONENT_SRCES` 中手动列出它们:

```
idf_component_register(SRCES library/a.c library/b.c platform/platform.c
    ...)
```

这是在 CMake 中手动列出源文件的 **最佳实践**。然而, 当有许多源文件都需要添加到构建中时, 这种方法就会很不方便。ESP-IDF 构建系统因此提供了另一种替代方法, 即使用 `SRC_DIRS` 来指定源文件:

```
idf_component_register(SRC_DIRS library platform
    ...)
```

后台会使用通配符在指定的目录中查找源文件。但是请注意, 在使用这种方法的时候, 如果组件中添加了一个新的源文件, CMake 并不知道重新运行配置, 最终该文件也没有被加入构建中。

如果是自己添加的源文件, 这种折衷还是可以接受的, 因为用户可以触发一次干净的构建, 或者运行 `idf.py reconfigure` 来手动重启 CMake。但是, 如果你需要与其他使用 Git 等版本控制工具的开发人员共享项目时, 问题就会变得更加困难, 因为开发人员有可能会拉取新的版本。

ESP-IDF 中的组件使用了第三方的 Git CMake 集成模块 (`/tools/cmake/third_party/GetGitRevisionDescription.cmake`), 任何时候源码仓库的提交记录发生了改变, 该模块就会自动重新运行 CMake。即只要拉取了新的 ESP-IDF 版本, CMake 就会重新运行。

对于不属于 ESP-IDF 的项目组件, 有以下几个选项供参考:



- 如果项目文件保存在 Git 中，ESP-IDF 会自动跟踪 Git 修订版本，并在它发生变化时重新运行 CMake。
- 如果一些组件保存在第三方 Git 仓库中（不在项目仓库或 ESP-IDF 仓库），则可以在组件 CMakeLists 文件中调用 `git_describe` 函数，以便在 Git 修订版本发生变化时自动重启 CMake。
- 如果没有使用 Git，请记住在源文件发生变化时手动运行 `idf.py reconfigure`。
- 使用 `idf_component_register` 的 `SRCs` 参数来列出项目组件中的所有源文件则可以完全避免这一问题。

具体选择哪一方式，就要取决于项目本身，以及项目用户。

## 4.5.22 构建系统的元数据

为了将 ESP-IDF 集成到 IDE 或者其它构建系统中，CMake 在构建的过程中会在 `build/` 目录下生成大量元数据文件。运行 `cmake` 或 `idf.py reconfigure`（或任何其它 `idf.py` 构建命令），可以重新生成这些元数据文件。

- `compile_commands.json` 是标准格式的 JSON 文件，它描述了在项目中参与编译的每个源文件。CMake 其中的一个功能就是生成此文件，许多 IDE 都知道如何解析此文件。
- `project_description.json` 包含有关 ESP-IDF 项目、已配置路径等的一些常规信息。
- `flasher_args.json` 包含 `esptool.py` 工具用于烧录项目二进制文件的参数，此外还有 `flash_*_args` 文件，可直接与 `esptool.py` 一起使用。更多详细信息请参阅 [flash 参数](#)。
- `CMakeCache.txt` 是 CMake 的缓存文件，包含 CMake 进程、工具链等其它信息。
- `config/sdkconfig.json` 包含 JSON 格式的项目配置结果。
- `config/kconfig_menus.json` 是在 `menuconfig` 中显示菜单的 JSON 格式版本，用于外部 IDE 的 UI。

## JSON 配置服务器

`kconfserver` 工具可以帮助 IDE 轻松地与配置系统的逻辑进行集成，它运行在后台，通过使用 `stdin` 和 `stdout` 读写 JSON 文件的方式与调用进程交互。

你可以通过 `idf.py confserver` 或 `ninja kconfserver` 从项目中运行 `kconfserver`，也可以使用不同的构建生成器来触发类似的目标。

有关 `kconfserver` 的更多信息，请参阅 [esp-idf-kconfig 文档](#)。

## 4.5.23 构建系统内部

### 构建脚本

ESP-IDF 构建系统的列表文件位于 `/tools/cmake` 中。实现构建系统核心功能的模块如下

- `build.cmake` - 构建相关命令，即构建初始化、检索/设置构建属性、构建处理。
- `component.cmake` - 组件相关的命令，如添加组件、检索/设置组件属性、注册组件。
- `kconfig.cmake` - 从 `Kconfig` 文件中生成配置文件（`sdkconfig`、`sdkconfig.h`、`sdkconfig.cmake` 等）。
- `ldgen.cmake` - 从链接器片段文件生成最终链接器脚本。
- `target.cmake` - 设置构建目标和工具链文件。
- `utilities.cmake` - 其它帮助命令。

除了这些文件，还有两个重要的 CMake 脚本在 `/tools/cmake` 中：

- `idf.cmake` - 设置构建参数并导入上面列出的核心模块。之所以包括在 CMake 项目中，是为了方便访问 ESP-IDF 构建系统功能。
- `project.cmake` - 导入 `idf.cmake`，并提供了一个自定义的 `project()` 命令，该命令负责处理建立可执行文件时所有的繁重工作。包含在标准 ESP-IDF 项目的顶层 `CMakeLists.txt` 中。

`/tools/cmake` 中的其它文件都是构建过程中的支持性文件或第三方脚本。

## 构建过程

本节介绍了标准的 ESP-IDF 应用构建过程。构建过程可以大致分为四个阶段：



图 3: ESP-IDF Build System Process

### 初始化

该阶段为构建设置必要的参数。

- 在将 `idf.cmake` 导入 `project.cmake` 后，将执行以下步骤：
  - 在环境变量中设置 `IDF_PATH` 或从顶层 `CMakeLists.txt` 中包含的 `project.cmake` 路径推断相对路径。
  - 将 `/tools/cmake` 添加到 `CMAKE_MODULE_PATH` 中，并导入核心模块和各种辅助/第三方脚本。
  - 设置构建工具/可执行文件，如默认的 Python 解释器。
  - 获取 ESP-IDF git 修订版，并存储为 `IDF_VER`。
  - 设置全局构建参数，即编译选项、编译定义、包括所有组件的 `include` 目录。
  - 将 `components` 中的组件添加到构建中。
- 自定义 `project()` 命令的初始部分执行以下步骤：
  - 在环境变量或 CMake 缓存中设置 `IDF_TARGET` 以及设置相应要使用的 `CMAKE_TOOLCHAIN_FILE`。
  - 添加 `EXTRA_COMPONENT_DIRS` 中的组件至构建中
  - 从 `COMPONENTS/` `EXCLUDE_COMPONENTS`、`SDKCONFIG`、`SDKCONFIG_DEFAULTS` 等变量中为调用命令 `idf_build_process()` 准备参数。

调用 `idf_build_process()` 命令标志着这个阶段的结束。

### 枚举

这个阶段会建立一个需要在构建过程中处理的组件列表，该阶段在 `idf_build_process()` 的前半部分进行。

- 检索每个组件的公共和私有依赖。创建一个子进程，以脚本模式执行每个组件的 `CMakeLists.txt`。`idf_component_register` `REQUIRES` 和 `PRIV_REQUIRES` 参数的值会返回给父进程。这就是所谓的早期扩展。在这一步中定义变量 `CMAKE_BUILD_EARLY_EXPANSION`。
- 根据公共和私有的依赖关系，递归地导入各个组件。

### 处理

该阶段处理构建中的组件，是 `idf_build_process()` 的后半部分。

- 从 `sdkconfig` 文件中加载项目配置，并生成 `sdkconfig.cmake` 和 `sdkconfig.h` 头文件。这两个文件分别定义了可以从构建脚本和 C/C++ 源文件/头文件中访问的配置变量/宏。
- 导入各组件的 `project_include.cmake`。
- 将每个组件添加为一个子目录，处理其 `CMakeLists.txt`。组件 `CMakeLists.txt` 调用注册命令 `idf_component_register` 添加源文件、导入目录、创建组件库、链接依赖关系等。

## 完成

该阶段是 `idf_build_process()` 剩余的步骤。

- 创建可执行文件并将其链接到组件库中。
- 生成 `project_description.json` 等项目元数据文件并且显示所建项目等相关信息。

请参考 </tools/cmake/project.cmake> 获取更多信息。

## 4.5.24 从 ESP-IDF GNU Make 构建系统迁移到 CMake 构建系统

ESP-IDF CMake 构建系统与旧版的 GNU Make 构建系统在某些方面非常相似，开发者都需要提供 `include` 目录、源文件等。然而，有一个语法上的区别，即对于 ESP-IDF CMake 构建系统，开发者需要将这些作为参数传递给注册命令 `idf_component_register`。

### 自动转换工具

在 ESP-IDF v4.x 版本中，`tools/cmake/convert_to_cmake.py` 提供了项目自动转换工具。由于该脚本依赖于 `make` 构建系统，所以 v5.0 版本中不包含该脚本。

### CMake 中不可用的功能

有些功能已从 CMake 构建系统中移除，或者已经发生很大改变。GNU Make 构建系统中的以下变量已从 CMake 构建系统中删除：

- `COMPONENT_BUILD_DIR`：由 `CMAKE_CURRENT_BINARY_DIR` 替代。
- `COMPONENT_LIBRARY`：默认为 `$(COMPONENT_NAME).a` 但是库名可以被组件覆盖。在 CMake 构建系统中，组件库名称不可再被组件覆盖。
- `CC`、`LD`、`AR`、`OBJCOPY`：`gcc xtensa` 交叉工具链中每个工具的完整路径。CMake 使用 `CMAKE_C_COMPILER`、`CMAKE_C_LINK_EXECUTABLE` 和 `CMAKE_OBJCOPY` 进行替代。完整列表请参阅 [CMake 语言变量](#)。
- `HOSTCC`、`HOSTLD`、`HOSTAR`：宿主机本地工具链中每个工具的全名。CMake 系统不再提供此变量，外部项目需要手动检测所需的宿主机工具链。
- `COMPONENT_ADD_LDFLAGS`：用于覆盖链接标志。CMake 中使用 `target_link_libraries` 命令替代。
- `COMPONENT_ADD_LINKER_DEPS`：链接过程依赖的文件列表。`target_link_libraries` 通常会推断这些依赖。对于链接脚本，可以使用自定义的 CMake 函数 `target_linker_scripts`。
- `COMPONENT_SUBMODULES`：不再使用。CMake 会自动枚举 ESP-IDF 仓库中所有的子模块。
- `COMPONENT_EXTRA_INCLUDES`：曾是 `COMPONENT_PRIV_INCLUDEDIRS` 变量的替代版本，仅支持绝对路径。CMake 系统中统一使用 `COMPONENT_PRIV_INCLUDEDIRS`（可以是相对路径，也可以是绝对路径）。
- `COMPONENT_OBJS`：以前，可以以目标文件列表的方式指定组件源，现在，可以通过 `COMPONENT_SRCS` 以源文件列表的形式指定组件源。
- `COMPONENT_OBJEXCLUDE`：已被 `COMPONENT_SRC_EXCLUDE` 替换。用于指定源文件（绝对路径或组件目录的相对路径）。
- `COMPONENT_EXTRA_CLEAN`：已被 `ADDITIONAL_MAKE_CLEAN_FILES` 属性取代，注意，[CMake 对此项功能有部分限制](#)。
- `COMPONENT_OWNBUILDTARGET` & `COMPONENT_OWNCLEANTARGET`：已被 CMake 外部项目 `<ExternalProject>` 替代，详细内容请参阅 [完全覆盖组件的构建过程](#)。
- `COMPONENT_CONFIG_ONLY`：已被 `register_config_only_component()` 函数替代，请参阅 [仅配置组件](#)。
- `CFLAGS`、`CPPFLAGS`、`CXXFLAGS`：已被相应的 CMake 命令替代，请参阅 [组件编译控制](#)。

### 无默认值的变量

以下变量不再具有默认值：

- 源目录 (Make 中的 COMPONENT\_SRCDIRS 变量, CMake 中 idf\_component\_register 的 SRC\_DIRS 参数)
- include 目录 (Make 中的 COMPONENT\_ADD\_INCLUDEDIRS 变量, CMake 中 idf\_component\_register 的 INCLUDE\_DIRS 参数)

### 不再需要的变量

在 CMake 构建系统中, 如果设置了 COMPONENT\_SRCS, 就不需要再设置 COMPONENT\_SRCDIRS。实际上, CMake 构建系统中如果设置了 COMPONENT\_SRCDIRS, 那么 COMPONENT\_SRCS 就会被忽略。

### 从 Make 中烧录

仍然可以使用 `make flash` 或者类似的目标来构建和烧录, 但是项目 `sdkconfig` 不能再用来指定串口和波特率。可以使用环境变量来覆盖串口和波特率的设置, 详情请参阅[使用 Ninja/Make 来烧录](#)。

## 4.6 RF 共存

### 4.6.1 概览

ESP 系列芯片最多支持三种射频收发模块: Bluetooth (BT 和 BLE), IEEE802.15.4 和 Wi-Fi, 而每款芯片只支持一路被多个射频收发模块共享的 RF, 不同模块无法同时使用 RF 收发数据, 因此采用时分复用的方法调节不同模块的数据包收发。

### 4.6.2 ESP32-H2 支持的共存场景

表 1: 表 3 Thread (IEEE802.15.4) 和 BLE 共存支持功能

		BLE			
		Scan	Advertising	Connecting	Connected
Thread	Scan	X	Y	Y	Y
	Connecting	X	Y	Y	Y
	Connected	X	Y	Y	Y
	Connected (high throughput)	X	C1	C1	C1

**备注:** Y: 支持且性能稳定。C1: 不能保证性能处于稳定状态。X: 不支持。S: 在 STA 模式下支持且性能稳定, 否则不支持。

### 4.6.3 共存机制与策略

#### 共存机制

基于优先级抢占的 RF 资源分配机制, 如下图所示, Bluetooth 模块和 Wi-Fi 模块向共存模块申请 RF 资源, 共存模块根据二者的优先级高低裁决 RF 归谁使用。



图 4: 共存机制

### 共存策略

**共存周期和时间片** 目前, 当 BLE 与 IEEE802.15.4 共存时, ESP 芯片使用的策略为 BLE 优先级始终优先于 IEEE802.15.4。

- 1) CONNECTED 状态: 共存周期以目标信标传输时间 (Target Beacon Transmission Time, TBTT) 点为起始点, 周期大于 100 ms。
- 2) SCAN 状态: Wi-Fi 时间片以及共存周期都比在 CONNECTED 状态下的长。为了确保蓝牙的性能, 蓝牙的时间片也会做相应的调整。
- 3) CONNECTING 状态: Wi-Fi 时间片比在 CONNECTED 状态下的长。为了确保蓝牙的性能, 蓝牙的时间片也会做相应的调整。

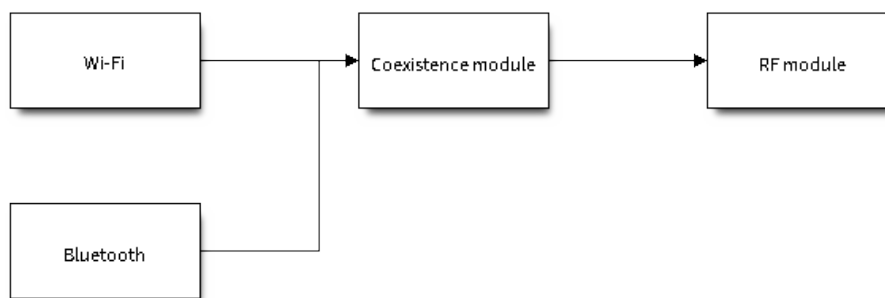
共存逻辑会根据当前 Wi-Fi 和 Bluetooth 的使用场景来选取不同的共存周期和共存时间片的划分策略。对应一个使用场景的共存策略, 我们称之为“共存模板”。比如, Wi-Fi CONNECTED 与 BLE CONNECTED 的场景, 就对应有一个共存模板。在这个共存模板中, 一个共存周期内 Wi-Fi 和 BLE 的时间片各占 50%, 时间分配如下图所示:



图 5: Wi-Fi CONNECTED 和 BLE CONNECTED 共存状态下时间片划分图

**动态优先级** 共存模块为每个模块的不同状态分配不同的优先级。每种状态下的优先级并不是一成不变的, 例如对于 BLE, 每 N 个广播事件 (Advertising event) 中会有一个广播事件使用高优先级。如果高优先级的广播事件发生在 Wi-Fi 时间片内, RF 的使用权可能会被 BLE 抢占。

## 4.6.4 如何使用共存功能

### 共存 API 的使用

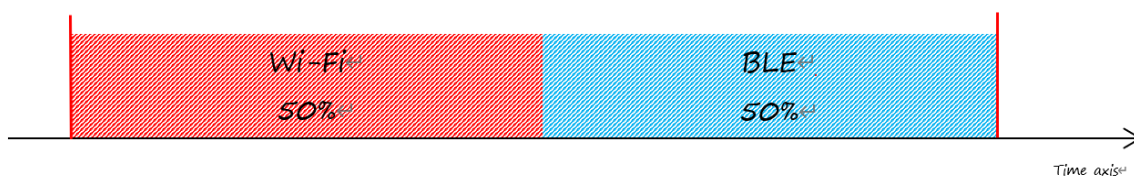
在大多数共存情况下, ESP32-H2 会自动进行共存状态切换, 无需调用 API 对其进行干预。但是对于 BLE MESH 和 Wi-Fi 的共存, ESP32-H2 对其提供了两个 API。当 BLE MESH 的状态发生变化时, 应先调用

`esp_coex_status_bit_clear` 对上一个状态进行清除，然后调用 `esp_coex_status_bit_set` 设置当前状态。

**BLE MESH 共存状态描述** 由于 Wi-Fi 和 Bluetooth 固件无法获知当前的上层应用的场景，一些共存模板需要应用代码调用共存的 API 才能生效。BLE MESH 的工作状态就需要由应用层通知给共存模块，用于选择共存模板。

- `ESP_COEX_BLE_ST_MESH_CONFIG`: 正在组网。
- `ESP_COEX_BLE_ST_MESH_TRAFFIC`: 正在传输数据。
- `ESP_COEX_BLE_ST_MESH_STANDBY`: 处于空闲状态，无大量数据交互。

### 共存 API 错误代码

所有共存 API 都有自定义的返回值，即错误代码。这些代码可分类为：

- 无错误，例如：返回值为 `ESP_OK` 代表 API 成功返回。
- 可恢复错误，例如：返回值为 `ESP_ERR_INVALID_ARG` 代表 API 参数错误。

### 设置共存编译时选项

- 在完成共存程序编写的时候，您必须通过 `menuconfig` 选择 `CONFIG_ESP_COEX_SW_COEXIST_ENABLE` 打开软件共存配置选项，否则就无法使用上文中提到的共存功能。
- 您可以通过修改以下 `menuconfig` 选项，以减小内存开销：
  - `CONFIG_BT_BLE_DYNAMIC_ENV_MEMORY` 选择打开蓝牙协议栈动态内存配置选项。

---

**备注：** 由于共存配置选项依赖于任何两个已启用的射频收发模块的存在，请在配置任何共存功能之前，确保至少使能了两个射频收发模块。

---

## 4.7 C Support

ESP-IDF is primarily written in C and provides C APIs. `Newlib` is used as standard C library (the `Newlib` version can be found in `newlib/sbom.yml`). In general, all C features supported by the compiler, currently GCC, should be available in ESP-IDF, unless specified in *Unsupported C Features* below.

### 4.7.1 C Version

**GNU dialect of ISO C17** (`--std=gnu17`) is the current default C version in ESP-IDF.

To compile the source code of a certain component using a different language standard, set the desired compiler flag in the component's `CMakeLists.txt` file:

```
idf_component_register( ... )
target_compile_options(${COMPONENT_LIB} PRIVATE -std=gnu11)
```

If the public header files of the component also need to be compiled with the same language standard, replace the flag `PRIVATE` with `PUBLIC`.



## 4.7.2 Unsupported C Features

The following features are not supported in ESP-IDF.

### Nested Function Pointers

The **GNU dialect of ISO C17** supports [nested functions](#). However, they do not work in ESP-IDF when referenced as function pointer because the compiler generates a trampoline on the stack, while the stack is not executable in ESP-IDF. Hence, do not use function pointers to nested functions.

## 4.8 C++ 支持

ESP-IDF 主要使用 C 语言编写，并提供 C 语言 API。但 ESP-IDF 也支持使用 C++ 开发应用程序，与 C++ 开发相关的各种主题在本文档中列出。

ESP-IDF 支持以下 C++ 功能：

- [异常处理](#)
- [多线程](#)
- [运行时类型信息 \(RTTI\)](#)
- [线程局部存储](#) (`thread_local` 关键字)
- 除部分限制，所有由 GCC 实现的 C++ 功能均受支持。有关由 GCC 所实现功能的详细信息，请参阅 [GCC 文档](#)。

### 4.8.1 esp-idf-cxx 组件

`esp-idf-cxx` 组件为一些 ESP-IDF 中的功能提供了更高级别的 C++ API，该组件可以从 [ESP-IDF 组件注册表](#) 中获取。

### 4.8.2 C++ 语言标准

默认情况下，ESP-IDF 使用 C++23 语言标准和 GNU 扩展 (`-std=gnu++23`) 编译 C++ 代码。

要使用其他语言标准编译特定组件的源代码，请按以下步骤，在组件的 `CMakeLists.txt` 文件中设置所需的编译器标志：

```
idf_component_register( ... )
target_compile_options(${COMPONENT_LIB} PRIVATE -std=gnu++11)
```

如果组件的公共头文件也需要以该语言标准编译，请使用 `PUBLIC` 而非 `PRIVATE`。

### 4.8.3 多线程

支持 C++ 线程，互斥锁和条件变量。C++ 线程基于 `pthread` 构建，而 `pthread` 封装了 FreeRTOS 任务。

有关在 C++ 中创建线程的示例，请参阅 [cxx/pthread](#)。

---

**备注：** `std::jthread` 的析构函数只能从 [线程 API](#) 或 [C++ 线程库 API](#) 创建的任务中安全地调用。

---

## 4.8.4 异常处理

ESP-IDF 默认禁用对 C++ 异常处理的支持，可以用 `CONFIG_COMPILER_CXX_EXCEPTIONS` 选项启用该支持。

如果抛出了异常处理，却没有相应的 `catch` 块，程序将由 `abort` 函数终止，并打印回溯信息。有关回溯信息的更多信息，请参见 [严重错误](#)。

C++ 异常处理应 **仅**应用于异常情况，即意外情况及罕见情况，如发生频率低于 1% 的事件。**请勿**将 C++ 异常处理用于流程控制，详情请参阅下文的资源使用部分。有关使用 C++ 异常处理的更多详情，请参阅 [ISO C++ FAQ](#) 和 [C++ 核心指南](#)。

有关 C++ 异常处理的示例，请参阅 [cxx/exceptions](#)。

### C++ 异常处理及所需资源

启用异常处理后，应用程序的二进制文件通常会增加几个 KB。

此外，可能需要为异常处理应急内存池保留一部分 RAM。如果无法从堆内存中分配异常处理对象，则会使用该池中的内存。

使用 `CONFIG_COMPILER_CXX_EXCEPTIONS_EMG_POOL_SIZE` 变量可以设置异常处理应急内存池的内存量。

当且仅当 C++ 异常抛出时，会使用额外的栈内存（约 200 字节），从而从栈内存顶部调用函数，启动异常处理。

使用 C++ 异常处理的代码的运行时间取决于运行时实际发生的情况。

- 如果没有抛出异常，则异常处理的代码运行速度会更快，因为无需检查错误代码。
- 如果抛出异常，异常处理代码的运行时间会比返回错误代码的代码长几个数量级。

如果抛出异常，解开栈代码的速度要比返回错误代码慢好几个数量级。所增加的运行时长取决于应用程序的要求和错误处理的实现方式（例如，是否需要用户输入或发送消息到云端）。因此，在实时关键的代码路径中，不应使用会抛出异常的代码。

## 4.8.5 运行时类型信息 (RTTI)

ESP-IDF 默认禁用对 RTTI 的支持，可以用 `CONFIG_COMPILER_CXX_RTTI` 选项启用该支持。

启用此选项，将以启用了 RTTI 支持的方式编译所有的 C++ 文件，并支持使用 `dynamic_cast` 转换和 `typeid` 运算符。启用此选项通常会增加几十 KB 的二进制文件大小。

有关在 ESP-IDF 中使用 RTTI 的示例，请参阅 [cxx/rtti](#)。

## 4.8.6 在 C++ 中进行开发

以下部分提供了在 C++ 中开发 ESP-IDF 应用程序的一些技巧。

### 组合 C 和 C++ 代码

当应用程序的不同部分使用 C 和 C++ 开发时，理解 [语言链接性](#) 的概念非常重要。

为了能够从 C 代码中调用 C++ 函数，该 C++ 函数必须使用 C 链接 (`extern "C"`) 进行 **声明**和 **定义**：

```
// 在 .h 文件中声明：
#ifdef __cplusplus
extern "C" {
#endif
```

(下页继续)



```

void my_cpp_func(void);

#ifdef __cplusplus
}
#endif

// 在 .cpp 文件中进行定义:
extern "C" void my_cpp_func(void) {
    // ...
}

```

为了能够从 C++ 中调用 C 函数，该 C 函数必须使用 C 链接声明：

```

// 在 .h 文件中声明:
#ifdef __cplusplus
extern "C" {
#endif

void my_c_func(void);

#ifdef __cplusplus
}
#endif

// 在 .c 文件中进行定义:
void my_c_func(void) {
    // ...
}

```

### 在 C++ 中定义 app\_main

ESP-IDF 希望应用程序入口点 `app_main` 以 C 链接定义。当 `app_main` 在 `.cpp` 源文件中定义时，必须以 `extern "C"` 标识：

```

extern "C" void app_main()
{
}

```

### 指定初始化器

许多 ESP-IDF 组件会以配置结构体作为初始化函数的参数。用 C 编写的 ESP-IDF 示例通常使用指定初始化器，以可读且可维护的方式填充有关结构体。

C 和 C++ 语言对于指定初始化器有不同的规则。例如，C++23（当前在 ESP-IDF 中默认使用）不支持无序指定初始化、嵌套指定初始化、混合使用指定初始化器和常规初始化器，而对数组进行指定初始化。因此，当将 ESP-IDF 的 C 示例移植到 C++ 时，可能需要对结构体初始化器进行一些更改。详细信息请参阅 [C++ aggregate initialization reference](#)。

### iostream

ESP-IDF 支持 `iostream` 功能，但应注意：

1. ESP-IDF 在构建过程中通常会删除未使用的代码。然而，在使用 `iostreams` 的情况下，仅在其中一个源文件包含 `<iostream>` 头文件就会使二进制文件增加大约 200 kB。
2. ESP-IDF 默认使用简单的非阻塞机制来处理标准输入流 (`stdin`)。要获得 `std::cin` 的常规行为，应用程序必须初始化 UART 驱动程序，并启用阻塞模式，详情请参阅 [common\\_components/protocol\\_examples\\_common/stdin\\_out.c](#)。

## 4.8.7 限制

- 链接脚本生成器不支持将具有 C++ 链接的函数单独放置在内存的特定位置。
- 当与模板函数一起使用时，会忽略各种节属性（例如 `IRAM_ATTR`）。
- `vtable` 位于 flash 中，在禁用 flash 缓存时无法访问。因此，在 [IRAM 安全中断处理程序](#) 中应避免调用虚拟函数。目前尚无法使用链接器脚本生成器调整 `vtable` 的放置位置。
- 不支持 C++ 文件系统 (`std::filesystem`) 功能。

## 4.8.8 注意事项

请勿在 C++ 中使用 `setjmp/longjmp`。`longjmp` 会在不调用任何析构函数的情况下盲目跳出堆栈，容易引起未定义的行为和内存泄漏。请改用 C++ 异常处理，这类程序可以确保正确调用析构函数。如果无法使用 C++ 异常处理，请使用其他替代方案（`setjmp/longjmp` 除外），如简单的返回码。

## 4.9 核心转储

### 4.9.1 概述

核心转储是软件发生致命错误时，由紧急处理程序自动保存的一组软件状态信息。核心转储有助于对故障进行事后分析，了解软件状态。ESP-IDF 支持生成核心转储。

核心转储包含了系统中所有任务在发生故障时的快照，每个快照都包括任务的控制块 (TCB) 和栈信息。通过分析任务快照，可以确定是哪个任务、在哪个指令（代码行），以及该任务的哪个调用栈导致了系统崩溃。如果将某些变量赋予特殊的核心转储属性，还可以转储这些变量的内容。

核心转储数据会按照特定格式保存在核心转储文件中，详情请参阅[核心转储镜像文件详解](#)。然而，ESP-IDF 的 `idf.py` 命令提供了专门的子命令，用于解码和分析核心转储文件。

### 4.9.2 配置

#### 目标

选项 `CONFIG_ESP_COREDUMP_TO_FLASH_OR_UART` 可以启用或禁用核心转储，并在启用时选择核心转储的目标。发生崩溃时，生成的核心转储文件可以保存到 flash 中，也可以通过 UART 输出到连接的主机上。

#### 格式和大小

选项 `CONFIG_ESP_COREDUMP_DATA_FORMAT` 控制核心转储文件格式，即 ELF 格式或二进制格式。

ELF 格式具备扩展特性，支持在发生崩溃时保存更多关于错误任务和崩溃软件的信息，但使用 ELF 格式会使核心转储文件变大。建议在新的软件设计中使用此格式，该格式足够灵活，可以在未来的修订版本中进行扩展，保存更多信息。

出于兼容性考虑，核心转储文件保留二进制格式。二进制格式的核心转储文件更小，性能更优。

选项 `CONFIG_ESP_COREDUMP_MAX_TASKS_NUM` 配置核心转储保存的任务快照数量。

通过 `Components > Core dump > Core dump data integrity check` 选项可进行核心转储数据完整性检查。

## 保留栈大小

核心转储例程需要解析并保存所有其他任务的栈，因此会从单独的栈中运行。选项 `CONFIG_ESP_COREDUMP_STACK_SIZE` 控制核心转储栈大小，以字节数表示。

将此选项设置为 0 字节将使核心转储例程从 ISR 栈中运行，从而节省内存。将选项设置为大于零的值将创建一个独立的栈。

---

**备注：** 如果使用了独立的栈，建议栈大小应大于 1300 字节，确保核心转储例程本身不会导致栈溢出。

---

## 核心转储内存区域

核心转储默认保存 CPU 寄存器、任务数据和崩溃原因。选择 `CONFIG_ESP_COREDUMP_CAPTURE_DRAM` 选项后，`.bss` 段和 `.data` 段以及 `heap` 数据也将保存到转储中。

推荐将上面提到的几个数据段都保存到核心转储中，以方便调试。但这会导致核心转储文件变大，具体所需的额外存储空间取决于应用程序使用的 DRAM 大小。

---

**备注：** 该功能仅在使用 ELF 文件格式时可用。

---

### 4.9.3 将核心转储保存到 flash

将核心转储文件保存至 flash 时，这些文件会保存到 flash 上的特殊分区。指定核心转储分区可以在 flash 芯片上预留空间来存储核心转储文件。

使用 ESP-IDF 提供的默认分区表时，核心转储分区会自动声明。但使用自定义分区表时，请按如下示例进行核心转储分区声明：

```
# 名称,      类型, 子类型,      偏移量,      大小
# 注意: 如果增加了引导加载程序大小, 请及时更新偏移量, 避免产生重叠
nvs,        data, nvs,        0x9000,      0x6000
phy_init,   data, phy,         0xf000,      0x1000
factory,    app,  factory, 0x10000,     1M
coredump,   data, coredump,,      64K
```

---

**重要：** 如果设备启用了 [flash 加密](#)，请在核心转储分区中添加 `encrypted` 标志。请注意，使用 `idf.py coredump-info` 或 `idf.py coredump-debug` 命令无法从加密分区读取核心转储。建议使用 `idf.py coredump-info -c <path-to-core-dump>` 命令从 ESP 设备侧读取核心转储，ESP 设备会自动解密分区并发送到相应位置用于分析。

```
coredump, data, coredump,,      64K, encrypted
```

---

分区命名没有特殊要求，可以根据应用程序的需要选择。但分区类型应为 `data`，子类型应为 `coredump`。此外，在选择分区大小时需注意，核心转储的数据结构会产生 20 字节的固定开销和 12 字节的单任务开销，此开销不包括每个任务的 TCB 和栈的大小。因此，分区大小应至少为  $20 + \text{最大任务数} \times (12 + \text{TCB 大小} + \text{最大任务栈大小})$  字节。

用于分析 flash 中核心转储的常用命令，可参考以下示例：

```
idf.py coredump-info
```

或

```
idf.py coredump-debug
```

**备注:** `idf.py coredump-info` 命令和 `idf.py coredump-debug` 命令对 `esp-coredump` 工具进行了封装，可以在 ESP-IDF 环境中轻松使用。更多信息，请参考[核心转储命令](#)。

## 4.9.4 将核心转储保存到 UART

当核心转储文件输出到 UART 时，输出文件会以 Base64 编码方式呈现。通过 `CONFIG_ESP_COREDUMP_DECODE` 选项，可以选择 ESP-IDF 监视器对输出文件自动解码，或保持编码状态等待手动解码。

### 自动解码

如果设置 `CONFIG_ESP_COREDUMP_DECODE`，使其自动解码 UART 核心转储文件，ESP-IDF 监视器会自动解码数据，将所有函数地址转换为源代码行，并在监视器中显示相应信息。ESP-IDF 监视器会输出类似以下内容：

此外，选项 `CONFIG_ESP_COREDUMP_UART_DELAY` 支持在将核心转储文件输出到 UART 前添加延迟。

```

=====
===== ESP32 CORE DUMP START =====

Crashed task handle: 0x3ffafba0, name: 'main', GDB name: 'process 1073413024'
Crashed task is not in the interrupt context
Panic reason: abort() was called at PC 0x400d66b9 on core 0

===== CURRENT THREAD REGISTERS =====
exccause      0x1d (StoreProhibitedCause)
excvaddr      0x0
epc1          0x40084013
epc2          0x0
...
===== CURRENT THREAD STACK =====
#0 0x4008110d in panic_abort (details=0x3ffb4f0b "abort() was called at PC
↳0x400d66b9 on core 0") at /builds/espessif/esp-idf/components/esp_system/panic.
↳c:472
#1 0x4008510c in esp_system_abort (details=0x3ffb4f0b "abort() was called at PC
↳0x400d66b9 on core 0") at /builds/espessif/esp-idf/components/esp_system/port/
↳esp_system_chip.c:93
...
===== THREADS INFO =====
  Id  Target Id      Frame
* 1   process 1073413024 0x4008110d in panic_abort (details=0x3ffb4f0b "abort()
↳was called at PC 0x400d66b9 on core 0") at /builds/espessif/esp-idf/components/
↳esp_system/panic.c:472
  2   process 1073413368 vPortTaskWrapper (pxCode=0x0, pvParameters=0x0) at /
↳builds/espessif/esp-idf/components/freertos/FreeRTOS-Kernel/portable/xtensa/
↳port.c:133
...
      TCB          NAME  PRIO  C/B   STACK  USED/FREE
-----
0x3ffafba0        main    1/1    368/3724
0x3ffa9cf8        IDLE0   0/0    288/1240
0x3ffa9e50        IDLE1   0/0    416/1108
...
===== THREAD 1 (TCB: 0x3ffafba0, name: 'main') =====
#0 0x4008110d in panic_abort (details=0x3ffb4f0b "abort() was called at PC
↳0x400d66b9 on core 0") at /builds/espessif/esp-idf/components/esp_system/panic.
↳c:472
#1 0x4008510c in esp_system_abort (details=0x3ffb4f0b "abort() was called at PC
↳0x400d66b9 on core 0") at /builds/espessif/esp-idf/components/esp_system/port/
↳esp_system_chip.c:93

```

```

...
===== THREAD 2 (TCB: 0x3ffafcf8, name: 'IDLE0')
↳=====
#0  vPortTaskWrapper (pxCode=0x0, pvParameters=0x0) at /builds/espressif/esp-idf/
↳components/freertos/FreeRTOS-Kernel/portable/xtensa/port.c:133
#1  0x40000000 in ?? ()
...
===== ALL MEMORY REGIONS =====
Name      Address      Size      Attrs
...
.iram0.vectors 0x40080000 0x403 R XA
.iram0.text 0x40080404 0xb8ab R XA
.dram0.data 0x3ffb0000 0x2114 RW A
...
===== ESP32 CORE DUMP END =====
=====

```

## 手动解码

如果设置 `CONFIG_ESP_COREDUMP_DECODE` 为不解码，则在以下 UART 输出的页眉和页脚之间，将输出核心转储的原始 Base64 编码正文：

```

===== CORE DUMP START =====
<将 Base64 编码的核心转储内容解码，并将其保存到磁盘文件中>
===== CORE DUMP END =====

```

建议将核心转储文本主体手动保存到文件，CORE DUMP START 和 CORE DUMP END 行不应包含在核心转储文本文件中。随后，可以使用以下命令解码保存的文本：

```
idf.py coredump-info -c </path/to/saved/base64/text>
```

或

```
idf.py coredump-debug -c </path/to/saved/base64/text>
```

## 4.9.5 核心转储命令

ESP-IDF 提供了一些特殊命令，有助于检索和分析核心转储：

- `idf.py coredump-info` - 打印崩溃任务的寄存器、调用栈、系统可用任务列表、内存区域以及核心转储中存储的内存内容（包括 TCB 和栈）。
- `idf.py coredump-debug` - 创建核心转储 ELF 文件，并使用该文件运行 GDB 调试会话。你可以手动检查内存、变量和任务状态。请注意，由于并未将所有内存保存在核心转储中，因此只有在栈上分配的变量的值才有意义。

高阶用户如果需要传递额外参数或使用自定义 ELF 文件，可直接使用 `esp-coredump` 工具。如果在 ESP-IDF 环境中使用该工具，可运行如下命令查询更多信息：

```
esp-coredump --help
```

## 4.9.6 回溯中的 ROM 函数

程序崩溃时，某些任务和/或崩溃任务本身的调用栈中可能包含一或多个 ROM 函数。由于 ROM 不是程序 ELF 的一部分，而 GDB 需要分析函数序言来解码回溯，因此 GDB 无法解析这些调用栈。因此，在遇到第一个 ROM 函数时，调用栈解析将中断并报错误。

为解决这一问题，ESP-IDF 监视器会根据目标芯片及其修订版本自动加载乐鑫提供的 ROM ELF。有关 ROM ELF 的详细信息，请参阅 [esp-rom-elfs](#)。

## 4.9.7 按需转储变量

通过读取变量的最后一个值，可以了解崩溃发生的根本原因。核心转储支持通过为已声明的变量添加特殊标记，在 GDB 上检索变量数据。

### 支持的标记和 RAM 区域

- COREDUMP\_DRAM\_ATTR 将变量放置在 DRAM 区域，该区域包含在转储中。
- COREDUMP\_RTC\_ATTR 将变量放置在 RTC 区域，该区域包含在转储中。
- COREDUMP\_RTC\_FAST\_ATTR 将变量放置在 RTC\_FAST 区域，该区域包含在转储中。

### 示例

1. 在 **项目配置菜单** 中启用 *COREDUMP TO FLASH*，随后保存并退出。
2. 在项目中，创建如下全局变量，放置在 DRAM 区域：

```
// uint8_t global_var;
COREDUMP_DRAM_ATTR uint8_t global_var;
```

3. 在主应用程序中，将该变量设置为任意值，并以 `assert(0)` 引发崩溃。

```
global_var = 25;
assert(0);
```

4. 在目标设备上构建、烧写并运行应用程序，等待转储信息。
5. 运行以下命令，在 GDB 中开始核心转储，其中 PORT 是设备的 USB 端口：

```
idf.py coredump-debug
```

6. 在 GDB shell 中，输入 `p global_var` 获取变量内容：

```
(gdb) p global_var
$1 = 25 '\031'
```

## 4.9.8 运行 `idf.py coredump-info` 和 `idf.py coredump-debug`

要获取更多有关使用方法的详情，请运行 `idf.py coredump-info --help` 和 `idf.py coredump-debug --help` 命令。

### 相关文档

#### 核心转储镜像文件详解

核心转储文件的格式可以配置为使用 ELF 格式或传统的二进制格式。建议在所有新设计中使用 ELF 格式，该格式在发生崩溃时会提供更多关于软件状态的信息，例如 CPU 寄存器和内存内容。

内存状态包含程序内存空间中映射的所有任务的快照；CPU 状态包含核心转储生成时的寄存器值。核心转储文件使用 ELF 结构的子集注册这些信息。

可加载的 ELF 段用于存储进程的内存状态，ELF 注释 (ELF.PT\_NOTE) 用于存储进程的元数据（如 pid、寄存器、信号等）。CPU 状态则存储在一个具有特殊名称 (CORE) 和类型 (NT\_PRSTATUS type) 的注释中。

下图展示了核心转储的结构:



图 6: 核心转储 ELF 镜像文件格式

**备注:** 上图仅展示当前版本镜像的文件格式, 在未来的发布版本中可能会发生变化。

**核心转储实现** 下图展示了核心转储实现的基本情况:

**备注:** 上图隐藏了部分细节, 仅展示当前版本的核心转储实现, 在未来的发布版本中可能会发生变化。

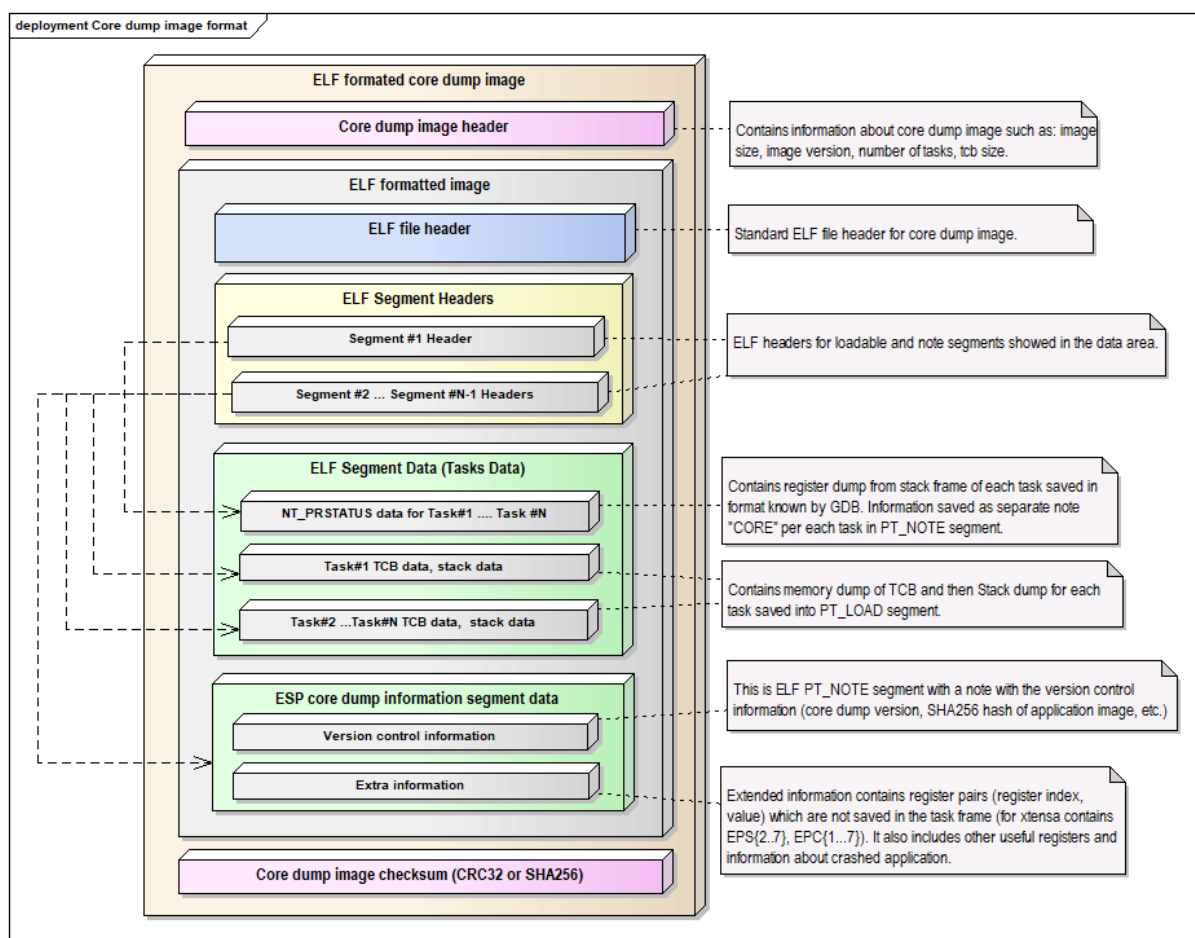
## 4.10 Current Consumption Measurement of Modules

You may want to know the current consumption of a [module](#) in deep-sleep mode, *other power-saving modes*, and active mode to develop some applications sensitive to power consumption. This section introduces how to measure the current consumption of a module running such an application.

### 4.10.1 Notes to Measurement





图 7: 核心转储二进制镜像文件格式



图 8: 核心转储实现

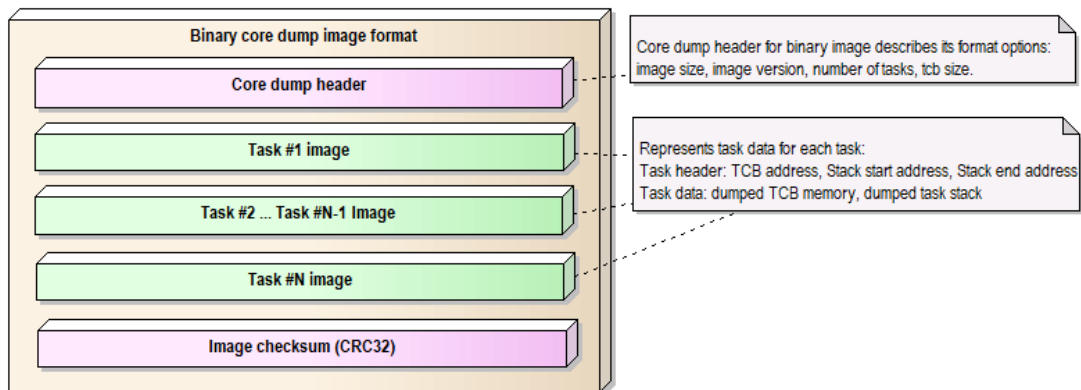

### Can We Use a Development Board?

For ESP32-H2, you can use development boards such as [ESP32-H2-DevKitM-1](#) to measure current consumption of corresponding modules as these development boards are equipped with headers, which can be used to measure current drawn by modules.

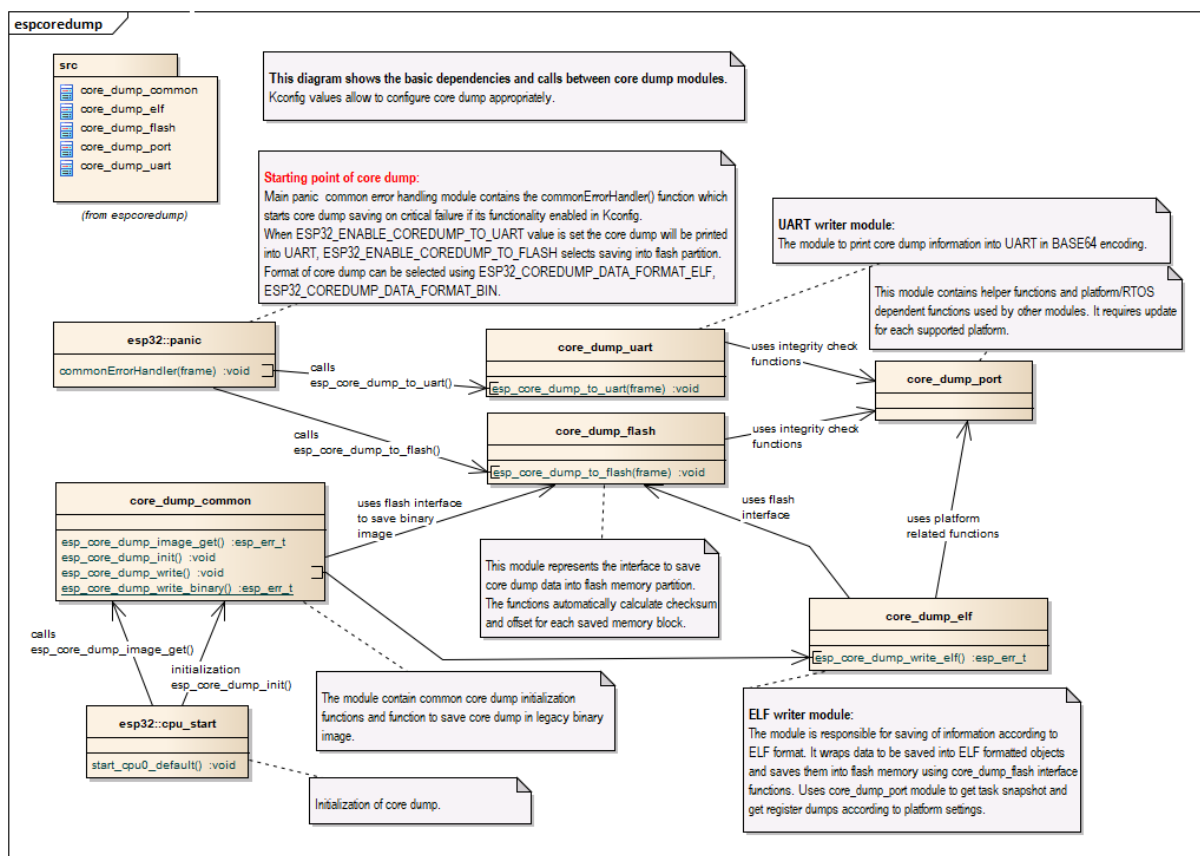
With such development boards, you can measure current consumption of modules in deep-sleep mode by flashing chips with the [deep\\_sleep](#) example. However, you can also measure current of bare modules equipped with ESP32-H2 chip using the following method.

### How to Choose an Appropriate Ammeter?

In the [deep\\_sleep](#) example, the module will be woken up every 20 seconds. In deep-sleep mode, the current in the module is just several microamps ( $\mu\text{A}$ ), while in active mode, the current is in the order of milliamps (mA). The high dynamic current range makes accurate measurement difficult. Ordinary ammeters cannot dynamically switch the measurement range fast enough.

Additionally, ordinary ammeters have a relatively high internal resistance, resulting in a significant voltage drop. This may cause the module to enter an unstable state, as it is powered by a voltage smaller than the minimum required voltage supply.

Therefore, an ammeter suitable for measuring current in deep-sleep mode should have low internal resistance and, ideally, switch current ranges dynamically. We recommend two options: the [Joulescope ammeter](#) and the [Power Profiler Kit II from Nordic](#).

**Joulescope Ammeter** The Joulescope ammeter combines high-speed sampling and rapid dynamic current range switching to provide accurate and seamless current and energy measurements, even for devices with rapidly varying current consumption. Joulescope accurately measures electrical current over nine orders of magnitude from amps down to nanoamps. This wide range allows for accurate and precise current measurements for devices. Additionally, Joulescope has a total voltage drop of 25 mV at 1 A, which keeps the module running normally. These two features make Joulescope a perfect option for measuring the module switching between deep-sleep mode and wake-up mode.

Joulescope has no display screen. You need to connect it to a PC to visualize the current waveforms of the measured module. For specific instructions, please follow the documentation provided by the manufacturer.

**Nordic Power Profiler Kit II** The Nordic Power Profiler Kit II has an advanced analog measurement unit with a high dynamic measurement range. This allows for accurate power consumption measurements for the entire range typically seen in low-power embedded applications, all the way from single  $\mu\text{As}$  to 1 A. The resolution varies between 100 nA and 1 mA, depending on the measurement range, and is high enough to detect small spikes often seen in low-power optimized systems.

## 4.10.2 Hardware Connection

To measure the power consumption of a bare module, you need an [ESP-Prog](#) to flash the [deep\\_sleep](#) example to the module and power the module during measurement, a suitable ammeter (here we use the Joulescope ammeter), a computer, and of course a bare module with necessary jumper wires. For the connection, please refer to the following figure.

Please connect the pins of **UART TX**, **UART RX**, **SPI Boot**, **Enable**, and **Ground** on the measured module with corresponding pins on ESP-Prog, and connect the **VPROG** pin on ESP-Prog with the **IN+** port on the Joulescope ammeter and connect its **OUT+** port with the **Power supply (3V3)** pin on the measured module. For the specific names of these pins in different modules, please refer to the list below.



图 9: Hardware Connection (click to enlarge)

表 2: Pin Names of Modules Based on ESP32-H2 Chip

Function of Module Pin	Pin Name
UART TX	TXD0
UART RX	RXD0
SPI Boot	IO9
Enable	EN
Power Supply	3V3
Ground	GND

For details of the pin names, please refer to the [datasheet of specific module](#).

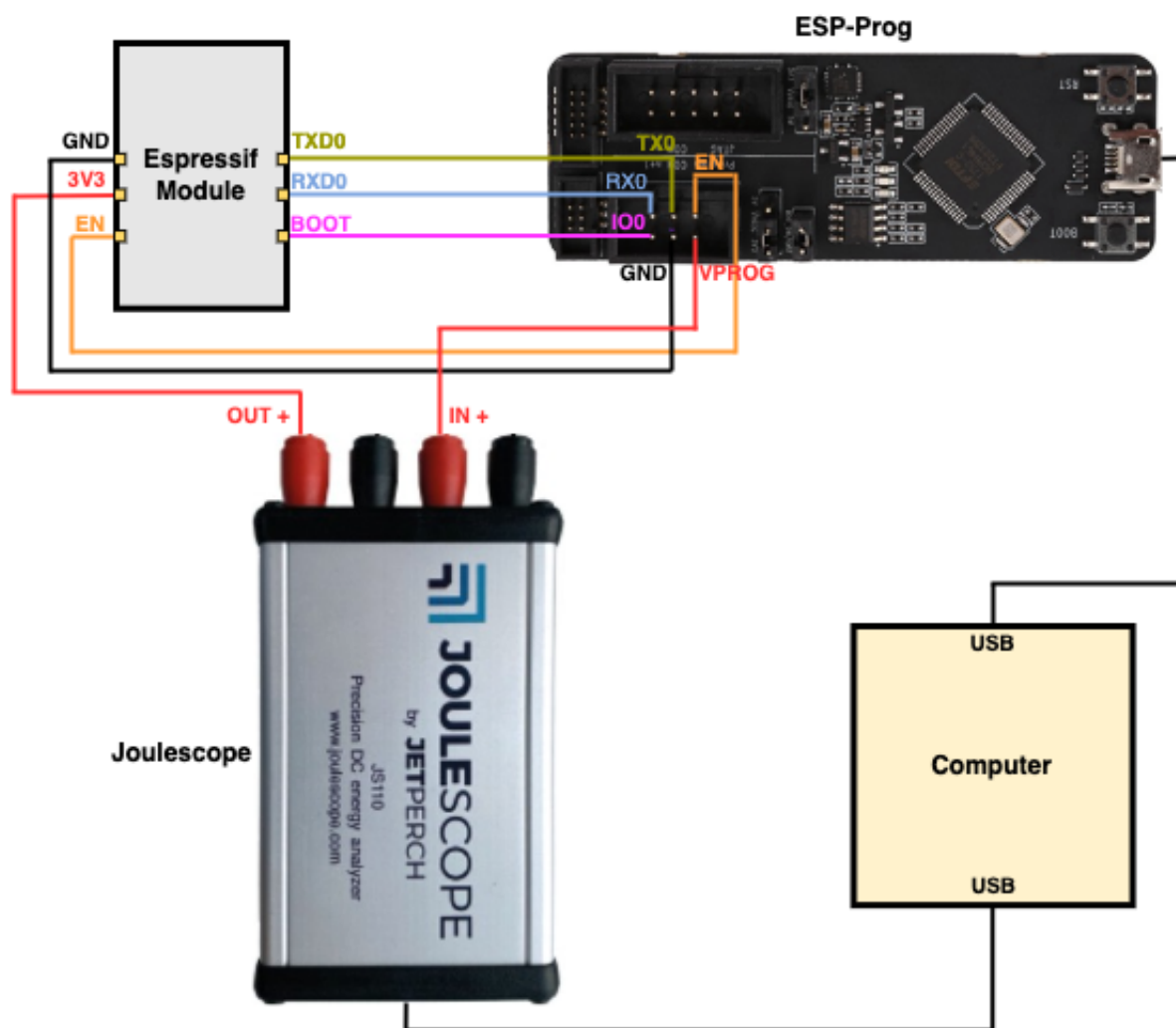
### 4.10.3 Measurement Steps

ESP32-S3-WROOM-1 is used as an example in the measurement, and other modules can be measured similarly. For the specific current consumption of chips in different modes, please refer to the Current Consumption subsection in the corresponding [chip datasheet](#).

You can refer to the following steps to measure the current in deep-sleep mode.

- Connect the aforementioned devices according to the hardware connection.
- Flash the `deep_sleep` example to the module. For details, please refer to Start a Project on Linux and macOS for a computer with Linux or macOS system or Start a Project on Windows for a computer with Windows system.
- By default, the module will be woken up every 20 seconds (you can change the timing by modifying the code of this example). To check if the example runs as expected, you can monitor the module operation by running `idf.py -p PORT monitor` (please replace PORT with your serial port name).
- Open the Joulescope software to see the current waveform as shown in the image below.

From the waveforms, you can obtain that the current of the module in deep-sleep mode is 8.14  $\mu\text{A}$ . In addition, you can also see the current of the module in active mode, which is about 23.88 mA. The waveforms also show that the average power consumption during deep-sleep mode is 26.85  $\mu\text{W}$ , and the average power consumption during active mode is 78.32 mW.

The figure below shows the total power consumption of one cycle is 6.37 mW.

By referring to these power consumption in different modes, you can estimate the power consumption of your applications and choose the appropriate power source.

## 4.11 Deep Sleep Wake Stubs

### 4.11.1 Introduction

The wakeup time from Deep-sleep mode is much longer, compared to Light-sleep and Modem-sleep modes as ROM and RAM are both powered down in this case, and the CPU needs more time for SPI booting. However, ESP32-H2 supports running a “deep sleep wake stub” when coming out of deep sleep. This function runs immediately as soon as the chip wakes up - before any normal initialization, bootloader, or ESP-IDF code has run.

Specifically, after waking up from Deep-sleep mode, ESP32-H2 starts partial initialization. Then RTC fast memory will be validated with CRC. If validation passes, the wake stub code will be executed.

As ESP32-H2 has just woken up from deep sleep, most of the peripherals are in the reset state. The SPI flash has not been mapped. Thus, wake stub code can only call functions implemented in ROM or loaded into RTC fast memory, which retains content during deep sleep.

From the above, utilizing the wake stub functionality in an application you can quickly run some code when waking up from Deep-sleep mode, without having to wait for the whole boot-up process. However, the stub size is restricted by the size of RTC fast memory.



图 10: Current Waveform of ESP32-S3-WROOM-1 (click to enlarge)



图 11: Power Consumption of ESP32-S3-WROOM-1 (click to enlarge)

ESP32-H2 only supports RTC fast memory. The wake stub code and data that it utilizes should be loaded into RTC fast memory.

Next we will introduce how to implement the wake stub code in an application.

### 4.11.2 Implement wake stub

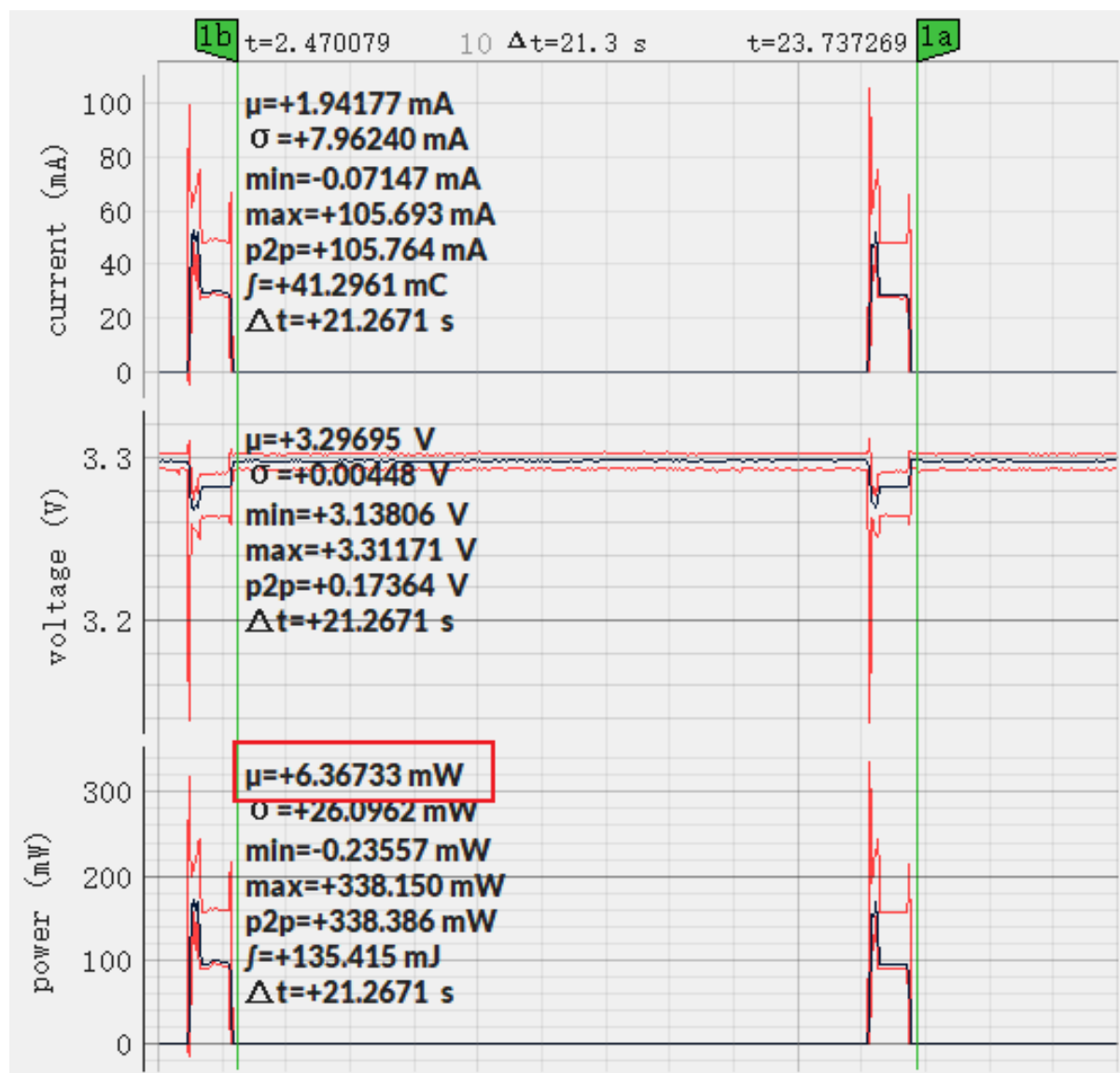
The wake stub in esp-idf is realized by the function `esp_wake_deep_sleep()`. This function is executed whenever the SoC wakes from deep sleep. As this function is weakly-linked to the default function `esp_default_wake_deep_sleep()`, if your application contains a function with the name `esp_wake_deep_sleep()`, the default version `esp_default_wake_deep_sleep()` in esp-idf will be overridden.

Please note that implementing the function `esp_wake_deep_sleep()` in your application is not mandatory for utilizing the deep sleep functionality. It becomes necessary only if you want to introduce certain behavior immediately upon the SoC's wake-up.

When you develop a customized wake stub, the first step it should do is to call the default function `esp_default_wake_deep_sleep()`.

In addition, you can switch between different wake stubs by calling the function `esp_set_deep_sleep_wake_stub()` during runtime.

Implementing the wake stub function in your application includes the following steps:

- Loading wake stub code into RTC fast memory
- Loading data into RTC fast memory

#### Load Wake Stub Code into RTC Fast Memory

The wake stub code can only call functions present in ROM or loaded into RTC fast memory. All other RAM locations are uninitialized and contain random data. While the wake stub code can use other RAM areas for temporary storage, the contents of these areas will be overwritten either upon returning to deep sleep mode or upon initiating esp-idf.

Wake stub code is a part of the main esp-idf application. During regular execution of esp-idf, functions can call the wake stub code or access RTC memory, treating them as a regular part of the application.

Wake stub code must reside in RTC fast memory. This can be realized in two ways.

- Employ the attribute `RTC_IRAM_ATTR` to place `esp_wake_deep_sleep()` into RTC fast memory:

```
void RTC_IRAM_ATTR esp_wake_deep_sleep(void) {
    esp_default_wake_deep_sleep();
    // Add additional functionality here
}
```

The first approach is suitable for short and simple code segments or for source files including both "normal" and "RTC" code.

- Place the function `esp_wake_deep_sleep()` into any source file with name starting with `rtc_wake_stub`. For files with such names `rtc_wake_stub*`, their contents can be automatically put into RTC fast memory by the linker.

The second method is preferable when writing longer code segments in RTC fast memory.

However, any string constants used in this way must be declared as arrays and marked with `RTC_RODATA_ATTR`, as shown in the example above.

- Place the data into any source file with name starting with `rtc_wake_stub`, as demonstrated in the example source file `system/deep_sleep_wake_stub/main/rtc_wake_stub_example.c`.

```

if (s_count >= s_max_count) {
    // Reset s_count
    s_count = 0;

    // Set the default wake stub.
    // There is a default version of this function provided in esp-idf.
    esp_default_wake_deep_sleep();

    // Return from the wake stub function to continue
    // booting the firmware.
    return;
}

```

The second approach is advisable when incorporating strings or more complex code segments.

You can enable the Kconfig option `CONFIG_BOOTLOADER_SKIP_VALIDATE_IN_DEEP_SLEEP` to reduce wake-up time. See more information in [Fast boot from Deep Sleep](#).

All of the above functions are declared in `esp_hw_support/include/esp_sleep.h`.

### Load Wake Stub Data into RTC Fast memory

Data used by wake stub code must be resident in RTC fast memory.

The data can be specified in the following two methods:

- Use the `RTC_DATA_ATTR` and `RTC_RODATA_ATTR` to specify writable or read-only data, respectively.

```

RTC_DATA_ATTR int wake_count;

void RTC_IRAM_ATTR esp_wake_deep_sleep(void) {
    esp_default_wake_deep_sleep();
    static RTC_RODATA_ATTR const char fmt_str[] = "Wake count %d\n";
    esp_rom_printf(fmt_str, wake_count++);
}

```

The attributes `RTC_FAST_ATTR` and `RTC_SLOW_ATTR` can be used to specify data that will be force placed into RTC fast memory and RTC slow memory respectively. However, ESP32-H2 includes RTC fast memory only, so both these two attributes will map to this region.

### 4.11.3 Example

ESP-IDF provides an example to show how to implement the deep sleep wake stub.

- [system/deep\\_sleep\\_wake\\_stub](#)

## 4.12 错误处理

### 4.12.1 概述

在应用程序开发中，及时发现并处理在运行时期的错误，对于保证应用程序的健壮性非常重要。常见的运行时错误有如下几种：

- 可恢复的错误：
  - 通过函数的返回值（错误码）表示的错误
  - 使用 `throw` 关键字抛出的 C++ 异常



- 不可恢复（严重）的错误：
  - 断言失败（使用 `assert` 宏或者其它类似方法，可参考 [Assertions](#)）或者直接调用 `abort()` 函数造成的错误
  - CPU 异常：访问受保护的内存区域、非法指令等
  - 系统级检查：看门狗超时、缓存访问错误、堆栈溢出、堆栈粉碎、堆栈损坏等

本文将介绍 ESP-IDF 中针对可恢复错误的错误处理机制，并提供一些常见错误的处理模式。

关于如何处理不可恢复的错误，请查阅 [不可恢复错误](#)。

## 4.12.2 错误码

ESP-IDF 中大多数函数会返回 `esp_err_t` 类型的错误码，`esp_err_t` 实质上是带符号的整型，`ESP_OK` 代表成功（没有错误），具体值定义为 0。

在 ESP-IDF 中，许多头文件都会使用预处理器，定义可能出现的错误代码。这些错误代码通常均以 `ESP_ERR_` 前缀开头，一些常见错误（比如内存不足、超时、无效参数等）的错误代码则已经在 `esp_err.h` 文件中定义好了。此外，ESP-IDF 中的各种组件 (component) 也都可以针对具体情况，自行定义更多错误代码。

完整错误代码列表，请见 [错误代码参考](#) 中查看完整的错误列表。

## 4.12.3 错误码到错误消息

错误代码并不直观，因此 ESP-IDF 还可以使用 `esp_err_to_name()` 或者 `esp_err_to_name_r()` 函数，将错误代码转换为具体的错误消息。例如，我们可以向 `esp_err_to_name()` 函数传递错误代码 `0x101`，可以得到返回字符串“ESP\_ERR\_NO\_MEM”。这样一来，我们可以在日志中输出更加直观的错误消息，而不是简单的错误码，从而帮助研发人员更快理解发生了何种错误。

此外，如果出现找不到匹配的 `ESP_ERR_` 值的情况，函数 `esp_err_to_name_r()` 则会尝试将错误码作为一种 **标准 POSIX 错误代码** 进行解释。具体过程为：POSIX 错误代码（例如 `ENOENT`，`ENOMEM`）定义在 `errno.h` 文件中，可以通过 `errno` 变量获得，进而调用 `strerror_r` 函数实现。在 ESP-IDF 中，`errno` 是一个基于线程的局部变量，即每个 FreeRTOS 任务都有自己的 `errno` 副本，通过函数修改 `errno` 也只会作用于当前任务中的 `errno` 变量值。

该功能（即在无法匹配 `ESP_ERR_` 值时，尝试用标准 POSIX 解释错误码）默认启用。用户也可以禁用该功能，从而减小应用程序的二进制文件大小，详情可见 [CONFIG\\_ESP\\_ERR\\_TO\\_NAME\\_LOOKUP](#)。注意，该功能对禁用并不影响 `esp_err_to_name()` 和 `esp_err_to_name_r()` 函数的定义，用户仍可调用这两个函数转化错误码。在这种情况下，`esp_err_to_name()` 函数在遇到无法匹配错误码的情况会返回 `UNKNOWN ERROR`，而 `esp_err_to_name_r()` 函数会返回 `Unknown error 0xXXXX (YYYYY)`，其中 `0xXXXX` 和 `YYYYY` 分别代表错误代码的十六进制和十进制表示。

## 4.12.4 ESP\_ERROR\_CHECK 宏

宏 `ESP_ERROR_CHECK` 的功能和 `assert` 类似，不同之处在于：这个宏会检查 `esp_err_t` 的值，而非判断 `bool` 条件。如果传给 `ESP_ERROR_CHECK` 的参数不等于 `ESP_OK`，则会在控制台上打印错误消息，然后调用 `abort()` 函数。

错误消息通常如下所示：

```
ESP_ERROR_CHECK failed: esp_err_t 0x107 (ESP_ERR_TIMEOUT) at 0x400d1fdf

file: "/Users/user/esp/example/main/main.c" line 20
func: app_main
expression: sdmmc_card_init(host, &card)

Backtrace: 0x40086e7c:0x3ffb4ff0 0x40087328:0x3ffb5010 0x400d1fdf:0x3ffb5030
↳ 0x400d0816:0x3ffb5050
```



**备注：** 如果使用 *IDF* 监视器，则最后一行回溯结果中的地址将会被自动解析为相应的文件名和行号。

- 第一行打印错误代码的十六进制表示，及该错误在源代码中的标识符。这个标识符取决于 `CONFIG_ESP_ERR_TO_NAME_LOOKUP` 选项的设定。最后，第一行还会打印程序中该错误发生的具体位置。
- 下面几行显示了程序中调用 `ESP_ERROR_CHECK` 宏的具体位置，以及传递给该宏的参数。
- 最后一行打印回溯结果。对于所有不可恢复错误，这里在应急处理程序中打印的内容都是一样的。更多有关回溯结果的详细信息，请参阅 [不可恢复错误](#)。

#### 4.12.5 ESP\_ERROR\_CHECK\_WITHOUT\_ABORT 宏

宏 `ESP_ERROR_CHECK_WITHOUT_ABORT` 的功能和 `ESP_ERROR_CHECK` 类似，不同之处在于它不会调用 `abort()`。

#### 4.12.6 ESP\_RETURN\_ON\_ERROR 宏

宏 `ESP_RETURN_ON_ERROR` 用于错误码检查，如果错误码不等于 `ESP_OK`，该宏会打印错误信息，并使原函数立刻返回。

#### 4.12.7 ESP\_GOTO\_ON\_ERROR 宏

宏 `ESP_GOTO_ON_ERROR` 用于错误码检查，如果错误码不等于 `ESP_OK`，该宏会打印错误信息，将局部变量 `ret` 赋值为该错误码，并使原函数跳转至给定的 `goto_tag`。

#### 4.12.8 ESP\_RETURN\_ON\_FALSE 宏

宏 `ESP_RETURN_ON_FALSE` 用于条件检查，如果给定条件不等于 `true`，该宏会打印错误信息，并使原函数立刻返回，返回值为给定的 `err_code`。

#### 4.12.9 ESP\_GOTO\_ON\_FALSE 宏

宏 `ESP_GOTO_ON_FALSE` 用于条件检查，如果给定条件不等于 `true`，该宏会打印错误信息，将局部变量 `ret` 赋值为给定的 `err_code`，并使原函数跳转至给定的 `goto_tag`。

#### 4.12.10 CHECK 宏使用示例

示例：

```
static const char* TAG = "Test";

esp_err_t test_func(void)
{
    esp_err_t ret = ESP_OK;

    ESP_ERROR_CHECK(x); // err message_
    ↪printed if `x` is not `ESP_OK`, and then `abort()`.
    ESP_ERROR_CHECK_WITHOUT_ABORT(x); // err message_
    ↪printed if `x` is not `ESP_OK`, without `abort()`.
    ESP_RETURN_ON_ERROR(x, TAG, "fail reason 1"); // err message_
    ↪printed if `x` is not `ESP_OK`, and then function returns with code `x`.
    ESP_GOTO_ON_ERROR(x, err, TAG, "fail reason 2"); // err message_
    ↪printed if `x` is not `ESP_OK`, `ret` is set to `x`, and then jumps to `err`.
```

(下页继续)

```

    ESP_RETURN_ON_FALSE(a, err_code, TAG, "fail reason 3"); // err message
↳printed if `a` is not `true`, and then function returns with code `err_code`.
    ESP_GOTO_ON_FALSE(a, err_code, err, TAG, "fail reason 4"); // err message
↳printed if `a` is not `true`, `ret` is set to `err_code`, and then jumps to
↳`err`.

err:
    // clean up
    return ret;
}

```

**备注：**如果 Kconfig 中的 `CONFIG_COMPILER_OPTIMIZATION_CHECKS_SILENT` 选项被打开，CHECK 宏将不会打印错误信息，其他功能不变。

ESP\_RETURN\_xx 和 ESP\_GOTO\_xx 宏不可以在中断服务程序里被调用。如需要在中断中使用类似功能，请使用 xx\_ISR 宏，如 ESP\_RETURN\_ON\_ERROR\_ISR 等。

### 4.12.11 错误处理模式

1. 尝试恢复。根据具体情况不同，我们具体可以：
  - 在一段时间后，重新调用该函数；
  - 尝试删除该驱动，然后重新进行“初始化”；
  - 采用其他带外机制，修改导致错误发生的条件（例如，对一直没有响应的外设进行复位等）。

示例：

```

esp_err_t err;
do {
    err = sdio_slave_send_queue(addr, len, arg, timeout);
    // 如果发送队列已满就不断重试
} while (err == ESP_ERR_TIMEOUT);
if (err != ESP_OK) {
    // 处理其他错误
}

```

2. 将错误传递回调用程序。在某些中间件组件中，采用此类处理模式代表函数必须以相同的错误码退出，这样才能确保所有分配的资源都能得到释放。

示例：

```

sdmmc_card_t* card = calloc(1, sizeof(sdmmc_card_t));
if (card == NULL) {
    return ESP_ERR_NO_MEM;
}
esp_err_t err = sdmmc_card_init(host, &card);
if (err != ESP_OK) {
    // 释放内存
    free(card);
    // 将错误码传递给上层（例如通知用户）
    // 或者，应用程序可以自定义错误代码并返回
    return err;
}

```

3. 转为不可恢复错误，比如使用 ESP\_ERROR\_CHECK。详情请见 [ESP\\_ERROR\\_CHECK 宏](#) 章节。对于中间件组件而言，通常并不希望在发生错误时中止应用程序。不过，有时在应用程序级别，这种做法是可以接受的。在 ESP-IDF 的示例代码中，很多都会使用 ESP\_ERROR\_CHECK 来处理各种 API 引发的错误，虽然这不是应用程序的最佳做法，但可以让示例代码看起来更加简洁。
- 示例：

```
ESP_ERROR_CHECK(spi_bus_initialize(host, bus_config, dma_chan));
```

### 4.12.12 C++ 异常

请参考[异常处理](#)。

## 4.13 ESP-BLE-MESH

蓝牙 mesh 网络实现了无线设备的“多对多”通讯，其可用于建立包含大量设备的网络。

设备能将数据中继至不在初始设备无线电覆盖范围内的其他设备。这样，mesh 网络就能够覆盖非常大的物理区域，并且囊括大量设备。Mesh 网络非常适用于楼宇自动化、传感器网络和其他物联网解决方案，这些情景下数以十计、百计、千计的设备需要与其他设备进行安全可靠的通信。

蓝牙 mesh 并非无线通信技术，而是一种网络技术。该技术基于一种无线通讯协议栈，即低功耗蓝牙。

ESP-BLE-MESH 基于 Zephyr 蓝牙 Mesh 协议栈的顶端，其实现支持设备配网和节点控制，同时也实现了代理、中继、低功耗和朋友等节点功能。

有关 ESP-BLE-MESH 架构实现的信息，请参见[ESP-BLE-MESH 架构](#)；有关各自 API 的信息，请参见[ESP-BLE-MESH API Reference](#)。

ESP-BLE-MESH 的实现和认证基于最新的 [Mesh Profile v1.0.1](#)。有关 ESP-BLE-MESH 认证的细节，请参考[此处](#)。

### 4.13.1 ESP-BLE-MESH 快速入门

该章节旨在帮助你基于乐鑫的 ESP32 开发板搭建 ESP-BLE-MESH 网络。

我们将会展示如何搭建并运行一个包含 3 个节点的小型 ESP-BLE-MESH 网络，其中包含设备配网、节点配置，以及向特定节点上的 Generic OnOff Server Model 发送开关灯命令。

如果你是第一次接触 ESP-IDF，请参见 [esp-idf 快速入门](#) 来设置开发环境，编译、烧写和运行示例应用程序。

#### 硬件及软件准备

硬件：

- 3 块 ESP32 开发板，请参见[options](#)。
- 连接开发板的 USB 线。
- ESP-IDF 开发环境。
- 运行 Android 或 iOS 的手机或平板。

软件：

- 下载至 ESP32 开发板的示例应用 [bluetooth/esp\\_ble\\_mesh/onoff\\_models](#)。
- 手机 App: **nRF Mesh** Android 或 iOS 版本。除 nRF Mesh 的 App，以下 App 也支持 ESP-BLE-MESH:
  - [EspBleMesh](#) Android App
  - Silicon Labs Android 或 iOS App

#### 安装

以下详细步骤可指导你完成安装过程。

**步骤 1. 检查硬件** ESP32-DevKitC 和 ESP-WROVER-KIT 开发板均支持 ESP-BLE-MESH。你可以通过 `menuconfig: idf.py menuconfig > Example Configuration > Board selection for ESP-BLE-MESH` 选择特定的开发板。

**备注:** 如果你打算使用 ESP32-DevKitC 开发板, 请将 RGB 灯焊接至 GPIO 管脚 25、26 和 27。

**步骤 2. 配置软件** 进入 `bluetooth/esp_ble_mesh/onoff_models` 示例文件夹, 运行 `idf.py menuconfig` 选择所使用的开发板, 然后运行 `idf.py build` 编译示例。

### 步骤 3. 下载应用

`bluetooth/esp_ble_mesh/onoff_models` 示例编译成功后, 用户可以运行 `idf.py flash` 将编译生成的二进制文件下载至 3 块开发板中。

当开发板上电后, RGB 灯会变为绿色。



图 12: ESP-BLE-MESH 设备上电

**步骤 4. 设备配网** 在该章节中, 我们将使用 **nRF Mesh Android App** 演示如何配网设备。用户也可以从 App Store 下载其 iOS 版本。

**4.1 扫描 (scanner)** 扫描 (Scanner) 是 nRF Mesh App 搜索蓝牙通信范围内未配网设备的功能。打开 App, 点击底部的扫描按钮 **Scanner**。App 就会开始扫描设备, 很快, 我们便可在屏幕上看到 3 个未配网设备。

**4.2 识别** 用户可以选择任何一个未配网设备, 此时 App 会尝试和该设备建立连接。连接成功 (有时可能需要尝试多次), 且发现相应的 ESP-BLE-MESH GATT 服务后, 用户可以在屏幕中看到识别按钮 **IDENTIFY**。IDENTIFY 操作告诉用户哪个设备将被配网。

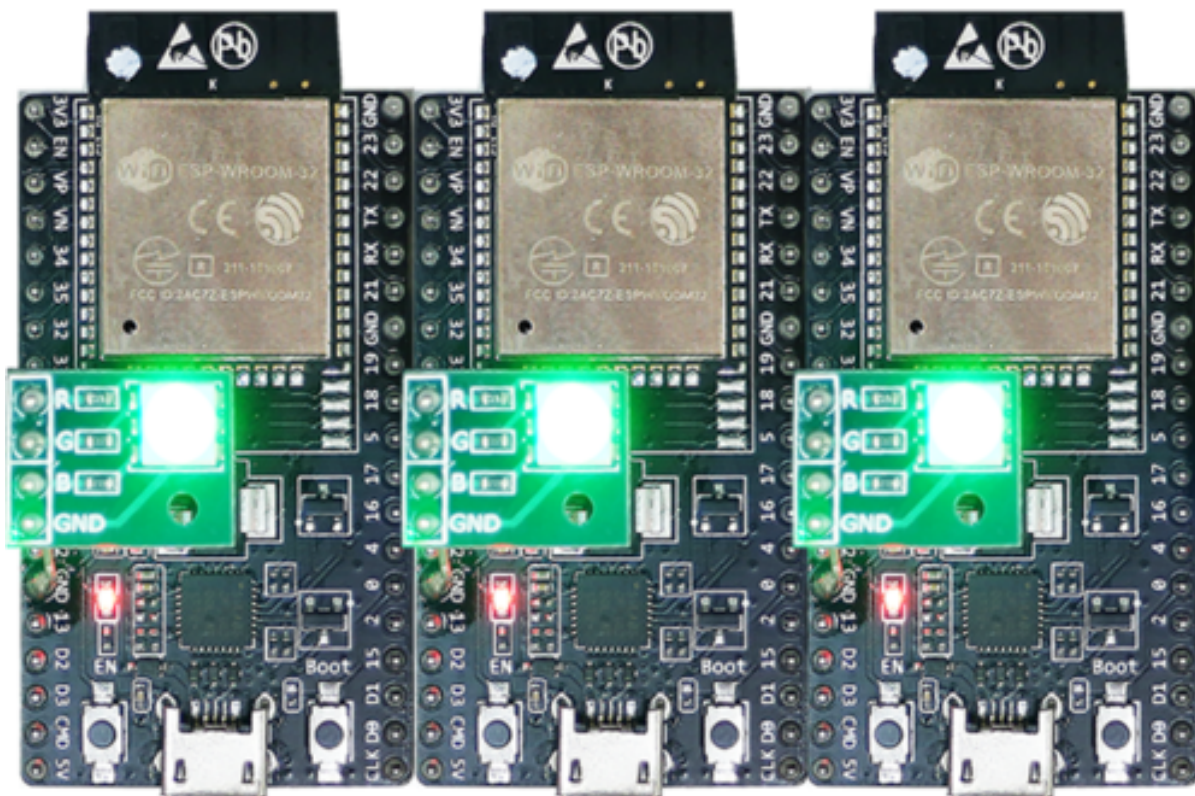

图 13: nRF Mesh - 扫描

**备注:** IDENTIFY 需要设备侧的支持，然后才能用来识别当前正在配网的设备。当前如果点击识别按钮 **IDENTIFY**，除了串口输出的 log，在当前的 example 中设备侧不会有其他现象。

点击识别按钮 **IDENTIFY** 后，用户可以看到配网按钮 **PROVISION**。

**4.3 配网** 点击配网按钮 **PROVISION**，App 会开始配网设备。当设备配网成功后，开发板上的 RGB 灯会熄灭，此时 App 会执行以下几个步骤：

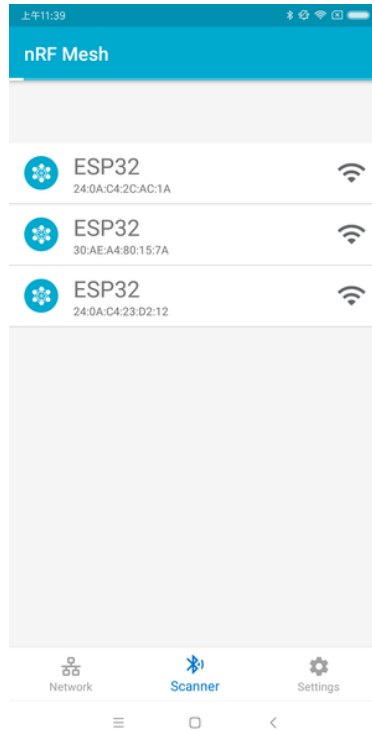
1. 和该节点（设备配网后成为节点）断开连接
2. 尝试和该节点重新建立连接
3. 连接成功并且发现了相应的 ESP-BLE-MESH GATT 服务
4. 获取节点的 Composition Data 并且给该节点添加 AppKey

当以上所有的步骤完成后，节点初始配置完成。此时点击 **OK**，用户可以看见节点的单播地址分配成功，并且其 Composition Data 也被成功解析。

有时在上述步骤 2 中，App 可能与节点连接失败。这种情况下，用户点击 **OK** 后可以看到，节点只有单播地址被成功分配，Composition data 并没有被成功获取。此时用户需要点击右上角的连接按钮 **CONNECT**，屏幕上会显示原先配网的节点，用户需要选择该节点并与其建立连接。

连接成功后，App 会显示获取 Composition Data 以及添加 AppKey 的按钮。

如果该设备是 App 配网的第二个或第三个节点，此时点击连接按钮 **CONNECT** 后，用户可以在屏幕中看到 2 个或 3 个节点。这种情况下，用户可以选择其中的任何一个节点建立连接，连接成功后可以返回至主界面选择需要配置的节点。

这里给出了一个 3 个节点的示例。

- 左侧图片表示第三个设备成功配网，但是 App 没有和其成功建立连接。当 App 尝试去重新连接第三个节点时，界面上会出现 3 个节点。
- 右侧图片表示和节点成功建立连接后，App 显示这 3 个节点的信息。用户可以看到 App 已经获取了第一个和第二个节点的 Composition Data，但是对于第三个节点，只有单播地址被成功分配而节点的 Composition Data 未知。





图 14: nRF Mesh - 识别 - 配网



图 15: nRF Mesh - 配置完成

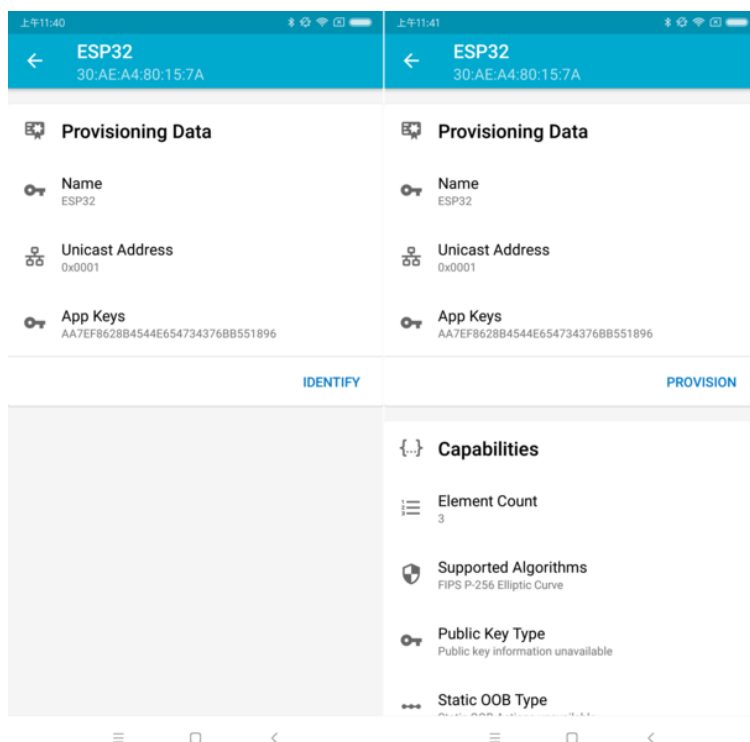

图 16: nRF Mesh - 初始配置失败

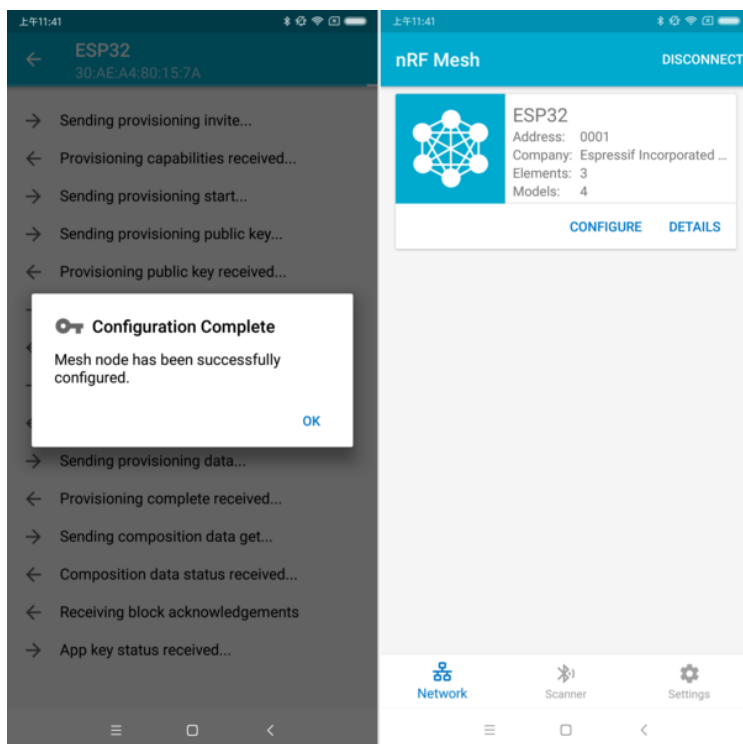

图 17: nRF Mesh - 重连 - 初始配置

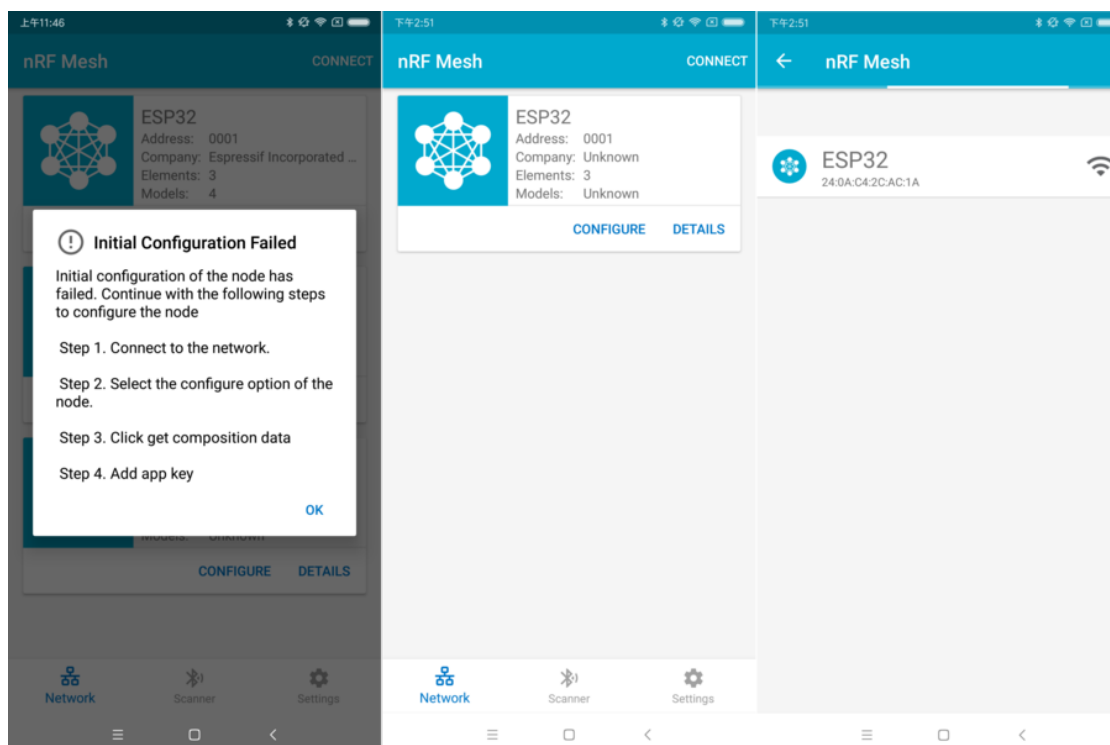

图 18: nRF Mesh - 重连 - 3 个节点

**4.4 配置** 当成功配网和初始配置完成后，用户可以配置节点的其余信息，例如将 AppKey 绑定至每个元素 (element) 的每个模型 (model) 中、设置模型的发布信息等。

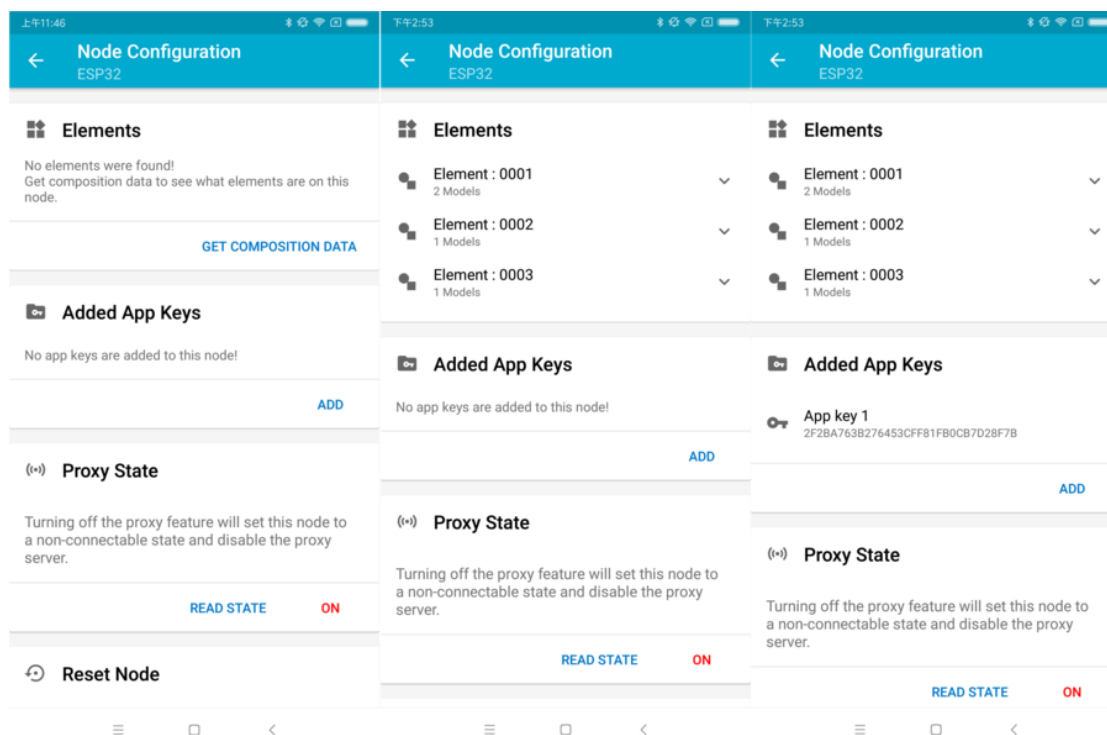
下图展示了如何将 AppKey 绑定至 Primary Element 中的 Generic OnOff Server Model 上。

**备注：** 用户不需要将 AppKey 绑定至 Configuration Server Model，因为该模型使用 DevKey 在 Upper Transport Layer 中对消息进行加密。

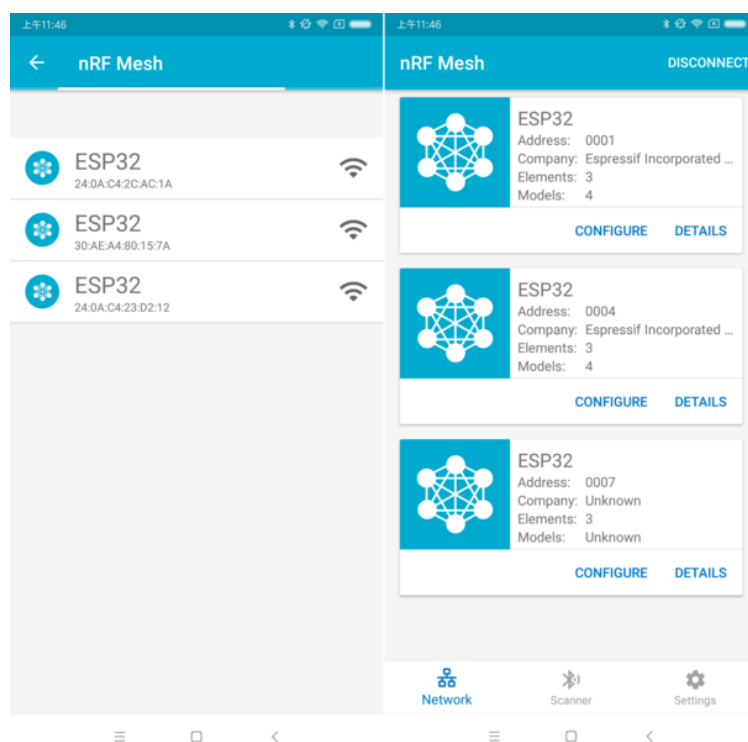
**Step 5. 运行网络** 当 3 个元素中的 Generic OnOff Server Models 均成功绑定 AppKey 后，用户可以使用 App 开关 RGB 灯。

在 [bluetooth/esp\\_ble\\_mesh/onoff\\_models](#) 示例中，第一个 Generic OnOff Server Model 用来控制 **红色**，第二个用来控制 **绿色**，同时第三个用来控制 **蓝色**。

下图展示了打开了不同色灯的开发板。

**备注：** 对于 nRF Mesh iOS App [version 1.0.4]，当节点包含超过一个元素时，App 表现不正确。如果用户尝试打开或者关闭第 2 个或第 3 个 Generic OnOff Server Model，App 会将相应的消息发送至第 1 个 Generic OnOff Server Model。

### 4.13.2 ESP-BLE-MESH 示例

- **开关节点** - 展示了将 ESP-BLE-MESH 作为拥有 Configuration Server model 和 Generic OnOff Server model 的节点设备的用法。然后，ESP-BLE-MESH Provisioner 可以配网设备，控制表示开/关状态的 RGB 灯，示例请见 [example code](#)。
- **客户端模型** - 展示了 Generic OnOff Client model 如何在节点内工作。节点拥有 Configuration Server model、Generic OnOff Server model 和 Generic OnOff Client model，示例请见：[example code](#)。





图 19: nRF Mesh - Model Bind AppKey



图 20: nRF Mesh - 通用开关控制

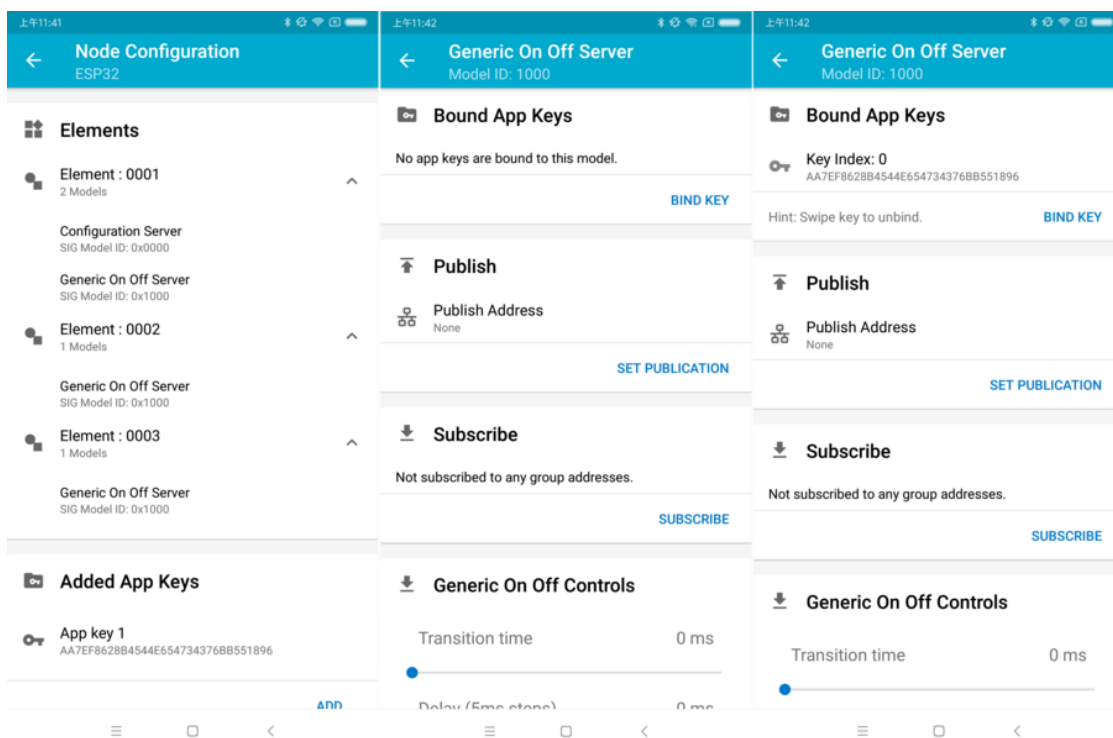

图 21: 3 个上电的 ESP-BLE-MESH 节点

- **配网器** - 展示了设备如何充当 ESP-BLE-MESH Provisioner 以配网设备。Provisioner 拥有 Configuration Server model、Configuration Client model 和 Generic OnOff Client model, 示例请见 [example code](#)。
- **快速配网 - Client 和 Server** - 该示例用于演示快速配网。配网 100 个设备费时不超过 60 秒, 示例请见: [example client code](#) 和 [example server code](#)。
- **Wi-Fi 和 BLE-Mesh 共存** - 该示例用于演示 Wi-Fi 和 ESP-BLE-MESH 共存的功能。简而言之, 用户可在运行 ESP-BLE-MESH 时使用 Wi-Fi, 示例请见 [example code](#)。
- **远程配网 (v1.1 新增) - Client, Server and device** - 该示例用于演示 mesh 协议 v1.1 中新增的远程配网功能, 示例请见: [example client code](#), [example server code](#) and [example device code](#)。
- **定向转发 (v1.1 新增) - Client and Server** - 该示例用于演示 mesh 协议 v1.1 中新增的定向转发功能。只有路径上的节点才会对定向消息进行转发, 而其他节点不参与转发, 示例请见 [example client code](#) and [example server code](#)。

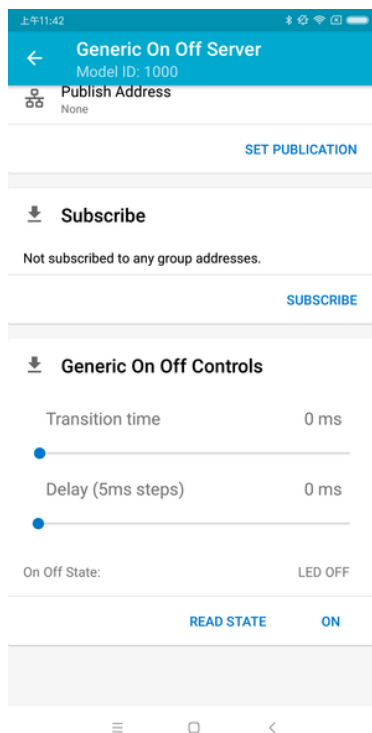
### 4.13.3 ESP-BLE-MESH 演示视频

- Espressif Fast Provisioning using ESP-BLE-MESH App
- Espressif ESP-BLE-MESH and Wi-Fi Coexistence

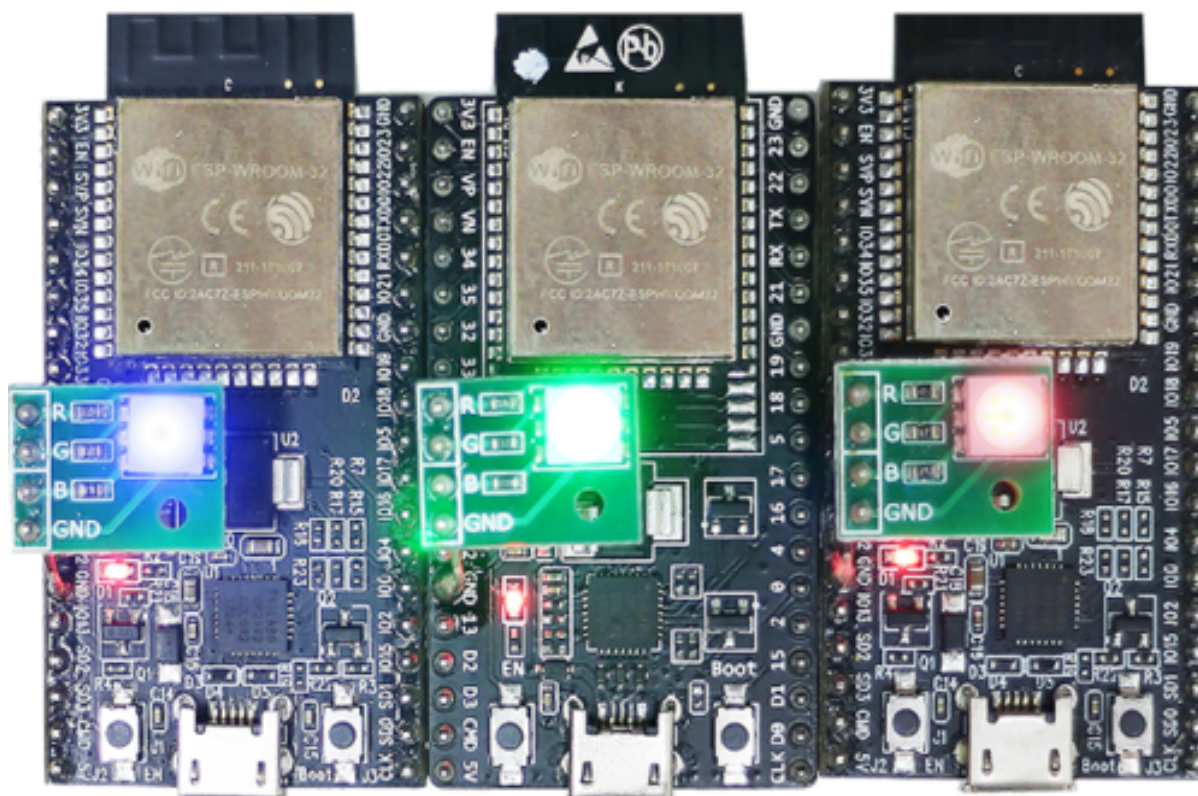
### 4.13.4 ESP-BLE-MESH 常见问题手册

1. Provisioner 开发
2. 节点开发
3. ESP-BLE-MESH 和 Wi-Fi 共存
4. 快速配网
5. Log 帮助
6. 示例帮助
7. 其他

## 4.13.5 相关文档

### ESP-BLE-MESH Feature List

#### Supported Features

##### Mesh Core

- **Provisioning:**
  - PB-ADV, PB-GATT and PB-Remote
  - OOB Authentication
  - Certificate-based Provisioning
  - Remote Provisioning
  - Enhanced Provisioning Authentication
- **Networking**
  - Relay
  - Segmentation and Reassembly
  - Key Refresh Procedure
  - IV Update Procedure
  - Friend
  - Low Power
  - Proxy Server
  - Proxy Client
  - Directed Forwarding
  - Private Beacon
  - Subnet Bridge
  - Minor Enhancements
- **Multiple Client Models Run Simultaneously**
  - Support multiple client models send packets to different nodes simultaneously
  - No blocking between client model and server model
- **NVS Storing**
  - Store provisioning and configuration information of ESP-BLE-MESH Node

##### Mesh Models

- **Foundation models**
  - Configuration Server model
  - Configuration Client model
  - Health Server model
  - Health Client model
  - Remote Provisioning Server model
  - Remote Provisioning Client model
  - Directed Forwarding Configuration Server model
  - Directed Forwarding Configuration Client model
  - Bridge Configuration Server model
  - Bridge Configuration Client model
  - Mesh Private Beacon Server model
  - Mesh Private Beacon Client model
  - On-Demand Private Proxy Server model
  - On-Demand Private Proxy Client model
  - SAR Configuration Server model
  - SAR Configuration Client model
  - Solicitation PDU RPL Configuration Server model
  - Solicitation PDU RPL Configuration Client model
  - Opcodes Aggregator Server model
  - Opcodes Aggregator Client model
  - Large Composition Data Server model
  - Large Composition Data Client model

- **Generic client models**
  - Generic OnOff Client
  - Generic Level Client
  - Generic Default Transition Time Client
  - Generic Power OnOff Client
  - Generic Power Level Client
  - Generic Battery Client
  - Generic Location Client
  - Generic Property Client
- **Sensor client models**
  - Sensor Client
- **Time and Scenes client models**
  - Time Client
  - Scene Client
  - Scheduler Client
- **Lighting client models**
  - Light Lightness Client
  - Light CTL Client
  - Light HSL Client
  - Light xyL Client
  - Light LC Client
- **Generic server models**
  - Generic OnOff Server
  - Generic Level Server
  - Generic Default Transition Time Server
  - Generic Power OnOff Server
  - Generic Power OnOff Setup Server
  - Generic Power Level Server
  - Generic Power Level Setup Server
  - Generic Battery Server
  - Generic Location Server
  - Generic Location Setup Server
  - Generic User Property Server
  - Generic Admin Property Server
  - Generic Manufacturer Property Server
  - Generic Client Property Server
- **Sensor server models**
  - Sensor Server
  - Sensor Setup Server
- **Time and Scenes server models**
  - Time Server
  - Time Setup Server
  - Scene Server
  - Scene Setup Server
  - Scheduler Server
  - Scheduler Setup Server
- **Lighting server models**
  - Light Lightness Server
  - Light Lightness Setup Server
  - Light CTL Server
  - Light CTL Temperature Server
  - Light CTL Setup Server
  - Light HSL Server
  - Light HSL Hue Server
  - Light HSL Saturation Server
  - Light HSL Setup Server
  - Light xyL Server
  - Light xyL Setup Server

- Light LC Server
- Light LC Setup Server

### Mesh Applications

- **ESP-BLE-MESH Node**
  - Tutorial
  - Tutorial
  - Example
- **ESP-BLE-MESH Provisioner**
  - Tutorial
  - Example
- **ESP-BLE-MESH Fast Provisioning**
  - Fast Provisioning Client Model Tutorial
  - Fast Provisioning Server Model Tutorial
  - Example
  - Demo Video
- **ESP-BLE-MESH and Wi-Fi Coexistence**
  - Tutorial
  - Example
  - Demo Video

### Future Release Features

#### Mesh Core

- Provisioner NVS Storage

#### Mesh Applications

- Fast OTA
- Friendship

### ESP-BLE-MESH 架构

本文档将介绍 ESP-BLE-MESH 的架构概览、架构实现和辅助程序。

- ESP-BLE-MESH 架构概览
  - 描述了 ESP-BLE-MESH 架构的 5 大部分及每个部分的功能。
- ESP-BLE-MESH 架构实现
  - 描述了 ESP-BLE-MESH 文件的基本功能、文件与 ESP-BLE-MESH 架构的对应关系及文件间调用的接口。
- ESP-BLE-MESH 辅助程序
  - 描述了 ESP-BLE-MESH 的辅助程序，比如 Mesh 网络管理，Mesh 特性等。

**1. ESP-BLE-MESH 架构概览** 目前，ESP-BLE-MESH 已经实现了 Mesh Profile 的大多数功能及 Mesh Model 规范中定义的所有 Client Model。未支持的功能/模型尚在开发中，会尽快提供。ESP-BLE-MESH 已通过 Bluetooth SIG 蓝牙技术联盟的 [认证](#)。

ESP-BLE-MESH 架构主要由以下 5 大部分组成：

- Mesh 协议栈
  - Mesh Networking 负责 ESP-BLE-MESH 节点的网络消息处理等。
  - Mesh Provisioning 负责 ESP-BLE-MESH 设备的启动配置流程。
  - Mesh Models 负责实现 SIG 定义的模型。



图 22: 图 1.1 ESP-BLE-MESH 架构图



- 网络管理
  - 负责实现网络管理程序，包括节点删除程序、网络索引 (IV Index) 恢复程序等。
- 特性
  - 包括 ESP-BLE-MESH 特性，如低功耗特性、好友特性、中继特性等。
- Mesh 承载层
  - 包括广播承载层和 GATT 承载层。承载层对于 ESP-BLE-MESH 协议栈至关重要，因为协议栈基于蓝牙低功耗技术构建而成，其必须利用承载层通过 BLE 广播通道和连接通道进行数据传输。
- 应用程序
  - 基于 ESP-BLE-MESH 协议栈和 Mesh Models。
  - 通过调用 API 和处理事件，Applications 实现了与 ESP-BLE-MESH 协议栈中的 Mesh Networking 和 Mesh Provisioning 的交互，也实现了与 Mesh Models 中一系列模型的交互。

## 1.1 Mesh 协议栈

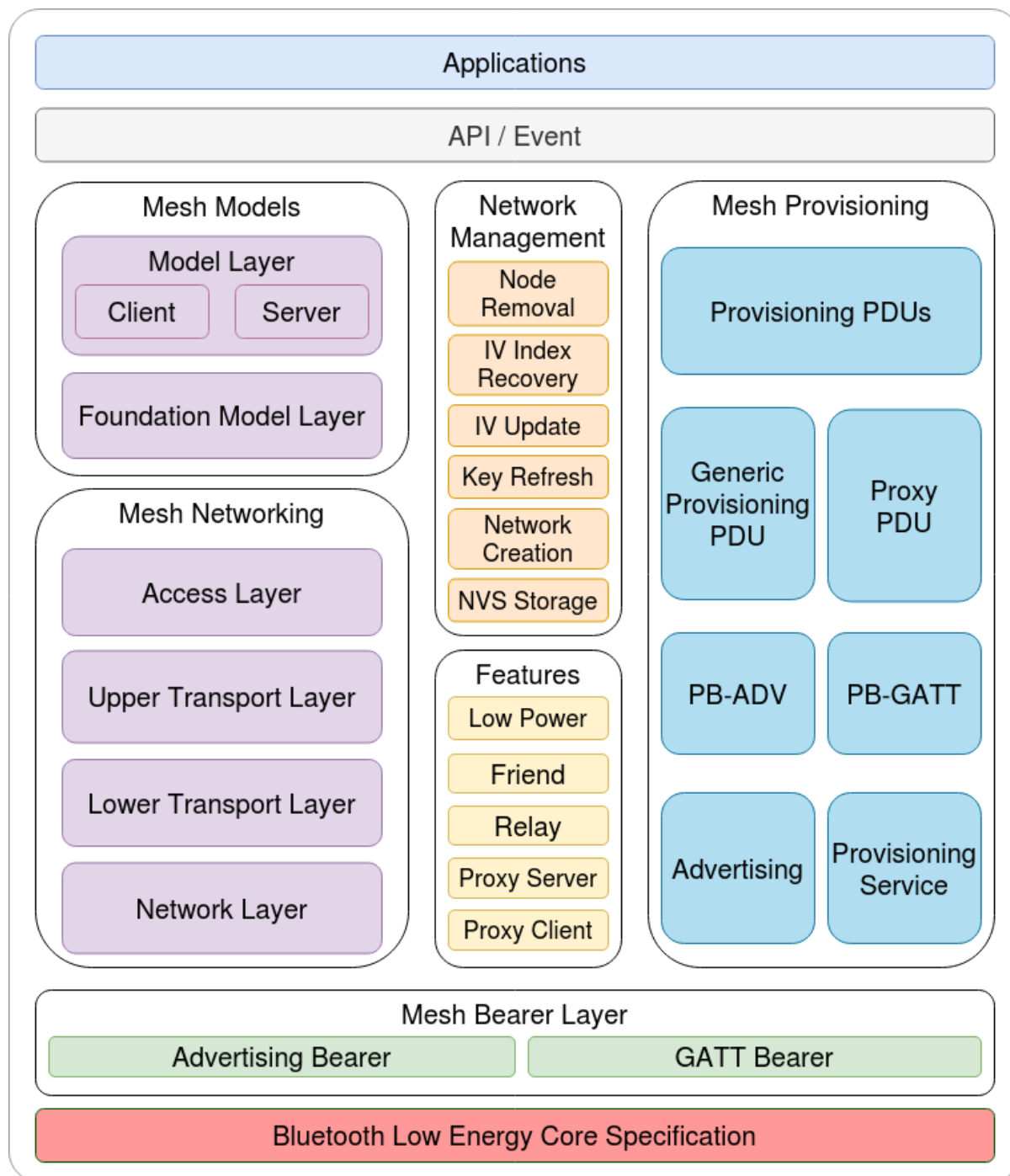
**1.1.1 Mesh Networking** 协议栈架构中的 Mesh Networking 实现了如下功能：

- Mesh 网络中节点间的通讯。
- Mesh 网络中消息的加解密。
- Mesh 网络资源的管理，如网络密钥 (NetKey)、网络索引等。
- Mesh 网络消息的分包与重组。
- 消息在不同模型间的模型映射。
- 更多功能，请参见 [ESP-BLE-MESH Feature List](#)。

Mesh Networking 功能的实现是基于层级结构的。每一层的功能如表 1.1 所示：

表 3: 表 1.1 Mesh Networking 框架描述

层级	功能
接入层	接入层定义应用程序数据的格式，还对上层传输层对数据包的加密和解密进行定义和控制。
上层传输层	上层传输层对接入层进出的应用数据进行加密、解密和认证，同时也处理被称为“传输控制消息”的特殊消息，这种消息包括了与“友谊”和心跳包相关的消息。
底层传输层	底层传输层处理 PDU 的分包和重组。
网络层	网络层定义网络消息的地址类型和格式，实现设备的中继功能。

**1.1.2 Mesh Provisioning** 协议栈架构中的 Mesh Provisioning 实现了如下功能：

- 对未配网设备的配网。
- Mesh 网络资源的分配（单播地址、网络索引和网络密钥）。
- 配网期间对 4 种验证方法的支持。
- 更多功能，请参见 [ESP-BLE-MESH Feature List](#)。

Mesh Provisioning 功能的实现是基于层级结构的。每一层的功能如表 1.2 所示：

表 4: 表 1.2 Mesh Provisioning 框架描述

层级	功能
Provisioning PDUs	通过配网协议处理不同层级的 Provisioning PDUs。
Generic Provisioning PDU/Proxy PDU	使用 Generic Provisioning 层或代理协议层将 Provisioning PDU 传输到未配网的设备。
PB-ADV/PB-GATT	这些层级定义了 Provisioning PDUs 作为可分包和重组的消息进行传输的方式。
Advertising/Provisioning Service	Provisioning bearer 定义了会话建立的方式，该方式用来将 Generic Provisioning 层的传输包传送到设备。

**1.1.3 Mesh Models** 协议栈架构中的 Mesh Models 实现了如下功能：

- Configuration Client/Server Models
- Health Client/Server Models
- Generic Client/Server Models
- Sensor Client/Server Models
- Time and Scenes Client/Server Models
- Lighting Client/Server Models

每一层的功能如表 1.3 所示：

表 5: 表 1.3 Mesh Models 框架描述

层级	功能
模型层	模型层实现用于标准化典型用户场景操作的模型，包括 Generic Client/Server Models、Sensor Client/Server Models、Time and Scenes Client/Server Models、Lighting Client/Server Models 和若干自定义模型。
基础模型层	基础模型层实现与 ESP-BLE-MESH 网络配置、管理和自我诊断等相关的模型。

**1.2 Mesh 网络管理** 网络管理实现了如下功能：

- 节点移除程序：用于将节点从网络中移除。
- 网络索引恢复程序：用于恢复节点的网络索引。
- 网络索引更新程序：用于更新节点的网络索引。
- 密钥更新程序：用于更新节点的网络密钥、应用密钥 (AppKey) 等。
- 网络创建程序：用于创建 mesh 网络。
- NVS 存储器：用于存储节点的网络信息。

**1.3 Mesh 特性** 特性包括以下几项：

- 低功耗特性：用于降低节点的能耗。
- 好友特性：用于为低功耗节点存储消息。
- 中继特性：用于中继/转发节点通过广播承载层收到的网络 PDU。
- Proxy Server/Client 是代理协议中的两个节点角色，其使节点可以通过面向连接的承载层收发 Network PDUs、mesh beacons、代理配置消息和 Provisioning PDU。

**1.4 Mesh 承载层** 协议栈框架中的 承载层负责 ESP-BLE-MESH 协议栈和低功耗蓝牙核心协议间的数据传输。

承载层可视为是基于蓝牙低功耗核心协议的载体层，其实现了 ESP-BLE-MESH 协议栈数据的接收和传输。

表 6: 表 1.3 Mesh 承载层描述

层级	功能
GATT 承载层	GATT 承载层使用代理协议通过 GATT 连接在两个设备之间发送和接收 Proxy PDUs。
广播承载层	使用广播承载层时，必须使用低功耗蓝牙广播通道来发送 mesh 数据包，数据包中的 AD Type 需要设置为 mesh 数据包的类型。

**1.5 Mesh 应用层** 协议栈框架图中的 应用层通过调用 ESP-BLE-MESH 协议栈提供的 API 并处理协议栈上报的事件来实现相应的功能，有一些常见应用，比如网关、照明等。

应用层和 API / 事件之间的交互

- 应用层调用 API
  - 调用配网相关的 API 进行配网。
  - 调用模型相关的 API 发送消息。
  - 调用设备属性相关的 API 获取设备的本地信息。



- 应用层处理事件  
应用层的设计基于事件设计，事件将参数传输给应用层。事件主要分为两大类。
  - 调用 API 完成的事件。
    - \* 比如接收消息的节点。
  - 协议栈主动上报给应用层的事件。
    - \* 协议栈主动上报的事件。
    - \* 模型主动上报的事件。
- 事件通过应用层注册的回调函数进行上报，同时回调函数中也会包含对事件的相应处理。

#### API / 事件与 ESP-BLE-MESH 协议栈的交互

- 用户使用的 API 主要调用 Mesh Networking、Mesh Provisioning 和 Mesh Models 提供的函数。
- API / 事件和协议栈的交互不会跨越协议栈的层级进行操作。比如 API 不会调用 Network Layer 相关的函数。

**2. ESP-BLE-MESH 架构实现** ESP-BLE-MESH 架构的设计和实现是基于层级和模块的。具体而言，第 2.1 节（Mesh 网络的实现），第 2.2 节（Mesh 配网实现）和第 2.3 节（Mesh 层级实现）基于层级思想，第 2.4 节（网格模型的实现）基于模块思想。

- **层级思想:** 基于层级思想，网络架构根据 Mesh Profile Specification 中指定的层级设计而成。每层都有独特的文件，文件包括该层的 API 等。具体设计如图 2.1 所示。
- **模块思想:** 每个文件实现一个独立的功能，供其它程序调用。

ESP-BLE-MESH 架构采用分层的方式进行设计，数据包的处理所经过的层级顺序是固定的，也就是数据包的处理过程会形成一个消息流。因此，我们可以从图 2.1 的协议栈接口图中看到消息流。

### 2.1 Mesh 协议栈的实现

**2.1.1 Mesh Networking 实现** Mesh Networking 中的文件列表和每个文件实现的功能如表 2.1 所示：

表 7: 表 2.1 Mesh Networking 文件描述

文件	功能
<a href="#">access.c</a>	ESP-BLE-MESH 接入层
<a href="#">transport.c</a>	ESP-BLE-MESH 底层/上层传输层
<a href="#">net.c</a>	ESP-BLE-MESH 网络层
<a href="#">adv.c</a>	用于发送 ESP-BLE-MESH 广播包的任务，一个用于处理收到的广播包的回调以及用于分配 adv 缓冲区的 API

**2.1.2 Mesh Provisioning 实现** 由于 Node/Provisioner 共存的限制，Mesh Provisioning 的实现分为两大模块。实现 Node 启动配置的特定文件如表 2.2 所示：

表 8: 表 2.2 Mesh Provisioning（节点）文件描述

文件	功能
<a href="#">prov_node.c</a>	ESP-BLE-MESH 节点配网 (PB-ADV & PB-GATT)
<a href="#">proxy_server.c</a>	ESP-BLE-MESH 节点代理服务器相关功能
<a href="#">beacon.c</a>	用于处理 ESP-BLE-MESH Beacon 的 API

实现 Provisioner 配置功能的特定文件如表 2.3 所示：

表 9: 表 2.3 Mesh Provisioning (Provisioner) 文件描述

文件	功能
<a href="#">prov_pvr.c</a>	ESP-BLE-MESH Provisioner 配置入网 (PB-ADV & PB-GATT)
<a href="#">proxy_client.c</a>	ESP-BLE-MESH 代理客户端相关功能
<a href="#">pvr_mgmt.c</a>	ESP-BLE-MESH Provisioner 网络相关功能



图 23: 图 2.1 ESP-BLE-MESH 架构实现图

**2.1.3 Mesh Models 实现** Mesh Models 用于实现节点中所包含的模型的具体功能。服务器模型主要用于维护节点状态。客户端模型主要用于获取和修改节点状态。

表 10: Table 2.4 Mesh Models 文件描述

文件	功能
cfg_cli.c	发送 Configuration Client 消息, 接收相应应答消息
cfg_srv.c	接收 Configuration Client 消息, 发送适当应答消息
health_cli.c	发送 Health Client 消息, 接收相应应答消息
health_srv.c	接收 Health Client 消息, 发送适当应答消息
client_common.c	ESP-BLE-MESH 模型相关操作
generic_client.c	发送 ESP-BLE-MESH Generic Client 消息, 接收相应应答消息
lighting_client.c	发送 ESP-BLE-MESH Lighting Client 消息, 接收相应应答消息
sensor_client.c	发送 ESP-BLE-MESH Sensor Client 消息, 接收相应应答消息
time_scene_client.c	发送 ESP-BLE-MESH Time Scene Client 消息, 接收相应应答消息
generic_server.c	发送 ESP-BLE-MESH Generic Client 消息, 发送相应应答消息
lighting_server.c	接收 ESP-BLE-MESH Lighting Client 消息, 发送相应应答消息
sensor_server.c	接收 ESP-BLE-MESH Sensor Client 消息, 发送相应应答消息
time_scene_server.c	接收 ESP-BLE-MESH Time Scene Client 消息, 发送相应应答消息

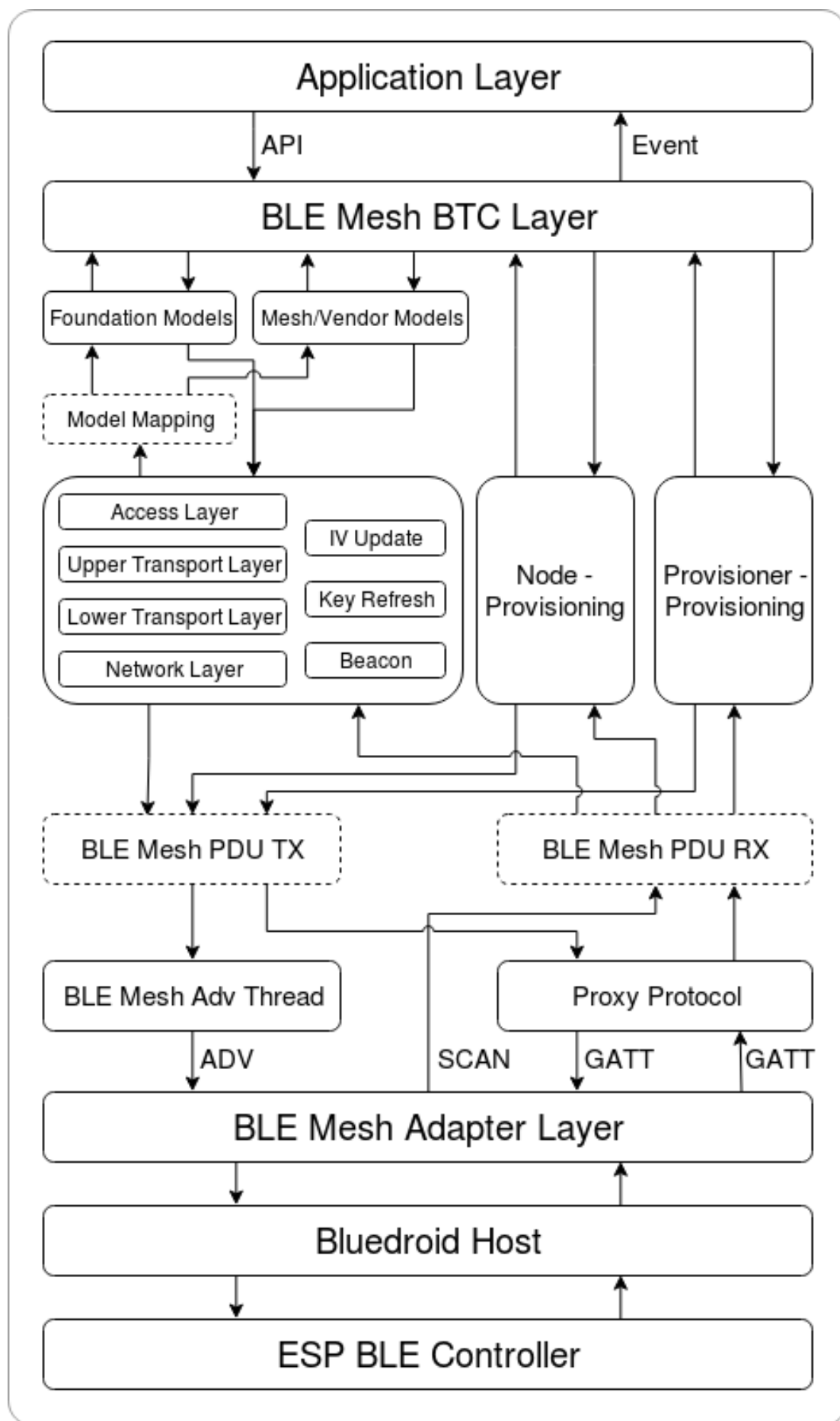
**2.2 Mesh Bearers 实现** Mesh Bearers 在实现时充分考虑了可移植性。当 ESP-BLE-MESH 协议栈需要移植到其它平台时, 用户只需要修改 `adapter.c` 就能移植成功。

表 11: 表 2.5 Mesh Bearers 文件描述

文件	功能
adapter.c	ESP-BLE-MESH 承载层适配文件。此文件提供用于接收和发送 ESP-BLE-MESH ADV 和 GATT 相关数据包的接口。

**备注:** `adapter.c` 是对 Mesh 网络框架中 Advertising Bearer 和 GATT Bearer 的实现。

**2.3 Mesh Applications 实现** 我们提供了一系列用于客户开发的应用示例, 用户可以基于 *ESP-BLE-MESH* 示例 开发产品。

**1. ESP-BLE-MESH 辅助程序** 辅助程序指的是 ESP-BLE-MESH 协议栈中可选的功能。辅助程序的设计通常通过 *CONFIG\_BLE\_MESH* 来实现代码的裁剪。

### 3.1 特性

- 低功耗
- 好友
- 中继
- 代理客户端/代理服务器

### 3.2 网络管理

- 节点移除程序
- 网络索引恢复程序
- 网络索引更新程序
- 秘钥更新程序
- 网络创建程序
- NVS 存储器

### 3.3 辅助程序实现

采用独立模块的设计主要考虑到两个因素：

- 该模块不具备分层实现的条件，其实现可以完全独立，不需要依赖其它模块。
- 模块中的函数会被反复使用到，因此最好设计成独立模块。独立模块如表 3.1 所示：

表 12: 表 3.1 模块文件描述

文件	功能
<a href="#">lpn.c</a>	ESP-BLE-MESH 低功耗功能
<a href="#">friend.c</a>	ESP-BLE-MESH 好友功能
<a href="#">net.c</a>	ESP-BLE-MESH 中继功能、网络创建、网络索引更新程序、网络索引恢复程序、密钥更新程序相关功能
<a href="#">proxy_server.c</a>	ESP-BLE-MESH 代理服务器相关功能
<a href="#">proxy_client.c</a>	ESP-BLE-MESH 代理客户端相关功能
<a href="#">settings.c</a>	ESP-BLE-MESH NVS 存储器功能
<a href="#">main.c</a>	ESP-BLE-MESH 协议栈初始化，协议栈使能，节点移除相关功能

## ESP-BLE-MESH 常见问题手册

本文汇总了 ESP-BLE-MESH 协议栈开发的常见问题及解答，全文分为 7 个章节。

- [1. Provisioner 开发](#)
- [2. 节点开发](#)
- [3. ESP-BLE-MESH 和 Wi-Fi 共存](#)
- [4. 快速配网](#)
- [5. Log 帮助](#)
- [6. 示例帮助](#)
- [7. 其他](#)

用户可以参考这些章节，快速找到问题的答案。该文档会根据各种渠道收集的反馈进行更新。

**1. Provisioner 开发** 通常而言，Provisioner 用于配网未配网设备并形成 mesh 网络。组网后，设备的角色变成节点。

### 1.1 未配网设备加入 ESP-BLE-MESH 网络的流程是什么？

设备通过 Provisioner 加入 ESP-BLE-MESH 网络分为两个阶段，配网阶段和配置阶段。

- 配网阶段：为设备分配单播地址、添加网络密钥 (NetKey) 等。通过配网，设备加入 ESP-BLE-MESH 网络，身份从未配网设备变为节点。
- 配置阶段：为节点添加应用密钥 (AppKey)，并将应用密钥绑定到相应模型。配置期间，有些选项是可选的，比如为节点添加订阅地址、设置发布地址等。通过配置，该节点实际上可以向 Provisioner 发送消息，也可以接收来自 Provisioner 的消息。

### 1.2 如果 Provisioner 想要改变节点状态，其需满足什么条件？

- 需要有和节点的服务器模型相对应的客户端模型。
- 需要和节点有相同的、可用于加密消息的网络密钥和应用密钥。
- 需要知道节点的地址，可以是单播地址，也可以是订阅地址。

### 1.3 如何使用网络密钥和应用密钥？

- 网络密钥用于加密网络层的消息。具有相同网络密钥的节点视作在同一网络中，具有不同网络密钥的节点相互之间不能进行通信。
- 应用密钥用于加密上层传输层中的消息。如果服务器模型和客户端模型绑定的应用密钥不同，则无法实现相互通信。

#### 1.4 如何生成网络密钥或应用密钥？是否可以采用固定的网络密钥或应用密钥？

- API `esp_ble_mesh_provisioner_add_local_net_key()` 可以用来添加包含固定值或随机值的网络密钥。
- API `esp_ble_mesh_provisioner_add_local_app_key()` 可以用来添加包含固定值或随机值的应用密钥。

#### 1.5 Provisioner 的单播地址是不是固定的？

`esp_ble_mesh_prov_t` 中 `prov_unicast_addr` 的值用于设置 Provisioner 的单播地址，只能在初始化期间设置一次，此后不能更改。

#### 1.6 Provisioner 的地址是否可以作为节点上报状态消息的目的地址？

Provisioner 的单播地址只能在初始化期间设置一次，此后不能更改。理论而言，只要节点知道 Provisioner 的单播地址，此地址便可用作节点上报状态消息的目的地址。节点在网络配置的过程中可以知道 Provisioner 的单播地址，因为 Provisioner 往节点发送消息时，消息的源地址就是 Provisioner 的单播地址。

订阅地址也可使用。Provisioner 订阅组地址或者虚拟地址，节点向该订阅地址发送消息。

#### 1.7 被 Provisioner 配网到 ESP-BLE-MESH 网络中的第一个节点的单播地址是不是固定的？

`esp_ble_mesh_prov_t` 中 `prov_start_address` 的值用于设置 Provisioner 配网未配网设备的起始地址，即其首先配网的节点的单播地址。单播地址只能在初始化期间设置一次，此后不能修改。

#### 1.8 手机 App 首先配置的节点的单播地址是不是固定的？

该 App 将确定单播地址，目前大多数单播地址是固定的。

#### 1.9 如何知道当前 Provisioner 正在配网哪个未配网设备？

`esp_ble_mesh_prov_t` 中 `prov_attention` 的值由 Provisioner 在配网过程中设置给未配网设备。该值只能在初始化期间设置一次，此后不能修改。未配网设备加入 mesh 网络后可以用特定的方式来显示自己正在配网，比如灯光闪烁，以告知 Provisioner 其正在配网。

#### 1.10 配网过程中，认证设备共有多少种方法？提供的范例中 provided examples 使用了什么方法？

共有四种设备认证方法，即 No OOB、Static OOB、Output OOB 和 Input OOB。提供的范例使用了 No OOB 的方式。

#### 1.11 配置入网前，未配网设备的广播包可以携带哪些信息？

- Device UUID
- OOB Info
- URL Hash (可选的)

#### 1.12 这些信息可以用于设备识别吗？

是的。每个设备都有独一无二的 Device UUID, 用户可以通过 Device UUID 识别设备。

#### 1.13 当 Provisioner 配网的节点包含多个元素时，单播地址是如何分配的？

- Provisioner 会给设备的主元素分配一个单播地址，其余元素的单播地址在此基础上递增。
- 比如：如果一个未配网设备有三个元素，即主要元素、第二元素和第三元素。配网完成后，节点主元素的单播地址为 0x0002，节点第二元素的单播地址为 0x0003，节点第三元素的单播地址为 0x0004。

### 1.14 Provisioner 如何通过 Configuration Client Model 获取并且解析节点的构成数据？

- Provisioner 可以调用 *Configuration Client Model* API `esp_ble_mesh_config_client_set_state()` 设置参数，调用 `esp_ble_mesh_cfg_client_get_state_t` 中的 `comp_data_get` 获取节点的构成数据。
- 用户可以参考以下代码解析 Composition Data:

```

#include <stdio.h>
#include <string.h>
#include <stdint.h>

//test date: 0C001A0001000800030000010501000000800100001003103F002A00
//0C00 1A00 0100 0800 0300 0001 05 01 0000 0080 0100 0010 0310 3F002A00

// CID is 0x000C
// PID is 0x001A
// VID is 0x0001
// CRPL is 0x0008
// Features is 0x0003 - Relay and Friend features.
// Loc is "front" - 0x0100
// NumS is 5
// NumV is 1
// The Bluetooth SIG Models supported are: 0x0000, 0x8000, 0x0001, 0x1000,
↪ 0x1003
// The Vendor Models supported are: Company Identifier 0x003F and Model
↪ Identifier 0x002A

typedef struct {
    int16_t cid;
    int16_t pid;
    int16_t vid;
    int16_t crpl;
    int16_t features;
    int16_t all_models;
    uint8_t sig_models;
    uint8_t vnd_models;
} esp_ble_mesh_composition_head;

typedef struct {
    uint16_t model_id;
    uint16_t vendor_id;
} tsModel;

typedef struct {
    // reserve space for up to 20 SIG models
    uint16_t SIG_models[20];
    uint8_t numSIGModels;

    // reserve space for up to 4 vendor models
    tsModel Vendor_models[4];
    uint8_t numVendorModels;
} esp_ble_mesh_composition_decode;

int decode_comp_data(esp_ble_mesh_composition_head *head, esp_ble_mesh_
↪composition_decode *data, uint8_t *mystr, int size)
{
    int pos_sig_base;
    int pos_vnd_base;
    int i;

    memcpy(head, mystr, sizeof(*head));

    if(size < sizeof(*head) + head->sig_models * 2 + head->vnd_models *
↪4) {

```

(下页继续)

```

        return -1;
    }

    pos_sig_base = sizeof(*head) - 1;

    for(i = 1; i < head->sig_models * 2; i = i + 2) {
        data->SIG_models[i/2] = mystr[i + pos_sig_base] | (mystr[i + pos_
→sig_base + 1] << 8);
        printf("%d: %4.4x\n", i/2, data->SIG_models[i/2]);
    }

    pos_vnd_base = head->sig_models * 2 + pos_sig_base;

    for(i = 1; i < head->vnd_models * 2; i = i + 2) {
        data->Vendor_models[i/2].model_id = mystr[i + pos_vnd_base] |_
→(mystr[i + pos_vnd_base + 1] << 8);
        printf("%d: %4.4x\n", i/2, data->Vendor_models[i/2].model_id);

        data->Vendor_models[i/2].vendor_id = mystr[i + pos_vnd_base + 2]_
→| (mystr[i + pos_vnd_base + 3] << 8);
        printf("%d: %4.4x\n", i/2, data->Vendor_models[i/2].vendor_id);
    }

    return 0;
}

void app_main(void)
{
    esp_ble_mesh_composition_head head = {0};
    esp_ble_mesh_composition_decode data = {0};
    uint8_t mystr[] = { 0x0C, 0x00, 0x1A, 0x00,
                        0x01, 0x00, 0x08, 0x00,
                        0x03, 0x00, 0x00, 0x01,
                        0x05, 0x01, 0x00, 0x00,
                        0x00, 0x80, 0x01, 0x00,
                        0x00, 0x10, 0x03, 0x10,
                        0x3F, 0x00, 0x2A, 0x00};

    int ret;

    ret = decode_comp_data(&head, &data, mystr, sizeof(mystr));
    if (ret == -1) {
        printf("decode_comp_data error");
    }
}

```

### 1.15 Provisioner 如何通过获取的 Composition Data 进一步配置节点？

Provisioner 通过调用 *Configuration Client Model* API `esp_ble_mesh_config_client_set_state()` 来进行如下配置。

- 正确设置参数 `esp_ble_mesh_cfg_client_set_state_t` 中的 `app_key_add`，将应用密钥添加到节点中。
- 正确设置参数 `esp_ble_mesh_cfg_client_set_state_t` 中的 `model_sub_add`，将订阅地址添加到节点的模型中。
- 正确设置参数 `esp_ble_mesh_cfg_client_set_state_t` 中的 `model_pub_set`，将发布地址添加到节点的模型中。

### 1.16 节点可以自己添加相应的配置吗？

本法可用于特殊情况，如测试阶段。



- 此示例展示了节点如何为自己的模型添加新的组地址。

```

esp_err_t example_add_fast_prov_group_address(uint16_t model_id, uint16_t
↪group_addr)
{
    const esp_ble_mesh_comp_t *comp = NULL;
    esp_ble_mesh_elem_t *element = NULL;
    esp_ble_mesh_model_t *model = NULL;
    int i, j;

    if (!ESP_BLE_MESH_ADDR_IS_GROUP(group_addr)) {
        return ESP_ERR_INVALID_ARG;
    }

    comp = esp_ble_mesh_get_composition_data();
    if (!comp) {
        return ESP_FAIL;
    }

    for (i = 0; i < comp->element_count; i++) {
        element = &comp->elements[i];
        model = esp_ble_mesh_find_sig_model(element, model_id);
        if (!model) {
            continue;
        }
        for (j = 0; j < ARRAY_SIZE(model->groups); j++) {
            if (model->groups[j] == group_addr) {
                break;
            }
        }
        if (j != ARRAY_SIZE(model->groups)) {
            ESP_LOGW(TAG, "%s: Group address already exists, element_
↪index: %d", __func__, i);
            continue;
        }
        for (j = 0; j < ARRAY_SIZE(model->groups); j++) {
            if (model->groups[j] == ESP_BLE_MESH_ADDR_UNASSIGNED) {
                model->groups[j] = group_addr;
                break;
            }
        }
        if (j == ARRAY_SIZE(model->groups)) {
            ESP_LOGE(TAG, "%s: Model is full of group addresses, element_
↪index: %d", __func__, i);
        }
    }

    return ESP_OK;
}

```

**备注：**使能了节点的 NVS 存储器后，通过该方式添加的组地址以及绑定的应用密钥在设备掉电的情况下不能保存。这些配置信息只有通过 Configuration Client Model 配置时才会保存。

### 1.17 Provisioner 如何通过分组的方式控制节点？

通常而言，在 ESP-BLE-MESH 网络中实现组控制有两种方法，即组地址方法和虚拟地址方法。假设有 10 个设备，即 5 个带蓝灯的设备 and 5 个带红灯的设备。

- 方案一：5 个蓝灯设备订阅一个组地址，5 个红灯设备订阅另一个组地址。Provisioner 往不同的组地址发送消息，即可实现分组控制设备。



- 方案二：5 个蓝灯设备订阅一个虚拟地址，5 个红灯设备订阅另一个虚拟地址，Provisioner 往不同的虚拟地址发送消息，即可实现分组控制设备。

### 1.18 Provisioner 如何将节点添加至多个子网？

节点配置期间，Provisioner 可以为节点添加多个网络密钥，拥有相同网络密钥的节点属于同一子网。Provisioner 可以通过不同的网络密钥与不同子网内的节点进行通信。

### 1.19 Provisioner 如何知道网络中的某个设备是否离线？

节点离线通常定义为：电源故障或其他原因导致的节点无法与 mesh 网络中的其他节点正常通信的情况。

ESP-BLE-MESH 网络中的节点间彼此不连接，它们通过广播通道进行通信。

此示例展示了如何通过 Provisioner 检测节点是否离线。

- 节点定期给 Provisioner 发送心跳包。如果 Provisioner 超过一定的时间未接收到心跳包，则视该节点离线。

---

**备注：**心跳包的设计应该采用单包（字节数小于 11 个字节）的方式，这样收发效率会更高。

---

### 1.20 Provisioner 删除网络中的节点时，需要进行哪些操作？

通常而言，Provisioner 从网络中移除节点主要涉及三个步骤：

- 首先，Provisioner 将需要移除的节点添加至“黑名单”。
- 其次，Provisioner 启动**密钥更新程序**。
- 最后，节点执行节点重置程序，切换自身身份为未配网设备。

### 1.21 在密钥更新的过程中，Provisioner 如何更新节点的网络密钥？

- 通过正确设置参数 `esp_ble_mesh_cfg_client_set_state_t` 中的 `net_key_update`，使用 *Configuration Client Model* API `esp_ble_mesh_config_client_set_state()`，Provisioner 更新节点的网络密钥。
- 通过正确设置参数 `esp_ble_mesh_cfg_client_set_state_t` 中的 `app_key_update`，使用 *Configuration Client Model* API `esp_ble_mesh_config_client_set_state()`，Provisioner 更新节点的应用密钥。

### 1.22 Provisioner 如何管理 mesh 网络中的节点？

ESP-BLE-MESH 在示例中实现了一些基本的节点管理功能，比如 `esp_ble_mesh_store_node_info()`。ESP-BLE-MESH 还提供可用于设置节点本地名称的 API `esp_ble_mesh_provisioner_set_node_name()` 和可用于获取节点本地名称的 API `esp_ble_mesh_provisioner_get_node_name()`。

### 1.23 Provisioner 想要控制节点的服务器模型时需要什么？

Provisioner 在控制节点的服务器模型前，必须包括相应的客户端模型。

Provisioner 应当添加本地的网络密钥和应用密钥。

- Provisioner 调用 API `esp_ble_mesh_provisioner_add_local_net_key()` 以添加网络密钥。
- Provisioner 调用 API `esp_ble_mesh_provisioner_add_local_app_key()` 以添加应用密钥。

Provisioner 应当配置自己的客户端模型。

- Provisioner 调用 API `esp_ble_mesh_provisioner_bind_app_key_to_local_model()` 以绑定应用密钥至自己的客户端模型。

## 1.24 Provisioner 如何控制节点的服务器模型？

ESP-BLE-MESH 支持所有 SIG 定义的客户端模型。Provisioner 可以使用这些客户端模型控制节点的服务器模型。客户端模型分为 6 类，每类有相应的功能。

- Configuration Client Model
  - API `esp_ble_mesh_config_client_get_state()` 可用于获取 Configuration Server Model 的 `esp_ble_mesh_cfg_client_get_state_t` 值。
  - API `esp_ble_mesh_config_client_set_state()` 可用于设置 Configuration Server Model 的 `esp_ble_mesh_cfg_client_set_state_t` 值。
- Health Client Model
  - API `esp_ble_mesh_health_client_get_state()` 可用于获取 Health Server Model 的 `esp_ble_mesh_health_client_get_state_t` 值。
  - API `esp_ble_mesh_health_client_set_state()` 可用于设置 Health Server Model 的 `esp_ble_mesh_health_client_set_state_t` 值。
- Generic Client Models
  - API `esp_ble_mesh_generic_client_get_state()` 可用于获取 Generic Server Model 的 `esp_ble_mesh_generic_client_get_state_t` 值。
  - API `esp_ble_mesh_generic_client_set_state()` 可用于设置 Generic Server Model 的 `esp_ble_mesh_generic_client_set_state_t` 值。
- Lighting Client Models
  - API `esp_ble_mesh_light_client_get_state()` 可用于获取 Lighting Server Model 的 `esp_ble_mesh_light_client_get_state_t` 值。
  - API `esp_ble_mesh_light_client_set_state()` 可用于设置 Lighting Server Model 的 `esp_ble_mesh_light_client_set_state_t` 值。
- Sensor Client Models
  - API `esp_ble_mesh_sensor_client_get_state()` 可用于获取 Sensor Server Model 的 `esp_ble_mesh_sensor_client_get_state_t` 值。
  - API `esp_ble_mesh_sensor_client_set_state()` 可用于设置 Sensor Server Model 的 `esp_ble_mesh_sensor_client_set_state_t` 值。
- Time and Scenes Client Models
  - API `esp_ble_mesh_time_scene_client_get_state()` 可用于获取 Time and Scenes Server Model 的 `esp_ble_mesh_time_scene_client_get_state_t` 值。
  - API `esp_ble_mesh_time_scene_client_set_state()` 可用于设置 Time and Scenes Server Model 的 `esp_ble_mesh_time_scene_client_set_state_t` 值。

## 2. 节点开发

### 2.1 节点包含什么样的模型？

- ESP-BLE-MESH 中，节点由一系列的模型组成，每个模型实现节点的某些功能。
- 模型分为两种，客户端模型和服务器模型。客户端模型可以获取并设置服务器模型的状态。
- 模型也可以分为 SIG 模型和自定义模型。SIG 模型的所有行为都由官方定义，而自定义模型的行为均由用户定义。

### 2.2 每个模型对应的消息格式是不是固定的？

- 消息由 opcode 和 payload 组成，通过 opcode 进行区分。
- 与模型对应的消息的类型和格式都是固定的，这意味着模型之间传输的消息是固定的。

### 2.3 节点的模型可以使用哪些函数发送消息？

- 对于客户端模型，用户可以调用 API `esp_ble_mesh_client_model_send_msg()` 发送消息。
- 对于服务器模型，用户可以调用 API `esp_ble_mesh_server_model_send_msg()` 发送消息。
- 对于发布，用户可以调用 API `esp_ble_mesh_model_publish()` 发布消息。

### 2.4 如何实现消息传输不丢包？

如果用户要实现消息传输不丢包，则需有应答的消息。等待应答的默认时间在 `CONFIG_BLE_MESH_CLIENT_MSG_TIMEOUT` 中设置。如果发送端等待应答超时，就会触发对应的超时事件。

---

**备注：** API `esp_ble_mesh_client_model_send_msg()` 中可以设置应答的超时时间。如果参数 `msg_timeout` 设为 **0**，那么超时时间便会采用默认值（4 秒）。

---

### 2.5 如何发送无应答的消息？

对于客户端模型，用户可以调用 API `esp_ble_mesh_client_model_send_msg()` with the parameter `need_rsp` set to `false` 发送无应答消息。

对于服务器模型，调用 API `esp_ble_mesh_server_model_send_msg()` 发送的消息总是无应答的消息。

### 2.6 如何为模型添加订阅地址？

通过 Configuration Client Model 添加订阅地址。

### 2.7 模型发送的消息和发布的消息有何不同？

调用 API `esp_ble_mesh_client_model_send_msg()` 或 `esp_ble_mesh_server_model_send_msg()` 发送的消息会在 Network Transmit 状态规定的期限内发送。

调用 API `esp_ble_mesh_model_publish()` 发布的消息将由模型发布状态决定是否发布。消息的发布一般是周期性的，或者有固定次数。发布周期和发布次数由模型发布状态控制，并且可以通过 Configuration Client Model 进行配置。

### 2.8 发送不分包消息时，最多可携带多少有效字节？

不分包消息的总有效载荷长度（可由用户设置）为 11 个八位位组，因此，如果消息的 opcode 为 2 个八位位组，则该消息可以携带 9 个八位位组的有效信息。对于 vendor 消息，由于 opcode 是 3 个八位位组，剩余的有效负载长度为 8 个八位位组。

### 2.9 什么时候应该使能节点的 Relay 功能？

如果 mesh 网络中检测到的节点很稀疏，用户可以使能节点的 Relay 功能。

如果 mesh 网络中检测到的节点很密集，用户可以选择仅使能一些节点的 Relay 功能。

如果 mesh 网络大小未知，用户可以默认使能 Relay 功能。

### 2.10 什么时候应该使能节点的 Proxy 功能？

如果未配网设备将由电话配网，则未配网设备应该使能 Proxy 功能，因为当前几乎所有电话都不支持通过广播承载层发送 ESP-BLE-MESH 数据包。并且，未配网设备成功配网成为 Proxy 节点后，其会通过 GATT 承载层和广播承载层与 mesh 网络中的其他节点通信。

### 2.11 如何使用代理过滤器？

代理过滤器用于减少 Proxy Client（如手机）和 Proxy Server（如节点）之间交换的 Network PDU 的数量。另外，通过代理过滤器，Proxy Client 可以明确请求仅接收来自 Proxy Server 的某些目标地址的 mesh 消息。

### 2.12 Relay 节点什么时候可以中继消息？

如果要中继消息，消息需满足以下要求。

- 消息存在于 mesh 网络中。
- 消息的目的地址不是节点的单播地址。
- 消息的 TTL 值需大于 1。

### 2.13 如果一条消息分成几段，那么其他 Relay 节点是接收到一段消息就中继还是等接收到完整的数据包才中继？

Relay 节点收到其中一段消息时就中继，而非一直等到接收所有的消息。

### 2.14 使用 Low Power 功能降低功耗的原理是什么？

- 开启无线电进行收听时，设备消耗能量。使能节点的低功耗功能后，它将在大多数时间内关闭无线电功能。
- 低功耗节点和好友节点需要合作，因此低功耗节点可以以适当或较低的频率接收消息，而无需一直收听。
- 当低功耗节点有一些新消息时，好友节点将为其存储消息。低功耗节点可以间隔固定时间轮询好友节点，以查看是否有新的消息。

### 2.15 设备断电后上电，如何能继续在网络中进行通讯？

在 `menuconfig` 中启用配置 Store BLE Mesh Node configuration persistently。

### 2.16 如何实现将节点自检的信息发送出来？

推荐节点通过 Health Server Model 定期发布其自检结果。

### 2.17 节点间如何传输消息？

节点间传输信息的可能应用场景是，一旦烟雾警报检测到高浓度的烟雾，就会触发喷淋设备。有两种实现方法。

- 方法 1：喷淋设备订阅组地址。当烟雾警报器检测到高浓度的烟雾时，它会发布一条消息，该消息的目标地址是喷淋设备已订阅的组地址。
- 方法 2：Provisioner 可以配置喷淋设备的单播地址为烟雾报警器的地址。当检测到高浓度的烟雾时，烟雾警报器以喷淋设备的单播地址为目标地址，将消息发送到喷淋设备。

### 2.18 设备通信必须要网关吗？

- 情况 1：节点仅在 mesh 网络内通信。这种情况下，不需要网关。ESP-BLE-MESH 网络是一个泛洪的网络，网络中的消息没有固定的路径，节点与节点之间可以随意通信。
- 情况 2：如果用户想要远程控制网络，比如在到家之前打开某些节点，则需要网关。

### 2.19 何时使用 IV Update 更新程序？

一旦节点的底层检测到发送的消息的序列号达到临界值，IV Update 更新程序便会启用。

## 2.20 如何启用 IV Update 更新程序？

节点可以使用带有 Secure Network Beacon 的 IV Update 更新程序。

## 3. ESP-BLE-MESH 和 Wi-Fi 共存

### 3.1 Wi-Fi 和 ESP-BLE-MESH 共存时，支持哪些模式？

目前，只有 Wi-Fi STA 模式支持共存。

### 3.2 Wi-Fi 和 ESP-BLE-MESH 共存时，为什么 Wi-Fi 吞吐量很低？

应使能 menuconfig 中的一些配置来支持 PSRAM。

- ESP32-H2-specific > Support for external, SPI-connected RAM > Try to allocate memories of Wi-Fi and LWIP...
- Bluetooth > Bluedroid Enable > BT/BLE will first malloc the memory from the PSRAM
- Bluetooth > Bluedroid Enable > Use dynamic memory allocation in BT/BLE stack
- Bluetooth > Bluetooth controller > BLE full scan feature supported
- Wi-Fi > Software controls Wi-Fi/Bluetooth coexistence > Wi-Fi

## 4. 快速配网

### 4.1 为什么需要快速配网？

通常而言，存在少量未配网设备时，用户可以逐个配置。但是如果有大量未配网设备（比如 100 个）时，逐个配置会耗费大量时间。通过快速配网，用户可以在约 50 秒内配网 100 个未配网设备。

### 4.2 为什么会出现 EspBleMesh App 在快速配网期间长时间等待的情况？

快速配网期间，代理节点在配置完一个节点后会断开与 APP 的连接，待所有节点配网完成后，再与 APP 重新建立连接。

### 4.3 为什么 APP 中显示的节点地址的数量比现有的节点地址更多？

每完成一次快速配网后、开始新一次快速配网前，APP 会存有上次配网的数据，因此 APP 中显示的节点地址的数量比现有的节点地址更多。

### 4.4 在 EspBleMesh App 中输入的 count 值有什么用途？

此 count 值提供给 App 配置的代理节点，以决定何时提前开始 Proxy 广播信息。

### 4.5 运行以下示例 fast\_prov\_server 的节点的 Configuration Client Model 何时开始工作？

使能了 Temporary Provisioner 功能后，Configuration Client Model 会开始工作。

### 4.6 Temporary Provisioner 功能会一直处于使能的状态吗？

节点收到打开/关闭电灯的消息后，所有节点会禁用其 Temporary Provisioner 功能并且转化为一般节点。

**5. Log 帮助** 当 ESP-BLE-MESH 协议栈底层出现错误或者警告时，可以在这儿找到这些错误和警告的含义。



### 5.1 ran out of retransmit attempts 代表什么？

节点发送分段消息时，由于某些原因，接收端未收到完整的消息。节点会重传消息。当重传次数达到最大重传数时，会出现该警告，当前最大重传数为 4。

### 5.2 Duplicate found in Network Message Cache 代表什么？

当节点收到一条消息时，它会该消息与网络缓存中存储的消息进行比较。如果在缓存中找到相同的消息，这意味着之前已接受过该消息，则该消息会被丢弃。

### 5.3 Incomplete timer expired 代表什么？

当节点在一定时间段（比如 10 秒）内未收到分段消息的所有段时，则 Incomplete 计时器到时，并且出现该警告。

### 5.4 No matching TX context for ack 代表什么？

当节点收到一个分段 ack 且不能找到任何自己发送的与该 ack 相关的消息时，会出现该警告。

### 5.5 No free slots for new incoming segmented messages 代表什么？

当节点没有空间来接收新的分段消息时，会出现该警告。用户可以通过配置 `CONFIG_BLE_MESH_RX_SEG_MSG_COUNT` 扩大空间。

### 5.6 Model not bound to AppKey 0x0000 代表什么？

当节点发送带有模型的消息且该模型尚未绑定到索引为 0x000 的应用密钥时，会出现该报错。

### 5.7 Busy sending message to DST xxxx 代表什么？

该错误表示节点的客户端模型已将消息发送给目标节点，并且正在等待响应，用户无法将消息发送到单播地址相同的同一节点。接收到相应的响应或计时器到时后，可以发送另一条消息。

## 6. 示例帮助

### 6.1 ESP-BLE-MESH 回调函数如何分类？

- API `esp_ble_mesh_register_prov_callback()` 用于注册处理配网和入网相关事件的回调函数。
- API `esp_ble_mesh_register_config_client_callback()` 用于注册处理 Configuration Client Model 相关事件的回调函数。
- API `esp_ble_mesh_register_config_server_callback()` 用于注册处理 Configuration Server Model 相关事件的回调函数。
- API `esp_ble_mesh_register_health_client_callback()` 用于注册处理 Health Client Model 相关事件的回调函数。
- API `esp_ble_mesh_register_health_server_callback()` 用于注册处理 Health Server Model 相关事件的回调函数。
- API `esp_ble_mesh_register_generic_client_callback()` 用于注册处理 Generic Client Models 相关事件的回调函数。
- API `esp_ble_mesh_register_light_client_callback()` 用于注册处理 Lighting Client Models 相关事件的回调函数。
- API `esp_ble_mesh_register_sensor_client_callback()` 用于注册处理 Sensor Client Model 相关事件的回调函数。
- API `esp_ble_mesh_register_time_scene_client_callback()` 用于注册处理 Time and Scenes Client Models 相关事件的回调函数。

- API `esp_ble_mesh_register_custom_model_callback()` 用于注册处理自定义模型和未实现服务器模型的相关事件的回调函数。

## 7. 其他

### 7.1 如何打印数据包？

示例使用如下函数 `ESP_LOG_BUFFER_HEX()` 打印信息语境，而 ESP-BLE-MESH 协议栈使用 `bt_hex()` 打印。

### 7.2 重启 ESP32 应使用哪个 API？

API `esp_restart()`。

### 7.3 如何监测任务栈的剩余空间？

API `vTaskList()` 可以用于定期打印任务栈的剩余空间。

### 7.4 如何在不更改 menuconfig 输出级别的情况下改变 log 级别？

无需使用 menuconfig，可以通过 API `esp_log_level_set()` 修改 log 的输出级别。

## ESP-BLE-MESH Terminology

表 13: 表 1 ESP-BLE-MESH 术语 - 身份

术语	官方定义	详细说明
未配网设备	"A device that is not a member of a mesh network is known as an unprovisioned device."	示例：照明装置、温控设备、制造设备和电动门等。
节点	"A node is a provisioned device."	经配网加入 ESP-BLE-MESH 网络后，未配网设备的身份转变成节点。节点（如照明装置、温控设备、制造设备和电动门）是指能在蓝牙 ESP-BLE-MESH 网络中发送、接收或中继消息的设备，且节点可以选择性地支持一个或多个子网。
中继节点	"A node that supports the Relay feature and has the Relay feature enabled is known as a Relay node."	中继节点接收并中继 ESP-BLE-MESH 消息，因此消息可以传输得更远。用户可以根据节点的状态来决定是否使能节点的中继功能。消息可以中继多次，每次中继为“一跳”，消息最多可有 126 跳，足以让消息在广阔的区域传输。
代理节点	"A node that supports the Proxy feature and has the Proxy feature enabled is known as a Proxy node."	代理节点从一个承载层（通常包括广播承载层和 GATT 承载层）接收消息，并通过另一个承载层重新发送消息。其目的是将只支持 GATT 承载层的通讯设备接入到 ESP-BLE-MESH 网络中。通常而言，手机 App 需要一个代理节点才能接入 Mesh 网络。没有代理节点，手机 App 无法与 Mesh 网络中成员通信。
好友节点	"A node that supports the Friend feature, has the Friend feature enabled, and has a friendship with a node that supports the Low Power feature is known as a Friend node."	好友节点相当于低功耗节点 (LPN) 的备份，可存储发往低功耗节点的消息及安全更新信息；当低功耗节点需要这些存储的信息时，这些信息便会被传输至低功耗节点。低功耗节点必须与支持好友特性的另一节点建立“友谊”，以减少其接收器的占空比，从而降低低功耗节点的功耗。低功耗节点需要找到好友节点，与其建立友谊关系，其中涉及的过程称为“友谊建立”。低功耗节点与好友节点的搭配可让低功耗节点规划对无线电的使用，从而以适当或较低的频率接收消息，无需保持收听状态。低功耗节点会轮询好友节点以查看是否有新的消息。
低功耗节点	"A node that supports the Low Power feature and has a friendship with a node that supports the Friend feature is known as a Low Power node."	低功耗节点通过轮询从好友节点获取信息，比如消息、安全更新等。
启动配置设备 (以下称为 Provisioner)	"A node that is capable of adding a device to a mesh network."	能够配网未配网设备的设备称为启动配置设备。这一流程通常需要通过产品制造商提供的 App 来实现，并可在网关、智能手机、平板电脑和其他载体上使用。



表 14: 表 2 ESP-BLE-MESH 术语 - 节点构成

术语	官方定义	详细说明
状态	"A value representing a condition of an element that is exposed by an element of a node."	ESP-BLE-MESH 网络中的每台设备都具有一组独立的状态值，表示设备的某些状态，比如照明设备的亮度、颜色等状态。更改状态值会修改设备本身的物理状态，比如更改设备的开关状态值实际是在打开或关闭设备。
模型	"A model defines the basic functionality of a node."	一个节点可能包含多个模型，而每个模型定义了节点的基本功能，比如节点所需要的状态、控制状态的消息以及处理消息所产生的动作等。节点功能的实现是基于模型的，模型可分为 SIG 模型和自定义模型，前者由 SIG 定义，而后者由用户定义。
元素	"An addressable entity within a device."	一个节点可以包含一个或多个元素，每个元素都有一个单播地址和一个或多个模型，并且同一元素所包含的模型不可以出现重复。
节点构成状态	"The Composition Data state contains information about a node, the elements it includes, and the supported models."	通过读取节点构成状态的值，用户可以了解节点的基本信息，比如元素的数量及每个元素中的模型。Provisioner 通过获取这个消息对设备进一步配置，比如配置节点的订阅地址与发布地址。

表 15: 表 3 ESP-BLE-MESH 术语 - 特性

术语	官方定义	详细说明
低功耗特性	"The ability to operate within a mesh network at significantly reduced receiver duty cycles only in conjunction with a node supporting the Friend feature."	低功耗功能可降低节点的功耗。当低功耗节点寻找好友节点、且附近有多个好友节点时，它会通过算法选择最适合的好友节点。
好友特性	"The ability to help a node supporting the Low Power feature to operate by storing messages destined for those nodes."	通过使能好友特性，节点可以帮助存储低功耗节点的信息。使能了好友特性的节点可能会产生更大的功耗和内存消耗。
中继特性	"The ability to receive and retransmit mesh messages over the advertising bearer to enable larger networks."	中继特性能让 ESP-BLE-MESH 的消息在节点之间实现多次跳跃，传输距离可超过两个节点之间直接进行无线电传输的范围，从而覆盖整个网络。使能了中继特性的节点中继消息时，只中继其所在子网的消息，不中继其它子网的消息。使能了中继特性的节点中继分段消息时不考虑数据的完整性。节点每收到一条分段消息便直接中继，不会等待收到完整的消息。
代理特性	"The ability to receive and retransmit mesh messages between GATT and advertising bearers."	代理特性的目的是允许不具备广播承载层的节点访问 ESP-BLE-MESH 网络。代理特性通常为需要和手机 App 连接的节点所用。

表 16: 表 4 ESP-BLE-MESH 术语 - 配置入网

术语	官方定义	详细说明
PB-ADV	"PB-ADV is a provisioning bearer used to provision a device using Generic Provisioning PDUs over the advertising channels."	PB-ADV 通过广播通道传输配网过程中产生的数据包。只有 Provisioner 和未配网设备都支持 PB-ADV 时才可使用这种方法进行配网。
PB-GATT	"PB-GATT is a provisioning bearer used to provision a device using Proxy PDUs to encapsulate Provisioning PDUs within the Mesh Provisioning Service."	PB-GATT 通过连接通道传输配网过程中产生的数据包。如果未配网设备想使用此方式进行配网，其需要实现相关的 Mesh Provisioning Service。未实现此服务的未配网设备不能通过 PB-GATT 承载层配网接入 mesh 网络。
PB-Remote	"The PB-Remote provisioning bearer uses the existing mesh network to provision an unprovisioned device that is not within immediate radio range of the Provisioner."	PB-Remote 是一种使用现有的网状网络来为无法与配网器直接通信的未配网设备进行配网的配网承载方式。
配置入网	"Provisioning is a process of adding an unprovisioned device to a mesh network, managed by a Provisioner."	经过配网，“未配网设备”的身份转变为“节点”，成为 ESP-BLE-MESH 网络中的一员。
认证方式	"Authentication is a step during the provisioning of nodes."	未配网设备有四种认证方法：输入带外 (Input OOB)、输出带外 (Output OOB)、静态带外 (Static OOB) 和无带外 (No OOB)。
输入带外 (Input OOB)	Input Out-of-Band	比如，Provisioner 生成并显示随机数，然后提示用户采取适当操作将随机数输入未配网的设备中。以照明开关为例，用户可以在一定时间内数次按下按钮，以这种形式输入 Provisioner 端显示的随机数。输入带外认证方法与输出带外的认证方法类似，但设备的角色相反。
输出带外 (Output OOB)	Output Out-of-Band	比如，未配网设备会选择一个随机数，并通过与其功能兼容的方式输出该数字。如果未配网设备是一个灯泡，则其能够闪烁指定的次数。如果未配网设备有 LCD 屏幕，则可以将随机数显示为多位数值。启动 Provisioner 的用户需要输入观察到的数字，来认证未配网的设备。
静态带外 (Static OOB)	Static Out-of-Band	静态 OOB 的认证方法：使用静态 OOB 信息。如果需要无 OOB 信息，请将静态 OOB 字段赋值为 0。如果需要 OOB 信息，请使用静态 OOB 信息认证正在配网的设备。
无带外 (No OOB)	No Out-of-Band	无 OOB 的认证方法：将“静态 OOB”字段赋值为 0。采用这种方式相当于不认证未配网的设备。
基于证书的配网 (Certificate-based Provisioning)	Certificate-based Out-of-Band	基于证书的配网功能利用公钥基础设施来验证未配网设备的公钥和 UUID 信息。

表 17: 表 5 ESP-BLE-MESH 术语 - 地址

术语	官方定义	详细说明
未分配地址	"This is a special address type, with a value of 0x0000. Its use indicates that an Element has not yet been configured or had a Unicast Address assigned to it."	未配置的元素地址或未分配的元素地址都称为未分配地址。鉴于这些元素没有固定的地址，它们不会用于消息的传输。建议在设置用户代码的地址之前，将该地址的值设为未分配地址。
单播地址	"A unicast address is a unique address allocated to each element."	在配网期间，Provisioner 会给网络中处于生命周期内节点的每个元素分配一个单播地址。单播地址可能会出现在消息的源/目标地址字段中。发送到单播地址的消息只能由拥有该单播地址的元素进行处理。
虚拟地址	"A virtual address represents a set of destination addresses. Each virtual address logically represents a Label UUID, which is a 128-bit value that does not have to be managed centrally."	虚拟地址与特定的 UUID 标签相关联，可以用作模型的发布地址或订阅地址。UUID 标签是与一个或多个节点的元素相关联的 128 位值。虚拟地址的第 15 位和第 14 位分别设置为 1 和 0。从第 13 位到第 0 位设置为散列值（提供 16384 个散列值）。散列是 UUID 标签的派生。使用订阅元素检查完整的 128 位 UUID 十分低效，而散列值提供了一种更有效的方法来确定最终将哪些消息发送到哪些元素。
群组地址	"A group address is an address that is programmed into zero or more elements."	群组地址是 ESP-BLE-MESH 网络中的另一种多播地址，通常用于将节点进行分组。发送到 all-proxies 地址的信息应由启用了代理功能的所有节点的主要元素处理。发送到 all-friends 地址的消息应由启用了好友功能的所有节点的主要元素处理。发送到 all-relays 地址的消息应由启用了中继功能的所有节点的主要元素处理。发送到 all-nodes 地址的消息应由所有节点的主要元素处理。

表 18: 表 6 ESP-BLE-MESH 术语 - 安全

术语	官方定义	详细说明
设备密钥 (DevKey)	”There is also a device key, which is a special application key that is unique to each node, is known only to the node and a Configuration Client, and is used to secure communications between the node and a Configuration Client.”	设备密钥让您能够配网未配网设备、配置节点。设备密钥用来加密配置信息，即配置设备时 Provisioner 和节点之间传输的消息。
应用密钥 (App-Key)	”Application keys are used to secure communications at the upper transport layer.”	应用密钥用于应用数据传递至应用层过程中对应用数据的解密，和应用层下发过程中对数据的加密。网络中的一些节点有特定的用途，并且可以根据应用程序的需求对一些潜在敏感数据的访问进行限制。通过特定的应用密钥，这些节点与特定应用程序相关联。通常而言，使用不同应用密钥的领域有安全（楼宇门禁、机房门禁和 CEO 办公室门禁）、照明（工厂、外部楼宇和人行道）和 HVAC 系统。应用密钥绑定在网络密钥上，这意味着应用密钥仅在绑定网络密钥的情况下使用。每一个应用密钥仅可绑定到一个网络密钥。
泛洪安全资料	”The master security material is derived from the network key (NetKey) and can be used by other nodes in the same network. Messages encrypted with master security material can be decoded by any node in the same network.”	使用好友安全材料加密的相应友谊消息有：1. 好友轮询 (Friend Poll), 2. 好友更新 (Friend Update), 3. 好友订阅列表 (Friend Subscription List), 添加/删除/确认, 4. 好友节点发送到低功耗节点的“已存储消息”，使用泛洪安全材料加密的相应友谊消息有：1. 好友清除 (Friend Clear), 2. 好友清除确认 (Friend Clear Confirm)。根据应用程序的设置，从低功耗节点发送到好友节点的消息会使用友谊安全材料或泛洪安全材料进行加密，前者用于低功耗节点与好友节点之间的消息传输，而后者用于其他网络消息。
定向安全资料	”The directed security material is derived from the network key (NetKey) and can be used by other nodes in the directed forwarding path.”	定向安全资料是从网络密钥 (NetKey) 派生的，可以被定向转发路径中的其他节点使用。使用定向安全资料加密的消息可以被同一定向转发路径中的任何节点解码。

表 19: 表 7 ESP-BLE-MESH 术语 - 消息

术语	官方定义	详细说明
重组 / 分包	”Segmentation and reassembly (SAR) is a method of communication network, which is divided into small units before transmitting packets and re-assembled in a proper order at the communication receiving end.”	底层传输层会自动分包过大的消息。接收端会回复一条应答消息，根据应答消息，发送端会重新向接收端发送其未接收到的数据包。这些都是底层传输层自动完成的。未分包的消息最多携带 15 个字节，其中 4 个字节是 transMIC，所以剩余 11 个字节；在分包的情况下，前面的包中每包有 12 个有效字节，最后一个包中有 8 个有效字节。特殊情况：一个较短的包需要底层传输端强制分包，这种情况下有 8 个有效字节。
无应答 / 有应答	”There are two types of messages: Unacknowledged or Acknowledged.”	根据接收端是否需要发送应答消息，发送的消息可分为两种。发送端需要设置最大重传次数。

表 20: 表 8 ESP-BLE-MESH 术语 - 基础模型

术语	官方定义	详细说明
Configuration Server Model	”This model is used to represent a mesh network configuration of a device.”	节点必须包含 Configuration Server Model, 其负责维护配置相关的状态。Configuration Server Model 维护的状态包含: 网络密钥名单 (NetKey List)、应用密钥名单 (AppKey List)、模型绑定的应用密钥名单 (Model to AppKey List)、节点身份 (Node Identity)、密钥更新阶段 (Key Refresh Phase)、心跳消息发布 (Heartbeat Publish)、心跳消息订阅 (Heartbeat Subscription)、网络传输 (Network Transmit) 和中继重传 (Relay Retransmit) 等。
Configuration Client Model	”The model is used to represent an element that can control and monitor the configuration of a node.”	Configuration Client Model 通过消息控制 Configuration Server Model 维护的状态。Provisioner 必须包含 Configuration Client Model, 有了该模型才可发送”Configuration Composition Data Get” 等配置消息。
Health Server Model	”This model is used to represent a mesh network diagnostics of a device.”	Health Server Model 主要用于设备检查自身状态, 查看自身是否发生错误。Health Server model 维护的状态包含: 当前故障 (Current Fault)、已登记故障 (Registered Fault)、健康周期 (Health Period) 和关注计时器 (Attention Timer)。
Health Client Model	”The model is used to represent an element that can control and monitor the health of a node.”	Health Client Model 通过消息控制 Health Server Model 维护的状态。该模型可通过消息 “Health Fault Get” 获取其他节点的自检信息。
Remote Provisioning Server model	”The model is used to support the functionality of provisioning a remote device over the mesh network and to perform the Node Provisioning Protocol Interface procedures.”	该模型用于支持通过网状网络对远程设备进行供应, 并执行节点供应协议接口程序。
Remote Provisioning Client model	”The model is used to support the functionality of provisioning devices into a mesh network by interacting with a mesh node that supports the Remote Provisioning Server model.”	该模型用于与支持远程供应服务器模型的网状节点进行交互, 以支持将设备供应到网状网络的功能。
Directed Forwarding Configuration Server model	”The model is used to support the configuration of the directed forwarding functionality of a node.”	该模型用于支持节点的定向转发功能的配置。
Directed Forwarding Configuration Client model	”The model is used to support the functionality of a node that can configure the directed forwarding functionality of another node.”	该模型用于支持一个节点配置另一个节点的定向转发功能的功能。
Bridge Configuration Server model	”The model is used to support the configuration of the subnet bridge functionality of a node.”	该模型用于支持节点的子网桥接功能的配置。
Bridge Configuration Client model	”The model is used to support the functionality of a node that can configure	该模型用于支持一个节点配置另一个节点的子网桥接功能的功能。



表 21: 表 9 ESP-BLE-MESH 术语 - 网络管理

术语	官方定义	详细说明
密钥更新程序	"This procedure is used when the security of one or more network keys and/or one or more of the application keys has been compromised or could be compromised."	密钥更新程序用于更新 ESP-BLE-MESH 网络的网络密钥和应用密钥。当一个或多个网络密钥和/或多个应用密钥的安全受到威胁或可能受到威胁时，会启动密钥更新程序。通常而言，在网络中某些节点移除后可以进行密钥更新。
IV 更新程序	"A node can also use an IV Update procedure to signal to peer nodes that it is updating the IV Index."	IV 更新程序用于更新 ESP-BLE-MESH 网络的 IV Index 的值，这个值和消息加密时所需的随机数相关。为了保证随机数的值不重复，所以将这个值定期增加。IV Index 是一个 32 位的值，是一种共享网络资源，比如一个 mesh 网中的所有节点共享一个 IV Index 值。IV Index 从 0x00000000 开始，在 IV 更新过程中递增，并由特定的进程维护，以保证整个 Mesh 网内共享一个 IV Index。当节点认为它有耗尽其序列号的风险，或它确定另一个节点即将耗尽其序列号时，可以启动该程序。注意：每次的更新时间不得低于 96 小时。节点接收到 secure network beacon 或者确定自己的序列号大于特定值时，会触发 IV 更新程序。

官方定义摘自 [ESP-BLE-MESH Glossary of Terms](#). 查看更多术语，也请参照上述网址。

## 蓝牙 SIG 文档

- [BLE Mesh Core Specification](#)
- [BLE Mesh Protocol v1.1 Specification](#)
- [BLE Mesh Model Specification](#)
- [BLE Mesh Model v1.1 Specification](#)
- [An Intro to Bluetooth Mesh Part 1 / Part 2](#)
- [The Fundamental Concepts of Bluetooth Mesh Networking, Part 1 / Part 2](#)
- [Bluetooth Mesh Networking: Friendship](#)
- [Management of Devices in a Bluetooth Mesh Network](#)
- [Bluetooth Mesh Security Overview](#)
- [Provisioning a Bluetooth Mesh Network Part 1 / Part 2](#)

## 4.14 严重错误

### 4.14.1 概述

在某些情况下，程序并不会按照我们的预期运行，在 ESP-IDF 中，这些情况包括：

- CPU 异常：非法指令，加载/存储时的内存对齐错误，加载/存储时的访问权限错误。
- 系统级检查错误：
  - 中断看门狗 超时
  - 任务看门狗 超时（只有开启 `CONFIG_ESP_TASK_WDT_PANIC` 后才会触发严重错误）
  - 高速缓存访问错误
  - 掉电检测事件
  - 堆栈溢出
  - 堆栈粉碎保护检查
  - 堆完整性检查
  - 未定义行为清理器 (UBSAN) 检查

- 使用 `assert`、`configASSERT` 等类似的宏断言失败。

本指南会介绍 ESP-IDF 中这类错误的处理流程，并给出对应的解决建议。

## 4.14.2 紧急处理程序

**概述** 中列举的所有错误都会由紧急处理程序 (*Panic Handler*) 负责处理。

紧急处理程序首先会将出错原因打印到控制台，例如 CPU 异常的错误信息通常会类似于

```
Guru Meditation Error: Core 0 panic'ed (IllegalInstruction). Exception was
↳unhandled.
```

对于一些系统级检查错误（如中断看门狗超时，高速缓存访问错误等），错误信息会类似于

```
Guru Meditation Error: Core 0 panic'ed (Cache error). Exception was
↳unhandled.
```

不管哪种情况，错误原因都会被打印在括号中。请参阅 [Guru Meditation 错误](#) 以查看所有可能的出错原因。

紧急处理程序接下来的行为将取决于 `CONFIG_ESP_SYSTEM_PANIC` 的设置，支持的选项包括：

- 打印 CPU 寄存器，然后重启 (`CONFIG_ESP_SYSTEM_PANIC_PRINT_REBOOT`) - 默认选项  
打印系统发生异常时 CPU 寄存器的值，打印回溯，最后重启芯片。
- 打印 CPU 寄存器，然后暂停 (`CONFIG_ESP_SYSTEM_PANIC_PRINT_HALT`)  
与上一个选项类似，但不会重启，而是选择暂停程序的运行。重启程序需要外部执行复位操作。
- 静默重启 (`CONFIG_ESP_SYSTEM_PANIC_SILENT_REBOOT`)  
不打印 CPU 寄存器的值，也不打印回溯，立即重启芯片。
- 调用 GDB Stub (`CONFIG_ESP_SYSTEM_PANIC_GDBSTUB`)  
启动 GDB 服务器，通过控制台 UART 接口与 GDB 进行通信。该选项只提供只读调试或者事后调试，详细信息请参阅 [GDB Stub](#)。

---

**备注：** 仅当构建中包含组件 `esp_gdbstub` 时，配置选项 `CONFIG_ESP_SYSTEM_PANIC` 中的 `CONFIG_ESP_SYSTEM_PANIC_GDBSTUB` 选项可用。

---

紧急处理程序的行为还受到另外两个配置项的影响：

- 如果使能了 `CONFIG_ESP_DEBUG_OCDAWARE`（默认），紧急处理程序会检测 ESP32-H2 是否已经连接 JTAG 调试器。如果检测成功，程序会暂停运行，并将控制权交给调试器。在这种情况下，寄存器和回溯不会被打印到控制台，并且也不会使用 GDB Stub 和 Core Dump 的功能。
- 如果使能了 [内核转储](#) 功能，系统状态（任务堆栈和寄存器）会被转储到 flash 或者 UART 以供后续分析。
- 如果 `CONFIG_ESP_PANIC_HANDLER_IRAM` 被禁用（默认情况下禁用），紧急处理程序的代码会放置在 flash 而不是 IRAM 中。这意味着，如果 ESP-IDF 在 flash 高速缓存禁用时崩溃，在运行 GDB Stub 和内核转储之前紧急处理程序会自动重新使能 flash 高速缓存。如果 flash 高速缓存也崩溃了，这样做会增加一些小风险。  
如果使能了该选项，紧急处理程序的代码（包括所需的 UART 函数）会放置在 IRAM 中，导致 SRAM 中的可用内存空间变小。当禁用 flash 高速缓存（如写入 SPI flash）时或触发异常导致 flash 高速缓存崩溃时，可用此选项调试一些复杂的崩溃问题。
- 如果启用 `CONFIG_ESP_SYSTEM_PANIC_REBOOT_DELAY_SECONDS`（默认为禁用）并将其配置为大于 0 的数字，紧急处理程序将基于该数字延迟重启的时间，单位为秒。如果用于监测串行输出的工具不支持停止和检查串行输出，可启用该选项。在这种情况下，借助延迟重启，用户可以在延迟期间检查和调试紧急处理程序的输出（例如回溯）。延迟结束后，设备将重新启动，并记录重置原因。

下图展示了紧急处理程序的行为：

## 4.14.3 寄存器转储与回溯

除非启用了 `CONFIG_ESP_SYSTEM_PANIC_SILENT_REBOOT` 否则紧急处理程序会将 CPU 寄存器和回溯打印到控制台



图 24: 紧急处理程序流程图 (点击放大)



```

Core 0 register dump:
MEPC      : 0x420048b4 RA      : 0x420048b4 SP      : 0x3fc8f2f0 GP      : _
↳0x3fc8a600
TP        : 0x3fc8a2ac T0      : 0x40057fa6 T1      : 0x0000000f T2      : _
↳0x00000000
S0/FP     : 0x00000000 S1      : 0x00000000 A0      : 0x00000001 A1      : _
↳0x00000001
A2        : 0x00000064 A3      : 0x00000004 A4      : 0x00000001 A5      : _
↳0x00000000
A6        : 0x42001fd6 A7      : 0x00000000 S2      : 0x00000000 S3      : _
↳0x00000000
S4        : 0x00000000 S5      : 0x00000000 S6      : 0x00000000 S7      : _
↳0x00000000
S8        : 0x00000000 S9      : 0x00000000 S10     : 0x00000000 S11     : _
↳0x00000000
T3        : 0x00000000 T4      : 0x00000000 T5      : 0x00000000 T6      : _
↳0x00000000
MSTATUS   : 0x00001881 MTVEC   : 0x40380001 MCAUSE   : 0x00000007 MTVAL   : _
↳0x00000000
MHARTID   : 0x00000000

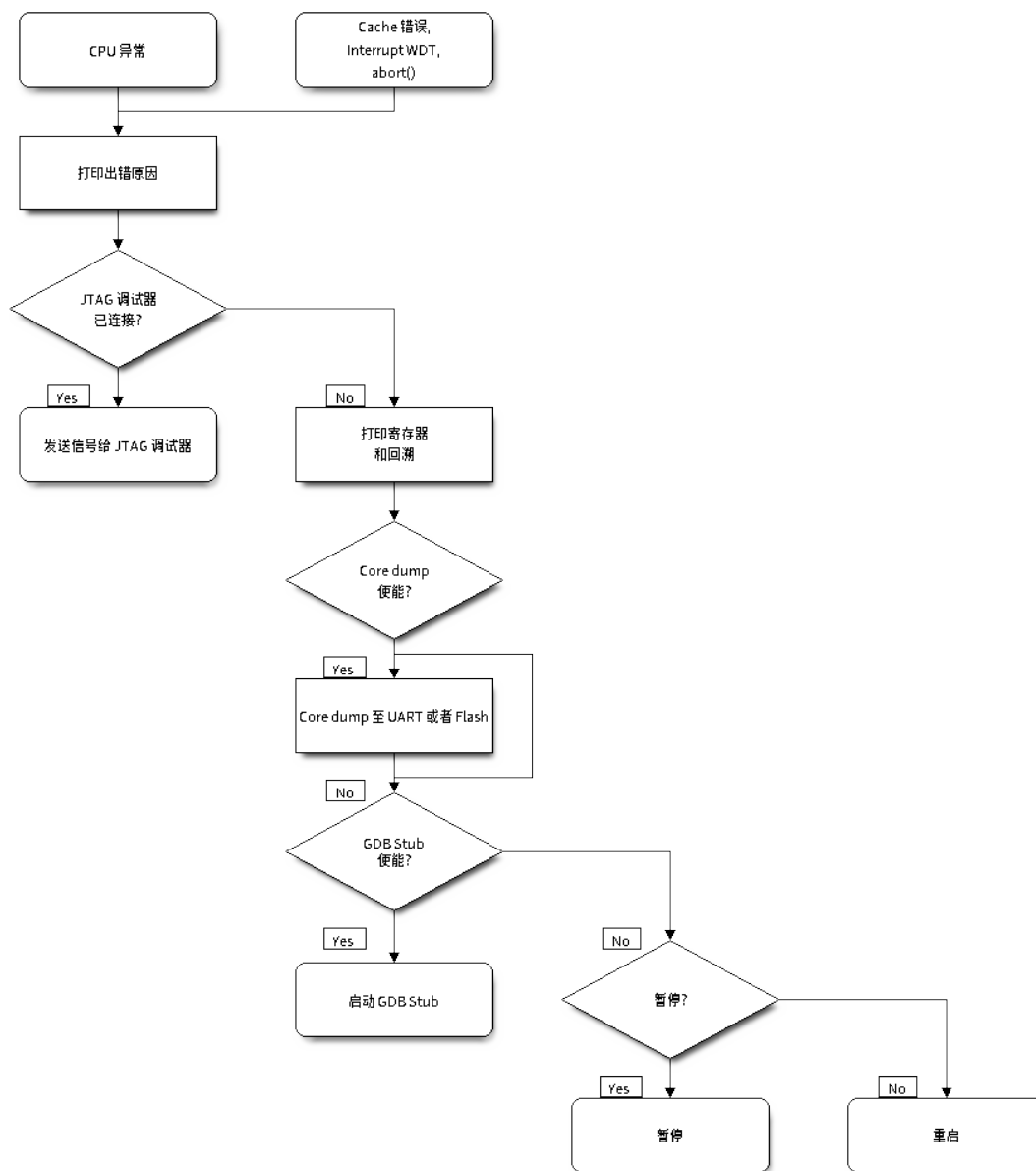
```

仅会打印异常帧中 CPU 寄存器的值，即引发 CPU 异常或者其它严重错误时刻的值。

紧急处理程序如果是因 `abort()` 而调用，则不会打印寄存器转储。

如果使用了 [IDF 监视器](#)，该工具会将程序计数器的值转换为对应的代码位置（函数名，文件名，行号），并加以注释：

```

Core 0 register dump:
MEPC      : 0x420048b4 RA      : 0x420048b4 SP      : 0x3fc8f2f0 GP      : _
↳0x3fc8a600
0x420048b4: app_main at /Users/user/esp/example/main/hello_world_main.c:20
0x420048b4: app_main at /Users/user/esp/example/main/hello_world_main.c:20
TP        : 0x3fc8a2ac T0      : 0x40057fa6 T1      : 0x0000000f T2      : _
↳0x00000000
S0/FP     : 0x00000000 S1      : 0x00000000 A0      : 0x00000001 A1      : _
↳0x00000001
A2        : 0x00000064 A3      : 0x00000004 A4      : 0x00000001 A5      : _
↳0x00000000
A6        : 0x42001fd6 A7      : 0x00000000 S2      : 0x00000000 S3      : _
↳0x00000000
0x42001fd6: uart_write at /Users/user/esp/esp-idf/components/vfs/vfs_uart.c:201
S4        : 0x00000000 S5      : 0x00000000 S6      : 0x00000000 S7      : _
↳0x00000000
S8        : 0x00000000 S9      : 0x00000000 S10     : 0x00000000 S11     : _
↳0x00000000
T3        : 0x00000000 T4      : 0x00000000 T5      : 0x00000000 T6      : _
↳0x00000000
MSTATUS   : 0x00001881 MTVEC   : 0x40380001 MCAUSE   : 0x00000007 MTVAL   : _
↳0x00000000
MHARTID   : 0x00000000

```

此外，由于紧急处理程序中提供了堆栈转储，因此 [IDF 监视器](#) 也可以生成并打印回溯。输出结果如下：

```

Backtrace:
0x42006686 in bar (ptr=ptr@entry=0x0) at ../main/hello_world_main.c:18
18      *ptr = 0x42424242;
#0 0x42006686 in bar (ptr=ptr@entry=0x0) at ../main/hello_world_main.c:18

```

(下页继续)

(续上页)

```
#1 0x42006692 in foo () at ../main/hello_world_main.c:22
#2 0x420066ac in app_main () at ../main/hello_world_main.c:28
#3 0x42015ece in main_task (args=<optimized out>) at /Users/user/esp/components/
↳freertos/port/port_common.c:142
#4 0x403859b8 in vPortEnterCritical () at /Users/user/esp/components/freertos/
↳port/riscv/port.c:130
#5 0x00000000 in ?? ()
Backtrace stopped: frame did not save the PC
```

虽然以上的回溯信息非常方便，但要求用户使用 *IDF* 监视器。因此，如果用户希望使用其它的串口监控软件也能显示堆栈回溯信息，则需要 `menuconfig` 中启用 `CONFIG_ESP_SYSTEM_USE_EH_FRAME` 选项。

该选项会让编译器为项目的每个函数生成 DWARF 信息。然后，当 CPU 异常发生时，紧急处理程序将解析这些数据并生成出错任务的堆栈回溯信息。输出结果如下：

```
Backtrace: 0x42009e9a:0x3fc92120 0x42009ea6:0x3fc92120 0x42009ec2:0x3fc92130
↳0x42024620:0x3fc92150 0x40387d7c:0x3fc92160 0xffffffff:0x3fc92170
```

这些 PC:SP 对代表当前任务每一个栈帧的程序计数器值 (Program Counter) 和栈顶地址 (Stack Pointer)。

`CONFIG_ESP_SYSTEM_USE_EH_FRAME` 选项的主要优点是，回溯信息可以由程序自己解析生成并打印 (而不依靠 *IDF* 监视器)。但是该选项会导致编译后的二进制文件更大 (增幅可达 20% 甚至 100%)。此外，该选项会将调试信息也保存在二进制文件里。因此，强烈不建议用户在量产/生产版本中启用该选项。

若要查找发生严重错误的代码位置，请查看“Backtrace”的后面几行，发生严重错误的代码显示在顶行，后续几行显示的是调用堆栈。

#### 4.14.4 GDB Stub

如果启用了 `CONFIG_ESP_SYSTEM_PANIC_GDBSTUB` 选项，在发生严重错误时，紧急处理程序不会复位芯片，相反，它将启动 GDB 远程协议服务器，通常称为 GDB Stub。发生这种情况时，可以让主机上运行的 GDB 实例通过 UART 端口连接到 ESP32。

如果使用了 *IDF* 监视器，该工具会在 UART 端口检测到 GDB Stub 提示符后自动启动 GDB，输出会类似于：

```
Entering gdb stub now.
$T0b#e6GNU gdb (crosstool-NG crosstool-ng-1.22.0-80-gfff1f415) 7.10
Copyright (C) 2015 Free Software Foundation, Inc.
License GPLv3+: GNU GPL version 3 or later <http://gnu.org/licenses/gpl.html>
This is free software: you are free to change and redistribute it.
There is NO WARRANTY, to the extent permitted by law. Type "show copying"
and "show warranty" for details.
This GDB was configured as "--host=x86_64-build_apple-darwin16.3.0 --
↳target=riscv32-esp-elf".
Type "show configuration" for configuration details.
For bug reporting instructions, please see:
<http://www.gnu.org/software/gdb/bugs/>.
Find the GDB manual and other documentation resources online at:
<http://www.gnu.org/software/gdb/documentation/>.
For help, type "help".
Type "apropos word" to search for commands related to "word"...
Reading symbols from /Users/user/esp/example/build/example.elf...done.
Remote debugging using /dev/cu.usbserial-31301
0x400e1b41 in app_main ()
    at /Users/user/esp/example/main/main.cpp:36
36     *((int*) 0) = 0;
(gdb)
```

在 GDB 会话中，我们可以检查 CPU 寄存器，本地和静态变量以及内存中任意位置的值。但是不支持设置断点，改变 PC 值或者恢复程序的运行。若要复位程序，请退出 GDB 会话，在 *IDF* 监视器中连续输入

Ctrl-T Ctrl-R，或者按下开发板上的复位按键也可以重新运行程序。

### 4.14.5 RTC 看门狗超时

RTC 看门狗在启动代码中用于跟踪执行时间，也有助于防止由于电源不稳定引起的锁定。RTC 看门狗默认启用，参见 `CONFIG_BOOTLOADER_WDT_ENABLE`。如果执行时间超时，RTC 看门狗将自动重启系统。此时，ROM 引导加载程序将打印消息 `RTC Watchdog Timeout` 说明重启原因。

```
rst:0x10 (LP_WDT_SYS)
```

RTC 看门狗涵盖了从一级引导程序（ROM 引导程序）到应用程序启动的执行时间，最初在 ROM 引导程序中设置，而后在引导程序中使用 `CONFIG_BOOTLOADER_WDT_TIME_MS` 选项进行配置（默认 9000 ms）。在应用初始化阶段，由于慢速时钟源可能已更改，RTC 看门狗将被重新配置，最后在调用 `app_main()` 之前被禁用。可以使用选项 `CONFIG_BOOTLOADER_WDT_DISABLE_IN_USER_CODE` 以保证 RTC 看门狗在调用 `app_main` 之前不被禁用，而是保持运行状态，用户需要在应用代码中定期“喂狗”。

### 4.14.6 Guru Meditation 错误

本节将对打印在 `Guru Meditation Error: Core panic'ed` 后面括号中的致错原因进行逐一解释。

**备注：**想要了解“Guru Meditation”的历史渊源，请参阅 [维基百科](#)。

#### IllegalInstruction

此 CPU 异常表示当前执行的指令不是有效指令，引起此错误的常见原因包括：

- FreeRTOS 中的任务函数已返回。在 FreeRTOS 中，如果想终止任务函数，需要调用 `vTaskDelete()` 函数释放当前任务的资源，而不是直接返回。
- 无法从 SPI flash 中读取下一条指令，这通常发生在：
  - 应用程序将 SPI flash 的管脚重新配置为其它功能（如 GPIO、UART 等）。有关 SPI flash 管脚的详细信息，请参阅硬件设计指南和芯片/模组的数据手册。
  - 某些外部设备意外连接到 SPI flash 的管脚上，干扰了 ESP32-H2 和 SPI flash 之间的通信。
- 在 C++ 代码中，退出 non-void 函数而无返回值被认为是未定义的行为。启用优化后，编译器通常会忽略此类函数的结尾，导致 `IllegalInstruction` 异常。默认情况下，ESP-IDF 构建系统启用 `-Werror=return-type`，这意味着缺少返回语句会被视为编译时错误。但是，如果应用程序项目禁用了编译器警告，可能就无法检测到该问题，在运行时就会出现 `IllegalInstruction` 异常。

#### Instruction address misaligned

此 CPU 异常表示要执行的指令地址非 2 字节对齐。

#### Instruction access fault, Load access fault, Store access fault

当应用程序尝试读取或写入无效的内存位置时，会发生此类 CPU 异常。此类无效内存地址可以在寄存器转储的 `MTVAL` 中找到。如果该地址为零，通常意味着应用程序正尝试解引用一个 NULL 指针。如果该地址接近于零，则通常意味着应用程序尝试访问某个结构体的成员，但是该结构体的指针为 NULL。如果该地址是其它非法值（不在 `0x3fxxxxxx - 0x6xxxxxxx` 的范围内），则可能意味着用于访问数据的指针未初始化或者已经损坏。

#### Breakpoint

执行 `EBREAK` 指令时，会发生此 CPU 异常。请参见 [FreeRTOS 任务堆栈末尾监视点](#)。

### Load address misaligned, Store address misaligned

应用程序尝试读取/写入的内存位置不符合加载/存储指令对字节对齐大小的要求，例如，32 位加载指令只能访问 4 字节对齐的内存地址，而 16 位加载指令只能访问 2 字节对齐的内存地址。

### Interrupt wdt timeout on CPU0 / CPU1

这表示发生了中断看门狗超时，详细信息请查阅[看门狗](#) 文档。

### Cache error

在某些情况下，ESP-IDF 会暂时禁止通过高速缓存访问外部 SPI flash 和 SPI RAM，例如在使用 spi\_flash API 读取/写入/擦除/映射 SPI flash 的时候。在这些情况下，任务会被挂起，并且未使用 ESP\_INTR\_FLAG\_IRAM 注册的中断处理程序会被禁用。请确保任何使用此标志注册的中断处理程序所访问的代码和数据分别位于 IRAM 和 DRAM 中。更多详细信息请参阅[SPI flash API 文档](#)。

## 4.14.7 其他严重错误

### 掉电

ESP32-H2 内部集成掉电检测电路，并且会默认启用。如果电源电压低于安全值，掉电检测器可以触发系统复位。掉电检测器可以使用 `CONFIG_ESP_BROWNOUT_DET` 和 `CONFIG_ESP_BROWNOUT_DET_LVL_SEL` 这两个选项进行设置。

当掉电检测器被触发时，会打印如下信息：

```
Brownout detector was triggered
```

芯片会在该打印信息结束后复位。

请注意，如果电源电压快速下降，则只能在控制台上看到部分打印信息。

### 堆不完整

ESP-IDF 堆的实现包含许多运行时的堆结构检查，可以在 menuconfig 中开启额外的检查（“Heap Poisoning”）。如果其中的某项检查失败，则会打印类似如下信息：

```
CORRUPT HEAP: Bad tail at 0x3ffe270a. Expected 0xbaad5678 got 0xbaac5678
assertion "head != NULL" failed: file "/Users/user/esp/esp-idf/components/heap/
↳multi_heap_poisoning.c", line 201, function: multi_heap_free
abort() was called at PC 0x400dca43 on core 0
```

更多详细信息，请查阅[堆内存调试](#) 文档。

### 堆栈溢出

**硬件堆栈保护** ESP32-H2 集成了辅助调试模块，支持监测堆栈指针 (SP) 寄存器，确保其值位于已分配给堆栈的内存范围内。发生中断处理或 FreeRTOS 切换上下文时，辅助调试模块都会设置新的堆栈监测范围。注意，该操作会对性能产生一定影响。

以下为辅助调试模块的部分相关特性：

- 采用硬件实现
- 支持监测堆栈指针寄存器的值
- 无需占用额外 CPU 时间或内存，即可监测堆栈内存范围

当辅助调试模块检测到堆栈溢出时，将触发紧急处理程序并打印类似如下信息：

```
Guru Meditation Error: Core 0 panic'ed (Stack protection fault).
```

可以通过 `CONFIG_ESP_SYSTEM_HW_STACK_GUARD` 选项，禁用硬件堆栈保护。

**FreeRTOS 任务堆栈末尾监视点** ESP-IDF 支持基于监视点的 FreeRTOS 堆栈溢出检测机制。每次 FreeRTOS 切换任务上下文时，都会设置一个监视点，用于监视堆栈的最后 32 字节。

通常，该设置会提前触发监视点，触发点可能会比预期提前多达 28 字节。基于 FreeRTOS 中堆栈金丝雀的大小为 20 字节，故将观察范围设置为 32 字节，确保可以在堆栈金丝雀遭到破坏前及时触发监测点。

**备注：**并非每次堆栈溢出都能触发监视点。如果任务绕过堆栈金丝雀的位置访问堆栈，则无法触发监视点。

监视点触发后，将打印类似如下信息：

```
Guru Meditation Error: Core 0 panic'ed (Breakpoint). Exception was unhandled.
```

可以通过 `CONFIG_FREERTOS_WATCHPOINT_END_OF_STACK` 选项启用该功能。

**FreeRTOS 堆栈检查** 请参见 `CONFIG_FREERTOS_CHECK_STACKOVERFLOW`。

## 堆栈粉碎

堆栈粉碎保护（基于 GCC `-fstack-protector*` 标志）可以通过 ESP-IDF 中的 `CONFIG_COMPILER_STACK_CHECK_MODE` 选项来开启。如果检测到堆栈粉碎，则会打印类似如下信息：

```
Stack smashing protect failure!

abort() was called at PC 0x400d2138 on core 0

Backtrace: 0x4008e6c0:0x3ffc1780 0x4008e8b7:0x3ffc17a0 0x400d2138:0x3ffc17c0
↳0x400e79d5:0x3ffc17e0 0x400e79a7:0x3ffc1840 0x400e79df:0x3ffc18a0
↳0x400e2235:0x3ffc18c0 0x400e1916:0x3ffc18f0 0x400e19cd:0x3ffc1910
↳0x400e1a11:0x3ffc1930 0x400e1bb2:0x3ffc1950 0x400d2c44:0x3ffc1a80
0
```

回溯信息会指明发生堆栈粉碎的函数，建议检查函数中是否有代码访问局部数组时发生了越界。

## 未定义行为清理器 (UBSAN) 检查

未定义行为清理器 (UBSAN) 是一种编译器功能，它会为可能不正确的操作添加运行时检查，例如：

- 溢出（乘法溢出、有符号整数溢出）
- 移位基数或指数错误（如移位超过 32 位）
- 整数转换错误

请参考 [GCC 文档](#) 中的 `-fsanitize=undefined` 选项，查看支持检查的完整列表。

**使能 UBSAN** 默认情况下未启用 UBSAN。可以通过在构建系统中添加编译器选项 `-fsanitize=undefined` 在文件、组件或项目级别上使能 UBSAN。

在对使用 SoC 硬件寄存器头文件 (`soc/xxx_reg.h`) 的代码使能 UBSAN 时，建议使用 `-fno-sanitize=shift-base` 选项禁用移位基数清理器。这是由于 ESP-IDF 寄存器头文件目前包含的模式会对这个特定的清理器选项造成误报。

要在项目级使能 UBSAN，请在项目 `CMakeLists.txt` 文件的末尾添加以下内容：

```
idf_build_set_property(COMPILER_OPTIONS "-fsanitize=undefined" "-fno-sanitize=shift-
↪base" APPEND)
```

或者，通过 `EXTRA_CFLAGS` 和 `EXTRA_CXXFLAGS` 环境变量来传递这些选项。

使能 UBSAN 会明显增加代码量和数据大小。当为整个应用程序使能 UBSAN 时，微控制器的可用 RAM 无法容纳大多数应用程序（除了一些小程序）。因此，建议为特定的待测组件使能 UBSAN。

要为项目 `CMakeLists.txt` 文件中的特定组件 (`component_name`) 启用 UBSAN，请在文件末尾添加以下内容：

```
idf_component_get_property(lib component_name COMPONENT_LIB)
target_compile_options(${lib} PRIVATE "-fsanitize=undefined" "-fno-sanitize=shift-
↪base")
```

**注意：** 关于 [构建属性](#) 和 [组件属性](#) 的更多信息，请查看构建系统文档。

要为同一组件的 `CMakeLists.txt` 中的特定组件 (`component_name`) 使能 UBSAN，在文件末尾添加以下内容：

```
target_compile_options(${COMPONENT_LIB} PRIVATE "-fsanitize=undefined" "-fno-
↪sanitize=shift-base")
```

**UBSAN 输出** 当 UBSAN 检测到一个错误时，会打印一个信息和回溯，例如：

```
Undefined behavior of type out_of_bounds

Backtrace:0x4008b383:0x3ffcd8b0 0x4008c791:0x3ffcd8d0 0x4008c587:0x3ffcd8f0
↪0x4008c6be:0x3ffcd950 0x400db74f:0x3ffcd970 0x400db99c:0x3ffcd9a0
```

当使用 *IDF* 监视器 时，回溯会被解码为函数名以及源代码位置，并指向问题发生的位置（这里是 `main.c:128`）：

```
0x4008b383: panic_abort at /path/to/esp-idf/components/esp_system/panic.c:367

0x4008c791: esp_system_abort at /path/to/esp-idf/components/esp_system/system_api.
↪c:106

0x4008c587: __ubsan_default_handler at /path/to/esp-idf/components/esp_system/
↪ubsan.c:152

0x4008c6be: __ubsan_handle_out_of_bounds at /path/to/esp-idf/components/esp_system/
↪ubsan.c:223

0x400db74f: test_ub at main.c:128

0x400db99c: app_main at main.c:56 (discriminator 1)
```

UBSAN 报告的错误类型为以下几种：



名称	含义
type_mismatch、 type_mismatch_v1	指针值不正确：空、未对齐、或与给定类型不兼容
add_overflow、sub_overflow、 mul_overflow、negate_overflow	加法、减法、乘法、求反过程中的整数溢出
divrem_overflow	整数除以 0 或 INT_MIN
shift_out_of_bounds	左移或右移运算符导致的溢出
out_of_bounds	访问超出数组范围
unreachable	执行无法访问的代码
missing_return	Non-void 函数已结束而没有返回值（仅限 C++）
vla_bound_not_positive	可变长度数组的大小不是正数
load_invalid_value	bool 或 enum（仅 C++）变量的值无效（超出范围）
nonnull_arg	对于 nonnull 属性的函数，传递给函数的参数为空
nonnull_return	对于 returns_nonnull 属性的函数，函数返回值为空
builtin_unreachable	调用 __builtin_unreachable 函数
pointer_overflow	指针运算过程中的溢出

## 4.15 硬件抽象

ESP-IDF 提供了一组用于硬件抽象的 API，支持以不同抽象级别控制外设，相比仅使用 ESP-IDF 驱动程序与硬件进行交互，使用更加灵活。ESP-IDF 硬件抽象适用于编写高性能裸机驱动程序，或尝试将 ESP 芯片移植到另一个平台。

本指南分为以下三个小节：

1. 架构
2. LL 层（低级层）
3. HAL（硬件抽象层）

**警告：** 硬件抽象 API（不包括驱动程序和 xxx\_types.h）尚处于试验阶段，因此不能算作公共 API。硬件抽象 API 不遵守 ESP-IDF 版本控制方案的 API 名称更改规范。换言之，非主要 ESP-IDF 版本迭代时，硬件抽象 API 的名称可能会更改。

**备注：** 尽管本文档主要关注外设的硬件抽象，如 UART、SPI、I2C 等，但硬件抽象可以扩展到外设以外的其他硬件部分，如某些 CPU 功能也进行了部分抽象。

### 4.15.1 架构

ESP-IDF 的硬件抽象由以下层级各组成，从接近硬件的低层级抽象，到远离硬件的高层级抽象。

- 低级层 (LL)
- 硬件抽象层 (HAL)
- 驱动层

LL 层和 HAL 完全包含在 hal 组件中，每一层都依赖于其下方的层级，即驱动层依赖于 HAL 层，HAL 层依赖于 LL 层，LL 层依赖于寄存器头文件。

对于特定外设 xxx，其硬件抽象通常由下表中的头文件组成。其中 **特定目标** 指的是文件对于不同目标（即芯片）有不同的实现。然而，对于不同的目标，#include 指令相同，构建系统会自动包含正确版本的头文件和源文件。

表 22: 硬件抽象头文件

包含指令	特定目标	描述
#include 'soc/ xxx_caps.h"	是	此头文件包含了 C 宏列表, 指明 ESP32-H2 外设 xxx 的各种功能。外设的硬件功能包括通道数量、DMA 支持、硬件 FIFO/缓冲区长度等。
#include "soc/ xxx_struct.h" #include "soc/ xxx_reg.h"	是	这两个头文件分别以 C 结构体和 C 宏的形式表示外设寄存器, 支持通过其中任一头文件, 在寄存器级别上操作外设。
#include "soc/ xxx_pins.h"	是	如果某些外设的信号映射到 ESP32-H2 的特定管脚上, 则该头文件中以 C 宏的形式定义了它们的映射关系。
#include "soc/ xxx_periph.h"	否	此头文件主要是为了方便, 可以自动包含 xxx_caps.h、xxx_struct.h 和 xxx_reg.h。
#include "hal/ xxx_types.h"	否	此头文件包含了在 LL、HAL 和驱动层间共享的类型定义和宏。此外, 作为公共 API, 该头文件可以包含在应用层中。共享的类型和定义通常与具体的实现无关, 例如: <ul style="list-style-type: none"> <li>• 协议相关的类型/宏, 如帧、模式、常见总线速度等。</li> <li>• xxx 外设可能存在的特性/特点, 可能存在于任何实现上 (与实现无关), 例如通道、工作模式、信号放大或衰减强度等。</li> </ul>
#include "hal/ xxx_ll.h"	是	此头文件包含了硬件抽象的 LL 层。LL 层 API 主要用于将寄存器操作抽象成可读的函数。
#include "hal/ xxx_hal.h"	是	HAL 层用于将外设操作步骤抽象成函数, 如读取缓冲区、启动传输、处理事件等。HAL 层构建在 LL 层之上。
#include "driver/xxx.h"	否	驱动层是 ESP-IDF 硬件抽象的最高级别。驱动层 API 旨在从 ESP-IDF 应用程序中调用, 并在内部使用操作系统的基本功能。因此, 驱动层 API 由事件驱动, 并可在多线程环境中使用。

### 4.15.2 LL 层 (低级层)

LL 层主要目的是将寄存器字段访问抽象为更容易理解的函数。LL 函数本质是将各种输入/输出参数转换为外设寄存器的寄存器字段, 并以获取/设置函数的形式呈现。所有必要的位移、掩码、偏移和寄存器字段的字节顺序都应由 LL 函数处理。

```
//在 xxx_ll.h 内
static inline void xxx_ll_set_baud_rate(xxx_dev_t *hw,
                                        xxx_ll_clk_src_t clock_source,
                                        uint32_t baud_rate) {
    uint32_t src_clk_freq = (source_clk == XXX_SCLK_APB) ? APB_CLK_FREQ : REF_CLK_
↪FREQ;
    uint32_t clock_divider = src_clk_freq / baud;
    // 设置时钟选择字段
    hw->clk_div_reg.divider = clock_divider >> 4;
    // 设置时钟分频器字段
    hw->config.clk_sel = (source_clk == XXX_SCLK_APB) ? 0 : 1;
}

static inline uint32_t xxx_ll_get_rx_byte_count(xxx_dev_t *hw) {
    return hw->status_reg.rx_cnt;
}
```

以上代码片段展示了外设 xxx 的典型 LL 函数。LL 函数通常具有以下特点:

- 所有 LL 函数均定义为 static inline, 因此, 由于编译器优化而调用这些函数时, 开销最小。这些函数不保证由编译器内联, 因此在禁用缓存时 (例如从 IRAM ISR 上下文调用) 调用的任何



LL 函数都应标记为 `__attribute__((always_inline))`。

- 第一个参数应指向 `xxx_dev_t` 类型的指针。`xxx_dev_t` 类型表示外设寄存器的结构体，因此第一个参数始终是指向外设寄存器起始地址的指针。请注意，在某些情况下，如果外设具有多个相同寄存器布局的通道，`xxx_dev_t *hw` 可能指向特定通道的寄存器。
- LL 函数应尽可能简短，并且在大多数情况下是确定性的。换句话说，在最糟糕的情况下，LL 函数的运行时间可以在编译时确定。因此，LL 函数中的任何循环都应该是有限的；然而，目前也存在一些例外。
- LL 函数并非线程安全，其上层（驱动层）有责任确保不会同时访问寄存器和寄存器字段。

### 4.15.3 HAL（硬件抽象层）

HAL 将外设的操作过程建模成一组通用步骤，其中每个步骤都有一个相关联的函数。对于每个步骤，HAL 隐藏（抽象）了外设寄存器的实现细节（即需要设置/读取的寄存器）。通过将外设操作过程建模为一组功能步骤，HAL 可以抽象化（即透明处理）不同目标或芯片版本间的微小硬件实现差异。换句话说，特定外设的 HAL API 在多个目标/芯片版本之间基本保持相同。

以下 HAL 函数示例选自看门狗定时器 (WDT) HAL，每个函数都映射到了 WDT 操作生命周期的某个步骤，从而展示了 HAL 如何将外设的操作抽象为功能步骤。

```
// 初始化某个 WDT
void wdt_hal_init(wdt_hal_context_t *hal, wdt_inst_t wdt_inst, uint32_t prescaler,
↳ bool enable_intr);

// 配置 WDT 的特定超时阶段
void wdt_hal_config_stage(wdt_hal_context_t *hal, wdt_stage_t stage, uint32_t
↳ timeout, wdt_stage_action_t behavior);

// 启动 WDT
void wdt_hal_enable(wdt_hal_context_t *hal);

// 喂养（即重置）WDT
void wdt_hal_feed(wdt_hal_context_t *hal);

// 处理 WDT 超时
void wdt_hal_handle_intr(wdt_hal_context_t *hal);

// 停止 WDT
void wdt_hal_disable(wdt_hal_context_t *hal);

// 去初始化 WDT
void wdt_hal_deinit(wdt_hal_context_t *hal);
```

#### 禁用 RTC\_WDT

```
wdt_hal_context_t rtc_wdt_ctx = RWDT_HAL_CONTEXT_DEFAULT();
wdt_hal_write_protect_disable(&rtc_wdt_ctx);
wdt_hal_disable(&rtc_wdt_ctx);
wdt_hal_write_protect_enable(&rtc_wdt_ctx);
```

#### 重置 RTC\_WDT 计数器

```
wdt_hal_context_t rtc_wdt_ctx = RWDT_HAL_CONTEXT_DEFAULT();
wdt_hal_write_protect_disable(&rtc_wdt_ctx);
wdt_hal_feed(&rtc_wdt_ctx);
wdt_hal_write_protect_enable(&rtc_wdt_ctx);
```

HAL 函数通常具有以下特点：

- HAL 函数的第一个参数是 `xxx_hal_context_t *` 类型。HAL 上下文类型用于存储信息，这些信息与特定外设实例（即上下文实例）相关。HAL 上下文通过 `xxx_hal_init()` 函数初始化，可以存储以下信息：
  - 该实例的通道编号
  - 指向外设（或通道）寄存器的指针（即 `xxx_dev_t *` 类型）
  - 进行中的事务的信息（例如使用中的 DMA 描述符列表的指针）
  - 实例的一些配置值（例如通道配置）
  - 维护实例状态信息的变量（例如表明实例是否正在等待事务完成的标志）
- HAL 函数不应包含任何操作系统原语，如队列、信号量、互斥锁等。所有同步/并发操作应在更高层次（如驱动程序）处理。
- 某些外设的某些步骤可能无法由 HAL 进一步抽象，因此最终成为对 LL 函数的直接封装（或宏）。
- 某些 HAL 函数可能会放置在 IRAM 中，因此可能带有 `IRAM_ATTR` 或放置在单独的 `xxx_hal_iram.c` 源文件中。

## 4.16 JTAG 调试

本文将介绍如何安装 ESP32-H2 的 OpenOCD 调试环境，以及如何使用 GDB 来调试 ESP32-H2 的应用程序。

---

**备注：**也可以使用 `idf.py monitor` 来调试 ESP32-H2，免于设置 JTAG 或 OpenOCD。请参阅 [IDF 监视器](#) 和 [CONFIG\\_ESP\\_SYSTEM\\_GDBSTUB\\_RUNTIME](#)。

---

本文档结构如下：

**引言** 介绍本指南主旨。

**工作原理** 介绍 ESP32-H2、JTAG (Joint Test Action Group) 接口、OpenOCD 和 GDB 如何相互连接，从而实现 ESP32-H2 的调试功能。

**选择 JTAG 适配器** 介绍有关 JTAG 硬件适配器的选择及参照标准。

**安装 OpenOCD** 介绍如何安装官方预编译好的 OpenOCD 软件包并验证是否安装成功。

**配置 ESP32-H2 目标板** 介绍如何设置 OpenOCD 软件并安装 JTAG 硬件，两项共同构成调试目标。

**启动调试器** 介绍如何从 [Eclipse 集成开发环境](#) 和 [命令行终端](#) 启动 GDB 调试会话。

**调试范例** 如果你不熟悉 GDB，请查看此小节以获取 [Eclipse 集成开发环境](#) 以及 [命令行终端](#) 提供的调试示例。

**从源码构建 OpenOCD** 介绍如何在 [Windows](#)、[Linux](#) 和 [macOS](#) 操作系统上从源码构建 OpenOCD。

**注意事项和补充内容** 介绍使用 OpenOCD 和 GDB 通过 JTAG 接口调试 ESP32-H2 时的注意事项和补充内容。

### 4.16.1 引言

乐鑫已完成 OpenOCD 移植，以支持 ESP32-H2 处理器和多核 FreeRTOS 架构（大多数 ESP32-H2 应用程序的基础）。此外，乐鑫还提供了一些 OpenOCD 本身并不支持的工具，以进一步丰富调试功能。

本文将介绍如何在 Linux、Windows 和 macOS 环境下为 ESP32-H2 安装 OpenOCD，并使用 GDB 进行软件调试。除部分安装流程有所不同外，所有操作系统的软件用户界面和使用流程都是相同的。

---

**备注：**本文使用的图片素材来自于 Ubuntu 16.04 LTS 上 Eclipse Neon 3 软件的截图，不同的操作系统（Windows、macOS 或 Linux）或不同的 Eclipse 软件版本在用户界面上可能会有细微差别。

---

### 4.16.2 工作原理

通过 JTAG (Joint Test Action Group) 接口使用 OpenOCD 调试 ESP32-H2 时所需要的关键软件和硬件包括 `riscv32-esp-elf-gdb` 调试器、OpenOCD 片上调试器和连接到 ESP32-H2 目标的 JTAG 适配器，如下图

“Application Loading and Monitoring” 标志所示。



图 25: JTAG 调试 - 概述图

“Application Loading and Monitoring” 标志显示一组关键的软件和硬件组件，可用于编译、构建和烧写应用程序到 ESP32-H2 上，以及监视来自 ESP32-H2 的运行诊断信息。

Eclipse 环境集成了 JTAG 调试和应用程序加载、监视的功能，使得软件从编写、编译、加载到调试的迭代过程变得更加快速简单。Eclipse IDE 及其集成的调试软件均适用于 Windows、Linux 和 macOS 平台。根据用户喜好，除了使用 Eclipse 集成开发环境，还可以直接在命令行终端运行 *debugger* 和 *idf.py build*。

仅需一根 USB 线即可高效连接 PC 与 ESP32-H2，因为 ESP32-H2 芯片本身提供了两路 USB 通道，一路连接到 JTAG，另一路连接到 USB 终端。应将 USB 线连接到 ESP32-H2 的 D+/D- USB 管脚，而非通过 USB-UART 芯片连接到串行 RxD/TxD。后文中配置 [ESP32-H2 目标板](#) 小节将对此进行解释。

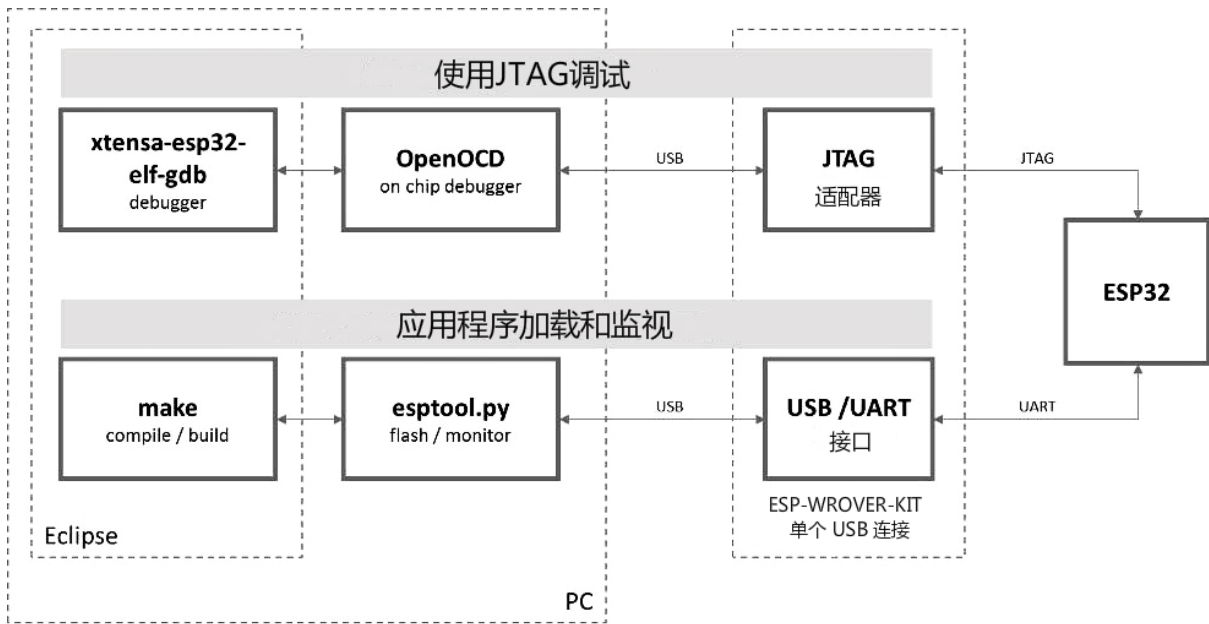
### 4.16.3 选择 JTAG 适配器

上手 JTAG 最快速便捷的方式是将一根 USB 线连接到 ESP32-H2 的 D+/D- USB 管脚，无需使用外部 JTAG 适配器和额外线缆。

如果想使用单独的 JTAG 适配器，请确保其与 ESP32-H2 的电平电压和 OpenOCD 软件都兼容。ESP32-H2 使用的是业界标准的 JTAG 接口，它未使用（实际上也不需要）TRST 信号脚。JTAG 使用的 IO 管脚由 VDD\_3P3\_RTC 电源管脚供电（通常连接到外部 3.3 V 的电源轨），因此 JTAG 硬件适配器的管脚需要能够在该电压范围内正常工作。

在软件方面，OpenOCD 支持相当多数量的 JTAG 适配器，请参阅 [OpenOCD 支持的适配器列表](#)（请注意这一列表并不完整），其中还列出了兼容 SWD 接口的适配器，但请注意，ESP32-H2 目前并不支持 SWD。此外，硬编码为只支持特定产品线的 JTAG 适配器也无法在 ESP32-H2 上工作，例如仅针对 STM32 系列产品的 ST-LINK 适配器。

保证 JTAG 正常工作需要连接的信号线包括：TDI、TDO、TCK、TMS 和 GND。一些 JTAG 适配器还需要 ESP32-H2 提供一路电源到适配器的某个管脚上（比如 Vtar），用于设置适配器的工作电压。也可以选择将 SRST 信号线连接到 ESP32-H2 的 CH\_PD 管脚上，但请注意，目前 OpenOCD 对该信号线提供的支持相当有限。

ESP-Prog 中展示了使用外部电路板进行调试的实例，方法是将其连接到 ESP32-H2 的 JTAG 管脚上。

## 4.16.4 安装 OpenOCD

如果已经按照[快速入门](#)完成了 ESP-IDF 及其 CMake 构建系统的安装，那么 OpenOCD 已经被默认安装到了你的开发系统中。在[设置开发环境](#)结束后，应该能够在终端中运行如下 OpenOCD 命令：

```
openocd --version
```

终端会输出以下信息（实际版本号可能会更新）：

```
Open On-Chip Debugger v0.12.0-esp32-20240318 (2024-03-18-18:25)
Licensed under GNU GPL v2
For bug reports, read
    http://openocd.org/doc/doxygen/bugs.html
```

你还可以检查 OPENOCD\_SCRIPTS 环境变量的值，以确认 OpenOCD 配置文件的路径，Linux 和 macOS 用户可以在终端输入 `echo $OPENOCD_SCRIPTS`，Windows 用户需要输入 `echo %OPENOCD_SCRIPTS%`。如果终端输出了有效路径，则表明已经正确安装 OpenOCD。

如果无法执行上述步骤，请再次阅读快速入门手册，Linux 和 macOS 用户请参考[设置安装工具](#) 章节，Windows 用户请参考[ESP-IDF 工具安装器](#)。

**备注：**另外也可以从源代码编译 OpenOCD 工具，详细信息请参阅[从源码构建 OpenOCD](#) 章节。

## 4.16.5 配置 ESP32-H2 目标板

OpenOCD 安装完成后就可以配置 ESP32-H2 目标（即带 JTAG 接口的 ESP32-H2 板），具体分为以下三个步骤：

- [配置并连接 JTAG 接口](#)
- [运行 OpenOCD](#)
- [上传待调试的应用程序](#)

### 配置并连接 JTAG 接口

此步骤取决于使用的 JTAG 和 ESP32-H2 板，请参考以下两种情况。

#### 配置 ESP32-H2 内置 JTAG 接口

ESP32-H2 配备了内置的 JTAG 电路，无需额外芯片，即可进行调试。只需将 USB 电缆连接到 D+/D- 管脚即可。必要的连接如下所示。

#### 配置硬件

表 23: ESP32-H2 管脚及 USB 信号

ESP32-H2 管脚	USB 信号
GPIO26	D-
GPIO27	D+
5V	V_BUS
GND	接地

请不要将用于 USB 通信的 ESP32-H2 管脚连接到可能会干扰 JTAG 操作的其他硬件上。

**配置 USB 驱动程序** JTAG 通信在所有支持的平台上都可工作。Windows 用户可能会遇到 `LIBUSB_ERROR_NOT_FOUND` 错误。请使用 2.8 版本（或更新版本）的 [ESP-IDF 工具安装器](#)，并选择驱动程序“Espressif - WinUSB 支持 JTAG (ESP32-C3/S3)”以解决此问题。如果您不想重新运行安装程序，则可以通过 `idf-env` 实现相同的效果。请在 PowerShell 运行以下命令：

```
Invoke-WebRequest 'https://dl.espressif.com/dl/idf-env/idf-env.exe' -OutFile .\idf-
↪env.exe; .\idf-env.exe driver install --espressif
```

在 Linux 上，需要添加 OpenOCD udev 规则。方法是将以下 [udev 规则文件](#) 放置在 `/etc/udev/rules.d` 文件夹中。

### 配置其他 JTAG 接口

关于适配 OpenOCD 和 ESP32-H2 的 JTAG 接口选择问题，请参考 [选择 JTAG 适配器](#) 章节。然后按照以下步骤进行设置，使其正常工作。

**配置 eFuse** ESP32-H2 JTAG 接口默认连接至内置 [USB\\_SERIAL\\_JTAG](#) 外设。要使用外部 JTAG 适配器，需将 JTAG 接口切换至 GPIO 管脚。你可以使用 `espefuse.py` 工具来烧录 eFuse，以完成接口转换。

- 烧录 `DIS_USB_JTAG` eFuse 后，`USB_SERIAL_JTAG` 和 ESP32-H2 的 JTAG 接口之间的连接将被永久禁用，此后你可以将 JTAG 接口连接到 GPIO2-GPIO5。注意，烧录后，`USB_SERIAL_JTAG` 的 USB CDC 功能仍然可用，即仍然可以通过 USB CDC 进行烧录和查看日志。
- 烧录 `JTAG_SEL_ENABLE` eFuse 后，JTAG 接口的选择将由 `strapping` 管脚 GPIO25 来决定。ESP32-H2 复位时，如果该 `strapping` 管脚为低电平，JTAG 接口将使用 GPIO2-GPIO5；如果为高电平，`USB_SERIAL_JTAG` 将被用作 JTAG 接口。

**警告：** 请注意，烧录 eFuse 是一项不可逆的操作，请在开始前谨慎考虑以上选项。

### 配置硬件

1. 找到 JTAG 接口和 ESP32-H2 板上需要相互连接并建立通信的所有管脚或信号。

表 24: ESP32-H2 pins and JTAG signals

ESP32-H2 Pin	JTAG Signal
MTDO / GPIO3	TDO
MTDI / GPIO5	TDI
MTCK / GPIO4	TCK
MTMS / GPIO2	TMS

2. 检查 ESP32-H2 上用于 JTAG 通信的管脚是否被连接到了其它硬件上，这可能会影响 JTAG 的工作。
3. 连接 ESP32-H2 和 JTAG 接口上的管脚或信号。

**配置驱动** 你可能还需要安装软件驱动，才能使 JTAG 在计算机上正常工作，请参阅你所使用的 JTAG 适配器的有关文档，获取相关详细信息。

在 Linux 中，请务必将 [udev 规则文件](#) 复制到 `/etc/udev/rules.d` 目录中，以添加 OpenOCD udev 规则。

**连接** 将 JTAG 接口连接到计算机，打开 ESP32-H2 和 JTAG 接口板上的电源，然后检查计算机是否可以识别到 JTAG 接口。

如需继续设置调试环境，请前往 [运行 OpenOCD](#) 章节。



## 运行 OpenOCD

配置完目标并将其连接到电脑后，即可启动 OpenOCD。

打开终端，按照快速入门指南中的[设置好开发环境](#)章节进行操作，然后运行如下命令，以启动 OpenOCD (该命令适用于 Windows、Linux 和 macOS)：

```
openocd -f board/esp32h2-builtin.cfg
```

**备注：**上述命令中 `-f` 选项后跟的配置文件专用于 ESP32-H2 through built-in USB connection。基于具体使用的硬件，你可能需要选择不同的配置文件，具体内容请参阅[根据目标芯片配置 OpenOCD](#)。

例如，对于带有用于 JTAG 连接的 FT2232H 或 FT232H 芯片的定制板，或带有 ESP-Prog 的定制板，可使用 `board/esp32h2-ftdi.cfg`。

现在应该可以看到如下输出（此日志来自 ESP32-H2 through built-in USB connection）：

```
user-name@computer-name:~/esp/esp-idf$ openocd -f board/esp32h2-builtin.cfg
Open On-Chip Debugger v0.12.0-esp32-20221026-175-g0f5217b3-dirty (2023-02-02-11:32)
Licensed under GNU GPL v2
For bug reports, read
    http://openocd.org/doc/doxygen/bugs.html
Info : only one transport option; autoselecting 'jtag'
Info : esp_usb_jtag: VID set to 0x303a and PID to 0x1001
Info : esp_usb_jtag: capabilities descriptor set to 0x2000
Warn : Transport "jtag" was already selected
Info : Listening on port 6666 for tcl connections
Info : Listening on port 4444 for telnet connections
Info : esp_usb_jtag: serial (60:55:F9:F7:2C:3F)
Info : esp_usb_jtag: Device found. Base speed 24000KHz, div range 1 to 255
Info : clock speed 24000 kHz
Info : JTAG tap: esp32h2.cpu tap/device found: 0x00010c25 (mfg: 0x612 (Espressif_
↳Systems), part: 0x0010, ver: 0x0)
Info : datacount=2 progbufsize=16
Info : Examined RISC-V core; found 1 harts
Info : hart 0: XLEN=32, misa=0x40903105
Info : starting gdb server for esp32h2 on 3333
Info : Listening on port 3333 for gdb connections
```

- 如果出现指示权限问题的错误，请打开 `~/esp/openocd-esp32` 目录，参阅 OpenOCD README 文件中关于“Permissions delegation”的说明。
- 如果遇到无法找到配置文件的错误，例如 `Can't find board/esp32h2-builtin.cfg`，请检查 `OPENOCD_SCRIPTS` 环境变量是否设置正确，OpenOCD 根据此变量来查找 `-f` 指定的文件，详见[安装 OpenOCD](#)。此外，还需要检查配置文件是否确实位于该路径下。
- 如果出现 JTAG 错误（例如输出为 `...all ones` 或 `...all zeroes`），请检查硬件连接是否正确，除了 ESP32-H2 的管脚之外是否还有其他信号连接到了 JTAG，并查看是否所有器件都已经上电。

## 上传待调试的应用程序

按照正常步骤构建并上传 ESP32-H2 应用程序，具体请参阅[第五步：开始使用 ESP-IDF 吧](#)章节。

除此以外，还可以使用 OpenOCD 通过 JTAG 接口将应用程序镜像烧写到 flash 中，命令如下：

```
openocd -f board/esp32h2-builtin.cfg -c "program_esp filename.bin 0x10000 verify_
↳exit"
```

其中 OpenOCD 的烧写命令 `program_esp` 格式如下：

```
program_esp <image_file> <offset> [verify] [reset] [exit] [compress]
[encrypt]
```

- `image_file` - 程序镜像文件存放的路径
- `offset` - 镜像烧写到 `flash` 中的偏移地址
- `verify` - 烧写完成后校验 `flash` 中的内容 (可选)
- `reset` - 烧写完成后重启目标 (可选)
- `exit` - 烧写完成后退出 `OpenOCD` (可选)
- `compress` - 烧写开始前压缩镜像文件 (可选)
- `encrypt` - 烧写到 `flash` 前加密二进制文件, 与 `idf.py encrypted-flash` 功能相同 (可选)

现在可以调试应用程序了, 请按照以下章节中的步骤进行操作。

### 4.16.6 启动调试器

ESP32-H2 的工具链中带有 GNU 调试器 (简称 GDB), 它和其它工具链软件共同存放于 `riscv32-esp-elf-gdb` 中。除了直接在命令行终端中调用并操作 GDB 外, 也可以在 IDE (例如 Eclipse、Visual Studio Code 等) 中进行调用, 使用图形用户界面间接操作 GDB, 这一方法无需在终端中输入任何命令。

关于调试器的使用方法, 详见以下链接。

- [使用 Eclipse 调试](#)
- [使用命令行调试](#)
- [使用 VS Code 调试](#)

建议首先检查调试器能否在 [命令行终端](#) 下正常工作, 然后再使用 [Eclipse 集成开发环境](#) 进行调试工作。

### 4.16.7 调试范例

本节适用于不熟悉 GDB 的用户, 下文将使用 [get-started/blink](#) 下简单的应用程序来演示 [调试会话的工作流程](#), 同时会介绍以下常用的调试操作:

1. [浏览代码, 查看堆栈和线程](#)
2. [设置和清除断点](#)
3. [手动暂停目标](#)
4. [单步执行代码](#)
5. [查看并设置内存](#)
6. [观察和设置程序变量](#)
7. [设置条件断点](#)

此外还会提供在 [在命令行终端进行调试](#) 下使用 GDB 调试的案例。

---

**备注:** [调试 FreeRTOS 对象](#) 目前仅适用于命令行调试。

---

在演示之前, 请完成 [ESP32-H2 目标板设置并加载 get-started/blink](#) 至 ESP32-H2 中。

### 4.16.8 从源码构建 OpenOCD

以下文档分别介绍了如何在各操作系统平台上从源码构建 OpenOCD。

#### Windows 环境下从源码编译 OpenOCD

---

**备注:** 本文介绍了如何从 OpenOCD 源文件构建二进制文件。如果你想要更快速地构建, 也可以从 [乐鑫 GitHub](#) 直接下载 OpenOCD 的预构建二进制文件, 而无需自己编译 (详细信息, 请参阅 [安装 OpenOCD](#))。

---

---

**备注：** 本文涉及的命令行操作均在装有 MINGW32 子系统的 MSYS2 shell 环境中进行了验证。

---

**安装依赖的软件包** 安装编译 OpenOCD 所需的软件包：

```
pacman -S --noconfirm --needed autoconf automake git make \
mingw-w64-i686-gcc \
mingw-w64-i686-toolchain \
mingw-w64-i686-libtool \
mingw-w64-i686-pkg-config \
mingw-w64-cross-winpthreads-git \
p7zip
```

**下载 OpenOCD 源码** 支持 ESP32-H2 的 OpenOCD 源码可以从乐鑫官方 GitHub 获取，网址为 <https://github.com/espressif/openocd-esp32>。你可以在 Git 中使用以下命令来拉取源代码：

```
cd ~/esp
git clone --recursive https://github.com/espressif/openocd-esp32.git
```

克隆后的源代码保存在 ~/esp/openocd-esp32 目录下。

**下载 libusb** 构建 OpenOCD 需使用 libusb 库。请执行以下命令来下载特定版本的 libusb，并将其解压至当前目录。

```
wget https://github.com/libusb/libusb/releases/download/v1.0.22/libusb-1.0.22.7z
7z x -olibusb ./libusb-1.0.22.7z
```

现在需要导出以下变量，以便将 libusb 库与 OpenOCD 构建相关联。

```
export CPPFLAGS="$CPPFLAGS -I${PWD}/libusb/include/libusb-1.0"
export LDFLAGS="$LDFLAGS -L${PWD}/libusb/MinGW32/.libs/dll"
```

**构建 OpenOCD** 配置和构建 OpenOCD，请参考以下命令：

```
cd ~/esp/openocd-esp32
export CPPFLAGS="$CPPFLAGS -D__USE_MINGW_ANSI_STDIO=1 -Wno-error"; export CFLAGS="
↪$CFLAGS -Wno-error"
./bootstrap
./configure --disable-doxxygen-pdf --enable-ftdi --enable-jlink --enable-ulink --
↪build=i686-w64-mingw32 --host=i686-w64-mingw32
make
cp ../libusb/MinGW32/dll/libusb-1.0.dll ./src
cp /opt/i686-w64-mingw32/bin/libwinpthread-1.dll ./src
```

构建完成后，OpenOCD 的二进制文件将被保存于 ~/esp/openocd-esp32/src/ 目录下。

你也可以调用 `make install`，将其复制到指定位置。

- 你可以在配置 OpenOCD 时指定这一位置，也可以在调用 `make install` 前设置 `export DESTDIR="/custom/install/dir"`。
- 如果你已经安装过其他开发平台的 OpenOCD，请跳过此步骤，否则原来的 OpenOCD 可能会被覆盖。

---

**备注：**

- 如果发生错误，请解决后再次尝试编译，直到 `make` 成功为止。



- 如果 OpenOCD 存在子模块问题，请 cd 到 openocd-esp32 目录，并输入 `git submodule update --init` 命令。
- 如果 `./configure` 成功运行，JTAG 被使能的信息会被打印在 OpenOCD configuration summary 下面。
- 如果你的设备信息未显示在日志中，请根据 `../openocd-esp32/doc/INSTALL.txt` 文中的描述使用 `./configure` 启用它。
- 有关编译 OpenOCD 的详细信息，请参阅 `openocd-esp32/README.Windows`。
- 请记得将 `libusb-1.0.dll` 和 `libwinpthread-1.dll` 从 `~/esp/openocd-esp32/src` 复制到 `OOCD_INSTALLDIR/bin`。

一旦 make 过程完成，OpenOCD 的可执行文件会被保存到 `~/esp/openocd-esp32/src/openocd` 目录下。

**完整编译过程** OpenOCD 编译过程中所调用的所有命令都已包含在以下代码片段中，你可以将其复制到 shell 脚本中，以便快速执行：

```
pacman -S --noconfirm --needed autoconf automake git make mingw-w64-i686-gcc mingw-
↪w64-i686-toolchain mingw-w64-i686-libtool mingw-w64-i686-pkg-config mingw-w64-
↪cross-winpthreads-git p7zip
cd ~/esp
git clone --recursive https://github.com/espressif/openocd-esp32.git

wget https://github.com/libusb/libusb/releases/download/v1.0.22/libusb-1.0.22.7z
7z x -olibusb ./libusb-1.0.22.7z
export CPPFLAGS="$CPPFLAGS -I${PWD}/libusb/include/libusb-1.0"; export LDFLAGS="
↪$LDFLAGS -L${PWD}/libusb/MinGW32/.libs/dll"

export CPPFLAGS="$CPPFLAGS -D__USE_MINGW_ANSI_STDIO=1 -Wno-error"; export CFLAGS="
↪$CFLAGS -Wno-error"
cd ~/esp/openocd-esp32
./bootstrap
./configure --disable-doxygen-pdf --enable-ftdi --enable-jlink --enable-ulink --
↪build=i686-w64-mingw32 --host=i686-w64-mingw32
make
cp ../libusb/MinGW32/dll/libusb-1.0.dll ./src
cp /opt/i686-w64-mingw32/bin/libwinpthread-1.dll ./src

# # optional
# export DESTDIR="$PWD"
# make install
# cp ./src/libusb-1.0.dll $DESTDIR/mingw32/bin
# cp ./src/libwinpthread-1.dll $DESTDIR/mingw32/bin
```

**下一步** 想要进一步配置调试环境，请前往配置 [ESP32-H2 目标板](#) 章节。

## Linux 环境下从源码编译 OpenOCD

除了从 [Espressif 官方](#) 直接下载 OpenOCD 可执行文件，你还可以选择从源码编译得到 OpenOCD。如果想要快速设置 OpenOCD 而不是自行编译，请备份好当前文件，前往 [安装 OpenOCD](#) 章节查阅。

**下载 OpenOCD 源码** 支持 ESP32-H2 的 OpenOCD 源代码可以从乐鑫官方的 GitHub 获得，网址为 <https://github.com/espressif/openocd-esp32>。请使用以下命令来下载源代码：

```
cd ~/esp
git clone --recursive https://github.com/espressif/openocd-esp32.git
```

克隆后的源代码被保存在 `~/esp/openocd-esp32` 目录中。

**安装依赖的软件包** 安装编译 OpenOCD 所需的软件包。

---

**备注:** 依次安装以下软件包, 检查安装是否成功, 然后继续下一个软件包的安装。在进行下一步操作之前, 要先解决当前报告的问题。

---

```
sudo apt-get install make
sudo apt-get install libtool
sudo apt-get install pkg-config
sudo apt-get install autoconf
sudo apt-get install automake
sudo apt-get install texinfo
sudo apt-get install libusb-1.0
```

---

**备注:**

- `pkg-config` 应为 0.2.3 或以上的版本。
  - `autoconf` 应为 2.6.4 或以上的版本。
  - `automake` 应为 1.9 或以上的版本。
  - 当使用 USB-Blaster, ASIX Presto, OpenJTAG 和 FT2232 作为适配器时, 需要下载安装 `libFTDI` 和 `FTD2XX` 的驱动。
  - 当使用 CMSIS-DAP 时, 需要安装 `HIDAPI`。
- 

**构建 OpenOCD** 配置和构建 OpenOCD 的流程如下:

```
cd ~/esp/openocd-esp32
./bootstrap
./configure
make
```

你可以选择最后再执行 `sudo make install`, 如果你已经安装过别的开发平台的 OpenOCD, 请跳过这个步骤, 因为它可能会覆盖掉原来的 OpenOCD。

---

**备注:**

- 如果发生错误, 请解决后再次尝试编译, 直到 `make` 成功为止。
  - 如果 OpenOCD 存在子模块问题, 请 `cd` 到 `openocd-esp32` 目录, 并输入 `git submodule update --init` 命令。
  - 如果 `./configure` 成功运行, JTAG 被使能的信息会被打印在 OpenOCD configuration summary 下面。
  - 如果你的设备信息未显示在日志中, 请根据 `./openocd-esp32/doc/INSTALL.txt` 文中的描述使用 `./configure` 启用它。
  - 有关编译 OpenOCD 的详细信息, 请参阅 `openocd-esp32/README`。
- 

一旦 `make` 过程成功结束, OpenOCD 的可执行文件会被保存到 `~/openocd-esp32/bin` 目录中。

**下一步** 想要进一步配置调试环境, 请前往[配置 ESP32-H2 目标板](#) 章节。

**MacOS 环境下从源码编译 OpenOCD**

除了从 [Espressif 官方](#) 直接下载 OpenOCD 可执行文件，你还可以选择从源码编译得到 OpenOCD。如果想要快速设置 OpenOCD 而不是自行编译，请备份好当前文件，前往 [安装 OpenOCD](#) 章节查阅。

**下载 OpenOCD 源码** 支持 ESP32-H2 的 OpenOCD 源代码可以从乐鑫官方的 GitHub 获得，网址为 <https://github.com/espressif/openocd-esp32>。请使用以下命令来下载源代码：

```
cd ~/esp
git clone --recursive https://github.com/espressif/openocd-esp32.git
```

克隆后的源代码被保存在 ~/esp/openocd-esp32 目录中。

**安装依赖的软件包** 使用 Homebrew 安装编译 OpenOCD 所需的软件包：

```
brew install automake libtool libusb wget gcc@4.9 pkg-config
```

**构建 OpenOCD** 配置和构建 OpenOCD 的流程如下：

```
cd ~/esp/openocd-esp32
./bootstrap
./configure
make
```

你可以选择最后再执行 `sudo make install`，如果你已经安装过别的开发平台的 OpenOCD，请跳过这个步骤，因为它可能会覆盖掉原来的 OpenOCD。

#### 备注：

- 如果发生错误，请解决后再次尝试编译，直到 make 成功为止。
- 发生 Unknown command 'raggedright' 错误可能是因为安装的 texinfo 版本不对，或是由于没有将其添加到 PATH 路径。为了解决该问题，在运行 ./bootstrap 前，请先运行如下命令确保安装合适版本的 texinfo 并将其添加到 PATH 路径：

```
brew install texinfo
export PATH=/usr/local/opt/texinfo/bin:$PATH
```

- 如果 OpenOCD 存在子模块问题，请 cd 到 openocd-esp32 目录，并输入 `git submodule update --init` 命令。
- 如果 ./configure 成功运行，JTAG 被使能的信息会被打印在 OpenOCD configuration summary 下面。
- 如果你的设备信息未显示在日志中，请根据 ../openocd-esp32/doc/INSTALL.txt 文中的描述使用 ./configure 启用它。
- 有关编译 OpenOCD 的详细信息，请参阅 openocd-esp32/README.OSX。

一旦 make 过程成功结束，OpenOCD 的可执行文件会被保存到 ~/esp/openocd-esp32/src/openocd 目录中。

**下一步** 想要进一步配置调试环境，请前往 [配置 ESP32-H2 目标板](#) 章节。

本文档在演示中所使用的 OpenOCD 是预编译好的二进制发行版，在 [安装 OpenOCD](#) 章节中有所介绍。

如果要使用本地从源代码编译的 OpenOCD 程序，需要将相应可执行文件的路径修改为 src/openocd，并设置 OPENOCD\_SCRIPTS 环境变量，使得 OpenOCD 能够找到配置文件。Linux 和 macOS 用户可以执行：

```
cd ~/esp/openocd-esp32
export OPENOCD_SCRIPTS=$PWD/tcl
```

Windows 用户可以执行：

```
cd %USERPROFILE%\esp\openocd-esp32
set "OPENOCD_SCRIPTS=%CD%\tcl"
```

针对 Linux 和 macOS 用户，运行本地编译的 OpenOCD 的示例：

```
src/openocd -f board/esp32h2-builtin.cfg
```

Windows 用户的示例如下：

```
src\openocd -f board/esp32h2-builtin.cfg
```

### 4.16.9 注意事项和补充内容

本节列出了上文中提到的所有注意事项和补充内容的链接。

#### 注意事项和补充内容

本节提供了本指南中各部分提到的一些注意事项和补充内容。

**可用的断点和观察点** ESP32-H2 调试器支持 4 个硬件断点和 64 个软件断点。硬件断点是由 ESP32-H2 芯片内部的逻辑电路实现的，能够设置在代码的任何位置：flash 或者 IRAM 的代码区域。除此以外，OpenOCD 实现了两种软件断点：flash 断点（最多 32 个）和 IRAM 断点（最多 32 个）。目前 GDB 无法在 flash 中设置软件断点，因此除非解决此限制，否则这些断点只能由 OpenOCD 模拟为硬件断点（详细信息可以参阅下文）。ESP32-H2 还支持 4 个观察点，所以可以观察 4 个变量的变化或者通过 GDB 命令 `watch myVariable` 来读取变量的值。请注意 `menuconfig` 中的 `CONFIG_FREERTOS_WATCHPOINT_END_OF_STACK` 选项会使用最后一个观察点，如果你想在 OpenOCD 或者 GDB 中再次尝试使用这个观察点，可能不会得到预期的结果。详情请查看 `menuconfig` 中的帮助文档。

**关于断点的补充知识** 使用软件 flash 模拟部分硬件断点的意思就是当使用 GDB 命令 `hb myFunction` 给某个函数设置硬件断点时，如果该函数位于 flash 中，并且此时还有可用的硬件断点，那调试器就会使用硬件断点，否则就使用 32 个软件 flash 断点中的一个来模拟。这个规则同样适用于 `b myFunction` 之类的命令，在这种情况下，GDB 会自己决定该使用哪种类型的断点。如果 `myFunction` 位于可写区域 (IRAM)，那就会使用软件 IRAM 断点，否则就会像处理 `hb` 命令一样使用硬件断点或者软件 flash 断点。

**flash 映射 vs 软件 flash 断点** 为了在 flash 中设置或者清除软件断点，OpenOCD 需要知道它们在 flash 中的地址。为了完成从 ESP32-H2 的地址空间到 flash 地址的转换，OpenOCD 使用 flash 中程序代码区域的映射。这些映射被保存在程序映像的头部，位于二进制数据（代码段和数据段）之前，并且特定于写入 flash 的每一个应用程序的映像。因此，为了支持软件 flash 断点，OpenOCD 需要知道待调试的应用程序映像的位置。默认情况下，OpenOCD 会在 0x8000 处读取分区表并使用第一个找到的应用程序映像的映射，但是也可能存在无法工作的情况，比如分区表不在标准的 flash 位置，甚至可能有多个映像：一个出厂映像和两个 OTA 映像，你可能想要调试其中的任意一个。为了涵盖所有可能的调试情况，OpenOCD 支持特殊的命令，用于指定待调试的应用程序映像的具体位置。该命令具有以下格式：

```
esp appimage_offset <offset>
```

偏移量应为十六进制格式，如果要恢复默认行为，可以将偏移地址设置为 `-1`。

**备注：**由于 GDB 在连接 OpenOCD 时仅仅请求一次内存映射，所以可以在 TCL 配置文件中指定该命令，或者通过命令行传递给 OpenOCD。对于后者，命令行示例如下：

```
openocd -f board/esp32h2-builtin.cfg -c "init; halt; esp appimage_offset 0x210000"
```

另外还可以通过 OpenOCD 的 telnet 会话执行该命令，然后再连接 GDB，不过这种方式似乎没有那么便捷。

**“next”命令无法跳过子程序的原因** 当使用 next 命令单步执行代码时，GDB 会在子程序的前面设置一个断点，这样就可以跳过进入子程序内部的细节。如果 4 个断点都已经设置好，那么 next 命令将不起作用。在这种情况下，请删掉其他断点以使其中一个变得可用。当所有断点都已经被使用时，next 命令会像 step 命令一样工作，调试器就会进入子程序内部。

**OpenOCD 支持的编译时的选项** ESP-IDF 有一些针对 OpenOCD 调试功能的选项可以在编译时进行设置：

- `CONFIG_ESP_DEBUG_OCDAWARE` 默认会被使能。如果程序抛出了不可修复或者未处理的异常，并且此时已经连接上了 JTAG 调试器（即 OpenOCD 正在运行），那么 ESP-IDF 将会进入调试器工作模式。
- `CONFIG_FREERTOS_WATCHPOINT_END_OF_STACK` 默认没有使能。在所有任务堆栈的末尾设置观察点，从 1 号开始索引。这是调试任务堆栈溢出的最准确的方式。

更多有关设置编译时的选项的信息，请参阅[项目配置菜单](#)。

**支持 FreeRTOS** OpenOCD 完全支持 ESP-IDF 自带的 FreeRTOS 操作系统，GDB 会将 FreeRTOS 中的任务当做线程。使用 GDB 命令 `i threads` 可以查看所有的线程，使用命令 `thread n` 可以切换到某个具体任务的堆栈，其中 `n` 是线程的编号。检测 FreeRTOS 的功能可以在配置目标时被禁用。更多详细信息，请参阅[根据目标芯片配置 OpenOCD](#)。

GDB 具有 FreeRTOS 支持的 Python 扩展模块。在系统要求满足的情况下，通过 `idf.py gdb` 命令，ESP-IDF 会将该模块自动加载到 GDB 中。详细信息请参考[调试 FreeRTOS 对象](#)。

**优化 JTAG 的速度** 为了实现更高的数据通信速率同时最小化丢包数，建议优化 JTAG 时钟频率的设置，使其达到 JTAG 能稳定运行的最大值。为此，请参考以下建议。

1. 如果 CPU 以 80 MHz 运行，则 JTAG 时钟频率的上限为 20 MHz；如果 CPU 以 160 MHz 或者 240 MHz 运行，则上限为 26 MHz。
2. 根据特定的 JTAG 适配器和连接线缆的长度，你可能需要将 JTAG 的工作频率降低至 20 MHz 或 26 MHz 以下。
3. 在某些特殊情况下，如果你看到 DSR/DIR 错误（并且它并不是由 OpenOCD 试图从一个没有物理存储器映射的地址空间读取数据而导致的），请降低 JTAG 的工作频率。
4. ESP-WROVER-KIT 能够稳定运行在 20 MHz 或 26 MHz 频率下。

**调试器的启动命令的含义** 在启动时，调试器发出一系列命令来复位芯片并使其在特定的代码行停止运行。这个命令序列（如下所示）支持自定义，用户可以选择在最方便合适的代码行开始调试工作。

- `set remote hardware-watchpoint-limit 4` —限制 GDB 使用芯片支持的硬件观察点数量，ESP32-H2 支持 4 个观察点。更多详细信息，请查阅[GDB 配置远程目标](#)。
- `mon reset halt` —复位芯片并使 CPU 停止运行。
- `maintenance flush register-cache` —`monitor (mon)` 命令无法通知 GDB 目标状态已经更改，GDB 会假设在 `mon reset halt` 之前所有的任务堆栈仍然有效。实际上，复位后目标状态将发生变化。执行 `maintenance flush register-cache` 是一种强制 GDB 从目标获取最新状态的方法。
- `thb app_main` —在 `app_main` 处插入一个临时的硬件断点，如果有需要，可以将其替换为其他函数名。
- `c` —恢复程序运行，它将会在 `app_main` 的断点处停止运行。

**根据目标芯片配置 OpenOCD** OpenOCD 有很多种配置文件 (\*.cfg)，它们位于 OpenOCD 安装目录的 `share/openocd/scripts` 子目录中（或者在 OpenOCD 源码目录的 `tcl/scripts` 目录中）。本文主要介绍 `board`，`interface` 和 `target` 这三个目录。



- `interface` 包含了例如 ESPProg、J-Link 这些 JTAG 适配器的配置文件。
- `target` 包含了目标芯片或者模组的配置文件。
- `board` 包含有内置了 JTAG 适配器的开发板的配置文件，这些配置文件会根据实际的 JTAG 适配器和芯片/模组来导入某个具体的 `interface` 和 `target` 的配置。

ESP32-H2 可以使用的配置文件如下表所示:

表 25: OpenOCD configuration files for ESP32-H2

Name	Description
<code>board/esp32h2-builtin.cfg</code>	Board configuration file for ESP32-H2 through built-in USB, includes target and adapter configuration.
<code>board/esp32h2-ftdi.cfg</code>	Board configuration file for ESP32-H2 for via externally connected FTDI-based probe like ESP-Prog, includes target and adapter configuration.
<code>target/esp32h2.cfg</code>	ESP32-H2 target configuration file. Can be used together with one of the <code>interface/</code> configuration files.
<code>interface/esp_usb_jtag.cfg</code>	JTAG adapter configuration file for ESP32-H2.
<code>interface/ftdi/esp32_devkitj_v1.cfg</code>	JTAG adapter configuration file for ESP-Prog boards.

如果你使用的开发板已经有了一份预定义好的配置文件，你只须将该文件通过 `-f` 参数告诉 OpenOCD。

如果你的开发板不在上述列表中，你需要使用多个 `-f` 参数来告诉 OpenOCD 你选择的 `interface` 和 `target` 配置文件。

**自定义配置文件** OpenOCD 的配置文件是用 TCL 语言编写的，包含了定制和编写脚本的各种选项。这在非标准调试的场景中非常有用，更多关于 TCL 脚本的内容请参考 [OpenOCD 参考手册](#)。

**OpenOCD 中的配置变量** 你还可以视情况在导入 `target` 配置文件之前，设定如下变量的值。可以写在自定义配置文件中，或者通过命令行传递。

TCL 语言中为变量赋值的语法是:

```
set VARIABLE_NAME value
```

在命令行中为变量赋值请参考如下示例（请把 `.cfg` 配置文件替换成你自己的开发板配置）：

```
openocd -c 'set VARIABLE_NAME value' -f board/esp-xxxxx-kit.cfg
```

请切记，一定要在导入配置文件之前设置这些变量，否则变量的值将不会生效。为多个变量赋值需要重复多次 `-c` 选项。

表 26: 通用的 ESP 相关的 OpenOCD 变量

变量名	描述
<code>ESP_RTOS</code>	设置成 <code>none</code> 可以关闭 OpenOCD 对 RTOS 的支持，这样的话，你将无法在 GDB 中查看到线程列表。这个功能在调试 FreeRTOS 本身的时候会很有用，可以单步调试调度器的代码。
<code>ESP_FLASH_SIZE</code>	设置成 <code>0</code> 可以关闭对 flash 断点的支持。
<code>ESP_SEMIHOST_BASED</code>	设置 <code>semihosting</code> 在主机端的默认目录。

**复位 ESP32-H2** 通过在 GDB 中输入 `mon reset` 或者 `mon reset halt` 来复位板子。

**JTAG 管脚是否能用于其他功能** ESP32-H2 包含一个可用于调试的 USB Serial/JTAG 控制器。默认情况下，ESP32-H2 JTAG 接口连接到内置的外设 USB Serial/JTAG。详细信息可参阅[配置 ESP32-H2 内置 JTAG 接口](#)。

如果 USB Serial/JTAG 控制器用于调试，GPIO2-GPIO5 可用于其他功能。

如果用户通过烧录 eFuse 将 USB JTAG 接口切换为 GPIO，GPIO2-GPIO5 则可用于 JTAG 调试，但用于 JTAG 调试的 GPIO2-GPIO5 不能再用于其他功能。

如果除了 ESP32-H2 模组和 JTAG 适配器之外的其他硬件也连接到了 JTAG 管脚，那么 JTAG 的操作可能会受到干扰。ESP32-H2 JTAG 使用以下管脚：

表 27: ESP32-H2 pins and JTAG signals

ESP32-H2 Pin	JTAG Signal
MTDO / GPIO3	TDO
MTDI / GPIO5	TDI
MTCK / GPIO4	TCK
MTMS / GPIO2	TMS

如果用户应用程序更改了 JTAG 管脚的配置，JTAG 通信可能会失败。如果 OpenOCD 正确初始化（检测到芯片全部 CPU 内核），但在程序运行期间失去了同步并报出大量 DTR/DIR 错误，原因可能是应用程序将 JTAG 管脚重新配置为其他功能或者用户忘记将 Vtar 连接到 JTAG 适配器。

**JTAG 与 flash 加密和安全引导** 默认情况下，开启了 flash 加密和（或者）安全引导后，系统在首次启动时，引导程序会烧写 eFuse 的某个比特，从而将 JTAG 永久关闭。

请注意，一旦 JTAG 被永久禁用，就无法重新启用以访问 JTAG。但是我们也提供了暂时禁用 (soft disable) JTAG 的选项。有关如何暂时禁用以及重新启用 JTAG，请参考[HMAC 启用 JTAG 接口](#)。

Kconfig 配置项 `CONFIG_SECURE_BOOT_ALLOW_JTAG` 可以改变这个默认行为，使得用户即使开启了安全引导或者 flash 加密，仍会保留 JTAG 的功能。

然而，因为设置软件断点的需要，OpenOCD 会尝试自动读写 flash 中的内容，这会带来两个问题：

- 软件断点和 flash 加密是不兼容的，目前 OpenOCD 尚不支持对 flash 中的内容进行加密和解密。
- 如果开启了安全引导功能，设置软件断点会改变被签名的程序的摘要，从而使得签名失效。这也意味着，如果设置了软件断点，系统会在下次重启时的签名验证阶段失败，导致无法启动。

关闭 JTAG 的软件断点功能，可以在启动 OpenOCD 时在命令行额外加一项配置参数 `-c 'set ESP_FLASH_SIZE 0'`，请参考[OpenOCD 中的配置变量](#)。

---

**备注：**同样地，当启用该选项，并且在调试过程中设置了软件断点，引导程序将无法校验通过应用程序的签名。

---

**报告 OpenOCD/GDB 的问题** 如果你遇到 OpenOCD 或者 GDB 程序本身的问题，并且在网上没有找到可行的解决方案，请前往 <https://github.com/espressif/openocd-esp32/issues> 新建一个议题。

1. 请在问题报告中提供你使用的配置的详细信息：
  - a. JTAG 适配器类型。
  - b. 用于编译和加载正在调试的应用程序的 ESP-IDF 版本号。
  - c. 用于调试的操作系统的相关信息。
  - d. 操作系统是在本地计算机运行还是在虚拟机上运行？
2. 创建一个能够演示问题的简单示例工程，描述复现该问题的步骤。且这个调试示例不能受到 Wi-Fi 协议栈引入的非确定性行为的影响，这样再次遇到同样问题时，更容易复现。
3. 在启动命令中添加额外的参数来输出调试日志。  
OpenOCD 端：

```
openocd -l openocd_log.txt -d3 -f board/esp32h2-builtin.cfg
```

这种方式会将日志输出到文件，但是它会阻止调试信息打印在终端上。当有大量信息需要输出的时候（比如调试等级提高到 `-d3`）这是个不错的选择。如果你仍然希望在屏幕上看到调试日志，请改用以下命令：

```
openocd -d3 -f board/esp32h2-builtin.cfg 2>&1 | tee openocd.log
```

Debugger 端：

```
riscv32-esp-elf-gdb -ex "set remotelogfile gdb_log.txt" <all other options>
```

也可以将命令 `remotelogfile gdb_log.txt` 添加到 `gdbinit` 文件中。

4. 请将 `openocd_log.txt` 和 `gdb_log.txt` 文件附在你的问题报告中。

## 4.16.10 相关文档

### 使用调试器

本节介绍以下几种配置和运行调试器的方法：

- 使用 [Eclipse 调试](#)
- 使用 [命令行调试](#)
- 使用 [idf.py 进行调试](#)

关于如何使用 VS Code 进行调试，请参阅文档 [使用 VS Code 调试](#)。

### 使用 Eclipse 调试

**备注：** 建议首先通过 [idf.py](#) 或 [命令行](#) 检查调试器是否正常工作，然后再转到使用 [Eclipse](#) 平台。

作为一款集成开发环境 (IDE)，Eclipse 提供了一套强大的工具，用于开发和调试软件应用程序。对于 ESP-IDF 应用程序，[IDF Eclipse 插件](#) 提供了两种调试方式：

1. [ESP-IDF GDB OpenOCD 调试](#)
2. [GDB 硬件调试](#)

默认情况下，Eclipse 通过 GDB 硬件调试插件支持 OpenOCD 调试。该调试方式需要从命令行启动 OpenOCD 服务器，并在 Eclipse 中配置 GDB 客户端，整个过程耗时且容易出错。

为了使调试过程更加容易，[IDF Eclipse 插件](#) 提供了定制的 ESP-IDF GDB OpenOCD 调试功能，支持在 Eclipse 内部配置好 OpenOCD 服务器和 GDB 客户端。该插件已经设置好所有必需的配置参数，点击一个按钮即可开始调试。

因此，建议通过 [IDF Eclipse 插件](#) 进行 [ESP-IDF GDB OpenOCD 调试](#)。

### GDB 硬件调试

**备注：** 只有在无法使用 [ESP-IDF GDB OpenOCD 调试](#) 的情况下，才建议使用 GDB 硬件调试。

首先，打开 Eclipse，选择 `Help > Install New Software` 来安装 GDB Hardware Debugging 插件。

安装完成后，按照以下步骤配置调试会话。请注意，一些配置参数是通用的，有些则针对特定项目。我们会通过配置“blink”示例项目的调试环境来进行展示，请先按照 [Eclipse Plugin](#) 介绍的方法将该示例项目添加到 Eclipse 的工作空间。示例项目 [get-started/blink](#) 的源代码可以在 ESP-IDF 仓库的 [examples](#) 目录下找到。

1. 在 Eclipse 中，进入 `Run > Debug Configuration`，会出现一个新的窗口。在窗口的左侧窗格中，双击 GDB Hardware Debugging（或者选择 GDB Hardware Debugging 然后按下 New 按钮）来新建一个配置。



2. 在右边显示的表单中，Name：一栏中输入配置的名称，例如：“Blink checking”。
  3. 在下面的 Main 选项卡中，点击 Project：边上的 Browse 按钮，然后选择当前的 blink 项目。
  4. 在下一行的 C/C++ Application：中，点击 Browse 按钮，选择 blink.elf 文件。如果 blink.elf 文件不存在，那么很有可能该项目还没有编译，请参考 [Eclipse Plugin](#) 指南中的介绍。
  5. 最后，在 Build (if required) before launching 下面点击 Disable auto build。
- 上述步骤 1 - 5 的示例输入如下图所示。



图 26: GDB 硬件调试的配置 - Main 选项卡

6. 点击 Debugger 选项卡，在 GDB Command 栏中输入 riscv32-esp-elf-gdb 来调用调试器。
  7. 更改 Remote host 的默认配置，在 Port number 下面输入 3333。
- 上述步骤 6 - 7 的示例输入如下图所示。
8. 最后一个需要更改默认配置的选项卡是 Startup 选项卡。在 Initialization Commands 下，取消选中 Reset and Delay (seconds) 和 Halt，然后在下面一栏中输入以下命令：

```
mon reset halt
maintenance flush register-cache
set remote hardware-watchpoint-limit 2
```

**备注：** 如果想在启动新的调试会话之前自动更新闪存中的镜像，请在 Initialization Commands 文本框的开头添加以下命令行：

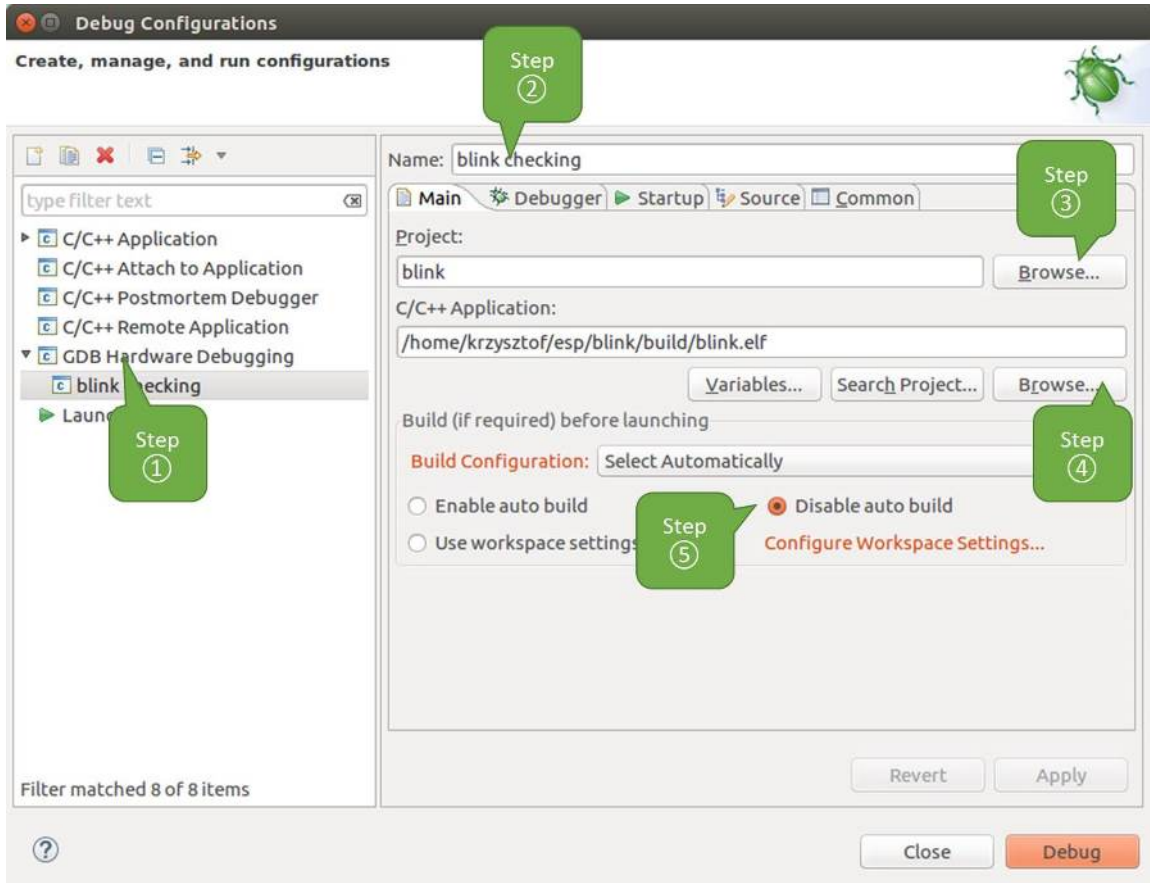
```
mon reset halt
mon program_esp ${workspace_loc:blink/build/blink.bin} 0x10000 verify
```

有关 program\_esp 命令的说明请参考 [上传待调试的应用程序](#) 章节。

9. 在 Load Image and Symbols 下，取消选中 Load image 选项。
10. 在同一个选项卡中继续往下浏览，建立一个初始断点用来在调试器复位后暂停 CPU。插件会根据 Set break point at：一栏中输入的函数名，在该函数的开头设置断点。选中这一选项，并在相应的字段中输入 app\_main。



图 27: GDB 硬件调试的配置 - Debugger 选项卡

- 选中 Resume 选项，这会使得程序在每次调用步骤 8 中的 `mon reset halt` 后恢复，然后在 `app_main` 的断点处停止。  
上述步骤 8 - 11 的示例输入如下图所示。

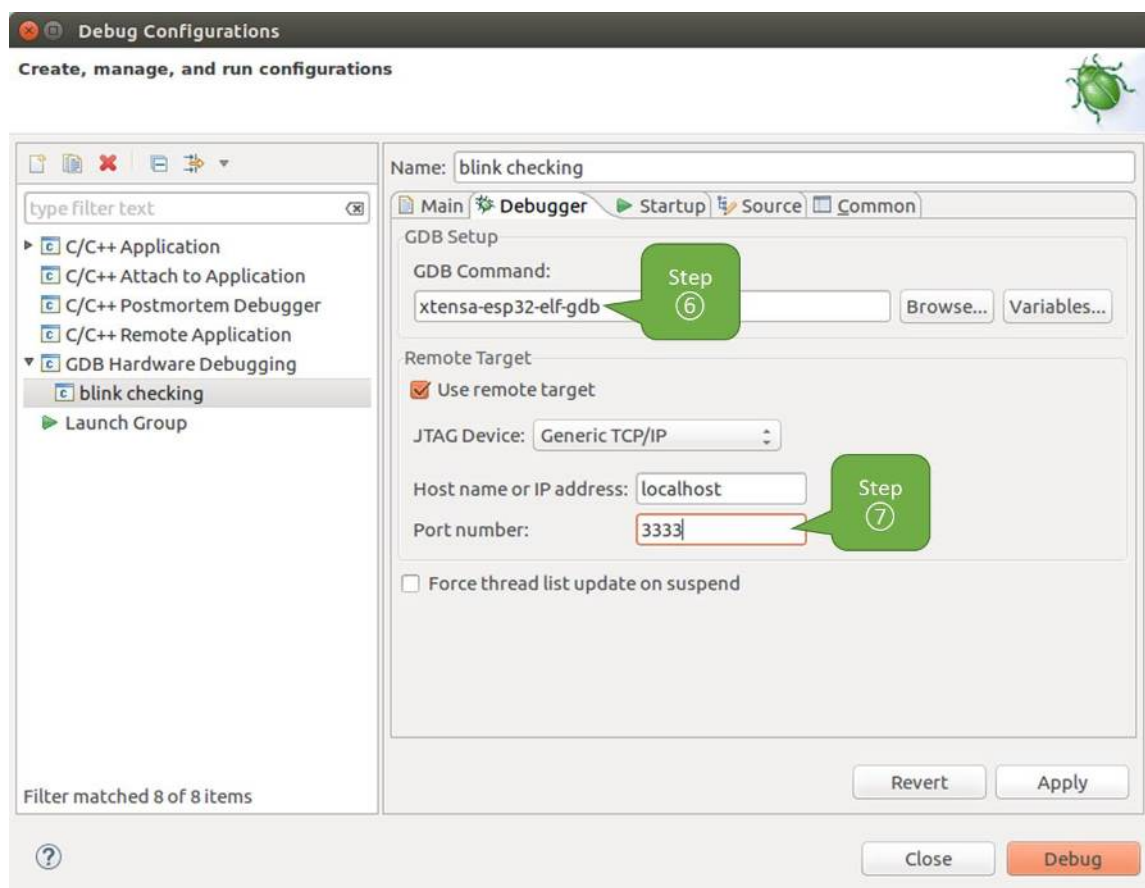

图 28: GDB 硬件调试的配置 - Startup 选项卡

上面的启动序列看起来有些复杂，如果你对其中的初始化命令不太熟悉，请查阅[调试器的启动命令的含义](#)章节获取更多说明。

- 如果前面已经完成[配置 ESP32-H2 目标板](#)中介绍的步骤，目标正在运行并准备好与调试器进行对话，那么点击 `Debug` 按钮直接进行调试。如果尚未完成前面步骤，请点击 `Apply` 按钮保存配置，返回[配置 ESP32-H2 目标板](#)章节进行配置，最后再回到这里开始调试。

一旦所有 1-12 的配置步骤都已经完成，Eclipse 就会打开 Debug 视图，如下图所示。

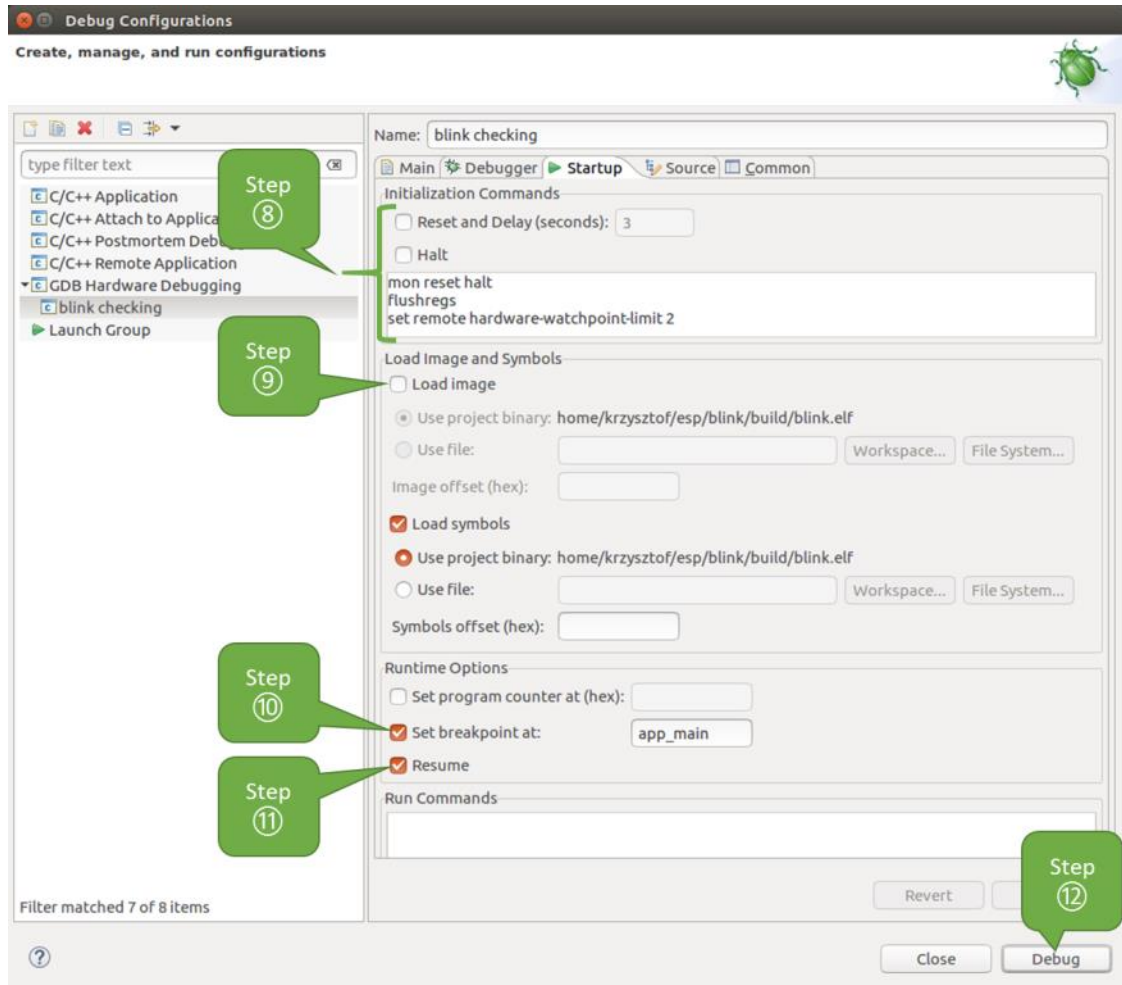
如果不太了解 GDB 的常用方法，请查阅[使用 Eclipse 的调试示例](#)文章中的调试示例章节[调试范例](#)。

### 使用命令行调试

- 为了能够启动调试会话，需要先启动并运行目标，如果还没有完成，请按照[配置 ESP32-H2 目标板](#)中的介绍进行操作。
- 打开一个新的终端会话并前往待调试的项目目录，比如：

```
cd ~/esp/blink
```

- 当启动调试器时，通常需要提供几个配置参数和命令，为了避免每次都在命令行中逐行输入这些命令，你可以新建一个配置文件，并将其命名为 `gdbinit`：



图 29: Eclipse 中的调试视图

```
target remote :3333
set remote hardware-watchpoint-limit 2
mon reset halt
maintenance flush register-cache
thb app_main
c
```

将此文件保存在当前目录中。

有关 gdbinit 文件内部的更多详细信息，请参阅[调试器的启动命令的含义](#) 章节。

4. 准备好启动 GDB，请在终端中输入以下内容：

```
riscv32-esp-elf-gdb -x gdbinit build/blink.elf
```

5. 如果前面的步骤已经正确完成，你会看到如下所示的输出日志，在日志的最后会出现 (gdb) 提示符：

```
user-name@computer-name:~/esp/blink$ riscv32-esp-elf-gdb -x gdbinit build/
↳blink.elf
GNU gdb (crosstool-NG crosstool-ng-1.22.0-61-gab8375a) 7.10
Copyright (C) 2015 Free Software Foundation, Inc.
License GPLv3+: GNU GPL version 3 or later <http://gnu.org/licenses/gpl.html>
This is free software: you are free to change and redistribute it.
There is NO WARRANTY, to the extent permitted by law. Type "show copying"
and "show warranty" for details.
This GDB was configured as "--host=x86_64-build_pc-linux-gnu --target=riscv32-
↳esp-elf".
Type "show configuration" for configuration details.
For bug reporting instructions, please see:
<http://www.gnu.org/software/gdb/bugs/>.
Find the GDB manual and other documentation resources online at:
<http://www.gnu.org/software/gdb/documentation/>.
For help, type "help".
Type "apropos word" to search for commands related to "word"...
Reading symbols from build/blink.elf...done.
0x400d10d8 in esp_vApplicationIdleHook () at /home/user-name/esp/esp-idf/
↳components/esp32h2/./freertos_hooks.c:52
52      asm("waiti 0");
JTAG tap: esp32h2.cpu0 tap/device found: 0x120034e5 (mfg: 0x272 (Tensilica),
↳part: 0x2003, ver: 0x1)
JTAG tap: esp32h2.slave tap/device found: 0x120034e5 (mfg: 0x272 (Tensilica),
↳part: 0x2003, ver: 0x1)
esp32h2: Debug controller was reset (pwrstat=0x5F, after clear 0x0F).
esp32h2: Core was reset (pwrstat=0x5F, after clear 0x0F).
esp32h2 halted. PRO_CPU: PC=0x5000004B (active) APP_CPU: PC=0x00000000
esp32h2: target state: halted
esp32h2: Core was reset (pwrstat=0x1F, after clear 0x0F).
Target halted. PRO_CPU: PC=0x40000400 (active) APP_CPU: PC=0x40000400
esp32h2: target state: halted
Hardware assisted breakpoint 1 at 0x400db717: file /home/user-name/esp/blink/
↳main/./blink.c, line 43.
0x0: 0x00000000
Target halted. PRO_CPU: PC=0x400DB717 (active) APP_CPU: PC=0x400D10D8
[New Thread 1073428656]
[New Thread 1073413708]
[New Thread 1073431316]
[New Thread 1073410672]
[New Thread 1073408876]
[New Thread 1073432196]
[New Thread 1073411552]
[Switching to Thread 1073411996]

Temporary breakpoint 1, app_main () at /home/user-name/esp/blink/main/./blink.
↳c:43
```

(下页继续)



```
43     xTaskCreate(&blink_task, "blink_task", 512, NULL, 5, NULL);
(gdb)
```

注意上面日志的倒数第三行显示了调试器已经在 `app_main()` 函数的断点处停止，该断点在 `gdbinit` 文件中设定。由于处理器已经暂停运行，LED 不会再闪烁。如果你的 LED 也停止了闪烁，则可以开始调试。

如果不太了解 GDB 的常用方法，请查阅[使用命令行的调试示例](#)文章中的调试示例章节[调试范例](#)。

**使用 idf.py 进行调试** 你还可以使用 `idf.py` 更方便地执行上述提到的调试命令，可以使用以下命令：

1. `idf.py openocd`  
在终端中运行 OpenOCD，其配置信息来源于环境变量或者命令行。默认会使用 `OPENOCD_SCRIPTS` 环境变量中指定的脚本路径，它是由 ESP-IDF 项目仓库中的导出脚本 (`export.sh` 或 `export.bat`) 添加到系统环境变量中的。当然，你可以在命令行中通过 `--openocd-scripts` 参数来覆盖这个变量的值。  
至于当前开发板的 JTAG 配置，请使用环境变量 `OPENOCD_COMMANDS` 或命令行参数 `--openocd-commands`。如果这两者都没有被定义，那么 OpenOCD 会使用 `-f board/esp32h2-builtin.cfg` 参数来启动。
2. `idf.py gdb`  
根据当前项目的 `elf` 文件自动生成 GDB 启动脚本，然后会按照[使用命令行调试](#)中所描述的步骤启动 GDB。
3. `idf.py gdbtui`  
和步骤 2 相同，但是会在启动 GDB 的时候传递 `tui` 参数，这样可以方便在调试过程中查看源代码。
4. `idf.py gdbgui`  
启动 `gdbgui`，在浏览器中打开调试器的前端界面。请在运行安装脚本时添加 `--enable-gdbgui` 参数，即运行 `install.sh --enable-gdbgui`，从而确保支持 `gdbgui` 选项。  
上述这些命令也可以合并到一起使用，`idf.py` 会自动将后台进程（比如 `openocd`）最先运行，交互式进程（比如 GDB，`monitor`）最后运行。  
常用的组合命令如下所示：

```
idf.py openocd gdbgui monitor
```

上述命令会将 OpenOCD 运行至后台，然后启动 `gdbgui` 打开一个浏览器窗口，显示调试器的前端界面，最后在活动终端打开串口监视器。

## 调试示例

本节将介绍如何在 [Eclipse](#) 和 [命令行](#) 中使用 GDB 进行调试的示例。

**使用 Eclipse 的调试示例** 请检查目标板是否已经准备好，并加载了 [get-started/blink](#) 示例代码，然后按照[使用 Eclipse 调试](#)中介绍的步骤配置和启动调试器，最后选择让应用程序在 `app_main()` 建立的断点处停止。

## 本小节的示例

1. 浏览代码，查看堆栈和线程
2. 设置和清除断点
3. 手动暂停目标
4. 单步执行代码
5. 查看并设置内存
6. 观察和设置程序变量
7. 设置条件断点



图 30: Eclipse 中的 Debug 视图

**浏览代码，查看堆栈和线程** 当目标暂停时，调试器会在“Debug”窗口中显示线程的列表，程序暂停的代码行在下面的另一个窗口中被高亮显示，如下图所示。此时板子上的 LED 停止了闪烁。



图 31: 调试时目标停止

暂停的程序所在线程也会被展开，显示函数调用的堆栈，它表示直到目标暂停所在代码行（下图高亮处）为止的相关函数的调用关系。1 号线程下函数调用堆栈的第一行包含了最后一个调用的函数 `app_main()`，根据下一行显示，它又是在函数 `main_task()` 中被调用的。堆栈的每一行还包含调用函数的文件名和行号。通过单击每个堆栈的条目，在下面的窗口中，你将看到此文件的内容。

通过展开线程，你可以浏览整个应用程序。展开 5 号线程，它包含了更长的函数调用堆栈，你可以看到函数调用旁边的数字，比如 `0x4000000c`，它们代表未以源码形式提供的二进制代码所在的内存地址。

无论项目是以源代码还是仅以二进制形式提供，在右边一个窗口中，都可以看到反汇编后的机器代码。

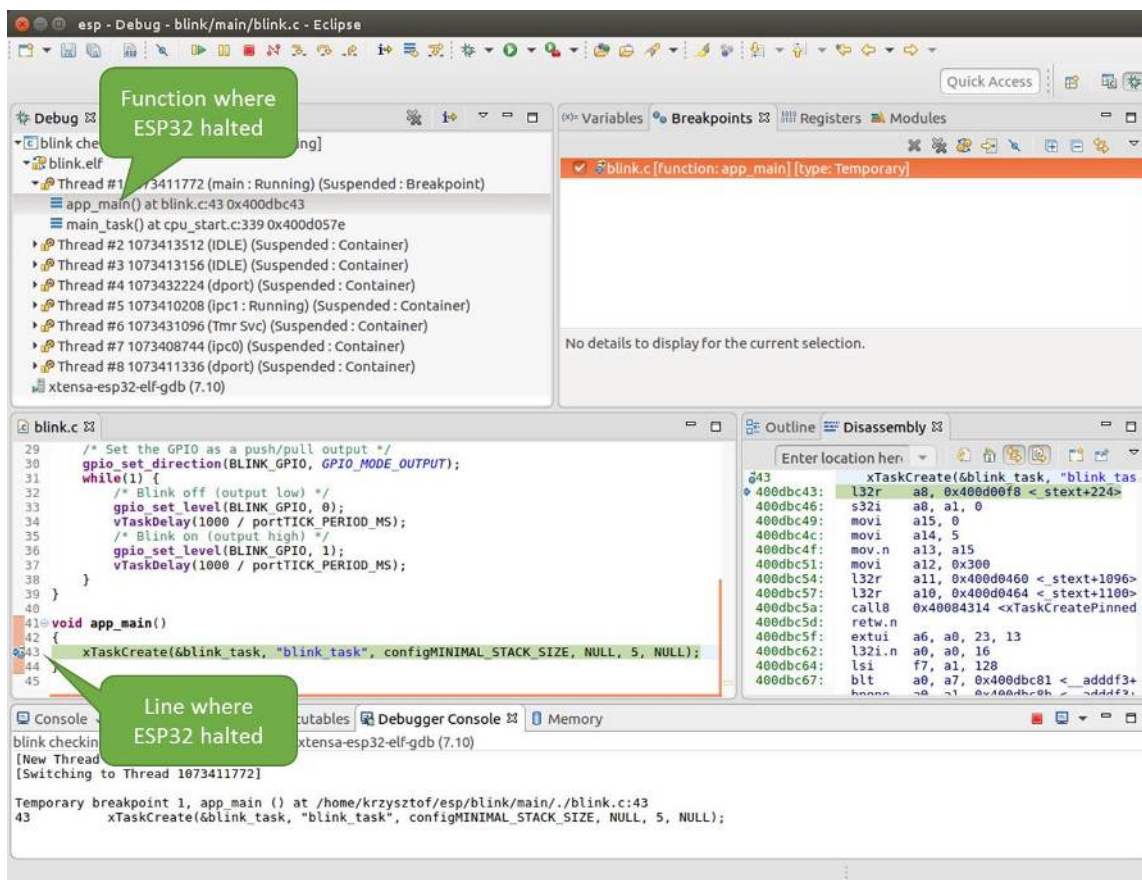
回到 1 号线程中的 `app_main()` 函数所在的 `blinker.c` 源码文件，下面的示例将会以该文件为例介绍调试的常用功能。调试器可以轻松浏览整个应用程序的代码，这给单步调试代码和设置断点带来了很大的便利，下面将一一展开讨论。

**设置和清除断点** 在调试时，我们希望能够在关键的代码行停止应用程序，然后检查特定的变量、内存、寄存器和外设的状态。为此我们需要使用断点，以便在特定某行代码处快速访问和停止应用程序。

我们在控制 LED 状态发生变化的两处代码行分别设置一个断点。基于以上代码列表，这两处分别为第 33 和 36 代码行。按住键盘上的“Control”键，双击 `blinker.c` 文件中的行号 33，并在弹出的对话框中点击“OK”按钮进行确定。如果你不想看到此对话框，双击行号即可。执行同样操作，在第 36 行设置另外一个断点。

断点的数量和位置信息会显示在右上角的“断点”窗口中。单击“Show Breakpoints Supported by Selected Target”图标可以刷新此列表。除了刚才设置的两个断点外，列表中可能还包含在调试器启动时设置在 `app_main()` 函数处的临时断点。由于最多只允许设置两个断点（详细信息请参阅[可用的断点和观察点](#)），你需要将其删除，否则调试会失败。





图 32: 浏览函数调用堆栈



图 33: 设置断点

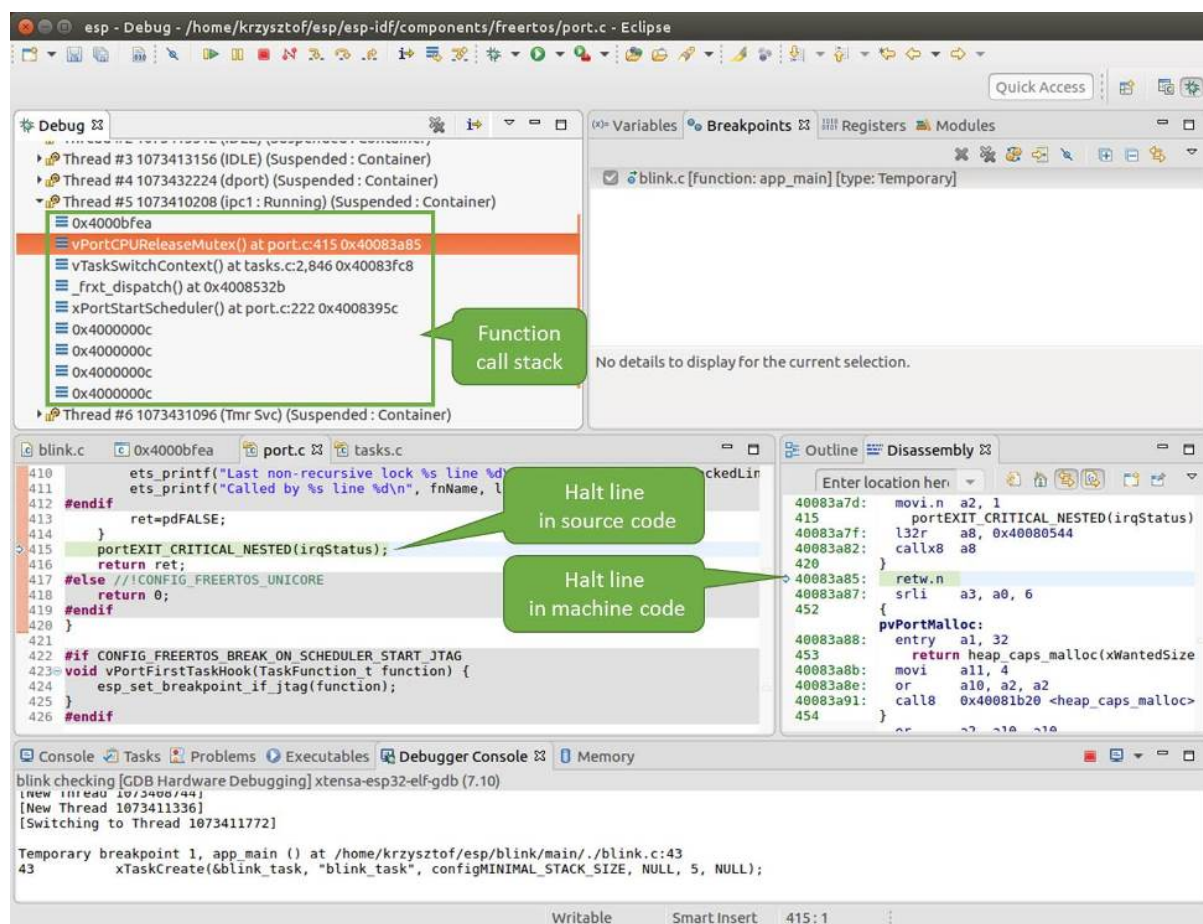

图 34: 设置了三个断点 / 最多允许两个断点

单击“Resume”（如果“Resume”按钮是灰色的，请先单击 8 号线程的 `blink_task()` 函数）后处理器将开始继续运行，并在断点处停止。再一次单击“Resume”按钮，使程序再次运行，然后停在第二个断点处，依次类推。

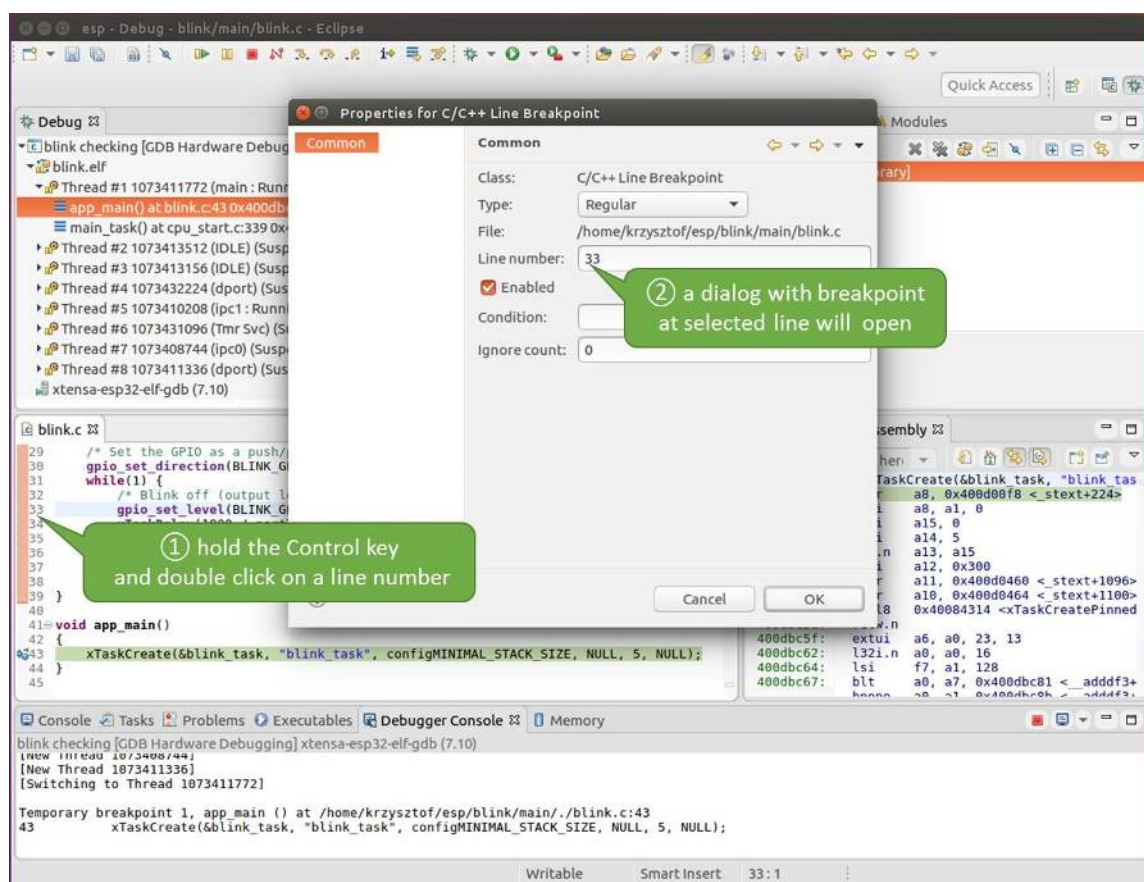
每次单击“Resume”按钮恢复程序运行后，都会看到 LED 切换状态。

更多关于断点的信息，请参阅[可用的断点和观察点](#)和[关于断点的补充知识](#)。

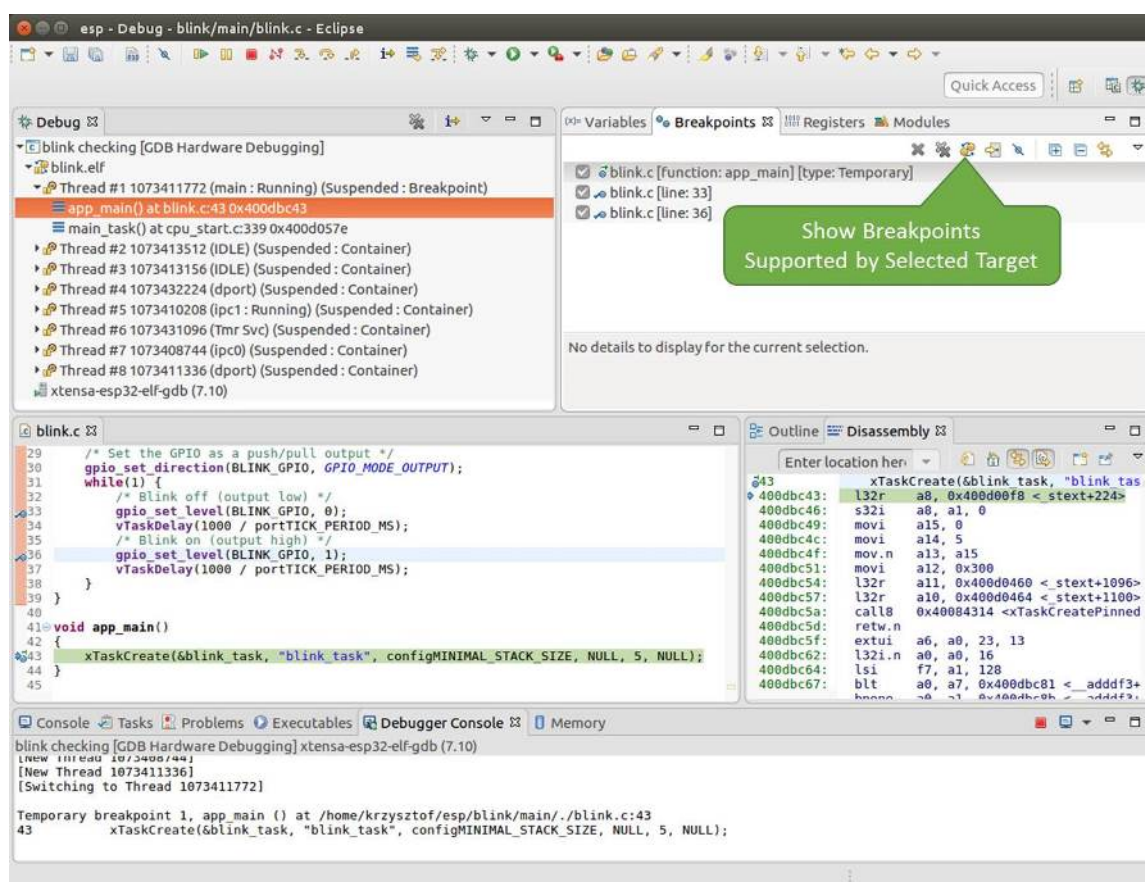
**手动暂停目标** 在调试时，你可以恢复程序运行并输入代码等待某个事件发生或者保持无限循环而不设置任何断点。后者，如果想要返回调试模式，可以通过单击“Suspend”按钮来手动中断程序的运行。

在此之前，请删除所有的断点，然后单击“Resume”按钮。接着单击“Suspend”按钮，应用程序会停止在某个随机的位置，此时 LED 也将停止闪烁。调试器将展开线程并高亮显示停止的代码行。



图 35: 手动暂停目标

在上图所示的情况下，应用程序已经在 `freertos_hooks.c` 文件的第 52 行暂停运行，现在你可以通过单击“Resume”按钮再次将其恢复运行或者进行下面要介绍的调试工作。

**单步执行代码** 我们还可以使用“Step Into (F5)”和“Step Over (F6)”命令单步执行代码，这两者之间的区别是执行“Step Into (F5)”命令会进入调用的子程序，而执行“Step Over (F6)”命令则会直接将子程序看成单个源码行，单步就能将其运行结束。

在继续演示此功能之前，请参照上文所述确保目前只在 `blink.c` 文件的第 36 行设置了一个断点。

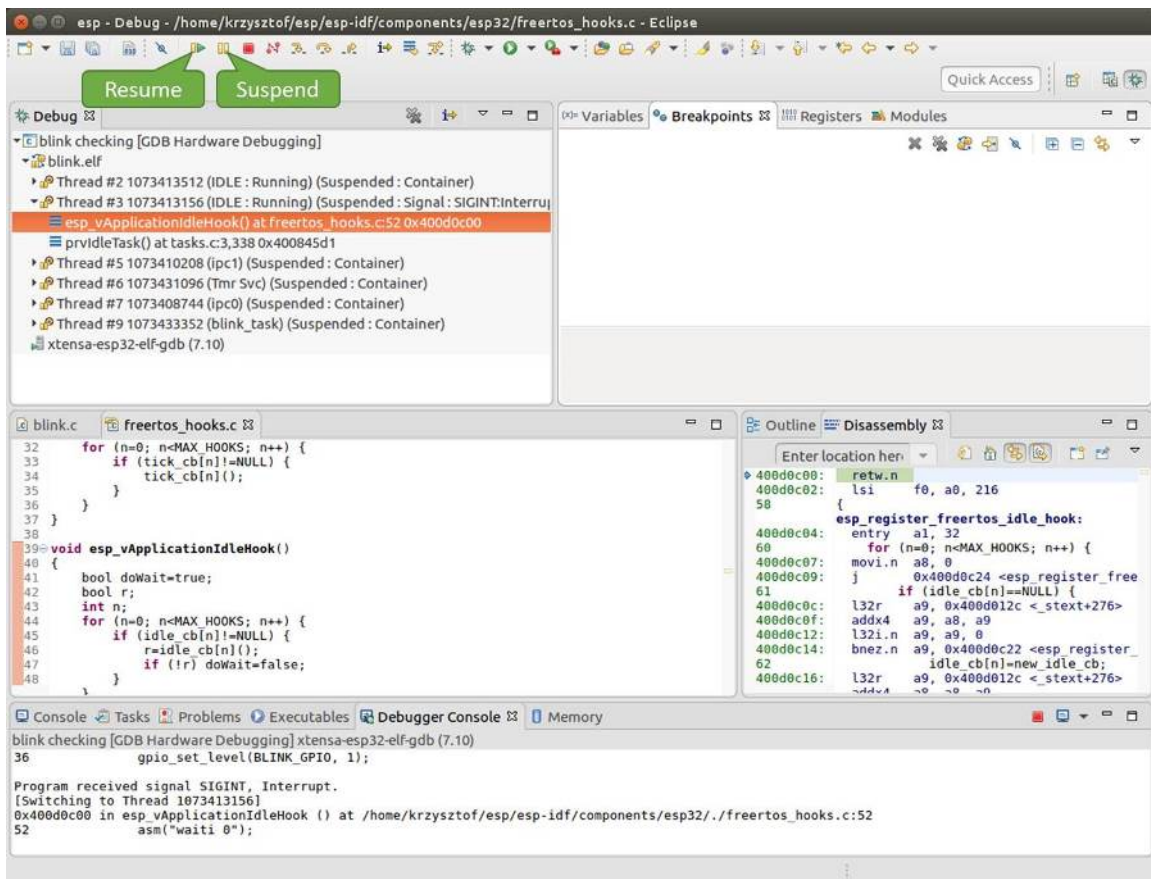
按下 F8 键让程序继续运行然后在断点处停止运行，多次按下“Step Over (F6)”按钮，观察调试器是如何单步执行一行代码的。

如果你改用“Step Into (F5)”，那么调试器将会进入调用的子程序内部。

在上述例子中，调试器进入 `gpio_set_level(BLINK_GPIO, 0)` 代码内部，同时代码窗口快速切换到 `gpio.c` 驱动文件。





图 36: 使用“Step Over (F6)”单步执行代码



图 37: 使用“Step Into (F5)”单步执行代码

请参阅“[next](#)”命令无法跳过子程序的原因 文档以了解 next 命令的潜在局限。

**查看并设置内存** 要显示或者设置内存的内容，请使用“调试”视图中位于底部的“Memory”选项卡。

在“Memory”选项卡下，我们将在内存地址 0x3FF44004 处读取和写入内容。该地址也是 GPIO\_OUT\_REG 寄存器的地址，可以用来控制（设置或者清除）某个 GPIO 的电平。

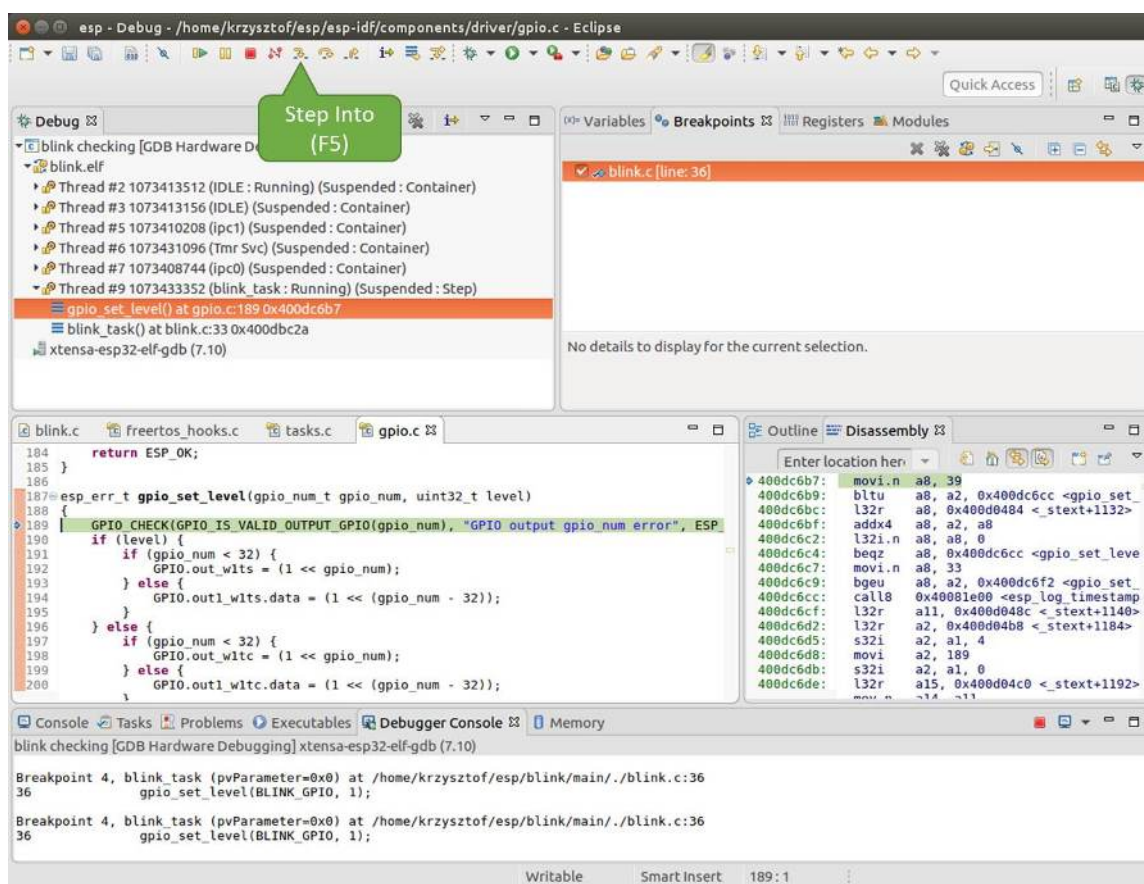
关于该寄存器的更多详细信息，请参阅 *ESP32-H2 技术参考手册 > IO MUX 和 GPIO Matrix (GPIO, IO\_MUX) [PDF]* 章节。

同样在 blink.c 项目文件中，在两个 gpio\_set\_level 语句的后面各设置一个断点，单击“Memory”选项卡，然后单击“Add Memory Monitor”按钮，在弹出的对话框中输入 0x3FF44004。

按下 F8 按键恢复程序运行，并观察“Monitor”选项卡。



图 38: 观察内存地址 0x3FF44004 处的某个比特被置高

每按一下 F8，你就会看到在内存 0x3FF44004 地址处的一个比特位被翻转（并且 LED 会改变状态）。

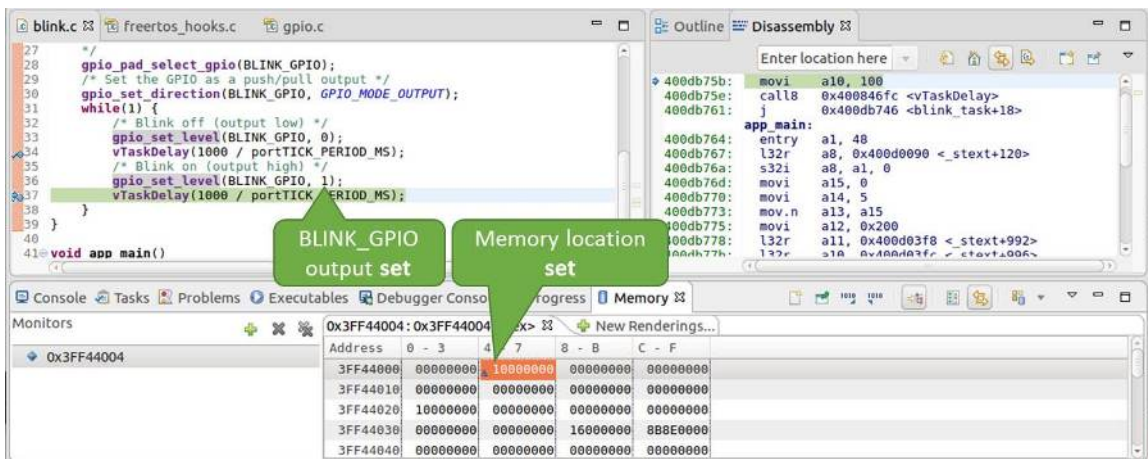

图 39: 观察内存地址 0x3FF44004 处的某个比特被置低

要修改内存的数值，请在“Monitor”选项卡中找到待修改的内存地址，如前面观察的结果一样，输入特定比特翻转后的值。当按下回车键后，将立即看到 LED 的状态发生了改变。

**观察和设置程序变量** 常见的调试任务是在程序运行期间检查程序中某个变量的值，为了演示这个功能，更新 blink.c 文件，在 blink\_task 函数的上面添加一个全局变量的声明 int i，然后在 while(1) 里添加 i++，这样每次 LED 改变状态的时候，变量 i 都会增加 1。

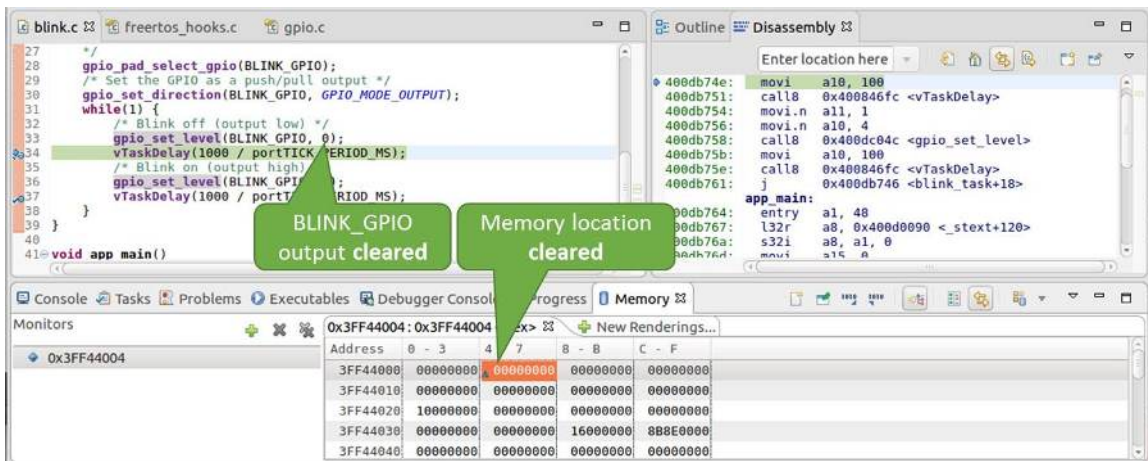

退出调试器，这样就不会与新代码混淆，然后重新构建并烧写代码到 ESP32-H2 中，接着重启调试器。注意，这里不需要我们重启 OpenOCD。

一旦程序停止运行，在代码 `i++` 处添加一个断点。

下一步，在“Breakpoints”所在的窗口中，选择“Expressions”选项卡。如果该选项卡不存在，请在顶部菜单栏的 `Window > Show View > Expressions` 中添加这一选项卡。然后在该选项卡中单击“Add new expression”，并输入 `i`。

按下 F8 继续运行程序，每次程序停止时，都会看到变量 `i` 的值在递增。



图 40: 观察程序变量“i”

如想更改 `i` 的值，可以在“Value”一栏中输入新的数值。按下“Resume (F8)”后，程序将从新输入的数字开始递增 `i`。

**设置条件断点** 接下来的内容更为有趣，你可能想在一定条件满足的情况下设置断点，然后让程序停止运行。右击断点打开上下文菜单，选择“Breakpoint Properties”，将“Type:”改选为“Hardware”然后在“Condition:”一栏中输入条件表达式，例如 `i == 2`。

如果当前 `i` 的值小于 2（如果有需要也可以更改这个阈值）并且程序被恢复运行，那么 LED 就会循环闪烁，直到 `i == 2` 条件成立，最后程序停止在该处。

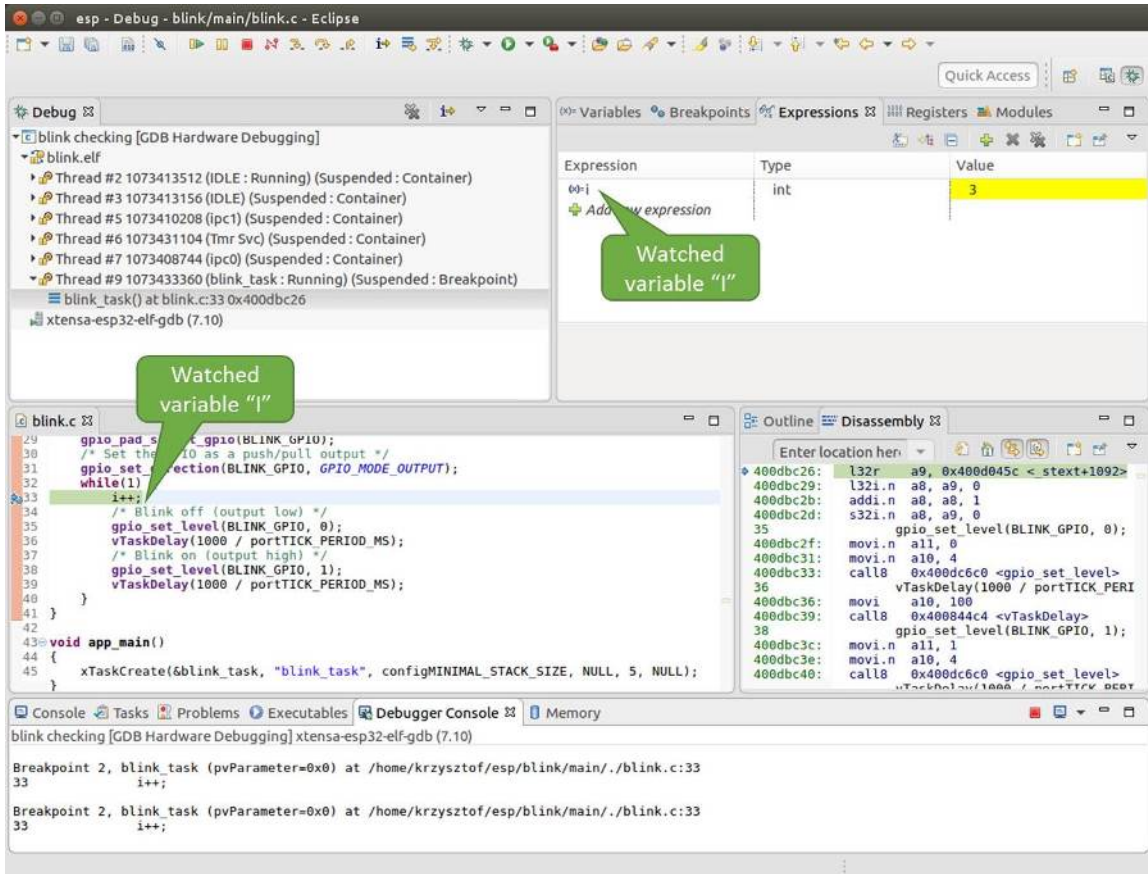
**使用命令行的调试示例** 请检查你的目标板是否已经准备好，并加载了 [get-started/blink](#) 示例代码，然后按照[使用命令行调试](#)中介绍的步骤配置和启动调试器，最后选择让应用程序在 `app_main()` 建立的断点处停止运行

```
Temporary breakpoint 1, app_main () at /home/user-name/esp/blink/main/./blink.c:43
43     xTaskCreate(&blink_task, "blink_task", configMINIMAL_STACK_SIZE, NULL, 5,
↳ NULL);
(gdb)
```





图 41: 设置条件断点

### 本小节的示例

1. 浏览代码，查看堆栈和线程
2. 设置和清除断点
3. 暂停和恢复应用程序的运行
4. 单步执行代码
5. 查看并设置内存
6. 观察和设置程序变量
7. 设置条件断点
8. 调试 *FreeRTOS* 对象

**浏览代码，查看堆栈和线程** 当看到 (gdb) 提示符的时候，应用程序已停止运行，LED 也停止闪烁。

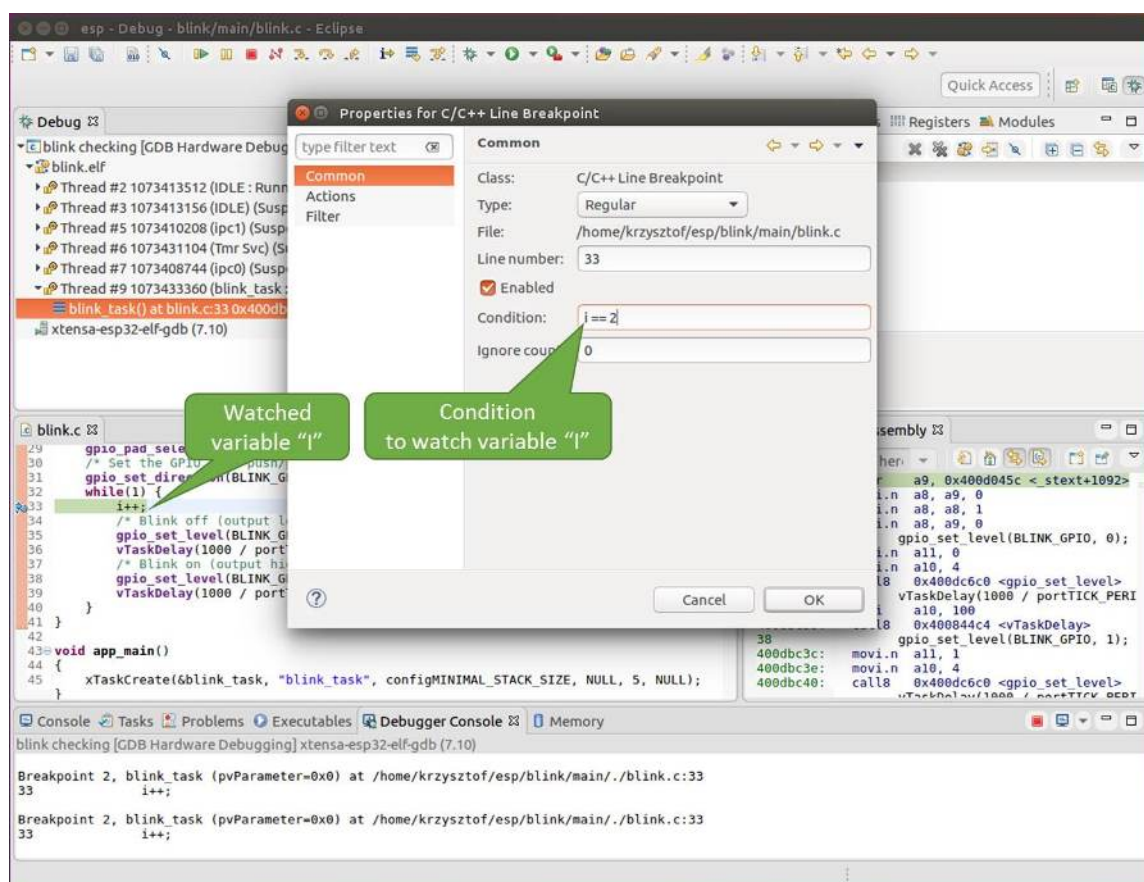
要找到代码暂停的位置，输入 `l` 或者 `list` 命令，调试器会打印出暂停点 (`blink.c` 代码文件的第 43 行) 附近的几行代码

```
(gdb) l
38     }
39   }
40
41   void app_main()
42   {
43     xTaskCreate(&blink_task, "blink_task", configMINIMAL_STACK_SIZE, NULL, 5,
↳NULL);
44   }
(gdb)
```

也可以通过输入 `l 30, 40` 等命令来查看特定行号范围内的代码。

使用 `bt` 或者 `backtrace` 来查看哪些函数最终导致了此代码被调用:

```
(gdb) bt
#0  app_main () at /home/user-name/esp/blink/main/./blink.c:43
#1  0x400d057e in main_task (args=0x0) at /home/user-name/esp/esp-idf/components/
↳esp32h2/./cpu_start.c:339
(gdb)
```

输出的第 0 行表示应用程序暂停之前调用的最后一个函数，即我们之前列出的 `app_main ()`。`app_main ()` 又被位于 `cpu_start.c` 文件第 339 行的 `main_task` 函数调用。

想查看 `cpu_start.c` 文件中 `main_task` 函数的上下文，需要输入 `frame N`，其中 `N=1`，因为根据前面的输出，`main_task` 位于 #1 下:

```
(gdb) frame 1
#1  0x400d057e in main_task (args=0x0) at /home/user-name/esp/esp-idf/components/
↳esp32h2/./cpu_start.c:339
339   app_main();
(gdb)
```

输入 `l` 将显示一段名为 `app_main ()` 的代码 (在第 339 行) :

```
(gdb) l
334     ;
335   }
336 #endif
337   //Enable allocation in region where the startup stacks were located.
338   heap_caps_enable_nonos_stack_heaps();
339   app_main();
340   vTaskDelete(NULL);
341 }
342
(gdb)
```

通过打印前面的一些行，你会看到我们一直在寻找的 `main_task` 函数：

```
(gdb) l 326, 341
326 static void main_task(void* args)
327 {
328     // Now that the application is about to start, disable boot watchdogs
329     REG_CLR_BIT(TIMG_WDTCONFIG0_REG(0), TIMG_WDT_FLASHBOOT_MOD_EN_S);
330     REG_CLR_BIT(RTC_CNTL_WDTCONFIG0_REG, RTC_CNTL_WDT_FLASHBOOT_MOD_EN);
331 #if !CONFIG_FREERTOS_UNICORE
332     // Wait for FreeRTOS initialization to finish on APP CPU, before replacing
↳ its startup stack
333     while (port_xSchedulerRunning[1] == 0) {
334         ;
335     }
336 #endif
337     //Enable allocation in region where the startup stacks were located.
338     heap_caps_enable_nonos_stack_heaps();
339     app_main();
340     vTaskDelete(NULL);
341 }
(gdb)
```

如果要查看其他代码，可以输入 `i threads` 命令，则会输出目标板上运行的线程列表：

```
(gdb) i threads
  Id  Target Id      Frame
  8   Thread 1073411336 (dport) 0x400d0848 in dport_access_init_core (arg=
↳ <optimized out>)
    at /home/user-name/esp/esp-idf/components/esp32h2/./dport_access.c:170
  7   Thread 1073408744 (ipc0) xQueueGenericReceive (xQueue=0x3ffae694,
↳ pvBuffer=0x0, xTicksToWait=1644638200,
    xJustPeeking=0) at /home/user-name/esp/esp-idf/components/freertos/./queue.
↳ c:1452
  6   Thread 1073431096 (Tmr Svc) prvTimerTask (pvParameters=0x0)
    at /home/user-name/esp/esp-idf/components/freertos/./timers.c:445
  5   Thread 1073410208 (ipc1 : Running) 0x4000bfea in ?? ()
  4   Thread 1073432224 (dport) dport_access_init_core (arg=0x0)
    at /home/user-name/esp/esp-idf/components/esp32h2/./dport_access.c:150
  3   Thread 1073413156 (IDLE) prvIdleTask (pvParameters=0x0)
    at /home/user-name/esp/esp-idf/components/freertos/./tasks.c:3282
  2   Thread 1073413512 (IDLE) prvIdleTask (pvParameters=0x0)
    at /home/user-name/esp/esp-idf/components/freertos/./tasks.c:3282
* 1   Thread 1073411772 (main : Running) app_main () at /home/user-name/esp/blink/
↳ main/./blink.c:43
(gdb)
```

线程列表显示了每个线程最后一个被调用的函数以及所在的 C 源文件名（如果存在的话）。

你可以通过输入 `thread N` 进入特定的线程，其中 `N` 是线程 ID。我们进入 5 号线程来看一下它是如何工作的：

```
(gdb) thread 5
[Switching to thread 5 (Thread 1073410208)]
#0 0x4000bfea in ?? ()
(gdb)
```

然后查看回溯：

```
(gdb) bt
#0 0x4000bfea in ?? ()
#1 0x40083a85 in vPortCPUReleaseMutex (mux=<optimized out>) at /home/user-name/
↳ esp/esp-idf/components/freertos/./port.c:415
#2 0x40083fc8 in vTaskSwitchContext () at /home/user-name/esp/esp-idf/components/
↳ freertos/./tasks.c:2846
```

(下页继续)

```
#3 0x4008532b in _frxt_dispatch ()
#4 0x4008395c in xPortStartScheduler () at /home/user-name/esp/esp-idf/components/
↳freertos/./port.c:222
#5 0x4000000c in ?? ()
#6 0x4000000c in ?? ()
#7 0x4000000c in ?? ()
#8 0x4000000c in ?? ()
(gdb)
```

如上所示，回溯可能会包含多个条目，方便查看直至目标停止运行的函数调用顺序。如果找不到某个函数的源码文件，将会使用问号 ?? 替代，这表示该函数是以二进制格式提供的。像 0x4000bfea 这样的值是被调用函数所在的内存地址。

使用诸如 `bt`, `i threads`, `thread N` 和 `list` 命令可以浏览整个应用程序的代码。这给单步调试代码和设置断点带来很大的便利，下面将一一展开来讨论。

**设置和清除断点** 在调试时，我们希望能够在关键的代码行停止应用程序，然后检查特定的变量、内存、寄存器和外设的状态。为此我们需要使用断点，以便在特定某行代码处快速访问和停止应用程序。

我们在控制 LED 状态发生变化的两处代码行分别设置一个断点。基于以上代码列表，这两处分别为第 33 和 36 代码行。使用命令 `break M` 设置断点，其中 `M` 是具体的代码行：

```
(gdb) break 33
Breakpoint 2 at 0x400db6f6: file /home/user-name/esp/blink/main/./blink.c, line 33.
(gdb) break 36
Breakpoint 3 at 0x400db704: file /home/user-name/esp/blink/main/./blink.c, line 36.
```

输入命令 `c`，处理器将运行并在断点处停止。再次输入 `c` 将使其再次运行，并在第二个断点处停止，依此类推：

```
(gdb) c
Continuing.
Target halted. PRO_CPU: PC=0x400DB6F6 (active) APP_CPU: PC=0x400D10D8

Breakpoint 2, blink_task (pvParameter=0x0) at /home/user-name/esp/blink/main/./
↳blink.c:33
33      gpio_set_level(BLINK_GPIO, 0);
(gdb) c
Continuing.
Target halted. PRO_CPU: PC=0x400DB6F8 (active) APP_CPU: PC=0x400D10D8
Target halted. PRO_CPU: PC=0x400DB704 (active) APP_CPU: PC=0x400D10D8

Breakpoint 3, blink_task (pvParameter=0x0) at /home/user-name/esp/blink/main/./
↳blink.c:36
36      gpio_set_level(BLINK_GPIO, 1);
(gdb)
```

只有在输入命令 `c` 恢复程序运行后才能看到 LED 改变状态。

查看已设置断点的数量和位置，请使用命令 `info break`：

```
(gdb) info break
Num      Type          Disp Enb Address      What
2        breakpoint    keep y  0x400db6f6 in blink_task at /home/user-name/esp/
↳blink/main/./blink.c:33
         breakpoint already hit 1 time
3        breakpoint    keep y  0x400db704 in blink_task at /home/user-name/esp/
↳blink/main/./blink.c:36
         breakpoint already hit 1 time
(gdb)
```

请注意，断点序号（在 Num 栏列出）从 2 开始，这是因为在调试器启动时执行 `thb app_main` 命令已经在 `app_main()` 函数处建立了第一个断点。由于它是一个临时断点，已经被自动删除，所以没有被列出。

要删除一个断点，请输入 `delete N` 命令（或者简写成 `d N`），其中 `N` 代表断点序号：

```
(gdb) delete 1
No breakpoint number 1.
(gdb) delete 2
(gdb)
```

更多关于断点的信息，请参阅[可用的断点和观察点](#)和[关于断点的补充知识](#)。

**暂停和恢复应用程序的运行** 在调试时，可以恢复程序运行并输入代码等待某个事件发生或者保持无限循环而不设置任何断点。对于后者，想要返回调试模式，可以通过输入 `Ctrl+C` 手动中断程序的运行。

在此之前，请删除所有的断点，然后输入 `c` 恢复程序运行。接着输入 `Ctrl+C`，应用程序会停止在某个随机的位置，此时 LED 也将停止闪烁。调试器会打印如下信息：

```
(gdb) c
Continuing.
^CTarget halted. PRO_CPU: PC=0x400D0C00          APP_CPU: PC=0x400D0C00 (active)
[New Thread 1073433352]

Program received signal SIGINT, Interrupt.
[Switching to Thread 1073413512]
0x400d0c00 in esp_vApplicationIdleHook () at /home/user-name/esp/esp-idf/
↳components/esp32h2/./freertos_hooks.c:52
52          asm("waiti 0");
(gdb)
```

在上图所示的情况下，应用程序已经在 `freertos_hooks.c` 文件的第 52 行暂停运行，现在你可以通过输入 `c` 再次将其恢复运行或者进行如下所述的一些调试工作。

**单步执行代码** 我们还可以使用 `step` 和 `next` 命令（可以简写成 `s` 和 `n`）单步执行代码，这两者之间的区别是执行“`step`”命令会进入调用的子程序内部，而执行“`next`”命令则会直接将子程序看成单个源代码行，单步就能将其运行结束。

在继续演示此功能之前，请使用前面介绍的 `break` 和 `delete` 命令，确保目前只在 `blink.c` 文件的第 36 行设置了一个断点：

```
(gdb) info break
Num      Type           Disp Enb Address      What
3        breakpoint      keep y   0x400db704 in blink_task at /home/user-name/esp/
↳blink/main/./blink.c:36
          breakpoint already hit 1 time
(gdb)
```

输入 `c` 恢复程序运行然后等它在断点处停止运行：

```
(gdb) c
Continuing.
Target halted. PRO_CPU: PC=0x400DB754 (active)  APP_CPU: PC=0x400D1128

Breakpoint 3, blink_task (pvParameter=0x0) at /home/user-name/esp/blink/main/./
↳blink.c:36
36          gpio_set_level(BLINK_GPIO, 1);
(gdb)
```

然后输入 `n` 多次，观察调试器是如何单步执行一行代码的：

```
(gdb) n
Target halted. PRO_CPU: PC=0x400DB756 (active)    APP_CPU: PC=0x400D1128
Target halted. PRO_CPU: PC=0x400DB758 (active)    APP_CPU: PC=0x400D1128
Target halted. PRO_CPU: PC=0x400DC04C (active)    APP_CPU: PC=0x400D1128
Target halted. PRO_CPU: PC=0x400DB75B (active)    APP_CPU: PC=0x400D1128
37         vTaskDelay(1000 / portTICK_PERIOD_MS);
(gdb) n
Target halted. PRO_CPU: PC=0x400DB75E (active)    APP_CPU: PC=0x400D1128
Target halted. PRO_CPU: PC=0x400846FC (active)    APP_CPU: PC=0x400D1128
Target halted. PRO_CPU: PC=0x400DB761 (active)    APP_CPU: PC=0x400D1128
Target halted. PRO_CPU: PC=0x400DB746 (active)    APP_CPU: PC=0x400D1128
33         gpio_set_level(BLINK_GPIO, 0);
(gdb)
```

如果你输入 `s`，那么调试器将进入子程序：

```
(gdb) s
Target halted. PRO_CPU: PC=0x400DB748 (active)    APP_CPU: PC=0x400D1128
Target halted. PRO_CPU: PC=0x400DB74B (active)    APP_CPU: PC=0x400D1128
Target halted. PRO_CPU: PC=0x400DC04C (active)    APP_CPU: PC=0x400D1128
Target halted. PRO_CPU: PC=0x400DC04F (active)    APP_CPU: PC=0x400D1128
gpio_set_level (gpio_num=GPIO_NUM_4, level=0) at /home/user-name/esp/esp-idf/
↳components/esp_driver_gpio/src/gpio.c:183
183     GPIO_CHECK(GPIO_IS_VALID_OUTPUT_GPIO(gpio_num), "GPIO output gpio_num error
↳", ESP_ERR_INVALID_ARG);
(gdb)
```

上述例子中，调试器进入 `gpio_set_level(BLINK_GPIO, 0)` 代码内部，同时代码窗口快速切换到 `gpio.c` 驱动文件。

请参阅 [“next”命令无法跳过子程序的原因](#) 文档以了解 `next` 命令的潜在局限。

**查看并设置内存** 使用命令 `x` 可以显示内存的内容，配合其余参数还可以调整所显示内存位置的格式和数量。运行 `help x` 可以查看更多相关细节。与 `x` 命令配合使用的命令是 `set`，它允许你将值写入内存。

为了演示 `x` 和 `set` 的使用，我们将在内存地址 `0x3FF44004` 处读取和写入内容。该地址也是 `GPIO_OUT_REG` 寄存器的地址，可以用来控制（设置或者清除）某个 `GPIO` 的电平。

关于该寄存器的更多详细信息，请参阅 [ESP32-H2 技术参考手册 > IO MUX 和 GPIO Matrix \(GPIO, IO\\_MUX\) \[PDF\]](#) 章节。

同样在 `blink.c` 项目文件中，在两个 `gpio_set_level` 语句的后面各设置一个断点。输入两次 `c` 命令后停止在断点处，然后输入 `x /1wx 0x3FF44004` 来显示 `GPIO_OUT_REG` 寄存器的值：

```
(gdb) c
Continuing.
Target halted. PRO_CPU: PC=0x400DB75E (active)    APP_CPU: PC=0x400D1128
Target halted. PRO_CPU: PC=0x400DB74E (active)    APP_CPU: PC=0x400D1128

Breakpoint 2, blink_task (pvParameter=0x0) at /home/user-name/esp/blink/main./
↳blink.c:34
34         vTaskDelay(1000 / portTICK_PERIOD_MS);
(gdb) x /1wx 0x3FF44004
0x3ff44004: 0x00000000
(gdb) c
Continuing.
Target halted. PRO_CPU: PC=0x400DB751 (active)    APP_CPU: PC=0x400D1128
Target halted. PRO_CPU: PC=0x400DB75B (active)    APP_CPU: PC=0x400D1128

Breakpoint 3, blink_task (pvParameter=0x0) at /home/user-name/esp/blink/main./
↳blink.c:37
37         vTaskDelay(1000 / portTICK_PERIOD_MS);
```

(下页继续)

(续上页)

```
(gdb) x /1wx 0x3FF44004
0x3ff44004: 0x00000010
(gdb)
```

如果闪烁的 LED 连接到了 GPIO4，那么每次 LED 改变状态时你会看到第 4 比特被翻转：

```
0x3ff44004: 0x00000000
...
0x3ff44004: 0x00000010
```

现在，当 LED 熄灭时，与之对应地会显示 0x3ff44004: 0x00000000，尝试使用 set 命令向相同的内存地址写入 0x00000010 来将该比特置高：

```
(gdb) x /1wx 0x3FF44004
0x3ff44004: 0x00000000
(gdb) set {unsigned int}0x3FF44004=0x000010
```

在输入 set {unsigned int}0x3FF44004=0x000010 命令后，你会立即看到 LED 亮起。

**观察和设置程序变量** 常见的调试任务是在程序运行期间检查程序中某个变量的值，为了能够演示这个功能，更新 blink.c 文件，在 blink\_task 函数的上面添加一个全局变量的声明 int i，然后在 while(1) 里添加 i++，这样每次 LED 改变状态的时候，变量 i 都会增加 1。

退出调试器，这样就不会与新代码混淆，然后重新构建并烧写代码到 ESP32-H2 中，接着重启调试器。注意，这里不需要我们重启 OpenOCD。

一旦程序停止运行，输入命令 watch i：

```
(gdb) watch i
Hardware watchpoint 2: i
(gdb)
```

这会在所有变量 i 发生改变的代码处插入所谓的“观察点”。现在输入 continue 命令来恢复应用程序的运行并观察它停止：

```
(gdb) c
Continuing.
Target halted. PRO_CPU: PC=0x400DB751 (active)   APP_CPU: PC=0x400D0811
[New Thread 1073432196]

Program received signal SIGTRAP, Trace/breakpoint trap.
[Switching to Thread 1073432196]
0x400db751 in blink_task (pvParameter=0x0) at /home/user-name/esp/blink/main/./
->blink.c:33
33      i++;
(gdb)
```

多次恢复程序运行后，变量 i 的值会增加，现在你可以输入 print i（简写 p i）来查看当前 i 的值：

```
(gdb) p i
$1 = 3
(gdb)
```

要修改 i 的值，请使用 set 命令，如下所示（可以将其打印输出出来查看是否确已修改）：

```
(gdb) set var i = 0
(gdb) p i
$3 = 0
(gdb)
```

最多可以使用两个观察点，详细信息请参阅[可用的断点和观察点](#)。



**设置条件断点** 接下来的内容更为有趣，你可能想在一定条件满足的情况下设置断点。请先删除已有的断点，然后尝试如下命令：

```
(gdb) break blink.c:34 if (i == 2)
Breakpoint 3 at 0x400db753: file /home/user-name/esp/blink/main/./blink.c, line 34.
(gdb)
```

以上命令在 `blink.c` 文件的 34 处设置了一个条件断点，当 `i == 2` 条件满足时，程序会停止运行。

如果当前 `i` 的值小于 2 并且程序被恢复运行，那么 LED 就会循环闪烁，直到 `i == 2` 条件成立，最后程序停止在该处：

```
(gdb) set var i = 0
(gdb) c
Continuing.
Target halted. PRO_CPU: PC=0x400DB755 (active) APP_CPU: PC=0x400D112C
Target halted. PRO_CPU: PC=0x400DB753 (active) APP_CPU: PC=0x400D112C
Target halted. PRO_CPU: PC=0x400DB755 (active) APP_CPU: PC=0x400D112C
Target halted. PRO_CPU: PC=0x400DB753 (active) APP_CPU: PC=0x400D112C

Breakpoint 3, blink_task (pvParameter=0x0) at /home/user-name/esp/blink/main/./
↪blink.c:34
34         gpio_set_level(BLINK_GPIO, 0);
(gdb)
```

**调试 FreeRTOS 对象** 该部分内容或许可以帮助你调试 FreeRTOS 任务交互。

需要调试 FreeRTOS 任务交互的用户可使用 GDB 命令 `freertos`。该命令并非 GDB 原生命令，而是来自于 Python 扩展模块 `freertos-gdb`，其包含一系列子命令：

```
(gdb) freertos
"freertos" 后面必须紧随子命令的名称
freertos 子命令如下：

freertos queue -- 打印当前队列信息
freertos semaphore -- 打印当前信号量信息
freertos task -- 打印当前任务及其状态
freertos timer -- 打印当前定时器信息
```

点击 <https://pypi.org/project/freertos-gdb> 链接了解此扩展模块的详细信息。

**备注：**ESP-IDF 在安装 Python 包时会自动安装 `freertos-gdb` Python 模块，详情请参考 [第三步：设置工具](#)。

如果使用 `idf.py gdb` 命令运行 GDB，FreeRTOS 扩展会自动加载。也可以使用 GDB 内部命令 `python import freertos_gdb` 使能该模块。

请保证使用 Python 3.6 及以上版本，该版本具有 Python 共享库。

**获得命令的帮助信息** 目前所介绍的都是些非常基础的命令，目的在于让你快速上手 JTAG 调试。如果想获得特定命令的语法和功能相关的信息，请在 (gdb) 提示符下输入 `help` 和命令名：

```
(gdb) help next
Step program, proceeding through subroutine calls.
Usage: next [N]
Unlike "step", if the current source line calls a subroutine,
this command does not enter the subroutine, but instead steps over
the call, in effect treating it as a single source line.
(gdb)
```



只需输入 `help` 命令，即可获得高级命令列表，帮助你了解更多详细信息。此外，还可以参考一些 GDB 命令速查表，比如 <https://darkdust.net/files/GDB%20Cheat%20Sheet.pdf>。虽然不是所有命令都适用于嵌入式环境，但还是会有所裨益。

**结束调试会话** 输入命令 `q` 可以退出调试器：

```
(gdb) q
A debugging session is active.

    Inferior 1 [Remote target] will be detached.

Quit anyway? (y or n) y
Detaching from program: /home/user-name/esp/blink/build/blink.elf, Remote target
Ending remote debugging.
user-name@computer-name:~/esp/blink$
```

- [使用调试器](#)
- [调试示例](#)
- [注意事项和补充内容](#)
- [应用层跟踪库](#)
- [ESP-Prog 调试板介绍](#)

## 4.17 链接器脚本生成机制

### 4.17.1 概述

ESP32-H2 中有多个用于存放代码和数据的内存区域。代码和只读数据默认存放在 flash 中，可写数据存放在 RAM 中。不过有时，用户必须更改默认存放区域。

例如：

- 将关键代码存放到 RAM 中以提高性能；
- 将可执行代码存放到 IRAM 中，以便在缓存被禁用时运行这些代码；
- 将代码存放到 RTC 存储器中，以便在 wake stub 中使用；

链接器脚本生成机制可以让用户指定代码和数据在 ESP-IDF 组件中的存放区域。组件包含如何存放符号、目标或完整库的信息。在构建应用程序时，组件中的这些信息会被收集、解析并处理；生成的存放规则用于链接应用程序。

### 4.17.2 快速上手

本段将指导如何使用 ESP-IDF 的即用方案，快速将代码和数据放入 RAM 和 RTC 存储器中。

假设用户有：

```
components
├── my_component
│   ├── CMakeLists.txt
│   ├── Kconfig
│   └── src/
│       ├── my_src1.c
│       ├── my_src2.c
│       └── my_src3.c
└── my_linker_fragment_file.lf
```

- 名为 `my_component` 的组件，在构建过程中存储为 `libmy_component.a` 库文件
- 库文件包含的三个源文件：`my_src1.c`、`my_src2.c` 和 `my_src3.c`，编译后分别为 `my_src1.o`、`my_src2.o` 和 `my_src3.o`
- 在 `my_src1.o` 中定义 `my_function1` 功能；在 `my_src2.o` 中定义 `my_function2` 功能
- 在 `my_component` 下 `Kconfig` 中存在布尔类型配置 `PERFORMANCE_MODE (y/n)` 和整数类型配置 `PERFORMANCE_LEVEL (范围是 0-3)`

### 创建和指定链接器片段文件

首先，用户需要创建链接器片段文件。链接器片段文件是一个扩展名为 `.lf` 的文本文件，想要存放的位置信息会写入该文件内。文件创建成功后，需要将其呈现在构建系统中。`ESP-IDF` 支持的构建系统指南如下：

在组件目录的 `CMakeLists.txt` 文件中，指定 `idf_component_register` 调用引数 `LDFRAGMENTS` 的值。`LDFRAGMENTS` 可以为绝对路径，也可为组件目录的相对路径，指向已创建的链接器片段文件。

```
# 相对于组件的 CMakeLists.txt 的文件路径
idf_component_register(...
    LDFRAGMENTS "path/to/linker_fragment_file.1f" "path/to/
↳another_linker_fragment_file.1f"
    ...
)
```

### 指定存放区域

可以按照下列粒度指定存放区域：

- 目标文件（`.obj` 或 `.o` 文件）
- 符号（函数/变量）
- 库（`.a` 文件）

**存放目标文件** 假设整个 `my_src1.o` 目标文件对性能至关重要，所以最好把该文件放在 `RAM` 中。另外，`my_src2.o` 目标文件包含从深度睡眠唤醒所需的符号，因此需要将其存放到 `RTC` 存储器中。

在链接器片段文件中可以写入以下内容：

```
[mapping:my_component]
archive: libmy_component.a
entries:
    my_src1 (noflash)      # 将所有 my_src1 代码和只读数据存放在 IRAM 和 DRAM 中
    my_src2 (rtc)         # 将所有 my_src2 代码、数据和只读数据存放到 RTC 快速 RAM_
↳和 RTC 慢速 RAM 中
```

那么 `my_src3.o` 放在哪里呢？由于未指定存放区域，`my_src3.o` 会存放到默认区域。更多关于默认存放区域的信息，请查看[这里](#)。

**存放符号** 继续上文的例子，假设 `object1.o` 目标文件定义的功能中，只有 `my_function1` 影响到性能；`object2.o` 目标文件中只有 `my_function2` 需要在芯片从深度睡眠中唤醒后运行。要实现该目的，可在链接器片段文件中写入以下内容：

```
[mapping:my_component]
archive: libmy_component.a
entries:
    my_src1:my_function1 (noflash)
    my_src2:my_function2 (rtc)
```

`my_src1.o` 和 `my_src2.o` 中的其他函数以及整个 `object3.o` 目标文件会存放到默认区域。要指定数据的存放区域，仅需将上文的函数名替换为变量名即可，如：

```
my_src1:my_variable (noflash)
```

**注意：**按照符号粒度存放代码和数据有一定的局限。为确保存放区域合适，您也可以将相关代码和数据集中在源文件中，参考[使用目标文件的存放规则](#)。

**存放整个库** 在这个例子中，假设整个组件库都需存放到 RAM 中，可以写入以下内容存放整个库：

```
[mapping:my_component]
archive: libmy_component.a
entries:
    * (noflash)
```

类似的，写入以下内容可以将整个组件存放到 RTC 存储器中：

```
[mapping:my_component]
archive: libmy_component.a
entries:
    * (rtc)
```

**根据具体配置存放** 假设只有在某个条件为真时，比如 `CONFIG_PERFORMANCE_MODE == y` 时，整个组件库才有特定存放区域，可以写入以下内容实现：

```
[mapping:my_component]
archive: libmy_component.a
entries:
    if PERFORMANCE_MODE = y:
        * (noflash)
    else:
        * (default)
```

来看一种更复杂的情况。假设 `CONFIG_PERFORMANCE_LEVEL == 1` 时，只有 `object1.o` 存放到 RAM 中；`CONFIG_PERFORMANCE_LEVEL == 2` 时，`object1.o` 和 `object2.o` 会存放到 RAM 中；`CONFIG_PERFORMANCE_LEVEL == 3` 时，库中的所有目标文件都会存放到 RAM 中。以上三个条件为假时，整个库会存放到 RTC 存储器中。虽然这种使用场景很罕见，不过，还是可以通过以下方式实现：

```
[mapping:my_component]
archive: libmy_component.a
entries:
    if PERFORMANCE_LEVEL = 1:
        my_src1 (noflash)
    elif PERFORMANCE_LEVEL = 2:
        my_src1 (noflash)
        my_src2 (noflash)
    elif PERFORMANCE_LEVEL = 3:
        my_src1 (noflash)
        my_src2 (noflash)
        my_src3 (noflash)
    else:
        * (rtc)
```

也可以嵌套条件检查。以下内容与上述片段等效：

```
[mapping:my_component]
archive: libmy_component.a
entries:
    if PERFORMANCE_LEVEL <= 3 && PERFORMANCE_LEVEL > 0:
        if PERFORMANCE_LEVEL >= 1:
```

(下页继续)

```

object1 (noflash)
  if PERFORMANCE_LEVEL >= 2:
    object2 (noflash)
    if PERFORMANCE_LEVEL >= 3:
      object2 (noflash)
else:
  * (rtc)

```

### 默认存放区域

到目前为止，“默认存放区域”在未指定 `rtc` 和 `noflash` 存放规则时才会作为备选方案使用。需要注意的是，`noflash` 或者 `rtc` 标记不仅仅是关键字，实际上还是被称作片段的实体，确切地说是[协议](#)。

与 `rtc` 和 `noflash` 类似，还有一个默认协议，定义了默认存放规则。顾名思义，该协议规定了代码和数据通常存放的区域，即代码和常量存放在 `flash` 中，变量存放在 `RAM` 中。更多关于默认协议的信息，请见[这里](#)。

---

**备注：** 使用链接器脚本生成机制的 IDF 组件示例，请参阅 [freertos/CMakeLists.txt](#)。为了提高性能，`freertos` 使用链接器脚本生成机制，将其目标文件存放到 `RAM` 中。

---

快速入门指南到此结束，下文将详述这个机制的内核，有助于创建自定义存放区域或修改默认方式。

### 4.17.3 链接器脚本生成机制内核

链接是将 C/C++ 源文件转换成可执行文件的最后一步。链接由工具链的链接器完成，接受指定代码和数据存放区域等信息的链接脚本。链接器脚本生成机制的转换过程类似，区别在于传输给链接器的链接脚本根据 (1) 收集的[链接器片段文件](#)和 (2) [链接器脚本模板](#) 动态生成。

---

**备注：** 执行链接器脚本生成机制的工具存放在 `tools/ldgen` 之下。

---

#### 链接器片段文件

如快速入门指南所述，片段文件是拓展名为 `.lf` 的简单文本文件，内含想要存放区域的信息。不过，这是对片段文件所包含内容的简化版描述。实际上，片段文件内包含的是“片段”。片段是实体，包含多条信息，这些信息放在一起组成了存放规则，说明目标文件各个段在二进制输出文件中的存放位置。片段一共有三种，分别是[段](#)、[协议](#)和[映射](#)。

**语法** 三种片段类型使用同一种语法：

```

[type:name]
key: value
key:
  value
  value
  value
  ...

```

- 类型：片段类型，可以为段、协议或映射。
- 名称：片段名称，指定片段类型的片段名称应唯一。
- 键值：片段内容。每个片段类型可支持不同的键值和不同的键值语法。
  - 在[段](#)和[协议](#)中，仅支持 `entries` 键。
  - 在[映射](#)中，支持 `archive` 和 `entries` 键。

---

**备注：** 多个片段的类型和名称相同时会引发异常。

---



---

**备注：** 片段名称和键值只能使用字母、数字和下划线。

---

### 条件检查

条件检查使得链接器脚本生成机制可以感知配置。含有配置值的表达式是否为真，决定了使用哪些特定键值。检查使用的是 `kconfiglib` 脚本的 `eval_string`，遵循该脚本要求的语法和局限性，支持：

- **比较**
  - 小于 <
  - 小于等于 <=
  - 大于 >
  - 大于等于 >=
  - 等于 =
  - 不等于 !=
- **逻辑**
  - 或 ||
  - 和 &&
  - 取反 !
- **分组**
  - 圆括号 ()

条件检查和其他语言中的 `if...elseif/elif...else` 块作用一样。键值和完整片段都可以进行条件检查。以下两个示例效果相同：

```
# 键值取决于配置
[type:name]
key_1:
    if CONDITION = y:
        value_1
    else:
        value_2
key_2:
    if CONDITION = y:
        value_a
    else:
        value_b
```

```
# 完整片段的定义取决于配置
if CONDITION = y:
    [type:name]
    key_1:
        value_1
    key_2:
        value_a
else:
    [type:name]
    key_1:
        value_2
    key_2:
        value_b
```

### 注释

链接器片段文件中的注释以 `#` 开头。和在其他语言中一样，注释提供了有用的描述和资料，在处理过程中会被忽略。

### 类型 段

段定义了 GCC 编译器输出的一系列目标文件段，可以是默认段（如 `.text`、`.data`），也可以是用户通过 `__attribute__` 关键字定义的段。

'+' 表示段列表开始，且当前段为列表中的第一个段。这种表达方式更加推荐。

```
[sections:name]
entries:
    .section+
    .section
    ...
```

示例：

```
# 不推荐的方式
[sections:text]
entries:
    .text
    .text.*
    .literal
    .literal.*

# 推荐的方式，效果与上面等同
[sections:text]
entries:
    .text+           # 即 .text 和 .text.*
    .literal+       # 即 .literal 和 .literal.*
```

## 协议

协议定义了每个段对应的目标。

```
[scheme:name]
entries:
    sections -> target
    sections -> target
    ...
```

示例：

```
[scheme:noflash]
entries:
    text -> iram0_text           # text 段下的所有条目均归入 iram0_text
    rodata -> dram0_data       # rodata 段下的所有条目均归入 dram0_data
```

### 默认协议

注意，有一个默认的协议很特殊，特殊在于包罗存放规则都是根据这个协议中的条目生成的。这意味着，如果该协议有一条条目是 `text -> flash_text`，则将为目标 `flash_text` 生成如下的存放规则：

```
*(.literal .literal.* .text .text.*)
```

这些生成的包罗规则将用于未指定映射规则的情况。

默认协议在 `esp_system/app.lf` 文件中定义。快速上手指南中提到的内置 `noflash` 协议和 `rtc` 协议也在该文件中定义。

## 映射

映射定义了可映射实体（即目标文件、函数名、变量名和库）对应的协议。

```
[mapping]
archive: archive           # 构建后输出的库文件名称（即 libxxx.a）
entries:
    object:symbol (scheme) # 符号
```

(下页继续)

```
object (scheme)          # 目标
* (scheme)              # 库
```

有三种存放粒度：

- 符号：指定了目标文件名称和符号名称。符号名称可以是函数名或变量名。
- 目标：只指定目标文件名称。
- 库：指定 \*，即某个库下面所有目标文件的简化表达法。

为了更好地理解条目的含义，请看一个按目标存放的例子。

```
object (scheme)
```

根据条目定义，将这个协议展开：

```
object (sections -> target,
        sections -> target,
        ...)
```

再根据条目定义，将这个段展开：

```
object (.section,
        .section,
        ... -> target, # 根据目标文件将这里所列出的所有段放在该目标位置

        .section,
        .section,
        ... -> target, # 同样的方法指定其他段

        ...)          # 直至所有段均已展开
```

示例：

```
[mapping:map]
archive: libfreertos.a
entries:
    * (noflash)
```

除了实体和协议，条目中也支持指定如下标志：（注：<> = 参数名称，[] = 可选参数）

#### 1. ALIGN(<alignment>[, pre, post])

根据 alignment 中指定的数字对齐存放区域，根据是否指定 pre 和 post，或两者都指定，在输入段描述（生成于映射条目）的前面和/或后面生成：

#### 2. SORT([<sort\_by\_first>, <sort\_by\_second>])

在输入段描述中输出 SORT\_BY\_NAME, SORT\_BY\_ALIGNMENT, SORT\_BY\_INIT\_PRIORITY 或 SORT。

sort\_by\_first 和 sort\_by\_second 的值可以是：name、alignment、init\_priority。

如果既没指定 sort\_by\_first 也没指定 sort\_by\_second，则输入段会按照名称排序，如果两者都指定了，那么嵌套排序会遵循 <https://sourceware.org/binutils/docs/ld/Input-Section-Wildcards.html> 中的规则。

#### 3. KEEP()

用 KEEP 命令包围输入段描述，从而防止链接器丢弃存放区域。更多细节请参考 <https://sourceware.org/binutils/docs/ld/Input-Section-Keep.html>

#### 4. SURROUND(<name>)

在存放区域的前面和后面生成符号，生成的符号遵循 \_<name>\_start 和 \_<name>\_end 的命名方式，例如，如果 name == sym1

在添加标志时，协议中需要指定具体的 section -> target。对于多个 section -> target，使用逗号作为分隔符，例如：

```
# 注意
# A. entity-scheme 后使用分号
# B. section2 -> target2 前使用逗号
# C. 在 scheme1 条目中定义 section1 -> target1 和 section2 -> target2
entity1 (scheme1);
    section1 -> target1 KEEP() ALIGN(4, pre, post),
    section2 -> target2 SURROUND(sym) ALIGN(4, post) SORT()
```

合并后，如下的映射：

```
[mapping:name]
archive: lib1.a
entries:
    obj1 (noflash);
        rodata -> dram0_data KEEP() SORT() ALIGN(8) SURROUND(my_sym)
```

会在链接器脚本上生成如下输出：

```
. = ALIGN(8)
_my_sym_start = ABSOLUTE(.)
KEEP(lib1.a:obj1.*( SORT(.rodata) SORT(.rodata.*) ))
_my_sym_end = ABSOLUTE(.)
```

注意，正如在 **flag** 描述中提到的，ALIGN 和 SURROUND 的使用对顺序敏感，因此如果将两者顺序调换后用到相同的映射片段，则会生成：

```
_my_sym_start = ABSOLUTE(.)
. = ALIGN(8)
KEEP(lib1.a:obj1.*( SORT(.rodata) SORT(.rodata.*) ))
_my_sym_end = ABSOLUTE(.)
```

**按符号存放** 按符号存放可通过编译器标志 `-ffunction-sections` 和 `-ffdata-sections` 实现。ESP-IDF 默认用这些标志编译。用户若选择移除标志，便不能按符号存放。另外，即便有标志，也会有其他限制，具体取决于编译器输出的段。

比如，使用 `-ffunction-sections`，针对每个功能会输出单独的段。段的名称可以预测，即 `.text.{func_name}` 和 `.literal.{func_name}`。但是功能内的字符串并非如此，因为字符串会进入字符串池，或者使用生成的段名称。

使用 `-ffdata-sections`，对全局数据来说编译器可输出 `.data.{var_name}`、`.rodata.{var_name}` 或 `.bss.{var_name}`；因此类型 I 映射词条可以适用。但是，功能中声明的静态数据并非如此，生成的段名称是将变量名称和其他信息混合。

### 链接器脚本模板

链接器脚本模板是指定存放规则的存放位置的框架，与其他链接器脚本没有本质区别，但带有特定的标记语法，可以指示存放生成的存放规则的位置。

如需引用一个目标标记下的所有存放规则，请使用以下语法：

```
mapping[target]
```

示例：

以下示例是某个链接器脚本模板的摘录，定义了输出段 `.iram0.text`，该输出段包含一个引用目标 `iram0_text` 的标记。

```
.iram0.text :
{
    /* 标记 IRAM 空间不足 */
```

(下页继续)



```

_iram_text_start = ABSOLUTE(.);

/* 引用 iram0_text */
mapping[iram0_text]

_iram_text_end = ABSOLUTE(.);
} > iram0_0_seg

```

假设链接器脚本生成器收集到了以下片段定义：

```

[sections:text]
.text+
.literal+

[sections:iram]
.iram1+

[scheme:default]
entries:
text -> flash_text
iram -> iram0_text

[scheme:noflash]
entries:
text -> iram0_text

[mapping:freertos]
archive: libfreertos.a
entries:
* (noflash)

```

然后生成的链接器脚本的相应摘录如下：

```

.iram0.text :
{
/* 标记 IRAM 空间不足 */
_iram_text_start = ABSOLUTE(.);

/* 处理片段生成的存放规则，存放在模板标记的位置处 */
*(.iram1 .iram1.*)
*libfreertos.a:(.literal .text .literal.* .text.*)

_iram_text_end = ABSOLUTE(.);
} > iram0_0_seg

```

```
*libfreertos.a:(.literal .text .literal.* .text.*)
```

这是根据 `freertos` 映射的 `* (noflash)` 条目生成的规则。`libfreertos.a` 库下所有目标文件的所有 `text` 段会收集到 `iram0_text` 目标下（按照 `noflash` 协议），并放在模板中被 `iram0_text` 标记的地方。

```
*(.iram1 .iram1.*)
```

这是根据默认协议条目 `iram -> iram0_text` 生成的规则。默认协议指定了 `iram -> iram0_text` 条目，因此生成的规则同样也放在被 `iram0_text` 标记的地方。由于该规则是根据默认协议生成的，因此在同一目标下收集的所有规则下排在第一位。

目前使用的链接器脚本模板是 [esp\\_system/ld/esp32h2/sections.ld.in](#)，生成的脚本存放在构建目录下。

## 4.18 lwIP

ESP-IDF 使用开源的 [lwIP 轻量级 TCP/IP 协议栈](#)，该版 lwIP ([esp-lwip](#)) 相对上游项目做了修改和增补。

### 4.18.1 支持的 API

ESP-IDF 支持以下 lwIP TCP/IP 协议栈功能：

- [BSD 套接字 API](#)
- [Netconn API](#) 已启用，但暂无对 ESP-IDF 应用程序的官方支持

#### 适配的 API

**警告：** 在使用除 [BSD 套接字 API](#) 外的任意 lwIP API 时，请确保所用 API 为线程安全。请启用 [CONFIG\\_LWIP\\_CHECK\\_THREAD\\_SAFETY](#) 配置选项并运行应用程序，检查所用 API 是否线程安全。此时，lwIP 断言 TCP/IP 核心功能可以正确访问。如果未能从正确的 [lwIP FreeRTOS 任务](#) 访问，或没有正确锁定，则执行中止。建议使用 [ESP-NETIF](#) 组件与 lwIP 交互。

ESP-IDF 间接支持以下常见的 lwIP 应用程序 API：

- 动态主机设置协议 (DHCP) 服务器和客户端，由 [ESP-NETIF](#) 功能间接支持。
- 域名系统 (DNS)；获取 DHCP 地址时，可以自动分配 DNS 服务器，也可以通过 [ESP-NETIF](#) API 手动配置。

**备注：** lwIP 中的 DNS 服务器配置为全局配置，而非针对特定接口的配置。如需同时使用不同 DNS 服务器的多个网络接口，在从一个接口获取 DHCP 租约时，请注意避免意外覆盖另一个接口的 DNS 设置。

- 简单网络时间协议 (SNTP)，由 [ESP-NETIF](#) 功能间接支持，或通过 [lwip/include/apps/esp\\_sntp.h](#) 中的函数直接支持。该函数还为 [lwip/lwip/src/include/lwip/apps/sntp.h](#) 函数提供了线程安全的 API，请参阅 [SNTP 时间同步](#)。
- ICMP Ping，由 lwIP ping API 的变体支持，请参阅 [ICMP 回显](#)。
- ICMPv6 Ping，由 lwIP 的 ICMPv6 Echo API 支持，用于测试 IPv6 网络连接情况。有关详细信息，请参阅 [protocols/sockets/icmpv6\\_ping](#)。
- NetBIOS 查找，由标准的 lwIP API 支持，[protocols/http\\_server/restful\\_server](#) 示例中提供了使用 NetBIOS 在局域网中查找主机的选项。
- mDNS 与 lwIP 的默认 mDNS 使用不同实现方式，请参阅 [mDNS 服务](#)。但启用 [CONFIG\\_LWIP\\_DNS\\_SUPPORT\\_MDNS\\_QUERIES](#) 设置项后，lwIP 可以使用 `gethostbyname()` 等标准 API 和 `hostname.local` 约定查找 mDNS 主机。
- lwIP 中的 PPP 实现可用于在 ESP-IDF 中创建 PPPoS (串行 PPP) 接口。请参阅 [ESP-NETIF](#) 组件文档，使用 [esp\\_netif/include/esp\\_netif\\_defaults.h](#) 中定义的 `ESP_NETIF_DEFAULT_PPP()` 宏创建并配置 PPP 网络接口。[esp\\_netif/include/esp\\_netif\\_ppp.h](#) 中提供了其他的运行时设置。PPPoS 接口通常用于与 NBIoT/GSM/LTE 调制解调器交互。[esp\\_modem](#) 仓库还支持更多应用层友好的 API，该仓库内部使用了上述 PPP lwIP 模块。

### 4.18.2 BSD 套接字 API

BSD 套接字 API 是一种常见的跨平台 TCP/IP 套接字 API，最初源于 UNIX 操作系统的伯克利标准发行版，现已标准化为 POSIX 规范的一部分。BSD 套接字有时也称 POSIX 套接字，或伯克利套接字。

在 ESP-IDF 中，lwIP 支持 BSD 套接字 API 的所有常见用法。

## 参考

BSD 套接字的相关参考资料十分丰富，包括但不限于：

- [单一 UNIX 规范 - BSD 套接字](#)
- [伯克利套接字 - 维基百科](#)

## 示例

以下为 ESP-IDF 中使用 BSD 套接字 API 的部分示例：

- [protocols/sockets/tcp\\_server](#)
- [protocols/sockets/tcp\\_client](#)
- [protocols/sockets/udp\\_server](#)
- [protocols/sockets/udp\\_client](#)
- [protocols/sockets/udp\\_multicast](#)
- [protocols/http\\_request](#)：此简化示例使用 TCP 套接字发送 HTTP 请求，但更推荐使用 *ESP HTTP 客户端* 发送 HTTP 请求

## 支持的函数

在 ESP-IDF 中，lwIP 支持以下 BSD 套接字 API 函数，详情请参阅 [lwip/lwip/src/include/lwip/sockets.h](#)。

- `socket()`
- `bind()`
- `accept()`
- `shutdown()`
- `getpeername()`
- `getsockopt()` 和 `setsockopt()`：请参阅[套接字选项](#)
- `close()`：通过[虚拟文件系统组件](#)调用
- `read()`、`readv()`、`write()`、`writenv()`：通过[虚拟文件系统组件](#)调用
- `recv()`、`recvmsg()`、`recvfrom()`
- `send()`、`sendmsg()`、`sendto()`
- `select()`：通过[虚拟文件系统组件](#)调用
- `poll()`：ESP-IDF 通过在内部调用 `select()` 实现 `poll()`，因此，建议直接调用 `select()`
- `fcntl()`：请参阅[fcntl\(\)](#)

非标准函数：

- `ioctl()`：请参阅[ioctl\(\)](#)

---

**备注：**部分 lwIP 应用程序示例代码使用了带前缀的 BSD API，如 `lwip_socket()`，而非标准 `socket()`。ESP-IDF 支持使用以上两种形式，但更建议使用标准名称。

---

## 套接字错误处理

要使套接字应用程序保持稳定，BSD 套接字错误处理代码至关重要。套接字错误处理通常涉及以下几个方面：

- 错误检测
- 获取错误原因代码
- 根据错误原因代码处理错误

在 lwIP 中，处理套接字错误分以下两种情况：

- 套接字 API 返回错误，请参阅[套接字 API 错误](#)。

- `select(int maxfdp1, fd_set *readset, fd_set *writerset, fd_set *exceptset, struct timeval *timeout)` 包含异常描述符，表示套接字出现错误，详情请参阅[select\(\) 错误](#)。

### 套接字 API 错误 错误检测

- 根据返回值判断套接字 API 是否出错。

#### 获取错误原因代码

- 套接字 API 出错时，其返回值不包含失败原因，可以通过应用程序访问 `errno` 获取错误原因代码。不同返回值具有不同含义，详情请参阅[套接字错误原因代码](#)。

示例：

```
int err;
int sockfd;

if (sockfd = socket(AF_INET, SOCK_STREAM, 0) < 0) {
    // 从 errno 获取错误代码
    err = errno;
    return err;
}
```

### select() 错误 错误检测

- `select()` 包含异常描述符时的套接字错误。

#### 获取错误原因代码

- 如果 `select()` 报告套接字错误，访问 `errno` 无法获取错误原因代码，此时，应调用 `getsockopt()`。因为当 `select()` 包含异常描述符时，错误代码不会直接赋值给 `errno`。

---

**备注：** `getsockopt()` 函数具有以下原型：`int getsockopt(int s, int level, int optname, void *optval, socklen_t *optlen)`。原型可以获取任意类型、任意状态套接字选项的当前值，并将结果存储在 `optval` 中。例如，要在套接字上获取错误代码，可以通过 `getsockopt(sockfd, SOL_SOCKET, SO_ERROR, &err, &optlen)` 实现。

---

示例：

```
int err;

if (select(sockfd + 1, NULL, NULL, &exfds, &tval) <= 0) {
    err = errno;
    return err;
} else {
    if (FD_ISSET(sockfd, &exfds)) {
        // 使用 getsockopt() 获取 select() 异常集
        int optlen = sizeof(int);
        getsockopt(sockfd, SOL_SOCKET, SO_ERROR, &err, &optlen);
        return err;
    }
}
```

**套接字错误原因代码** 以下是常见错误代码列表。有关标准 POSIX/C 错误代码的详细列表，请参阅 [newlib errno.h](#) 和特定平台扩展 [newlib/platform\\_include/errno.h](#)。

错误代码	描述
ECONNREFUSED	拒绝连接
EADDRINUSE	地址已在使用中
ECONNABORTED	软件导致连接中断
ENETUNREACH	网络不可达
ENETDOWN	未配置网络接口
ETIMEDOUT	连接超时
EHOSTDOWN	主机已关闭
EHOSTUNREACH	主机不可达
EINPROGRESS	连接已在进行中
EALREADY	套接字已连接
EDESTADDRREQ	需要目标地址
EPROTONOSUPPORT	未知协议

### 套接字选项

`getsockopt()` 支持获取套接字选项，`setsockopt()` 支持设置套接字选项。

在 ESP-IDF 中，lwIP 并不支持所有标准套接字选项。以下套接字选项受 lwIP 支持：

**常见选项** 与级别参数 `SOL_SOCKET` 一起使用。

- `SO_REUSEADDR`：如果 `CONFIG_LWIP_SO_REUSE` 已启用，则该选项可用，可以设置 `CONFIG_LWIP_SO_REUSE_RXTOALL` 自定义其行为
- `SO_KEEPALIVE`
- `SO_BROADCAST`
- `SO_ACCEPTCONN`
- `SO_RCVBUF`：如果 `CONFIG_LWIP_SO_RCVBUF` 已启用，则该选项可用
- `SO_SNDTIMEO / SO_RCVTIMEO`
- `SO_ERROR`：此选项仅支持与 `select()` 一起使用，请参阅[套接字错误处理](#)
- `SO_TYPE`
- `SO_NO_CHECK`：仅适用于 UDP 套接字

**IP 选项** 与级别参数 `IPPROTO_IP` 一起使用。

- `IP_TOS`
- `IP_TTL`
- `IP_PKTINFO`：如果 `CONFIG_LWIP_NETBUF_RECVINFO` 已启用，则该选项可用

对于组播 UDP 套接字：

- `IP_MULTICAST_IF`
- `IP_MULTICAST_LOOP`
- `IP_MULTICAST_TTL`
- `IP_ADD_MEMBERSHIP`
- `IP_DROP_MEMBERSHIP`

**TCP 选项** 只适用于 TCP 套接字，与级别参数 `IPPROTO_TCP` 一起使用。

- `TCP_NODELAY`

与 TCP 保活探测相关的选项：

- `TCP_KEEPALIVE`：整数值，以毫秒为单位，设置 TCP 保活探测周期
- `TCP_KEEPIDLE`：整数值，以秒为单位，与 `TCP_KEEPALIVE` 相同
- `TCP_KEEPINTVL`：整数值，以秒为单位，设置保活探测间隔
- `TCP_KEEPCNT`：整数值，设置超时前进行的保活探测次数

**IPv6 选项** 只适用于 IPv6 套接字，与级别参数 `IPPROTO_IPV6` 一起使用。

- `IPV6_CHECKSUM`
- `IPV6_V6ONLY`

对于组播 IPv6 UDP 套接字：

- `IPV6_JOIN_GROUP / IPV6_ADD_MEMBERSHIP`
- `IPV6_LEAVE_GROUP / IPV6_DROP_MEMBERSHIP`
- `IPV6_MULTICAST_IF`
- `IPV6_MULTICAST_HOPS`
- `IPV6_MULTICAST_LOOP`

### `fcntl()`

`fcntl()` 函数是设置与文件描述符相关选项的标准 API。在 ESP-IDF 中，使用[虚拟文件系统组件](#)层实现该函数。

当文件描述符为套接字时，仅支持以下 `fcntl()` 值：

- `O_NONBLOCK` 用于置位或清除非阻塞 I/O 模式。`O_NDELAY` 也受支持，与前者功能相同。
- `O_RDONLY`、`O_WRONLY`、`O_RDWR` 标志用于不同的读或写模式，只能用 `F_GETFL` 读取，且无法用 `F_SETFL` 设置。根据连接状况，即两端开启或任一端关闭，TCP 套接字会返回不同模式，而 UDP 套接字始终返回 `O_RDWR`。

### `ioctl()`

`ioctl()` 函数以半标准的方式访问 TCP/IP 协议栈的部分内部功能。ESP-IDF 通过[虚拟文件系统组件](#)层实现此函数。

当文件描述符为套接字时，仅支持以下 `ioctl()` 值：

- `FIONREAD` 返回套接字网络 buffer 中接收的待处理字节数。
- `FIONBIO` 和 `fcntl(fd, F_SETFL, O_NONBLOCK, ...)` 相同，也可置位或清除套接字非阻塞 I/O 状态。

## 4.18.3 Netconn API

lwIP 支持两种较低级别的 API 和 BSD 套接字 API，即 Netconn API 和 Raw API。

lwIP Raw API 适用于单线程设备，无法在 ESP-IDF 中使用。

Netconn API 用于在 lwIP 内部使用 BSD 套接字 API，支持直接从 ESP-IDF 的应用程序调用。相较于 BSD 套接字 API，该 API 占用资源更少。无需提前将数据复制到内部 lwIP buffer，即可使用 Netconn API 发送和接收数据。

---

**重要：**乐鑫尚未在 ESP-IDF 中测试 Netconn API，因此 **此功能已启用，但尚无官方支持**。对于某些功能，可能只有在从 BSD 套接字 API 中使用时才能正常运作。

---

有关 Netconn API 的更多信息，请参阅 [lwip/lwip/src/include/lwip/api.h](#) 和 [lwIP 应用程序 \\*\\*非官方\\*\\* 开发手册的一部分](#)。

## 4.18.4 lwIP FreeRTOS 任务

lwIP 创建了专用的 TCP/IP FreeRTOS 任务，处理来自其他任务的套接字 API 请求。

以下配置项可用于修改任务，并调整向 TCP/IP 任务发送数据和从 TCP/IP 任务接收数据的队列（邮箱）：

- `CONFIG_LWIP_TCPIP_RECVMBOX_SIZE`

- [CONFIG\\_LWIP\\_TCPIP\\_TASK\\_STACK\\_SIZE](#)
- [CONFIG\\_LWIP\\_TCPIP\\_TASK\\_AFFINITY](#)

### 4.18.5 IPv6 支持

系统支持 IPv4 和 IPv6 的双栈功能，并默认启用这两种协议。如无需要，可将其禁用，请参阅[最小内存使用](#)。

在 ESP-IDF 中，IPv6 支持仅限 **无状态自动配置**，不支持 **有状态配置**，上游的 lwIP 也不支持 **有状态配置**。

IPv6 地址配置通过以下协议或服务定义：

- 支持 **SLAAC IPv6** 无状态地址配置 (RFC-2462)
- 支持 **DHCPv6 IPv6** 动态主机配置协议 (RFC-8415)

以上两种地址配置默认处于禁用状态，设备仅使用链路本地地址或静态定义的地址。

#### 无状态自动配置流程

要通过路由器通告协议启用地址自动配置，请启用此配置选项：

- [CONFIG\\_LWIP\\_IPV6\\_AUTOCONFIG](#)

该配置选项启用了所有网络接口的 IPv6 自动配置。而在上游 lwIP 中，需要设置 `netif->ip6_autoconfig_enabled=1`，针对每个 netif 明确启用自动配置。

#### DHCPv6

lwIP 中的 DHCPv6 非常简单，仅支持无状态配置，可通过以下配置选项启用：

- [CONFIG\\_LWIP\\_IPV6\\_DHCP6](#)

由于 DHCPv6 仅在无状态配置下工作，因此还需要通过[CONFIG\\_LWIP\\_IPV6\\_AUTOCONFIG](#) 启用[无状态自动配置流程](#)。

此外，还需要使用以下语句，在应用程序代码中明确启用 DHCPv6：

```
dhcp6_enable_stateless(netif);
```

#### IPv6 自动配置中的 DNS 服务器

要自动配置 DNS 服务器，尤其是在仅使用 IPv6 的网络中配置，可使用以下两种选项：

- 递归域名系统 (DNS)，属于邻居发现协议 (NDP) 的一部分，可使用[无状态自动配置流程](#)。  
DNS 服务器的数量必须设置为[CONFIG\\_LWIP\\_IPV6\\_RDNSS\\_MAX\\_DNS\\_SERVERS](#)，该选项默认禁用，即置位为 0。
- DHCPv6 无状态配置，使用[DHCPv6](#) 配置 DNS 服务器。注意，此配置假设 IPv6 路由通告标志 (RFC-5175) 进行了如下设置
  - 管理地址配置标志 (Managed Address Configuration Flag) = 0
  - 其他配置标志 (Other Configuration Flag) = 1

### 4.18.6 ESP-lwIP 自定义修改

#### 补充内容

以下代码均为新增代码，尚未包含至上游 lwIP 版本：



**线程安全的套接字** 调用 `close()` 可以从不同于创建套接字的线程中关闭该套接字。该调用持续阻塞，直至其他任务中使用该套接字的函数调用返回。

然而，任务处于主动等待 `select()` 或 `poll()` API 的状态时，无法删除该任务。销毁任务前，这些 API 必须先退出，否则可能会破坏内部数据结构，并导致后续 lwIP 崩溃。这些 API 在栈上分配了全局引用的回调指针，因此，在未完全卸载栈的情况下删除任务时，lwIP 仍可以持有指向已删除栈的指针。

**按需定时器** lwIP 中的 IGMP 和 MLD6 功能都会初始化一个定时器，以便在特定时间触发超时事件。

即便没有活动的超时事件，lwIP 也会默认始终启用这些定时器，增加自动 Light-sleep 模式下的 CPU 使用率和功耗。ESP-LWIP 则默认将各定时器设置为按需使用，即只有在有待处理事件时启用。

如果要返回默认 lwIP 设置，即始终启用定时器，请禁用 `CONFIG_LWIP_TIMERS_ONDEMAND`。

**lwIP 定时器 API** 不使用 Wi-Fi 时，可以通过 API 关闭 lwIP 定时器，减少功耗。

以下 API 函数均受支持，详情请参阅 `lwip/lwip/src/include/lwip/timeouts.h`。

- `sys_timeouts_init()`
- `sys_timeouts_deinit()`

### 附加套接字选项

- 目前已实现部分标准 IPv4 和 IPv6 组播套接字选项，详情请参阅 [套接字选项](#)。
- 使用 `IPV6_V6ONLY` 套接字选项，可以设置仅使用 IPv6 的 UDP 和 TCP 套接字，而 lwIP 一般只支持 TCP 套接字。

### IP 层特性

- IPv4 源地址基础路由实现不同
- 支持 IPv4 映射 IPv6 地址

**NAPT 和端口转发** 支持 IPv4 网络地址端口转换 (NAPT) 和端口转发。然而，仅限于单个接口启用 NAPT。

- 要在两个接口之间使用 NAPT 转发数据包，必须在连接到目标网络的接口上启用 NAPT。例如，为了通过 Wi-Fi 接口为以太网流量启用互联网访问，必须在以太网接口上启用 NAPT。
- NAPT 的使用示例可参考 [network/vlan\\_support](#)。

**自定义 lwIP 钩子** 原始 lwIP 支持通过 `LWIP_HOOK_FILENAME` 实现自定义的编译时修改。ESP-IDF 端口层已使用该文件，但仍支持通过由宏 `ESP_IDF_LWIP_HOOK_FILENAME` 定义的头文件，在 ESP-IDF 中包含并实现自定义添加。以下示例展示了向构建过程添加自定义钩子文件的过程，其中钩子文件名为 `my_hook.h`，位于项目的主文件夹中：

```
idf_component_get_property(lwip lwip COMPONENT_LIB)
target_compile_options(${lwip} PRIVATE "-I${PROJECT_DIR}/main")
target_compile_definitions(${lwip} PRIVATE "-DESP_IDF_LWIP_HOOK_FILENAME=\"my_hook.h\"")
```

**使用 ESP-IDF 构建系统自定义 lwIP 选项** 组件配置菜单可以配置常见的 lwIP 选项，但是一些自定义选项需要通过命令行添加。CMake 函数 `target_compile_definitions()` 可以用于定义宏，示例如下：

```
idf_component_get_property(lwip lwip COMPONENT_LIB)
target_compile_definitions(${lwip} PRIVATE "-DETHARP_SUPPORT_VLAN=1")
```



使用这种方法可能无法定义函数式宏。虽然 GCC 支持此类定义，但是未必所有编译器都会接受。为了解决这一限制，可以使用 `add_definitions()` 函数为整个项目定义宏，例如 `add_definitions("-DFALLBACK_DNS_SERVER_ADDRESS(addr)=\"IP_ADDR4((addr), 8, 8, 8, 8)\")`。

另一种方法是在头文件中定义函数式宏，该头文件将预先包含在 lwIP 钩子文件中，请参考[自定义 lwIP 钩子](#)。

## 限制

如[适配的 API](#)所述，ESP-IDF 中的 lwIP 扩展功能仍然受到全局 DNS 限制的影响。为了在应用程序代码中解决这一限制，可以使用 `FALLBACK_DNS_SERVER_ADDRESS()` 宏定义所有接口能够访问的全局 DNS 备用服务器，或者单独维护每个接口的 DNS 服务器，并在默认接口更改时重新配置。

在 UDP 套接字上重复调用 `send()` 或 `sendto()` 最终可能会导致错误。此时 `errno` 报错为 `ENOMEM`，错误原因是底层网络接口驱动程序中的 `buffer` 大小有限。当所有驱动程序的传输 `buffer` 已满时，UDP 传输事务失败。如果应用程序需要发送大量 UDP 数据报，且不希望发送方丢弃数据报，建议检查错误代码，采用短延迟的重传机制。

## 4.18.7 性能优化

影响 TCP/IP 性能因素较多，可以从多方面进行优化。经调整，ESP-IDF 的默认设置已在 TCP/IP 的吞吐量、响应时间和内存使用间达到平衡。

### 最大吞吐量

乐鑫使用 `iperf` 测试应用程序 <https://iperf.fr/> 测试了 ESP-IDF 的 TCP/IP 吞吐量。关于实际测试和优化配置的更多信息，请参考[提高网络速度](#)。

---

**重要：** 建议逐步应用更改，并在每次更改后，通过特定应用程序的工作负载检查性能。

---

- 如果系统中有许多任务抢占 CPU 时间，可以考虑调整 lwIP 任务的 CPU 亲和性 (`CONFIG_LWIP_TCPIP_TASK_AFFINITY`)，并以固定优先级 (18, `ESP_TASK_TCPIP_PRIO`) 运行。为优化 CPU 使用，可以考虑将竞争任务分配给不同核心，或将其优先级调整至较低值。有关内置任务优先级的更多详情，请参阅[内置任务优先级](#)。
- 如果使用仅带有套接字参数的 `select()` 函数，禁用 `CONFIG_VFS_SUPPORT_SELECT` 可以更快地调用 `select()`。
- 如果有足够的空闲 IRAM，可以选择 `CONFIG_LWIP_IRAM_OPTIMIZATION` 和 `CONFIG_LWIP_EXTRA_IRAM_OPTIMIZATION`，提高 TX/RX 吞吐量。

### 最低延迟

除增加 `buffer` 大小外，大多数增加吞吐量的设置会减少 lwIP 函数占用 CPU 的时间，进而降低延迟，缩短响应时间。

- 对于 TCP 套接字，lwIP 支持设置标准的 `TCP_NODELAY` 标记以禁用 Nagle 算法。

### 最小内存使用

由于 RAM 按需从堆中分配，多数 lwIP 的 RAM 使用也按需分配。因此，更改 lwIP 设置减少 RAM 使用时，或许不会改变空闲时的 RAM 使用量，但可以改变高峰期的 RAM 使用量。

- 减少 `CONFIG_LWIP_MAX_SOCKETS` 可以减少系统中的最大套接字数量。更改此设置，会让处于 `WAIT_CLOSE` 状态的 TCP 套接字在需要打开新套接字时更快地关闭和复用，进一步降低峰值 RAM 使用量。

- 减少 `CONFIG_LWIP_TCPIP_RECVMBOX_SIZE`、`CONFIG_LWIP_TCP_RECVMBOX_SIZE` 和 `CONFIG_LWIP_UDP_RECVMBOX_SIZE` 可以减少 RAM 使用量，但会影响吞吐量，具体取决于使用情况。
- 减少 `CONFIG_LWIP_TCP_ACCEPTMBOX_SIZE` 可以通过限制同时接受的连接数来减少 RAM 使用量。
- 减少 `CONFIG_LWIP_TCP_MSL` 和 `CONFIG_LWIP_TCP_FIN_WAIT_TIMEOUT` 可以减少系统中的最大分段寿命，同时会使处于 `TIME_WAIT` 和 `FIN_WAIT_2` 状态的 TCP 套接字能更快地关闭和复用。
- 禁用 `CONFIG_LWIP_IPV6` 可以在系统启动时节省大约 39 KB 的固件大小和 2 KB 的 RAM，并在运行 TCP/IP 栈时节省 7 KB 的 RAM。如果无需支持 IPv6，可以禁用 IPv6，减少 flash 和 RAM 占用。
- 禁用 `CONFIG_LWIP_IPV4` 可以在系统启动时节省大约 26 KB 的固件大小和 600 B 的 RAM，并在运行 TCP/IP 栈时节省 6 KB 的 RAM。如果本地网络仅支持 IPv6 配置，可以禁用 IPv4，减少 flash 和 RAM 占用。

**最大 buffer 使用** lwIP 消耗的最大堆内存即 lwIP 驱动程序 **理论上可能消耗的最大内存**，通常取决于以下因素：

- 创建 UDP 连接所需的内存： `lwip_udp_conn`
- 创建 TCP 连接所需的内存： `lwip_tcp_conn`
- 应用程序拥有的 UDP 连接数量： `lwip_udp_con_num`
- 应用程序拥有的 TCP 连接数量： `lwip_tcp_con_num`
- TCP 的 TX 窗口大小： `lwip_tcp_tx_win_size`
- TCP 的 RX 窗口大小： `lwip_tcp_rx_win_size`

因此，lwIP 消耗的最大堆内存可以用以下公式计算：  

$$\text{lwip\_dynamic\_peek\_memory} = (\text{lwip\_udp\_con\_num} * \text{lwip\_udp\_conn}) + (\text{lwip\_tcp\_con\_num} * (\text{lwip\_tcp\_tx\_win\_size} + \text{lwip\_tcp\_rx\_win\_size} + \text{lwip\_tcp\_conn}))$$

某些基于 TCP 的应用程序只需要一个 TCP 连接。然而，当出现错误（如发送失败）时，应用程序可能会关闭此 TCP 连接，并创建一个新的连接。根据 TCP 状态机和 RFC793，关闭 TCP 连接可能需要很长时间，这可能导致系统中同时存在多个 TCP 连接。

## 4.19 存储器类型

ESP32-H2 芯片具有不同类型的存储器和灵活的存储器映射特性，本小节将介绍 ESP-IDF 默认如何使用这些功能。

ESP-IDF 区分了指令总线 (IRAM、IROM、RTC FAST memory) 和数据总线 (DRAM、DROM)。指令存储器是可执行的，只能通过 4 字节对齐字读取或写入。数据存储器不可执行，可以通过单独的字节操作访问。有关总线的更多信息，请参阅 [ESP32-H2 技术参考手册 > 系统和存储器 \[PDF\]](#)。

### 4.19.1 DRAM (数据 RAM)

非常量静态数据 (.data 段) 和零初始化数据 (.bss 段) 由链接器放入内部 SRAM 作为数据存储。此区域中的剩余空间可在程序运行时用作堆。

**备注：**静态分配的 DRAM 的最大值也会因编译应用程序的 *IRAM (指令 RAM)* 大小而减小。运行时可用的堆内存会因应用程序的总静态 IROM 和 DRAM 使用而减少。

常量数据也可能被放入 DRAM，例如当它被用于 non-flash-safe ISR 时（具体请参考 [如何将代码放入 IROM](#)）。

#### “noinit” DRAM

可以将 `__NOINIT_ATTR` 宏用作属性，从而将数据放入 .noinit 部分。放入该部分的值在启动时不会被初始化，在软件重启后也会保持值不变。

示例:

```
__NOINIT_ATTR uint32_t noinit_data;
```

## 4.19.2 IRAM (指令 RAM)

**备注:** 内部 SRAM 中不用于指令 RAM 的部分都会作为 **DRAM (数据 RAM)** 供静态数据和动态分配 (堆) 使用。

### 何时需要将代码放入 IRAM

以下情况时应将部分应用程序放入 IRAM:

- 如果在注册中断处理程序时使用了 `ESP_INTR_FLAG_IRAM`, 则中断处理程序必须要放入 IRAM。更多信息可参考 [IRAM 安全中断处理程序](#)。
- 可将一些时序关键代码放入 IRAM, 以减少从 flash 中加载代码造成的相关损失。ESP32-H2 通过 MMU 缓存从 flash 中读取代码和数据。在某些情况下, 将函数放入 IRAM 可以减少由缓存未命中造成的延迟, 从而显著提高函数的性能。

### 如何将代码放入 IRAM

借助链接器脚本, 一些代码会被自动放入 IRAM 区域中。

如果要将某些特定的应用程序代码放入 IRAM, 可以使用 [链接器脚本生成机制](#) 功能并在组件中添加链接器脚本片段文件, 在该片段文件中, 可以给整个目标源文件或其中的个别函数打上 `noflash` 标签。更多信息可参考 [链接器脚本生成机制](#)。

或者, 也可以通过使用 `IRAM_ATTR` 宏在源代码中指定需要放入 IRAM 的代码:

```
#include "esp_attr.h"

void IRAM_ATTR gpio_isr_handler(void* arg)
{
    // ...
}
```

放入 IRAM 后可能会导致 IRAM 安全中断处理程序出现问题:

- `IRAM_ATTR` 函数中的字符串或常量可能没有自动放入 RAM 中, 这时可以使用 `DRAM_ATTR` 属性进行标记, 或者也可以使用链接器脚本方法将它们自动放入 RAM 中。

```
void IRAM_ATTR gpio_isr_handler(void* arg)
{
    const static DRAM_ATTR uint8_t INDEX_DATA[] = { 45, 33, 12, 0 };
    const static char *MSG = DRAM_STR("I am a string stored in RAM");
}
```

注意, 具体哪些数据需要被标记为 `DRAM_ATTR` 可能很难确定。如果没有被标记为 `DRAM_ATTR`, 某些变量或表达式有时会被编译器别为常量 (即使它们没有被标记为 `const`) 并将其放入 flash 中。

- GCC 的优化会自动生成跳转表或 `switch/case` 查找表, 并将这些表放在 flash 中。IDF 默认在编译所有文件时使用 `-fno-jump-tables -fno-tree-switch-conversion` 标志来避免这种情况。

可以为不需要放置在 IRAM 中的单个源文件重新启用跳转表优化。关于如何在编译单个源文件时添加 `-fno-jump-tables -fno-tree-switch-conversion` 选项, 请参考 [组件编译控制](#)。

### 4.19.3 IROM (代码从 flash 中运行)

如果一个函数没有被显式地声明放在 IRAM 或者 RTC 存储器中，则它会放在 flash 中。由于 IRAM 空间有限，应用程序的大部分二进制代码都需要放入 IROM 中。

在启动过程中，从 IRAM 中运行的引导加载程序配置 MMU flash 缓存，将应用程序的指令代码区域映射到指令空间。通过 MMU 访问的 flash 使用一些内部 SRAM 进行缓存，访问缓存的 flash 数据与访问其他类型的内部存储器一样快。

### 4.19.4 DROM (数据存储在 flash 中)

默认情况下，链接器将常量数据放入一个映射到 MMU flash 缓存的区域中。这与 IROM (代码从 flash 中运行) 部分相同，但此处用于只读数据而不是可执行代码。

唯一没有默认放入 DROM 的常量数据是被编译器嵌入到应用程序代码中的字面常量。这些被放置在周围函数的可执行指令中。

DRAM\_ATTR 属性可以用来强制将常量从 DROM 放入 DRAM (数据 RAM) 部分 (见上文)。

### 4.19.5 RTC FAST memory (RTC 快速存储器)

**备注：**对于 ESP32-H2，RTC 存储器已被重新命名为 LP (低功耗) 存储器。在与 ESP32-H2 相关的 IDF 代码、文档以及技术参考手册中，可能会出现这两个术语混用的情况。

RTC FAST memory 的同一区域既可以作为指令存储器也可以作为数据存储器进行访问。从深度睡眠模式唤醒后必须要运行的代码要放在 RTC 存储器中，更多信息请查阅文档[深度睡眠](#)。

除非禁用 `CONFIG_ESP_SYSTEM_ALLOW_RTC_FAST_MEM_AS_HEAP` 选项，否则剩余的 RTC FAST memory 会被添加到堆中。该部分内存可以和 DRAM (数据 RAM) 互换使用，但是访问速度稍慢一点。

### 4.19.6 具备 DMA 功能

大多数的 DMA 控制器 (比如 SPI、sdmmc 等) 都要求发送/接收缓冲区放在 DRAM 中，并且按字对齐。我们建议将 DMA 缓冲区放在静态变量而不是堆栈中。使用 DMA\_ATTR 宏可以声明该全局/本地的静态变量具备 DMA 功能，例如：

```
DMA_ATTR uint8_t buffer[]="I want to send something";

void app_main()
{
    // 初始化代码
    spi_transaction_t temp = {
        .tx_buffer = buffer,
        .length = 8 * sizeof(buffer),
    };
    spi_device_transmit(spi, &temp);
    // 其它程序
}
```

或者：

```
void app_main()
{
    DMA_ATTR static uint8_t buffer[] = "I want to send something";
    // 初始化代码
    spi_transaction_t temp = {
        .tx_buffer = buffer,
```

(下页继续)

```
.length = 8 * sizeof(buffer),
};
spi_device_transmit(spi, &temp);
// 其它程序
}
```

也可以通过使用 `MALLOC_CAP_DMA` 标志来动态分配具备 DMA 能力的内存缓冲区。

### 4.19.7 在堆栈中放置 DMA 缓冲区

可以在堆栈中放置 DMA 缓冲区，但建议尽量避免。如果实在有需要的话，请注意以下几点：

- 在函数中使用 `WORD_ALIGNED_ATTR` 宏来修饰变量，将其放在适当的位置上，比如：

```
void app_main()
{
    uint8_t stuff;
    WORD_ALIGNED_ATTR uint8_t buffer[] = "I want to send something"; //否则 ↪
    ↪buffer 会被存储在 stuff 变量后面
    // 初始化代码
    spi_transaction_t temp = {
        .tx_buffer = buffer,
        .length = 8 * sizeof(buffer),
    };
    spi_device_transmit(spi, &temp);
    // 其它程序
}
```

## 4.20 OpenThread

OpenThread 是在 802.15.4 MAC 层上运行的 IP 协议栈，支持 mesh 网络，具有低功耗特性。

### 4.20.1 OpenThread 协议栈运行模式

在乐鑫的芯片上，OpenThread 可按以下模式运行：

#### 独立节点模式

在此模式下，完整的 OpenThread 协议栈及其应用层在同一芯片上运行，适用于支持 15.4 无线通信协议的芯片，如 ESP32-H2, ESP32-C6。

#### 无线协处理器 (RCP) 模式

在此模式下，芯片通过连接到运行 OpenThread IP 协议栈的另一个主机，代表主机发送和接收 15.4 数据包。该模式适用于支持 15.4 无线通信协议的芯片，如 ESP32-H2, ESP32-C6。对于芯片和主机之间的通信方式，目前 ESP-IDF 支持 SPI 或 UART。考虑到传输延迟，建议使用 SPI。

## OpenThread 主机模式

在此模式下，不支持 15.4 无线通信协议的芯片可以连接到 RCP，并在主机模式下运行 OpenThread。这种模式支持在 Wi-Fi 芯片上（如 ESP32、ESP32-S2、ESP32-S3 和 ESP32-C3 等）运行 OpenThread。下图展示了设备在不同模式下的工作方式：



图 42: OpenThread 设备模式

### 4.20.2 编写 OpenThread 应用程序

要学习编写 OpenThread 应用程序，可以从 OpenThread 应用示例 [openthread/ot\\_cli](#) 开始。该示例中展示了简单的 OpenThread 网络组网流程，以及在 OpenThread 网络上，如何实现基于套接字的服务器和客户端之间的简单通信。

#### 初始化 OpenThread 协议栈所需的准备

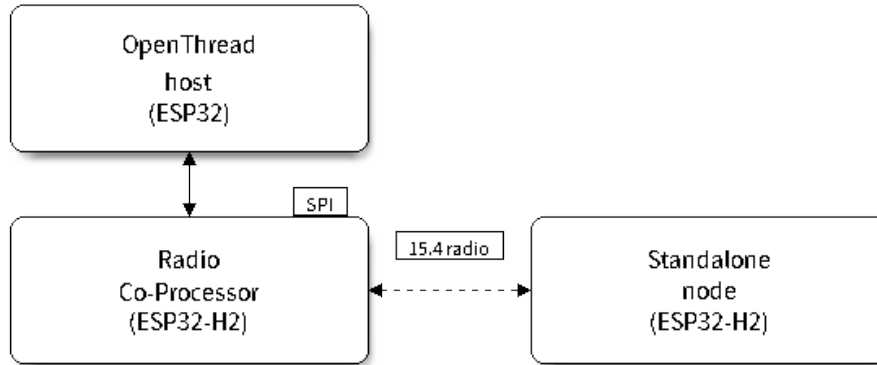
- s1.1: 主任务调用 `esp_vfs_eventfd_register()`，初始化 eventfd 虚拟文件系统。eventfd 文件系统用于实现 OpenThread 协议栈中的任务通知。
- s1.2: 主任务调用 `nvs_flash_init()` 初始化 NVS，即 Thread 网络数据的存储位置。
- s1.3: **可选**。主任务调用 `esp_netif_init()`，为 Thread 创建网络接口。
- s1.4: 主任务调用 `esp_event_loop_create()` 创建系统事件任务，并初始化应用程序事件的回调函数。

#### OpenThread 协议栈初始化

- s2.1: 调用 `esp_openthread_init()` 初始化 OpenThread 协议栈。

#### OpenThread 网络接口初始化

以下为 **可选**步骤，仅在应用程序需为 Thread 创建网络接口时使用。

- s3.1: 使用 `ESP_NETIF_DEFAULT_OPENTHREAD` 调用 `esp_netif_new()`，创建网络接口。
- s3.2: 调用 `esp_openthread_netif_glue_init()`，创建 OpenThread 网络接口处理程序。
- s3.3: 调用 `esp_netif_attach()` 将处理程序附加到网络接口。



## OpenThread 主循环

- s4.3: 调用 `esp_openthread_launch_mainloop()` 启动 OpenThread 主循环。注意，OpenThread 主循环属于忙等循环，仅在 OpenThread 协议栈终止后返回。

## 调用 OpenThread API

OpenThread API 非线程安全。当从其他任务中调用 OpenThread API 时，请确保以 `esp_openthread_lock_acquire()` 获取锁，并在之后以 `esp_openthread_lock_release()` 释放锁。

## 卸载 OpenThread 协议栈

要在应用程序中卸载 OpenThread 协议栈，请遵循以下步骤：

- 如果创建了 OpenThread 网络接口，请调用 `esp_netif_destroy()` 和 `esp_openthread_netif_glue_deinit()` 卸载 OpenThread 协议栈。
- 调用 `esp_openthread_deinit()` 卸载 OpenThread 协议栈。

### 4.20.3 OpenThread 边界路由器

OpenThread 边界路由器连接了 Thread 网络和其他 IP 网络，提供 IPv6 连通性、服务注册和委托功能。

要在 ESP 芯片上启用 OpenThread 边界路由器，需要将 RCP 连接到具备 Wi-Fi 功能的芯片上，如 ESP32。

在初始化过程中，调用 `esp_openthread_border_router_init()` 会启用所有边界路由功能。

要了解更多有关边界路由器的详细信息，请参阅 [openthread/ot\\_br](#) 示例和其中的 README 文件。

## 4.21 分区表

### 4.21.1 概述

每片 ESP32-H2 的 flash 可以包含多个应用程序，以及多种不同类型的数据（例如校准数据、文件系统数据、参数存储数据等）。因此，我们在 flash 的默认偏移地址 0x8000 处烧写一张分区表。

分区表的长度为 0xC00 字节，最多可以保存 95 条分区表条目。MD5 校验和附加在分区表之后，用于在运行时验证分区表的完整性。分区表占据了整个 flash 扇区，大小为 0x1000 (4 KB)。因此，它后面的任何分区至少需要位于 (默认偏移地址) + 0x1000 处。

分区表中的每个条目都包括以下几个部分：Name（标签）、Type（app、data 等）、SubType 以及在 flash 中的偏移量（分区的加载地址）。

在使用分区表时，最简单的方法就是打开项目配置菜单 (`idf.py menuconfig`)，并在 `CONFIG_PARTITION_TABLE_TYPE` 下选择一个预定义的分区表：

- "Single factory app, no OTA"
- "Factory app, two OTA definitions"

在以上两种选项中，出厂应用程序均将被烧录至 flash 的 0x10000 偏移地址处。这时，运行 `idf.py partition-table`，即可以打印当前使用分区表的信息摘要。

### 4.21.2 内置分区表

以下是“Single factory app, no OTA”选项的分区表信息摘要：

```
# ESP-IDF Partition Table
# Name, Type, SubType, Offset, Size, Flags
nvs, data, nvs, 0x9000, 0x6000,
phy_init, data, phy, 0xf000, 0x1000,
factory, app, factory, 0x10000, 1M,
```

- flash 的 0x10000 (64 KB) 偏移地址处存放一个标记为“factory”的二进制应用程序，且启动加载器将默认加载这个应用程序。
- 分区表中还定义了两个数据区域，分别用于存储 NVS 库专用分区和 PHY 初始化数据。

以下是“Factory app, two OTA definitions”选项的分区表信息摘要：

```
# ESP-IDF Partition Table
# Name, Type, SubType, Offset, Size, Flags
nvs, data, nvs, 0x9000, 0x4000,
otadata, data, ota, 0xd000, 0x2000,
phy_init, data, phy, 0xf000, 0x1000,
factory, app, factory, 0x10000, 1M,
ota_0, app, ota_0, 0x110000, 1M,
ota_1, app, ota_1, 0x210000, 1M,
```

- 分区表中定义了三个应用程序分区，这三个分区的类型都被设置为“app”，但具体 app 类型不同。其中，位于 0x10000 偏移地址处的为出厂应用程序 (factory)，其余两个为 OTA 应用程序 (ota\_0, ota\_1)。
- 新增了一个名为“otadata”的数据分区，用于保存 OTA 升级时需要的数据。启动加载器会查询该分区的数据，以判断该从哪个 OTA 应用程序分区加载程序。如果“otadata”分区为空，则会执行出厂程序。

### 4.21.3 创建自定义分区表

如果在 menuconfig 中选择了“Custom partition table CSV”，则还需要输入该分区表的 CSV 文件在项目中的路径。CSV 文件可以根据需要，描述任意数量的分区信息。

CSV 文件的格式与上面摘要中打印的格式相同，但是在 CSV 文件中并非所有字段都是必需的。例如下面是一个自定义的 OTA 分区表的 CSV 文件：

```
# Name, Type, SubType, Offset, Size, Flags
nvs, data, nvs, 0x9000, 0x4000
otadata, data, ota, 0xd000, 0x2000
phy_init, data, phy, 0xf000, 0x1000
factory, app, factory, 0x10000, 1M
ota_0, app, ota_0, , 1M
ota_1, app, ota_1, , 1M
nvs_key, data, nvs_keys, , 0x1000
```

- 字段之间的空格会被忽略，任何以 # 开头的行（注释）也会被忽略。
- CSV 文件中的每个非注释行均为一个分区定义。
- 每个分区的 Offset 字段可以为空，gen\_esp32part.py 工具会从分区表位置的后面开始自动计算并填充该分区的偏移地址，同时确保每个分区的偏移地址正确对齐。

#### Name 字段

Name 字段可以是任何有意义的名称，但不能超过 16 个字节，其中包括一个空字节（之后的内容将被截断）。该字段对 ESP32-H2 并不是特别重要。



## Type 字段

Type 字段可以指定为 `app` (0x00) 或者 `data` (0x01)，也可以直接使用数字 0-254（或者十六进制 0x00-0xFE）。注意，0x00-0x3F 不得使用（预留给 `esp-idf` 的核心功能）。

如果你的应用程序需要以 ESP-IDF 尚未支持的格式存储数据，请在 0x40-0xFE 内添加一个自定义分区类型。

参考 `esp_partition_type_t` 关于 `app` 和 `data` 分区的枚举定义。

如果用 C++ 编写，那么指定一个应用程序定义的分区类型，需要在 `esp_partition_type_t` 中使用整数，从而与分区 API 一起使用。例如：

```
static const esp_partition_type_t APP_PARTITION_TYPE_A = (esp_partition_type_t) 0x40;
```

注意，启动加载器将忽略 `app` (0x00) 和 `data` (0x01) 以外的其他分区类型。

## SubType 字段

SubType 字段长度为 8 bit，内容与具体分区 Type 有关。目前，`esp-idf` 仅仅规定了“`app`”和“`data`”两种分区类型的子类型含义。

参考 `esp_partition_subtype_t`，以了解 ESP-IDF 定义的全部子类型列表，包括：

- 当 Type 定义为 `app` 时，SubType 字段可以指定为 `factory` (0x00)、`ota_0` (0x10) … `ota_15` (0x1F) 或者 `test` (0x20)。
  - `factory` (0x00) 是默认的 `app` 分区。启动加载器将默认加载该应用程序。但如果存在类型为 `data/ota` 分区，则启动加载器将加载 `data/ota` 分区中的数据，进而判断启动哪个 OTA 镜像文件。
    - \* OTA 升级永远都不会更新 `factory` 分区中的内容。
    - \* 如果你希望在 OTA 项目中预留更多 flash，可以删除 `factory` 分区，转而使用 `ota_0` 分区。
  - `ota_0` (0x10) … `ota_15` (0x1F) 为 OTA 应用程序分区，启动加载器将根据 OTA 数据分区中的数据来决定加载哪个 OTA 应用程序分区中的程序。在使用 OTA 功能时，应用程序应至少拥有 2 个 OTA 应用程序分区 (`ota_0` 和 `ota_1`)。更多详细信息，请参考 [OTA 文档](#)。
  - `test` (0x20) 为预留的子类型，用于工厂测试流程。如果没有其他有效 `app` 分区，`test` 将作为备选启动分区使用。也可以配置启动加载器在每次启动时读取 GPIO，如果 GPIO 被拉低则启动该分区。详细信息请查阅 [从测试固件启动](#)。
- 当 Type 定义为 `data` 时，SubType 字段可以指定为 `ota` (0x00)、`phy` (0x01)、`nvs` (0x02)、`nvs_keys` (0x04) 或者其他组件特定的子类型（请参考 [子类型枚举](#)）。
  - `ota` (0) 即 [OTA 数据分区](#)，用于存储当前所选的 OTA 应用程序的信息。这个分区的大小需要设定为 0x2000。更多详细信息，请参考 [OTA 文档](#)。
  - `phy` (1) 分区用于存放 PHY 初始化数据，从而保证可以为每个设备单独配置 PHY，而非必须采用固件中的统一 PHY 初始化数据。
    - \* 默认配置下，`phy` 分区并不启用，而是直接将 `phy` 初始化数据编译至应用程序中，从而节省分区表空间（直接将此分区删掉）。
    - \* 如果需从此分区加载 `phy` 初始化数据，请打开项目配置菜单 (`idf.py menuconfig`)，并且使能 `CONFIG_ESP_PHY_INIT_DATA_IN_PARTITION` 选项。此时，还需要手动将 `phy` 初始化数据烧至设备 flash (`esp-idf` 编译系统并不会自动完成该操作)。
  - `nvs` (2) 是专门给 [非易失性存储 \(NVS\) API](#) 使用的分区。
    - \* 用于存储每台设备的 PHY 校准数据（注意，并不是 PHY 初始化数据）。
    - \* NVS API 还可以用于其他应用程序数据。
    - \* 强烈建议为 NVS 分区分配至少 0x3000 字节空间。
    - \* 如果使用 NVS API 存储大量数据，请增加 NVS 分区的大小（默认是 0x6000 字节）。
  - `nvs_keys` (4) 是 NVS 秘钥分区。详细信息，请参考 [非易失性存储 \(NVS\) API](#) 文档。
    - \* 用于存储加密密钥（如果启用了 NVS 加密功能）。
    - \* 此分区应至少设定为 4096 字节。
  - ESP-IDF 还支持其他用于数据存储的预定义子类型，包括：
    - \* `coredump` (0x03) 用于在使用自定义分区表 CSV 文件时存储核心转储，详情请参阅 [核心转储](#)。
    - \* `efuse` (0x05) 使用 [虚拟 eFuse](#) 模拟 eFuse 位。

- \* `undefined (0x06)` 隐式用于未指定子类型（即子类型为空）的数据分区，但也可显式将其标记为未定义。
  - \* `fat (0x81)` 用于 *FAT* 文件系统。
  - \* `spiffs (0x82)` 用于 *SPIFFS* 文件系统。
  - \* `littlefs (0x83)` 用于 *LittleFS* 文件系统，详情可参阅 [storage/littlefs](#) 示例。
- 如果分区类型是由应用程序定义的任意值 (0x40-0xFE)，那么 `subtype` 字段可以是由应用程序选择的任何值 (0x00-0xFE)。请注意，如果用 C++ 编写，应用程序定义的子类型值需要转换为 `esp_partition_type_t`，从而与分区 API 一起使用。

### 额外分区 SubType 字段

组件可以通过设置 `EXTRA_PARTITION_SUBTYPES` 属性来定义额外的分区子类型。`EXTRA_PARTITION_SUBTYPES` 是一个 CMake 列表，其中的每个条目由字符串组成，以逗号为分隔，格式为 `<type>, <subtype>, <value>`。构建系统通过该属性会自动添加额外的子类型，并在 `esp_partition_subtype_t` 中插入名为 `ESP_PARTITION_SUBTYPE_<type>_<subtype>` 的字段。项目可以使用这个子类型来定义分区表 CSV 文件中的分区，并使用 `esp_partition_subtype_t` 中的新字段。

### 偏移地址 (Offset) 和大小 (Size) 字段

- 偏移地址表示 SPI flash 中的分区地址，扇区大小为 0x1000 (4 KB)。因此，偏移地址必须是 4 KB 的倍数。
- 若 CSV 文件中的分区偏移地址为空，则该分区会接在前一个分区之后；若为首个分区，则将接在分区表之后。
- app 分区的偏移地址必须与 0x10000 (64 KB) 对齐。如果偏移字段留空，则 `gen_esp32part.py` 工具会自动计算得到一个满足对齐要求的偏移地址。如果 app 分区的偏移地址没有与 0x10000 (64 KB) 对齐，则该工具会报错。
- app 分区的大小必须与 flash 扇区大小对齐。为 app 分区指定未对齐的大小将返回错误。
- app 分区的大小和偏移地址可以采用十进制数或是以 0x 为前缀的十六进制数，且支持 K 或 M 的倍数单位 (K 和 M 分别代表 1024 和 1024\*1024 字节)。

如果你希望允许分区表中的分区采用任意起始偏移量 (`CONFIG_PARTITION_TABLE_OFFSET`)，请将分区表 (CSV 文件) 中所有分区的偏移字段都留空。注意，此时，如果你更改了分区表中任意分区的偏移地址，则其他分区的偏移地址也会跟着改变。这种情况下，如果你之前还曾设定某个分区采用固定偏移地址，则可能造成分区表冲突，从而导致报错。

### Flags 字段

目前支持 `encrypted` 和 `readonly` 标记：

- 如果 Flags 字段设置为 `encrypted`，且已启用 *flash 加密* 功能，则该分区将会被加密。

---

**备注：** 无论是否设置 Flags 字段，app 分区都将保持加密。

---

- 如果 Flags 字段设置为 `readonly`，则该分区为只读分区。`readonly` 标记仅支持除 `ota` 和 `coredump` 子类型外的 `data` 分区。使用该标记，防止意外写入如出厂数据分区等包含关键设备特定配置数据的分区。

---

**备注：** 在任何写入模式下 (`w`, `w+`, `a`, `a+`, `r+`)，尝试通过 C 文件 I/O API 打开文件 (`fopen`) 的操作都将失败并返回 `NULL`。除 `O_RDONLY` 外，`open` 与任何标志一同使用都将失败并返回 `-1`，全局变量 `errno` 也将设置为 `EROFS`。上述情况同样适用于通过其他 POSIX 系统调用函数执行写入或擦除的操作。在只读分区上，以读写模式打开 NVS 的句柄将失败并返

回 `ESP_ERR_NOT_ALLOWED` 错误代码，使用 `esp_partition` 或 `spi_flash` 等较低级别的 API 进行写入操作也将返回 `ESP_ERR_NOT_ALLOWED` 错误代码。

可以使用冒号连接不同的标记，来同时指定多个标记，如 `encrypted:readonly`。

#### 4.21.4 生成二进制分区表

烧写到 ESP32-H2 中的分区表采用二进制格式，而不是 CSV 文件本身。此时，`partition_table/gen_esp32part.py` 工具可以实现 CSV 和二进制文件之间的转换。

如果你在项目配置菜单 (`idf.py menuconfig`) 中设置了分区表 CSV 文件的名称，然后构建项目或执行 `idf.py partition-table`。这时，转换将在编译过程中自动完成。

手动将 CSV 文件转换为二进制文件：

```
python gen_esp32part.py input_partitions.csv binary_partitions.bin
```

手动将二进制文件转换为 CSV 文件：

```
python gen_esp32part.py binary_partitions.bin input_partitions.csv
```

在标准输出 (stdout) 上，打印二进制分区表的内容（运行 `idf.py partition-table` 时展示的信息摘要也是这样生成的）：

```
python gen_esp32part.py binary_partitions.bin
```

#### 4.21.5 分区大小检查

ESP-IDF 构建系统将自动检查生成的二进制文件大小与可用的分区大小是否匹配，如果二进制文件太大，则会构建失败并报错。

目前会对以下二进制文件进行检查：

- 引导加载程序的二进制文件的大小要适合分区表前的区域大小（分区表前的区域都分配给了引导加载程序），具体请参考[引导加载程序大小](#)。
- 应用程序二进制文件应至少适合一个“app”类型的分区。如果不适合任何应用程序分区，则会构建失败。如果只适合某些应用程序分区，则会打印相关警告。

**备注：**即使分区大小检查返回错误并导致构建失败，仍然会生成可以烧录的二进制文件（它们对于可用空间来说过大，因此无法正常工作）。

#### MD5 校验和

二进制格式的分区表中含有一个 MD5 校验和。这个 MD5 校验和是根据分区表内容计算的，可在设备启动阶段，用于验证分区表的完整性。

用户可通过 `gen_esp32part.py` 的 `--disable-md5sum` 选项或者 `CONFIG_PARTITION_TABLE_MD5` 选项关闭 MD5 校验。

#### 4.21.6 烧写分区表

- `idf.py partition-table-flash`：使用 `esptool.py` 工具烧写分区表。
- `idf.py flash`：会烧写所有内容，包括分区表。

在执行 `idf.py partition-table` 命令时，手动烧写分区表的命令也将打印在终端上。

**备注：**分区表的更新并不会擦除根据旧分区表存储的数据。此时，可以使用 `idf.py erase-flash` 命令或者 `esptool.py erase_flash` 命令来擦除 `flash` 中的所有内容。

### 4.21.7 分区工具 (`parttool.py`)

`partition_table` 组件中有分区工具 `parttool.py`，可以在目标设备上完成分区相关操作。该工具有如下用途：

- 读取分区，将内容存储到文件中 (`read_partition`)
- 将文件中的内容写至分区 (`write_partition`)
- 擦除分区 (`erase_partition`)
- 检索特定分区的名称、偏移、大小和 `flag`（“加密”）标志等信息 (`get_partition_info`)

用户若想通过编程方式完成相关操作，可从另一个 Python 脚本导入并使用分区工具，或者从 Shell 脚本调用分区工具。前者可使用工具的 Python API，后者可使用命令行界面。

#### Python API

首先请确保已导入 `parttool` 模块。

```
import sys
import os

idf_path = os.environ["IDF_PATH"] # 从环境中获取 IDF_PATH 的值
parttool_dir = os.path.join(idf_path, "components", "partition_table") # parttool.
↳py 位于 $IDF_PATH/components/partition_table 下

sys.path.append(parttool_dir) # 使能 Python 寻找 parttool 模块
from parttool import * # 导入 parttool 模块内的所有名称
```

要使用分区工具的 Python API，第一步是创建 `ParttoolTarget`：

```
# 创建 parttool.py 的目标设备，并将目标设备连接到串行端口 /dev/ttyUSB1
target = ParttoolTarget("/dev/ttyUSB1")
```

现在，可使用创建的 `ParttoolTarget` 在目标设备上完成操作：

```
# 擦除名为 'storage' 的分区
target.erase_partition(PartitionName("storage"))

# 读取类型为 'data'、子类型为 'spiffs' 的分区，保存至文件 'spiffs.bin'
target.read_partition(PartitionType("data", "spiffs"), "spiffs.bin")

# 将 'factory.bin' 文件的内容写至 'factory' 分区
target.write_partition(PartitionName("factory"), "factory.bin")

# 打印默认启动分区的大小
storage = target.get_partition_info(PARTITION_BOOT_DEFAULT)
print(storage.size)
```

使用 `PartitionName`、`PartitionType` 或 `PARTITION_BOOT_DEFAULT` 指定要操作的分区。顾名思义，这三个参数可以指向拥有特定名称的分区、特定类型和子类型的分区或默认启动分区。

更多关于 Python API 的信息，请查看分区工具的代码注释。

## 命令行界面

`parttool.py` 的命令行界面具有如下结构：

```
parttool.py [command-args] [subcommand] [subcommand-args]
```

- `command-args` - 执行主命令 (`parttool.py`) 所需的实际参数，多与目标设备有关
- `subcommand` - 要执行的操作
- `subcommand-args` - 所选操作的实际参数

```
# 擦除名为 'storage' 的分区
parttool.py --port "/dev/ttyUSB1" erase_partition --partition-name=storage

# 读取类型为 'data'、子类型为 'spiffs' 的分区，保存到 'spiffs.bin' 文件
parttool.py --port "/dev/ttyUSB1" read_partition --partition-type=data --partition-
↳subtype=spiffs --output "spiffs.bin"

# 将 'factory.bin' 文件中的内容写入到 'factory' 分区
parttool.py --port "/dev/ttyUSB1" write_partition --partition-name=factory --input
↳"factory.bin"

# 打印默认启动分区的大小
parttool.py --port "/dev/ttyUSB1" get_partition_info --partition-boot-default --
↳info size
```

更多信息可用 `--help` 指令查看：

```
# 显示可用的子命令和主命令描述
parttool.py --help

# 显示子命令的描述
parttool.py [subcommand] --help
```

## 4.22 性能

ESP-IDF 预设了默认设置，旨在性能、资源使用和可用功能之间进行权衡。

本指南详述了如何优化固件应用程序，以提高特定方面的性能。这一过程通常涉及到性能之间的权衡，例如限制部分可用功能，或者牺牲某性能以满足另一性能的要求，例如通过使用更多内存换取更快的运行速度。

### 4.22.1 如何优化性能

1. 确定应用程序的关键性能要求，例如控制某个网络操作的响应时间、控制启动时间、或在某个外设中实现特定的数据吞吐量。
2. 确定衡量该性能的方法（下文指南中概述了一些方法）。
3. 修改代码和项目配置，比较新旧测量结果。
4. 重复第三步，直到性能达到第一步中设定的要求为止。

### 4.22.2 指南

#### 速度优化



**概述** 提高代码执行速度是提升软件性能的关键要素，该优化也可能带来其他积极影响，比如降低总体功耗。然而，提高代码执行速度可能会牺牲其他性能，如[最小化二进制文件大小](#)。

**决定优化目标** 如果应用程序固件中的某个函数仅每周在后台执行一次，其执行时间是 10 ms 还是 100 ms 对整体性能的影响或可忽略不计。但如果某个函数以 10 Hz 的频率持续执行，其执行时间是 10 ms 还是 100 ms 就会对系统性能产生显著影响。

大多数应用程序固件中，只有一小部分函数需要优化性能，例如频繁执行的函数，或者必须满足应用程序对延迟或吞吐量的要求的函数。应针对这些特定函数优化其执行速度。

**测量性能** 想要提升某方面性能，首先要对其进行测量。

**基本性能测量方法** 可以直接测量与外部交互的性能，例如，测量一般网络性能可以参考 [wifi/ipperf](#) 和 [ethernet/ipperf](#)，或者使用示波器或逻辑分析仪来测量与设备外设的交互时间。

此外，另一种测量性能的方法是在代码中添加计时测量：

```
#include "esp_timer.h"

void measure_important_function(void) {
    const unsigned MEASUREMENTS = 5000;
    uint64_t start = esp_timer_get_time();

    for (int retries = 0; retries < MEASUREMENTS; retries++) {
        important_function(); // 需要测量的代码
    }

    uint64_t end = esp_timer_get_time();

    printf("%u iterations took %llu milliseconds (%llu microseconds per_
↪invocation)\n",
           MEASUREMENTS, (end - start)/1000, (end - start)/MEASUREMENTS);
}
```

通过多次执行目标代码可以降低其他因素的影响，例如实时操作系统 (RTOS) 的上下文切换、测量的开销等。

- 使用 `esp_timer_get_time()` 可以生成微秒级精度的“墙钟”时间戳，但每次调用计时函数都会产生适量开销。
- 也可以使用标准 Unix 函数 `gettimeofday()` 和 `utime()` 来进行计时测量，尽管其开销略高一些。
- 此外，代码中包含 `hal/cpu_hal.h` 头文件，并调用 HAL 函数 `cpu_hal_get_cycle_count()` 可以返回已执行的 CPU 循环数。该函数开销较低，适用于高精度测量执行时间极短的代码。
- 在执行“微基准测试”时（即仅对运行时间不到 1-2 ms 的小代码段进行基准测试），二进制文件会影响 flash 缓存的性能，进而可能会导致计时测量出现较大差异。这是因为二进制布局可能会导致在特定的执行顺序中产生不同模式的缓存缺失。执行较大测试代码通常可以抵消这种影响。在基准测试时多次执行一个小函数可以减少 flash 缓存缺失的影响。另外，将该代码移到 IRAM 中（参见[针对性优化](#)）也可以解决这个问题。

**外部跟踪** [应用层跟踪库](#) 可以在几乎不影响代码执行的情况下测量其执行速度。

**任务** 如果启用了选项 `CONFIG_FREERTOS_GENERATE_RUN_TIME_STATS`，则可以使用 FreeRTOS API `vTaskGetRunTimeStats()` 来获取各个 FreeRTOS 任务运行时占用处理器的时间。

[SEGGER SystemView](#) 是一款出色的工具，可将任务执行情况可视化，也可用于排查系统整体的性能问题或改进方向。

**提高整体速度** 以下优化措施将提高几乎所有代码的执行效果，包括启动时间、吞吐量、延迟等：

- 设置 `CONFIG_ESPTOOLPY_FLASHMODE` 为 QIO 或 QOUT 模式（四线 I/O 模式）。相较于默认的 DIO 模式，在这两种模式下，从 flash 加载或执行代码的速度几乎翻倍。如果两种模式都支持，QIO 会稍微快于 QOUT。请注意，flash 芯片以及 ESP32-H2 与 flash 芯片之间的电气连接都必须支持四线 I/O 模式，否则 SoC 将无法正常工作。
- 设置 `CONFIG_COMPILER_OPTIMIZATION` 为 Optimize for performance (-O2)。相较于默认设置，这可能会略微增加二进制文件大小，但几乎必然会提高某些代码的性能。请注意，如果代码包含 C 或 C++ 的未定义行为，提高编译器优化级别可能会暴露出原本未发现的错误。
- 禁用 `CONFIG_ESP_SYSTEM_HW_STACK_GUARD` 可能会小幅提高代码性能，尤其是在设备上出现大量中断的情况下。
- 避免使用浮点运算 float。ESP32-H2 通过软件模拟进行浮点运算，因此速度非常慢。可以考虑使用不同的整数表示方法进行运算，如定点表示法，或者将部分计算用整数运算后再切换为浮点运算。
- 避免使用双精度浮点运算 double。ESP32-H2 通过软件模拟进行双精度浮点运算，因此速度非常慢。可以考虑使用基于整数的表示方法或单精度浮点数。

**减少日志开销** 尽管标准输出会先存储在缓冲区中，但缓冲区缺少可用空间时，应用程序将数据输出到日志的速度可能会受限。这点在程序启动并输出大量日志时尤为明显，但也可能随时发生。为解决这一问题，可以采取以下几种方法：

- 通过调低应用日志默认等级 `CONFIG_LOG_DEFAULT_LEVEL`（引导加载程序日志等级的相应配置为 `CONFIG_BOOTLOADER_LOG_LEVEL`）来减少日志输出量。这样做不仅可以减小二进制文件大小，还可以节省一些 CPU 用于格式化字符串的时间。
- 增加 `CONFIG_ESP_CONSOLE_UART_BAUDRATE`，可以提高日志输出速度。

**不建议的选项** 以下选项也可以提高执行速度，但不建议使用，因为它们会降低固件应用程序的可调试性，并可能导致出现更严重的 bug。

- 禁用 `CONFIG_COMPILER_OPTIMIZATION_ASSERTION_LEVEL`。这也会略微减小固件二进制文件大小。然而，它可能导致出现更严重的 bug，甚至出现安全性 bug。如果为了优化特定函数而必须禁用该选项，可以考虑在该源文件的顶部单独添加 `#define NDEBUG`。

**针对性优化** 以下更改将提高固件应用程序特定部分的速度：

- 将频繁执行的代码移至 IRAM。应用程序中的所有代码都默认从 flash 中执行。这意味着缓存缺失时，CPU 需要等待从 flash 加载后续指令。如果将函数复制到 IRAM 中，则仅需要在启动时加载一次，然后始终以全速执行。IRAM 资源有限，使用更多的 IRAM 可能会减少可用的 DRAM。因此，将代码移动到 IRAM 需要有所取舍。更多信息参见 [IRAM（指令 RAM）](#)。
- 针对不需要放置在 IRAM 中的单个源文件，可以重新启用跳转表优化。这将提高大型 switch cases 代码中的热路径性能。关于如何在编译单个源文件时添加 `-fjump-tables -ftree-switch-conversion` 选项，参见 [组件编译控制](#)。

**减少启动时间** 除了上述提高整体性能的方法外，还可以微调以下选项来专门减少启动时间：

- 最小化 `CONFIG_LOG_DEFAULT_LEVEL` 和 `CONFIG_BOOTLOADER_LOG_LEVEL` 可以大幅减少启动时间。如要在应用程序启动后获取更多日志，可以设置 `CONFIG_LOG_MAXIMUM_LEVEL`，然后调用 `esp_log_level_set()` 来恢复更高级别的日志输出。示例 `system/startup_time` 的主函数展示了如何实现这一点。

- 如果使用 Deep-sleep 模式，启用 `CONFIG_BOOTLOADER_SKIP_VALIDATE_IN_DEEP_SLEEP` 可以加快从睡眠中唤醒的速度。请注意，启用该选项后在唤醒时将不会执行安全启动验证，需要考量安全风险。
- 设置 `CONFIG_BOOTLOADER_SKIP_VALIDATE_ON_POWER_ON` 可以在每次上电复位启动时跳过二进制文件验证，节省的时间取决于二进制文件大小和 flash 设置。请注意，如果 flash 意外损坏，此设置将有一定风险。更多关于使用该选项的解释和建议，参见 [项目配置](#)。
- 禁用 RTC 慢速时钟校准可以节省一小部分启动时间。设置 `CONFIG_RTC_CLK_CAL_CYCLES` 为 0 可以实现该操作。设置后，以 RTC 慢速时钟为时钟源的固件部分精确度将降低。

示例项目 `system/startup_time` 预配了优化启动时间的设置，文件 `system/startup_time/sdkconfig.defaults` 包含了所有相关设置。可以将这些设置追加到项目中 `sdkconfig` 文件的末尾并合并，但请事先阅读每个设置的相关说明。

**任务优先级** ESP-IDF FreeRTOS 是实时操作系统，因此需确保高吞吐量或低延迟的任务获得更高优先级，以便立即运行。调用 `xTaskCreate()` 或 `xTaskCreatePinnedToCore()` 会设定优先级，并且可以在运行时调用 `vTaskPrioritySet()` 进行更改。

此外，还需确保任务适时释放 CPU（通过调用 `vTaskDelay()` 或 `sleep()`，或在信号量、队列、任务通知等方面进行阻塞），以避免低优先级任务饥饿并造成系统性问题。[任务看门狗定时器 \(TWDT\)](#) 提供任务饥饿自动检测机制，但请注意，正确的固件操作有时需要长时间运算，因此任务看门狗定时器超时并不总意味着存在问题。在这些情况下，可能需要微调超时时限，甚至禁用任务看门狗定时器。

**内置任务优先级** ESP-IDF 启动的系统任务预设了固定优先级。启动时，一些任务会自动启动，而另一些仅在应用程序固件初始化特定功能时启动。为优化性能，请合理设置应用程序任务优先级，以确保它们不会被系统任务阻塞，同时需确保系统任务不会饥饿进而影响其他系统功能。

为此，可能需要分解特定任务。例如，可以在高优先级任务或中断处理程序中执行实时操作，并在较低优先级任务中处理非实时操作。

头文件 `components/esp_system/include/esp_task.h` 包含了用于设置 ESP-IDF 内置任务系统优先级的宏定义。更多系统任务详情，参见 [后台任务](#)。

常见优先级包括：

- [运行主任务](#) 中执行 `app_main` 函数的主任务优先级最低 (1)。
- 系统任务 [ESP 定时器](#) 用于管理定时器事件并执行回调函数，优先级较高 (22, `ESP_TASK_TIMER_PRIO`)。
- FreeRTOS 初始化调度器时会创建定时器任务，用于处理 FreeRTOS 定时器的回调函数，优先级最低 (1, [可配置](#))。
- 系统任务 [事件循环库](#) 用于管理默认的系统事件循环并执行回调函数，优先级较高 (20, `ESP_TASK_EVENT_PRIO`)。仅在应用程序调用 `esp_event_loop_create_default()` 时使用此配置。可以调用 `esp_event_loop_create()` 添加自定义任务配置。
- [lwIP TCP/IP](#) 任务优先级较高 (18, `ESP_TASK_TCP_IP_PRIO`)。
- [Controller & VHCI](#) 任务优先级较高 (23, `ESP_TASK_BT_CONTROLLER_PRIO`)。蓝牙控制器需要以低延迟响应请求，因此其任务应始终为系统最高优先级的任务之一。
- [NimBLE-based Host APIs](#) 任务优先级较高 (21)。
- 以太网驱动程序会创建一个 `MAC` 任务，用于接收以太网帧。如果使用默认配置 `ETH_MAC_DEFAULT_CONFIG`，则该任务为中高优先级 (15)。可以在以太网 `MAC` 初始化时输入自定义 `eth_mac_config_t` 结构体来更改此设置。
- 如果使用 [ESP-MQTT](#) 组件，它会创建优先级默认为 5 的任务 ([可配置](#))，可通过 `CONFIG_MQTT_USE_CUSTOM_CONFIG` 调整，也可以在运行时通过 `esp_mqtt_client_config_t` 结构体中的 `task_prio` 字段调整。
- 关于 mDNS 服务的任务优先级，参见 [性能优化](#)。

**设定应用程序任务优先级** 一般情况下，不建议将任务优先级设置得比内置的蓝牙/802.15.4, esp32c5= 操作更高，因为这样可能会使 CPU 被长时间占用，导致系统不稳定。



对于非常短、对时序要求严格且不涉及网络的操作，可以使用中断服务程序或是限制运行时间的最高优先级 (24) 任务。

将特定任务优先级设为 19，则较低层级的蓝牙/802.15.4, esp32c5= 功能可以无延迟运行，且仍然会抢占 lwIP TCP/IP 堆栈以及其他非实时内部功能，这对于不执行网络操作的实时任务而言是最佳选项。

lwIP TCP/IP 任务优先级 (18) 应高于所有执行 TCP/IP 网络操作的任务，从而避免优先级反转的问题。

默认配置下，除了个别例外，尤其是 lwIP TCP/IP 任务，大多数内置任务都固定在核 0 上执行。因此，应用程序可以方便地将高优先级任务放置在核 1 上执行。优先级大于等于 19 的应用程序任务在核 1 上运行时可以确保不会被任何内置任务抢占。为了进一步隔离各个 CPU 上运行的任务，配置 [lwIP 任务](#)，可以使 lwIP 任务仅在核 0 上运行，而非其他内核，这可能会根据其他任务的运行情况减少总 TCP/IP 吞吐量。

一般情况下，不建议将核 0 上的任务优先级设置得比内置的蓝牙/802.15.4, esp32c5= 操作更高，因为这样可能会使 CPU 被长时间占用，导致系统不稳定。选择优先级为 19 并在核 0 上运行可以使底层蓝牙/802.15.4, esp32c5= 功能运行无延迟，但仍会抢占 lwIP TCP/IP 栈和其他不太关键的内部功能。这对于无需执行网络操作且时序要求高的任务来说是一个选择。执行 TCP/IP 网络操作的任何任务都应该以低于 lwIP TCP/IP 任务 (18) 的优先级运行，以避免优先级反转问题。

---

**备注：** 如果要让特定任务始终先于 ESP-IDF 内置任务运行，并不需要将其固定在核 1 上。将该任务优先级设置为小于等于 17，则无需与内核绑定，那么核 0 上没有执行较高优先级的内置任务时，该任务也可以选择核 0 上执行。使用未固定的任务可以提高整体 CPU 利用率，但这会增加任务调度的复杂性。

---



---

**备注：** 对内置 SPI flash 芯片进行写入操作时，任务会完全暂停执行。只有 [IRAM 安全中断处理程序](#) 会继续执行。

---

**提高中断性能** ESP-IDF 支持动态 [中断分配](#) 和中断抢占。系统中每个中断都有相应优先级，较高优先级的中断将优先执行。

只要其他任务不在临界区内，中断处理程序将优先于所有其他任务执行。因此，尽量减少中断处理程序的执行时间十分重要。

要以最佳性能执行特定中断处理程序，可以考虑：

- 调用 `esp_intr_alloc()` 时使用 `ESP_INTR_FLAG_LEVEL2` 或 `ESP_INTR_FLAG_LEVEL3` 等标志，可以为更重要的中断设定更高优先级。
- 如果确定整个中断处理程序可以在 IRAM 中运行（参见 [IRAM 安全中断处理程序](#)），那么在调用 `esp_intr_alloc()` 分配中断时，请设置 `ESP_INTR_FLAG_IRAM` 标志，这样可以防止在应用程序固件写入内置 SPI flash 时临时禁用中断。
- 即使是非 IRAM 安全的中断处理程序，如果需要频繁执行，可以考虑将处理程序的函数移到 IRAM 中，从而尽可能规避执行中断代码时发生 flash 缓存缺失的可能性（参见 [针对性优化](#)）。如果可以确保只有部分处理程序位于 IRAM 中，则无需添加 `ESP_INTR_FLAG_IRAM` 标志将程序标记为 IRAM 安全。

### 提高网络速度

- 关于提高 lwIP TCP/IP 网速，参见 [性能优化](#)。

**提高 I/O 性能** 使用标准 C 库函数，如 `fread` 和 `fwrite` 时，相较于使用平台特定的不带缓冲系统调用，I/O 性能可能更慢，如 `read` 和 `write`。标准 C 库函数是为可移植性而设计的，它们会在执行时会引入一定开销和缓冲延迟，因此并不适用需要较高执行速度的场景。

[FAT 文件系统](#) 具体信息和提示如下：

- 读取/写入请求的最大大小等于 FatFS 簇大小（分配单元大小）。

- 使用 `read` 和 `write` 而非 `fread` 和 `fwrite` 可以提高性能。
- 要提高诸如 `fread` 和 `fgets` 等缓冲读取函数的执行速度，可以增加文件缓冲区的大小（Newlib 的默认值为 128 字节），例如 4096、8192 或 16384 字节。为此，可以在特定文件的指针上使用 `setvbuf` 函数进行局部更改，或者修改 `CONFIG_FATFS_VFS_FSTAT_BLKSIZE` 实现全局应用。

---

**备注：**增加缓冲区的大小会增加堆内存的使用量。

---

## 最小化二进制文件大小

ESP-IDF 构建系统会编译项目和 ESP-IDF 中所有源文件，但只有程序实际引用的函数和变量才会链接到最终的二进制文件中。在某些情况下，需要减小固件二进制文件的总大小，例如，为使固件适配 flash 分区大小。

要减小固件二进制文件总大小，首先要找到导致其大小增加的原因。

**测量静态数据大小** 为了优化固件二进制文件大小和内存使用，需要测量项目中静态分配的 RAM (`data`, `bss`)，代码 (`text`) 和只读数据 (`rodata`)。

使用 `idf.py` 的子命令 `size`，`size-components` 和 `size-files` 可以输出项目使用内存概况：

---

**备注：**添加 `-DOUTPUT_FORMAT=csv` 或 `-DOUTPUT_FORMAT=json`，即可用 CSV 或 JSON 格式输出文件。

---

## 数据大小概况 `idf.py size`

```
$ idf.py size
[...]
Total sizes:
Used stat D/IRAM:  53743 bytes ( 122385 remain, 30.5% used)
  .data size:     6504 bytes
  .bss size:      1984 bytes
  .text size:     44228 bytes
  .vectors size:  1027 bytes
Used Flash size : 118879 bytes
  .text:          83467 bytes
  .rodata:        35156 bytes
Total image size: 170638 bytes (.bin may be padded larger)
```

该输出结果细分了固件二进制文件中所有静态内存区域的大小：

```
$ idf.py size
[...]
Total sizes:
Used stat D/IRAM:  53743 bytes ( 122385 remain, 30.5% used)
  .data size:     6504 bytes
  .bss size:      1984 bytes
  .text size:     44228 bytes
  .vectors size:  1027 bytes
Used Flash size : 118879 bytes
  .text:          83467 bytes
  .rodata:        35156 bytes
Total image size: 170638 bytes (.bin may be padded larger)
```

- `Used stat D/IRAM:` 编译时使用的 D/IRAM 大小。`remain` 表示在运行时可用作堆内存的 D/IRAM 余量。请注意，由于元数据开销、实现限制和启动时的堆分配，实际的 DRAM 堆会更小。

- .data size: 编译时为 .data (即所有初始化为非零值的静态变量) 分配的 D/IRAM 大小。 .data 还在二进制映像中占用空间来存储非零初始化值。
- .bss size: 编译时为 .bss (即所有初始化为零的静态变量) 分配的 D/IRAM 大小。 .bss 不会在 flash 中占用额外空间。
- .text size: 用于 .text 的 D/IRAM 大小 (即所有从内部 RAM 执行的代码)。 由于代码最初存储在 .text 中, 在启动时才会复制到 D/IRAM, 因此 .text 在二进制映像中也会占用空间。
- Used Flash size: 使用的 flash 总大小 (不包括 D/IRAM 的使用量)。
  - .text: 用于 .text (即通过 flash 缓存执行的所有代码, 请参阅 [IROM](#)) 的 flash 大小。
  - .rodata: 用于 .rodata (即通过 flash 缓存加载的只读数据, 参阅 [DROM](#)) 的 flash 大小。
- Total image size is the estimated total size of the binary file.

**组件使用概况 idf.py size-components** idf.py size 的输出结果不够详细, 无法找出导致二进制文件过大的主要原因。 要进行更详细的分析, 请使用 idf.py size-components。

```
$ idf.py size-components
[...]
```

Archive	File	DRAM	.data & .bss & other	IRAM	D/IRAM	Flash code	&...
↪rodata	Total						
	libnet80211.a	1267	6044	0	5490	0	107445 ↪
↪18484	138730						
	liblwip.a	21	3838	0	0	0	97465 ↪
↪16116	117440						
	libmbedtls.a	60	524	0	0	0	27655 ↪
↪69907	98146						
	libmbedcrypto.a	64	81	0	30	0	76645 ↪
↪11661	88481						
	libpp.a	2427	1292	0	20851	0	37208 ↪
↪4708	66486						
	libc.a	4	0	0	0	0	57056 ↪
↪6455	63515						
	libphy.a	1439	715	0	7798	0	33074 ↪
↪ 0	43026						
	libwpa_supplicant.a	12	848	0	0	0	35505 ↪
↪1446	37811						
	libfreertos.a	3104	740	0	15711	0	367 ↪
↪4228	24150						
	libnvs_flash.a	0	24	0	0	0	14347 ↪
↪2924	17295						
	libspi_flash.a	1562	294	0	8851	0	1840 ↪
↪1913	14460						
	libesp_system.a	245	206	0	3078	0	5990 ↪
↪3817	13336						
	libesp-tls.a	0	4	0	0	0	5637 ↪
↪3524	9165						
[... removed some lines here ...]							
	libesp_rom.a	0	0	0	112	0	0 ↪
↪ 0	112						
	libcxx.a	0	0	0	0	0	47 ↪
↪ 0	47						
	(exe)	0	0	0	3	0	3 ↪
↪ 12	18						

(下页继续)

(续上页)

	libesp_pm.a	0	0	0	0	0	8	└
↔ 0	8							
	libesp_eth.a	0	0	0	0	0	0	└
↔ 0	0							
	libmesh.a	0	0	0	0	0	0	└
↔ 0	0							

idf.py size-components 输出的前几行与 idf.py size 相同，此外还会输出 Per-archive contributions to ELF file 表格，显示每个静态库对最终二进制文件大小的贡献程度。

通常，每个组件都会构建一个静态库归档文件，尽管部分是由特定组件包含的二进制库，例如，esp\_wifi 组件包含了 libnet80211.a。此外，这里还列出了一些工具链库，例如 libc.a 和 libgcc.a，用于提供 C/C++ 标准库和工具链内置功能。

对于只有一个 main 组件的简单项目，可在 libmain.a 目录下找到所有项目代码。若项目包含其特有组件（参阅构建系统），则每个组件将单独在一行中显示。

该表格按静态库归档文件对最终二进制文件大小的贡献程度降序排序。

各列含义如下：

- DRAM .data & .bss & other-.data 和 .bss 分别与上方显示的总数相同。两者都是静态变量，且都会减少运行时的可用 RAM，但 .bss 不会增加二进制文件大小。other 列指任何会增加 RAM 大小的自定义数据段，该值通常为 0。
- IRAM - 与上方显示的总数相同，表示链接到从 IRAM 执行的代码，这些代码占用二进制文件空间，并且会减少运行时可用作堆内存的 DRAM 空间。
- Flash code & rodata - 这些值与上方显示总数相同，指通过 flash 缓存访问的 IROM 和 DROM 空间，对二进制文件大小的贡献。

**源文件使用概况 idf.py size-files** 要了解更多详情，请运行 idf.py size-files，获取每个目标文件对最终二进制文件大小的贡献概况。每个目标文件对应一个单独的源文件。

```

$ idf.py size-files
[...]
Total sizes:
  DRAM .data size: 14956 bytes
  DRAM .bss size: 15808 bytes
Used static DRAM: 30764 bytes ( 149972 available, 17.0% used)
Used static IRAM: 83918 bytes ( 47154 available, 64.0% used)
  Flash code: 559943 bytes
  Flash rodata: 176736 bytes
Total image size:~ 835553 bytes (.bin may be padded larger)
Per-file contributions to ELF file:
  Object File DRAM .data & .bss & other IRAM D/IRAM Flash code &
↔rodata Total
  x509_crt_bundle.S.o 0 0 0 0 0 0
↔64212 64212
  wl_cnx.o 2 3183 0 221 0 13119
↔3286 19811
  phy_chip_v7.o 721 614 0 1642 0 16820
↔ 0 19797
  ieee80211_ioctl.o 740 96 0 437 0 15325
↔2627 19225
  pp.o 1142 45 0 8871 0 5030
↔537 15625
  ieee80211_output.o 2 20 0 2118 0 11617
↔914 14671
  ieee80211_sta.o 1 41 0 1498 0 10858
↔2218 14616

```

(下页继续)

(续上页)

↔752	lib_a-vfprintf.o	0	0	0	0	0	13829	↔
	14581							
↔752	lib_a-svfprintf.o	0	0	0	0	0	13251	↔
	14003							
↔463	ssl_tls.c.o	60	0	0	0	0	12769	↔
	13292							
↔1030	sockets.c.o	0	648	0	0	0	11096	↔
	12774							
↔314	nd6.c.o	8	932	0	0	0	11515	↔
	12769							
↔ 0	phy_chip_v7_cal.o	477	53	0	3499	0	8561	↔
	12590							
↔782	pm.o	32	364	0	2673	0	7788	↔
	11639							
↔1921	ieee80211_scan.o	18	288	0	0	0	8889	↔
	11116							
↔1206	lib_a-svfiprintf.o	0	0	0	0	0	9654	↔
	10860							
↔734	lib_a-vfiprintf.o	0	0	0	0	0	10069	↔
	10803							
↔898	ieee80211_ht.o	0	4	0	1186	0	8628	↔
	10716							
↔ 0	phy_chip_v7_ana.o	241	48	0	2657	0	7677	↔
	10623							
↔752	bignum.c.o	0	4	0	0	0	9652	↔
	10408							
↔1282	tcp_in.c.o	0	52	0	0	0	8750	↔
	10084							
↔1108	trc.o	664	88	0	1726	0	6245	↔
	9831							
↔1475	tasks.c.o	8	704	0	7594	0	0	↔
	9781							
↔2325	ecp_curves.c.o	28	0	0	0	0	7384	↔
	9737							
↔286	ecp.c.o	0	64	0	0	0	8864	↔
	9214							
↔585	ieee80211_hostap.o	1	41	0	0	0	8578	↔
	9205							
↔580	wdev.o	121	125	0	4499	0	3684	↔
	9009							
↔2161	tcp_out.c.o	0	0	0	0	0	5686	↔
	7847							
↔1617	tcp.c.o	2	26	0	0	0	6161	↔
	7806							
↔973	ieee80211_input.o	0	0	0	0	0	6797	↔
	7770							
↔ 55	wpa.c.o	0	656	0	0	0	6828	↔
	7539							

[... additional lines removed ...]

文件总大小概况下方会显示 Per-file contributions to ELF file 表格。

该表格的列与上文运行 `idy.py size-components` 显示的列相同，但该表格的粒度更细，展示了每个目标文件对二进制文件大小的贡献。

例如，文件 `x509_crt_bundle.S.o` 对总固件大小贡献了 64,212 字节，全都存储在 flash 中的 `.rodata` 区域。由此可以推知，该应用程序正在使用 [ESP x509 证书包](#) 功能。如果不使用该功能，固件大小至少可以减少 64,212 字节。

某些目标文件从二进制库中链接至此，因此无法找到对应源文件。要确定一个源文件属于哪个组件，通常可以在 [ESP-IDF 源代码树](#) 中搜索，或者在 [链接器映射文件](#) 中查找完整路径。

**比较两个二进制文件** 如果某些改动影响了二进制文件大小，可以使用 ESP-IDF 工具来详细分析文件大小的确切差异。

该操作不是通过运行 `idf.py` 进行的，而是需要直接运行 Python 工具 `esp_idf_size`。

执行该操作，首先需要在构建目录中找到链接器映射文件 `PROJECTNAME.map`。`esp_idf_size` 工具会基于链接器映射文件的输出结果分析文件大小差异。

要与另一个二进制文件进行比较，还需要保存该文件对应的 `.map` 文件，该文件位于构建目录中。

例如，要比较两个构建文件，其中一个使用默认的 `CONFIG_COMPILER_OPTIMIZATION` Debug (`-Og`) 配置，而另一个使用 Optimize for size (`-Os`) 配置：

```
$ python -m esp_idf_size --diff build_Og/https_request.map build_Os/https_request.
↪map
<CURRENT> MAP file: build_Os/https_request.map
<REFERENCE> MAP file: build_Og/https_request.map
Difference is counted as <CURRENT> - <REFERENCE>, i.e. a positive number means
↪that <CURRENT> is larger.
Total sizes of <CURRENT>:
↪<REFERENCE>      Difference
DRAM .data size:  14516 bytes
↪14956             -440
DRAM .bss size:   15792 bytes
↪15808            -16
Used static DRAM: 30308 bytes ( 150428 available, 16.8% used)
↪30764            -456 ( +456 available, +0 total)
Used static IRAM: 78498 bytes ( 52574 available, 59.9% used)
↪83918           -5420 ( +5420 available, +0 total)
    Flash code:   509183 bytes
↪559943          -50760
    Flash rodata: 170592 bytes
↪176736          -6144
Total image size:~ 772789 bytes (.bin may be padded larger)
↪835553          -62764
```

从 Difference 列可以看出，改变该设置导致整个二进制文件减小了 60 KB 以上，并且可用的 RAM 增加了 5 KB 以上。

还可以使用 `diff` 模式来输出表格，显示组件级（静态库）的差异：

---

**备注：** 运行 `esp_idf_size` 时可以使用 `--format` 选项输出 JSON 或 CSV 格式的结果。

---

```
python -m esp_idf_size --archives --diff build_Og/https_request.map build_Oshttps_
↪request.map
```

同样适用于比较单个源文件级的差异：

```
python -m esp_idf_size --files --diff build_Og/https_request.map build_Oshttps_
↪request.map
```

了解将输出写入文件等其他选项，可以输入 `--help` 查看完整列表。

**链接器失败时显示文件大小** 如果被分配的静态内存大小超越上限，链接器会失败并显示错误信息，例如 `DRAM segment data does not fit` 和 `region `iram0_0_seg' overflowed by 44 bytes` 等。

在这些情况下，`idf.py size` 也无法成功执行。然而，通过手动运行 `esp_idf_size`，可以查看 **部分静态内存使用情况**。内存使用情况将不包含无法链接的变量，因此仍然会显示有部分可用空间。

映射文件参数为构建目录下的 `<projectname>.map` 文件。



```
python -m esp_idf_size build/project_name.map
```

还可以查看类似于 `size-components` 或 `size-files` 输出的内容：

```
python -m esp_idf_size --archives build/project_name.map
python -m esp_idf_size --files build/project_name.map
```

### 链接器映射文件

**备注：**这是一种非常有用的进阶分析方法。可以先跳转到[减小总体文件大小](#)，以后再详阅这一部分。

分析工具 `idf.py size` 通过解析 GNU binutils 的“链接器映射文件”来输出结果，该文件囊括了链接器在创建（即链接到）最终固件二进制文件时的所有操作。

链接器映射文件本身是纯文本文件，因此可以进行读取并准确了解链接器的操作，但这些文件非常复杂冗长，通常有 100,000 行甚至更多。

映射文件分为多个部分，每个部分各有标题，包括：

- Archive member included to satisfy reference by file (symbol)
  - 该列表显示了链接器链接各个目标文件时所搜寻的特定符号（函数或变量）。
  - 要了解二进制文件包含特定目标文件的原因，可以查看该列表以及文件末尾的 Cross Reference Table。

**备注：**请注意，并非每个显示在该列表中的目标文件最后都会出现在最终二进制文件中，有些目标文件可能会列在 Discarded input sections 中。

- Allocating common symbols
  - 该列表显示了部分全局变量及其大小。常见符号在 ELF 二进制文件中具有特定含义，但 ESP-IDF 并未广泛使用这些符号。
- Discarded input sections
  - 在链接器读取目标文件时，会将一些输入段作为文件的一部分读取并准备链接到最终的二进制文件中，但由于没有其他部分引用这些输入段，这些段最终会被丢弃。
  - 对于 ESP-IDF 项目来说，这个列表可能会非常长，因为我们将每个函数和静态变量都编译到一个独立的段中，以最小化最终二进制文件的大小。具体而言，ESP-IDF 将使用编译器选项 `-ffunction-sections` `-fdata-sections` 和链接器选项 `--gc-sections`。
  - 在这个列表中出现的条目 **不会**对最终的二进制文件大小产生影响。
- Memory Configuration 和 Linker script and memory map
  - 这两部分相互关联。输出结果的一部分来自由[构建系统](#)提供的链接器命令行和链接脚本，部分链接脚本由 ESP-IDF 项目通过[链接器脚本生成机制](#)功能生成。
  - 在 `map` 文件的 Linker script and memory map 输出中，会显示链接到最终二进制文件中的每个符号（函数或静态变量）及其地址（以 16 位十六进制数字表示）和长度（也以十六进制表示），还有链接的库和目标文件（可以用于确定组件和源文件）。
  - 在所有占用最终 `.bin` 文件的输出段之后，memory map 还会显示一些 ELF 文件中用于调试的段，如 `.debug_*` 等。这些段不会对最终的二进制文件大小产生影响，且这些符号的地址数值很小，从 `0x0000000000000000` 开始递增。
- Cross Reference Table
  - 该表格显示了引用了各个符号（函数或静态变量）的目标文件。了解二进制文件包含某个特定符号的原因，可参考该表格以确定引用特定符号的目标文件。

**备注：**Cross Reference Table 不仅包含最终二进制文件中的符号，还包含已丢弃的段内符号。因此，某个符号出现在该表中并不意味着最终二进制文件包含这一符号，需要单独检查。

**备注：**链接器映射文件由 GNU binutils 的链接器 `ld` 而非由 ESP-IDF 生成。本快速概览专从 ESP-IDF 构建系统的角度编写而成，建议自行搜索更多关于链接器映射文件格式的信息。

**减小总体文件大小** 可以通过以下配置选项减小几乎所有 ESP-IDF 项目最终二进制文件的大小：

- 将 `CONFIG_COMPILER_OPTIMIZATION` 设置为 `Optimize for size (-Os)`。在某些情况下，相较于默认设置，`Optimize for size (-Os)` 也可以减小二进制文件的大小。请注意，若代码包含 C 或 C++ 的未定义行为，提高编译器优化级别可能会暴露出原本不存在的错误。
- 通过降低应用程序的 `CONFIG_LOG_DEFAULT_LEVEL`，可以减少编译时的日志输出。如果改变 `CONFIG_LOG_MAXIMUM_LEVEL` 的默认选项，则可以控制二进制文件的大小。减少编译时的日志输出可以减少二进制文件中的字符串数量，并减小调用日志函数的代码大小。
- 将 `CONFIG_COMPILER_OPTIMIZATION_ASSERTION_LEVEL` 设置为 `Silent`，可以避免为所有可能失败的断言编译专门的断言字符串和源文件名。尽管如此，仍可以通过查看断言失败时的内存地址以在代码中找到失败断言。
- 除 `CONFIG_COMPILER_OPTIMIZATION_ASSERTION_LEVEL` 外，还可以通过设置 `CONFIG_HAL_DEFAULT_ASSERTION_LEVEL` 单独禁用或静默 HAL 组件的断言。请注意，即使将 `CONFIG_HAL_DEFAULT_ASSERTION_LEVEL` 设置为 `full-assertion` 级别，ESP-IDF 在引导加载程序中也会把 HAL 断言级别降为 `silent`，以减小引导加载程序的大小。
- 设置 `CONFIG_COMPILER_OPTIMIZATION_CHECKS_SILENT` 会移除针对 ESP-IDF 内部错误检查宏的特定错误消息。错误消息移除后，通过阅读日志输出来调试某些错误条件可能变得更加困难。
- 不要启用 `CONFIG_COMPILER_CXX_EXCEPTIONS` 或 `CONFIG_COMPILER_CXX_RTTI`，也不要将 `CONFIG_COMPILER_STACK_CHECK_MODE` 设置为 `Overall`。这些选项已默认禁用，启用这些选项会大幅增加二进制文件的大小。
- 禁用 `CONFIG_ESP_ERR_TO_NAME_LOOKUP` 将会移除查找表，该表用于将错误日志中的错误值转换成用户友好名称（参阅 [错误处理](#)）。这样做可以减小二进制文件的大小，但错误值将只以整数形式输出。
- 将 `CONFIG_ESP_SYSTEM_PANIC` 设置为 `Silent reboot` 可以减小一小部分二进制文件的大小，但此操作 **仅**建议在没有任何开发者使用 UART 输出来调试设备时进行。
- 设置 `CONFIG_COMPILER_SAVE_RESTORE_LIBCALLS` 以库调用替代内联的入口/出口代码，可以减小二进制文件的大小。
- 如果应用程序的二进制文件只使用 `protocomm` 组件的某个安全版本，取消对其他版本的支持可以减小部分代码大小。请通过 `CONFIG_ESP_PROTOCOMM_SUPPORT_SECURITY_VERSION_0`、`CONFIG_ESP_PROTOCOMM_SUPPORT_SECURITY_VERSION_1` 或者 `CONFIG_ESP_PROTOCOMM_SUPPORT_SECURITY_VERSION_2` 方式，取消对应版本的支持。

---

**备注：**除了上述众多配置项之外，还有一些配置选项在更改为非默认设置时会增加二进制文件的大小，这些选项未在此列出。配置项的帮助文本中通常会阐明显著增加二进制文件大小的设置。

---

**针对性优化** 以下二进制文件大小优化适用于特定的组件或函数：

**Bluetooth NimBLE** 如果使用 *NimBLE-based Host APIs*，要减小二进制文件的大小，可以执行以下操作：

- 如果只需要连接一个 Bluetooth LE，则将 `CONFIG_BT_NIMBLE_MAX_CONNECTIONS` 设置为 1。
- 如果不需要 `CONFIG_BT_NIMBLE_ROLE_CENTRAL` 和 `CONFIG_BT_NIMBLE_ROLE_OBSERVER`，可以选择禁用其一。
- 降低 `CONFIG_BT_NIMBLE_LOG_LEVEL` 可以减小二进制文件的大小。请注意，如果在上述 **减小总体文件大小** 中已经降低了整体日志级别，那么也会降低 NimBLE 的日志级别。

### lwIP IPv6

- 将 `CONFIG_LWIP_IPV6` 设置为 `false` 可以减小 lwIP TCP/IP 堆栈的大小，但将仅支持 IPv4。

---

**备注：**如果禁用 IPv6，*ASIO* 端口等组件将无法使用。

---



## lwIP IPv4

- 如果不需要 IPv4 连接功能，将 `CONFIG_LWIP_IPV4` 设置为 `false` 可以减小 lwIP 的大小，使其成为仅支持 IPv6 的 TCP/IP 堆栈。

---

**备注：**在禁用 IPv4 支持之前，请注意，仅支持 IPv6 的网络环境尚未普及，必须在本地网络中提供支持，例如，由互联网服务提供商提供支持，或使用受限制的本地网络设置。

---

**Newlib Nano 格式化** ESP-IDF 的 I/O 函数 (`printf()` 和 `scanf()` 等) 默认使用 Newlib 的“完整”格式化功能。

启用配置选项 `CONFIG_NEWLIB_NANO_FORMAT` 将使 Newlib 切换到 Nano 格式化模式。这种模式的代码量更小，并且大部分内容被编译到了 ESP32-H2 的 ROM 中，因此不需要将其添加至二进制文件中。

具体的二进制文件大小差异取决于固件使用的功能，但通常为 25 KB 到 50 KB。

启用 Nano 格式化会减少调用 `printf()` 或其他字符串格式化函数的堆栈使用量，参阅 [栈内存大小优化](#)。

“Nano” 格式化不支持 64 位整数或 C99 格式化功能。请在 [Newlib README 文件](#) 中搜索 `--enable-newlib-nano-formatted-io` 来获取完整的限制列表。

**MbedTLS 功能** 在 **Component Config > mbedTLS** 下有多个默认启用的 mbedTLS 功能，如果不需要，可以禁用相应功能以减小代码大小。

这些功能包括：

- `CONFIG_MBEDTLS_HAVE_TIME`
- `CONFIG_MBEDTLS_ECDSA_DETERMINISTIC`
- `CONFIG_MBEDTLS_SHA512_C`
- `CONFIG_MBEDTLS_CLIENT_SSL_SESSION_TICKETS`
- `CONFIG_MBEDTLS_SERVER_SSL_SESSION_TICKETS`
- `CONFIG_MBEDTLS_SSL_CONTEXT_SERIALIZATION`
- `CONFIG_MBEDTLS_SSL_ALPN`
- `CONFIG_MBEDTLS_SSL_RENEGOTIATION`
- `CONFIG_MBEDTLS_CCM_C`
- `CONFIG_MBEDTLS_GCM_C`
- `CONFIG_MBEDTLS_ECP_C` (或者：启用此选项，但在子菜单中禁用部分椭圆曲线)
- `CONFIG_MBEDTLS_ECP_NIST_OPTIM`
- `CONFIG_MBEDTLS_ECP_FIXED_POINT_OPTIM`
- 如果不需要 mbedTLS 的服务器和客户端功能，可以修改 `CONFIG_MBEDTLS_TLS_MODE`
- 可以考虑禁用在 TLS Key Exchange Methods 子菜单中列出的一些密码套件 (例如 `CONFIG_MBEDTLS_KEY_EXCHANGE_RSA`)，以减小代码大小。

每个选项的帮助文本中都有更多信息可供参考。

---

**重要：**强烈建议不要禁用所有 mbedTLS 选项。仅在理解功能用途，并确定在应用程序中不需要此功能时，方可禁用相应选项。请特别注意以下两点：

- 确保设备连接的任何 TLS 服务器仍然可用。如果服务器由第三方或云服务控制，建议确保固件至少支持两种 TLS 密码套件，以防未来某次更新禁用了其中一种。
- 确保连接设备的任何 TLS 客户端仍然可以使用支持/推荐的密码套件进行连接。请注意，未来版本的客户端操作系统可能会移除对某些功能的支持，因此建议启用多个支持的密码套件或算法以实现冗余。

如果依赖于第三方客户端或服务器，请密切关注其有关支持的 TLS 功能的公告和变更。否则，当所支持功能变更时，ESP32-H2 设备可能无法访问。

---

---

**备注：**ESP-IDF 并未测试所有 mbedTLS 编译配置组合。如果发现某个组合无法编译或无法按预期执行，请在 [GitHub](#) 上报告详细信息。

---

**虚拟文件系统 (VFS)** 在 ESP-IDF 中，[虚拟文件系统组件](#) 功能允许使用标准的 I/O 函数（如 open、read、write 等）和 C 库函数（如 fopen、fread、fwrite 等）来访问多个文件系统驱动程序和类似文件的外设驱动程序。当应用程序中不需要文件系统或类似文件的外设驱动功能时，可以部分或完全禁用该功能。VFS 组件提供以下配置选项：

- [CONFIG\\_VFS\\_SUPPORT\\_TERMIOS](#) — 如果应用程序不使用 termios 函数族，可以禁用此选项。目前，这些函数仅在 UART VFS 驱动程序中实现，大多数应用程序可以禁用此选项。禁用后可以减小约 1.8 KB 代码大小。
- [CONFIG\\_VFS\\_SUPPORT\\_SELECT](#) — 如果应用程序不使用 select 函数处理文件描述符，可以禁用此选项。目前，只有 UART 和 eventfd VFS 驱动程序支持 select 函数。请注意，当禁用该选项时，仍然可以使用 select 处理套接字文件描述符。禁用此选项将减小约 2.7 KB 代码大小。
- [CONFIG\\_VFS\\_SUPPORT\\_DIR](#) — 如果应用程序不使用与目录相关的函数，例如 readdir（参阅此选项的描述以获取完整列表），可以禁用此选项。如果应用程序只需打开、读取和写入特定文件，而不需要枚举或创建目录，可以禁用此选项，从而减少超过 0.5 KB 代码大小，具体减小多少取决于使用的文件系统驱动程序。
- [CONFIG\\_VFS\\_SUPPORT\\_IO](#) — 如果应用程序不使用文件系统或类似文件的外设驱动程序，可以禁用此选项，这将禁用所有 VFS 功能，包括上述三个选项。当禁用此选项时，无法使用 [控制台终端](#)。请注意，当禁用此选项时，应用程序仍然可以使用标准 I/O 函数处理套接字文件描述符。相较于默认配置，禁用此选项可以减小约 9.4 KB 代码大小。

## HAL

- 启用 [CONFIG\\_HAL\\_SYSTIMER\\_USE\\_ROM\\_IMPL](#) 可以通过链接 ROM 实现的 systimer HAL 驱动程序来减少 IRAM 使用和二进制文件大小。
- 启用 [CONFIG\\_HAL\\_WDT\\_USE\\_ROM\\_IMPL](#) 可以通过链接 ROM 实现的看门狗 HAL 驱动程序来减少 IRAM 使用和二进制文件大小。

## 堆

- 启用 [CONFIG\\_HEAP\\_TLSF\\_USE\\_ROM\\_IMPL](#) 可以将整个堆功能放置在 flash 中，从而减少 IRAM 使用和二进制文件大小。
- 启用 [CONFIG\\_HEAP\\_TLSF\\_USE\\_ROM\\_IMPL](#) 可以通过链接 ROM 实现的 TLSF 库来减少 IRAM 使用和二进制文件大小。

**引导加载程序大小** 本文档仅涉及 ESP-IDF 应用程序的二进制文件大小，而不涉及 ESP-IDF [二级引导程序](#)。

关于 ESP-IDF 引导加载程序二进制文件大小的讨论，参阅 [引导加载程序大小](#)。

**IRAM 二进制文件大小** 如果二进制文件的 IRAM 部分过大，可以通过减少 IRAM 使用来解决这个问题，参阅 [IRAM 优化](#)。

## 内存优化

固件应用程序的可用 RAM 在某些情况下可能处于低水平，甚至完全耗尽。为此，应调整这些情况下固件应用程序的内存使用情况。

固件应用程序通常需要为内部 RAM 保留备用空间，用于应对非常规情况，或在后续版本的更新中，适应 RAM 使用需求的变化。

**背景** 在进行 ESP-IDF 的内存优化前，应了解有关 ESP32-H2 内存类型的基础知识、C 语言中静态和动态内存使用的区别、以及 ESP-IDF 中栈和堆的使用方式。以上信息均可参阅[堆内存分配](#)。

**测量静态内存使用情况** `idf.py` 工具可用于生成应用程序静态内存的使用情况报告，请参阅[测量静态数据大小](#)。

**测量动态内存使用情况** ESP-IDF 包含一系列堆 API，可以在运行时测量空闲堆内存，请参阅[堆内存调试](#)。

---

**备注：**在嵌入式系统中，除 RAM 使用总量外，也应重点关注堆碎片化问题。堆测量 API 提供了一些方法，可以测量最大空闲内存块。通过监测最大空闲内存块和总空闲字节数，可以快速了解是否存在堆碎片化问题。

---

### 静态内存优化

- 降低应用程序的静态内存使用，会增加运行时堆的可用 RAM 空间，反之亦然。
- 优化静态内存使用通常需要监测 `.data` 和 `.bss` 的大小，有关工具请参阅[测量静态数据大小](#)。
- 在 C 语言中，ESP-IDF 内部函数不会占用大量静态 RAM。在多数情况下（例如蓝牙控制器，IEEE 802.15.4 库），静态缓冲区仍从堆中分配。然而，这些分配只在功能初始化阶段进行一次，并在功能去初始化时释放，从而在应用程序生命周期中，优化不同阶段的可用内存。

要实现静态内存优化，请执行以下操作：

- 由于常量数据可以存储在 flash 中，不占用 RAM，建议尽量将结构体、缓冲区或其他变量声明为 `const`。为此，可能需要修改固件参数，使其接收 `const * 参数` 而非可变指针参数。以上更改还可以减少某些函数的栈内存使用。
- 若使用 Bluedroid，请设置 `CONFIG_BT_BLE_DYNAMIC_ENV_MEMORY` 选项，Bluedroid 将在初始化时分配内存，并在去初始化时释放内存。这并不一定会降低内存使用峰值，但可以将使用静态内存改为运行时使用动态内存。
- 若使用 OpenThread，请设置 `CONFIG_OPENTHREAD_PLATFORM_MSGPOOL_MANAGEMENT` 选项，OpenThread 将从外部 PSRAM 中分配消息池缓冲区，从而减少对内部静态内存的使用。

**栈内存大小优化** 在 FreeRTOS 操作系统中，任务栈通常从堆中分配。每个任务的栈大小固定，且会作为参数传递给 `xTaskCreate()`。每个任务可用的栈内存不得超过为其分配的栈内存大小，否则将导致栈内存溢出或堆内存损坏，使原本可用的程序崩溃。

因此，确定每个任务栈内存的最佳大小、最小化每个任务栈内存大小、以及最小化任务栈内存的整体数量，都可以大幅减少 RAM 的使用。

要确定特定任务栈内存的最佳大小，请执行以下操作：

- 程序运行时，如你认为某任务有未使用的栈内存，可通过其任务句柄调用 `uxTaskGetStackHighWaterMark()`。该函数将以字节为单位，返回任务中生命周期最短的空闲栈内存。
  - 从任务本身内部调用 `uxTaskGetStackHighWaterMark()` 是调用该函数最容易的方式：在任务达到其栈内存使用峰值后，调用 `uxTaskGetStackHighWaterMark(NULL)` 获取当前任务的高水位标记，换言之，如果有主循环，请多次执行主循环来覆盖各种状态，随后调用 `uxTaskGetStackHighWaterMark()`。
  - 通常可以用任务的栈内存总大小减去调用 `uxTaskGetStackHighWaterMark()` 的返回值，计算任务实际使用的栈内存大小，但应留出一定的安全余量，应对运行时栈内存使用量的小幅意外增长。
- 程序运行时，调用 `uxTaskGetSystemState()` 获取系统中所有任务的摘要，包括各栈内存的高水位标记值。

- 在未使用调试器的监视点时，可以设置 `CONFIG_FREERTOS_WATCHPOINT_END_OF_STACK` 选项。启用此选项时，系统会使用一个观察点，监视每个任务栈的最后一个字节。如果有新的数据覆盖了该字节（例如发生栈溢出），将立即触发 `panic`。相比默认 `CONFIG_FREERTOS_CHECK_STACKOVERFLOW` 选项的 Check using canary bytes，这种方式更可靠，因其能够立即触发 `panic`，而不是在下次 RTOS 上下文切换时触发。然而，两种选项都存在缺点，有时栈指针可能会跳过监视点或 canary 字节，损坏 RAM 的其他区域。

要减少特定任务栈内存大小，请执行以下操作：

- 避免占用过多栈内存的函数。字符串格式化函数（如 `printf()`）会使用大量栈内存，如果任务不调用这类函数，通常可以减小其占用的栈内存。
  - 启用 `Newlib Nano 格式化`，可以在任务调用 `printf()` 或其他 C 语言字符串格式化函数时，减少这类任务的栈内存使用量。
- 避免在栈上分配大型变量。在 C 语言声明的默认作用域中，任何分配为自动变量的大型结构体或数组都会占用栈内存。要优化这些变量占用的栈内存大小，可以使用静态分配，或仅在需要从堆中动态分配。
- 避免调用深度递归函数。尽管调用单个递归函数并不一定会占用大量栈内存，但若每个函数都包含大量基于栈的变量，那么调用这些函数的开销将会很高。

要减少任务的整体数量，请执行以下操作：

- 合并任务。如果从未创建某个特定任务，就不会分配该任务的栈内存，从而极大减少 RAM 使用。如果某些任务可以与另一个任务合并，通常可以将不必要的任务删除。在应用程序中，如果满足以下条件，通常可以合并或删除任务：
  - 任务所执行的内容可以按顺序分解为多个函数调用。
  - 任务所执行的内容可以分解为较小的工作，这些工作可以通过 FreeRTOS 队列或类似机制串行化，并由工作任务执行。

**内部任务栈内存大小** 为进行系统维护，或操作系统功能，ESP-IDF 分配了许多内部任务，一部分在启动过程中创建，一部分在初始化特定功能时创建。

为了确保支持所有常见的使用模式，这些任务栈内存的默认设置值较大。ESP-IDF 支持配置栈内存大小，因此可以减小任务栈内存，匹配其实际运行时的栈内存使用情况。

---

**重要：** 如果内部任务的栈内存设置得过小，可能会导致 ESP-IDF 发生无法预测的崩溃。即使任务栈内存溢出是导致崩溃的根本原因，在调试过程中也很难确定具体原因。因此，建议特别关注任务在负载高时的高水位标记，在必要情况下，谨慎减小内部任务的栈内存大小。如果在减小内部任务堆内存大小后，仍遇到问题，请在报告中提供以下信息，以及正在使用的具体配置。

---

- 运行主任务的栈内存大小为 `CONFIG_ESP_MAIN_TASK_STACK_SIZE`。
- 系统任务 `ESP 定时器` 用于执行回调函数，其栈内存大小为 `CONFIG_ESP_TIMER_TASK_STACK_SIZE`。
- 部分 FreeRTOS 定时器任务用于处理 FreeRTOS 定时器回调，其栈内存大小为 `CONFIG_FREERTOS_TIMER_TASK_STACK_DEPTH`。
- 系统任务 `事件循环库` 用于执行默认系统事件循环回调，其栈内存大小为 `CONFIG_ESP_SYSTEM_EVENT_TASK_STACK_SIZE`。
- TCP/IP 任务 `lwIP` 的栈内存大小为 `CONFIG_LWIP_TCPIP_TASK_STACK_SIZE`。
- 蓝牙 API 的栈内存大小为 `CONFIG_BT_BTC_TASK_STACK_SIZE`，`CONFIG_BT_BTU_TASK_STACK_SIZE`。
- `NimBLE-based Host APIs` 的栈内存大小为 `CONFIG_BT_NIMBLE_HOST_TASK_STACK_SIZE`。
- 以太网驱动程序会创建任务，用于使 MAC 接收以太网帧，在默认配置 `ETH_MAC_DEFAULT_CONFIG` 下，任务栈内存大小为 4 KB。在初始化以太网 MAC 时，传递自定义 `eth_mac_config_t` 结构体可以更改此设置。
- FreeRTOS 空闲任务栈内存大小由 `CONFIG_FREERTOS_IDLE_TASK_STACKSIZE` 配置。
- 使用 `ESP-MQTT` 组件时会创建一个任务，其栈内存大小由 `CONFIG_MQTT_TASK_STACK_SIZE` 配置。MQTT 栈内存大小也可以使用 `esp_mqtt_client_config_t` 结构体中的 `task_stack` 字段配置。
- 有关使用 mDNS 时内存优化的详细信息，请参阅 [优化内存使用](#)。



---

**备注：**除 ESP 定时器等内置系统功能外，若固件应用程序没有初始化 ESP-IDF 中特定功能，则不会创建相关任务。此时，相关任务的栈内存使用量为零，而这些功能没有与之关联的任务，因此无需考虑其栈内存大小配置。

---

**堆内存优化** 有关分析运行时堆内存使用的函数，请参阅[堆内存调试](#)。

通常，堆内存优化包含以下几个方面：分析堆内存使用情况、撤回未使用的 `malloc()` 调用、缩小相应的内存使用大小、或提早释放先前分配的缓冲区。

以下是一些 ESP-IDF 配置选项，有助于在运行时实现堆内存优化：

- [lwIP 文档](#)中的有关章节介绍了如何配置[最小内存使用](#)。
- 部分 Mbed TLS 配置选项也可用于堆内存优化，详情请参阅[减少内存使用](#)的 Mbed TLS 部分。

---

**备注：**如果将某些配置选项更改为非默认值，也会增加运行时的堆内存使用。这类选项未在上文中列出，但配置选项的帮助文档中给出了相应说明。

---

**IRAM 优化** 程序运行时，由于使用了静态 IRAM，用于堆内存使用的 DRAM 会相应减少。反之，可以通过减少 IRAM 使用，增加可用 DRAM。

如果应用程序分配的静态 IRAM 超过可用上限，应用程序将无法构建，并出现链接器错误，如 `section '.iram0.text' will not fit in region 'iram0_0_seg'`、`IRAM0 segment data does not fit` 以及 `region 'iram0_0_seg' overflowed by 84-bytes`。如果发生这种情况，应找到减少静态 IRAM 使用的方法，链接应用程序。

要分析固件应用程序二进制文件中的 IRAM 使用情况，请使用[测量静态数据大小](#)。如果固件应用程序链接失败，请参阅[链接器失败时显示文件大小](#)中的步骤，分析失败原因。

要对某些 ESP-IDF 功能进行 IRAM 优化，请使用以下选项：

- 启用 [CONFIG\\_FREERTOS\\_PLACE\\_FUNCTIONS\\_INTO\\_FLASH](#)。只要没有从 ISR 中错误地调用这些函数，就可以在所有配置中安全启用此选项。
- 启用 [CONFIG\\_RINGBUF\\_PLACE\\_FUNCTIONS\\_INTO\\_FLASH](#)。只要没有从 ISR 中错误地调用这些函数，就可以在所有配置中安全启用此选项。
- 启用 [CONFIG\\_RINGBUF\\_PLACE\\_ISR\\_FUNCTIONS\\_INTO\\_FLASH](#)。如果从 IRAM 中的中断上下文中使用 ISR ringbuf 函数，例如启用了 [CONFIG\\_UART\\_ISR\\_IN\\_IRAM](#)，则无法安全使用此选项。在此情况下，安装 ESP-IDF 相关驱动程序时，将在运行时报错。
- 启用 [CONFIG\\_SPI\\_FLASH\\_ROM\\_IMPL](#) 选项可以释放一些 IRAM，但此时 `esp_flash` 错误修复程序及新的 flash 芯片支持将失效，详情请参阅 [SPI Flash API ESP-IDF Version vs Chip-ROM Version](#)。
- 禁用 [CONFIG\\_ESP\\_EVENT\\_POST\\_FROM\\_IRAM\\_ISR](#) 可以防止从 [IRAM 安全中断处理程序](#) 中发布 `esp_event` 事件，节省 IRAM 空间。
- 禁用 [CONFIG\\_SPI\\_MASTER\\_ISR\\_IN\\_IRAM](#) 可以防止在写入 flash 时发生 `spi_master` 中断，节省 IRAM 空间，但可能影响 `spi_master` 的性能。
- 禁用 [CONFIG\\_SPI\\_SLAVE\\_ISR\\_IN\\_IRAM](#) 可以防止在写入 flash 时发生 `spi_slave` 中断，节省 IRAM 空间。
- 设置 [CONFIG\\_HAL\\_DEFAULT\\_ASSERTION\\_LEVEL](#) 为禁用 HAL 组件的断言，可以节省 IRAM 空间，对于经常调用 `HAL_ASSERT` 且位于 IRAM 中的 HAL 代码尤为如此。
- 要禁用不需要的 flash 驱动程序，节省 IRAM 空间，请参阅 `sdkconfig` 菜单中的 `Auto-detect Flash chips` 选项。
- 启用 [CONFIG\\_HEAP\\_PLACE\\_FUNCTION\\_INTO\\_FLASH](#)。只要未启用 [CONFIG\\_SPI\\_MASTER\\_ISR\\_IN\\_IRAM](#) 选项，且没有从 ISR 中错误地调用堆函数，就可以在所有配置中安全启用此选项。

---

**备注：**将常用函数从 IRAM 移动到 flash，可能会增加函数的执行时间。

---

---

**备注：**部分配置选项可以将一些功能移动到 IRAM 中，从而提高性能，但这类选项默认不进行配置，因此未在此列出。了解启用上述选项对 IRAM 大小造成的影响，请参阅配置项的帮助文本。

---

## 4.23 Reproducible Builds

### 4.23.1 Introduction

ESP-IDF build system has support for [reproducible builds](#).

When reproducible builds are enabled, the application built with ESP-IDF does not depend on the build environment. Both the .elf file and .bin files of the application remains exactly the same, even if the following variables change:

- Directory where the project is located
- Directory where ESP-IDF is located (IDF\_PATH)
- Build time

### 4.23.2 Reasons for Non-Reproducible Builds

There are several reasons why an application may depend on the build environment, even when the same source code and tools versions are used.

- In C code, `__FILE__` preprocessor macro is expanded to the full path of the source file.
- `__DATE__` and `__TIME__` preprocessor macros are expanded to compilation date and time.
- When the compiler generates object files, it adds sections with debug information. These sections help debuggers, like GDB, to locate the source code which corresponds to a particular location in the machine code. These sections typically contain paths of relevant source files. These paths may be absolute, and will include the path to ESP-IDF or to the project.

There are also other possible reasons, such as unstable order of inputs and non-determinism in the build system.

### 4.23.3 Enabling Reproducible Builds in ESP-IDF

Reproducible builds can be enabled in ESP-IDF using `CONFIG_APP_REPRODUCIBLE_BUILD` option.

This option is disabled by default. It can be enabled in `menuconfig`.

The option may also be added into `sdkconfig.defaults`. If adding the option into `sdkconfig.defaults`, delete the `sdkconfig` file and run the build again. See [自定义 `sdkconfig` 的默认值](#) for more information.

### 4.23.4 How Reproducible Builds Are Achieved

ESP-IDF achieves reproducible builds using the following measures:

- In ESP-IDF source code, `__DATE__` and `__TIME__` macros are not used when reproducible builds are enabled. Note, if the application source code uses these macros, the build will not be reproducible.
- ESP-IDF build system passes a set of `-fmacro-prefix-map` and `-fdebug-prefix-map` flags to replace base paths with placeholders:
  - Path to ESP-IDF is replaced with `/IDF`
  - Path to the project is replaced with `/IDF_PROJECT`
  - Path to the build directory is replaced with `/IDF_BUILD`

- Paths to components are replaced with `/COMPONENT_NAME_DIR` (where NAME is the name of the component)
- Build date and time are not included into the *application metadata structure* and *bootloader metadata structure* if `CONFIG_APP_REPRODUCIBLE_BUILD` is enabled.
- ESP-IDF build system ensures that source file lists, component lists and other sequences are sorted before passing them to CMake. Various other parts of the build system, such as the linker script generator also perform sorting to ensure that same output is produced regardless of the environment.

### 4.23.5 Reproducible Builds and Debugging

When reproducible builds are enabled, file names included in debug information sections are altered as shown in the previous section. Due to this fact, the debugger (GDB) is not able to locate the source files for the given code location.

This issue can be solved using GDB `set substitute-path` command. For example, by adding the following command to GDB init script, the altered paths can be reverted to the original ones:

```
set substitute-path /COMPONENT_FREERTOS_DIR /home/user/esp/esp-idf/components/
↳freertos
```

ESP-IDF build system generates a file with the list of such `set substitute-path` commands automatically during the build process. The file is called `prefix_map_gdbinit` and is located in the project build directory.

When `idf.py gdb` is used to start debugging, this additional `gdbinit` file is automatically passed to GDB. When launching GDB manually or from an IDE, please pass this additional `gdbinit` script to GDB using `-x build/prefix_map_gdbinit` argument.

### 4.23.6 Factors Which Still Affect Reproducible Builds

Note that the built application still depends on:

- ESP-IDF version
- Versions of the build tools (CMake, Ninja) and the cross-compiler

*IDF Docker 镜像* can be used to ensure that these factors do not affect the build.

## 4.24 RF 校准

ESP32-H2 在 RF 初始化过程中支持以下三种 RF 校准：

1. 部分校准
2. 全面校准
3. 不校准

### 4.24.1 部分校准

在 RF 初始化期间，默认使用部分校准，该方法基于存储在 NVS 中的完全校准数据实现。要使用此校准方法，请前往 `menuconfig` 并启用 `CONFIG_ESP_PHY_CALIBRATION_AND_DATA_STORAGE`。

### 4.24.2 全面校准

在以下几种情况下，使用全面校准：

1. NVS 不存在。
2. 存储校准数据的 NVS 分区已擦除。
3. 硬件 MAC 地址变更。

4. PHY 库版本变更。
5. 从 NVS 分区加载的 RF 校准数据损坏。

全面校准耗时比部分校准长约 100 ms。当启动时长的重要性不高时，建议使用全面校准。要切换到全面校准，请前往 `menuconfig` 并禁用 `CONFIG_ESP_PHY_CALIBRATION_AND_DATA_STORAGE`。如果使用了默认的部分校准，作为最后补救措施，可以使用以下两种方法添加函数，触发全面校准：

1. 如果不介意擦除 NVS 分区中的所有数据，那么擦除 NVS 分区是最简单的方法。
2. 在初始化 Wi-Fi 和 Bluetooth®/Bluetooth Low Energy 前，根据某些条件（例如，在某些诊断模式下提供的选项）调用 API `esp_phy_erase_cal_data_in_nvs()`，此时仅会擦除 NVS 分区的 PHY 命名空间。

### 4.24.3 不校准

设备从 Deep-sleep 模式中唤醒时，可以不校准。

### 4.24.4 PHY 初始化数据

PHY 初始化数据用于 RF 校准，通过以下两种方法，可以获取 PHY 初始化数据。

一是使用默认初始化数据，该数据位于头文件 `components/esp_phy/esp32h2/include/phy_init_data.h` 中。默认初始化数据会在编译后嵌入到应用程序的二进制文件，然后存储在只读存储器 (DROM) 中。要使用默认的初始化数据，请前往 `menuconfig` 并禁用 `CONFIG_ESP_PHY_INIT_DATA_IN_PARTITION`。

二是将初始化数据存储于 PHY 数据分区中。默认的分表已经包含了 PHY 数据分区，但是使用自定义分区表时，请确保在自定义分区表中包含一个 PHY 数据分区（类型：data，子类型：phy）。无论使用自定义分区表还是默认分区表，只要初始化数据存储于分区中，就需要将其烧录到相应的分区中，否则运行时可能会出现错误。如果想要使用存储在分区中的初始化数据，请前往 `menuconfig` 并启用选项 `CONFIG_ESP_PHY_INIT_DATA_IN_PARTITION`。

### 4.24.5 API 参考

#### Header File

- `components/esp_phy/include/esp_phy_init.h`
- This header file can be included with:

```
#include "esp_phy_init.h"
```

- This header file is a part of the API provided by the `esp_phy` component. To declare that your component depends on `esp_phy`, add the following to your `CMakeLists.txt`:

```
REQUIRES esp_phy
```

or

```
PRIV_REQUIRES esp_phy
```

#### Functions

```
const esp_phy_init_data_t* esp_phy_get_init_data (void)
```

Get PHY init data.

If "Use a partition to store PHY init data" option is set in `menuconfig`, This function will load PHY init data from a partition. Otherwise, PHY init data will be compiled into the application itself, and this function will return a pointer to PHY init data located in read-only memory (DROM).

If "Use a partition to store PHY init data" option is enabled, this function may return NULL if the data loaded from flash is not valid.



---

**备注:** Call `esp_phy_release_init_data` to release the pointer obtained using this function after the call to `esp_wifi_init`.

---

返回 pointer to PHY init data structure

void **esp\_phy\_release\_init\_data** (const *esp\_phy\_init\_data\_t* \*data)

Release PHY init data.

参数 **data** -- pointer to PHY init data structure obtained from `esp_phy_get_init_data` function

*esp\_err\_t* **esp\_phy\_load\_cal\_data\_from\_nvs** (*esp\_phy\_calibration\_data\_t* \*out\_cal\_data)

Function called by `esp_phy_load_cal_and_init` to load PHY calibration data.

This is a convenience function which can be used to load PHY calibration data from NVS. Data can be stored to NVS using `esp_phy_store_cal_data_to_nvs` function.

If calibration data is not present in the NVS, or data is not valid (was obtained for a chip with a different MAC address, or obtained for a different version of software), this function will return an error.

参数 **out\_cal\_data** -- pointer to calibration data structure to be filled with loaded data.

返回 ESP\_OK on success

*esp\_err\_t* **esp\_phy\_store\_cal\_data\_to\_nvs** (const *esp\_phy\_calibration\_data\_t* \*cal\_data)

Function called by `esp_phy_load_cal_and_init` to store PHY calibration data.

This is a convenience function which can be used to store PHY calibration data to the NVS. Calibration data is returned by `esp_phy_load_cal_and_init` function. Data saved using this function to the NVS can later be loaded using `esp_phy_store_cal_data_to_nvs` function.

参数 **cal\_data** -- pointer to calibration data which has to be saved.

返回 ESP\_OK on success

*esp\_err\_t* **esp\_phy\_erase\_cal\_data\_in\_nvs** (void)

Erase PHY calibration data which is stored in the NVS.

This is a function which can be used to trigger full calibration as a last-resort remedy if partial calibration is used. It can be called in the application based on some conditions (e.g. an option provided in some diagnostic mode).

返回 ESP\_OK on success

返回 others on fail. Please refer to NVS API return value error number.

void **esp\_phy\_enable** (*esp\_phy\_modem\_t* modem)

Enable PHY and RF module.

PHY and RF module should be enabled in order to use WiFi or BT. Now PHY and RF enabling job is done automatically when start WiFi or BT. Users should not call this API in their application.

参数 **modem** -- the modem to call the phy enable.

void **esp\_phy\_disable** (*esp\_phy\_modem\_t* modem)

Disable PHY and RF module.

PHY module should be disabled in order to shutdown WiFi or BT. Now PHY and RF disabling job is done automatically when stop WiFi or BT. Users should not call this API in their application.

参数 **modem** -- the modem to call the phy disable.

void **esp\_btbb\_enable** (void)

Enable BTBB module.

BTBB module should be enabled in order to use IEEE802154 or BT. Now BTBB enabling job is done automatically when start IEEE802154 or BT. Users should not call this API in their application.

void **esp\_btbb\_disable** (void)

Disable BTBB module.

Disable BTBB module, used by IEEE802154 or Bluetooth. Users should not call this API in their application.

void **esp\_phy\_load\_cal\_and\_init** (void)

Load calibration data from NVS and initialize PHY and RF module.

void **esp\_phy\_modem\_init** (void)

Initialize backup memory for Phy power up/down.

void **esp\_phy\_modem\_deinit** (void)

Deinitialize backup memory for Phy power up/down Set phy\_init\_flag if all modems deinit on ESP32C3.

void **esp\_phy\_common\_clock\_enable** (void)

Enable WiFi/BT common clock.

void **esp\_phy\_common\_clock\_disable** (void)

Disable WiFi/BT common clock.

int64\_t **esp\_phy\_rf\_get\_on\_ts** (void)

Get the time stamp when PHY/RF was switched on.

**返回** return 0 if PHY/RF is never switched on. Otherwise return time in microsecond since boot when phy/rf was last switched on

*esp\_err\_t* **esp\_phy\_update\_country\_info** (const char \*country)

Update the corresponding PHY init type according to the country code of Wi-Fi.

**参数** **country** -- country code

**返回** ESP\_OK on success.

**返回** esp\_err\_t code describing the error on fail

char \***get\_phy\_version\_str** (void)

Get PHY lib version.

**返回** PHY lib version.

void **phy\_init\_param\_set** (uint8\_t param)

Set PHY init parameters.

**参数** **param** -- is 1 means combo module

void **phy\_wifi\_enable\_set** (uint8\_t enable)

Wi-Fi RX enable.

**参数** **enable** -- True for enable wifi receiving mode as default, false for closing wifi receiving mode as default.

## Structures

struct **esp\_phy\_init\_data\_t**

Structure holding PHY init parameters.

## Public Members

uint8\_t **params**[128]

opaque PHY initialization parameters

struct **esp\_phy\_calibration\_data\_t**

Opaque PHY calibration data.

### Public Members

uint8\_t **version**[4]

PHY version

uint8\_t **mac**[6]

The MAC address of the station

uint8\_t **opaque**[1894]

calibration data

### Enumerations

enum **esp\_phy\_modem\_t**

PHY enable or disable modem.

*Values:*

enumerator **PHY\_MODEM\_WIFI**

PHY modem WIFI

enumerator **PHY\_MODEM\_BT**

PHY modem BT

enumerator **PHY\_MODEM\_IEEE802154**

PHY modem IEEE802154

enum **esp\_phy\_calibration\_mode\_t**

PHY calibration mode.

*Values:*

enumerator **PHY\_RF\_CAL\_PARTIAL**

Do part of RF calibration. This should be used after power-on reset.

enumerator **PHY\_RF\_CAL\_NONE**

Don't do any RF calibration. This mode is only suggested to be used after deep sleep reset.

enumerator **PHY\_RF\_CAL\_FULL**

Do full RF calibration. Produces best results, but also consumes a lot of time and current. Suggested to be used once.

### Header File

- [components/esp\\_phy/include/esp\\_phy\\_cert\\_test.h](#)
- This header file can be included with:

```
#include "esp_phy_cert_test.h"
```

- This header file is a part of the API provided by the `esp_phy` component. To declare that your component depends on `esp_phy`, add the following to your `CMakeLists.txt`:

```
REQUIRES esp_phy
```

or

```
PRIV_REQUIRES esp_phy
```

## Functions

void `esp_wifi_power_domain_on` (void)

Wifi power domain power on.

void `esp_wifi_power_domain_off` (void)

Wifi power domain power off.

void `esp_phy_rftest_config` (uint8\_t conf)

Environment variable configuration.

**参数** `conf` -- Set to 1 to enter RF test mode.

void `esp_phy_rftest_init` (void)

RF initialization configuration.

void `esp_phy_tx_contin_en` (bool contin\_en)

TX Continuous mode.

**参数** `contin_en` -- Set to true for continuous packet sending, which can be used for certification testing; Set to false to cancel continuous mode, which is the default mode and can be used for WLAN tester.

void `esp_phy_cbw40m_en` (bool en)

HT40/HT20 mode selection.

**参数** `en` -- Set to false to enter 11n HT20 mode; Set to true to enter 11n HT40 mode;

void `esp_phy_wifi_tx` (uint32\_t chan, `esp_phy_wifi_rate_t` rate, int8\_t backoff, uint32\_t length\_byte, uint32\_t packet\_delay, uint32\_t packet\_num)

Wi-Fi TX command.

**参数**

- **chan** -- channel setting, 1~14;
- **rate** -- rate setting;
- **backoff** -- Transmit power attenuation, unit is 0.25dB. For example, 4 means that the power is attenuated by 1dB;
- **length\_byte** -- TX packet length configuration, indicating PSDU Length, unit is byte;
- **packet\_delay** -- TX packet interval configuration, unit is us;
- **packet\_num** -- The number of packets sent, 0 means sending packets continuously, other values represent the number of packets to send.

void `esp_phy_test_start_stop` (uint8\_t value)

Test start/stop command, used to stop transmitting or receiving state.

**参数** `value` -- Value should be set to 3 before TX/RX. Set value to 0 to end TX/RX state.

void `esp_phy_wifi_rx` (uint32\_t chan, `esp_phy_wifi_rate_t` rate)

Wi-Fi RX command.

**参数**

- **chan** -- channel setting, 1~14;

- **rate** -- rate setting;

void **esp\_phy\_wifi\_tx\_tone** (uint32\_t start, uint32\_t chan, uint32\_t backoff)

Wi-Fi Carrier Wave(CW) TX command.

#### 参数

- **start** -- enable CW, 1 means transmit, 0 means stop transmitting;
- **chan** -- CW channel setting, 1~14;
- **backoff** -- CW power attenuation parameter, unit is 0.25dB. 4 indicates the power is attenuated by 1dB.

void **esp\_phy\_ble\_tx** (uint32\_t txpwr, uint32\_t chan, uint32\_t len, *esp\_phy\_ble\_type\_t* data\_type, uint32\_t syncw, *esp\_phy\_ble\_rate\_t* rate, uint32\_t tx\_num\_in)

BLE TX command.

#### 参数

- **txpwr** -- Transmit power level. Tx power is about (level-8)\*3 dBm, step is 3dB. Level 8 is around 0 dBm;
- **chan** -- channel setting, range is 0~39, corresponding frequency = 2402+chan\*2;
- **len** -- Payload length setting, range is 0-255, unit is byte, 37 bytes is employed generally;
- **data\_type** -- Data type setting;
- **syncw** -- Packet identification (need to be provided by the packet generator or instrument manufacturer), 0x71764129 is employed generally;
- **rate** -- rate setting;
- **tx\_num\_in** -- The number of packets sent, 0 means sending packets continuously, other values represent the number of packets to send.

void **esp\_phy\_ble\_rx** (uint32\_t chan, uint32\_t syncw, *esp\_phy\_ble\_rate\_t* rate)

BLE RX command.

#### 参数

- **chan** -- channel selection, range is 0-39; Channels 0, 1, 2~10 correspond to 2404MHz, 2406MHz, 2408MHz~2424MHz respectively; Channels 11, 12, 13~36 correspond to 2428MHz, 2430MHz, 2432MHz~2478MHz respectively; Channel 37: 2402MHz, Channel 38: 2426MHz, Channel 39: 2480MHz;
- **syncw** -- Packet identification (need to be provided by the packet generator or instrument manufacturer), 0x71764129 is employed generally;
- **rate** -- rate setting;

void **esp\_phy\_bt\_tx\_tone** (uint32\_t start, uint32\_t chan, uint32\_t power)

BLE Carrier Wave(CW) TX command.

#### 参数

- **start** -- enable CW, 1 means transmit, 0 means stop transmitting;
- **chan** -- Single carrier transmission channel selection, range is 0~39, corresponding frequency freq = 2402+chan\*2;
- **power** -- CW power attenuation parameter, unit is 0.25dB. 4 indicates the power is attenuated by 1dB.

void **esp\_phy\_get\_rx\_result** (*esp\_phy\_rx\_result\_t* \*rx\_result)

Get some RX information.

参数 **rx\_result** -- This struct for storing RX information;

## Structures

struct **esp\_phy\_rx\_result\_t**

Structure holding PHY RX result.

### Public Members

uint32\_t **phy\_rx\_correct\_count**

The number of desired packets received

int **phy\_rx\_rssi**

Average RSSI of desired packets

uint32\_t **phy\_rx\_total\_count**

The number of total packets received

uint32\_t **phy\_rx\_result\_flag**

0 means no RX info; 1 means the latest Wi-Fi RX info; 2 means the latest BLE RX info.

### Enumerations

enum **esp\_phy\_wifi\_rate\_t**

*Values:*

enumerator **PHY\_RATE\_1M**

enumerator **PHY\_RATE\_2M**

enumerator **PHY\_RATE\_5M5**

enumerator **PHY\_RATE\_11M**

enumerator **PHY\_RATE\_6M**

enumerator **PHY\_RATE\_9M**

enumerator **PHY\_RATE\_12M**

enumerator **PHY\_RATE\_18M**

enumerator **PHY\_RATE\_24M**

enumerator **PHY\_RATE\_36M**

enumerator **PHY\_RATE\_48M**

enumerator **PHY\_RATE\_54M**

enumerator **PHY\_RATE\_MCS0**

enumerator **PHY\_RATE\_MCS1**

enumerator **PHY\_RATE\_MCS2**

enumerator **PHY\_RATE\_MCS3**

enumerator **PHY\_RATE\_MCS4**

enumerator **PHY\_RATE\_MCS5**

enumerator **PHY\_RATE\_MCS6**

enumerator **PHY\_RATE\_MCS7**

enumerator **PHY\_WIFI\_RATE\_MAX**

enum **esp\_phy\_ble\_rate\_t**

*Values:*

enumerator **PHY\_BLE\_RATE\_1M**

enumerator **PHY\_BLE\_RATE\_2M**

enumerator **PHY\_BLE\_RATE\_125K**

enumerator **PHY\_BLE\_RATE\_500k**

enumerator **PHY\_BLE\_RATE\_MAX**

enum **esp\_phy\_ble\_type\_t**

*Values:*

enumerator **PHY\_BLE\_TYPE\_1010**

enumerator **PHY\_BLE\_TYPE\_00001111**

enumerator **PHY\_BLE\_TYPE\_prbs9**

enumerator **PHY\_BLE\_TYPE\_00111100**

enumerator **PHY\_BLE\_TYPE\_MAX**

## 4.25 线程局部存储

## 4.25.1 概述

线程局部存储 (TLS) 机制可以分配变量，使每个现有的线程都有相应变量实例。ESP-IDF 提供了以下三种方法，支持使用此类变量：

- *FreeRTOS 原生 API*：ESP-IDF FreeRTOS 原生 API。
- *Pthread API*：ESP-IDF pthread API。
- *C11 标准*：C11 标准引入了特殊关键字，将变量声明为线程局部变量。

## 4.25.2 FreeRTOS 原生 API

ESP-IDF FreeRTOS 提供以下 API，用于管理线程局部变量：

- `vTaskSetThreadLocalStoragePointer()`
- `pvTaskGetThreadLocalStoragePointer()`
- `vTaskSetThreadLocalStoragePointerAndDelCallback()`

此时，可以分配的最大变量数量受 `CONFIG_FREERTOS_THREAD_LOCAL_STORAGE_POINTERS` 限制。变量保存在任务控制块 (TCB) 中，并由其索引访问。注意，索引 0 保留，供 ESP-IDF 内部使用。

通过使用上述 API，你可以分配任意大小的线程局部变量，并将其分配给任意数量的任务。不同任务可以拥有不同的 TLS 变量集。

如果变量大小超过 4 个字节，你需要负责为其分配/释放内存。在任务删除时，FreeRTOS 会释放变量，但必须提供回调函数来适当清理。

## 4.25.3 Pthread API

ESP-IDF 提供以下 *POSIX Thread*，用于管理线程局部变量：

- `pthread_key_create()`
- `pthread_key_delete()`
- `pthread_getspecific()`
- `pthread_setspecific()`

Pthread API 具备 FreeRTOS 原生 API 的所有优点，并突破了 FreeRTOS 原生 API 的部分限制，如变量数量仅受堆上可用内存大小的限制。然而由于 Pthread API 具备动态性质，与原生 API 相比，这个 API 引入了额外的性能开销。

## 4.25.4 C11 标准

ESP-IDF FreeRTOS 支持基于 C11 标准的线程局部变量，使用 `__thread` 关键字指定。要了解 GCC 功能详情，请参阅 [GCC 文档](#)。

这类变量的存储空间分配在任务栈上。请注意，即使任务根本不使用这些变量，程序中所有这类变量的存储区域都会在系统中每个任务的栈上分配。例如，ESP-IDF 系统任务（如 `ipc`、`timer` 任务等）也有额外的栈空间分配。因此，使用这个特性时，需要谨慎考虑。

在使用 C11 线程局部变量时，可以针对以下特点进行权衡：在编程中使用 C11 线程局部变量非常方便，使用最少的 CPU 指令即可访问，但这一优势的代价是系统中所有任务都会额外使用栈。由于变量分配的静态性质，系统中的所有任务具有一组相同的 C11 线程局部变量。

## 4.26 工具

### 4.26.1 IDF 前端工具 - `idf.py`



idf.py 命令行工具提供了一个前端界面，管理工程构建、工程部署及工程调试等操作。该前端界面使用多项工具，如：

- **CMake** 用于配置要构建的工程。
- **Ninja** 用于构建工程。
- **esptool.py** 用于烧录目标芯片。

**第五步：开始使用 ESP-IDF 吧** 简要介绍了设置 idf.py 以配置、构建及烧录工程的操作流程。

---

**重要：** idf.py 应在 ESP-IDF 工程目录下运行，即包含 CMakeLists.txt 文件的目录。旧版本工程，即包含 Makefile 的目录，与 idf.py 不兼容。

---

## 常用命令

### 创建新工程：create-project

```
idf.py create-project <project name>
```

此命令将创建一个新的 ESP-IDF 工程。此外，使用 --path 选项可指定工程创建路径。

### 创建新组件：create-component

```
idf.py create-component <component name>
```

此命令将创建一个新的组件，包含构建所需的最基本文件集。使用 -C 选项可指定组件创建目录。有关组件的更多信息，请参阅[组件 CMakeLists 文件](#)。

**选择目标芯片：set-target** ESP-IDF 支持多个目标芯片，运行 idf.py --list-targets 查看当前 ESP-IDF 版本支持的所有目标芯片。

```
idf.py set-target <target>
```

此命令将设置当前工程的目标芯片。

**重要：** idf.py set-target 将清除构建目录，并重新生成 sdkconfig 文件，原来的 sdkconfig 文件保存为 sdkconfig.old。

---

**备注：** idf.py set-target 命令与以下操作效果相同：

1. 清除构建目录 (idf.py fullclean)
  2. 删除 sdkconfig 文件 (mv sdkconfig sdkconfig.old)
  3. 使用新的目标芯片重新配置工程 (idf.py -DIDF\_TARGET=esp32 reconfigure)
- 

所需的 IDF\_TARGET 还可以作为环境变量（如 export IDF\_TARGET=esp32s2）或 CMake 变量（如将 -DIDF\_TARGET=esp32s2 作为 CMake 或 idf.py 的参数）传递。在经常使用同类芯片的情况下，设置环境变量将使操作更加便利。

要给指定工程设定 IDF\_TARGET 的默认值，请将 CONFIG\_IDF\_TARGET 选项添加到该工程的 sdkconfig.defaults 文件（如 CONFIG\_IDF\_TARGET="esp32s2"）。若未通过使用环境变量、CMake 变量或 idf.py set-target 命令等方法指定 IDF\_TARGET，则默认使用该选项的值。

若未通过以上任一方法设置目标芯片，构建系统将默认使用 esp32。

### 启动图形配置工具：menuconfig

```
idf.py menuconfig
```

### 构建工程: **build**

```
idf.py build
```

此命令将构建当前目录下的工程，具体步骤如下：

- 若有需要，创建构建子目录 `build` 保存构建输出文件，使用 `-B` 选项可改变子目录的路径。
- 必要时运行 **CMake** 配置工程，并为主要构建工具生成构建文件。
- 运行主要构建工具 (**Ninja** 或 **GNU Make**)。默认情况下，构建工具会完成自动检测，也可通过将 `-G` 选项传递给 `idf.py` 来显式设置构建工具。

构建是增量行为，因此若上次构建结束后，源文件或配置并未发生更改，则不会执行任何操作。

此外，使用 `app`、`bootloader` 或 `partition-table` 参数运行此命令，可选择仅构建应用程序、引导加载程序或分区表。

### 清除构建输出: **clean**

```
idf.py clean
```

此命令可清除构建目录中的构建输出文件，下次构建时，工程将完全重新构建。注意，使用此选项不会删除构建文件夹内的 **CMake** 配置输出。

### 删除所有构建内容: **fullclean**

```
idf.py fullclean
```

此命令将删除所有 `build` 子目录内容，包括 **CMake** 配置输出。下次构建时，**CMake** 将重新配置其输出。注意，此命令将递归删除构建目录下的所有文件（工程配置将保留），请谨慎使用。

### 烧录工程: **flash**

```
idf.py flash
```

此命令将在需要时自动构建工程，随后将其烧录到目标芯片。使用 `-p` 和 `-b` 选项可分别设置串口名称和烧录程序的波特率。

---

**备注：**环境变量 `ESPPORT` 和 `ESPBAUD` 可分别设置 `-p` 和 `-b` 选项的默认值，在命令行上设置这些选项的参数可覆盖默认值。

---

与 `build` 命令类似，使用 `app`、`bootloader` 或 `partition-table` 参数运行此命令，可选择仅烧录应用程序、引导加载程序或分区表。

### 错误处理提示

`idf.py` 使用存储在 [tools/idf\\_py\\_actions/hints.yml](#) 中的提示数据库，当找到与给定错误相匹配的提示时，`idf.py` 会打印该提示以尝试提供解决方案。目前，错误处理提示不支持 `menuconfig` 对象。

若无需该功能，可以通过 `idf.py` 的 `--no-hints` 参数关闭提示。

### 重要提示

多个 `idf.py` 命令可以在同一行命令中组合使用。例如，`idf.py -p COM4 clean flash monitor` 可以清除源代码树、编译工程、并将其烧录到目标芯片，随后运行串行监视器。

在同一调用中，多个 `idf.py` 命令的顺序并不重要，它们将自动以正确的程序执行，以使全部操作生效（例如先构建后烧录、先擦除后烧录）。

`idf.py` 会尝试将未知命令作为构建系统目标执行。

命令 `idf.py` 支持 `bash`、`zsh` 和 `fish shell` 的 **shell 自动补全**。

调用命令 `export` 为 `idf.py` 启用自动补全（[第四步：设置环境变量](#)），按 `TAB` 键启动自动补全。输入 `idf.py -` 并按 `TAB` 键以自动补全选项。

预计未来版本将支持 `PowerShell` 自动补全。

## 高级命令

### 打开文档: `docs`

```
idf.py docs
```

此命令将在浏览器中打开工程目标芯片和 ESP-IDF 版本对应的文档。

### 显示大小: `Size`

```
idf.py size
```

此命令将显示应用程序大小，包括占用的 `RAM` 和 `flash` 及各部分（如 `.bss`）的大小。

```
idf.py size-components
```

此命令将显示工程中各个组件的应用程序大小。

```
idf.py size-files
```

该命令将显示工程中每个源文件的大小。

## 选项

- `--format` 指定输出格式，可输出 `text`、`csv`、`json` 格式，默认格式为 `text`。
- `--output-file` 可选参数，可以指定命令输出文件的文件名，而非标准输出。

### 重新配置工程: `reconfigure`

```
idf.py reconfigure
```

此命令将重新运行 `CMake`。正常情况下并不会用到该命令，因为一般无需重新运行 `CMake`，但如果从源代码树中添加或删除了文件，或需要修改 `CMake` 缓存变量时，将有必要使用该命令。例如，`idf.py -DNAME='VALUE' reconfigure` 可将变量 `NAME` 在 `CMake` 缓存中设置为值 `VALUE`。

### 清除 Python 字节码: `python-clean`

```
idf.py python-clean
```

此命令将从 `ESP-IDF` 目录中删除生成的 Python 字节码。字节码在切换 `ESP-IDF` 和 Python 版本时可能会引起问题，建议在切换 Python 版本后运行此命令。

### 生成 UF2 二进制文件: `uf2`

```
idf.py uf2
```

此命令将在构建目录中生成一个 UF2 (USB 烧录格式) 二进制文件 `uf2.bin`，该文件包含所有烧录目标芯片所必需的二进制文件，即引导加载程序、应用程序和分区表。

在 ESP 芯片上运行 [ESP USB Bridge](#) 项目将创建一个 USB 大容量存储设备，用户可以将生成的 UF2 文件复制到该 USB 设备中，桥接 MCU 将使用该文件来烧录目标 MCU。这一操作十分简单，只需将文件复制(或“拖放”)到文件资源管理器访问的公开磁盘中即可。

如需仅为应用程序生成 UF2 二进制文件，即不包含加载引导程序和分区表，请使用 `uf2-app` 命令。

```
idf.py uf2-app
```

### 读取 Otadata 分区: `read-otadata`

```
idf.py read-otadata
```

此命令将打印 `otadata` 分区的内容，该分区存储当前所选 OTA 应用程序分区的信息。有关 `otadata` 分区的更多信息，请参阅[空中升级 \(OTA\)](#)。

### 全局选项

运行 `idf.py --help` 列出所有可用的根级别选项。要列出特定子命令的选项，请运行 `idf.py <command> --help`，如 `idf.py monitor --help`。部分常用选项如下：

- `-C <dir>` 支持从默认当前工作目录覆盖工程目录。
- `-B <dir>` 支持从工程目录的默认 `build` 子目录覆盖构建目录。
- `--ccache` 可以在安装了 [CCache](#) 工具的前提下，在构建源文件时启用 [CCache](#)，减少部分构建耗时。

**重要：** 注意，某些旧版本 [CCache](#) 在某些平台上存在 bug，因此如果文件没有按预期重新构建，可禁用 [CCache](#) 并重新构建。可以通过将环境变量 `IDF_CCACHE_ENABLE` 设置为非零值来默认启用 [CCache](#)。

- `-v` 会使 `idf.py` 和构建系统生成详细的构建输出，有助于调试构建错误。
- `--cmake-warn-uninitialized` (或 `-w`) 将使 [CMake](#) 只显示在工程目录中发现的变量未初始化的警告，该选项仅控制 [CMake](#) 内部的 [CMake](#) 变量警告，不控制其他类型的构建警告。将环境变量 `IDF_CMAKE_WARN_UNINITIALIZED` 设置为非零值，可永久启用该选项。
- `--no-hints` 用于禁用有关错误处理的提示并禁用捕获输出。

**通过 @file 传递参数** 可以通过文件向 `idf.py` 传递多个参数。该文件或文件路径须在开头使用 `@` 进行标注。文件中的参数支持通过换行或空格分隔，并按其在 `idf.py` 命令行中的顺序扩展。

例如，当前有文件 `custom_flash.txt`：

```
flash --baud 115200
```

运行命令：`idf.py @custom_flash.txt monitor`

文件中的参数可以与额外的命令行参数结合使用，也支持同时使用带有 `@` 标注的多个文件。例如，另有一个文件 `another_config.txt`，此时，可以通过指定 `idf.py @custom_flash.txt @another_config.txt monitor` 同时使用两个文件。

关于参数文件的更多示例，如通过 `@filename` 创建配置文件概要，请参阅 [多个构建配置示例](#)。

## 4.2.6.2 IDF 监视器

IDF 监视器是一个串行终端程序，使用了 [esp-idf-monitor](#) 包，用于收发目标设备串口的串行数据，IDF 监视器同时还兼具 ESP-IDF 的其他特性。

在 ESP-IDF 中调用 `idf.py monitor` 可以启用此监视器。

### 操作快捷键

为了方便与 IDF 监视器进行交互，请使用表中给出的快捷键。这些快捷键可以自定义，请查看[配置文件](#)章节了解详情。

快捷键	操作	描述
Ctrl + ]	退出监视器程序	
Ctrl + T	菜单退出键	按下如下给出的任意键之一，并按指示操作。
• Ctrl + T	将菜单字符发送至远程	
• Ctrl + ]	将 exit 字符发送至远程	
• Ctrl + P	重置目标设备，进入引导加载程序，通过 RTS 和 DTR 线暂停应用程序	重置目标设备，通过 RTS 和 DTR 线（如已连接）进入引导加载程序。这会阻止开发板运行任何程序，在等待其他设备启动时可以使用此操作。更多详细信息，请参考 <a href="#">复位目标到引导加载程序</a> 。
• Ctrl + R	通过 RTS 线重置目标设备	重置设备，并通过 RTS 线（如已连接）重新启动应用程序。
• Ctrl + F	编译并烧录此项目	暂停 <code>idf_monitor</code> ，运行 <code>flash</code> 目标，然后恢复 <code>idf_monitor</code> 。任何改动的源文件都会被重新编译，然后重新烧录。如果 <code>idf_monitor</code> 是以参数 <code>-E</code> 启动的，则会运行目标 <code>encrypted-flash</code> 。
• Ctrl + A (或者 A)	仅编译及烧录应用程序	暂停 <code>idf_monitor</code> ，运行 <code>app-flash</code> 目标，然后恢复 <code>idf_monitor</code> 。这与 <code>flash</code> 类似，但只有主应用程序被编译并被重新烧录。如果 <code>idf_monitor</code> 是以参数 <code>-E</code> 启动的，则会运行目标 <code>encrypted-flash</code> 。
• Ctrl + Y	停止/恢复在屏幕上打印日志输出	激活时，会丢弃所有传入的串行数据。允许在不退出监视器的情况下快速暂停和检查日志输出。
• Ctrl + L	停止/恢复向文件写入日志输出	在工程目录下创建一个文件，用于写入日志输出。可使用快捷键停止/恢复该功能（退出 IDF 监视器也会终止该功能）。
• Ctrl + I (或者 I)	停止/恢复打印时间标记	IDF 监视器可以在每一行的开头打印一个时间标记。时间标记的格式可以通过 <code>--timestamp-format</code> 命令行参数来改变。
• Ctrl + H (或者 H)	显示所有快捷键	
• Ctrl + X (或者 X)	退出监视器程序	
Ctrl + C	中断正在运行的应用程序	暂停 IDF 监视器并运行 <a href="#">GDB</a> 项目调试器，从而在运行时调试应用程序。这需要启用 <code>ref: CONFIG_ESP_SYSTEM_GDBSTUB_RUNTIME</code> 选项。

除了 Ctrl-] 和 Ctrl-T，其他快捷键信号会通过串口发送到目标设备。

**兼具 ESP-IDF 特性**

**自动解码地址** 每当芯片输出指向可执行代码的十六进制地址时，IDF 监视器将查找该地址在源代码中的位置（文件名和行号），并在下一行用黄色打印出该位置。

ESP-IDF 应用程序发生 crash 和 panic 事件时，将产生如下的寄存器转储和回溯：

```

abort() was called at PC 0x42067cd5 on core 0

Stack dump detected
Core 0 register dump:
MEPC   : 0x40386488  RA       : 0x40386b02  SP       : 0x3fc9a350  GP       : _
↳0x3fc923c0
TP     : 0xa5a5a5a5  T0      : 0x37363534  T1       : 0x7271706f  T2       : _
↳0x33323130
S0/FP  : 0x00000004  S1      : 0x3fc9a3b4  A0       : 0x3fc9a37c  A1       : _
↳0x3fc9a3b2
A2     : 0x00000000  A3      : 0x3fc9a3a9  A4       : 0x00000001  A5       : _
↳0x3fc99000
A6     : 0x7a797877  A7      : 0x76757473  S2       : 0xa5a5a5a5  S3       : _
↳0xa5a5a5a5
S4     : 0xa5a5a5a5  S5      : 0xa5a5a5a5  S6       : 0xa5a5a5a5  S7       : _
↳0xa5a5a5a5
S8     : 0xa5a5a5a5  S9      : 0xa5a5a5a5  S10      : 0xa5a5a5a5  S11      : _
↳0xa5a5a5a5
T3     : 0x6e6d6c6b  T4      : 0x6a696867  T5       : 0x66656463  T6       : _
↳0x62613938
MSTATUS : 0x00001881  MTVEC   : 0x40380001  MCAUSE   : 0x00000007  MTVAL    : _
↳0x00000000

MHARTID : 0x00000000

Stack memory:
3fc9a350: 0xa5a5a5a5 0xa5a5a5a5 0x3fc9a3b0 0x403906cc 0xa5a5a5a5 0xa5a5a5a5 _
↳0xa5a5a5a5
3fc9a370: 0x3fc9a3b4 0x3fc9423c 0x3fc9a3b0 0x726f6261 0x20292874 0x20736177 _
↳0x6c6c6c61635
3fc9a390: 0x43502074 0x34783020 0x37363032 0x20356463 0x63206e6f 0x2065726f _
↳0x000000300
3fc9a3b0: 0x00000030 0x36303234 0x35646337 0x3c093700 0x0000002a 0xa5a5a5a5 _
↳0x3c0937f48
3fc9a3d0: 0x00000001 0x3c0917f8 0x3c0937d4 0x0000002a 0xa5a5a5a5 0xa5a5a5a5 _
↳0xa5a5a5a5e
3fc9a3f0: 0x0001f24c 0x000000c8 0x00000000 0x0001c200 0xffffffff 0xffffffff _
↳0x000000200
3fc9a410: 0x00001000 0x00000002 0x3c093818 0x3fccb470 0xa5a5a5a5 0xa5a5a5a5 _
↳0xa5a5a5a56
.....

```

通过分析堆栈转储 IDF 监视器为寄存器转储补充如下信息：

```

abort() was called at PC 0x42067cd5 on core 0
0x42067cd5: __assert_func at /builds/idf/crosstool-NG/.build/riscv32-esp-elf/src/
↳newlib/newlib/libc/stdlib/assert.c:62 (discriminator 8)

Stack dump detected
Core 0 register dump:
MEPC   : 0x40386488  RA       : 0x40386b02  SP       : 0x3fc9a350  GP       : _
↳0x3fc923c0
0x40386488: panic_abort at /home/marius/esp-idf_2/components/esp_system/panic.c:367

0x40386b02: rtos_int_enter at /home/marius/esp-idf_2/components/freertos/port/
↳riscv/portasm.S:35

```

(下页继续)

(续上页)

```

TP      : 0xa5a5a5a5  T0      : 0x37363534  T1      : 0x7271706f  T2      : _
↳0x33323130
S0/FP   : 0x00000004  S1      : 0x3fc9a3b4  A0      : 0x3fc9a37c  A1      : _
↳0x3fc9a3b2
A2      : 0x00000000  A3      : 0x3fc9a3a9  A4      : 0x00000001  A5      : _
↳0x3fc99000
A6      : 0x7a797877  A7      : 0x76757473  S2      : 0xa5a5a5a5  S3      : _
↳0xa5a5a5a5
S4      : 0xa5a5a5a5  S5      : 0xa5a5a5a5  S6      : 0xa5a5a5a5  S7      : _
↳0xa5a5a5a5
S8      : 0xa5a5a5a5  S9      : 0xa5a5a5a5  S10     : 0xa5a5a5a5  S11     : _
↳0xa5a5a5a5
T3      : 0x6e6d6c6b  T4      : 0x6a696867  T5      : 0x66656463  T6      : _
↳0x62613938
MSTATUS : 0x00001881  MTVEC   : 0x40380001  MCAUSE  : 0x00000007  MTVAL   : _
↳0x00000000

MHARTID : 0x00000000

Backtrace:
panic_abort (details=details@entry=0x3fc9a37c "abort() was called at PC 0x42067cd5_
↳on core 0") at /home/marius/esp-idf_2/components/esp_system/panic.c:367
367     *((int *) 0) = 0; // NOLINT(clang-analyzer-core.NullDereference) should be_
↳an invalid operation on targets
#0  panic_abort (details=details@entry=0x3fc9a37c "abort() was called at PC_
↳0x42067cd5 on core 0") at /home/marius/esp-idf_2/components/esp_system/panic.
↳c:367
#1  0x40386b02 in esp_system_abort (details=details@entry=0x3fc9a37c "abort() was_
↳called at PC 0x42067cd5 on core 0") at /home/marius/esp-idf_2/components/esp_
↳system/system_api.c:108
#2  0x403906cc in abort () at /home/marius/esp-idf_2/components/newlib/abort.c:46
#3  0x42067cd8 in __assert_func (file=file@entry=0x3c0937f4 "", line=line@entry=42,
↳ func=func@entry=0x3c0937d4 <__func__.8540> "",_
↳ failedexpr=failedexpr@entry=0x3c0917f8 "") at /builds/idf/crosstool-NG/.build/
↳riscv32-esp-elf/src/newlib/newlib/libc/stdlib/assert.c:62
#4  0x4200729e in app_main () at ../main/iperf_example_main.c:42
#5  0x42086cd6 in main_task (args=<optimized out>) at /home/marius/esp-idf_2/
↳components/freertos/port/port_common.c:133
#6  0x40389f3a in vPortEnterCritical () at /home/marius/esp-idf_2/components/
↳freertos/port/riscv/port.c:129

```

IDF 监视器在后台运行以下命令，解码各地址：

```
riscv32-esp-elf-addr2line -pfiaC -e build/PROJECT.elf ADDRESS
```

如果在应用程序源代码中找不到匹配的地址，IDF 监视器还会检查 ROM 代码。此时不会打印源文件名和行号，只显示函数名 in ROM:

```

abort() was called at PC 0x400481c1 on core 0
0x400481c1: ets_rsa_pss_verify in ROM

Stack dump detected
Core 0 register dump:
MEPC   : 0x4038051c  RA      : 0x40383840  SP      : 0x3fc8f6b0  GP      : _
↳0x3fc8b000
0x4038051c: panic_abort at /Users/espessif/esp-idf/components/esp_system/panic.
↳c:452
0x40383840: __ubsan_include at /Users/espessif/esp-idf/components/esp_system/
↳ubsan.c:313

```

(下页继续)



(续上页)

```

TP      : 0x3fc8721c  T0      : 0x37363534  T1      : 0x7271706f  T2      : ↵
↳0x33323130
S0/FP   : 0x00000004  S1      : 0x3fc8f714  A0      : 0x3fc8f6dc  A1      : ↵
↳0x3fc8f712
A2      : 0x00000000  A3      : 0x3fc8f709  A4      : 0x00000001  A5      : ↵
↳0x3fc8c000
A6      : 0x7a797877  A7      : 0x76757473  S2      : 0x00000000  S3      : ↵
↳0x3fc8f750
S4      : 0x3fc8f7e4  S5      : 0x00000000  S6      : 0x400481b0  S7      : ↵
↳0x3c025841
0x400481b0: ets_rsa_pss_verify in ROM
.....

```

ROM ELF 文件会根据 `IDF_PATH` 和 `ESP_ROM_ELF_DIR` 环境变量的路径自动加载。如需覆盖此行为, 可以通过调用 `esp_idf_monitor` 并指定特定的 ROM ELF 文件路径: `python -m esp_idf_monitor --rom-elf-file [ROM ELF 文件的路径]`。

**备注:** 将环境变量 `ESP_MONITOR_DECODE` 设置为 0 或者调用 `esp_idf_monitor` 的特定命令行选项 `python -m esp_idf_monitor --disable-address-decoding` 来禁止地址解码。

**连接时复位目标芯片** 默认情况下, IDF 监视器会在目标芯片连接时通过 DTR 和 RTS 串行线自动复位芯片。要防止 IDF 监视器在连接时自动复位, 请在调用 IDF 监视器时加上选项 `--no-reset`, 如 `idf.py monitor --no-reset`, 或者将环境变量 `ESP_IDF_MONITOR_NO_RESET` 设置成 1。

**备注:** `--no-reset` 选项在 IDF 监视器连接到特定端口时可以实现同样的效果, 如 `idf.py monitor --no-reset -p [PORT]`。

**复位目标到引导加载程序** IDF 监视器可以通过预定义的复位序列将芯片复位到引导加载程序, 该序列已经经过调整, 可以在大多数环境中正常工作。此外, 用户可以设置自定义复位序列。通过对复位序列进行微调, 使其适应各种情况。

**使用预定义的复位序列** IDF 监视器的默认复位序列可在大多数环境中使用。使用默认序列复位芯片到引导加载程序中, 无需进行额外配置。

**自定义复位序列** 对于高级用户或特定用例, IDF 监视器支持使用配置文件配置自定义复位序列。这在默认序列可能不足的极端情况下特别有用。

复位序列可通过以下格式的字符串定义:

- 各个命令由 | 分隔 (例如 `R0|D1|W0.5`)。
- 命令 (例如 `R0`) 由代码 (R) 和参数 (0) 定义。

代码	操作	参数
D	设置 DTR 控制线	1/0
R	设置 RTS 控制线	1/0
U	同时设置 DTR 和 RTS 控制线 (仅适用于类 Unix 系统)	0, 0/0, 1/1, 0/1, 1
W	等待 N 秒 (其中 N 为浮点数)	N

示例:



```
[esp-idf-monitor]
custom_reset_sequence = U0,1|W0.1|D1|R0|W0.5|D0
```

有关更多详细信息，请参阅 Esptool 文档中 [custom reset sequence](#) 章节。请注意，IDF 监视器只使用了 Esptool 配置中的 `custom_reset_sequence` 值，其他值会被 IDF 监视器忽略。

**IDF 监视器和 Esptool 之间共享配置** 自定义复位序列的配置可以在 IDF 监视器和 Esptool 之间的共享配置文件中指定。在这种情况下，为了使两个工具都能识别配置文件，其名称应为 `setup.cfg` 或 `tox.ini`。

共享配置文件的示例：

```
[esp-idf-monitor]
menu_key = T
skip_menu_key = True

[esptool]
custom_reset_sequence = U0,1|W0.1|D1|R0|W0.5|D0
```

**备注：** 当在 `[esp-idf-monitor]` 部分和 `[esptool]` 部分都使用 `custom_reset_sequence` 参数时，IDF 监视器会优先使用 `[esp-idf-monitor]` 部分的配置。`[esptool]` 部分中任何与之冲突的配置都将被忽略。

当配置分散在多个文件中时，此优先规则也适用。全局 `esp-idf-monitor` 配置将优先于本地 `esptool` 配置。

**配置 GDBStub 以启用 GDB** GDBStub 支持在运行时进行调试。GDBStub 在目标上运行，并通过串口连接到主机从而接收调试命令。GDBStub 支持读取内存和变量、检查调用堆栈帧等命令。虽然没有 JTAG 调试通用，但由于 GDBStub 完全通过串行端口完成通信，故不需要使用特殊硬件（如 JTAG/USB 桥接器）。

通过设置 `CONFIG_ESP_SYSTEM_GDBSTUB_RUNTIME`，可以将目标配置为在后台运行 GDBStub。GDBStub 将保持在后台运行，直到通过串行端口发送 `Ctrl+C` 导致应用程序中断（即停止程序执行），从而让 GDBStub 处理调试命令。

此外，还可以通过设置 `CONFIG_ESP_SYSTEM_PANIC` 为 GDBStub on panic 来配置 panic 处理程序，使其在发生 crash 事件时运行 GDBStub。当 crash 发生时，GDBStub 将通过串口输出特殊的字符串模式，表示 GDBStub 正在运行。

无论是通过发送 `Ctrl+C` 还是收到特殊字符串模式，IDF 监视器都会自动启动 GDB，从而让用户发送调试命令。GDB 退出后，通过 RTS 串口线复位目标。如果未连接 RTS 串口线，请按复位键，手动复位开发板。

**备注：** IDF 监视器在后台运行如下命令启用 GDB：

```
riscv32-esp-elf-gdb -ex "set serial baud BAUD" -ex "target remote PORT" -ex ↵
↳ interrupt build/PROJECT.elf :idf_target:`Hello NAME chip`
```

**输出筛选** 可以调用 `idf.py monitor --print-filter="xyz"` 启动 IDF 监视器，其中，`--print-filter` 是输出筛选的参数。参数默认值为空字符串，即打印所有内容。支持使用环境变量 `ESP_IDF_MONITOR_PRINT_FILTER` 调整筛选设置。

**备注：** 同时使用环境变量 `ESP_IDF_MONITOR_PRINT_FILTER` 和参数 `--print-filter` 时，通过命令行输入的 CLI 参数 `--print-filter` 优先级更高。

若需对打印内容设置限制，可指定 `<tag>:<log_level>` 等选项，其中 `<tag>` 是标签字符串，`<log_level>` 是 {N, E, W, I, D, V, \*} 集合中的一个字母，指的是日志级别。

例如，`--print_filter="tag1:W"` 只匹配并打印 `ESP_LOGW("tag1", ...)` 所写的输出，或者写在较低日志详细度级别的输出，即 `ESP_LOGE("tag1", ...)`。请勿指定 `<log_level>` 或使用详细级别默认值 `*`。

**备注：**编译时，可以使用主日志在日志库中禁用不需要的输出。也可以使用 IDF 监视器筛选输出来调整筛选设置，且无需重新编译应用程序。

应用程序标签不能包含空格、星号 `*`、冒号 `:`，以便兼容输出筛选功能。

如果应用程序输出的最后一行后面没有回车，可能会影响输出筛选功能，即，监视器开始打印该行，但后来发现该行不应该被写入。这是一个已知问题，可以通过添加回车来避免此问题（特别是在没有输出紧跟其后的情况下）。

### 筛选规则示例

- `*` 可用于匹配任何类型标签。但 `--print_filter="*:I tag1:E"` 打印关于 `tag1` 的输出时会报错，这是因为 `tag1` 规则比 `*` 规则的优先级高。
- 默认规则（空）等价于 `*:V`，因为在详细级别或更低级别匹配任意标签即意味匹配所有内容。
- `*:N` 不仅抑制了日志功能的输出，也抑制了 `printf` 的打印输出。为了避免这一问题，请使用 `*:E` 或更高的冗余级别。
- 规则 `"tag1:V"`、`"tag1:v"`、`"tag1:"`、`"tag1:*"` 和 `"tag1"` 等同。
- 规则 `"tag1:W tag1:E"` 等同于 `"tag1:E"`，这是因为后续出现的具有相同名称的标签会覆盖掉前一个标签。
- 规则 `"tag1:I tag2:W"` 仅在 Info 详细度级别或更低级别打印 `tag1`，在 Warning 详细度级别或更低级别打印 `tag2`。
- 规则 `"tag1:I tag2:W tag3:N"` 在本质上等同于上一规则，这是因为 `tag3:N` 指定 `tag3` 不打印。
- `tag3:N` 在规则 `"tag1:I tag2:W tag3:N *:V"` 中更有意义，这是因为如果没有 `tag3:N`，`tag3` 信息就可能打印出来了；`tag1` 和 `tag2` 错误信息会打印在指定的详细度级别（或更低级别），并默认打印所有内容。

**高级筛选规则示例** 如下日志是在没有设置任何筛选选项的情况下获得的：

```
load:0x40078000,len:13564
entry 0x40078d4c
E (31) esp_image: image at 0x30000 has invalid magic byte
W (31) esp_image: image at 0x30000 has invalid SPI mode 255
E (39) boot: Factory app partition is not bootable
I (568) cpu_start: Pro cpu up.
I (569) heap_init: Initializing. RAM available for dynamic allocation:
I (603) cpu_start: Pro cpu start user code
D (309) light_driver: [light_init, 74]:status: 1, mode: 2
D (318) vfs: esp_vfs_register_fd_range is successful for range <54; 64) and VFS ID_
↪1
I (328) wifi: wifi driver task: 3ffdbf84, prio:23, stack:4096, core=0
```

`--print_filter="wifi esp_image:E light_driver:I"` 筛选选项捕获的输出如下所示：

```
E (31) esp_image: image at 0x30000 has invalid magic byte
I (328) wifi: wifi driver task: 3ffdbf84, prio:23, stack:4096, core=0
```

`--print_filter="light_driver:D esp_image:N boot:N cpu_start:N vfs:N wifi:N *:V"` 选项的输出如下：

```
load:0x40078000,len:13564
entry 0x40078d4c
I (569) heap_init: Initializing. RAM available for dynamic allocation:
D (309) light_driver: [light_init, 74]:status: 1, mode: 2
```

## 配置文件

esp-idf-monitor 使用 **C0 控制字符** 与控制台进行交互。配置文件中的字符会被转换为对应的 C0 控制代码。可用字符包括英文字母 (A-Z) 和特殊符号: [、]、\、^、和 \_。

**警告:** 注意, 一些字符可能无法在所有平台通用, 或被保留作为其他用途的快捷键。请谨慎使用此功能。

**文件位置** 配置文件的默认名称为 esp-idf-monitor.cfg。首先, 在 esp-idf-monitor 路径中检测配置文件并运行。

如果此目录中没有检测到配置文件, 则检查当前用户操作系统的配置目录:

- Linux: /home/<user>/.config/esp-idf-monitor/
- MacOS /Users/<user>/.config/esp-idf-monitor/
- Windows: c:\Users\<user>\AppData\Local\esp-idf-monitor\

如仍未检测到配置文件, 会最后再检查主目录:

- Linux: /home/<user>/
- MacOS /Users/<user>/
- Windows: c:\Users\<user>\

在 Windows 中, 可以使用 HOME 或 USERPROFILE 环境变量设置主目录, 因此, Windows 配置目录的位置也取决于这些变量。

还可以使用 ESP\_IDF\_MONITOR\_CFGFILE 环境变量为配置文件指定一个不同的位置, 例如 ESP\_IDF\_MONITOR\_CFGFILE = ~/custom\_config.cfg。这一设置的检测优先级高于上述所有位置检测的优先级。

如果没有使用其他配置文件, esp-idf-monitor 会从其他常用的配置文件中读取设置。如果存在 setup.cfg 或 tox.ini 文件, esp-idf-monitor 会自动从这些文件中读取设置。

**配置选项** 下表列出了可用的配置选项:

选项名称	描述	默认值
menu_key	访问主菜单	T
exit_key	退出监视器	]
chip_reset_key	初始化芯片重置	R
recompile_upload_key	重新编译并上传	F
recompile_upload_app_key	仅重新编译并上传应用程序	A
toggle_output_key	切换输出显示	Y
toggle_log_key	切换日志功能	L
toggle_timestamp_key	切换时间戳显示	I
chip_reset_bootloader_key	将芯片重置为引导加载模式	P
exit_menu_key	从菜单中退出监视器	X
skip_menu_key	设置使用菜单命令时无需按下主菜单键	False
custom_reset_sequence	复位目标到引导加载程序的自定义复位序列	无默认值

**语法** 配置文件为.ini 文件格式，必须以 [esp-idf-monitor] 标头引入才能被识别为有效文件。以下语法以“配置名称 = 配置值”形式列出。以 # 或 ; 开头的行是注释，将被忽略。

```
# esp-idf-monitor.cfg file to configure internal settings of esp-idf-monitor
[esp-idf-monitor]
menu_key = T
exit_key = ]
chip_reset_key = R
recompile_upload_key = F
recompile_upload_app_key = A
toggle_output_key = Y
toggle_log_key = L
toggle_timestamp_key = I
chip_reset_bootloader_key = P
exit_menu_key = X
skip_menu_key = False
```

## IDF 监视器已知问题

如果在使用 IDF 监视器过程中遇到任何问题，请查看我们的 [GitHub 仓库](#) 以获取已知问题列表及其当前状态。如果遇到的问题没有相关记录，请创建一个新的问题报告。

### 4.26.3 IDF Docker 镜像

IDF Docker 镜像 (espressif/idf) 为使用特定版本的 ESP-IDF 自动化构建应用程序和库而设计。

该镜像包含以下内容：

- 常见的实用工具，如 git、wget、curl 和 zip。
- Python 3.8 或更高版本。
- 特定版本 ESP-IDF 的副本。有关版本信息，请参阅下文。该副本中设置了 IDF\_PATH 环境变量，并指向容器中 ESP-IDF 的位置。
- 构建特定版本 ESP-IDF 所需工具：CMake、Ninja、交叉编译器工具链等。
- ESP-IDF 需要的所有 Python 软件包。这些软件包均已安装在虚拟环境中。

镜像 ENTRYPOINT 会设置 PATH 环境变量，指向正确版本的工具，并激活 Python 虚拟环境。此时，环境已经准备好，可以使用 ESP-IDF 构建系统。

如需使用其他工具，可用该镜像作为基础自定义镜像。

## 标签

该镜像维护了以下多个标签：

- latest：跟踪 ESP-IDF 的 master 分支
- vX.Y：对应 ESP-IDF 的版本 vX.Y
- release-vX.Y：跟踪 ESP-IDF 的 release/vX.Y 分支

---

**备注：**在引入镜像功能前发布的 ESP-IDF 版本没有对应的 Docker 镜像版本。要查找最新可用标签列表，请参阅 <https://hub.docker.com/r/espressif/idf/tags>。

---

## 使用 Docker

**设置 Docker** 在本地使用 espressif/idf Docker 镜像前，请确保已安装 Docker。如果本地未安装 Docker，请按 <https://docs.docker.com/install/> 提供的说明完成安装。

如果在 CI 环境中使用该镜像，请参阅 CI 服务说明文档，了解如何指定用于构建的镜像。

**使用 CMake 构建项目** 在项目目录下，运行以下命令：

```
docker run --rm -v $PWD:/project -w /project -u $UID -e HOME=/tmp espressif/idf_
→idf.py build
```

该命令具体内容如下：

- `docker run`：运行 Docker 镜像。此为 `docker container run` 命令的缩写形式。
- `--rm`：构建完成后删除相应容器。
- `-v $PWD:/project`：将主机当前目录 (`$PWD`) 挂载为容器中的 `/project` 目录。
- `-w /project`：使 `/project` 成为当前命令的工作目录。
- `-u $UID`：以当前用户的 ID 运行命令，使文件以当前用户而非 `root` 用户的身份创建。
- `-e HOME=/tmp`：为用户提供一个主目录，用于将 `idf.py` 创建的临时文件保存在 `~/.cache` 中。
- `espressif/idf`：使用标签为 `latest` 的 Docker 镜像 `espressif/idf`。未指定标签时，Docker 会隐式添加 `latest` 标签。
- `idf.py build`：在容器内运行此命令。

**备注：** 如果挂载目录 `/project` 包含的 `git` 仓库的用户 (UID) 不同于运行 Docker 容器的用户，在 `/project` 中执行 `git` 命令可能会失败，并显示错误信息 `fatal: detected dubious ownership in repository at '/project'`。如需解决此问题，可以在启动 Docker 容器时设置 `IDF_GIT_SAFE_DIR` 环境变量，将 `/project` 目录指定为安全目录。例如，可以将 `-e IDF_GIT_SAFE_DIR='/project'` 作为参数包含，还可以使用分隔符：指定多个目录，或使用 `*` 完全禁用此项 `git` 安全检查。

要以特定 Docker 镜像标签进行构建，请将其指定为 `espressif/idf:TAG`，示例如下：

```
docker run --rm -v $PWD:/project -w /project -u $UID -e HOME=/tmp espressif/
→idf:release-v4.4 idf.py build
```

要查看最新可用标签列表，请参阅 <https://hub.docker.com/r/espressif/idf/tags>。

**交互使用镜像** Docker 也支持以交互方式进行构建，以调试构建问题或测试自动构建脚本。请使用 `-i -t` 标志启动容器，示例如下：

```
docker run --rm -v $PWD:/project -w /project -u $UID -e HOME=/tmp -it espressif/idf
```

接着在容器内部照常使用 `idf.py`：

```
idf.py menuconfig
idf.py build
```

**备注：** 若未将串行接口传递到容器中，则 `idf.py flash` 和 `idf.py monitor` 等与开发板通信的命令在容器中无法正常工作。对于 Linux 系统，可以使用 [设备选项](#) 将串行接口传递到容器中。然而，目前 Windows 系统 (<https://github.com/docker/for-win/issues/1018>) 和 Mac 系统 (<https://github.com/docker/for-mac/issues/900>) 中 Docker 不支持此功能。可以使用 [远程串行接口](#) 克服此限制。有关如何执行此操作，请参阅 [以下使用远程串行接口](#) 章节。

**备注：** 对于 Linux 系统，如果使用 `--device` 或 `--privileged` 等选项将主机的串行接口设备添加到容器，并使用 `-u $UID` 以特定用户启动容器时，请确保此用户对设备具有读/写访问权限。使用 `--group-add` 选项可以将容器用户添加到分配给主机设备的组 ID 中。例如，如果主机设备被分配到 `dialout` 组，你可以使用 `--group-add $(getent group dialout | cut -d':' -f3)` 将容器用户添加到主机的 `dialout` 组。



**使用远程串行接口** RFC2217 (Telnet) 协议可用于远程连接到串行接口，详情请参阅 ESP 工具项目的 [远程串行接口](#) 文档。如果无法直接访问 Docker 容器内的串行接口，也可使用该协议进行访问。以下示例展示了如何从 Docker 容器内部使用烧写命令。

在主机上安装并启动 `esp_rfc2217_server`：

- 在 Windows 系统中，该软件包以一个文件的形式提供，这个文件是由 `pyinstaller` 创建的可执行文件，可以从 [ESP 工具版本](#) 页面以 ZIP 压缩文件的形式与其他 ESP 工具一起下载：

```
esp_rfc2217_server -v -p 4000 COM3
```

- 在 Linux 或 macOS 系统中，该软件包是 `esptool` 的组成部分，可以在 ESP-IDF 环境中找到，或使用以下 `pip` 命令安装：

```
pip install esptool
```

随后执行以下命令启动服务器：

```
esp_rfc2217_server.py -v -p 4000 /dev/ttyUSB0
```

此时，便可使用以下命令，从 Docker 容器内部烧写连接到主机的设备：

```
docker run --rm -v <host_path>:<container_path> -w /<container_path> espressif/
↳idf idf.py --port 'rfc2217://host.docker.internal:4000?ign_set_control' flash
```

请确保将 `<host_path>` 正确设置为主机上的项目路径，并使用 `-w` 选项将 `<container_path>` 设置为容器内的工作目录。`host.docker.internal` 为特殊的 Docker DNS 名称，用于访问主机。如有需要，可以将其替换为主机的 IP 地址。

## 构建自定义镜像

ESP-IDF 库中的 Docker 文件提供了以下构建参数，可用于构建自定义 Docker 镜像：

- `IDF_CLONE_URL`：克隆 ESP-IDF 存储库的 URL。在使用 ESP-IDF 分支时，可以将该参数设置为自定义 URL，默认值为 `https://github.com/espressif/esp-idf.git`。
- `IDF_CLONE_BRANCH_OR_TAG`：克隆 ESP-IDF 时使用的 git 分支或标签的名称。该参数将作为 `git clone` 命令的 `--branch` 参数传递，默认值为 `master`。
- `IDF_CHECKOUT_REF`：如果将此参数设置为非空值，在克隆之后会执行 `git checkout $IDF_CHECKOUT_REF` 命令。可以将此参数设置为特定 commit 的 SHA 值，以便切换到所需的版本分支或 commit。例如，在希望使用特定版本分支上的某个 commit 时，就可以将此参数设置为该 commit 的 SHA 值。
- `IDF_CLONE_SHALLOW`：如果将此参数设置为非空值，则会在执行 `git clone` 时使用 `--depth=1 --shallow-submodules` 参数。浅克隆的深度可以使用 `IDF_CLONE_SHALLOW_DEPTH` 设置。浅克隆可以极大减少下载的数据量及生成的 Docker 镜像大小。然而，如果需要切换到此类“浅层”存储库中的其他分支，必须先执行额外的 `git fetch origin <branch>` 命令。
- `IDF_CLONE_SHALLOW_DEPTH`：此参数指定进行浅克隆时要使用的深度值。如未设置，将使用 `--depth=1`。此参数仅在使用 `IDF_CLONE_SHALLOW` 时有效。如果要为分支构建 Docker 镜像，并且该镜像必须包含该分支上的最新标签，则需使用此参数。要确定所需的深度，请在特定的分支运行 `git describe` 命令，并注意偏移值。将偏移值加 1 后即可将其用作 `IDF_CLONE_SHALLOW_DEPTH` 参数的值。此过程将确保生成的镜像包含分支上的最新标签，且 Docker 镜像内部的 `git describe` 命令也会按预期工作。
- `IDF_INSTALL_TARGETS`：以逗号分隔的 ESP-IDF 目标列表，用于安装工具链，或者使用 `all` 安装所有目标的工具链。选择特定目标可以减少下载的数据量和生成的 Docker 镜像的大小。该参数默认值为 `all`。

要使用以上参数，请通过 `--build-arg` 命令行选项传递。例如，以下命令使用 ESP-IDF v4.4.1 的浅克隆以及仅适用于 ESP32-C3 的工具链构建了 Docker 镜像：

```
docker build -t idf-custom:v4.4.1-esp32c3 \
  --build-arg IDF_CLONE_BRANCH_OR_TAG=v4.4.1 \
```

(下一页继续)

```
--build-arg IDF_CLONE_SHALLOW=1 \
--build-arg IDF_INSTALL_TARGETS=esp32c3 \
tools/docker
```

## 4.26.4 IDF Windows 安装程序

### 命令行参数

IDF Windows 安装程序 `esp-idf-tools-setup` 提供以下命令行参数：

- `/CONFIG=[PATH]` - 指定 ini 配置文件的路径，覆盖安装程序的默认配置。默认值：`config.ini`。
- `/GITCLEAN=[yes|no]` - 在以离线模式安装时，执行 `git clean` 命令，并删除未跟踪的目录。默认值：`yes`。
- `/GITRECURSIVE=[yes|no]` - 递归克隆所有 Git 仓库子模块。默认值：`yes`。
- `/GITREPO=[URL|PATH]` - 指定克隆 ESP-IDF 仓库的 URL。默认值：`https://github.com/espressif/esp-idf.git`。
- `/GITRESET=[yes|no]` - 在安装过程中，启用或禁用对仓库的 `git reset` 操作。默认值：`yes`。
- `/HELP` - 显示 Inno Setup 安装程序提供的命令行选项。
- `/IDFDIR=[PATH]` - 指定安装目录的路径。默认值：`{userdesktop}\esp-idf`。
- `/IDFVERSION=[v4.3|v4.1|master]` - 使用指定的 ESP-IDF 版本，如 `v4.1`、`v4.2`、`master`。默认值：`empty`，选取列表中的第一个版本。
- `/IDFVERSIONSURL=[URL]` - 使用 URL 下载 ESP-IDF 版本列表。默认值：`https://dl.espressif.com/dl/esp-idf/idf_versions.txt`。
- `/LOG=[PATH]` - 在指定目录中存储安装日志文件。默认值：`empty`。
- `/OFFLINE=[yes|no]` - 在离线模式下，使用 `pip` 执行。通过设置环境变量 `PIP_NO_INDEX`，也可在离线模式下安装 Python 软件包。默认值：`no`。
- `/USEEMBEDDEDPYTHON=[yes|no]` - 使用嵌入式 Python 版本完成安装。将此参数设置为 `no`，可以在安装程序中选择 Python 版本。默认值：`yes`。
- `/PYTHONNOUSERSITE=[yes|no]` - 在启动任意 Python 命令前，设置 `PYTHONNOUSERSITE` 变量，避免从 `AppDataRoaming` 加载 Python 软件包。默认值：`yes`。
- `/PYTHONWHEELSURL=[URL]` - 指定 PyPi 存储库的 URL，以解析二进制 Python Wheel 依赖关系。设置环境变量 `PIP_EXTRA_INDEX_URL` 可以实现相同效果。默认值：`https://dl.espressif.com/pypi`。
- `/SKIPSYSTEMCHECK=[yes|no]` - 跳过系统检查页面。默认值：`no`。
- `/VERYSILENT /SUPPRESSMSGBOXES /SP- /NOCANCEL` - 执行静默安装。

### 静默安装

通过设置以下命令行参数，可以静默安装 ESP-IDF：

```
esp-idf-tools-setup-x.x.exe /VERYSILENT /SUPPRESSMSGBOXES /SP- /NOCANCEL
```

在命令行中运行安装程序时，它会在后台启动一个独立的进程执行安装操作，而不会阻塞命令行的使用。通过以下 PowerShell 脚本可以等待安装程序完成：

```
esp-idf-tools-setup-x.x.exe /VERYSILENT /SUPPRESSMSGBOXES /SP- /NOCANCEL
$InstallerProcess = Get-Process esp-idf-tools-setup
Wait-Process -Id $InstallerProcess.id
```

### 自定义 Python 版本及 Python Wheel 位置

IDF 安装程序默认使用嵌入的 Python 版本，并参考预定义的 Python Wheel 镜像获取所需软件包。

以下参数支持自定义 Python 版本及 Python Wheel 位置：

```
esp-idf-tools-setup-x.x.exe /USEEMBEDDEDPYTHON=no /PYTHONWHEELSURL=https://pypi.org/simple/
```

### 4.26.5 IDF 组件管理器

IDF 组件管理器工具用于下载 ESP-IDF CMake 项目的依赖项，该下载在 CMake 运行期间自动完成。IDF 组件管理器可以从 [组件注册表](#) 或 Git 仓库获取组件。

要获取组件列表，请参阅 <https://components.espressif.com/>。

有关 IDF 组件管理器的详细信息，请参阅 [IDF 组件管理器及 ESP 组件注册表文档](#)。

#### 在项目中使用 IDF 组件管理器

项目中各组件的依赖项定义在单独的清单文件中，命名为 `idf_component.yml`，位于组件根目录。运行 `idf.py create-manifest` 可以为组件创建清单文件模板。默认情况下将为 `main` 组件创建清单文件。使用 `--path` 选项，可以显式指定创建清单文件的目录路径。使用 `--component=my_component` 选项可以指定组件名称，这样系统将会在 `components` 文件夹下为该组件创建清单文件。`create-manifest` 命令支持以下运行方式：

- `idf.py create-manifest` 为 `main` 组件创建清单文件
- `idf.py create-manifest --component=my_component` 在 `components` 目录下，为组件 `my_component` 创建清单文件
- `idf.py create-manifest --path="../../my_component"` 在 `my_component` 目录下，为组件 `my_component` 创建清单文件

在向项目的某个组件添加新的清单时，必须先运行 `idf.py reconfigure`，手动重新配置项目。随后，构建过程将跟踪 `idf_component.yml` 清单的变更，并在必要时自动触发 CMake。

要为 ESP-IDF 项目中的组件（如 `my_component`）添加依赖项，可以运行命令 `idf.py add-dependency DEPENDENCY`。DEPENDENCY 参数代表一个由 IDF 组件管理器管理的额外组件，而 `my_component` 也依赖于这个组件。DEPENDENCY 参数的格式为 `namespace/name=1.0.0`，`namespace/name` 代表组件名称，`=1.0.0` 是组件的版本范围，详情请参阅 [版本文档](#)。默认情况下，依赖项会添加到 `main` 组件。通过使用 `--path` 选项，可以显式指定包含清单的目录，也可以使用 `--component=my_component`，在 `components` 文件夹中指定组件。`add-dependency` 命令支持以下运行方式：

- `idf.py add-dependency example/cmp` 为 `main` 组件添加依赖项，依赖项为 `example/cmp` 的最新版本
- `idf.py add-dependency --component=my_component example/cmp<=3.3.3` 将依赖项添加到位于 `components` 目录下名为 `my_component` 的组件中，依赖项为版本号 `<=3.3.3` 的 `example/cmp`
- `idf.py add-dependency --path="../../my_component" example/cmp^3.3.3` 将依赖项添加到位于目录 `my_component` 下名为 `my_component` 的组件中，依赖项为版本号 `^3.3.3` 的 `example/cmp`

**备注：** `add-dependency` 命令会从 [乐鑫组件注册表](#) 将依赖项显式添加到你的项目中。

要更新 ESP-IDF 项目的依赖项，请运行命令 `idf.py update-dependencies`。你也可以使用 `--project-dir PATH` 选项，指定项目目录的路径。

应用程序示例 [build\\_system/cmake/component\\_manager](#) 使用了由组件管理器安装的组件。

对于不需要受管理依赖项的组件，则无需提供清单文件。

在 CMake 配置项目（如 `idf.py reconfigure`）时，组件管理器会执行以下操作：



- 处理项目中每个组件的 `idf_component.yml` 清单，并递归解析依赖项。
- 在项目根目录中创建 `dependencies.lock` 文件，包含完整的依赖项列表。
- 将所有依赖项下载至 `managed_components` 目录。

请勿更改 `dependencies.lock` 锁文件和 `managed_components` 目录的内容。组件管理器运行时，会始终确保这些文件处于最新状态。如果意外修改了这些文件，可以通过使用 `idf.py reconfigure` 触发 CMake，重新运行组件管理器。

设置构建属性 `DEPENDENCIES_LOCK` 可以指定顶层 `CMakeLists.txt` 文件中的锁文件路径。例如，在 `project(PROJECT_NAME)` 前添加 `idf_build_set_property(DEPENDENCIES_LOCK dependencies.lock.${IDF_TARGET})`，可以为不同目标生成不同锁文件。

## 从示例创建项目

组件注册表中，部分组件包含示例项目。要从示例创建一个新项目，可以运行命令 `idf.py create-project-from-example EXAMPLE`。EXAMPLE 参数格式为 `namespace/name=1.0.0:example`，`namespace/name` 代表组件名称，`=1.0.0` 是组件的版本范围（详情请参阅 [版本文档](#)），而 `example` 代表示例名称。在 [乐鑫组件注册表](#) 中，可以找到各组件的示例列表，以及启动组件示例的相应命令。

## 在清单文件中定义依赖项

通过在文本编辑器直接编辑，你可以轻松定义清单文件 `idf_component.yml` 中的依赖项。以下是有关定义依赖项的简单示例：

你可以通过指定组件名称和版本范围，定义来自注册表的依赖项：

```
dependencies:
# 定义来自注册表 (https://components.espressif.com/component/example/cmp)
→ 的依赖项
example/cmp: ">=1.0.0"
```

要从 Git 仓库定义依赖关系，请提供组件在仓库中的路径和仓库的 URL：

```
dependencies:
# 从 Git 仓库定义依赖项
test_component:
  path: test_component
  git: ssh://git@gitlab.com/user/components.git
```

在开发组件时，可以通过指定相对或绝对路径，使用本地目录中的组件：

```
dependencies:
# 通过相对路径定义本地依赖项
some_local_component:
  path: ../../projects/component
```

有关清单文件格式的详细信息，请参阅 [清单文件格式文档](#)。

## 禁用组件管理器

将环境变量 `IDF_COMPONENT_MANAGER` 设置为 0，可以显式禁用组件管理器。

### 4.26.6 IDF clang-tidy

IDF clang-tidy 是使用 [clang-tidy](#) 对当前应用程序进行静态分析的工具。

**警告：** IDF clang-tidy 的功能及其依赖的工具链尚在开发中，最终版本发布前可能有重大变更。

目前仅支持基于 clang 的工具链。在配置项目前，必须在环境变量或 CMake 缓存中设置 `IDF_TOOLCHAIN=clang` 进行激活。

**警告：** 当前工具尚不支持基于 RISC-V 的芯片。目前，乐鑫尚未针对 RISC-V 提供基于 clang 的工具链。

## 准备工作

初次运行此工具时，请按照以下步骤准备该工具：

1. 运行 `idf_tools.py install esp-clang` 安装 clang-tidy 所需的二进制文件。

**备注：** 该工具链尚在开发中，最终版本发布后，将无需手动安装工具链。

2. 再次运行导出脚本（如 `export.sh`、`export.bat` 等），刷新环境变量。

## 其他命令

**clang-check** 运行 `idf.py clang-check` 可以重新生成编译数据库，并在当前项目文件夹下运行 clang-tidy，所得输出写入 `<project_dir>/warnings.txt`。

运行 `idf.py clang-check --help` 查看完整文档。

## clang-html-report

1. 运行 `pip install codereport` 安装附加依赖关系。
2. 运行 `idf.py clang-html-report` 会根据 `warnings.txt` 在 `<project_dir>/html_report` 文件夹内生成 HTML 报告。请在浏览器中打开 `<project_dir>/html_report/index.html` 查看报告。

## 错误报告

此工具托管在 [espressif/clang-tidy-runner](https://github.com/espressif/clang-tidy-runner)。如遇到任何错误，或有任何功能请求，请通过 [Github issues](https://github.com/espressif/clang-tidy-runner/issues) 提交报告。

## 4.26.7 可下载的 ESP-IDF 工具

构建过程中，ESP-IDF 依赖许多工具，如交叉编译工具链、CMake 构建系统等。

如[快速入门](#)所述，若所需工具版本可用，首选使用当前操作系统的软件包管理器（如 `apt`、`yum`、`brew` 等）安装相关工具。例如，在 Linux 和 macOS 系统中，建议用 Linux 和 macOS 系统的软件包管理器安装 CMake。

但部分 ESP-IDF 的特定工具在操作系统软件包存储库中不可用，且不同版本的 ESP-IDF 需相应使用不同版本的工具运行。为解决以上两个问题，ESP-IDF 提供了一组脚本，可以下载和安装正确的工具版本，并设置相应运行环境。

下文中，这类可下载的工具简称为“工具”。除此类工具外，ESP-IDF 还使用以下工具：

- ESP-IDF 捆绑的 Python 脚本，如 `idf.py`
- 从 PyPI 安装的 Python 软件包

以下各小节介绍了可下载工具的安装方法，并提供了在不同平台上安装的工具列表。

---

**备注：** 本文档面向需要自定义其安装过程的高级用户、希望了解安装过程的用户以及 ESP-IDF 开发人员。要了解如何安装 ESP-IDF 工具，请参阅[快速入门](#)。

---

## 工具元数据文件

各平台所需工具及工具版本列表存放在 `tools/tools.json` 文件中，`tools/tools_schema.json` 定义了该文件的模式。

在安装工具或设置环境变量时，`tools/idf_tools.py` 脚本将使用上述文件。

## 工具安装目录

IDF\_TOOLS\_PATH 环境变量指定下载及安装工具的位置。若未设置该变量，Linux 和 macOS 系统的默认下载安装位置为 `HOME/.espressif`，Windows 系统的默认下载安装位置为 `%USER_PROFILE%\espressif`。

在 IDF\_TOOLS\_PATH 目录下，工具安装脚本会创建以下子目录和文件：

- `dist` — 工具存档下载位置。
- `tools` — 工具解压缩位置。工具会解压缩到子目录 `tools/TOOL_NAME/VERSION/` 中，该操作支持同时安装不同版本的工具。
- `idf-env.json` — “目标 (target)” 和 “功能 (feature)” 等用户安装选项均存储在此文件中。“目标”为选择需要安装和保持更新的工具的芯片目标；“功能”则决定应安装哪些 Python 软件包。有关用户安装选项的详情，请参阅下文。
- `python_env` — 与工具无关；虚拟 Python 环境安装在其子目录中。注意，设置 IDF\_PYTHON\_ENV\_PATH 环境变量可以将 Python 环境目录放置到其他位置。
- `espidf.constraints.*.txt` — 每个 ESP-IDF 版本都有的约束文件，包含 Python 包版本要求。

## GitHub 资源镜像

工具下载器下载的工具大多属于 GitHub 发布的资源，即在 GitHub 上伴随软件发布的文件。

如果无法访问 GitHub 下载或访问速度较慢，可以配置一个 GitHub 资源镜像。

要使用乐鑫下载服务器，请将环境变量 IDF\_GITHUB\_ASSETS 设置为 `dl.espressif.com/github_assets`，在国内下载时，也可设置为 `dl.espressif.cn/github_assets` 加快下载速度。安装过程中，当从 `github.com` 下载工具时，URL 将重写为使用乐鑫下载服务器。

只要 URL 与 `github.com` 的下载 URL 格式匹配，任何镜像服务器均可使用，安装过程中下载的 GitHub 资源 URL 将把 `https://github.com` 替换为 `https://{IDF_GITHUB_ASSETS}`。

---

**备注：** 目前，乐鑫下载服务器不会镜像 GitHub 上的所有内容，只镜像部分发布版本的附件资源文件及源文件。

---

## idf\_tools.py 脚本

ESP-IDF 随附的 `tools/idf_tools.py` 脚本具备以下功能：

- `install`：将工具下载到 `${IDF_TOOLS_PATH}/dist` 目录，并解压缩到 `${IDF_TOOLS_PATH}/tools/TOOL_NAME/VERSION`。  
`install` 命令接收 `TOOL_NAME` 或 `TOOL_NAME@VERSION` 格式的安装工具列表。如果给定参数 `all`，则会安装列表上的所有工具，包括必须项和可选项。如果没有给定参数，或给定参数为 `required`，则只安装必须项。

- `download`: 与 `install` 类似, 但不会解压缩工具。使用可选项 `--platform` 可下载特定平台的工具。
- `export`: 列出使用已安装工具前应设置的环境变量。对多数工具而言, 只需要设置环境变量 `PATH`, 但也有些工具需要设置额外的环境变量。

环境变量可以以 `shell` 或 `key-value` 格式列出, 使用 `--format` 参数设置该选项。

- `export` 可选参数:

- \* `--unset`: 该参数可用于创建语句, 取消特定全局变量设置, 使环境恢复到调用 `export` 前状态。
- \* `--add_paths_extras`: 该参数将 `$PATH` 中与 `ESP-IDF` 相关的额外路径添加到 `${IDF_TOOLS_PATH}/esp-idf.json` 中, 以保证在退出当前 `ESP-IDF` 环境时删除全局变量。例如, 在运行 `export.{sh/fish}` 脚本时, 如果在全局变量 `$PATH` 中添加了新的路径, 在命令中添加该参数可以将这些新路径保存到 `${IDF_TOOLS_PATH}/esp-idf.json` 文件中。

- `shell`: 生成适合在 `shell` 中执行的输出, 例如, 在 `Linux` 和 `macOS` 上生成以下输出

```
export PATH="/home/user/.espressif/tools/tool/v1.0.0/bin:$PATH"
```

在 `Windows` 上生成以下输出

```
set "PATH=C:\Users\user\.espressif\tools\v1.0.0\bin;%PATH%"
```

**备注:** 当前不支持以 `Powershell` 格式导出环境变量, 可以用 `key-value` 格式代替。

如果 `shell` 支持, 则该命令的输出可用于更新环境变量。例如

```
eval $(${IDF_PATH}/tools/idf_tools.py export)
```

- `key-value`: 以 `VARIABLE=VALUE` 格式生成输出, 以便其他脚本解析

```
PATH=/home/user/.espressif/tools/tool/v1.0.0:$PATH
```

注意, 用于处理此输出的脚本必须对输出中的 `$VAR` 或 `%VAR%` 模式进行扩展, 即解析成对应变量。

- `list`: 列出已知的工具版本, 并指示哪些版本已安装。以下选项可用于自定义输出。
  - `--outdated`: 仅列出安装在 `IDF_TOOLS_PATH` 中的过时版本工具。
- `check`: 检查每个工具是否在系统路径和 `IDF_TOOLS_PATH` 中可用。
- `install-python-env`: 在 `${IDF_TOOLS_PATH}/python_env` 目录或直接在 `IDF_PYTHON_ENV_PATH` 环境变量设置的目录中创建 `Python` 虚拟环境, 并在其中安装所需的 `Python` 软件包。
  - 参数 `--features` 为可选项, 用于指定要添加或删除的功能列表, 功能之间用逗号分隔。
    1. 该参数将删除以 `-` 开头的功能, 添加以 `+` 开头或无符号标记的功能。例如, 要删除功能 `XY`, 示例语法为 `--features=-XY`; 要添加功能 `XY`, 示例语法为 `--features=+XY` 或 `--features=XY`。如果为同一功能同时提供了删除和添加选项, 则不执行任何操作。
    2. 每个功能都必须有依赖文件。例如, 只有当 `${IDF_PATH}/tools/requirements/requirements.XY.txt` 文件已存在, 并包含要安装的 `Python` 包列表时, 功能 `XY` 才有效。
    3. `core` 功能为必须项, 确保 `ESP-IDF` 的核心功能, 如控制台中的构建、烧录、监视器、调试等。
    4. 用户可选择任意数量的可选功能, 已选功能列表存储在 `idf-env.json` 中。
    5. 依赖文件中存储了需要安装的 `Python` 包以及 `espidf.constraints.*.txt` 文件, 该约束文件从 <https://dl.espressif.com> 下载, 并存储在 `${IDF_TOOLS_PATH}` 目录, 包含了针对特定 `ESP-IDF` 版本的安装包版本要求。

**备注:** 可以通过使用 `--no-constraints` 参数或将环境变量 `IDF_PYTHON_CHECK_CONSTRAINTS` 设置为 `no`, 禁用约束文件的下载和使用, 但**不建议**此做法。

- `check-python-dependencies`: 检查所有必需的 `Python` 包是否均已安装。该命令会对比检查由 `idf-env.json` 功能列表从 `${IDF_PATH}/tools/requirements/requirements.*`

txt 所选择的软件包与 `espidf.constraints.*.txt` 文件指定的软件包版本是否一致。

---

**备注：**约束文件可通过 `install-python-env` 命令下载。与 `install-python-env` 命令类似，可以通过使用 `--no-constraints` 参数或将环境变量 `IDF_PYTHON_CHECK_CONSTRAINTS` 设置为 `no`，禁止使用约束文件。

---

- `uninstall`：打印并删除当前 ESP-IDF 版本未使用的工具。
  - `--dry-run` 打印已安装但未使用的工具。
  - `--remove-archives` 删除过去下载的所有旧版本软件安装包。

## 安装脚本

ESP-IDF 的根目录中提供了针对不同 shell 的用户安装脚本，包括：

- `install.bat` 适用于 Windows 命令提示符
- `install.ps1` 适用于 Powershell
- `install.sh` 适用于 Bash
- `install.fish` 适用于 Fish

这些脚本除了下载和安装 `IDF_TOOLS_PATH` 中的工具外，还会准备一个 Python 虚拟环境，并在此虚拟环境中安装所需软件包。

为启用相应功能，这些脚本可以选择性地接受一组以逗号分隔的芯片目标列表及 `--enable-*` 参数，这类参数会传递给 `idf_tools.py` 脚本，并由该脚本将这类参数存储在 `idf-env.json` 中，从而逐步启用芯片目标及功能。

要为所有芯片目标安装工具，请在不使用任何可选参数的情况下，运行 `idf_tools.py install --targets=all`。要安装具备 ESP-IDF 核心功能的 Python 软件包，请运行 `idf_tools.py install-python-env --features=core`。

也可为特定芯片安装工具，例如，运行 `install.sh esp32` 可以只为 ESP32 安装工具。更多相关示例，请参阅 [第三步：设置工具](#)。

运行 `idf_tools.py install-python-env --features=core,XY, install.sh --enable-XY` 可以启用 XY 功能。

## 导出脚本

由于安装好的工具并非永久添加到用户或系统的 `PATH` 环境变量中，因此，要在命令行中使用这些工具，还需要额外步骤。以下脚本会修改当前 shell 的环境变量，从而使用正确版本的工具：

- `export.bat` 适用于 Windows 命令提示符
- `export.ps1` 适用于 Powershell
- `export.sh` 适用于 Bash
- `export.fish` 适用于 Fish

---

**备注：**在 Bash 中修改 shell 环境时，必须使用 `./export.sh` 命令加载 `export.sh`，注意添加前面的点和空格。

`export.sh` 可以在除了 Bash 外的其他 shell（如 zsh）中使用。但在这种情况下，必须在运行脚本前设置 `IDF_PATH` 环境变量。在 Bash 中使用时，脚本会从当前目录猜测 `IDF_PATH` 的值。

---

除了调用 `idf_tools.py`，这些脚本还会列出已经添加到 `PATH` 的目录。

## 其他安装方法

为适用于不同环境，ESP-IDF 提供了更多用户友好的 `idf_tools.py` 包装工具：

- [ESP-IDF 工具安装器](#) 支持下载和安装工具，其内部使用 `idf_tools.py` 实现功能。

- **ESP-IDF Eclipse 插件** 包括了一个用于设置工具的菜单项，该插件内部调用 `idf_tools.py`。
- **VSCode ESP-IDF 扩展** 提供了设置工具的入门流程。尽管此扩展包不依赖 `idf_tools.py`，但安装方法相同。

### 自定义安装

推荐用户使用上述方法安装 ESP-IDF 工具，但也可以选择其他方式来构建 ESP-IDF 应用程序。自定义安装时，用户需将所有必要的工具都安装在某个位置，并在 `PATH` 中定义，以保证 ESP-IDF 构建系统可用。

### 卸载 ESP-IDF

卸载 ESP-IDF 需要删除安装过程中配置的工具和环境变量。

- 使用 **Windows ESP-IDF 工具安装器** 的 Windows 用户可以直接运行卸载向导卸载 ESP-IDF。
- **工具安装目录** 下包含了已下载及安装的工具，删除该目录即可删除此前通过运行 **安装脚本** 安装的内容。通过 **导出脚本** 设置的环境变量不具备永久性，新环境中不会存在此类环境变量。
- 如在安装过程中进行了自定义设置，除删除上述工具外，可能还涉及手动恢复此前为适用 ESP-IDF 工具而修改的环境变量及系统路径，例如 `IDF_PYTHON_ENV_PATH` 或 `IDF_TOOLS_PATH`。如存在通过手动复制安装的工具，则也需手动追踪并删除相关文件。
- 如安装了 **ESP-IDF Eclipse** 或 **VSCode ESP-IDF 扩展程序** 等插件，则需按照对应插件文档中的特定卸载说明进行操作。

---

**备注：** 卸载 ESP-IDF 工具不会删除任何项目文件或用户代码。为防止意外丢失其他文件，请在删除文件时谨慎操作。如果对某个步骤的操作有所疑问，请参考前述安装说明。

上述卸载指南默认需卸载的工具是按本文档中的步骤进行安装的。如果使用了自定义安装，可能需要进行相应调整。

---

### ESP-IDF 工具列表

**xtensa-esp-elf-gdb** GDB for Xtensa

License: [GPL-3.0-or-later](#)

More info: <https://github.com/espressif/binutils-gdb>



Platform	Required	Download
linux-amd64	required	<a href="https://github.com/espressif/binutils-gdb/releases/download/esp-gdb-v14.2_20240403/xtensa-esp-elf-gdb-14.2_20240403-x86_64-linux-gnu.tar.gz">https://github.com/espressif/binutils-gdb/releases/download/esp-gdb-v14.2_20240403/xtensa-esp-elf-gdb-14.2_20240403-x86_64-linux-gnu.tar.gz</a> SHA256: 9d68472d4cba5cf8c2b79d94f86f92c828e76a632bd1e6be5e7706e5b304d36e
linux-arm64	required	<a href="https://github.com/espressif/binutils-gdb/releases/download/esp-gdb-v14.2_20240403/xtensa-esp-elf-gdb-14.2_20240403-aarch64-linux-gnu.tar.gz">https://github.com/espressif/binutils-gdb/releases/download/esp-gdb-v14.2_20240403/xtensa-esp-elf-gdb-14.2_20240403-aarch64-linux-gnu.tar.gz</a> SHA256: bdabc3217994815fc311c4e16e588b78f6596b5ad4ffa46c80b40e982cfb1e66
linux-armel	required	<a href="https://github.com/espressif/binutils-gdb/releases/download/esp-gdb-v14.2_20240403/xtensa-esp-elf-gdb-14.2_20240403-arm-linux-gnueabi.tar.gz">https://github.com/espressif/binutils-gdb/releases/download/esp-gdb-v14.2_20240403/xtensa-esp-elf-gdb-14.2_20240403-arm-linux-gnueabi.tar.gz</a> SHA256: d54b8d703ba897b28c627da3d27106a3906dd01ba298778a67064710bc33c76d
linux-armhf	required	<a href="https://github.com/espressif/binutils-gdb/releases/download/esp-gdb-v14.2_20240403/xtensa-esp-elf-gdb-14.2_20240403-arm-linux-gnueabihf.tar.gz">https://github.com/espressif/binutils-gdb/releases/download/esp-gdb-v14.2_20240403/xtensa-esp-elf-gdb-14.2_20240403-arm-linux-gnueabihf.tar.gz</a> SHA256: 6187d1dd54e57927f7a7b804ff431fe0a295d5d5638c7654ee2bb7c3e0e84d4b
linux-i686	required	<a href="https://github.com/espressif/binutils-gdb/releases/download/esp-gdb-v14.2_20240403/xtensa-esp-elf-gdb-14.2_20240403-i586-linux-gnu.tar.gz">https://github.com/espressif/binutils-gdb/releases/download/esp-gdb-v14.2_20240403/xtensa-esp-elf-gdb-14.2_20240403-i586-linux-gnu.tar.gz</a> SHA256: 64d3bc992ed8fdec383d49e8b803ac494605a38117c8293db8da055037de96b0
macos	required	<a href="https://github.com/espressif/binutils-gdb/releases/download/esp-gdb-v14.2_20240403/xtensa-esp-elf-gdb-14.2_20240403-x86_64-apple-darwin14.tar.gz">https://github.com/espressif/binutils-gdb/releases/download/esp-gdb-v14.2_20240403/xtensa-esp-elf-gdb-14.2_20240403-x86_64-apple-darwin14.tar.gz</a> SHA256: 023e74b3fda793da4bc0509b02de776ee0dad6efaaac17bef5916fb7dc9c26b9
macos-arm64	required	<a href="https://github.com/espressif/binutils-gdb/releases/download/esp-gdb-v14.2_20240403/xtensa-esp-elf-gdb-14.2_20240403-aarch64-apple-darwin21.1.tar.gz">https://github.com/espressif/binutils-gdb/releases/download/esp-gdb-v14.2_20240403/xtensa-esp-elf-gdb-14.2_20240403-aarch64-apple-darwin21.1.tar.gz</a> SHA256: ea757c6bf8c25238f6d2fdcc6bbab25a1b00608a0f9e19b7ddd2f37ddbdc3fb1
win32	required	<a href="https://github.com/espressif/binutils-gdb/releases/download/esp-gdb-v14.2_20240403/xtensa-esp-elf-gdb-14.2_20240403-i686-w64-mingw32.zip">https://github.com/espressif/binutils-gdb/releases/download/esp-gdb-v14.2_20240403/xtensa-esp-elf-gdb-14.2_20240403-i686-w64-mingw32.zip</a> SHA256: 322e8d9b700dc32d8158e3dc55fb85ec55de48d0bb7789375ee39a28d5d655e2
win64	required	<a href="https://github.com/espressif/binutils-gdb/releases/download/esp-gdb-v14.2_20240403/xtensa-esp-elf-gdb-14.2_20240403-x86_64-w64-mingw32.zip">https://github.com/espressif/binutils-gdb/releases/download/esp-gdb-v14.2_20240403/xtensa-esp-elf-gdb-14.2_20240403-x86_64-w64-mingw32.zip</a> SHA256: a27a2fe20f192f8e0a51b8936428b4e1cf8935cfe008ee445cc49f6fc7f6db2e

**riscv32-esp-elf-gdb** GDB for RISC-V

License: [GPL-3.0-or-later](https://www.gnu.org/licenses/gpl-3.0-or-later.html)

More info: <https://github.com/espressif/binutils-gdb>

Platform	Required	Download
linux-amd64	required	<a href="https://github.com/espressif/binutils-gdb/releases/download/esp-gdb-v14.2_20240403/riscv32-esp-elf-gdb-14.2_20240403-x86_64-linux-gnu.tar.gz">https://github.com/espressif/binutils-gdb/releases/download/esp-gdb-v14.2_20240403/riscv32-esp-elf-gdb-14.2_20240403-x86_64-linux-gnu.tar.gz</a> SHA256: ce004bc0bbd71b246800d2d13b239218b272a38bd528e316f21f1af2db8a4b13
linux-arm64	required	<a href="https://github.com/espressif/binutils-gdb/releases/download/esp-gdb-v14.2_20240403/riscv32-esp-elf-gdb-14.2_20240403-aarch64-linux-gnu.tar.gz">https://github.com/espressif/binutils-gdb/releases/download/esp-gdb-v14.2_20240403/riscv32-esp-elf-gdb-14.2_20240403-aarch64-linux-gnu.tar.gz</a> SHA256: ba10f2866c61410b88c65957274280b1a62e3bed05131654ed9b6758efe18e55
linux-armel	required	<a href="https://github.com/espressif/binutils-gdb/releases/download/esp-gdb-v14.2_20240403/riscv32-esp-elf-gdb-14.2_20240403-arm-linux-gnueabi.tar.gz">https://github.com/espressif/binutils-gdb/releases/download/esp-gdb-v14.2_20240403/riscv32-esp-elf-gdb-14.2_20240403-arm-linux-gnueabi.tar.gz</a> SHA256: 88539db5d987f28827efac7e26080a2803b9b539342ccd2963ccfdd56d7f08f7
linux-armhf	required	<a href="https://github.com/espressif/binutils-gdb/releases/download/esp-gdb-v14.2_20240403/riscv32-esp-elf-gdb-14.2_20240403-arm-linux-gnueabi.tar.gz">https://github.com/espressif/binutils-gdb/releases/download/esp-gdb-v14.2_20240403/riscv32-esp-elf-gdb-14.2_20240403-arm-linux-gnueabi.tar.gz</a> SHA256: b45b9711d6a87d4c2f688a9599ce850ce02f477756e3e797c4a6c1c549127fcb
linux-i686	required	<a href="https://github.com/espressif/binutils-gdb/releases/download/esp-gdb-v14.2_20240403/riscv32-esp-elf-gdb-14.2_20240403-i586-linux-gnu.tar.gz">https://github.com/espressif/binutils-gdb/releases/download/esp-gdb-v14.2_20240403/riscv32-esp-elf-gdb-14.2_20240403-i586-linux-gnu.tar.gz</a> SHA256: 0e628ee37438ab6ba05eb889a76d09e50cb98e0020a16b8e2b935c5cf19b4ed2
macos	required	<a href="https://github.com/espressif/binutils-gdb/releases/download/esp-gdb-v14.2_20240403/riscv32-esp-elf-gdb-14.2_20240403-x86_64-apple-darwin14.tar.gz">https://github.com/espressif/binutils-gdb/releases/download/esp-gdb-v14.2_20240403/riscv32-esp-elf-gdb-14.2_20240403-x86_64-apple-darwin14.tar.gz</a> SHA256: 8f6bda832d70dad5860a639d55aba4237bd10cbac9f4822db1eece97357b34a9
macos-arm64	required	<a href="https://github.com/espressif/binutils-gdb/releases/download/esp-gdb-v14.2_20240403/riscv32-esp-elf-gdb-14.2_20240403-aarch64-apple-darwin21.1.tar.gz">https://github.com/espressif/binutils-gdb/releases/download/esp-gdb-v14.2_20240403/riscv32-esp-elf-gdb-14.2_20240403-aarch64-apple-darwin21.1.tar.gz</a> SHA256: d88b6116e86456c8480ce9bc95aed375a35c0d091f1da0a53b86be0e6ef3d320
win32	required	<a href="https://github.com/espressif/binutils-gdb/releases/download/esp-gdb-v14.2_20240403/riscv32-esp-elf-gdb-14.2_20240403-i686-w64-mingw32.zip">https://github.com/espressif/binutils-gdb/releases/download/esp-gdb-v14.2_20240403/riscv32-esp-elf-gdb-14.2_20240403-i686-w64-mingw32.zip</a> SHA256: d6e7ce05805b0d8d4dd138ad239b98a1adf8da98941867d60760eb1ae5361730
win64	required	<a href="https://github.com/espressif/binutils-gdb/releases/download/esp-gdb-v14.2_20240403/riscv32-esp-elf-gdb-14.2_20240403-x86_64-w64-mingw32.zip">https://github.com/espressif/binutils-gdb/releases/download/esp-gdb-v14.2_20240403/riscv32-esp-elf-gdb-14.2_20240403-x86_64-w64-mingw32.zip</a> SHA256: 5c9f211dc46daf6b96fad09d709284a0f0186fef8947d9f6edd6bca5b5ad4317

**xtensa-esp-elf** Toolchain for 32-bit Xtensa based on GCC

License: [GPL-3.0-with-GCC-exception](https://www.gnu.org/licenses/gpl-3.0.html)

More info: <https://github.com/espressif/crosstool-NG>



Platform	Required	Download
linux-amd64	required	<a href="https://github.com/espressif/crostoool-NG/releases/download/esp-13.2.0_20240530/xtensa-esp-elf-13.2.0_20240530-x86_64-linux-gnu.tar.xz">https://github.com/espressif/crostoool-NG/releases/download/esp-13.2.0_20240530/xtensa-esp-elf-13.2.0_20240530-x86_64-linux-gnu.tar.xz</a> SHA256: fcef03d87eac44c0dbec2bbee98443ed2fcf82720dcd8ebfe00640807b0f07c2
linux-arm64	required	<a href="https://github.com/espressif/crostoool-NG/releases/download/esp-13.2.0_20240530/xtensa-esp-elf-13.2.0_20240530-aarch64-linux-gnu.tar.xz">https://github.com/espressif/crostoool-NG/releases/download/esp-13.2.0_20240530/xtensa-esp-elf-13.2.0_20240530-aarch64-linux-gnu.tar.xz</a> SHA256: cfe55b92b4baeaa4309a948ba65e2adfc2d17a542c64856e36650869b419574a
linux-armel	required	<a href="https://github.com/espressif/crostoool-NG/releases/download/esp-13.2.0_20240530/xtensa-esp-elf-13.2.0_20240530-arm-linux-gnueabi.tar.xz">https://github.com/espressif/crostoool-NG/releases/download/esp-13.2.0_20240530/xtensa-esp-elf-13.2.0_20240530-arm-linux-gnueabi.tar.xz</a> SHA256: c57a062969ec3d98b02a97cd9240eb31091957788509b60c356b0a6f23032669
linux-armhf	required	<a href="https://github.com/espressif/crostoool-NG/releases/download/esp-13.2.0_20240530/xtensa-esp-elf-13.2.0_20240530-arm-linux-gnueabihf.tar.xz">https://github.com/espressif/crostoool-NG/releases/download/esp-13.2.0_20240530/xtensa-esp-elf-13.2.0_20240530-arm-linux-gnueabihf.tar.xz</a> SHA256: 1adc660f4d7bcf863f54051c5843719456fab7203c1d4ccb855924fda82987
linux-i686	required	<a href="https://github.com/espressif/crostoool-NG/releases/download/esp-13.2.0_20240530/xtensa-esp-elf-13.2.0_20240530-i586-linux-gnu.tar.xz">https://github.com/espressif/crostoool-NG/releases/download/esp-13.2.0_20240530/xtensa-esp-elf-13.2.0_20240530-i586-linux-gnu.tar.xz</a> SHA256: f9203673aa0c42b041847c86b07e6f5b4aa9c90e6ff03d3cd3146928784447ea
macos	required	<a href="https://github.com/espressif/crostoool-NG/releases/download/esp-13.2.0_20240530/xtensa-esp-elf-13.2.0_20240530-x86_64-apple-darwin.tar.xz">https://github.com/espressif/crostoool-NG/releases/download/esp-13.2.0_20240530/xtensa-esp-elf-13.2.0_20240530-x86_64-apple-darwin.tar.xz</a> SHA256: 39ee7df749f4ceb93624d73627688d5b86269a7429022f986f2940499936aacd
macos-arm64	required	<a href="https://github.com/espressif/crostoool-NG/releases/download/esp-13.2.0_20240530/xtensa-esp-elf-13.2.0_20240530-aarch64-apple-darwin.tar.xz">https://github.com/espressif/crostoool-NG/releases/download/esp-13.2.0_20240530/xtensa-esp-elf-13.2.0_20240530-aarch64-apple-darwin.tar.xz</a> SHA256: d967e49a64f823e18fbae273efb1b094ac55e2207aa21fd3947c9d59f999f47e
win32	required	<a href="https://github.com/espressif/crostoool-NG/releases/download/esp-13.2.0_20240530/xtensa-esp-elf-13.2.0_20240530-i686-w64-mingw32_hotfix.zip">https://github.com/espressif/crostoool-NG/releases/download/esp-13.2.0_20240530/xtensa-esp-elf-13.2.0_20240530-i686-w64-mingw32_hotfix.zip</a> SHA256: d6b227c50e3c8e21d62502b3140e5ab74a4cb502c2b4169c36238b9858a8fb88
win64	required	<a href="https://github.com/espressif/crostoool-NG/releases/download/esp-13.2.0_20240530/xtensa-esp-elf-13.2.0_20240530-x86_64-w64-mingw32_hotfix.zip">https://github.com/espressif/crostoool-NG/releases/download/esp-13.2.0_20240530/xtensa-esp-elf-13.2.0_20240530-x86_64-w64-mingw32_hotfix.zip</a> SHA256: 155ee97b531236e6a7c763395c68ca793e55e74d2cb4d38a23057a153e01e7d0

**esp-clang** Toolchain for all Espressif chips based on clang

License: [Apache-2.0](#)

More info: <https://github.com/espressif/llvm-project>

Platform	Required	Download
linux-amd64	optional	<a href="https://github.com/espressif/llvm-project/releases/download/esp-16.0.0-20230516/llvm-esp-16.0.0-20230516-linux-amd64.tar.xz">https://github.com/espressif/llvm-project/releases/download/esp-16.0.0-20230516/llvm-esp-16.0.0-20230516-linux-amd64.tar.xz</a> SHA256: 3bdb8dd290913a93e8941da8a451ecd49f9798cc2d74bb9b63ef5cf5c4fee37f
linux-arm64	optional	<a href="https://github.com/espressif/llvm-project/releases/download/esp-16.0.0-20230516/llvm-esp-16.0.0-20230516-linux-arm64.tar.xz">https://github.com/espressif/llvm-project/releases/download/esp-16.0.0-20230516/llvm-esp-16.0.0-20230516-linux-arm64.tar.xz</a> SHA256: 4b115af6ddd04a9bffc1908fc05837998ee71d450891d741c446186f2aa9b961
linux-armhf	optional	<a href="https://github.com/espressif/llvm-project/releases/download/esp-16.0.0-20230516/llvm-esp-16.0.0-20230516-linux-armhf.tar.xz">https://github.com/espressif/llvm-project/releases/download/esp-16.0.0-20230516/llvm-esp-16.0.0-20230516-linux-armhf.tar.xz</a> SHA256: 935082bb0704420c5ca42b35038bba8702135348a50cac454ae2fb55af0b4c32
macos	optional	<a href="https://github.com/espressif/llvm-project/releases/download/esp-16.0.0-20230516/llvm-esp-16.0.0-20230516-macos.tar.xz">https://github.com/espressif/llvm-project/releases/download/esp-16.0.0-20230516/llvm-esp-16.0.0-20230516-macos.tar.xz</a> SHA256: d9824acafd3e7b1d17ace084243b82a95bbdcb149a26b085bba487ab3d3716d7
macos-arm64	optional	<a href="https://github.com/espressif/llvm-project/releases/download/esp-16.0.0-20230516/llvm-esp-16.0.0-20230516-macos-arm64.tar.xz">https://github.com/espressif/llvm-project/releases/download/esp-16.0.0-20230516/llvm-esp-16.0.0-20230516-macos-arm64.tar.xz</a> SHA256: ed5621396dc3e48413e14e8b6caed8e2993e7f2ab5fca1410081f40c940a1060
win64	optional	<a href="https://github.com/espressif/llvm-project/releases/download/esp-16.0.0-20230516/llvm-esp-16.0.0-20230516-win64.tar.xz">https://github.com/espressif/llvm-project/releases/download/esp-16.0.0-20230516/llvm-esp-16.0.0-20230516-win64.tar.xz</a> SHA256: 598c8241c8bf10fd1be8bd21845307cfc404e127041b4ba4e828350a88692883

**riscv32-esp-elf** Toolchain for 32-bit RISC-V based on GCC

License: [GPL-3.0-with-GCC-exception](#)

More info: <https://github.com/espressif/crosstool-NG>

Platform	Required	Download
linux-amd64	required	<a href="https://github.com/espressif/crosstool-NG/releases/download/esp-13.2.0_20240530/riscv32-esp-elf-13.2.0_20240530-x86_64-linux-gnu.tar.xz">https://github.com/espressif/crosstool-NG/releases/download/esp-13.2.0_20240530/riscv32-esp-elf-13.2.0_20240530-x86_64-linux-gnu.tar.xz</a> SHA256: f69a491d2f42f63e119f9077da995f7743ea8e1bf6944166a42a312cf60728a8
linux-arm64	required	<a href="https://github.com/espressif/crosstool-NG/releases/download/esp-13.2.0_20240530/riscv32-esp-elf-13.2.0_20240530-aarch64-linux-gnu.tar.xz">https://github.com/espressif/crosstool-NG/releases/download/esp-13.2.0_20240530/riscv32-esp-elf-13.2.0_20240530-aarch64-linux-gnu.tar.xz</a> SHA256: 276351b883a53e81b695d858be74114a8b627bbe4fc9c69ef46a7127ab143680
linux-armel	required	<a href="https://github.com/espressif/crosstool-NG/releases/download/esp-13.2.0_20240530/riscv32-esp-elf-13.2.0_20240530-arm-linux-gnueabi.tar.xz">https://github.com/espressif/crosstool-NG/releases/download/esp-13.2.0_20240530/riscv32-esp-elf-13.2.0_20240530-arm-linux-gnueabi.tar.xz</a> SHA256: 14890f2a624e70f11da7268347adf25b6c396f42bcd4d8ac3c5bfa4050b7c934
linux-armhf	required	<a href="https://github.com/espressif/crosstool-NG/releases/download/esp-13.2.0_20240530/riscv32-esp-elf-13.2.0_20240530-arm-linux-gnueabihf.tar.xz">https://github.com/espressif/crosstool-NG/releases/download/esp-13.2.0_20240530/riscv32-esp-elf-13.2.0_20240530-arm-linux-gnueabihf.tar.xz</a> SHA256: b61ca9ceff25986ec1d166a01319bff09639be1d4ee5bf117502ce564fdae7e9
linux-i686	required	<a href="https://github.com/espressif/crosstool-NG/releases/download/esp-13.2.0_20240530/riscv32-esp-elf-13.2.0_20240530-i586-linux-gnu.tar.xz">https://github.com/espressif/crosstool-NG/releases/download/esp-13.2.0_20240530/riscv32-esp-elf-13.2.0_20240530-i586-linux-gnu.tar.xz</a> SHA256: 12ef50f96deb9040ce360974a4237c64ae0706b0c429b90cecc8ab664cf6dbb4
macos	required	<a href="https://github.com/espressif/crosstool-NG/releases/download/esp-13.2.0_20240530/riscv32-esp-elf-13.2.0_20240530-x86_64-apple-darwin.tar.xz">https://github.com/espressif/crosstool-NG/releases/download/esp-13.2.0_20240530/riscv32-esp-elf-13.2.0_20240530-x86_64-apple-darwin.tar.xz</a> SHA256: cfbf5deaba05bf217701c8ceab7396bb0c2ca95ab58e134d4b2e175b86c2fd6c
macos-arm64	required	<a href="https://github.com/espressif/crosstool-NG/releases/download/esp-13.2.0_20240530/riscv32-esp-elf-13.2.0_20240530-aarch64-apple-darwin.tar.xz">https://github.com/espressif/crosstool-NG/releases/download/esp-13.2.0_20240530/riscv32-esp-elf-13.2.0_20240530-aarch64-apple-darwin.tar.xz</a> SHA256: 230628fcf464ca8856c82c55514e40a8919e97fbc5e66b7165ca42c9653d2302
win32	required	<a href="https://github.com/espressif/crosstool-NG/releases/download/esp-13.2.0_20240530/riscv32-esp-elf-13.2.0_20240530-i686-w64-mingw32.zip">https://github.com/espressif/crosstool-NG/releases/download/esp-13.2.0_20240530/riscv32-esp-elf-13.2.0_20240530-i686-w64-mingw32.zip</a> SHA256: 590bf10576702639825581cc00c445da6e577012840a787137417e80d15f46d
win64	required	<a href="https://github.com/espressif/crosstool-NG/releases/download/esp-13.2.0_20240530/riscv32-esp-elf-13.2.0_20240530-x86_64-w64-mingw32.zip">https://github.com/espressif/crosstool-NG/releases/download/esp-13.2.0_20240530/riscv32-esp-elf-13.2.0_20240530-x86_64-w64-mingw32.zip</a> SHA256: 413eb9f6adf8fdaf25544d014c850fc09eb38bb93a2fc5ebd107ab1b0de1bb3a

**esp32ulp-elf** Toolchain for ESP32 ULP coprocessor

License: [GPL-3.0-or-later](#)

More info: <https://github.com/espressif/binutils-gdb>

Platform	Required	Download
linux-amd64	required	<a href="https://github.com/espressif/binutils-gdb/releases/download/esp32ulp-elf-2.38_20240113/esp32ulp-elf-2.38_20240113-linux-amd64.tar.gz">https://github.com/espressif/binutils-gdb/releases/download/esp32ulp-elf-2.38_20240113/esp32ulp-elf-2.38_20240113-linux-amd64.tar.gz</a> SHA256: d13a808365b78465fa6591636dfbbb9604d9d15a397c3d9cd22626d54828ac2c
linux-arm64	required	<a href="https://github.com/espressif/binutils-gdb/releases/download/esp32ulp-elf-2.38_20240113/esp32ulp-elf-2.38_20240113-linux-arm64.tar.gz">https://github.com/espressif/binutils-gdb/releases/download/esp32ulp-elf-2.38_20240113/esp32ulp-elf-2.38_20240113-linux-arm64.tar.gz</a> SHA256: ecce0788ce1000e5c669c5adaf2fd5bf7f9bf96dcbd3555d1d9ce4dcb311038
linux-armel	required	<a href="https://github.com/espressif/binutils-gdb/releases/download/esp32ulp-elf-2.38_20240113/esp32ulp-elf-2.38_20240113-linux-armel.tar.gz">https://github.com/espressif/binutils-gdb/releases/download/esp32ulp-elf-2.38_20240113/esp32ulp-elf-2.38_20240113-linux-armel.tar.gz</a> SHA256: 7228b01277f7908d72eb659470f82e143c4c66b444538a464290d88ece16130e
linux-armhf	required	<a href="https://github.com/espressif/binutils-gdb/releases/download/esp32ulp-elf-2.38_20240113/esp32ulp-elf-2.38_20240113-linux-armhf.tar.gz">https://github.com/espressif/binutils-gdb/releases/download/esp32ulp-elf-2.38_20240113/esp32ulp-elf-2.38_20240113-linux-armhf.tar.gz</a> SHA256: 951b089c66561bc2190a8d57c316dfaef985a778728a7c30e1edcd29fe180016
linux-i686	required	<a href="https://github.com/espressif/binutils-gdb/releases/download/esp32ulp-elf-2.38_20240113/esp32ulp-elf-2.38_20240113-linux-i686.tar.gz">https://github.com/espressif/binutils-gdb/releases/download/esp32ulp-elf-2.38_20240113/esp32ulp-elf-2.38_20240113-linux-i686.tar.gz</a> SHA256: df323d40962313168f6feeb2d9471c6010ff23a7896f40244e62991517d9745b
macos	required	<a href="https://github.com/espressif/binutils-gdb/releases/download/esp32ulp-elf-2.38_20240113/esp32ulp-elf-2.38_20240113-macos.tar.gz">https://github.com/espressif/binutils-gdb/releases/download/esp32ulp-elf-2.38_20240113/esp32ulp-elf-2.38_20240113-macos.tar.gz</a> SHA256: b2aeba8eaafdf156e9e30be928dde1f133b00eaf33802d96827ec544ac7c864c
macos-arm64	required	<a href="https://github.com/espressif/binutils-gdb/releases/download/esp32ulp-elf-2.38_20240113/esp32ulp-elf-2.38_20240113-macos-arm64.tar.gz">https://github.com/espressif/binutils-gdb/releases/download/esp32ulp-elf-2.38_20240113/esp32ulp-elf-2.38_20240113-macos-arm64.tar.gz</a> SHA256: e3a4dfea043e2bce8cd00b3a0b260a59249fa61ca5931bf02f18a3d43c18deb4
win32	required	<a href="https://github.com/espressif/binutils-gdb/releases/download/esp32ulp-elf-2.38_20240113/esp32ulp-elf-2.38_20240113-win32.zip">https://github.com/espressif/binutils-gdb/releases/download/esp32ulp-elf-2.38_20240113/esp32ulp-elf-2.38_20240113-win32.zip</a> SHA256: d33b64f49df27dcfa4a24d3af1a5ead77b020f85f33448994c31b98f88e66bb4
win64	required	<a href="https://github.com/espressif/binutils-gdb/releases/download/esp32ulp-elf-2.38_20240113/esp32ulp-elf-2.38_20240113-win64.zip">https://github.com/espressif/binutils-gdb/releases/download/esp32ulp-elf-2.38_20240113/esp32ulp-elf-2.38_20240113-win64.zip</a> SHA256: 3a7627008ac92d1580542b95c696449e56aaa1d0881dc3ef5fd5c60afc77a49d

### **cmake** CMake build system

On Linux and macOS, it is recommended to install CMake using the OS-specific package manager (like apt, yum, brew, etc.). However, for convenience it is possible to install CMake using idf\_tools.py along with the other tools.

License: [BSD-3-Clause](#)

More info: <https://github.com/Kitware/CMake>

Platform	Required	Download
linux-amd64	optional	<a href="https://github.com/Kitware/CMake/releases/download/v3.24.0/cmake-3.24.0-linux-x86_64.tar.gz">https://github.com/Kitware/CMake/releases/download/v3.24.0/cmake-3.24.0-linux-x86_64.tar.gz</a> SHA256: 726f88e6598523911e4bce9b059dc20b851aa77f97e4cc5573f4e42775a5c16f
linux-arm64	optional	<a href="https://github.com/Kitware/CMake/releases/download/v3.24.0/cmake-3.24.0-linux-aarch64.tar.gz">https://github.com/Kitware/CMake/releases/download/v3.24.0/cmake-3.24.0-linux-aarch64.tar.gz</a> SHA256: 50c3b8e9d3a3cde850dd1ea143df9d1ae546cbc5e74dc6d223eefc1979189651
linux-armel	optional	<a href="https://dl.espressif.com/dl/cmake/cmake-3.24.0-Linux-armv7l.tar.gz">https://dl.espressif.com/dl/cmake/cmake-3.24.0-Linux-armv7l.tar.gz</a> SHA256: 7dc787ef968dfef92491a4f191b8739ff70f8a649608b811c7a737b52481beb0
linux-armhf	optional	<a href="https://dl.espressif.com/dl/cmake/cmake-3.24.0-Linux-armv7l.tar.gz">https://dl.espressif.com/dl/cmake/cmake-3.24.0-Linux-armv7l.tar.gz</a> SHA256: 7dc787ef968dfef92491a4f191b8739ff70f8a649608b811c7a737b52481beb0
macos	optional	<a href="https://github.com/Kitware/CMake/releases/download/v3.24.0/cmake-3.24.0-macos-universal.tar.gz">https://github.com/Kitware/CMake/releases/download/v3.24.0/cmake-3.24.0-macos-universal.tar.gz</a> SHA256: 3e0cca74a56d9027dabb845a5a26e42ef8e8b33beb1655d6a724187a345145e4
macos-arm64	optional	<a href="https://github.com/Kitware/CMake/releases/download/v3.24.0/cmake-3.24.0-macos-universal.tar.gz">https://github.com/Kitware/CMake/releases/download/v3.24.0/cmake-3.24.0-macos-universal.tar.gz</a> SHA256: 3e0cca74a56d9027dabb845a5a26e42ef8e8b33beb1655d6a724187a345145e4
win32	required	<a href="https://github.com/Kitware/CMake/releases/download/v3.24.0/cmake-3.24.0-windows-x86_64.zip">https://github.com/Kitware/CMake/releases/download/v3.24.0/cmake-3.24.0-windows-x86_64.zip</a> SHA256: b1ad8c2dbf0778e3efcc9fd61cd4a962e5c1af40aabdebee3d5074bcff2e103c
win64	required	<a href="https://github.com/Kitware/CMake/releases/download/v3.24.0/cmake-3.24.0-windows-x86_64.zip">https://github.com/Kitware/CMake/releases/download/v3.24.0/cmake-3.24.0-windows-x86_64.zip</a> SHA256: b1ad8c2dbf0778e3efcc9fd61cd4a962e5c1af40aabdebee3d5074bcff2e103c

**openocd-esp32** OpenOCD for ESP32

License: GPL-2.0-only

More info: <https://github.com/espressif/openocd-esp32>

Platform	Required	Download
linux-amd64	required	<a href="https://github.com/espressif/openocd-esp32/releases/download/v0.12.0-esp32-20240318/openocd-esp32-linux-amd64-0.12.0-esp32-20240318.tar.gz">https://github.com/espressif/openocd-esp32/releases/download/v0.12.0-esp32-20240318/openocd-esp32-linux-amd64-0.12.0-esp32-20240318.tar.gz</a> SHA256: cf26c5cef4f6b04aa23cd2778675604e5a74a4ce4d8d17b854d05fbc782d52c
linux-arm64	required	<a href="https://github.com/espressif/openocd-esp32/releases/download/v0.12.0-esp32-20240318/openocd-esp32-linux-arm64-0.12.0-esp32-20240318.tar.gz">https://github.com/espressif/openocd-esp32/releases/download/v0.12.0-esp32-20240318/openocd-esp32-linux-arm64-0.12.0-esp32-20240318.tar.gz</a> SHA256: 9b97a37aa2cab94424a778c25c0b4aa0f90d6ef9cda764a1d9289d061305f4b7
linux-armel	required	<a href="https://github.com/espressif/openocd-esp32/releases/download/v0.12.0-esp32-20240318/openocd-esp32-linux-armel-0.12.0-esp32-20240318.tar.gz">https://github.com/espressif/openocd-esp32/releases/download/v0.12.0-esp32-20240318/openocd-esp32-linux-armel-0.12.0-esp32-20240318.tar.gz</a> SHA256: b7e82776ec374983807d3389df09c632ad9bc8341f2075690b6b500319dfeaf4
linux-armhf	required	<a href="https://github.com/espressif/openocd-esp32/releases/download/v0.12.0-esp32-20240318/openocd-esp32-linux-armhf-0.12.0-esp32-20240318.tar.gz">https://github.com/espressif/openocd-esp32/releases/download/v0.12.0-esp32-20240318/openocd-esp32-linux-armhf-0.12.0-esp32-20240318.tar.gz</a> SHA256: 16f8f65f12e5ba034d328cda2567d6851a2aceb3c957d577f89401c2e1d3f93a
macos	required	<a href="https://github.com/espressif/openocd-esp32/releases/download/v0.12.0-esp32-20240318/openocd-esp32-macos-0.12.0-esp32-20240318.tar.gz">https://github.com/espressif/openocd-esp32/releases/download/v0.12.0-esp32-20240318/openocd-esp32-macos-0.12.0-esp32-20240318.tar.gz</a> SHA256: b16c3082c94df1079367c44d99f7a8605534cd48aabc18898e46e94a2c8c57e7
macos-arm64	required	<a href="https://github.com/espressif/openocd-esp32/releases/download/v0.12.0-esp32-20240318/openocd-esp32-macos-arm64-0.12.0-esp32-20240318.tar.gz">https://github.com/espressif/openocd-esp32/releases/download/v0.12.0-esp32-20240318/openocd-esp32-macos-arm64-0.12.0-esp32-20240318.tar.gz</a> SHA256: 534ec925ae6e35e869e4e4e6e4d2c4a1eb081f97ebcc2dd5efdc52d12f4c2f86
win32	required	<a href="https://github.com/espressif/openocd-esp32/releases/download/v0.12.0-esp32-20240318/openocd-esp32-win32-0.12.0-esp32-20240318.zip">https://github.com/espressif/openocd-esp32/releases/download/v0.12.0-esp32-20240318/openocd-esp32-win32-0.12.0-esp32-20240318.zip</a> SHA256: d379329eba052435173ab0d69c9b15bc164a6ce489e2a67cd11169d2dabff633
win64	required	<a href="https://github.com/espressif/openocd-esp32/releases/download/v0.12.0-esp32-20240318/openocd-esp32-win32-0.12.0-esp32-20240318.zip">https://github.com/espressif/openocd-esp32/releases/download/v0.12.0-esp32-20240318/openocd-esp32-win32-0.12.0-esp32-20240318.zip</a> SHA256: d379329eba052435173ab0d69c9b15bc164a6ce489e2a67cd11169d2dabff633

**ninja** Ninja build system

On Linux and macOS, it is recommended to install ninja using the OS-specific package manager (like apt, yum, brew, etc.). However, for convenience it is possible to install ninja using idf\_tools.py along with the other tools.

License: [Apache-2.0](#)

More info: <https://github.com/ninja-build/ninja>

Platform	Required	Download
linux-amd64	optional	<a href="https://github.com/ninja-build/ninja/releases/download/v1.11.1/ninja-linux.zip">https://github.com/ninja-build/ninja/releases/download/v1.11.1/ninja-linux.zip</a> SHA256: b901ba96e486dce377f9a070ed4ef3f79deb45f4ffe2938f8e7ddc69cfb3df77
macos	optional	<a href="https://github.com/ninja-build/ninja/releases/download/v1.11.1/ninja-mac.zip">https://github.com/ninja-build/ninja/releases/download/v1.11.1/ninja-mac.zip</a> SHA256: 482ecb23c59ae3d4f158029112de172dd96bb0e97549c4b1ca32d8fad11f873e
macos-arm64	optional	<a href="https://github.com/ninja-build/ninja/releases/download/v1.11.1/ninja-mac.zip">https://github.com/ninja-build/ninja/releases/download/v1.11.1/ninja-mac.zip</a> SHA256: 482ecb23c59ae3d4f158029112de172dd96bb0e97549c4b1ca32d8fad11f873e
win64	required	<a href="https://github.com/ninja-build/ninja/releases/download/v1.11.1/ninja-win.zip">https://github.com/ninja-build/ninja/releases/download/v1.11.1/ninja-win.zip</a> SHA256: 524b344a1a9a55005eaf868d991e090ab8ce07fa109f1820d40e74642e289abc

**idf-exe** IDF wrapper tool for Windows

License: [Apache-2.0](#)

More info: [https://github.com/espressif/idf\\_py\\_exe\\_tool](https://github.com/espressif/idf_py_exe_tool)

Platform	Required	Download
win32	required	<a href="https://github.com/espressif/idf_py_exe_tool/releases/download/v1.0.3/idf-exe-v1.0.3.zip">https://github.com/espressif/idf_py_exe_tool/releases/download/v1.0.3/idf-exe-v1.0.3.zip</a> SHA256: 7c81ef534c562354a5402ab6b90a6eb1cc8473a9f4a7b7a7f93ebbd23b4a2755
win64	required	<a href="https://github.com/espressif/idf_py_exe_tool/releases/download/v1.0.3/idf-exe-v1.0.3.zip">https://github.com/espressif/idf_py_exe_tool/releases/download/v1.0.3/idf-exe-v1.0.3.zip</a> SHA256: 7c81ef534c562354a5402ab6b90a6eb1cc8473a9f4a7b7a7f93ebbd23b4a2755

**ccache** Ccache (compiler cache)

License: [GPL-3.0-or-later](#)

More info: <https://github.com/ccache/ccache>

Platform	Required	Download
win64	required	<a href="https://github.com/ccache/ccache/releases/download/v4.8/ccache-4.8-windows-x86_64.zip">https://github.com/ccache/ccache/releases/download/v4.8/ccache-4.8-windows-x86_64.zip</a> SHA256: a2b3bab4bb8318ffc5b3e4074dc25636258bc7e4b51261f7d9bef8127fda8309

**dfu-util** dfu-util (Device Firmware Upgrade Utilities)

License: [GPL-2.0-only](#)

More info: <http://dfu-util.sourceforge.net/>

Platform	Required	Download
win64	required	<a href="https://dl.espressif.com/dl/dfu-util-0.11-win64.zip">https://dl.espressif.com/dl/dfu-util-0.11-win64.zip</a> SHA256: 652eb94cb1c074c6dbead9e47adb628922aeb198a4d440a346ab32e7a0e9bf64

**esp-rom-elfs** ESP ROM ELFsLicense: [Apache-2.0](#)More info: <https://github.com/espressif/esp-rom-elfs>

Platform	Required	Download
any	required	<a href="https://github.com/espressif/esp-rom-elfs/releases/download/20240305/esp-rom-elfs-20240305.tar.gz">https://github.com/espressif/esp-rom-elfs/releases/download/20240305/esp-rom-elfs-20240305.tar.gz</a> SHA256: a26609b415710f0163d785850c769752717004059c129c472e9a0cbd54e0422c

**qemu-xtensa** QEMU for XtensaSome ESP-specific instructions for running QEMU for Xtensa chips are here: <https://github.com/espressif/esp-toolchain-docs/blob/main/qemu/esp32/README.md>License: [GPL-2.0-only](#)More info: <https://github.com/espressif/qemu>

Platform	Required	Download
linux-amd64	optional	<a href="https://github.com/espressif/qemu/releases/download/esp-develop-9.0.0-20240606/qemu-xtensa-softmmu-esp_develop_9.0.0_20240606-x86_64-linux-gnu.tar.xz">https://github.com/espressif/qemu/releases/download/esp-develop-9.0.0-20240606/qemu-xtensa-softmmu-esp_develop_9.0.0_20240606-x86_64-linux-gnu.tar.xz</a> SHA256: 071d117c44a6e9a1bc8664ab63b592d3e17ceb779119dcb46c59571a4a7a88c9
linux-arm64	optional	<a href="https://github.com/espressif/qemu/releases/download/esp-develop-9.0.0-20240606/qemu-xtensa-softmmu-esp_develop_9.0.0_20240606-aarch64-linux-gnu.tar.xz">https://github.com/espressif/qemu/releases/download/esp-develop-9.0.0-20240606/qemu-xtensa-softmmu-esp_develop_9.0.0_20240606-aarch64-linux-gnu.tar.xz</a> SHA256: 43552f32b303a6820d0d9551903e54fc221aca98ccbd04e5cbccba881548008
macos	optional	<a href="https://github.com/espressif/qemu/releases/download/esp-develop-9.0.0-20240606/qemu-xtensa-softmmu-esp_develop_9.0.0_20240606-x86_64-apple-darwin.tar.xz">https://github.com/espressif/qemu/releases/download/esp-develop-9.0.0-20240606/qemu-xtensa-softmmu-esp_develop_9.0.0_20240606-x86_64-apple-darwin.tar.xz</a> SHA256: 0096734280ce04f558cd9bd72f35db39667f80d44309a35565f2f8c02d1f9cc3
macos-arm64	optional	<a href="https://github.com/espressif/qemu/releases/download/esp-develop-9.0.0-20240606/qemu-xtensa-softmmu-esp_develop_9.0.0_20240606-aarch64-apple-darwin.tar.xz">https://github.com/espressif/qemu/releases/download/esp-develop-9.0.0-20240606/qemu-xtensa-softmmu-esp_develop_9.0.0_20240606-aarch64-apple-darwin.tar.xz</a> SHA256: fb4ca6be7b1a4dbcf153879cf0582300f974371def0826c0c5b728f12812ad08
win64	optional	<a href="https://github.com/espressif/qemu/releases/download/esp-develop-9.0.0-20240606/qemu-xtensa-softmmu-esp_develop_9.0.0_20240606-x86_64-w64-mingw32.tar.xz">https://github.com/espressif/qemu/releases/download/esp-develop-9.0.0-20240606/qemu-xtensa-softmmu-esp_develop_9.0.0_20240606-x86_64-w64-mingw32.tar.xz</a> SHA256: 281659f7a1d49761ac6f54d0aeb14366cb93c002f21948b847a0e15c0b8f5425

**qemu-riscv32** QEMU for RISC-VSome ESP-specific instructions for running QEMU for RISC-V chips are here: <https://github.com/espressif/esp-toolchain-docs/blob/main/qemu/esp32c3/README.md>License: [GPL-2.0-only](#)More info: <https://github.com/espressif/qemu>



Platform	Required	Download
linux-amd64	optional	<a href="https://github.com/espressif/qemu/releases/download/esp-develop-9.0.0-20240606/qemu-riscv32-softmmu-esp_develop_9.0.0_20240606-x86_64-linux-gnu.tar.xz">https://github.com/espressif/qemu/releases/download/esp-develop-9.0.0-20240606/qemu-riscv32-softmmu-esp_develop_9.0.0_20240606-x86_64-linux-gnu.tar.xz</a> SHA256: 47120e826cfec7180db8cb611a7a4aed2e9b2191c2a739194f8ce085e63cdd8d
linux-arm64	optional	<a href="https://github.com/espressif/qemu/releases/download/esp-develop-9.0.0-20240606/qemu-riscv32-softmmu-esp_develop_9.0.0_20240606-aarch64-linux-gnu.tar.xz">https://github.com/espressif/qemu/releases/download/esp-develop-9.0.0-20240606/qemu-riscv32-softmmu-esp_develop_9.0.0_20240606-aarch64-linux-gnu.tar.xz</a> SHA256: 3b6221a8b1881d2c9b9fa0b0bf8d7065c84153d2a54e429307bde9feae235c27
macos	optional	<a href="https://github.com/espressif/qemu/releases/download/esp-develop-9.0.0-20240606/qemu-riscv32-softmmu-esp_develop_9.0.0_20240606-x86_64-apple-darwin.tar.xz">https://github.com/espressif/qemu/releases/download/esp-develop-9.0.0-20240606/qemu-riscv32-softmmu-esp_develop_9.0.0_20240606-x86_64-apple-darwin.tar.xz</a> SHA256: 3afa55d5abea52ccf18d0bc41fe819d568bd4ee1582989b1ee9b1ee4a609a31e
macos-arm64	optional	<a href="https://github.com/espressif/qemu/releases/download/esp-develop-9.0.0-20240606/qemu-riscv32-softmmu-esp_develop_9.0.0_20240606-aarch64-apple-darwin.tar.xz">https://github.com/espressif/qemu/releases/download/esp-develop-9.0.0-20240606/qemu-riscv32-softmmu-esp_develop_9.0.0_20240606-aarch64-apple-darwin.tar.xz</a> SHA256: 69ba5154594fb2922d5490a49ea6b4925c024c6c37f875b42f9885f513e0bcdd
win64	optional	<a href="https://github.com/espressif/qemu/releases/download/esp-develop-9.0.0-20240606/qemu-riscv32-softmmu-esp_develop_9.0.0_20240606-x86_64-w64-mingw32.tar.xz">https://github.com/espressif/qemu/releases/download/esp-develop-9.0.0-20240606/qemu-riscv32-softmmu-esp_develop_9.0.0_20240606-x86_64-w64-mingw32.tar.xz</a> SHA256: f49bb5c8f4d6e2cfbf7eec21eb8ef190a57307778705bc689536ac13bde511c

## 4.27 ESP32-H2 中的单元测试

ESP-IDF 提供以下方法测试软件。

- 一种是基于目标的测试，该测试使用运行在 esp32h2 上的中央单元测试应用程序。这些测试使用的是基于 [Unity](#) 的单元测试框架。通过把测试用例放在组件的 test 子目录，可以将其集成到 ESP-IDF 组件中。本文档主要介绍这种基于目标的测试方法。
- 另一种是基于 Linux 主机的单元测试，其中所有硬件行为都通过 Mock 组件进行模拟。此测试方法目前仍在开发中，暂且只有一小部分 ESP-IDF 组件支持 Mock，具体请参考[基于 Linux 主机的单元测试](#)。

### 4.27.1 添加常规测试用例

单元测试被添加在相应组件的 test 子目录中，测试用例写在 C 文件中，一个 C 文件可以包含多个测试用例。测试文件的名字要以“test”开头。

测试文件需要包含 unity.h 头文件，此外还需要包含待测试 C 模块需要的头文件。

测试用例需要通过 C 文件中特定的函数来添加，如下所示：

```
TEST_CASE("test name", "[module name]")
{
    // 在这里添加测试用例
}
```

- 第一个参数是此测试的描述性名称。
- 第二个参数是用方括号括起来的标识符。标识符用来对相关测试或具有特定属性的测试进行分组。

**备注：** 没有必要在每个测试用例中使用 UNITY\_BEGIN() 和 UNITY\_END() 来声明主函数的区域，unity\_platform.c 会自动调用 UNITY\_BEGIN()，然后运行测试用例，最后调用 UNITY\_END()。

test 子目录应包含组件 *CMakeLists.txt*，因为他们本身就是一种组件（即测试组件）。ESP-IDF 使用了 Unity 测试框架，位于 unity 组件里。因此，每个测试组件都需要通过 REQUIRES 参数将 unity 组件设为依赖项。通常，组件需要手动指定待编译的源文件，但是，对于测试组件来说，这个要求被放宽为仅建议将参数 SRC\_DIRS 用于 idf\_component\_register。

总的来说，test 子目录下最小的 CMakeLists.txt 文件可能如下所示：

```
idf_component_register(SRC_DIRS "."
                      INCLUDE_DIRS "."
                      REQUIRES unity)
```

更多关于如何在 Unity 下编写测试用例的信息，请查阅 <http://www.throwtheswitch.org/unity>。

## 4.27.2 添加多设备测试用例

常规测试用例会在一个在试设备 (Device Under Test, DUT) 上执行。但是，由于要求互相通信的组件（比如 GPIO、SPI）需要与其他设备进行通信，因此不能使用常规测试用例进行测试。多设备测试用例包括写入多个测试函数，并在多个 DUT 运行测试。

以下是一个多设备测试用例：

```
void gpio_master_test()
{
    gpio_config_t slave_config = {
        .pin_bit_mask = 1 << MASTER_GPIO_PIN,
        .mode = GPIO_MODE_INPUT,
    };
    gpio_config(&slave_config);
    unity_wait_for_signal("output high level");
    TEST_ASSERT(gpio_get_level(MASTER_GPIO_PIN) == 1);
}

void gpio_slave_test()
{
    gpio_config_t master_config = {
        .pin_bit_mask = 1 << SLAVE_GPIO_PIN,
        .mode = GPIO_MODE_OUTPUT,
    };
    gpio_config(&master_config);
    gpio_set_level(SLAVE_GPIO_PIN, 1);
    unity_send_signal("output high level");
}

TEST_CASE_MULTIPLE_DEVICES("gpio multiple devices test example", "[driver]", gpio_
↪master_test, gpio_slave_test);
```

宏 TEST\_CASE\_MULTIPLE\_DEVICES 用来声明多设备测试用例。

- 第一个参数指定测试用例的名字。
- 第二个参数是测试用例的描述。
- 从第三个参数开始，可以指定最多 5 个测试函数，每个函数都是单独运行在一个 DUT 上的测试入口点。

在不同的 DUT 上运行的测试用例需要相互之间进行同步。可以通过 `unity_wait_for_signal` 和 `unity_send_signal` 这两个函数使用 UART 进行同步操作。上例的场景中，slave 应该在 master 设置好 GPIO 电平后再去读取 GPIO 电平，DUT 的 UART 终端会打印提示信息，并要求用户进行交互。

DUT1 (master) 终端：

```
Waiting for signal: [output high level]!
Please press "Enter" key once any board send this signal.
```

DUT2 (slave) 终端：

```
Send signal: [output high level]!
```

一旦 DUT2 发送了该信号，你需要在 DUT1 的终端按回车键，然后 DUT1 会从 `unity_wait_for_signal` 函数中解除阻塞，并开始更改 GPIO 的电平。



### 4.27.3 添加多阶段测试用例

常规的测试用例无需重启就会结束（或者仅需要检查是否发生了重启），可有些时候我们想在某些特定类型的重启事件后运行指定的测试代码。例如，在深度睡眠唤醒后检查复位的原因是否正确。首先我们需要触发深度睡眠复位事件，然后检查复位的原因。为了实现这一点，可以通过定义多阶段测试用例来将这些测试函数组合在一起：

```
static void trigger_deepsleep(void)
{
    esp_sleep_enable_timer_wakeup(2000);
    esp_deep_sleep_start();
}

void check_deepsleep_reset_reason()
{
    soc_reset_reason_t reason = esp_rom_get_reset_reason(0);
    TEST_ASSERT(reason == RESET_REASON_CORE_DEEP_SLEEP);
}

TEST_CASE_MULTIPLE_STAGES("reset reason check for deepsleep", "[esp32h2]", trigger_
↪deepsleep, check_deepsleep_reset_reason);
```

多阶段测试用例向用户呈现了一组测试函数，它需要用户进行交互（选择用例并选择不同的阶段）来运行。

### 4.27.4 应用于不同芯片的单元测试

某些测试（尤其与硬件相关的）不支持在所有的芯片上执行。请参照本节，让你的单元测试只在其中一部分芯片上执行。

1. 使用宏 `!(TEMPORARY_)DISABLED_FOR_TARGETS()` 包装你的测试代码，并将其放于原始的测试文件中，或将代码分成按功能分组的文件。但请确保所有这些文件都会由编译器处理。例：

```
#if !TEMPORARY_DISABLED_FOR_TARGETS(ESP32, ESP8266)
TEST_CASE("a test that is not ready for esp32 and esp8266 yet", "[ ]")
{
}
#endif //!TEMPORARY_DISABLED_FOR_TARGETS(ESP32, ESP8266)
```

如果要将其中某个测试在特定芯片上编译，只需要修改禁止的芯片列表。推荐使用一些能在 `soc_caps.h` 中被清楚描述的通用概念来禁止某些单元测试。如果已经进行上述操作，但一些测试在芯片中的调试暂未通过，请同时使用上述两种方法，当调试完成后再移除 `(TEMPORARY_)DISABLED_FOR_TARGETS()`。例：

```
#if SOC_SDIO_SLAVE_SUPPORTED
#if !TEMPORARY_DISABLED_FOR_TARGETS(ESP64)
TEST_CASE("a sdio slave tests that is not ready for esp64 yet", "[sdio_slave]")
{
    //available for esp32 now, and will be available for esp64 in the future
}
#endif //!TEMPORARY_DISABLED_FOR_TARGETS(ESP64)
#endif //SOC_SDIO_SLAVE_SUPPORTED
```

2. 对于某些你确定不会支持的测试（例如，芯片根本没有该外设），使用 `DISABLED_FOR_TARGETS` 来禁止该测试；对于其他只是临时性需要关闭的（例如，没有 `runner` 资源等），使用 `TEMPORARY_DISABLED_FOR_TARGETS` 来暂时关闭该测试。

一些禁用目标芯片测试用例的旧方法，由于它们具有明显的缺陷，已经被废弃，请勿继续使用：

- 请勿将测试代码放在 `test/target` 目录下并用 `CMakeLists.txt` 来选择其中一个进行编译。这是因为测试代码比实现代码更容易被复用。如果你将一些代码放在 `test/esp32` 目录下避免 `esp32s2` 芯片执行它，一旦你需要在新的芯片（比如 `esp32s3`）中启用该测试，这种结构很难保持代码整洁。

- 请勿继续使用 `CONFIG_IDF_TARGET_XXX` 宏来禁用测试。这种方法会让被禁用的测试项目难以追踪和重新打开。并且，相比于白名单式的 `#if CONFIG_IDF_TARGET_XXX`，黑名单式的 `#if !disabled` 不会导致在新芯片引入时这些测试被自动禁用。但对于测试实现，仍可使用 `#if CONFIG_IDF_TARGET_XXX` 给不同芯片版本选择实现代码。测试项目和测试实现区分如下：
  - 测试项目：那些会在一些芯片上执行，而在另外一些上跳过的项目，例如：
    - 有三个测试项目 `SD 1-bit`、`SD 4-bit` 和 `SDSPI`。对于不支持 `SD Host` 外设的 `ESP32-S2` 芯片，只有 `SDSPI` 一个项目需要被执行。
  - 测试实现：一些始终会发生的代码，但采取的实现方式不同。例如：
    - `ESP8266` 芯片没有 `SDIO_PKT_LEN` 寄存器。如果在测试过程中需要从 `slave` 设备的数据长度，你可以用不同方式读取的 `#if CONFIG_IDF_TARGET_` 宏来保护不同的实现代码。但请注意避免使用 `#else` 宏。这样当新芯片被引入时，测试就会在编译阶段失败，提示维护者去显示选择一个正确的测试实现。

### 4.27.5 编译单元测试程序

按照 `esp-idf` 顶层目录的 `README` 文件中的说明进行操作，请确保 `IDF_PATH` 环境变量已经被设置指向了 `esp-idf` 的顶层目录。

切换到 `tools/unit-test-app` 目录下进行配置和编译：

- `idf.py menuconfig` - 配置单元测试程序。
- `idf.py -T all build` - 编译单元测试程序，测试每个组件 `test` 子目录下的用例。
- `idf.py -T "xxx yyy" build` - 编译单元测试程序，对以空格分隔的特定组件进行测试（如 `idf.py -T heap build` - 仅对 `heap` 组件目录下的单元测试程序进行编译）。
- `idf.py -T all -E "xxx yyy" build` - 编译单元测试程序，测试除指定组件之外的所有组件（例如 `idf.py -T all -E "ulp mbedt1s" build` - 编译所有的单元测试，不包括 `ulp` 和 `mbedt1s` 组件。）。

**备注：**由于 Windows 命令提示符固有限制，需使用以下语法来编译多个组件的单元测试程序：`idf.py -T xxx -T yyy build` 或者在 PowerShell 中使用 `idf.py -T \"xxx yyy\" build`，在 Windows 命令提示符中使用 `idf.py -T \"ssd1306 hts221\" build`。

当编译完成时，它会打印出烧写芯片的指令。你只需要运行 `idf.py flash` 即可烧写所有编译输出的文件。

你还可以运行 `idf.py -T all flash` 或者 `idf.py -T xxx flash` 来编译并烧写，所有需要的文件都会在烧写之前自动重新编译。

使用 `menuconfig` 可以设置烧写测试程序所使用的串口。更多信息，见 <tools/unit-test-app/README.md>。

### 4.27.6 运行单元测试

**备注：**我们还提供基于 `pytest` 的框架 `pytest-embedded`，以便更方便、高效地运行单元测试。如需在 CI 中运行测试或连续运行多个测试，不妨尝试这一框架。了解更多信息，请查看 [pytest-embedded 文档](#) 和 [ESP-IDF pytest 指南](#)。

烧写完成后重启 `ESP32-H2`，它将启动单元测试程序。

当单元测试应用程序空闲时，输入回车键，它会打印出测试菜单，其中包含所有的测试项目：

```
Here is the test menu, pick your combo:
(1)  "esp_ota_begin() verifies arguments" [ota]
(2)  "esp_ota_get_next_update_partition logic" [ota]
(3)  "Verify bootloader image in flash" [bootloader_support]
(4)  "Verify unit test app image" [bootloader_support]
(5)  "can use new and delete" [cxx]
```

(下页继续)

(续上页)

```

(6)    "can call virtual functions" [cxx]
(7)    "can use static initializers for non-POD types" [cxx]
(8)    "can use std::vector" [cxx]
(9)    "static initialization guards work as expected" [cxx]
(10)   "global initializers run in the correct order" [cxx]
(11)   "before scheduler has started, static initializers work correctly" [cxx]
(12)   "adc2 work with wifi" [adc]
(13)   "gpio master/slave test example" [ignore][misc][test_env=UT_T2_1][multi_
↪device]
      (1)    "gpio_master_test"
      (2)    "gpio_slave_test"
(14)   "SPI Master clockdiv calculation routines" [spi]
(15)   "SPI Master test" [spi][ignore]
(16)   "SPI Master test, interaction of multiple devs" [spi][ignore]
(17)   "SPI Master no response when switch from host1 (SPI2) to host2 (SPI3)" ↪
↪[spi]
(18)   "SPI Master DMA test, TX and RX in different regions" [spi]
(19)   "SPI Master DMA test: length, start, not aligned" [spi]
(20)   "reset reason check for deepsleep" [esp32h2][test_env=UT_T2_1][multi_stage]
      (1)    "trigger_deepsleep"
      (2)    "check_deepsleep_reset_reason"

```

常规测试用例会打印用例名字和描述，主从测试用例还会打印子菜单（已注册的测试函数的名字）。

可以输入以下任意一项来运行测试用例：

- 引号中写入测试用例的名字，运行单个测试用例。
- 测试用例的序号，运行单个测试用例。
- 方括号中的模块名字，运行指定模块所有的测试用例。
- 星号，运行所有测试用例。

[multi\_device] 和 [multi\_stage] 标签告诉测试运行者该用例是多设备测试还是多阶段测试。这些标签由 TEST\_CASE\_MULTIPLE\_STAGES 和 TEST\_CASE\_MULTIPLE\_DEVICES 宏自动生成。

一旦选择了多设备测试用例，它会打印一个子菜单：

```

Running gpio master/slave test example...
gpio master/slave test example
      (1)    "gpio_master_test"
      (2)    "gpio_slave_test"

```

你需要输入数字以选择在 DUT 上运行的测试。

与多设备测试用例相似，多阶段测试用例也会打印子菜单：

```

Running reset reason check for deepsleep...
reset reason check for deepsleep
      (1)    "trigger_deepsleep"
      (2)    "check_deepsleep_reset_reason"

```

第一次执行此用例时，输入 1 来运行第一阶段（触发深度睡眠）。在重启 DUT 并再次选择运行此用例后，输入 2 来运行第二阶段。只有在最后一个阶段通过并且之前所有的阶段都成功触发了复位的情况下，该测试才算通过。

### 4.27.7 带缓存补偿定时器的定时代码

存储在外部存储器（如 SPI flash 和 SPI RAM）中的指令和数据是通过 CPU 的统一指令和数据缓存来访问的。当代码或数据在缓存中时，访问速度会非常快（即缓存命中）。

然而，如果指令或数据不在缓存中，则需要从外部存储器中获取（即缓存缺失）。访问外部存储器的速度明显较慢，因为 CPU 在等待从外部存储器获取指令或数据时会陷入停滞，从而导致整体代码执行速度会依据缓存命中或缓存缺失的次数而变化。

在不同的编译中，代码和数据的位置可能会有所不同，一些可能会更有利于缓存访问（即最大限度地减少缓存缺失）。理论上，这会影响执行速度，但这些因素通常无关紧要，因为它们的影响会在设备的运行过程中“平均化”。

然而，高速缓存对执行速度的影响可能与基准测试场景（尤其是微基准测试）有关。每次运行时间和构建时的测量时间可能会有所差异，减少差异的方法之一是将代码和数据分别放在指令或数据 RAM (IRAM/DRAM) 中。CPU 可以直接访问 IRAM 和 DRAM，从而消除了高速缓存的影响因素。然而，由于 IRAM 和 DRAM 容量有限，该方法并不总是可行。

缓存补偿定时器是上述方法的替代方法，该计时器使用处理器的内部事件计数器来确定在发生高速缓存未命中时等待代码/数据所花费的时间，然后从记录的实时时间中减去该时间。

```
// Start the timer
ccomp_timer_start();

// Function to time
func_code_to_time();

// Stop the timer, and return the elapsed time in microseconds relative to
// ccomp_timer_start
int64_t t = ccomp_timer_stop();
```

缓存补偿定时器的限制之一是基准功能必须固定在一个内核上。这是由于每个内核都有自己的事件计数器，这些事件计数器彼此独立。例如，如果在一个内核上调用 `ccomp_timer_start`，使调度器进入睡眠状态，唤醒并在另一个内核上重新调度，那么对应的 `ccomp_timer_stop` 将无效。

## 4.27.8 Mocks

**备注：**目前，只有一些特定的组件在 Linux 主机上运行时才能 Mock。未来我们计划，无论是在 Linux 主机上运行还是在目标芯片 ESP32-H2 上运行，ESP-IDF 所有重要的组件都可以实现 Mock。

嵌入式系统中单元测试的最大问题之一是对硬件依赖性极强。直接在 ESP32-H2 上运行单元测试对于上层组件来说存在极大的困难，原因如下：

- 受下层组件和/或硬件设置的影响，测试可靠性降低。
- 由于下层组件和/或硬件设置的限制，测试边缘案例的难度提高。
- 由于数量庞大的依赖关系影响了行为，识别根本难度的提高。

当测试一个特定的组件（即被测组件）时，通过软件进行 Mock 能让所有被测组件的依赖在软件中被完全替换（即 Mock）。为了实现该功能，ESP-IDF 集成了 CMock 的 Mock 框架作为组件。通过在 ESP-IDF 的构建系统中添加一些 CMake 函数，可以方便地 Mock 整个（或部分）ESP-IDF 组件。

理想情况下，被测组件所依赖的所有组件都应该被 Mock，从而让测试环境完全控制与被测组件之间的所有交互。然而，如果 Mock 所有的组件过于复杂或冗长（例如需要模拟过多的函数调用），以下做法可能会有帮助：

- 在测试代码中包含更多“真正”（非模拟）代码。这样做可能有效，但同时也会增加对“真正”代码行为的依赖。此外，一旦测试失败，很难判断失败原因是因为实际测试代码还是“真正”的 ESP-IDF 代码。
- 重新评估被测代码的设计，尝试将被测代码划分为更易于管理的组件来减少其依赖性。这可能看起来很麻烦，但众所周知，单元测试经常暴露软件设计的弱点。修复设计上的弱点不仅在短期内有助于进行单元测试，而且还有助于长期的代码维护。

请参考 [cmock/CMock/docs/CMock\\_Summary.md](#) 了解 CMock 工作原理以及如何创建和使用 Mock。

### 要求

目前 Mock 只支持基于 Linux 主机的单元测试。生成 Mock 需要满足如下要求：

- 已安装 ESP-IDF 及使用 ESP-IDF 的所有依赖项
- 满足系统软件包需求 (libbsd、libbsd-dev)
- Linux 或 macOS 和 GCC 编译器已更新至足够新的版本
- 应用程序所依赖的所有组件必须受 Linux 目标 (Linux/POSIX 模拟器) 支持，或可进行模拟

对于在 Linux 目标上运行的应用程序，需要在应用程序根目录的 CMakeLists.txt 文件中，设置 COMPONENTS 变量为 main，具体操作如下：

```
set (COMPONENTS main)
```

为方便起见，应用程序会在构建过程中，自动包含 ESP-IDF 的所有组件，执行上述代码则可以防止此类情况。

### 对组件进行 Mock

如果 ESP-IDF 中已对组件进行 Mock (也称为 组件模拟)，那么只要满足要求，该版本即可立即投入使用。已进行 Mock 的组件列表，可参考[组件 Linux/Mock 支持情况概述](#)。具体组件模拟的使用方法，请参考[修改单元测试文件](#)。

如果 ESP-IDF 尚未提供任何组件模拟，则需要创建组件的 Mock 版本，以特定方式覆盖组件。覆盖组件时，需要创建一个与原始组件名称完全相同的组件，让构建系统先发现原始组件，再发现这个具有相同名称的新组件。具体可参考[同名组件](#)。

在组件模拟中需要指定如下部分：

- 头文件，头文件中提供了需要生成模拟的函数
- 上述头文件的路径
- 模拟组件的依赖 (如果头文件中包含了其他组件的文件，那么这点非常必要)

以上这些部分都需要使用 ESP-IDF 构建系统函数 `idf_component_mock` 指定。你可以使用 ESP-IDF 构建系统函数 `idf_component_get_property`，并加上标签 `COMPONENT_OVERRIDEN_DIR` 来访问原始组件的组件目录，然后使用 `idf_component_mock` 注册模拟组件。

```
idf_component_get_property(original_component_dir <original-component-name>_
↳COMPONENT_OVERRIDEN_DIR)
...
idf_component_mock(INCLUDE_DIRS "${original_component_dir}/include"
  REQUIRES freertos
  MOCK_HEADER_FILES ${original_component_dir}/include/header_containing_
↳functions_to_mock.h)
```

组件模拟还需要一个单独的 mock 目录，里面包含一个 `mock_config.yaml` 文件用于配置 CMock。以下是一份简单的 `mock_config.yaml` 文件：

```
:cmock:
  :plugins:
    - expect
    - expect_any_args
```

更多关于 CMock yaml 类型配置文件的详细信息，请查看 [cmock/CMock/docs/CMock\\_Summary.md](#)。

请注意，组件模拟不一定要对原始组件进行整体模拟。只要组件模拟满足测试项目的依赖以及其他代码对原始组件的依赖，部分模拟就足够了。事实上，ESP-IDF 中 `tools/mocks` 中的大多数组件模拟都只是部分地模拟了原始组件。

可在 ESP-IDF 目录的 `tools/mocks` 下找到组件模拟的示例。有关如何覆盖 ESP-IDF 组件，可查看[同名组件](#)。

- [NVS 页面类的单元测试](#)。
- [esp\\_event 的单元测试](#)。
- [mqtt 的单元测试](#)。



## 修改单元测试文件

单元测试需要通知 `cmake` 构建系统对依赖的组件进行模拟（即用模拟组件来覆盖原始组件）。这可以通过将组件模拟放到项目的 `components` 目录，或者在项目的根目录 `CMakeLists.txt` 文件中使用以下代码来添加模拟组件的目录来实现：

```
list(APPEND EXTRA_COMPONENT_DIRS "<mock_component_dir>")
```

这两种方法都会让组件模拟覆盖 ESP-IDF 中的现有组件。如果你使用的是 ESP-IDF 提供的组件模拟，则第二个方法更加方便。

可参考 `esp_event` 基于主机的单元测试及其 `esp_event/host_test/esp_event_unit_test/CMakeLists.txt` 作为组件模拟的示例。

## 4.28 在主机上运行 ESP-IDF 应用程序

---

**备注：**在主机上运行 ESP-IDF 应用程序的功能仍处于试验阶段，无法保证 API 的稳定性。欢迎用户通过 [ESP-IDF GitHub 仓库](#) 或 [ESP32 论坛](#) 提供反馈意见，助力未来 ESP-IDF 基于主机的应用程序设计。

---

本文档概述了在 Linux 上运行 ESP-IDF 应用程序的方法，并介绍了可以在 Linux 上运行的常见 ESP-IDF 应用程序类型。

### 4.28.1 介绍

ESP-IDF 应用程序通常在主机上进行构建（交叉编译），然后上传（即烧录）到 ESP 芯片上运行，并由主机通过 UART/USB 端口监控。然而，在 ESP 芯片上运行 ESP-IDF 应用程序在各种开发/使用/测试场景下可能存在限制。

因此，ESP-IDF 支持在同一台 Linux 主机上构建和运行其应用程序。在主机上运行 ESP-IDF 应用程序具有以下几个优点：

- 无需上传到目标芯片。
- 应用程序在主机上的运行速度比在 ESP 芯片上快。
- 除主机本身外，无特定硬件要求。
- 更易进行软件测试的自动化和设置。
- 提供大量用于代码和运行分析的工具，如 `Valgrind`。

许多 ESP-IDF 组件依赖支持特定芯片的硬件，因此在主机上运行应用程序时，必须对这些硬件依赖文件进行模拟或仿真。目前，ESP-IDF 支持以下模拟和仿真方法：

1. 使用 [FreeRTOS POSIX/Linux 模拟器](#) 可以模拟 FreeRTOS 调度。在此模拟的基础上，在主机上运行应用程序时也会模拟或使用其他 API。
2. 使用 [CMock](#) 可以模拟所有依赖文件，并在完全独立的情况下运行代码。

原则上，这两种方法（POSIX/Linux 模拟器和使用 `CMock` 模拟）可以混用，但此功能在 ESP-IDF 中尚未实现。注意，尽管名称中包含 POSIX/Linux，但目前的 FreeRTOS POSIX/Linux 模拟器也支持在 macOS 系统中运行。在主机上运行 ESP-IDF 应用程序通常用于测试，但模拟环境和模拟依赖文件并不能完全代表目标设备。因此，仍然需要在目标设备上测试，此时测试的侧重点通常在集成和系统测试上。

---

**备注：**在主机上运行应用程序的另一方法是使用 `QEMU` 模拟器，但 ESP-IDF 的 `QEMU` 模拟器仍在开发中，尚未发布相关文档。

---

## 基于 CMock 的模拟

该方法使用 CMock 框架解决缺少硬件和软件依赖文件的问题。在主机上运行基于 CMock 的应用程序具备一大优势：在主机上运行的应用程序通常只编译必要代码，即模拟了最主要代码的依赖文件，而非编译整个系统。有关 Mocks 的总体介绍及其在 ESP-IDF 的配置和使用，请参阅 [Mocks](#)。

## POSIX/Linux 模拟器的模拟

ESP-IDF 已支持使用 [FreeRTOS POSIX/Linux 模拟器](#) 预览应用程序在目标芯片上的运行效果。使用该模拟器可以在主机上运行 ESP-IDF 组件，并使这类组件可用于在主机上运行的 ESP-IDF 应用程序。目前，只有一部分组件可以在 Linux 上构建。此外，各组件移植到 Linux 上后，其功能可能也会受到限制，或与在芯片目标上构建该组件的功能有所不同。有关所需组件在 Linux 上是否受支持的更多信息，请参阅 [组件 Linux/Mock 支持情况概述](#)。

**备注：**FreeRTOS POSIX/Linux 模拟器支持配置 [Amazon SMP FreeRTOS](#) 版本，但模拟仍在单核模式下运行。支持 Amazon SMP FreeRTOS 主要是为给 Amazon SMP FreeRTOS 编写的 ESP-IDF 应用程序提供 API 兼容性。

### 4.28.2 使用模拟器的前提

- 已安装 ESP-IDF 及使用 ESP-IDF 的所有依赖项
- 满足系统软件包需求 (libbsd、libbsd-dev)
- Linux 或 macOS 和 GCC 编译器已更新至足够新的版本
- 应用程序所依赖的所有组件必须受 Linux 目标 (Linux/POSIX 模拟器) 支持，或可进行模拟

对于在 Linux 目标上运行的应用程序，需要在应用程序根目录的 CMakeLists.txt 文件中，设置 COMPONENTS 变量为 main，具体操作如下：

```
set(COMPONENTS main)
```

为方便起见，应用程序会在构建过程中，自动包含 ESP-IDF 的所有组件，执行上述代码则可以防止此类情况。

如果使用了任意模拟器，则应设置变量 Ruby。

### 4.28.3 构建和运行

要在 Linux 上构建并运行应用程序，需要将目标芯片设置为 linux：

```
idf.py --preview set-target linux
idf.py build
idf.py monitor
```

### 4.28.4 组件 Linux/Mock 支持情况概述

注意，下表中的“是”并不代表完全实现或模拟，它也可以表示功能的部分实现或模拟。实现或模拟通常只进行到可以提供足够功能、可以构建和运行测试应用程序的程度。

组件	模拟	仿真
cmock	否	是
driver	是	否
esp_common	否	是
esp_event	是	是

下页继续

表 28 - 续上页

组件	模拟	仿真
esp_http_client	否	是
esp_http_server	否	是
esp_https_server	否	是
esp_hw_support	是	是
esp_netif	是	是
esp_netif_stack	否	是
esp_partition	是	否
esp_rom	否	是
esp_system	否	是
esp_timer	是	否
esp_tls	是	否
fatfs	否	是
freertos	是	是
hal	否	是
heap	否	是
http_parser	是	是
json	否	是
linux	否	是
log	否	是
lwip	是	是
mbdts	否	是
mqtt	否	是
nvs_flash	否	是
partition_table	否	是
protobuf-c	否	是
pthread	否	是
soc	否	是
spiffs	否	是
spi_flash	是	否
tcp_transport	是	否
unity	否	是

## 4.29 USB 串行/JTAG 控制器控制台

ESP 芯片通常使用 UART 实现串口，并可以通过外部 USB-UART 桥接芯片，连接到主机/PC 上的串口控制台仿真器。然而，在具有 USB 串行/JTAG 控制器的 ESP 芯片上，控制器的 CDC-ACM 部分即可实现串口，该串口直接连接到主机/PC，不需要外部 USB-UART 桥接芯片。

拥有 USB 串行/JTAG 控制器时，ESP32-H2 支持以下功能：

- 双向串行控制台，可与 *IDF 监视器* 或其他串行监视器一起使用。
- 使用 `esptool.py` 和 `idf.py flash` 烧录。
- 使用 OpenOCD 等工具进行 JTAG 调试，同时进行串行操作。

**备注：**USB 串行/JTAG 控制器是一个 USB 设备，其功能固定，完全由硬件实现。也就是说，即便重新配置，它也只能执行串口和 JTAG 调试功能。这不同于某些 ESP 芯片中的 USB OTG 控制器，后者经配置，可以执行多种 USB 设备功能。



### 4.29.1 硬件要求

将 ESP32-H2 连接到 USB 端口，连接方式如下：

GPIO	USB
27	D+ (绿)
26	D- (白)
GND	GND (黑)
5V (或由外部提供)	+5V (红)

部分开发板可能会为 USB 串行/JTAG 控制器提供 USB 连接器，此时无需额外连接。

### 4.29.2 软件配置

在 `CONFIG_ESP_CONSOLE_UART` 选项中选择 `CONFIG_ESP_CONSOLE_USB_SERIAL_JTAG`，可以将 USB 串行/JTAG 控制器用作串口。选择该选项后，即可正常构建和烧录项目。

另外，也可以通过 `usb_serial_jtag` 端口访问输出，但请确保在 `CONFIG_ESP_CONSOLE_SECONDARY` 选项中选择了 `CONFIG_ESP_CONSOLE_SECONDARY_USB_SERIAL_JTAG`。

**警告：** 除输出外，如果还想用控制台输入或使用交互式解释器 (REPL)，请选择 `CONFIG_ESP_CONSOLE_USB_SERIAL_JTAG` 选项。

### 4.29.3 上传应用程序

USB 串行/JTAG 控制器可以自动将 ESP32-H2 置于下载模式。用户只需正常烧录芯片，但需要在系统上指定 USB 串行/JTAG 控制器端口：`idf.py flash -p PORT`，PORT 是正确的端口名称。

**备注：** USB 串行/JTAG 控制器的串行端口通常：

- 在 Linux 系统上显示为 `/dev/ttyACM*`
- 在 MAC 系统上显示为 `/dev/cu*`
- 在 Windows 设备管理器上显示为 COM\* 端口

### 4.29.4 限制

USB 串行/JTAG 控制台功能存在一些限制，这些限制的影响程度各不相同，具体取决于开发中的应用程序类型，以及开发的工作流程。

#### 重新配置 USB 管脚

如果在意外情况下，应用程序重新配置了 USB 外设管脚，或禁用了 USB 串行/JTAG 控制器，设备会从系统消失。应用程序中的问题修复后，需要将未更新！拉低，并重置芯片，手动将 ESP32-H2 置于下载模式。

如果应用程序进入 Deep-sleep 模式，USB 串行/JTAG 设备会从系统中消失。

#### 数据缓冲

对于从 ESP32-H2 发送到 PC 终端的数据（例如 stdout、日志），ESP32-H2 会先写入一个小型内部缓冲区。如果该缓冲区达到最大容量（例如没有连接 PC 终端），ESP32-H2 会进行一次等待，时长约 50 ms。在此期间，PC 终端可以请求数据，但可能会导致应用程序出现非常短暂的暂停。

对于从 PC 终端发送到 ESP32-H2 的数据（如控制台命令），许多 PC 终端会等待 ESP32-H2 接收字节后，再允许发送更多数据。这与使用 USB 转串口 (URAT) 桥接芯片不同，URAT 桥接芯片始终接收字节，并将其发送到（可能未在监听）的 ESP32-H2。

**备注：**在极少数情况下，从 ESP32-H2 发送到主机的数据可能会“阻塞”在主机内存中。继续发送数据即可“取消阻塞”，但如果应用程序未继续发送数据，则需要手动将这些数据刷新到主机。能否继续发送数据取决于驱动程序，默认配置的非阻塞驱动程序和 VFS 实现会在换行后自动刷新，而基于中断的阻塞驱动程序会在发送缓冲区变空时自动刷新。

## 睡眠模式考虑因素

USB 串行/JTAG 控制器及其关联的 USB PHY 均由特定时钟控制（如 APB 和 USB PHY 时钟），并属于特定的电源域（如数字电源域）。因此，对 USB 串行/JTAG 控制器关联的时钟和电源域进行任何更改，如进入另一睡眠模式，都可能影响控制器操作。

**Deep-sleep** 进入 Deep-sleep 模式时，USB 串行/JTAG 控制器及 USB PHY 关闭，导致 USB PHY 的 D+ 线不再变成高电平。因此：

- 进入 Deep-sleep 模式时，USB 串行/JTAG 设备会对主机/PC 显示为断开连接。即使 USB 电缆在物理层面上处于连接状态，仍会显示为断开连接。
- 退出 Deep-sleep 模式时，USB 串行/JTAG 设备会重新连接到主机/PC。

**Light-sleep** 进入 Light-sleep 模式时，APB 和 USB PHY 时钟关闭。因此，USB 串行/JTAG 控制器将无法接收或响应任何来自相连主机的 USB 事务，包括周期性的 CDC Data IN 事务。因此：

- 进入 Light-sleep 模式时，USB 串行/JTAG 设备无法响应主机/PC 的 USB CDC 驱动程序。主机/PC 可能会报告 USB 串行/JTAG 设备已断开连接，或连接出错。即使 USB 电缆在物理层面上处于连接状态，仍会显示为断开连接。
- 退出 Light-sleep 模式时，由于 USB PHY 的 D+ 线在 Light-sleep 期间始终处于高电平，可能导致主机/PC 不会重新枚举（即重新连接）USB 串行/JTAG 设备。用户可能需要在物理层面上断开 USB 电缆，并重新连接。

**自动与手动进入睡眠模式** 如果通过 `esp_light_sleep_start()` 或 `esp_deep_sleep_start()` 手动进入睡眠模式，需注意，USB 串行/JTAG 控制器在睡眠期间不工作。ESP-IDF 没有添加任何拒绝进入睡眠的安全检查，即使 USB 串行/JTAG 控制器已连接，也会进入睡眠模式。如果在连接了 USB 串行/JTAG 控制器的情况下进入睡眠，可以通过拔出并重新插入 USB 电缆来重新建立连接。

如果通过 `esp_pm_configure()` 自动进入睡眠模式，请启用 `CONFIG_USJ_NO_AUTO_LS_ON_CONNECTION` 选项，该选项支持 ESP32-H2 自动检测 USB 串行/JTAG 控制器与主机的连接情况，并在连接持续时，阻止程序自动进入睡眠模式。注意，此选项会增加功耗。

## 4.30 低功耗模式使用指南

对于物联网应用场景，终端的待机性能表现十分重要，本文档旨在介绍 ESP32-H2 低功耗的基本原理，同时介绍 ESP32-H2 支持的低功耗模式，需注意本文档主要针对 `station mode`。文档还会具体给出每种模式的配置步骤、推荐配置和功耗表现，以帮助用户根据实际需求快速配置适合的低功耗模式。

### 4.30.1 系统低功耗模式介绍

低功耗模式不仅涉及到系统相关问题，还涉及到芯片具体的工作场景，如处在 Wi-Fi 工作场景就会与处在蓝牙工作场景时产生不同。为此本节将首先介绍纯系统角度，即不涉及具体场景的低功耗模式，主要

有 DFS、Light-sleep、Deep-sleep。纯系统下的低功耗模式主要思想就是在休眠时关闭或门控一些功能模块来降低功耗。

## DFS

DFS (Dynamic frequency scaling) 即动态频率切换，是 ESP-IDF 中集成的电源管理机制的基础功能。DFS 可以根据应用程序持有电源锁的情况，调整外围总线 (APB) 频率和 CPU 频率。持有高性能锁就使用高频，空闲状态不持有电源锁时则使用低频来降低功耗，以此来尽可能减少运行应用程序的功耗。

DFS 的调频机制即根据持有电源锁的最大频率需求来调整频率，同时，freertos tick rates 的数值也会对 DFS 调频产生影响。系统任务调度的灵敏度越大，则意味着系统能更及时的根据需求调整频率。有关调频机制的详细信息，请参见[电源管理](#)。

下图为 DFS 调频机制运行的理想电流情况。



图 43: 理想 DFS 机制调频电流图

DFS 适用于 CPU 必须处于工作状态但是对低功耗有需求的场景，因此 DFS 经常与其他低功耗模式共同开启，下文会详细介绍。

## Light-sleep

Light-sleep 模式是 ESP32-H2 预设的一种低功耗模式，其核心思想就是在休眠时关闭或门控一些功能模块来降低功耗。从纯系统方面来说，Light-sleep 模式有两种进入方式，一种是通过 API 调用进入休眠，一种是自动进入的 auto 模式。两种模式都需要配置唤醒源进行唤醒，同时在进入休眠后会门控或关闭一些模块。这里主要介绍 Auto Light-sleep 模式。

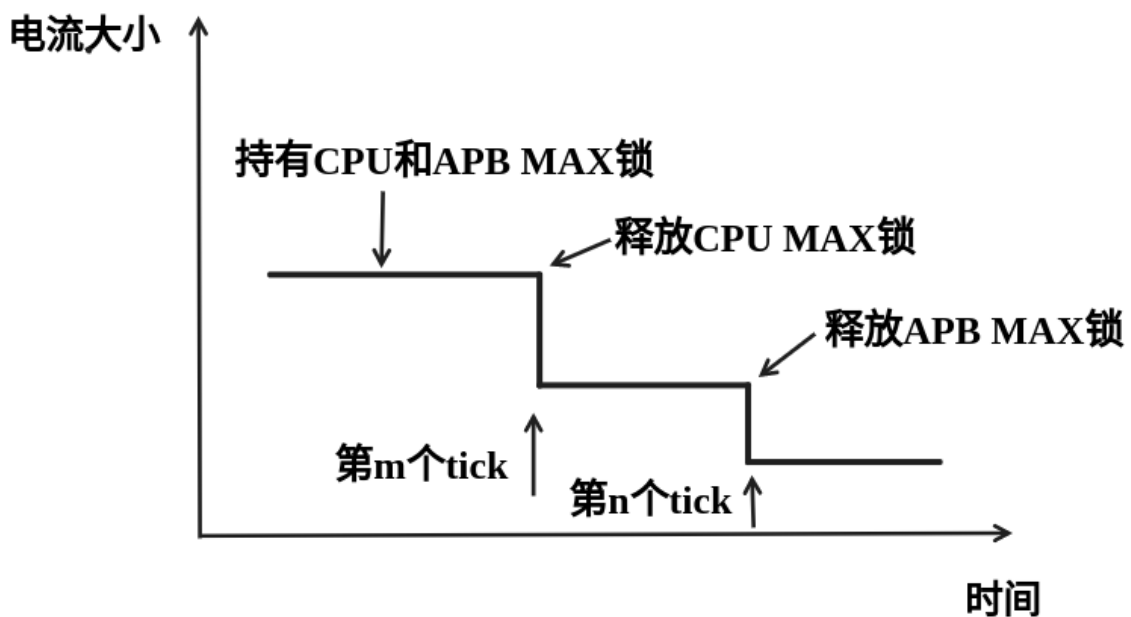
Auto Light-sleep 模式是 ESP-IDF 电源管理机制和 Light-sleep 模式的结合。开启电源管理机制是其前置条件，auto 体现在系统进入空闲状态 (IDLE) 超过设定时间后，自动进入 Light-sleep。空闲状态下，应用程序释放所有电源锁，此时，DFS 将降频以减小功耗。

Auto Light-sleep 依赖于电源管理机制，系统经过提前判断，发现空闲时间超过设定时间时，则直接进入休眠。该过程为自动进行。休眠时会自动关闭 RF、8 MHz 振荡器、40 MHz 高速晶振、PLL、门控数字内核时钟，暂停 CPU 工作。

Auto Light-sleep 模式需配置唤醒源。该模式拥有多种唤醒源，支持相互组合，此时任何一个唤醒源都可以触发唤醒。唤醒后，会从进入休眠的位置继续执行程序。若不配置唤醒源，进入 Light-sleep 休眠后，芯片将一直处在睡眠状态，直到外部复位。具体唤醒源有 RTC 定时器、触摸传感器、外部唤醒 (ext0)、外部唤醒 (ext1)、ULP 协处理器、SDIO、GPIO、UART、Wi-Fi、BT 唤醒等。

Auto Light-sleep 模式工作流程相对复杂，但是进入休眠状态是自动进行，同时需注意在进入前配置好唤醒源，防止芯片一直处在休眠状态。



图 44: Auto Light-sleep 模式工作流程图

根据 Auto Light-sleep 的工作流程可得其理想电流图，关键节点均在图上标出。

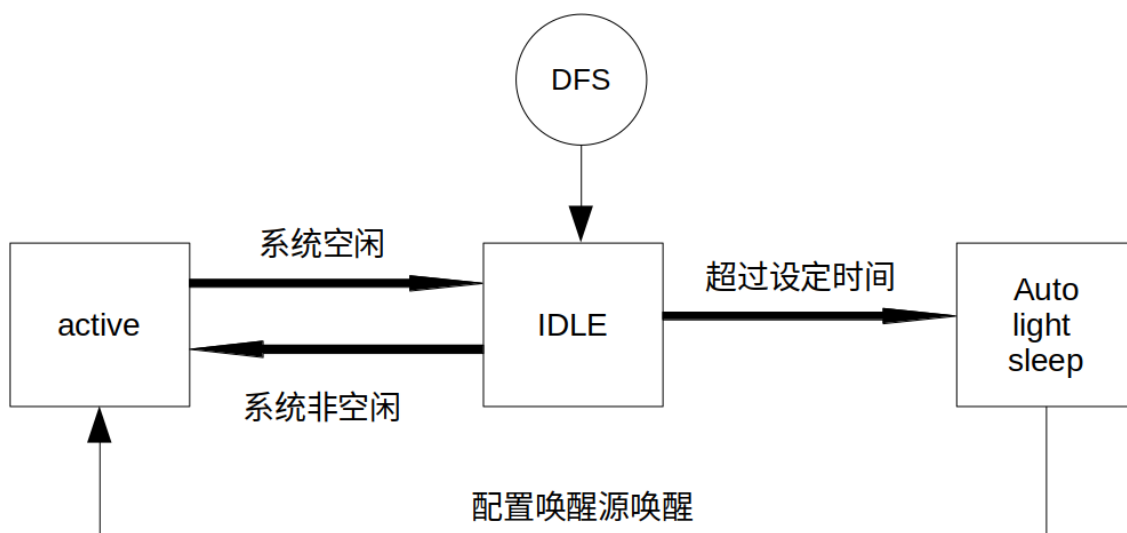

图 45: Auto Light-sleep 模式理想电流图

**备注：**为更加清晰地展现出 Auto Light-sleep 的主要变化，图中省略了 DFS 降频过程。

Auto Light-sleep 模式适用于不需要实时响应外界需求的场景。

## Deep-sleep

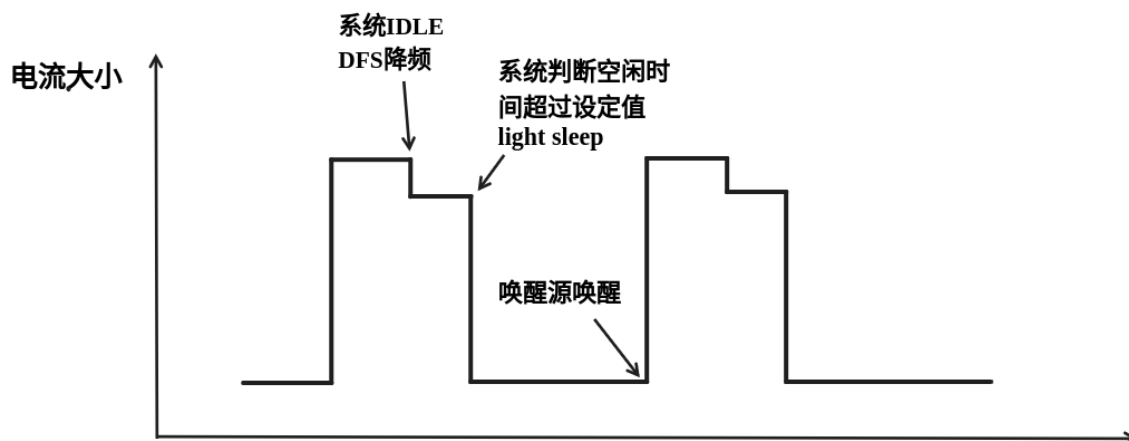
Deep-sleep 模式是为了追求更好的功耗表现所设计，休眠时仅保留 RTC 控制器、RTC 外设（可配置）、ULP 协处理器、RTC 高速内存、RTC 低速内存，其余模块全部关闭。与 Light-sleep 类似，Deep-sleep 同样通过 API 进入，且需要配置唤醒源进行唤醒。

Deep-sleep 通过调用 API 进入，休眠时会关闭除 RTC 控制器、RTC 外设、ULP 协处理器、RTC 高速内存、RTC 低速内存外的所有模块。

Deep-sleep 模式需配置唤醒源，其拥有多种唤醒源，这些唤醒源也可以组合在一起，此时任何一个唤醒源都可以触发唤醒。若不配置唤醒源进入 Deep-sleep 模式，芯片将一直处在睡眠状态，直到外部复位。具体唤醒源有 RTC 定时器、触摸传感器、外部唤醒 (ext0)、外部唤醒 (ext1)、ULP 协处理器、GPIO 唤醒等。

Deep-sleep 模式工作流程如下图所示：



图 46: Deep-sleep 模式工作流程图

Deep-sleep 模式主要应用场景决定了系统很长时间才会苏醒一次，完成工作后又会继续进入 Deep-sleep，所以其理想电流图如下。

Deep-sleep 可以用于低功耗的传感器应用，或是大部分时间都不需要进行数据传输的情况，也就是通常所说的待机模式。设备可以每隔一段时间从 Deep-sleep 状态醒来测量数据并上传，之后重新进入 Deep-sleep；也可以将多个数据存储于 RTC memory，然后一次性发送出去。

## 如何配置纯系统下低功耗模式

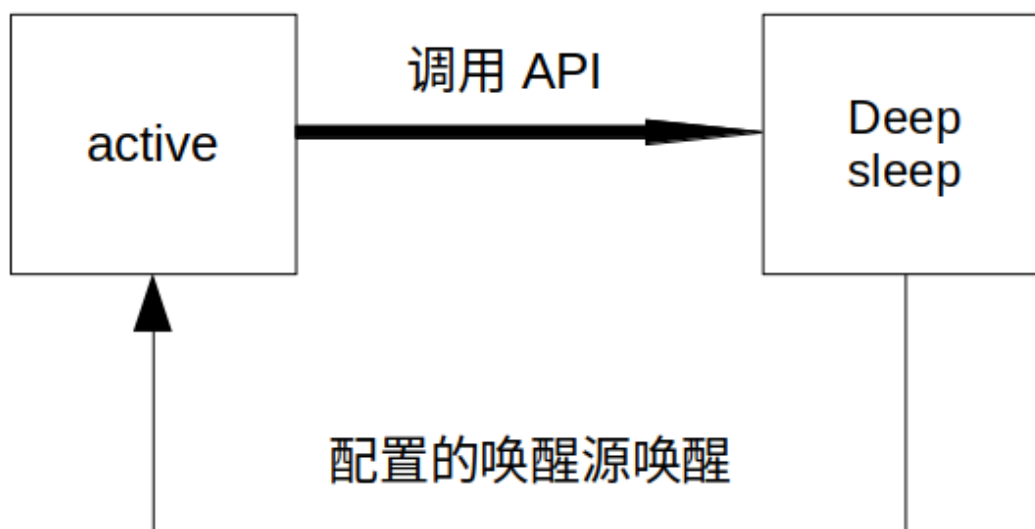
介绍完纯系统下的低功耗模式后，本节将介绍公共配置选项、每种模式独有的配置选项，以及相应低功耗模式 API 的使用说明，同时给出相应模式推荐的配置。

### 公共配置选项

#### DFS 配置

DFS 有如下可配置选项：

- **max\_freq\_mhz** 该参数表示最大 CPU 频率 (MHz)，即 CPU 最高性能工作时候的频率，一般设置为芯片参数的最大值。



图 47: Deep-sleep 模式理想电流图

- **min\_freq\_mhz** 该参数表示最小 CPU 频率 (MHz)，即系统处在空闲状态时 CPU 的工作频率。该字段可设置为晶振 (XTAL) 频率值，或者 XTAL 频率值除以整数。
- **light\_sleep\_enable** 使能该选项，系统将在空闲状态下自动进入 Light-sleep 状态，即 Auto Light-sleep 使能，上文已经具体介绍。

具体配置方法如下：

1. 使能 CONFIG\_PM\_ENABLE
2. 配置 max\_freq\_mhz 和 min\_freq\_mhz，方式如下：

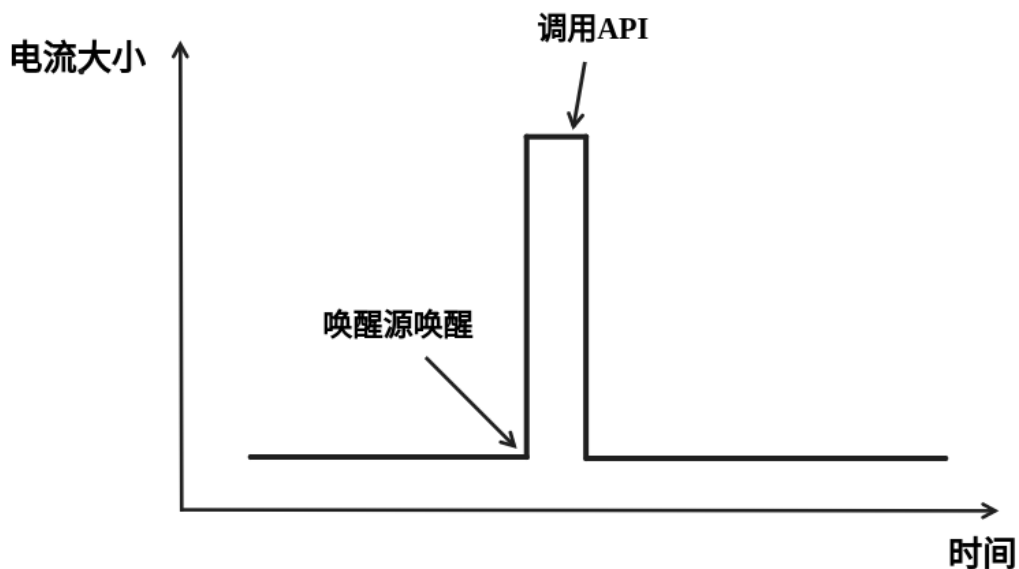
```
esp_pm_config_t pm_config = {
    .max_freq_mhz = CONFIG_EXAMPLE_MAX_CPU_FREQ_MHZ,
    .min_freq_mhz = CONFIG_EXAMPLE_MIN_CPU_FREQ_MHZ,
    .light_sleep_enable = false
};
ESP_ERROR_CHECK(esp_pm_configure(&pm_config));
```

推荐配置：

配置名称	设置情况
CONFIG_PM_ENABLE	ON
RTOS Tick rate (Hz)	1000
max_freq_mhz	160
min_freq_mhz	40
light_sleep_enable	false

**备注：**上表中不涉及的配置均是默认。

### Light-sleep 配置

本节介绍 Auto Light-sleep 的推荐配置和配置步骤。

Auto Light-sleep 有如下可配置选项：



- **Minimum step to enter sleep mode** 该参数表示系统自动进入休眠的阈值。该参数单位为 RTOS Tick，故其表示的时间与 RTOS Tick rate 相关，例该参数值为 3，RTOS Tick rate 配置为 1000 Hz 时，即当系统空闲时间大于等于 3 ms 时进入休眠。
- **Put light sleep related codes in internal RAM** 如果使能该选项，一些 light-sleep 功能将被移至 IRAM，减少代码运行时间，降低系统功耗，IRAM 使用量将增加 1.8 kB。
- **Put RTOS IDLE related codes in internal RAM** 如果使能该选项，一些 RTOS IDLE 功能将被移至 IRAM，减少代码运行时间，降低系统功耗，IRAM 使用量将增加 260 B。
- **RTC slow clock source** 该参数表表示 RTC 慢速时钟源。系统休眠时计时器模块的时钟被门控，此时使用 RTC Timer 进行计时，唤醒后使用 RTC Timer 的计数值对系统时间进行补偿。

时钟源	精度	频偏
Internal 150 kHz OSC	约 6.7 us/cycle	大
External 32 kHz XTAL	约 30.5 us/cycle	小

- **Disable all GPIO when chip at sleep** 如果使能该选项，系统将在休眠过程中禁用所有 GPIO 管脚，消除 GPIO 漏电，降低功耗，但是休眠过程中 GPIO 无法进行信号输入和输出。

唤醒源：

- RTC Timer Wakeup
- GPIO Wakeup
- UART Wakeup
- Touchpad Wakeup
- External Wakeup (ext0)
- External Wakeup (ext1)
- ULP Coprocessor Wakeup

**备注：** 以上仅列出可配置唤醒源，详细介绍请参考[睡眠模式](#)。

配置方法：

1. 配置唤醒源
2. 使能 CONFIG\_PM\_ENABLE
3. 使能 CONFIG\_FREERTOS\_USE\_TICKLESS\_IDLE
4. 配置 DFS 参数
5. light\_sleep\_enable = true，具体如下：

```
esp_pm_config_t pm_config = {
    .max_freq_mhz = CONFIG_EXAMPLE_MAX_CPU_FREQ_MHZ,
    .min_freq_mhz = CONFIG_EXAMPLE_MIN_CPU_FREQ_MHZ,
    #if CONFIG_FREERTOS_USE_TICKLESS_IDLE
    .light_sleep_enable = true
    #endif
};
ESP_ERROR_CHECK(esp_pm_configure(&pm_config));
```

6. 配置介绍的其余相关参数

推荐配置：

### Deep-sleep 配置

对 Deep-sleep 模式来说，除了唤醒源相关配置，其余配置意义已经不大。

Deep-sleep 有如下可配置选项：

- RTC Timer wakeup
- EXT0/1 wakeup
- Touchpad wakeup
- ULP wakeup





```

\      |PHY      |--antenna_select[0] --> | Matrix |--GPIO[x3] --> ant_
↔sel_in[3]--|_____| --- antenna 15
      \_____|Antenna 1|--antenna_select[1] --> |      |
           |Module  |--antenna_select[2] --> |      |
           |_____|--antenna_select[3] --> |_____|

```

ESP32-H2 多根天线功能主要包含 3 个部分：芯片内部的 PHY 天线模块、IO MUX 和 GPIO Matrix、以及外部的天线切换器。

1. 芯片内部的天线选择模块 PHY Antenna Module：- 两个天线模块均支持工作于发送 (TX) 或接收 (RX) 模式，可以通过软件配置发送和接收选用某个模块。- 每个天线模块最多支持输出 4 个天线选择信号 `antenna_select[3:0]`，该信号值可由软件配置并且可以一一映射到任意 IO 引脚。- 当某个天线模块处于工作状态时，IO 引脚的高低电平值为软件配置的信号值。

2. IO MUX 和 GPIO Matrix：- 将内部 4 路天线信号输出到具体的 IO 引脚上。

3. 外部的天线切换器：- 一般为多路选择器，通过 `ant_sel_in[x]` 引脚的电平，选择工作的天线，例如 `ant_sel_in[3:0]` 为“0b1011”，表示选中天线 11。

### 多根天线使用步骤

1. 根据硬件电路设计及外部天线切换器确定用于控制天线切换的 IO 引脚。

2. 配置天线选择信号输出到指定 IO 引脚 - API `esp_phy_set_ant_gpio()` 用于配置 `antenna_selects[3:0]` 信号连接 `GPIO[x3:x0]`。如果 `GPIO[x0]` 连接到 `antenna_select[0]`，`gpio_config->gpio_cfg[x0].gpio_select` 应设置为 1，且 `gpio_config->gpio_cfg[x0].gpio_num` 的值为 `GPIO[x0]`。

3. 配置内部天线工作模式及输出信号 - API `esp_phy_set_ant()` 用于配置发送或接收时使用内部天线模块 0 或 1，并配置当天线模块 0 或 1 工作时的输出信号值。- 对于 `ESP_PHY_ANT_MODE_AUTO` 模式目前不推荐使用。

### 多根天线配置参考例子

通常，可以执行以下步骤来配置多根天线：

- 配置 `antenna_selects` 连接哪些 GPIOs，例如，如果支持四根天线，且 `GPIO20/GPIO21` 连接到 `antenna_select[0]/antenna_select[1]`，配置如下所示：

```

esp_phy_ant_gpio_config_t ant_gpio_config = {
    .gpio_cfg[0] = { .gpio_select = 1, .gpio_num = 20 },
    .gpio_cfg[1] = { .gpio_select = 1, .gpio_num = 21 }
};

```

- 配置使能哪些天线、以及接收/发送数据如何使用使能的天线，例如，如果使能了天线 1 和天线 3，接收数据需要自动选择较好的天线，并将天线 1 作为默认天线，发送数据始终选择天线 3。配置如下所示：

```

esp_phy_ant_config_t config = {
    .rx_ant_mode = ESP_PHY_ANT_MODE_AUTO,
    .rx_ant_default = ESP_PHY_ANT_ANT0,
    .tx_ant_mode = ESP_PHY_ANT_MODE_ANT1,
    .enabled_ant0 = 1,
    .enabled_ant1 = 3
};

```

### 注意事项

1. 不同天线切换器，`ant_sel_in[3:0]` 的输入值中可能存在非法值，即 ESP32-H2 通过外部天线开关支持的天线数可能小于 16 根。例如，ESP32-WROOM-DA 使用 RTC6603SP 作为天线切换器，仅支持 2 根天线。

两个天线选择输入管脚为高电平有效，连接到两个 GPIO。'0b01' 表示选中天线 0，'0b10' 表示选中天线 1。输入值'0b00' 和'0b11' 为非法值。

2. 尽管最多支持 16 根天线，发送和接收数据时，最多仅能同时使能两根天线。

3. 对于 `ESP_PHY_ANT_MODE_AUTO` 模式目前不推荐使用，主要有以下限制情况需要考虑：

- 因为发送数据天线基于 `ESP_PHY_ANT_MODE_AUTO` 类型的接收数据天线选择算法，只有接收数据的天线模式为 `ESP_PHY_ANT_MODE_AUTO` 时，发送数据天线才能设置为 `ESP_PHY_ANT_MODE_AUTO`。
- 接收或者发送天线模式配置为 `ESP_PHY_ANT_MODE_AUTO` 时，只要存在 RF 信号的恶化，很容易触发天线切换。如果射频信号不稳定，天线会频繁切换，使得总的射频性能无法达到预期效果。

### 推荐在以下场景中使用多根天线

1. 应用程序可以始终选择指定的天线，也可以执行自身天线选择算法，如根据应用程序收集的信息来选择天线模式等。请参考 IDF 示例 [examples/phy/antenna/README.md](#) 来设计天线选择算法。

2. 接收/发送数据的天线模式均配置为 `ESP_PHY_ANT_MODE_ANT0` 或 `ESP_PHY_ANT_MODE_ANT1`。



# Chapter 5

## 迁移指南

### 5.1 迁移到 ESP-IDF 5.x

#### 5.1.1 从 4.4 迁移到 5.0

##### 低功耗蓝牙

##### Bluetooth

以下 Bluetooth 宏、类型和函数已被重命名：

- `bt/host/bluetooth/api/include/api/esp_gap_ble_api.h`
  - `esp_gap_ble_cb_event_t` 中：
    - \* `ESP_GAP_BLE_SET_PREFERED_DEFAULT_PHY_COMPLETE_EVT` 改名为 `ESP_GAP_BLE_SET_PREFERRED_DEFAULT_PHY_COMPLETE_EVT`
    - \* `ESP_GAP_BLE_SET_PREFERED_PHY_COMPLETE_EVT` 改名为 `ESP_GAP_BLE_SET_PREFERRED_PHY_COMPLETE_EVT`
    - \* `ESP_GAP_BLE_CHANNEL_SELETE_ALGORITHM_EVT` 改名为 `ESP_GAP_BLE_CHANNEL_SELECT_ALGORITHM_EVT`
  - `esp_ble_wl_opration_t` 改名为 `esp_ble_wl_operation_t`
  - `esp_ble_gap_cb_param_t.pkt_data_lenth_cmpl` 改名为 `pkt_data_length_cmpl`
  - `esp_ble_gap_cb_param_t.update_whitelist_cmpl.wl_opration` 改名为 `wl_operation`
  - `esp_ble_gap_set_prefered_default_phy` 改名为 `esp_ble_gap_set_preferred_default_phy()`
  - `esp_ble_gap_set_prefered_phy` 改名为 `esp_ble_gap_set_preferred_phy()`
- `bt/host/bluetooth/api/include/api/esp_gatt_defs.h`
  - `esp_gatt_status_t` 中：
    - \* `ESP_GATT_ENCRYPED_MITM` 改名为 `ESP_GATT_ENCRYPTED_MITM`
    - \* `ESP_GATT_ENCRYPED_NO_MITM` 改名为 `ESP_GATT_ENCRYPTED_NO_MITM`

## Nimble

以下 Nimble API 已被移除：

- [bt/host/nimble/esp-hci/include/esp\\_nimble\\_hci.h](#)
  - 移除 `esp_err_t esp_nimble_hci_and_controller_init(void)`
    - \* 控制器初始化、使能以及 HCI 初始化的调用已经被移到 `nimble_port_init` 中。可直接删除该函数。
  - 移除 `esp_err_t esp_nimble_hci_and_controller_deinit(void)`
    - \* 控制器去初始化、禁用以及 HCI 去初始化的调用已经被移到 `nimble_port_deinit` 中。可直接删除该函数。

## ESP-BLE-MESH

以下 ESP-BLE-MESH 宏已被重命名：

- [bt/esp\\_ble\\_mesh/api/esp\\_ble\\_mesh\\_defs.h](#)
  - `esp_ble_mesh_prov_cb_event_t` 中：
    - \* `ESP_BLE_MESH_PROVISIONER_DRIECT_ERASE_SETTINGS_COMP_EVT` 改名为 `ESP_BLE_MESH_PROVISIONER_DIRECT_ERASE_SETTINGS_COMP_EVT`

## 迁移构建系统至 ESP-IDF v5.0

**从 GNU Make 构建系统迁移至 ESP-IDF v5.0** ESP-IDF v5.0 已不再支持基于 Make 的工程，请参考从 [ESP-IDF GNU Make 构建系统迁移到 CMake 构建系统](#) 进行迁移。

**更新片段文件语法** ESP-IDF v5.0 中将不再支持 ESP-IDF v3.x 中链接器脚本片段文件的旧式语法。在迁移的过程中需注意以下几点：

- 必须缩进，缩进不当的文件会产生解析异常；旧版本不强制缩进，但之前的文档和示例均遵循了正确的缩进语法。
- 条件改用 `if...elif...else` 结构，可以参照[之前的章节](#)。
- 映射片段和其他片段类型一样，需有名称。

**明确指定组件依赖** 在之前的 ESP-IDF 版本中，除了[通用组件依赖项](#)，还有一些组件总是作为公共依赖项，在构建时添加至每个组件中，如：

- driver
- efuse
- esp\_timer
- lwip
- vfs
- esp\_wifi
- esp\_event
- esp\_netif
- esp\_eth
- esp\_phy

这意味着可以直接包含这些组件的头文件，而无需在 `idf_component_register` 中将它们指定为依赖。此行为是由各种常见组件的传递依赖关系引起的。

在 ESP-IDF v5.0 中，此行为已修复，这些组件不再默认作为公共依赖项添加。

如果组件所依赖的某个组件不属于通用组件依赖项，则必须显式地声明此依赖关系。可以通过在组件的 `CMakeLists.txt` 中的 `idf_component_register` 调用中添加 `REQUIRES <component_name>` 或 `PRIV_REQUIRES <component_name>` 来完成。有关指定组件依赖的更多信息，请参阅[组件依赖](#)。

**设置 COMPONENT\_DIRS 和 EXTRA\_COMPONENT\_DIRS 变量** 为了实现构建项目时的路径能够包含空格，ESP-IDF v5.0 做了一系列改进，其中包括改进了 CMakeLists.txt 文件中的 COMPONENT\_DIRS 和 EXTRA\_COMPONENT\_DIRS 变量。

ESP-IDF v5.0 版本中，不再支持添加不存在的目录到变量 COMPONENT\_DIRS 或 EXTRA\_COMPONENT\_DIRS 中，否则会出现报错。

同时，ESP-IDF v5.0 中也不再支持使用字符串拼接的方式定义 COMPONENT\_DIRS 或 EXTRA\_COMPONENT\_DIRS 变量。这些变量应该定义为 CMake 列表。例如：

```
set(EXTRA_COMPONENT_DIRS path1 path2)
list(APPEND EXTRA_COMPONENT_DIRS path3)
```

不支持：

```
set(EXTRA_COMPONENT_DIRS "path1 path2")
set(EXTRA_COMPONENT_DIRS "${EXTRA_COMPONENT_DIRS} path3")
```

将这些变量定义为 CMake 列表的方式兼容之前的 ESP-IDF 版本。

**更新 target\_link\_libraries 用法** ESP-IDF v5.0 修复了组件的 CMake 变量传播问题。此问题导致本应该只应用于某一组件的编译器标志和定义应用到了项目中的每个组件。

该修复也带来一定的副作用，从 ESP-IDF v5.0 开始，用户项目在使用 target\_link\_libraries 时必须明确指定 project\_elf，同时自定义 CMake 项目必须指定 PRIVATE、PUBLIC 或 INTERFACE 参数。这是一项重大变更，不兼容以前的 ESP-IDF 版本。

例如：

```
target_link_libraries(${project_elf} PRIVATE "-Wl,--wrap=esp_panic_handler")
```

不支持：

```
target_link_libraries(${project_elf} "-Wl,--wrap=esp_panic_handler")
```

**更新 CMake 版本** 在 ESP-IDF v5.0 中，最低 CMake 版本已更新到 3.16，并且不再支持低于 3.16 的版本。如果你的操作系统没有安装 CMake，请运行 tools/idf\_tools.py install cmake 来安装合适的版本。

该变更会影响到使用系统提供的 CMake 以及自定义 CMake 的 ESP-IDF 用户。

**重新定义特定目标配置文件的应用顺序** ESP-IDF v5.0 重新安排了特定目标配置文件和 SDKCONFIG\_DEFAULTS 中所有其他文件的应用顺序。现在，特定目标的配置文件将在引入它的文件之后、在 SDKCONFIG\_DEFAULTS 中后续的其他文件之前应用。

例如：

```
如果 ``SDKCONFIG_DEFAULTS="sdkconfig.defaults;sdkconfig_devkit1
↳ ``，且同一文件夹内有 ``sdkconfig.defaults.esp32``
↳ 文件，那么文件的应用顺序为：(1) sdkconfig.defaults (2) sdkconfig.defaults.esp32
↳ (3) sdkconfig_devkit1
```

如果某个键在不同的特定目标配置文件中有不同的值，那么后者的值会覆盖前者。例如在以上案例中，如果某个键在 sdkconfig.defaults.esp32 和 sdkconfig\_devkit1 中的值不同，则在 sdkconfig\_devkit1 中的值会覆盖在 sdkconfig.defaults.esp32 中的值。

如果确实需要设置特定目标的配置值，请将其放到后应用的特定目标文件中，如 sdkconfig\_devkit1.esp32。

## GCC

**GCC 版本** ESP-IDF 之前使用的 GCC 版本为 8.4.0，现已针对所有芯片目标升级至 GCC 11.2.0。若需要将代码从 GCC 8.4.0 迁移到 GCC 11.2.0，请参考以下官方 GCC 迁移指南。

- [迁移至 GCC 9](#)
- [迁移至 GCC 10](#)
- [迁移至 GCC 11](#)

**警告** 升级至 GCC 11.2.0 后会触发新警告，或是导致原有警告内容发生变化。所有 GCC 警告的详细内容，请参考 [GCC 警告选项](#)。建议用户仔细检查代码，并设法解决这些警告。但由于某些警告的特殊性及用户代码的复杂性，有些警告可能为误报，需要进行关键修复。在这种情况下，用户可以采取多种方式来抑制这些警告。本节介绍了用户可能遇到的常见警告及如何抑制这些警告。

**注意：** 建议用户在抑制警告之前仔细确认该警告是否确实为误报。

**-Wstringop-overflow、-Wstringop-overread、-Wstringop-truncation 和 -Warray-bounds** 如果编译器不能准确判断内存或字符串的大小，使用 memory/string copy/compare 函数的用户会遇到某种 -Wstringop 警告。下文展示了触发这些警告的代码，并介绍了如何抑制这些警告。

```
#pragma GCC diagnostic push
#pragma GCC diagnostic ignored "-Wstringop-overflow"
#pragma GCC diagnostic ignored "-Warray-bounds"
    memset(RTC_SLOW_MEM, 0, CONFIG_ULP_COPROC_RESERVE_MEM); // <<-- 此行触发了警告
#pragma GCC diagnostic pop
```

```
#pragma GCC diagnostic push
#if __GNUC__ >= 11
#pragma GCC diagnostic ignored "-Wstringop-overread" // <<-- 此键从 GCC 11 开始引入
#endif
#pragma GCC diagnostic ignored "-Warray-bounds" (-Warray-bounds) 。
    memcpy(backup_write_data, (void *)EFUSE_PGM_DATA0_REG, sizeof(backup_
↳write_data)); // <<-- 此行触发了警告
#pragma GCC diagnostic pop
```

**-Waddress-of-packed-member** 当访问打包 struct 中的某个未对齐成员时，由于非对齐内存访问会对性能产生影响，GCC 会触发 -Waddress-of-packed-member 警告。然而，所有基于 Xtensa 或 RISC-V 架构的 ESP 芯片都允许非对齐内存访问，并且不会产生额外的性能影响。因此，在大多数情况下，可以忽略此问题。

```
components/bt/host/bluedroid/btc/profile/std/gatt/btc_gatt_util.c: In function
↳'btc_to_bta_gatt_id':
components/bt/host/bluedroid/btc/profile/std/gatt/btc_gatt_util.c:105:21: warning:↳
↳taking address of packed member of 'struct <anonymous>' may result in an↳
↳unaligned pointer value [-Waddress-of-packed-member]
   105 |         btc_to_bta_uuid(&p_dest->uuid, &p_src->uuid);
       |         ^~~~~~
```

如果该警告在多个源文件中多次出现，可以在 CMake 级别抑制该警告，如下所示。





## 网络

### Wi-Fi

**回调函数类型 `esp_now_recv_cb_t`** 此前 `esp_now_recv_cb_t` 的第一个参数的类型是 `const uint8_t *mac_addr`，该参数只包含对端 ESP-NOW 设备的地址。

现在该函数有所更新。第一个参数的类型变更为 `esp_now_recv_info_t`，它包含三个成员变量 `src_addr`，`des_addr` 和 `rx_ctrl`。因此，需要进行如下更新：

- 重新定义的 ESP-NOW 收包回调函数。
- `src_addr` 可以等价替换原来的 `mac_addr`。
- `des_addr` 是 ESP-NOW 包的目的地 MAC 地址，可以是单播或广播地址。使用 `des_addr` 可以区分单播或广播的 ESP-NOW 包，其中，即使是在加密的 ESP-NOW 配置中，广播的 ESP-NOW 包也可以是非加密的。
- `rx_ctrl` 是 ESP-NOW 包的 Rx control info，它包含此包的更多有用信息。

请参考 ESP-NOW 样例：[wifi/espnow/main/espnow\\_example\\_main.c](#)

### 以太网

**`esp_eth_ioctl()` API** 此前，`esp_eth_ioctl()` API 存在以下问题：

- 在某些情况下，第三个参数（数据类型为 `void /*`）可以接受 `int/bool` 类型实参（而非指针）作为输入。然而，文档中未描述这些情况。
- 为了将 `int/bool` 类型实参作为第三个参数传递，实参将强制转换为 `void *` 类型，以防出现如下所示的编译器警告。此等转换可能引起 `esp_eth_ioctl()` 函数的滥用。

```
esp_eth_ioctl(eth_handle, ETH_CMD_S_FLOW_CTRL, (void *)true);
```

因此，我们统一了 `esp_eth_ioctl()` 的用法。现在，该结构体的第三个参数在传递时必须作为指向特定数据类型的指针，表示 `esp_eth_ioctl()` 读取/存储数据的位置。`esp_eth_ioctl()` 的用法如下列代码所示。

设置以太网配置的用例如下：

```
eth_duplex_t new_duplex_mode = ETH_DUPLEX_HALF;
esp_eth_ioctl(eth_handle, ETH_CMD_S_DUPLEX_MODE, &new_duplex_mode);
```

获取以太网配置的用例如下：

```
eth_duplex_t duplex_mode;
esp_eth_ioctl(eth_handle, ETH_CMD_G_DUPLEX_MODE, &duplex_mode);
```

**KSZ8041/81 和 LAN8720 驱动更新** KSZ8041/81 和 LAN8720 驱动现已更新，以支持相关产品系列中的更多设备（如新一代设备）。上述驱动能够识别特定芯片编号及驱动提供的潜在支持。

更新之后，通用函数将替代特定“芯片编号”函数得以调用：

- 删除 `esp_eth_phy_new_ksz8041()` 以及 `esp_eth_phy_new_ksz8081()`，转而使用 `esp_eth_phy_new_ksz80xx()`
- 删除 `esp_eth_phy_new_lan8720()`，转而使用 `esp_eth_phy_new_lan87xx()`

**ESP NETIF Glue 时间处理程序** `esp_eth_set_default_handlers()` 和 `esp_eth_clear_default_handlers()` 函数现已删除。现在可以自动处理以太网默认 IP 层处理程序的注册。如果在注册以太网/IP 事件处理程序之前，你已经按照建议，完全初始化以太网驱动和网络接口，则无需执行任何操作（除了删除受影响的函数）。否则，在注册用户事件处理程序后，应随即启动以太网驱动。

**PHY 地址自动检测** 以太网 PHY 地址自动检测函数 `esp_eth_detect_phy_addr()` 已重命名为 `esp_eth_phy_802_3_detect_phy_addr()`，其声明移至 `esp_eth/include/esp_eth_phy_802_3.h`。

**SPI 以太网模块初始化** SPI 以太网模块的初始化过程已经简化。此前，你需要在实例化 SPI 以太网 MAC 之前，使用 `spi_bus_add_device()` 手动分配 SPI 设备。

现在，SPI 设备已在内部分配，因此无需再调用 `spi_bus_add_device()`。`eth_dm9051_config_t`、`eth_w5500_config_t` 和 `eth_ksz8851snl_config_t` 配置结构体现已包含 SPI 设备配置成员（例如，可以微调可能依赖 PCB 设计的 SPI 时序）。`ETH_DM9051_DEFAULT_CONFIG`、`ETH_W5500_DEFAULT_CONFIG` 和 `ETH_KSZ8851SNL_DEFAULT_CONFIG` 配置初始化宏也已接受新的参数输入。了解 SPI 以太网模块初始化示例，请查看[以太网 API 参考指南](#)。

**Ethernet 驱动** 用于创建 MAC 实例的 API (`esp_eth_mac_new_*`) 的输入参数由一个配置参数改为两个，这两个参数用于

- 供应商特定的 MAC 配置
- Ethernet 驱动 MAC 配置

该更新不仅适用于内部 Ethernet MAC `esp_eth_mac_new_esp32()` 也适用于外部 MAC 设备，如 `esp_eth_mac_new_ksz8851snl()`、`esp_eth_mac_new_dm9051()` 和 `esp_eth_mac_new_w5500()`。

**TCP/IP 适配器** TCP/IP 适配器是在 ESP-IDF v4.1 之前使用的网络接口抽象组件。本文档概述了从 `tcpip_adapter` API 迁移至 *ESP-NETIF* 的过程。

## 更新网络连接代码

### 网络软件栈初始化

- 你只需用 `esp_netif_init()` 替换 `tcpip_adapter_init()`，注意 `esp_netif_init()` 函数现将返回标准错误代码。了解详细信息，请参考[ESP-NETIF](#)。
- `esp_netif_deinit()` 函数用于反初始化网络软件栈。
- 你还需用 `#include "esp_netif.h"` 替换 `#include "tcpip_adapter.h"`。

**创建网络接口** 更新之前，TCP/IP 适配器静态定义了以下三个接口：

- Wi-Fi Station
- Wi-Fi AP
- 以太网

接口定义现已更新。网络接口的设计应严格参考[ESP-NETIF](#)，使其能够连接至 TCP/IP 软件栈。例如，在 TCP/IP 软件栈和事件循环初始化完成后，Wi-Fi 的初始化代码必须显示调用 `esp_netif_create_default_wifi_sta()`；或 `esp_netif_create_default_wifi_ap()`；。

请参考上述三个接口的初始化代码示例：

- Wi-Fi Station: [wifi/getting\\_started/station/main/station\\_example\\_main.c](#)
- Wi-Fi AP: [wifi/getting\\_started/softAP/main/softap\\_example\\_main.c](#)
- 以太网: [ethernet/basic/main/ethernet\\_example\\_main.c](#)

**其他 tcpip\_adapter API 更换** 所有 tcpip\_adapter 函数都有对应的 esp-netif。请参考以下章节中的 esp\_netif.h 部分，了解更多信息：

- [Setters/Getters](#)
- [DHCP](#)
- [DNS](#)
- [IP address](#)

TCP/IP 适配器 API tcpip\_adapter\_get\_sta\_list() 用于获取与软件接入点 (softAP) 相关联的 Wi-Fi 站点列表，现已移到 Wi-Fi 组件，并更名为 esp\_wifi\_ap\_get\_sta\_list\_with\_ip()，它是 ESP-NETIF API [esp\\_netif\\_dhcps\\_get\\_clients\\_by\\_mac\(\)](#) 一个特例。无论服务器在哪个网络接口上运行，该 API 都可更方便地提供连接到 DHCP 服务器的客户端列表。

**默认事件处理程序** 事件处理程序已从 tcpip\_adapter 移至相应驱动程序代码。从应用程序的角度来看，这一变更不会产生任何影响，所有事件仍将以相同的方式处理。请注意，在与 IP 相关的事件处理程序中，应用程序代码通常以 esp-netif 结构体而非 LwIP 结构体的形式接收 IP 地址。两种结构体均兼容二进制格式。

打印地址的首选方式如下所示：

```
ESP_LOGI(TAG, "got ip:" IPSTR, IP2STR(&event->ip_info.ip));
```

不建议使用下述方式：

```
ESP_LOGI(TAG, "got ip:%s", ip4addr_ntoa(&event->ip_info.ip));
```

ip4addr\_ntoa() 为 LwIP API，因此 esp-netif 还提供了替代函数 esp\_ip4addr\_ntoa()，然而总得来说仍推荐使用 IP2STR() 这一方法。

**IP 地址** 推荐使用 esp-netif 定义的 IP 结构。请注意，在启用默认兼容性时，LwIP 结构体仍然可以工作。

- [esp-netif IP address definitions](#)

## 外设

**外设时钟门控** 与更新之前相同，外设的时钟仍由驱动处理，用户无需对外设模块的时钟门控进行设置。但是，如果用户想基于组件 hal 和 soc 开发自己的驱动，请注意时钟门控的头文件引用路径已由 driver/periph\_ctrl.h 更新为 esp\_private/periph\_ctrl.h。

**RTC 子系统控制** RTC 控制 API 已经从 driver/rtc\_ctrl.h 移动到了 esp\_private/rtc\_ctrl.h。

## ADC

**ADC 单次模式及连续模式驱动** ADC 单次模式的驱动已更新。

- 新的驱动位于组件 esp\_adc 中，头文件引用路径为 esp\_adc/adc\_oneshot.h。
- 旧版驱动仍然可用，其头文件引用路径为 driver/adc.h。

对于 ADC 连续模式驱动，其位置已由组件 driver 更新为 esp\_adc。

- 头文件引用路径由 driver/adc.h 更新为 esp\_adc/adc\_continuous.h。

但是，引用两种模式的旧版路径 `driver/adc.h` 会默认触发如下编译警告，可通过配置 `Kconfig` 选项 `CONFIG_ADC_SUPPRESS_DEPRECATED_WARN` 关闭该警告。

```
legacy adc driver is deprecated, please migrate to use esp_adc/adc_oneshot.h and
↳ esp_adc/adc_continuous.h for oneshot mode and continuous mode drivers
↳ respectively
```

### ADC 校准驱动 ADC 校准驱动已更新。

- 新的驱动位于组件 `esp_adc` 中，头文件引用路径为 `esp_adc/adc_cali.h` 和 `esp_adc/adc_cali_scheme.h`。

旧版驱动仍然可用，其头文件引用路径为 `esp_adc_cal.h`。如果用户要使用旧版路径，需要将组件 `esp_adc` 添加到文件 `CMakeLists.txt` 的组件需求表中。

默认情况下，引用路径 `esp_adc_cal.h` 会默认触发如下编译警告，可通过配置 `Kconfig` 选项 `CONFIG_ADC_CALI_SUPPRESS_DEPRECATED_WARN` 关闭该警告。

```
legacy adc calibration driver is deprecated, please migrate to use esp_adc/adc_
↳ cali.h and esp_adc/adc_cali_scheme.h
```

### API 更新

- ADC 电源管理 API `adc_power_acquire` 和 `adc_power_release` 已被移至 `esp_private/adc_share_hw_ctrl.h`，用于内部功能。
  - 更新前，由于硬件勘误表的工作原理，这两个 API 可以被用户调用。
  - 更新后，ADC 电源管理完全由驱动在内部实现。
  - 如果用户仍需调用这个 API，可以通过引用路径 `esp_private/adc_share_hw_ctrl.h` 来调用它。
- 更新后，`driver/adc2_wifi_private.h` 已被移至 `esp_private/adc_share_hw_ctrl.h`。
- `adc_unit_t` 中的枚举 `ADC_UNIT_BOTH`，`ADC_UNIT_ALTER` 及 `ADC_UNIT_MAX` 已被删除。
- 由于只有部分芯片支持下列枚举的某些取值，因此将下列枚举删除。如果用户使用了不支持的取值，会造成驱动运行错误。
  - 枚举 `ADC_CHANNEL_MAX`
  - 枚举 `ADC_ATTEN_MAX`
  - 枚举 `ADC_CONV_UNIT_MAX`
- ESP32 中的 API `hall_sensor_read` 已被删除，因此 ESP32 不再支持霍尔传感器。
- API `adc_set_i2s_data_source` 和 `adc_i2s_mode_init` 已被弃用，相关的枚举 `adc_i2s_source_t` 也已被弃用，请使用 `esp_adc/adc_continuous.h` 进行迁移。
- API `adc_digi_filter_reset`，`adc_digi_filter_set_config`，`adc_digi_filter_get_config` 和 `adc_digi_filter_enable` 已被移除。这些接口的行为不被保证。枚举 `adc_digi_filter_idx_t`，`adc_digi_filter_mode_t` 和结构体 `adc_digi_iir_filter_t` 已被移除。
- API `esp_adc_cal_characterize` 已被弃用，请迁移到 `adc_cali_create_scheme_curve_fitting` 或 `adc_cali_create_scheme_line_fitting`。
- API `esp_adc_cal_raw_to_voltage` 已被弃用，请迁移到 `adc_cali_raw_to_voltage`。
- API `esp_adc_cal_get_voltage` 已被弃用，请迁移到 `adc_oneshot_get_calibrated_result`。

### GPIO

- 之前的 `Kconfig` 选项 `RTCIO_SUPPORT_RTC_GPIO_DESC` 已被删除，因此数组 `rtc_gpio_desc` 已不可用，请使用替代数组 `rtc_io_desc`。
- 更新后，用户回调函数无法再通过读取 GPIO 中断的状态寄存器来获取用于触发中断的 GPIO 管脚的编号。但是，用户可以通过使用回调函数变量来确定该管脚编号。
  - 更新前，GPIO 中断发生时，GPIO 中断状态寄存器调用用户回调函数之后，会被清空。因此，用户可以在回调函数中读取 GPIO 中断状态寄存器，以便确定触发中断的 GPIO 管脚。
  - 但是，在调用回调函数后清空中断状态寄存器可能会导致边沿触发的中断丢失。例如，在调用用户回调函数时，如果某个边沿触发的中断 (re) 被触发，该中断会被清除，并且其注册的用户回调函数还未被处理。

- 更新后，GPIO 的中断状态寄存器在调用用户回调函数 **之前** 被清空。因此，用户无法读取 GPIO 中断状态寄存器来确定哪个管脚触发了中断。但是，用户可以通过回调函数变量来传递被触发的管脚编号。

**Sigma-Delta 调制器** Sigma-Delta 调制器的驱动现已更新为 *SDM*。

- 新驱动中实现了工厂模式，SDM 通道都位于内部通道池中，因此用户无需手动将 SDM 通道配置到 GPIO 管脚。
- SDM 通道会被自动分配。

尽管我们推荐用户使用新的驱动 API，旧版驱动仍然可用，位于头文件引用路径 `driver/sigmadelat.h` 中。但是，引用 `driver/sigmadelat.h` 会默认触发如下编译警告，可通过配置 Kconfig 选项 `CONFIG_SDM_SUPPRESS_DEPRECATED_WARN` 关闭该警告。

```
The legacy sigma-delta driver is deprecated, please use driver/sdm.h
```

概念与使用方法上的主要更新如下所示：

### 主要概念更新

- SDM 通道名称已由 `sigmadelta_channel_t` 更新为 `sdm_channel_handle_t`，后者为一个不透明指针。
- SDM 通道配置原来存放于 `sigmadelta_config_t`，现存放于 `sdm_config_t`。
- 旧版驱动中，用户无需为 SDM 通道设置时钟源。但是在新驱动中，用户需要在 `sdm_config_t::clk_src` 为 SDM 通道设置合适的时钟源，`soc_periph_sdm_clk_src_t` 中列出了可用的时钟源。
- 旧版驱动中，用户需要为通道设置 `prescale`，该参数会影响调制器输出脉冲的频率。在新的驱动中，用户需要使用 `sdm_config_t::sample_rate_hz` 实现该功能。
- 旧版驱动中，用户通过设置 `duty` 来改变输出的模拟量，现在换成了一个更贴切的名字 `density`

### 主要使用方法更新

- 更新前，通道配置由通道分配在 `sdm_new_channel()` 完成。在新驱动中，只有 `density` 可在运行时由 `sdm_channel_set_pulse_density()` 更新。其他参数如 `gpio number`、`prescale` 只能在通道分配时进行设置。
- 在进行下一步通道操作前，用户应通过调用 `sdm_channel_enable()` 提前 **使能** 该通道。该函数有助于管理一些系统级服务，如 **电源管理**。

**定时器组驱动** 为统一和简化通用定时器的使用，定时器组驱动已更新为 *GPTimer*。

尽管我们推荐使用新的驱动 API，旧版驱动仍然可用，其头文件引用路径为 `driver/timer.h`。但是，引用 `driver/timer.h` 会默认触发如下编译警告，可通过配置 Kconfig 选项 `CONFIG_GPTIMER_SUPPRESS_DEPRECATED_WARN` 关闭该警告。

```
legacy timer group driver is deprecated, please migrate to driver/gptimer.h
```

概念和使用方法上的主要更新如下所示：

### 主要概念更新

- 用于识别定时器的 `timer_group_t` 和 `timer_idx_t` 已被删除。在新驱动中，定时器用参数 `gptimer_handle_t` 表示。
- 更新后，定时器的时钟源由 `gptimer_clock_source_t` 定义，之前的时钟源参数 `timer_src_clk_t` 不再使用。
- 更新后，定时器计数方向由 `gptimer_count_direction_t` 定义，之前的计数方向参数 `timer_count_dir_t` 不再使用。
- 更新后，仅支持电平触发的中断，`timer_intr_t` 和 `timer_intr_mode_t` 不再使用。



- 更新后，通过设置标志位 `gptimer_alarm_config_t::auto_reload_on_alarm`，可以使能自动加载。`timer_autoreload_t` 不再使用。

### 主要使用方法更新

- 更新后，通过从 `gptimer_new_timer()` 创建定时器示例可以初始化定时器。用户可以在 `gptimer_config_t` 进行一些基本设置，如时钟源，分辨率和计数方向。请注意，无需在驱动安装阶段进行报警事件的特殊设置。
- 更新后，报警事件在 `gptimer_set_alarm_action()` 中进行设置，参数在 `gptimer_alarm_config_t` 中进行设置。
- 更新后，通过 `gptimer_get_raw_count()` 设置计数数值，通过 `gptimer_set_raw_count()` 获取计数数值。驱动不会自动将原始数据同步到 UTC 时间戳。由于定时器的分辨率已知，用户可以自行转换数据。
- 更新后，如果 `gptimer_event_callbacks_t::on_alarm` 被设置为有效的回调函数，驱动程序也会安装中断服务。在回调函数中，用户无需配置底层寄存器，如用于“清除中断状态”，“重新使能事件”的寄存器等。因此，`timer_group_get_intr_status_in_isr` 与 `timer_group_get_auto_reload_in_isr` 这些函数不再使用。
- 更新后，当报警事件发生时，为更新报警配置，用户可以在中断回调中调用 `gptimer_set_alarm_action()`，这样报警事件会被重新使能。
- 更新后，如果用户将 `gptimer_alarm_config_t::auto_reload_on_alarm` 设置为 `true`，报警事件将会一直被驱动程序使能。

## UART

删除/弃用项目	替代	备注
<code>uart_isr_register()</code>	无	更新后，UART 中断由驱动处理。
<code>uart_isr_free()</code>	无	更新后，UART 中断由驱动处理。
<code>uart_config_t</code> 中的 <code>use_ref_tick</code>	<code>uart_config_t::source_clk</code>	选择时钟源。
<code>uart_enable_pattern_detect</code>	<code>uart_enable_pattern_detect_baud</code>	使能模式检测中断。

## I2C

删除/弃用项目	替代	备注
<code>i2c_isr_register()</code>	无	更新后，I2C 中断由驱动处理。
<code>i2c_isr_register()</code>	无	更新后，I2C 中断由驱动处理。
<code>i2c_opmode_t</code>	无	更新后，该项不再在 <code>esp-idf</code> 中使用。

## SPI

删除/弃用项目	替代	备注
<code>spi_cal_clock()</code>	<code>spi_get_actual_clock()</code>	获取 SPI 真实的工作频率。

- 内部头文件 `spi_common_internal.h` 已被移至 `esp_private/spi_common_internal.h`。

## LEDC

删除/弃用项目	替代	备注
<code>ledc_timer_config_t</code> 中的 <code>bit_num</code>	<code>ledc_timer_config_t::duty_resolution</code>	设置占空比分辨率。

**脉冲计数器 (PCNT) 驱动** 为统一和简化 PCNT 外设，PCNT 驱动已更新，详见 [PCNT](#)。

尽管我们推荐使用新的驱动 API，旧版驱动仍然可用，保留在头文件引用路径 `driver/pcnt.h` 中。但是，引用路径 `driver/pcnt.h` 会默认触发如下编译警告，可通过配置 `Kconfig` 选项 `CONFIG_PCNT_SUPPRESS_DEPRECATED_WARN` 来关闭该警告。

```
legacy pcnt driver is deprecated, please migrate to use driver/pulse_cnt.h
```

主要概念和使用方法上的更新如下所示：

### 主要概念更新

- 更新后，`pcnt_port_t`、`pcnt_unit_t` 和 `pcnt_channel_t` 这些用于识别 PCNT 单元和通道的参数已被删除。在新的驱动中，PCNT 单元由参数 `pcnt_unit_handle_t` 表示，PCNT 通道由参数 `pcnt_channel_handle_t` 表示，这两个参数都是不透明指针。
- 更新后，不再使用 `pcnt_evt_type_t`，它们由统一的 **观察点事件** 表示。在事件回调函数 `pcnt_watch_cb_t` 中，通过 `pcnt_watch_event_data_t` 可以分辨不同观察点。
- `pcnt_count_mode_t` 更新为 `cpp:type:pcnt_channel_edge_action_t`，`pcnt_ctrl_mode_t` 更新为 `pcnt_channel_level_action_t`。

### 主要使用方法更新

- 更新前，PCNT 的单元配置和通道配置都通过函数 `pcnt_unit_config` 实现。更新后，PCNT 的单元配置通过工厂 API `pcnt_new_unit()` 完成，通道配置通过工厂 API `pcnt_new_channel()` 完成。
  - 只需配置计数范围即可初始化一个 PCNT 单元。更新后，GPIO 管脚分配通过 `pcnt_new_channel()` 完成。
  - 高/低电平控制模式和上升沿/下降沿计数模式分别通过函数 `pcnt_channel_set_edge_action()` 和 `pcnt_channel_set_level_action()` 进行设置。
- `pcnt_get_counter_value` 更新为 `pcnt_unit_get_count()`。
- `pcnt_counter_pause` 更新为 `pcnt_unit_stop()`。
- `pcnt_counter_resume` 更新为 `pcnt_unit_start()`。
- `pcnt_counter_clear` 更新为 `pcnt_unit_clear_count()`。
- 更新后，`pcnt_intr_enable` 与 `pcnt_intr_disable` 已被删除。新的驱动中，通过注册时间回调函数 `pcnt_unit_register_event_callbacks()` 来使能中断。
- 更新后，`pcnt_event_enable` 与 `pcnt_event_disable` 已被删除。新的驱动中，可通过 `pcnt_unit_add_watch_point()` 和 `pcnt_unit_remove_watch_point()` 来增加/删除观察点，以使能/停用 PCNT 事件。
- 更新后，`pcnt_set_event_value` 已被删除。新的驱动中，通过 `pcnt_unit_add_watch_point()` 增加观察点时，也同时设置了事件的数值。
- 更新后，`pcnt_get_event_value` 与 `pcnt_get_event_status` 已被删除。在新的驱动中，这些信息存储在 `pcnt_watch_event_data_t` 的回调函数 `pcnt_watch_cb_t` 中。
- 更新后，`pcnt_isr_register` 与 `pcnt_isr_unregister` 已被删除，不允许注册 ISR 句柄。用户可以通过调用 `cpp:func:pcnt_unit_register_event_callbacks` 来注册事件回调函数。
- 更新后，`pcnt_set_pin` 已被删除，新的驱动不再允许在运行时切换 GPIO 管脚。如果用户想切换为其他 GPIO 管脚，可通过 `cpp:func:pcnt_del_channel` 删除当前的 PCNT 通道，然后通过 `cpp:func:pcnt_new_channel` 安装新的 GPIO 管脚。
- `pcnt_filter_enable`、`pcnt_filter_disable` 与 `pcnt_set_filter_value` 更新为 `pcnt_unit_set_glitch_filter()`。同时，`pcnt_get_filter_value` 已被删除。
- `pcnt_set_mode` 更新为 `pcnt_channel_set_edge_action()` 与 `pcnt_channel_set_level_action()`。
- `pcnt_isr_service_install`、`pcnt_isr_service_uninstall`、`pcnt_isr_handler_add` 与 `pcnt_isr_handler_remove` 更新为 `pcnt_unit_register_event_callbacks()`。默认的 ISR 句柄已安装在新的驱动中。

**温度传感器驱动** 温度传感器的驱动已更新，推荐用户使用新驱动。旧版驱动仍然可用，但是无法与新驱动同时使用。

新驱动的头文件引用路径为 `driver/temperature_sensor.h`。旧版驱动仍然可用，保留在引用路径 `driver/temp_sensor.h` 中。但是，引用路径 `driver/temp_sensor.h` 会默认触发如下编译警告，可通过设置 Kconfig 选项 `CONFIG_TEMP_SENSOR_SUPPRESS_DEPRECATED_WARN` 来关闭该警告。

```
legacy temperature sensor driver is deprecated, please migrate to driver/
↳temperature_sensor.h
```

配置内容已更新。更新前，用户需要设置 `clk_div` 与 `dac_offset`。更新后，用户仅需设置 `tsens_range`。

温度传感器的使用过程也已更新。更新前，用户可通过 `config->start->read_celsius` 获取数据。更新后，用户需要通过 `temperature_sensor_install` 先安装温度传感器的驱动，测量完成后需卸载驱动，详情请参考 [Temperature Sensor](#)。

**RMT 驱动** 为统一和扩展 RMT 外设的使用，RMT 驱动已更新，详见 [RMT transceiver](#)。

尽管我们建议使用新的驱动 API，旧版驱动仍然可用，保留在头文件引用路径 `driver/rmt.h` 中。但是，引用路径 `driver/rmt.h` 会默认触发如下编译警告，可通过配置 Kconfig 选项 `CONFIG_RMT_SUPPRESS_DEPRECATED_WARN` 来关闭该警告。

```
The legacy RMT driver is deprecated, please use driver/rmt_tx.h and/or driver/rmt_
↳rx.h
```

主要概念和使用方法更新如下所示：

### 主要概念更新

- 更新后，用于识别硬件通道的 `rmt_channel_t` 已删除。在新的驱动中，RMT 通道用参数 `rmt_channel_handle_t` 表示，该通道由驱动程序动态分配，而不是由用户指定。
- `rmt_item32_t` 更新为 `rmt_symbol_word_t`，以避免在结构体中出现嵌套的共用体。
- 更新后，`rmt_mem_t` 已被删除，因为我们不允许用户直接访问 RMT 内存块（即 RMTMEM）。直接访问 RMTMEM 没有意义，反而会引发错误，特别是当 RMT 通道与 DMA 通道相连时。
- 更新后，由于 `rmt_mem_owner_t` 由驱动控制，而不是用户，因此 `rmt_mem_owner_t` 已被删除。
- `rmt_source_clk_t` 更新为 `rmt_clock_source_t`，后者不支持二进制兼容。
- 更新后，`rmt_data_mode_t` 已被删除，RMT 内存访问模式配置为始终使用 Non-FIFO 和 DMA 模式。
- 更新后，由于驱动有独立的发送和接收通道安装函数，因此 `rmt_mode_t` 已被删除。
- 更新后，`rmt_idle_level_t` 已被删除，在 `rmt_transmit_config_t::eot_level` 中可为发送通道设置空闲状态电平。
- 更新后，`rmt_carrier_level_t` 已被删除，可在 `rmt_carrier_config_t::polarity_active_low` 设置载流子极性。
- 更新后，`rmt_channel_status_t` 与 `rmt_channel_status_result_t` 已被删除，不再使用。
- 通过 RMT 通道发送并不需要用户提供 RMT 符号，但是用户需要提供一个 RMT 编码器用来告诉驱动如何将用户数据转换成 RMT 符号。

### 主要使用方法更新

- 更新后，分别通过 `rmt_new_tx_channel()` 和 `rmt_new_rx_channel()` 安装发送通道和接收通道。
- 更新后，`rmt_set_clk_div` 和 `rmt_get_clk_div` 已被删除。通道时钟配置只能在通道安装时完成。
- 更新后，`rmt_set_rx_idle_thresh` 和 `rmt_get_rx_idle_thresh` 已被删除。新驱动中，接收通道的空闲状态阈值定义为 `rmt_receive_config_t::signal_range_max_ns`。
- 更新后，`rmt_set_mem_block_num` 和 `rmt_get_mem_block_num` 已被删除。新驱动中，内存块的数量由 `rmt_tx_channel_config_t::mem_block_symbols` 与 `rmt_rx_channel_config_t::mem_block_symbols` 决定。
- 更新后，`rmt_set_tx_carrier` 已被删除。新驱动使用 `rmt_apply_carrier()` 来设置载波动作。
- 更新后，`rmt_set_mem_pd` 和 `rmt_get_mem_pd` 已被删除，驱动程序自动调整内存的功率。



- 更新后, `rmt_memory_rw_rst`, `rmt_tx_memory_reset` 和 `rmt_rx_memory_reset` 已被删除, 驱动程序自动进行内存重置。
- 更新后, `rmt_tx_start` 和 `rmt_rx_start` 被合并为函数 `rmt_enable()`, 该函数同时适用于发射通道和接收通道。
- 更新后, `rmt_tx_stop` 和 `rmt_rx_stop` 被合并为函数 `rmt_disable()`, 该函数同时适用于发射通道和接收通道。
- 更新后, `rmt_set_memory_owner` 和 `rmt_get_memory_owner` 已被删除, 驱动程序自动添加 RMT 内存保护。
- 更新后, `rmt_set_tx_loop_mode` 和 `rmt_get_tx_loop_mode` 已被删除。新驱动中, 在 `rmt_transmit_config_t::loop_count` 中设置循环模式。
- 更新后, `rmt_set_source_clk` 和 `rmt_get_source_clk` 已被删除。仅能在通道安装时通过 `rmt_tx_channel_config_t::clk_src` 和 `rmt_rx_channel_config_t::clk_src` 设置时钟源。
- 更新后, `rmt_set_rx_filter` 已被删除。新驱动中, 过滤阈值定义为 `rmt_receive_config_t::signal_range_min_ns`。
- 更新后, `rmt_set_idle_level` 和 `rmt_get_idle_level` 已被删除, 可在 `rmt_transmit_config_t::eot_level` 中设置发射通道的空闲状态电平。
- 更新后, `rmt_set_rx_intr_en`, `rmt_set_err_intr_en`, `rmt_set_tx_intr_en`, `rmt_set_tx_thr_intr_en` 和 `rmt_set_rx_thr_intr_en` 已被删除。新驱动不允许用户在用户端开启/关闭中断, 而是提供了回调函数。
- 更新后, `rmt_set_gpio` 和 `rmt_set_pin` 已被删除。新驱动不支持运行时动态切换 GPIO 管脚。
- 更新后, `rmt_config` 已被删除。新驱动中, 基础配置在通道安装阶段完成。
- 更新后, `rmt_isr_register` 和 `rmt_isr_deregister` 已被删除, 驱动程序负责分配中断。
- `rmt_driver_install` 更新为 `rmt_new_tx_channel()` 与 `rmt_new_rx_channel()`。
- `rmt_driver_uninstall` 更新为 `rmt_del_channel()`。
- 更新后, `rmt_fill_tx_items`, `rmt_write_items` 和 `rmt_write_sample` 已被删除。新驱动中, 用户需要提供一个编码器用来将用户数据“翻译”为 RMT 符号。
- 更新后, 由于用户可以通过 `rmt_tx_channel_config_t::resolution_hz` 配置通道的时钟分辨率, `rmt_get_counter_clock` 已被删除。
- `rmt_wait_tx_done` 更新为 `rmt_tx_wait_all_done()`。
- 更新后, `rmt_translator_init`, `rmt_translator_set_context` 和 `rmt_translator_get_context` 已被删除。新驱动中, 翻译器更新为 RMT 译码器。
- 更新后, `rmt_get_ringbuf_handle` 已被删除。新驱动程序不再使用 Ringbuffer 来保存 RMT 符号。输入数据会直接保存到用户提供的缓冲区中, 这些缓冲区甚至可以直接被挂载到 DMA 链接内部。
- `rmt_register_tx_end_callback` 更新为 `rmt_tx_register_event_callbacks()`, 用户可以在这个参数里面注册事件回调函数 `rmt_tx_event_callbacks_t::on_trans_done`。
- 更新后, `rmt_set_intr_enable_mask` 和 `rmt_clr_intr_enable_mask` 已被删除。由于驱动程序负责处理中断, 因此用户无需进行处理。
- `rmt_add_channel_to_group` 和 `rmt_remove_channel_from_group` 更新为 RMT 同步管理器, 详见 `rmt_new_sync_manager()`。
- 更新后, `rmt_set_tx_loop_count` 已被删除。新驱动中, 循环计数在 `rmt_transmit_config_t::loop_count` 进行配置。
- 更新后, `rmt_enable_tx_loop_autostop` 已被删除。新驱动中, 发射循环自动终止一直使能, 用户无法进行配置。

## LCD

- LCD 面板的初始化流程也有一些更新。更新后, `esp_lcd_panel_init()` 不再会自动打开显示器。用户需要调用 `esp_lcd_panel_disp_on_off()` 来手动打开显示器。请注意, 打开显示器与打开背光是不同的。更新后, 打开屏幕前, 用户可以烧录一个预定义的图案, 这可以避免开机复位后屏幕上的随机噪音。
- 更新后, `esp_lcd_panel_disp_off()` 已被弃用, 请使用 `esp_lcd_panel_disp_on_off()` 作为替代。
- 更新后, `dc_as_cmd_phase` 已被删除, SPI LCD 驱动不再支持 9-bit 的 SPI LCD。请使用专用的 GPIO 管脚来控制 LCD D/C 线。
- 更新后, 用于注册 RGB 面板的事件回调函数已从 `esp_lcd_rgb_panel_config_t` 更新为单独的 API `esp_lcd_rgb_panel_register_event_callbacks()`。但是, 事件回调签名仍保持

不变。

- 更新后, `esp_lcd_rgb_panel_config_t` 中的标志位 `relax_on_idle` 被重命名为 `esp_lcd_rgb_panel_config_t::refresh_on_demand`, 后者虽表达了同样的含义, 但是其命名更有意义。
- 更新后, 如果创建 RGB LCD 时, 标志位 `refresh_on_demand` 使能, 驱动不会在 `esp_lcd_panel_draw_bitmap()` 中进行刷新, 用户需要调用 `esp_lcd_rgb_panel_refresh()` 来刷新屏幕。
- 更新后, `esp_lcd_color_space_t` 已被弃用, 请使用 `lcd_color_space_t` 来描述色彩空间, 使用 `lcd_rgb_element_order_t` 来描述 RGB 颜色的排列顺序。

**MCPWM** MCPWM 驱动已更新 (详见 [MCPWM](#))。同时, 旧版驱动已被弃用。

新驱动中, 每个 MCPWM 子模块相互独立, 用户可以自由进行资源连接。

尽管我们推荐使用新的驱动 API, 旧版驱动仍然可用, 其引用路径为 `driver/mcpwm.h`。但是, 使用旧版驱动会默认触发如下编译警告, 可以通过配置 `Kconfig` 选项 `CONFIG_MCPWM_SUPPRESS_DEPRECATED_WARN` 来关闭该警告。

```
legacy MCPWM driver is deprecated, please migrate to the new driver (include_
↳driver/mcpwm_prelude.h)
```

主要概念和使用方法上的更新如下所示:

**主要概念更新** 更新后, MCPWM 驱动是面向对象的, 大多数 MCPWM 子模块都有一个与之相关的驱动对象。驱动对象是由工厂函数创建的, 如 `mcpwm_new_timer()`。IO 控制函数总是需要对象句柄。

旧版驱动有一个不恰当的假设, 即 MCPWM 运算器应连接到不同的 MCPWM 定时器上。但是, 硬件上并没有这样的限制。新驱动中, 同一个 MCPWM 定时器可以连接多个运算器, 这样运算器可以获得最佳的同步性能。

更新前, 驱动将生成 PWM 波形的方波预设为所谓的 `mcpwm_duty_type_t`, 但是, 列出的占空比模式远远不够。类似的, 旧版驱动有一些预设的 `mcpwm_deadtime_type_t` 也没有包含所有的使用场景。更重要的是, 用户通常会被占空比模式和死区时间模式的名称所迷惑。更新后, 驱动没有这些限制, 但是用户必须从头开始构建发生器的行为。

在旧版驱动中, 通过 GPIO 管脚, 软件和其他定时器模块同步 MCPWM 定时器的方法并不统一。这增加了用户的学习成本, 因此新驱动统一了同步 API。

旧版驱动混淆了“故障检测器”和“故障处理器”的概念。这让用户对 API 感到非常困惑。新驱动中, 故障对象只代表一个故障源, 而且我们引入了一个新概念, **制动器**, 来表示故障处理器。而且, 新驱动支持软件故障。

旧版驱动只为获取子模块提供了回调函数, 而新驱动为 MCPWM 子模块提供多种回调函数, 如停止定时器, 比较匹配, 故障进入, 紧急停止等。

- 更新后, 不再使用 `mcpwm_io_signals_t` 和 `mcpwm_pin_config_t`, GPIO 管脚配置被移至子模块的配置结构中。
- 更新后, 不再使用 `mcpwm_timer_t` 和 `mcpwm_generator_t`, 定时器和发生器分别用 `mcpwm_timer_handle_t` 和 `cpp:type:mcpwm_gen_handle_t` 表示。
- 更新后, 不再使用 `mcpwm_fault_signal_t` 和 `mcpwm_sync_signal_t`, 故障和同步源分别用 `mcpwm_fault_handle_t` 和 `cpp:type:mcpwm_sync_handle_t` 表示。
- 更新后, 不再使用 `mcpwm_capture_signal_t`, 获取通道用 `mcpwm_cap_channel_handle_t` 表示。

### 主要使用方法更新

- `mcpwm_gpio_init` 和 `mcpwm_set_pin`: GPIO 管脚配置在子模块配置中完成, 例如在 `mcpwm_generator_config_t::gen_gpio_num` 中设置 PWM GPIO 管脚。
- `mcpwm_init`: 为得到预期的 PWM 波形, 用户需要至少分配一个 MCPWM 定时器和 MCPWM 运算器, 然后通过调用 `mcpwm_operator_connect_timer()` 将二

- 者连接起来。然后，用户需要调用如：`cpp:func:mcpwm_generator_set_actions_on_timer_event`，`mcpwm_generator_set_actions_on_compare_event()` 来设置发生器对不同事件的动作。
- `mcpwm_group_set_resolution`: 新驱动中，群组分辨率固定为最大值，通常为 80 MHz。
  - `mcpwm_timer_set_resolution`: MCPWM 定时器的分辨率在 `mcpwm_timer_config_t::resolution_hz` 中进行设置。
  - `mcpwm_set_frequency`: PWM 频率由 `mcpwm_timer_config_t::resolution_hz`，`mcpwm_timer_config_t::count_mode` 和 `cpp:member:mcpwm_timer_config_t::period_ticks` 决定。
  - `mcpwm_set_duty`: 为设置 PWM 占空比，用户应调用 `mcpwm_comparator_set_compare_value()` 来改变比较器的阈值。
  - `mcpwm_set_duty_type`: 新驱动中没有预设的占空比模式，通过设置不同的发生器行为，如 `mcpwm_generator_set_actions_on_timer_event()`，来配置占空比模式。
  - `mcpwm_set_signal_high` 和 `mcpwm_set_signal_low` 更新为 `mcpwm_generator_set_force_level()`。新驱动中，这是通过为发生器设置力作用来实现的，而不是在后台将占空比改为 0% 或 100%。
  - `mcpwm_start` 和 `mcpwm_stop` 更新为 `mcpwm_timer_start_stop()`。用户可以用更多的模式来启动和停止 MCPWM 定时器，详见 `mcpwm_timer_start_stop_cmd_t`。
  - `mcpwm_carrier_init` 更新为 `mcpwm_operator_apply_carrier()`。
  - `mcpwm_carrier_enable` 与 `mcpwm_carrier_disable`: 通过检查载波设置结构 `mcpwm_carrier_config_t` 是否为空集来自动使能和停用载波子模块。
  - `mcpwm_carrier_set_period` 更新为 `mcpwm_carrier_config_t::frequency_hz`。
  - `mcpwm_carrier_set_duty_cycle` 更新为 `mcpwm_carrier_config_t::duty_cycle`。
  - `mcpwm_carrier_oneshot_mode_enable` 更新为 `mcpwm_carrier_config_t::first_pulse_duration`。
  - 更新后，`mcpwm_carrier_oneshot_mode_disable` 被删除。硬件不支持停用第一个载波脉冲（即一次性脉冲）。
  - `mcpwm_carrier_output_invert` 更新为 `mcpwm_carrier_config_t::invert_before_modulate` 和 `mcpwm_carrier_config_t::invert_after_modulate`。
  - `mcpwm_deadtime_enable` 与 `mcpwm_deadtime_disable` 更新为 `mcpwm_generator_set_dead_time()`。
  - `mcpwm_fault_init` 更新为 `mcpwm_new_gpio_fault()`。
  - `mcpwm_fault_set_oneshot_mode` 与 `mcpwm_fault_set_cyc_mode` 更新为 `mcpwm_operator_set_brake_on_fault()` 与 `mcpwm_generator_set_actions_on_brake_event()`。
  - 由于 `mcpwm_capture_enable` 与 `mcpwm_capture_enable_channel()` 重复，因此在更新后被删除。
  - 由于 `mcpwm_capture_disable` 与 `mcpwm_capture_disable_channel()` 重复，因此在更新后被删除。
  - `mcpwm_capture_enable_channel` 与 `mcpwm_capture_disable_channel` 更新为 `mcpwm_capture_channel_enable()` 与 `mcpwm_capture_channel_disable()`。
  - `mcpwm_capture_signal_get_value` 与 `mcpwm_capture_signal_get_edge`: 通过 `mcpwm_capture_event_data_t`，获取事件回调函数中提供了计时器的数值和边缘电平。只有获取事件发生时，获取数据才有意义，提供单一的 API 来获取捕获数据是没有意义的。
  - 由于 `mcpwm_sync_enable` 与 `mcpwm_sync_configure()` 重复，因此更新后被删除。
  - `mcpwm_sync_configure` 更新为 `mcpwm_timer_set_phase_on_sync()`。
  - `mcpwm_sync_disable` 相当于将 `mcpwm_timer_sync_phase_config_t::sync_src` 设置为 NULL。
  - `mcpwm_set_timer_sync_output` 更新为 `mcpwm_new_timer_sync_src()`。
  - `mcpwm_timer_trigger_soft_sync` 更新为 `mcpwm_soft_sync_activate()`。
  - `mcpwm_sync_invert_gpio_synchro` 与设置 `mcpwm_gpio_sync_src_config_t::active_neg` 功能相同。
  - 更新后，`mcpwm_isr_register` 已被删除。用户可以注册不同的事件回调函数来替代其功能，例如，可以使用 `mcpwm_capture_channel_register_event_callbacks()` 注册获取事件注册函数。

### 专用的 GPIO 驱动

- 更新后，所有与专用 GPIO 管脚相关的底层 (LL) 函数从 `cpu_ll.h` 中被移至 `dedic_gpio_cpu_ll.h`，并重新命名。

**I2S 驱动** 旧版 I2S 驱动在支持 ESP32-C3 和 ESP32-S3 新功能时暴露了很多缺点，为解决这些缺点，I2S 驱动已更新（请参考：[doc:I2S Driver <../../api-reference/peripherals/i2s>](#)）。用户可以通过引用不同 I2S 模式对应的头文件来使用新版驱动的 API，如 `esp_driver_i2s/include/driver/i2s_std.h`、`esp_driver_i2s/include/driver/i2s_pdm.h` 以及 `esp_driver_i2s/include/driver/i2s_tdm.h`。

为保证前向兼容，旧版驱动的 API 仍然在 `driver/deprecated/driver/i2s.h` 中可用。但使用旧版 API 会触发编译警告，该警告可通过配置 Kconfig 选项 `CONFIG_I2S_SUPPRESS_DEPRECATED_WARN` 来关闭。

以下是更新后的 I2S 文件概况。

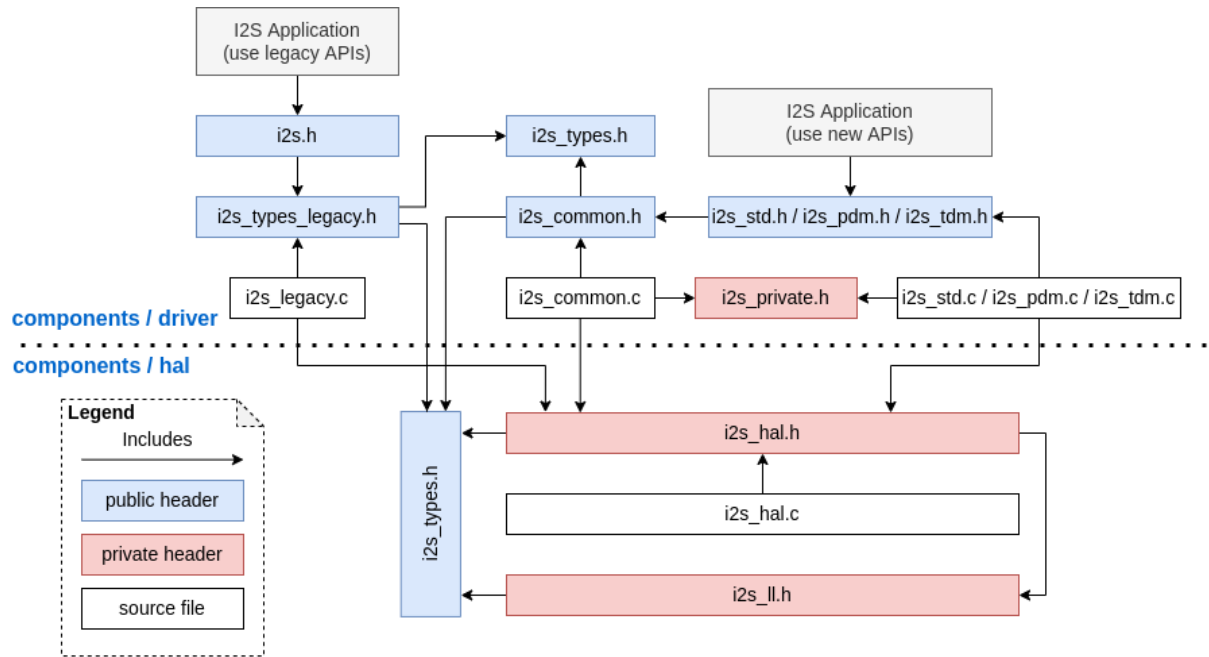

## 主要概念更新

**独立的发送通道和接收通道** 更新后，I2S 驱动的最小控制单元是发送/接收通道，而不是整个 I2S 控制器（控制器包括多个通道）。

- 用户可以分别控制同一个 I2S 控制器的发送通道和接收通道，即可以通过配置实现分别开启和关闭发送通道和接收通道。
- `i2s_chan_handle_t` 句柄类型用于唯一地识别 I2S 通道。所有的 API 都需要该通道句柄，用户需要对这些通道句柄进行维护。
- 对于 ESP32-C3 和 ESP32-S3，同一个控制器中的发送通道和接收通道可以配置为不同的时钟或不同的模式。
- 但是对于 ESP32 和 ESP32-S2，同一个控制器中的发送通道和接收通道共享某些硬件资源。因此，配置可能会造成一个通道影响同一个控制器中的另一个通道。
- 通过将 `i2s_port_t::I2S_NUM_AUTO` 设置为 I2S 端口 ID，驱动会搜索可用的发送/接收通道，之后通道会被自动注册到可用的 I2S 控制器上。但是，驱动仍然支持将通道注册到一个特定的端口上。
- 为区分发送/接收通道和声道，在更新后的驱动中，“通道 (channel)” 一词仅代表发送/接收通道，用“声道 (slot)” 来表示声道。

**I2S 模式分类** I2S 通信模式包括以下三种模式，请注意：

- **标准模式：**标准模式通常包括两个声道，支持 Philips, MSB 和 PCM（短帧同步）格式，详见 `esp_driver_i2s/include/driver/i2s_std.h`。
- **PDM 模式：**PDM 模式仅支持两个声道，16 bit 数据位宽，但是 PDM TX 和 PDM RX 的配置略有不同。对于 PDM TX，采样率可通过 `i2s_pdm_tx_clk_config_t::sample_rate` 进行设置，其时钟频率取决于上采样的配置。对于 PDM RX，采样率可通过 `i2s_pdm_rx_clk_config_t::sample_rate` 进行设置，其时钟频率取决于下采样的配置，详见 `esp_driver_i2s/include/driver/i2s_pdm.h`。



- **TDM 模式**: TDM 模式可支持高达 16 声道, 该模式可工作在 Philips, MSB, PCM (短帧同步) 和 PCM (长帧同步) 格式下, 详见 `esp_driver_i2s/include/driver/i2s_tdm.h`。

在某个模式下分配新通道时, 必须通过相应的函数初始化这个通道。我们强烈建议使用辅助宏来生成默认配置, 以避免默认值被改动。

**独立的声道配置和时钟配置** 可以单独进行声道配置和时钟配置。

- 通过调用 `i2s_channel_init_std_mode()`, `i2s_channel_init_pdm_rx_mode()`, `i2s_channel_init_pdm_tx_mode()` 或 `cpp:func:i2s_channel_init_tdm_mode` 初始化声道/时钟/GPIO 管脚配置。
- 通过调用 `i2s_channel_reconfig_std_slot()`, `i2s_channel_reconfig_pdm_rx_slot()`, `i2s_channel_reconfig_pdm_tx_slot()` 或 `i2s_channel_reconfig_tdm_slot()` 可以在初始化之后改变声道配置。
- 通过调用 `i2s_channel_reconfig_std_clock()`, `i2s_channel_reconfig_pdm_rx_clock()`, `i2s_channel_reconfig_pdm_tx_clock()` 或 `i2s_channel_reconfig_tdm_clock()` 可以在初始化之后改变时钟配置。
- 通过调用 `i2s_channel_reconfig_std_gpio()`, `i2s_channel_reconfig_pdm_rx_gpio()`, `i2s_channel_reconfig_pdm_tx_gpio()` 或 `i2s_channel_reconfig_tdm_gpio()` 可以在初始化之后改变 GPIO 管脚配置。

### Misc

- 更新后, I2S 驱动利用状态和状态机避免在错误状态下调用 API。
- 更新后, ADC 和 DAC 模式已被删除, 只有它们各自专用的驱动及 I2S 旧版驱动还支持这两种模式。

**主要使用方法更新** 请参考以下步骤使用更新后的 I2S 驱动:

1. 通过调用 `i2s_new_channel()` 来获取通道句柄。我们应该在此步骤中指定外设为主机还是从机以及 I2S 端口。此外, 驱动负责生成发送通道或接收通道的句柄。不需要同时输入发送通道和接收通道句柄, 但需要输入至少一个句柄。输入两个句柄时, 驱动会工作在双工模式。在同一端口上, 发送通道和接收通道同时可用, 并且共享 MCLK, BCLK 和 WS 信号。如果只输入了发送通道句柄或接收通道句柄, 该通道只能工作在单工模式。
2. 通过调用 `i2s_channel_init_std_mode()`, `i2s_channel_init_pdm_rx_mode()`, `i2s_channel_init_pdm_tx_mode()` 或 `i2s_channel_init_tdm_mode()` 将通道初始化为指定模式。进行相应的声道、时钟和 GPIO 管脚配置。
3. (可选) 通过调用 `i2s_channel_register_event_callback()` 注册 ISR 事件回调函数。I2S 事件由回调函数同步接收, 而不是从事件队列中异步接收。
4. 通过调用 `i2s_channel_enable()` 来开启 I2S 通道的硬件资源。在更新后的驱动中, I2S 在安装后不会再自动开启, 用户需要确定通道是否已经开启。
5. 分别通过 `i2s_channel_read()` 和 `i2s_channel_write()` 来读取和写入数据。当然, 在 `i2s_channel_read()` 中只能输入接收通道句柄, 在 `i2s_channel_write()` 中只能输入发送通道句柄。
6. (可选) 通过相应的'reconfig'函数可以更改声道、时钟和 GPIO 管脚配置, 但是更改配置前必须调用 `i2s_channel_disable()`。
7. 通过调用 `i2s_channel_disable()` 可以停止使用 I2S 通道的硬件资源。
8. 不再使用某通道时, 通过调用 `i2s_del_channel()` 可以删除和释放该通道资源, 但是删除之前必须先停用该通道。

**TWAI 驱动程序** CAN 外设驱动程序已弃用并被删除, 请使用 TWAI 驱动程序代替 (即在应用程序中包含 `driver/twai.h`)。

**用于访问寄存器的宏** 更新前, 所有用于访问寄存器的宏都可以作为表达式来使用, 所以以下命令是允许的:

```
uint32_t val = REG_SET_BITS(reg, bits, mask);
```

在 ESP-IDF v5.0 中, 用于写入或读取-修改-写入寄存器的宏不能再作为表达式使用, 而只能作为语句使用, 这适用于以下宏: `REG_WRITE`, `REG_SET_BIT`, `REG_CLR_BIT`, `REG_SET_BITS`, `REG_SET_FIELD`, `WRITE_PERI_REG`, `CLEAR_PERI_REG_MASK`, `SET_PERI_REG_MASK`, `SET_PERI_REG_BITS`。

为存储要写入寄存器的值, 请按以下步骤完成操作:

```
uint32_t new_val = REG_READ(reg) | mask;
REG_WRITE(reg, new_val);
```

要获得修改后的寄存器的值 (该值可能与写入的值不同), 要增加一个显示的读取命令:

```
REG_SET_BITS(reg, bits, mask);
uint32_t new_val = REG_READ(reg);
```

## 协议

**Mbed TLS** 在 ESP-IDF v5.0 版本中, [Mbed TLS](#) 已从 v2.x 版本更新到 v3.1.0 版本。

更多有关 Mbed TLS 从 v2.x 版本迁移到 v3.0 或更高版本的详细信息, 请参考 [官方指南](#)。

## 重大更新 (概述)

### 增加私有结构体字段数量

- 不再支持直接访问公共头文件中声明的结构体 (`struct` 类型) 字段。
- 当前版本下, 访问公共头文件中声明的结构体字段需要使用特定的访问函数 (`getter/setter`)。另外, 也可以用 `MBEDTLS_PRIVATE` 宏暂时代替, 但不建议使用此种方法。
- 更多详细信息, 请参考 [官方指南](#)。

## SSL

- 不再支持 TLS 1.0、TLS 1.1 和 DTLS 1.0
- 不再支持 SSL 3.0

### 移除密码模块中的废弃函数

- 更新了与 MD、SHA、RIPEMD、RNG、HMAC 模块相关的函数 `MBEDTLS_*_ret()` 的返回值, 并将其重新命名, 以取代未附加 `_ret` 的相应函数。
- 更多详细信息, 请参考 [官方指南](#)。

**废弃配置选项** 下列为在此次更新中废弃的重要配置选项。与以下配置有关或是依赖于下列配置的相关配置也已相应废弃。

- `MBEDTLS_SSL_PROTO_SSL3`: 原用于支持 SSL 3.0
- `MBEDTLS_SSL_PROTO_TLS1`: 原用于支持 TLS 1.0
- `MBEDTLS_SSL_PROTO_TLS1_1`: 原用于支持 TLS 1.1
- `MBEDTLS_SSL_PROTO_DTLS`: 原用于支持 DTLS 1.1 (当前版本仅支持 DTLS 1.2)
- `MBEDTLS_DES_C`: 原用于支持 3DES 密码套件
- `MBEDTLS_RC4_MODE`: 原用于支持基于 RC4 的密码套件

**备注:** 上述仅列出了可通过 `idf.py menuconfig` 配置的主要选项。更多有关废弃选项的信息, 请参考 [官方指南](#)。

## 其他更新

**禁用 Diffie-Hellman 密码交换模式** 为避免 [安全风险](#)，当前版本已默认禁用 Diffie-Hellman 密码交换模式。以下为相应的禁用配置项：

- `MBEDTLS_DHM_C`：原用于支持 Diffie-Hellman-Merkle 模块
- `MBEDTLS_KEY_EXCHANGE_DHE_PSK`：原用于支持 Diffie-Hellman 预共享密钥 (PSK) TLS 认证模式
- `MBEDTLS_KEY_EXCHANGE_DHE_RSA`：原用于支持带有前缀的密码套件 `TLS-DHE-RSA-WITH-`

**备注：**在信号交换的初始步骤（即 `client_hello`）中，服务器会在客户端提供的列表中选择一个密码。由于 `DHE_PSK/DHE_RSA` 密码已在本次更新中禁用，服务器将退回到一个替代密码。在极个别情况中，服务器不支持任何其他的代码，此时，初始步骤将失败。若要检索服务器所支持的密码列表，需要首先在客户端使用特定的密码连接服务器，可以使用 `ssllscan` 等工具完成连接。

## 从 X509 库中移除 `certs` 模块

- `mbdtdls 3.1` 不再支持 `mbdtdls/certs.h` 头文件。大多数应用程序支持从包含列表中安全删除该头文件。

## 对 `esp_cert_bundle_set` API 的重大更新

- 更新后，调用 `esp_cert_bundle_set()` API 需要一个额外的参数 `bundle_size`。该 API 的返回类型也从 `void` 变为了 `esp_err_t`。

## 对 `esp_ds_rsa_sign` API 的重大更新

- 更新后，调用 `esp_ds_rsa_sign()` API 无需再使用参数 `mode`。

## HTTPS 服务器

**重大更新（概述）** 更新 `httpd_ssl_config_t` 结构体中持有不同证书的变量名。

- `httpd_ssl_config::servercert`：原 `cacert_pem`
- `httpd_ssl_config::servercert_len`：原 `cacert_len`
- `httpd_ssl_config::cacert_pem`：原 `client_verify_cert_pem`
- `httpd_ssl_config::cacert_len`：原 `client_verify_cert_len`

`httpd_ssl_stop()` API 的返回类型从 `void` 变为了 `esp_err_t`。

## ESP HTTPS OTA

### 重大更新（概述）

- 函数 `esp_https_ota()` 现需以指向 `esp_https_ota_config_t` 的指针作为参数，而非之前的指向 `esp_http_client_config_t` 的指针。

## ESP-TLS

### 重大更新（概述）

**私有化 `esp_tls_t` 结构体** 更新后, `esp_tls_t` 已完全私有化, 用户无法直接访问其内部结构。之前需要通过 ESP-TLS 句柄获得的必要数据, 现在可由对应的 getter/setter 函数获取。如需特定功能的 getter/setter 函数, 请在 ESP-IDF 的 [Issue 板块](#) 提出。

下列为新增的 getter/setter 函数:

- `esp_tls_get_ssl_context()`: 从 ESP-TLS 句柄获取底层 ssl 栈的 ssl 上下文。

**废弃函数及推荐的替代函数** 下表总结了在 ESP-IDF v5.0 中废弃的函数以及相应的替代函数。

废弃函数	替代函数
<code>esp_tls_conn_new()</code>	<code>esp_tls_conn_new_sync()</code>
<code>esp_tls_conn_delete()</code>	<code>esp_tls_conn_destroy()</code>

- 函数 `esp_tls_conn_http_new()` 现已废弃。请使用替代函数 `esp_tls_conn_http_new_sync()` (或其异步函数 `esp_tls_conn_http_new_async()`)。请注意, 使用替代函数时, 需要额外的参数 `esp_tls_t`, 此参数必须首先通过 `esp_tls_init()` 函数进行初始化。

## HTTP 服务器

### 重大更新 (概述)

- `esp_http_server` 现不再支持 `http_server.h` 头文件。请使用 `esp_http_server.h`。

## ESP HTTP 客户端

### 重大更新 (概述)

- 函数 `esp_http_client_read()` 和 `esp_http_client_fetch_headers()` 现在会返回额外的返回值 `-ESP_ERR_HTTP_EAGAIN` 用于处理超时错误, 即数据准备好前就已调用超时的情况。

## TCP 传输

### 重大更新 (概述)

- 更新后, 出现连接超时的情况时, 函数 `esp_transport_read()` 将返回 0, 对其他错误则返回 `< 0`。请参考 `esp_tcp_transport_err_t`, 查看所有可能的返回值。

## MQTT 客户端

### 重大更新 (概述)

- `esp_mqtt_client_config_t` 的所有字段都分组存放在子结构体中。

以下为较为常用的配置选项:

- 通过 `esp_mqtt_client_config_t::broker::address::uri` 配置 MQTT Broker
- 通过 `esp_mqtt_client_config_t::broker::verification` 配置 MQTT Broker 身份验证的相关安全问题
- 通过 `esp_mqtt_client_config_t::credentials::username` 配置客户端用户名
- `esp_mqtt_client_config_t` 不再支持 `user_context` 字段。之后注册事件处理程序, 请使用 `esp_mqtt_client_register_event()`; 最后一个参数 `event_handler_arg` 可用于将用户上下文传递给处理程序。



## ESP-Modbus

**重大更新 (概述)** 本次更新从 ESP-IDF 中移除了组件 `freemodbus`，该组件已作为一个独立组件受到支持。可前往如下的独立仓库，查看更多有关 ESP-Modbus 的信息：

- [GitHub 中的 ESP-Modbus 组件](#)

在新版应用程序中，main 组件文件夹应包括组件管理器清单文件 `idf_component.yml`，如下所示：

```
dependencies:
  espressif/esp-modbus:
    version: "^1.0"
```

可以前往 [组件管理器注册表](#) 找到 ESP-Modbus 组件。更多有关如何设置组件管理器的信息，请参考 [组件管理器文档](#)。

对于使用 ESP-IDF v4.x 及以后版本的应用程序，需要通过添加组件管理器清单文件 `idf_component.yml` 拉取新版 ESP-Modbus 组件。同时，在编译时，应去掉已过时的 `freemodbus` 组件。此项操作可通过项目 `CMakeLists.txt` 中的以下语句实现：

```
set(EXCLUDE_COMPONENTS freemodbus)
```

## 配置

**Protocomm** `protocomm_set_security()` API 中的 `pop` 字段现已弃用。请使用 `sec_params` 字段来代替 `pop`。此参数应包含所使用的协议版本所要求的结构（包括安全参数）。

例如，当使用安全版本 2 时，`sec_params` 参数应包含指向 `protocomm_security2_params_t` 类型结构的指针。

## Wi-Fi 配置

- `wifi_prov_mgr_start_provisioning()` API 中的 `pop` 字段现已弃用。为了向后兼容，在使用安全版本 1 时，`pop` 仍可以作为字符串传递。但在使用安全版本 2 时，请使用 `wifi_prov_sec_params` 字段来代替 `pop`。此参数应包含所使用的协议版本所要求的结构（包括安全参数）。例如，当使用安全版本 2 时，`wifi_prov_sec_params` 参数应包含指向 `wifi_prov_security2_params_t` 结构体类型的指针。对于安全版本 1，该 API 的行为和使用方式保持不变。
- `wifi_prov_mgr_is_provisioned()` API 不再返回 `ESP_ERR_INVALID_STATE` 错误。此 API 现在可以在不依赖配置管理器初始化状态的情况下工作。

**ESP 本地控制** `esp_local_ctrl_proto_sec_cfg_t` API 中的 `pop` 字段现已弃用。请使用 `sec_params` 字段来代替 `pop`。此参数应包含所使用的协议版本所要求的结构（包括安全参数）。

例如，当使用安全版本 2 时，`sec_params` 字段应包含指向 `esp_local_ctrl_security2_params_t` 类型结构的指针。

## 从 ESP-IDF 中移出或弃用的组件

**移至 ESP-IDF Component Registry 的组件** 以下组件已经从 ESP-IDF 中迁出至 [ESP-IDF Component Registry](#)：

- [libsodium](#)
- [cbor](#)
- [jsmn](#)
- [esp\\_modem](#)
- [nghttp](#)
- [mdns](#)
- [esp\\_websocket\\_client](#)
- [asio](#)
- [freemodbus](#)
- [sh2lib](#)
- [expat](#)
- [coap](#)
- [esp-cryptoauthlib](#)
- [qrcode](#)
- [tjpgd](#)
- [esp\\_serial\\_slave\\_link](#)
- [tinyusb](#)

---

**备注：** 请注意，[http](#) 解析功能以前属于 [nghttp](#) 组件一部分，但现在属于 [http\\_parser](#) 组件。

---

可使用 `idf.py add-dependency` 命令安装以上组件。

例如，要安装 X.Y 版本的 [libsodium](#) 组件，请运行：`idf.py add-dependency libsodium==X.Y`。

根据 [semver](#) 规则安装与 X.Y 兼容的最新版本 [libsodium](#) 组件，请运行 `idf.py add-dependency libsodium~X.Y`。

可前往 <https://components.espressif.com> 查询每个组件有哪些版本，按名称搜索该组件，组件页面上会列出所有版本。

**弃用的组件** ESP-IDF v4.x 版本中已不再使用以下组件，这些组件已弃用：

- [tcpip\\_adapter](#)。可使用 [ESP-NETIF](#) 组件代替，具体可参考 [TCP/IP 适配器](#)。

---

**备注：** 不再支持 [OpenSSL-API](#) 组件。ESP-IDF Component Registry 中也没有该组件。请直接使用 [ESP-TLS](#) 或 [mbedtls](#) API。

---

---

**备注：** 不再支持 [esp\\_adc\\_cal](#) 组件。新的 [adc](#) 校准驱动在 [esp\\_adc](#) 组件中。旧版 [adc](#) 校准驱动已被迁移进 [esp\\_adc](#) 组件中。要使用旧版 [esp\\_adc\\_cal](#) 驱动接口，你应该在 `CMakeLists.txt` 文件的组件依赖列表中增加 [esp\\_adc](#)。更多细节请查看 [Peripherals Migration Guide](#)。

---

版本更新后无需目标组件，因此以下目标组件也已经从 ESP-IDF 中删除：

- [esp32](#)
- [esp32s2](#)
- [esp32s3](#)
- [esp32c2](#)
- [esp32c3](#)
- [esp32h2](#)

## 存储

**分区 API 的新组件** 非兼容性更新：所有的分区 API 代码都已迁移到新组件 `esp_partition` 中。如需查看所有受影响的函数及数据类型，请参见头文件 `esp_partition.h`。

在以前，这些 API 函数和数据类型属于 `spi_flash` 组件。因此，在现有的应用程序中或将依赖 `spi_flash`，这也意味着在直接使用 `esp_partition_*` API/数据类型时，可能会导致构建过程失败（比如，在出现 `#include "esp_partition.h"` 的行中报错 `fatal error: esp_partition.h: No such file or directory`）。如果遇到类似问题，请按以下步骤更新项目中的 `CMakeLists.txt` 文件：

原有的依赖性设置：

```
idf_component_register(...
    REQUIRES spi_flash)
```

更新后的依赖性设置：

```
idf_component_register(...
    REQUIRES spi_flash esp_partition)
```

**备注：**请根据项目的实际情况，更新相应的 `REQUIRES` 或是 `PRIV_REQUIRES` 部分。上述代码片段仅为范例。

如果问题仍未解决，请联系我们，我们将协助你进行代码迁移。

**SDMMC/SDSPI** 用户现可通过 `sdmmc_host_t.max_freq_khz` 将 SDMMC/SDSPI 接口上的 SD 卡频率配置为特定值，不再局限于之前的 `SDMMC_FREQ_PROBING (400 kHz)`、`SDMMC_FREQ_DEFAULT (20 MHz)` 或是 `SDMMC_FREQ_HIGHSPEED (40 MHz)`。此前，如果用户配置了上述三个给定频率之外的值，用户所选频率将自动调整为与其最为接近的给定值。

更新后，底层驱动将计算与用户配置的特定值最为接近的合适频率。相对于枚举项选择，该频率现由可用的分频器提供。不过，如果尚未更新现有的应用代码，可能会导致与 SD 卡的通信过程出现问题。如发现上述问题，请继续尝试配置与期望值接近的不同频率，直到找到合适的频率。如需查看底层驱动的计算结果以及实际应用的频率，请使用 `void sdmmc_card_print_info(FILE* stream, const sdmmc_card_t* card)` 函数。

**FatFs** FatFs 已更新至 v0.14，`f_mkfs()` 函数签名也已变更。新签名为 `FRESULT f_mkfs (const TCHAR* path, const MKFS_PARM* opt, void* work, UINT len);`，使用 `MKFS_PARM` 结构体作为第二个实参。

**分区表** 分区表生成器不再支持未对齐的分区。生成分区表时，ESP-IDF 将只接受偏移量与 4 KB 对齐的分区。此变更仅影响新生成的分区表，不影响读写现有分区。

**VFS** `esp_vfs_semihost_register()` 函数签名有所更改：

- 新签名为 `esp_err_t esp_vfs_semihost_register(const char* base_path);`
- 旧签名的 `host_path` 参数不再存在，请使用 `OpenOCD` 命令 `ESP_SEMIHOST_BASEDIR` 设置主机上的完整路径。

**函数签名更改** 以下函数现将返回 `esp_err_t`，而非 `void` 或 `nvs_iterator_t`。此前，当参数无效或内部出现问题时，这些函数将 `assert()` 或返回 `nullptr`。通过返回 `esp_err_t`，你将获得更加实用的错误报告。

- `nvs_entry_find()`
- `nvs_entry_next()`
- `nvs_entry_info()`

由于 `esp_err_t` 返回类型的更改，`nvs_entry_find()` 和 `nvs_entry_next()` 的使用模式也发生了变化。上述函数现均通过参数修改迭代器，而非返回一个迭代器。

迭代 NVS 分区的旧编程模式如下所示：

```
nvs_iterator_t it = nvs_entry_find(<nvs_partition_name>, <namespace>, NVS_TYPE_
↳ANY);
while (it != NULL) {
    nvs_entry_info_t info;
    nvs_entry_info(it, &info);
    it = nvs_entry_next(it);
    printf("key '%s', type '%d'", info.key, info.type);
};
```

现在，迭代 NVS 分区的编程模式已更新为：

```
nvs_iterator_t it = nullptr;
esp_err_t res = nvs_entry_find(<nvs_partition_name>, <namespace>, NVS_TYPE_ANY, &
↳it);
while(res == ESP_OK) {
    nvs_entry_info_t info;
    nvs_entry_info(it, &info); // Can omit error check if parameters are
↳guaranteed to be non-NULL
    printf("key '%s', type '%d'", info.key, info.type);
    res = nvs_entry_next(&it);
}
nvs_release_iterator(it);
```

**迭代器有效性** 请注意，由于函数签名的改动，如果存在参数错误，则可能从 `nvs_entry_find()` 获得无效迭代器。因此，请务必在使用 `nvs_entry_find()` 之前将迭代器初始化为 `NULL`，以免在调用 `nvs_release_iterator()` 之前进行复杂的错误检查。上述编程模式便是一个很好的例子。

**删除 SDSPI 弃用的 API** 结构体 `sdspi_slot_config_t` 和函数 `sdspi_host_init_slot()` 现已删除，并由结构体 `sdspi_device_config_t` 和函数 `sdspi_host_init_device()` 替代。

**ROM SPI flash** 在 v5.0 之前的版本中，ROM SPI flash 函数一般通过 `esp32**/rom/spi_flash.h` 得以体现。因此，为支持不同 ESP 芯片而编写的代码可能会填充不同目标的 ROM 头文件。此外，并非所有 API 都可以在全部的 ESP 芯片上使用。

现在，常用 API 已提取至 `esp_rom_spiflash.h`。尽管这不能算作重大变更，我们强烈建议仅使用此头文件中的函数（即以 `esp_rom_spiflash` 为前缀并包含在 `esp_rom_spiflash.h` 中），以获得不同 ESP 芯片之间更佳的交叉兼容性。

为了提高 ROM SPI flash API 的可读性，以下函数也进行了重命名：

- `esp_rom_spiflash_lock()` 更名为 `esp_rom_spiflash_set_bp()`
- `esp_rom_spiflash_unlock()` 更名为 `esp_rom_spiflash_clear_bp()`

**SPI flash 驱动** `esp_flash_speed_t` enum 类型现已弃用。现在，可以直接将实际时钟频率值传递给 flash 配置结构。下为配置 80 MHz flash 频率的示例：

```
esp_flash_spi_device_config_t dev_cfg = {
    // Other members
    .freq_mhz = 80,
    // Other members
};
```

**旧版 SPI flash 驱动** 为了使 SPI flash 驱动更为稳定，v5.0 已经删除旧版 SPI flash 驱动。旧版 SPI flash 驱动程序是指自 v3.0 以来的默认 SPI flash 驱动程序，以及自 v4.0 以来启用配置选项 CONFIG\_SPI\_FLASH\_USE\_LEGACY\_IMPL 的 SPI flash 驱动。从 v5.0 开始，我们将不再支持旧版 SPI flash 驱动程序。因此，旧版驱动 API 和 CONFIG\_SPI\_FLASH\_USE\_LEGACY\_IMPL 配置选项均已删除，请改用新 SPI flash 驱动的 API。

删除项目	替代项目
spi_flash_erase_sector()	esp_flash_erase_region()
spi_flash_erase_range()	esp_flash_erase_region()
spi_flash_write()	esp_flash_write()
spi_flash_read()	esp_flash_read()
spi_flash_write_encrypted()	esp_flash_write_encrypted()
spi_flash_read_encrypted()	esp_flash_read_encrypted()

**备注：**带有前缀 esp\_flash 的新函数接受额外的 esp\_flash\_t\* 参数。你可以直接将其设置为 NULL，从而使函数运行主 flash (esp\_flash\_default\_chip)。

由于系统函数不再是公共函数，esp\_spi\_flash.h 头文件已停止使用。若要使用 flash 映射 API，请使用 spi\_flash\_mmap.h。

## 系统

**跨核执行** 跨核执行 (Inter-Processor Call, IPC) 不再是一个独立组件，现已包含至 esp\_system。

因此，若项目的 CMakeLists.txt 文件中出现 PRIV\_REQUIRES esp\_ipc 或 REQUIRES esp\_ipc，应删除这些选项，因为项目中已默认包含 esp\_system 组件。

**ESP 时钟** ESP 时钟 API (即以 esp\_clk 为前缀的函数、类型或宏) 已更新为私有 API。因此，原先的包含路径 #include "ESP32-H2/clk.h" 和 #include "esp\_clk.h" 已移除。如仍需使用 ESP 时钟 API (并不推荐)，请使用 #include "esp\_private/esp\_clk.h" 来包含。

**注意：**私有 API 不属于稳定的 API，不会遵循 ESP-IDF 的版本演进规则，因此不推荐用户在应用中使用。

**缓存错误中断** 缓存错误中断 API (即以 esp\_cache\_err 为前缀的函数、类型或宏) 已更新为私有 API。因此，原先的包含路径 #include "ESP32-H2/cache\_err\_int.h" 已移除。如仍需使用缓存错误中断 API (并不推荐)，请使用 #include "esp\_private/cache\_err\_int.h" 来包含。

## bootloader\_support

- 函数 bootloader\_common\_get\_reset\_reason() 已移除。请使用 ROM 组件中的函数 esp\_rom\_get\_reset\_reason()。
- 函数 esp\_secure\_boot\_verify\_sbv2\_signature\_block() 和 esp\_secure\_boot\_verify\_rsa\_signature\_block() 已移除，无新的替换函数。不推荐用户直接使用以上函数。如确需要，请在 [GitHub](#) 上对该功能提交请求，并解释需要此函数的原因。

**断电** 断电 API (即以 esp\_brownout 为前缀的函数、类型或宏) 已更新为私有 API。因此，原先的包含路径 #include "brownout.h" 已移除。如仍需使用断电 API (并不推荐)，请使用 #include "esp\_private/brownout.h" 来包含。

**Trax** Trax API (即以 `trax_` 为前缀的函数、类型或宏) 已更新为私有 API。因此, 原先的包含路径 `#include "trax.h"` 已移除。如仍需使用 Trax API (并不推荐), 请使用 `#include "esp_private/trax.h"` 来包含。

**ROM** `components/esp32/rom/` 路径下存放的已弃用的 ROM 相关头文件已移除 (原包含路径为 `rom/*.h`)。请使用新的特定目标的路径 `components/esp_rom/include/ESP32-H2/` (新的包含路径为 `ESP32-H2/rom/*.h`)。

### esp\_hw\_support

- 头文件 `soc/cpu.h` 及弃用的 CPU util 函数都已移除。请包含 `esp_cpu.h` 来代替相同功能的函数。
- 头文件 `hal/cpu_ll.h`, `hal/cpu_hal.h`, `hal/soc_ll.h`, `hal/soc_hal.h` 和 `interrupt_controller_hal.h` 的 CPU API 函数已弃用。请包含 `esp_cpu.h` 来代替相同功能的函数。
- 头文件 `compare_set.h` 已移除。请使用 `esp_cpu.h` 中提供的 `esp_cpu_compare_and_set()` 函数来代替。
- `esp_cpu_get_ccount()`, `esp_cpu_set_ccount()` 和 `esp_cpu_in_ocd_debug_mode()` 已从 `esp_cpu.h` 中移除。请分别使用 `esp_cpu_get_cycle_count()`, `esp_cpu_set_cycle_count()` 和 `esp_cpu_dbgr_is_attached()` 代替。
- 头文件 `esp_intr.h` 已移除。请包含 `esp_intr_alloc.h` 以分配和操作中断。
- **Panic API** (即以 `esp_panic` 为前缀的函数、类型或宏) 已更新为私有 API。因此, 原先的包含路径 `#include "esp_panic.h"` 已移除。如仍需使用 Panic API (并不推荐), 请使用 `#include "esp_private/panic_reason.h"` 来包含。此外, 请包含 `esp_debug_helpers.h` 以使用与调试有关的任意辅助函数, 如打印回溯。
- 头文件 `soc_log.h` 现更名为 `esp_hw_log.h`, 并已更新为私有。建议用户使用 `esp_log.h` 头文件下的日志 API。
- 包含头文件 `spinlock.h`, `clk_ctrl_os.h` 和 `rtc_wdt.h` 时不应当使用 `soc` 前缀, 如 `#include "spinlock.h"`。
- `esp_chip_info()` 命令返回芯片版本, 格式为 `= 100 * 主要 eFuse 版本 + 次要 eFuse 版本`。因此, 为适应新格式, `esp_chip_info_t` 结构体中的 `revision` 扩展为 `uint16_t`。

### PSRAM

- 针对特定目标的头文件 `spiram.h` 及头文件 `esp_spiram.h` 已移除, 创建新组件 `esp_psram`。对于与 PSRAM 或 SPIRAM 相关的函数, 请包含 `esp_psram.h`, 并在 `CMakeLists.txt` 项目文件中将 `esp_psram` 设置为必需组件。
- `esp_spiram_get_chip_size` 和 `esp_spiram_get_size` 已移除, 请使用 `esp_psram_get_size`。

### eFuse

- 函数 `esp_secure_boot_read_key_digests()` 的参数类型从 `ets_secure_boot_key_digests_t*` 更新为 `esp_secure_boot_key_digests_t*`。新类型与旧类型相同, 仅移除了 `allow_key_revoke` 标志。在当前代码中, 后者总是设置为 `true`, 并未提供额外信息。
- 针对 eFuse 晶圆增加主要修订版本和次要修订版本。API `esp_efuse_get_chip_ver()` 与新修订不兼容, 因此已移除。请使用 API `efuse_hal_get_major_chip_version()`, `efuse_hal_get_minor_chip_version()` 或 `efuse_hal_chip_revision()` 来代替原有 API。

**esp\_common** `EXT_RAM_ATTR` 已弃用。请使用新的宏 `EXT_RAM_BSS_ATTR` 以将 `.bss` 放在 PSRAM 上。

### esp\_system



- 头文件 `esp_random.h`、`esp_mac.h` 和 `esp_chip_info.h` 以往都是通过头文件 `esp_system.h` 间接包含，更新后必须直接包含。已移除从 `esp_system.h` 中的间接包含功能。
- 回溯解析器 API（即以 `esp_eh_frame_` 为前缀的函数、类型或宏）已更新为私有 API。因此，原先的包含路径 `#include "eh_frame_parser.h"` 已移除。如仍需使用回溯解析器 API（并不推荐），请使用 `#include "esp_private/eh_frame_parser.h"` 来包含。
- 中断看门狗定时器 API（即以 `esp_int_wdt_` 为前缀的函数、类型或宏）已更新为私有 API。因此，原先的包含路径 `#include "esp_int_wdt.h"` 已移除。如仍需使用中断看门狗定时器 API（并不推荐），请使用 `#include "esp_private/esp_int_wdt.h"` 来包含。

### SOC 依赖性

- Doxyfiles 中列出的公共 API 头文件中不会显示不稳定和非必要的 SOC 头文件，如 `soc/soc.h` 和 `soc/rtc.h`。这意味着，如果用户仍然需要这些“缺失”的头文件，就必须在代码中明确包含这些文件。
- Kconfig 选项 `LEGACY_INCLUDE_COMMON_HEADERS` 也已移除。
- 头文件 `soc/soc_memory_types.h` 已弃用。请使用 `esp_memory_utils.h`。包含 `soc/soc_memory_types.h` 将触发构建警告，如 `soc_memory_types.h is deprecated, please migrate to esp_memory_utils.h`。

**应用跟踪** 其中一个时间戳源已从定时器组驱动改为新的 *GPTimer*。Kconfig 选项已重新命名，例如 `APPTRACE_SV_TS_SOURCE_TIMER00` 已更改为 `APPTRACE_SV_TS_SOURCE_GPTIMER`。用户已无需选择组和定时器 ID。

**esp\_timer** 基于 FRC2 的 `esp_timer` 过去可用于 ESP32，现在已移除，更新后仅可使用更简单有效的 LAC 定时器。

**ESP 镜像** ESP 镜像中关于 SPI 速度的枚举成员已重新更名：

- `ESP_IMAGE_SPI_SPEED_80M` 已重新命名为 `ESP_IMAGE_SPI_SPEED_DIV_1`。
- `ESP_IMAGE_SPI_SPEED_40M` 已重新命名为 `ESP_IMAGE_SPI_SPEED_DIV_2`。
- `ESP_IMAGE_SPI_SPEED_26M` 已重新命名为 `ESP_IMAGE_SPI_SPEED_DIV_3`。
- `ESP_IMAGE_SPI_SPEED_20M` 已重新命名为 `ESP_IMAGE_SPI_SPEED_DIV_4`。

### 任务看门狗定时器

- API `esp_task_wdt_init()` 更新后有如下变化：
  - 以结构体的形式传递配置。
  - 可将该函数配置为订阅空闲任务。
- 原先的配置选项 `CONFIG_ESP_TASK_WDT` 重新命名为 `CONFIG_ESP_TASK_WDT_INIT` 并引入了一个新选项 `CONFIG_ESP_TASK_WDT_EN`。

### FreeRTOS

**遗留 API 及数据类型** 在以往版本中，ESP-IDF 默认设置 `configENABLE_BACKWARD_COMPATIBILITY` 选项，因此可使用 FreeRTOS v8.0.0 之前的函数名称和数据类型。该选项现在已默认禁用，因此默认情况下不再支持以往的 FreeRTOS 名称或类型。用户可以选择以下一种解决方式：

- 更新代码，删除以往的 FreeRTOS 名称或类型。
- 启用 `CONFIG_FREERTOS_ENABLE_BACKWARD_COMPATIBILITY` 以显式调用这些名称或类型。

**任务快照** 头文件 `task_snapshot.h` 已从 `freertos/task.h` 中移除。如需使用任务快照 API，请包含 `freertos/task_snapshot.h`。

函数 `vTaskGetSnapshot()` 现返回 `BaseType_t`，成功时返回值为 `pdTRUE`，失败则返回 `pdFALSE`。

**FreeRTOS 断言** 在以往版本中，FreeRTOS 断言通过 `FREERTOS_ASSERT` `kconfig` 选项独立配置，不同于系统的其他部分。该选项已移除，现在需要通过 `COMPILER_OPTIMIZATION_ASSERTION_LEVEL` 来完成配置。

**FreeRTOS 移植相关的宏** 已移除用以保证弃用 API 向后兼容性的 `portmacro_deprecated.h` 文件。建议使用下列函数来代替弃用 API。

- `portENTER_CRITICAL_NESTED()` 已移除，请使用 `portSET_INTERRUPT_MASK_FROM_ISR()` 宏。
- `portEXIT_CRITICAL_NESTED()` 已移除，请使用 `portCLEAR_INTERRUPT_MASK_FROM_ISR()` 宏。
- `vPortCPUInitializeMutex()` 已移除，请使用 `spinlock_initialize()` 函数。
- `vPortCPUAcquireMutex()` 已移除，请使用 `spinlock_acquire()` 函数。
- `vPortCPUAcquireMutexTimeout()` 已移除，请使用 `spinlock_acquire()` 函数。
- `vPortCPUReleaseMutex()` 已移除，请使用 `spinlock_release()` 函数。

### 应用程序更新

- 函数 `esp_ota_get_app_description()` 和 `esp_ota_get_app_elf_sha256()` 已弃用，请分别使用 `esp_app_get_description()` 和 `esp_app_get_elf_sha256()` 函数来代替。这些函数已移至新组件 `esp_app_format`。请参考头文件 `esp_app_desc.h`。

### 引导加载程序支持

- `esp_app_desc_t` 结构体此前在 `esp_app_format.h` 中声明，现在在 `esp_app_desc.h` 中声明。
- 函数 `bootloader_common_get_partition_description()` 已更新为私有函数，请使用代替函数 `esp_ota_get_partition_description()`。注意，此函数的第一个参数为 `esp_partition_t`，而非 `esp_partition_pos_t`。

**芯片版本** 在应用程序开始加载时，引导加载程序会检查芯片版本。只有当版本为  $\geq$  `CONFIG_ESP32H2_REV_MIN` 和  $<$  `CONFIG_ESP32H2_REV_MAX_FULL` 时，应用程序才能成功加载。

在 OTA 升级时，会检查应用程序头部中的版本需求和芯片版本是否符合条件。只有当版本为  $\geq$  `CONFIG_ESP32H2_REV_MIN` 和  $<$  `CONFIG_ESP32H2_REV_MAX_FULL` 时，应用程序才能成功更新。

## 工具

**ESP-IDF 监视器** ESP-IDF 监视器在波特率方面的改动如下：

- 目前，ESP-IDF 监视器默认遵循自定义的控制台波特率 (`CONFIG_ESP_CONSOLE_UART_BAUDRATE`)，而非 115200。
- ESP-IDF v5.0 不再支持通过 `menuconfig` 自定义波特率。
- 支持通过设置环境变量或在命令行中使用 `idf.py monitor -b <baud>` 命令自定义波特率。
- 注意，为了与全局波特率 `idf.py -b <baud>` 保持一致，波特率参数已从 `-B` 改名为 `-b`。请运行 `idf.py monitor --help` 获取更多信息。

**废弃指令** ESP-IDF v5.0 已将 `idf.py` 子命令和 `cmake` 目标名中的下划线 (`_`) 统一为连字符 (`-`)。使用废弃的子命令及目标名将会触发警告，建议使用更新后的版本。具体改动如下：



表 1: 废弃子命令及目标名

废弃名	现用名
efuse_common_table	efuse-common-table
efuse_custom_table	efuse-custom-table
erase_flash	erase-flash
partition_table	partition-table
partition_table-flash	partition-table-flash
post_debug	post-debug
show_efuse_table	show-efuse-table
erase_otadata	erase-otadata
read_otadata	read-otadata

**Esptool** `CONFIG_ESPTOOLPY_FLASHSIZE_DETECT` 选项已重命名为 `CONFIG_ESPTOOLPY_HEADER_FLASHSIZE_UPDATE`，且默认禁用。迁移到 ESP-IDF v5.0 的新项目和现有项目必须设置 `CONFIG_ESPTOOLPY_FLASHSIZE`。若因编译时 flash 大小未知而无法设置，可启用 `CONFIG_ESPTOOLPY_HEADER_FLASHSIZE_UPDATE`。但需要注意的是，启用该项后，为在烧录期间使用 flash 大小更新二进制头时不会导致摘要无效，映像后将不再附加 SHA256 摘要。

**Windows 环境** 基于 MSYS/MinGW 的 Windows 环境支持已在 ESP-IDF v4.0 中弃用，v5.0 则完全移除了该项服务。请使用 *ESP-IDF 工具安装器* 设置 Windows 兼容环境。目前支持 Windows 命令行、Power Shell 和基于 Eclipse IDE 的图形用户界面等选项。此外，还可以使用 [支持的插件](#)，设置基于 VSCode 的环境。

## 5.1.2 从 5.0 迁移到 5.1

### GCC

**GCC 版本** ESP-IDF 之前使用的 GCC 版本为 11.2.0，现已针对所有芯片目标升级至 GCC 12.2.0。若需要将代码从 GCC 11.2.0 迁移到 GCC 12.2.0，请参考以下 GCC 官方迁移指南。

- [迁移至 GCC 12](#)

**警告** 升级至 GCC 12.2.0 后会触发新警告，或是导致原有警告内容发生变化。了解所有 GCC 警告的详细内容，请参考 [GCC 警告选项](#)。建议用户仔细检查代码，并尽量解决这些警告。但由于某些警告的特殊性及用户代码的复杂性，有些警告可能为误报，需要进行关键修复。在这种情况下，用户可以采取多种方式来抑制警告。本节介绍了用户可能遇到的常见警告及如何修复这些警告。

**-Wuse-after-free** 一般而言，此警告不会针对发布版本的代码产生误报，但是这种情况可能出现在测试用例中。以下示例为如何在 ESP-IDF 的 `test_realloc.c` 中修复该警告。

```
void *x = malloc(64);
void *y = realloc(x, 48);
TEST_ASSERT_EQUAL_PTR(x, y);
```

将指针转换为 `int` 可以避免出现 `-Wuse-after-free` 警告。

```
int x = (int) malloc(64);
int y = (int) realloc((void *) x, 48);
TEST_ASSERT_EQUAL_UINT32((uint32_t) x, (uint32_t) y);
```

**-Waddress** GCC 12.2.0 引入了增强版 `-Waddress` 警告选项，该选项对 `if` 语句中的数组指针检查更加敏感。

以下代码将触发警告：

```
char array[8];
...
if (array)
    memset(array, 0xff, sizeof(array));
```

删去不必要的检查可以消除警告。

```
char array[8];
...
memset(array, 0xff, sizeof(array));
```

**在 ESP-IDF 框架之外构建 RISC-V** RISC-V 的 `zicsr` 和 `zifencei` 扩展现已独立于 I 扩展，这一变化在 GCC 12 中也有所体现。因此，在 ESP-IDF 框架之外构建 RISC-V ESP32 芯片时，请在构建系统中指定 `-march` 选项时添加 `_zicsr_zifencei` 后缀。示例如下。

原为：

```
riscv32-esp-elf-gcc main.c -march=rv32imac
```

现为：

```
riscv32-esp-elf-gcc main.c -march=rv32imac_zicsr_zifencei
```

## IEEE 802.15.4

### Receive Handle Done

**备注：**这个功能仅包括在 IDF v5.1.3 以及之后的发布中。

当收到的数据帧被处理后，用户需要调用函数 `esp_ieee802154_receive_handle_done()` 通知 802.15.4 驱动层，否则这个数据空间将不会被释放。

## 外设

**GPSPI** 不再支持以下函数。从 ESP-IDF v5.1 版本起，GPSPI 时钟源可配置。

- `spi_get_actual_clock` 已废弃，更新为 `spi_device_get_actual_freq()`。

## LEDC

- `soc_periph_ledc_clk_src_legacy_t::LEDC_USE_RTC8M_CLK` 已废弃，更新为 `LEDC_USE_RC_FAST_CLK`。

## 存储

**FatFs** `esp_vfs_fat_sdmmc_unmount()` 已弃用，可以使用 `esp_vfs_fat_sdcard_unmount()` 代替。此接口在更早的 ESP-IDF 版本中已弃用，但是尚未添加弃用警告。自 ESP-IDF v5.1 起，调用 `esp_vfs_fat_sdmmc_unmount()` 接口将会产生弃用警告。

## SPI\_FLASH

- `spi_flash_get_counters()` 已弃用，请使用 `esp_flash_get_counters()` 代替。
- `spi_flash_dump_counters()` 已弃用，请使用 `esp_flash_dump_counters()` 代替。
- `spi_flash_reset_counters()` 已弃用，请使用 `esp_flash_reset_counters()` 代替。

## 网络

**SNTP** SNTP 模块现在提供线程安全的 API 用于访问 lwIP 功能。建议使用 `ESP_NETIF` API。了解更多信息，请参考章节 [SNTP API](#)。

## 系统

### FreeRTOS

### 电源管理

- `esp_pm_config_esp32xx_t` 已弃用，应使用 `esp_pm_config_t` 替代。
- `esp32xx/pm.h` 已弃用，应使用 `esp_pm.h` 替代。

## 5.1.3 从 5.1 迁移到 5.2

## GCC

**GCC 版本** ESP-IDF 之前使用的 GCC 版本为 12.2.0，现已针对所有芯片目标升级至 GCC 13.2.0。若需将代码从 GCC 12.2.0 迁移到 GCC 13.2.0，请参考以下 GCC 官方迁移指南。

- [迁移至 GCC 13](#)

### 常见迁移问题和解决方法

**stdio.h** 不再包含 `sys/types.h`

**问题描述** 使用旧工具链的代码可能会出现编译错误，例如：

```
#include <stdio.h>
clock_t var; // error: expected specifier-qualifier-list before 'clock_t'
```

**解决方法** 使用正确的头文件可以解决这一问题。请按照以下方式重构代码：

```
#include <time.h>
clock_t var;
```

## IEEE 802.15.4

**Receive Handle Done** 当收到的数据帧被处理后，用户需要调用函数 `esp_ieee802154_receive_handle_done()` 通知 802.15.4 驱动层，否则这个数据空间将不会被释放。

## 外设

### UART

- `UART_FIFO_LEN` 已弃用，更新为 `UART_HW_FIFO_LEN`。

**I2C** I2C 驱动已经被重新设计在 `I2C`，以统一接口并扩展 I2C 外设的使用。尽管我们推荐使用新驱动层的接口，但用户仍然可以通过包含路径 `driver/i2c.h` 来使用老驱动。

主要的概念上和用法上的改变如下所示：

### 主要概念更新

- 用于初始化整个 I2C 总线的结构体 `i2c_config_t` 已经被移除。在新驱动中，从机和主机是分开的。用户可以独立调用 `i2c_master_bus_config_t` 和 `i2c_slave_config_t`。
- `i2c_mode_t` 用来判断 I2C 控制器是工作在从模式还是主模式。该枚举器已被弃用。在新驱动程序中，用户无需自行设置，驱动程序会妥善处理。
- `i2c_rw_t` 用来判断 I2C 主控制器是在进行“写”还是“读”。现在，它已被弃用。
- `i2c_addr_mode_t` 被重命名为 `i2c_addr_bit_len_t`。
- 在老驱动中，你需要将 I2C 命令通过 `I2C_LINK_RECOMMENDED_SIZE`, `i2c_cmd_link_create_static`, 等链接成链表。在新驱动中，你不需要这么做，你只需要调用相关的接口函数即可。
- 在老驱动中，选择时钟通过例如 `I2C_SCLK_SRC_FLAG_FOR_NOMAL` 的时钟标志位。在新驱动中，你可以直接选择时钟源。

### 主要用法更新

- I2C 总线初始化通过两部分完成。第一步通过 `i2c_new_master_bus()` 初始化 I2C 总线，然后初始化 I2C 设备通过 `i2c_master_bus_add_device()`。
- `i2c_reset_tx_fifo` 和 `i2c_reset_rx_fifo` 已被删除，因为用户不太需要重置 fifo。但可以通过 `i2c_master_bus_reset` 重置整个总线。
- 删除了 `i2c_cmd_link_xxx` 函数，用户不需要自己使用 `link` 来链接命令。
- `i2c_master_write_to_device` 更名为 `i2c_master_transmit`。
- `i2c_master_read_from_device` 已更名为 `i2c_master_receive`。
- `i2c_master_write_read_device` 已更名为 `i2c_master_transmit_receive`。
- `i2c_slave_write_buffer` 重命名为 `i2c_slave_transmit`。
- `i2c_slave_read_buffer` 已更名为 `i2c_slave_receive`。

## 协议

**CoAP** CoAP 相关示例已迁移至 `idf-extra-components` 仓库。

**HTTP2** `http2_request` 相关示例已迁移至 `idf-extra-components` 仓库。

## 存储

### NVS 加密

- 在集成 HMAC 外设 (`SOC_HMAC_SUPPORTED`) 的 SoC 上, 启用 *flash* 加密时将不再自动启用 NVS 加密。
- 因此需显式启用 NVS 加密, 并按照需要选择基于 flash 加密或基于 HMAC 外设的方案。即使未启用 flash 加密, 也可选择基于 HMAC 外设的方案 (`CONFIG_NVS_SEC_KEY_PROTECTION_SCHEME`)。
- 启用 flash 加密后, 未集成 HMAC 外设的 SoC 仍会自动启用 NVS 加密。

## 系统

### FreeRTOS

**升级 IDF FreeRTOS** IDF FreeRTOS 内核 (通过 FreeRTOS 实现的双核 SMP) 已升级, 现基于 Vanilla FreeRTOS v10.5.1。伴随升级, IDF FreeRTOS 的设计和实现也发生了重大变化。因此, 用户应注意以下关于内核行为和 API 的变化:

- 通过 `CONFIG_FREERTOS_UNICORE` 选项启用单核模式时, 内核行为将与 Vanilla FreeRTOS 完全相同 (详见 [单核模式](#))。
- 对于由 IDF FreeRTOS 添加的与 SMP 相关的 API, `xCoreID` 参数的检查将更加严格。为 `xCoreID` 参数提供超出范围的值现在将触发断言。
- 为了保证命名一致性, 以下与 SMP 相关的 API 现已被弃用并已重新更名:
  - 弃用 `xTaskGetAffinity()`, 更名为 `xTaskGetCoreID()`。
  - 弃用 `xTaskGetIdleTaskHandleForCPU()`, 更名为 `xTaskGetIdleTaskHandleForCore()`。
  - 弃用 `xTaskGetCurrentTaskHandleForCPU()`, 更名为 `xTaskGetCurrentTaskHandleForCore()`。

**任务快照** 由于缺乏从用户代码中使用该 API 的实际方法 (必须先暂停调度器才能调用该 API), 任务快照 API 已被设置为私有。

**紧急处理程序行为** 在配置选项 `CONFIG_ESP_SYSTEM_PANIC` 中, 是否可选择 `CONFIG_ESP_SYSTEM_PANIC_GDBSTUB` 取决于是否在构建中包含了 `esp_gdbstub` 组件。使用 `set (COMPONENTS main)` 来缩减这类构建的组件列表时, 必须将 `esp_gdbstub` 组件添加到这个组件列表中, 以使 `CONFIG_ESP_SYSTEM_PANIC_GDBSTUB` 选项可用。

### 5.1.4 从 5.2 迁移到 5.3

## 经典蓝牙

### Bluedroid

以下 Bluedroid API 已被废弃：

- `/bt/host/bluedroid/api/include/esp_bt_device.h`
  - 废弃 `esp_err_t esp_bt_dev_set_device_name(const char *name)`
    - \* 设置设备名 API 已被替换为 `esp_err_t esp_bt_gap_set_device_name(const char *name)` 或 `esp_err_t esp_ble_gap_set_device_name(const char *name)`。原来的函数已经被废弃。
  - 废弃 `esp_err_t esp_bt_dev_get_device_name(void)`
    - \* 获取设备名 API 已被替换为 `esp_err_t esp_bt_gap_get_device_name(void)` 或 `esp_err_t esp_ble_gap_get_device_name(void)`。原来的函数已经被废弃。

### GCC

#### 常见的移植问题及解决方法

##### `sys/dirent.h` 不再包含一些函数原型

**问题** 使用旧工具链的代码可能会出现编译错误。例如：

```
#include <sys/dirent.h>
/* .... */
DIR* dir = opendir("test_dir");
/* .... */
/**
 * Compile error:
 * test.c: In function 'test_opendir':
 * test.c:100:16: error: implicit declaration of function 'opendir' [-
↳Werror=implicit-function-declaration]
 *   100 |     DIR* dir = opendir(path);
 *       |                ^~~~~~
 */
```

**解决方法** 包含正确的头文件即可解决此问题。请将代码重构如下：

```
#include <dirent.h>
/* .... */
DIR* dir = opendir("test_dir");
```

## 外设

**驱动程序** 为了细粒度地控制其他组件对外设驱动的依赖，原先位于 `driver` 组件下的驱动程序被拆分到了各自独立的组件中。这些组件包括：

- `esp_driver_gptimer` - 通用定时器驱动
- `esp_driver_pcmt` - 脉冲计数器驱动
- `esp_driver_gpio` - GPIO 驱动
- `esp_driver_spi` - 通用 SPI 驱动
- `esp_driver_mcpwm` - 电机控制 PWM 驱动
- `esp_driver_sdmmc` - SDMMC 驱动
- `esp_driver_sdspi` - SDSPI 驱动
- `esp_driver_sdio` - SDIO 驱动
- `esp_driver_ana_cmpr` - 模拟比较器驱动
- `esp_driver_i2s` - I2S 驱动
- `esp_driver_dac` - DAC 驱动
- `esp_driver_rmt` - RMT 驱动
- `esp_driver_tsens` - 温度传感器驱动
- `esp_driver_sdm` - Sigma-Delta 调制器驱动
- `esp_driver_i2c` - I2C 驱动
- `esp_driver_uart` - UART 驱动
- `esp_driver_ledc` - LEDC 驱动
- `esp_driver_parlio` - 并行 IO 驱动
- `esp_driver_usb_serial_jtag` - USB\_SERIAL\_JTAG 驱动

为了兼容性，原来的 `driver` 组件仍然存在，并作为一个“all-in-one”的组件，将以上这些 `esp_driver_xyz` 组件注册成自己的公共依赖。换句话说，你无需修改既有项目的 CMake 文件，但是你现在多了一个途径去指定你项目依赖的具体的外设驱动。

原来你可能使用 `linker.lf` 指定了一些驱动函数在内存空间的链接位置，但是现在，因为驱动文件的位置发生了挪动，就需要你对 `linker.lf` 文件做出相应的改动的。假如，你的 `linker.lf` 文件里面有以下的条目：

```
[mapping:my_mapping_scheme]
archive: libdriver.a
entries:
  gpio (noflash)
```

现在需要修改成：

```
[mapping:my_mapping_scheme]
archive: libesp_driver_gpio.a
entries:
  gpio (noflash)
```

**安全元素** ATECC608A 安全元素接口示例现已移至 GitHub 上的 [esp-cryptoauthlib](#) 仓库中。

该示例也是组件管理器注册表中 [esp-cryptoauthlib](#) 的一部分。

**I2S** 回调事件 `i2s_event_data_t` 中指向 DMA 数组的二级指针 `data` 因使用过于繁琐已被弃用，请使用新增的指向 DMA 数组的一级指针 `dma_buf` 字段代替。

## Protocols

## ESP HTTPS OTA

## Breaking Changes (Summary)

- If the image length is found in the HTTP header and `esp_https_ota_config_t::bulk_flash_erase` is set to true, then instead of erasing the entire flash, the erase operation will be performed to accommodate the size of the image length.

## 安全性

**平台安全特性** 当启用 flash 加密时，仅加密 app 分区中存在的应用程序镜像，而不是加密整个分区。这可以帮助优化在首次启动期间所需的加密时间。

这可以通过配置 `CONFIG_SECURE_FLASH_ENCRYPT_ONLY_IMAGE_LEN_IN_APP_PART` 来实现，默认情况下从 ESP-IDF v5.3 开始启用，而在所有早期版本中均禁用，以避免任何破坏性行为。

## 存储

**VFS** VFS 操作符的 UART 具体实现函数从 `vfs` 组件挪到了 `esp_driver_uart` 组件中。

所有以 `esp_vfs_dev_uart_` 前缀开头的 API 已被弃用，更新成在 `uart_vfs.h` 文件中定义的以 `uart_vfs_dev_` 为前缀的一组 API。具体来说，`esp_vfs_dev_uart_register` 更名为 `uart_vfs_dev_register` - `esp_vfs_dev_uart_port_set_rx_line_endings` 更名为 `uart_vfs_dev_port_set_rx_line_endings` - `esp_vfs_dev_uart_port_set_tx_line_endings` 更名为 `uart_vfs_dev_port_set_tx_line_endings` - `esp_vfs_dev_uart_use_nonblocking` 更名为 `uart_vfs_dev_use_nonblocking` - `esp_vfs_dev_uart_use_driver` 更名为 `uart_vfs_dev_use_driver`

为了兼容性，`vfs` 组件依旧将 `esp_driver_uart` 注册成了其私有依赖。换句话说，你无需修改既有项目的 CMake 文件。

## System

### Power Management

- `esp_sleep_enable_ext1_wakeup_with_level_mask` is deprecated, use `esp_sleep_enable_ext1_wakeup_io()` and `esp_sleep_disable_ext1_wakeup_io()` instead.

**Unit Testing** In the past versions of Unity framework, it was possible to omit a semicolon at the end of a `TEST_ASSERT_*` macro statement. This is no longer the case in the newer version of Unity, used in IDF v5.3.

For example, the following code:

```
TEST_ASSERT(some_func() == ESP_OK)
```

will now result in a compilation error. To fix this, add a semicolon at the end of the statement:

```
TEST_ASSERT(some_func() == ESP_OK);
```



**Partition Table** Partition Table generation tool has been fixed to ensure that the size of partition of type `app` is having flash sector (minimum erase size) aligned size (please see [偏移地址 \(Offset\)](#) 和 [大小 \(Size\)](#) 字段). If the partition does not have aligned size, partition table generator tool will raise an error. This fix ensures that OTA updates for a case where the file size is close or equal to the size of partition works correctly (erase operation does not go beyond the partition size).

In case you have the `app` partition size which is not a multiple of the 4 KB then please note that while migrating to ESP-IDF 5.3, you must align this size to its lower 4 KB boundary for the build to succeed. This does not impact the partition table for existing devices as such but ensures that generated firmware size remains within the OTA update capability limit.

## Chapter 6

# 安全指南

### 6.1 概述

#### 6.1.1 安全

本指南概述了乐鑫解决方案中可用的整体安全功能。从 **安全** 角度考虑，强烈建议在使用乐鑫平台和 ESP-IDF 软件栈设计产品时参考本指南。

#### 目标

高级安全目标包括：

1. 防止执行不受信任的代码
2. 保护存储在外部 flash 中代码的可信度和完整性
3. 保护设备身份
4. 安全存储机密数据
5. 设备身份验证与加密通信

#### 平台安全

**安全启动** 安全启动功能可以确保设备仅执行通过身份认证的软件。安全启动时，会验证 **应用程序的启动流程** 中所涉及的所有 **可变** 软件实体，形成信任链。设备启动以及 OTA 更新过程中都会进行签名认证。

关于安全启动功能的更多详情，请参阅 [Secure Boot V2](#)。

---

**重要：** 强烈建议在所有生产设备上启用安全启动功能。

---

#### 安全启动最佳实践

- 在具备高质量熵源的系统中生成签名密钥。
- 签名密钥始终保密；签名密钥泄露会危及安全启动系统。
- 禁止第三方使用 `espsecure.py` 观察密钥生成或签名过程的相关细节，这两个过程都容易受到时序攻击或其他侧信道攻击的影响。
- 确保正确烧录所有安全性 eFuse，包括禁用调试接口以及非必需的启动介质（例如 UART 下载模式）等。

**flash 加密** flash 加密功能可以加密外部 flash 中的内容，从而保护存储在 flash 中软件或数据的 **机密性**。关于该功能的更多详情，请参阅[flash 加密](#)。

### flash 加密最佳实践

- 建议在生产环境中使用 flash 加密的发布模式。
- 建议为每个设备生成唯一的 flash 加密密钥。
- 启用[安全启动](#)作为额外保护层，防止 flash 在启动前遭受恶意攻击。

**设备身份** 在 ESP32-H2 中，数字签名外设借助硬件加速，通过 HMAC 算法生成 RSA 数字签名。RSA 私钥仅限设备硬件访问，软件无法获取，保证了设备上存储密钥的安全性。

ESP32-H2 还支持 ECDSA 外设，用于生成硬件加速的 ECDSA 数字签名。ECDSA 私钥支持直接编程到 eFuse 块中，并在软件中标记为读保护。

DS 或 ECDSA 外设可以建立与远程终端之间的 **安全设备身份**，如基于 RSA 或 ECDSA 加密算法的 TLS 双向认证。

详情请参阅[椭圆曲线数字签名算法 \(ECDSA\)](#) 及[数字签名 \(DS\)](#)。

**内存保护** ESP32-H2 可以通过架构或 PMS 等特定外设实现 **内存保护**，强制执行和监控内存以及某些外设的权限属性。使用相应外设，ESP-IDF 应用程序启动代码可以配置数据内存的读取/写入权限以及指令内存的读取/执行权限。如有任何操作尝试违反这些权限属性，如写入指令内存区域，将触发违规中断，导致系统 panic。

使用该功能需启用配置选项 `CONFIG_ESP_SYSTEM_MEMPROT_FEATURE`，该选项默认启用。请注意，该功能的 API 是 **私有的**，仅供 ESP-IDF 代码使用。

---

**备注：**内存保护功能可以防止因软件漏洞导致的远程代码注入。

---

**差分功耗分析 (DPA) 保护** ESP32-H2 支持针对 DPA 相关安全攻击的保护机制。DPA 保护通过动态调整加密外设的时钟频率，在其运行期间模糊了功耗消耗记录。时钟变化范围会根据配置的 DPA 安全级别改变。更多详情请参阅[技术参考手册](#)。

通过 `CONFIG_ESP_CRYPTO_DPA_PROTECTION_LEVEL` 可以调整 DPA 级别。级别越高安全性越强，但也可能会影响性能。默认启用最低级别 DPA 保护，可以根据安全需求修改。

---

**备注：**请注意，为确保 DPA 保护正常工作，必须启用硬件 `RNG`。

---

## 调试接口

### JTAG

- 如果启用了任一安全功能，则 JTAG 接口将保持禁用。更多详情请参阅[JTAG 与 flash 加密和安全引导](#)。
- 如果不启用其他安全功能，也可以使用 `eFuse API` 禁用 JTAG 接口。
- ESP32-H2 支持软禁用 JTAG 接口，并且可以通过 HMAC 烧录密钥重新启用，请参阅[HMAC 启用 JTAG 接口](#)。

**UART 下载模式** ESP32-H2 中，如果启用了任一安全功能，则会激活安全 UART 下载模式。

- 要启用安全 UART 下载模式，也可以调用 `esp_efuse_enable_rom_secure_download_mode()`。
- 该模式下，禁止执行通过 UART 下载模式下载的任何代码。
- 该模式将限制部分涉及更新 SPI 配置的命令，如更改波特率、基本的 flash 写入以及通过 `get_security_info` 返回当前启用的安全功能摘要。
- 要完全禁用安全 UART 下载模式，可以将 `CONFIG_SECURE_UART_ROM_DL_MODE` 设置为建议选项 `Permanently disable ROM Download Mode`，或者在运行时调用 `esp_efuse_disable_rom_download_mode()`。

---

**重要：**安全 UART 下载模式下，仅支持使用 `--no-stub` 参数调用 `esptool.py`。

---

## 产品安全

### 安全 OTA 更新

- OTA 更新必须通过安全传输进行，如 HTTPS。
- ESP-IDF 为此提供了一个简化的抽象层，即 [ESP HTTPS OTA 升级](#)。
- 如果启用了 [安全启动](#)，则服务器应托管已签名的应用程序镜像。
- 如果启用了 [flash 加密](#)，则服务器端不需要额外操作，在 flash 写入时，设备将自动加密。
- OTA 更新的 [回滚过程](#) 可以在验证完应用程序的功能后，再将应用程序切换为 `active` 状态。

**防回滚保护** 防回滚保护功能确保设备仅执行特定版本的应用程序，即应满足设备 eFuse 存储的安全版本条件。因此，即使已由合法密钥信任和签名，应用程序可能包含已撤销的安全功能或凭据，因此设备必须拒绝执行此类应用程序。

ESP-IDF 仅支持在应用程序使用该功能，并通过二级引导加载程序管理。安全版本存储在设备 eFuse 中，并在启动时和 OTA 更新期间与应用程序镜像头进行比较。

关于启用此功能的更多详情，请参阅 [防回滚](#)。

**加密固件分发** OTA 更新期间，使用加密的固件分发，可以确保在从服务器传输到设备的过程中，应用程序保持加密。OTA 更新期间，这可以作为在 TLS 通信之上的额外保护层，保护应用程序身份。

关于加密固件分发的工作示例，请参阅 [使用预加密固件进行 OTA 升级](#)。

**安全存储** 安全存储指在设备上以安全方式存储应用程序的特定数据，即将数据存储在外部 flash 中。外部 flash 通常是可读写的 flash 分区，用于存储设备特定的配置数据，如 Wi-Fi 凭据。

ESP-IDF 提供了 **NVS（非易失性存储）** 管理组件，允许加密数据分区。该功能与上文提到的 [flash 加密](#) 平台功能相关。

关于该功能的工作原理和启用说明，请参阅 [NVS 加密](#)。

---

**重要：**ESP-IDF 组件会默认将 Wi-Fi 证书等设备特定数据写入 NVS 默认分区，建议使用 **NVS 加密** 功能来保护这些数据。

---

**安全设备控制** ESP-IDF 提供了 ESP 本地控制组件，可以通过 Wi-Fi/Ethernet + HTTP 或 BLE 安全地控制 ESP 设备。

关于该功能的更多详情，请参阅 [ESP 本地控制](#)。

## 安全策略

ESP-IDF GitHub 代码库内含 [安全政策介绍](#)。

## 公告

- 乐鑫会发布重要 [安全公告](#)，包括硬件和软件相关公告。
- ESP-IDF 软件组件的相关安全公告会发布在 [GitHub 仓库](#)。

**软件更新** ESP-IDF 会及时处理针对组件和第三方库的相关报告，并修复关键安全问题。修复内容会逐步同步到 ESP-IDF 的所有适用版本分支中。

ESP-IDF 的发布说明将涵盖各 ESP-IDF 组件和第三方库的相应安全问题和 CVE 编号。

---

**重要：** 为获取所有关键安全修复，建议定期更新到 ESP-IDF 的最新 Bugfix 版本。

---

## 6.2 功能

### 6.2.1 flash 加密

本文档旨在引导用户快速了解 ESP32-H2 的 flash 加密功能，通过应用程序代码示例向用户演示如何在开发及生产过程中测试及验证 flash 加密的相关操作。

#### 概述

flash 加密功能用于加密与 ESP32-H2 搭载使用的片外 flash 中的内容。启用 flash 加密功能后，固件会以明文形式烧录，然后在首次启动时将数据进行加密。因此，物理读取 flash 将无法恢复大部分 flash 内容。

---

**重要：** 对于生产用途，flash 加密仅应在“发布”模式下启用。

---

---

**重要：** 启用 flash 加密将限制后续 ESP32-H2 更新。在使用 flash 加密功能前，请务必阅读本文档了解其影响。

---

#### 加密分区

启用 flash 加密后，会默认加密以下类型的数据：

- [二级引导程序](#)（固件引导加载程序）
- 分区表
- [NVS 密钥分区](#)
- Otadata
- 所有 app 类型的分区

其他类型的数据将视情况进行加密：

- 分区表中标有 encrypted 标志的分区。如需了解详情，请参考[加密分区标志](#)。
- 如果启用了安全启动，则会对安全启动引导程序摘要进行加密（见下文）。

#### 相关 eFuses

flash 加密操作由 ESP32-H2 上的多个 eFuse 控制。以下是这些 eFuse 列表及其描述，下表中的各 eFuse 名称也在 espfuse.py 工具中使用，为了能在 eFuse API 中使用，请在名称前加上 ESP\_EFUSE\_，如：esp\_efuse\_read\_field\_bit(ESP\_EFUSE\_DISABLE\_DL\_ENCRYPT)。

表 1: flash 加密过程中使用的 eFuses

eFuse	描述	位深
BLOCK_KEYN	AES 密钥存储, N 在 0-5 之间。	256 位密钥块
KEY_PURPOSE_N	控制 eFuse 块 BLOCK_KEYN 的目的, 其中 N 在 0 到 5 之间。对于 flash 加密, 唯一的有效值是 4, 代表 XTS_AES_128_KEY。	4
DIS_DOWNLOAD_MANUAL_ENCRYPT	设置后, 则在下下载引导模式时禁用 flash 加密。	1
SPI_BOOT_CRYPT_CNT	设置 SPI 启动模式后, 可启用加密和解密。如果在 eFuse 中设置 1 或 3 个比特位, 则启用该功能, 否则将禁用。	3

**备注:**

- 上表中列出的所有 eFuse 位都提供读/写访问控制。
- 这些位的默认值是 0。

对上述 eFuse 位的读写访问由 WR\_DIS 和 RD\_DIS 寄存器中的相应字段控制。有关 ESP32-H2 eFuse 的详细信息, 请参考 [eFuse 管理器](#)。要使用 esefuse.py 更改 eFuse 字段的保护位, 请使用以下两个命令: read\_protect\_efuse 和 write\_protect\_efuse。例如 esefuse.py write\_protect\_efuse DISABLE\_DL\_ENCRYPT。

**flash 的加密过程**

假设 eFuse 值处于默认状态, 且固件的引导加载程序编译为支持 flash 加密, 则 flash 加密的具体过程如下:

1. 第一次开机复位时, flash 中的所有数据都是未加密的 (明文)。ROM 引导加载程序加载固件引导加载程序。
2. 固件的引导加载程序将读取 SPI\_BOOT\_CRYPT\_CNT eFuse 值 (0b000)。因为该值为 0 (偶数位), 固件引导加载程序将配置并启用 flash 加密块。关于 flash 加密块的更多信息, 请参考 [ESP32-H2 技术参考手册](#)。
3. 固件的引导加载程序使用 RNG (随机数发生器) 模块生成 256 位密钥, 然后将其写入 BLOCK\_KEYN eFuse。软件也为存储密钥的块更新了 KEY\_PURPOSE\_N。由于 BLOCK\_KEYN eFuse 已设置了读保护和写保护位, 因此无法通过软件访问密钥。KEY\_PURPOSE\_N 字段也受写保护。flash 加密操作完全在硬件中完成, 无法通过软件访问密钥。如果 eFuse 中已经存在有效密钥 (例如用 esefuse 工具烧写的密钥), 则会跳过密钥生成, 并将该密钥用于 flash 加密过程。
4. flash 加密块将加密 flash 的内容 (固件的引导加载程序、应用程序、以及标有“加密”标志的分区)。就地加密可能会耗些时间 (对于大分区最多需要一分钟)。
5. 固件引导加载程序将在 SPI\_BOOT\_CRYPT\_CNT (0b001) 中设置第一个可用位来对已加密的 flash 内容进行标记。设置奇数位。
6. 对于 [开发模式](#), 固件引导加载程序允许 UART 引导加载程序重新烧录加密后的二进制文件。同时, SPI\_BOOT\_CRYPT\_CNT eFuse 位不受写入保护。此外, 默认情况下, 固件引导加载程序设置 DIS\_DOWNLOAD\_ICACHE、DIS\_PAD\_JTAG、DIS\_USB\_JTAG 和 DIS\_LEGACY\_SPI\_BOOT eFuse 位。
7. 对于 [发布模式](#), 固件引导加载程序设置所有在开发模式下设置的 eFuse 位以及 DIS\_DOWNLOAD\_MANUAL\_ENCRYPT。它还写保护 SPI\_BOOT\_CRYPT\_CNT eFuse 位。要修改此行为, 请参阅 [启用 UART 引导加载程序加密/解密](#)。
8. 重新启动设备以开始执行加密镜像。固件引导加载程序调用 flash 解密块来解密 flash 内容, 然后将解密的内容加载到 IRAM 中。

在开发阶段常需编写不同的明文 flash 镜像并测试 flash 的加密过程。这要求固件下载模式能够根据需求不断加载新的明文镜像。但是, 在制造和生产过程中, 出于安全考虑, 固件下载模式不应有权限访问 flash 内容。

因此需要有两种不同的 flash 加密配置: 一种用于开发, 另一种用于生产。详情请参考 [flash 加密设置](#) 小节。



## flash 加密设置

提供以下 flash 加密模式：

- **开发模式** - 建议仅在开发过程中使用。因为在这种模式下，仍然可以将新的明文固件烧录到设备，并且引导加载程序将使用存储在硬件中的密钥对该固件进行透明加密。此操作间接允许从 flash 中读出固件明文。
- **发布模式** - 推荐用于制造和生产。因为在这种模式下，如果不知道加密密钥，则不可能将明文固件烧录到设备。

本节将详细介绍上述 flash 加密模式，并且逐步说明如何使用它们。

**开发模式** 在开发过程中，可使用 ESP32-H2 内部生成的密钥或外部主机生成的密钥进行 flash 加密。

**使用 ESP32-H2 生成的密钥** 开发模式允许用户使用固件下载模式下下载多个明文镜像。

测试 flash 加密过程需完成以下步骤：

1. 确保你的 ESP32-H2 设备有相关 *eFuses* 中所示的 flash 加密 eFuse 的默认设置。  
请参考如何检查 *ESP32-H2 flash 加密状态*。
2. 在 **项目配置菜单**，执行以下操作：
  - 启动时使能 *flash 加密*。
  - 选择加密模式（默认是 **开发模式**）。
  - 选择 *UART ROM 下载模式*（默认是 **启用**）。
  - 选择适当详细程度的 *引导加载程序日志*。
  - 保存配置并退出。

启用 flash 加密将增大引导加载程序，因而可能需更新分区表偏移量。请参考 *引导加载程序大小*。

3. 运行以下命令来构建和烧录完整的镜像。

```
idf.py flash monitor
```

**备注：** 这个命令不包括任何应该写入 flash 分区的用户文件。请在运行此命令前手动写入这些文件，否则在写入前应单独对这些文件进行加密。

该命令将向 flash 写入未加密的镜像：固件引导加载程序、分区表和应用程序。烧录完成后，ESP32-H2 将复位。在下次启动时，固件引导加载程序会加密：固件引导加载程序、应用程序分区和标记为“加密”的分区，然后复位。就地加密可能需要时间，对于大分区最多需要一分钟。之后，应用程序在运行时解密并执行命令。

下面是启用 flash 加密后 ESP32-H2 首次启动时的样例输出：

TO BE UPDATED

启用 flash 加密后，在下次启动时输出将显示已启用 flash 加密，样例输出如下：

TO BE UPDATED

在此阶段，如果用户需要更新或重新烧录二进制文件，请参考 *重新烧录更新后的分区*。

**使用主机生成的密钥** 可在主机中预生成 flash 加密密钥，并将其烧录到 eFuse 密钥块中。这样，无需明文 flash 更新便可以在主机上预加密数据并将其烧录。该功能可在 **开发模式** 和 **发布模式** 两模式下使用。如果没有预生成的密钥，数据将以明文形式烧录，然后 ESP32-H2 对数据进行就地加密。

**备注：** 不建议在生产中使用该方法，除非为每个设备都单独生成一个密钥。

使用主机生成的密钥需完成以下步骤：

1. 确保你的 ESP32-H2 设备有[相关 eFuses](#) 中所示的 flash 加密 eFuse 的默认设置。  
请参考[如何检查 ESP32-H2 flash 加密状态](#)。

2. 通过运行以下命令生成一个随机密钥：

```
espssecure.py generate_flash_encryption_key my_flash_encryption_key.bin
```

3. **在第一次加密启动前**，使用以下命令将该密钥烧录到设备上，这个操作只能执行一次。

```
espefuse.py --port PORT burn_key BLOCK my_flash_encryption_key.bin XTS_
→AES_128_KEY
```

其中 BLOCK 是 BLOCK\_KEY0 和 BLOCK\_KEY5 之间的一个空闲密钥区。

如果未烧录密钥并在启用 flash 加密后启动设备，ESP32-H2 将生成一个软件无法访问或修改的随机密钥。

4. 在[项目配置菜单](#)中进行如下设置：
  - [启动时启用 flash 加密功能](#)
  - [选择加密模式](#)（默认为[开发模式](#)）
  - [选择适当详细程度的引导加载程序日志](#)
  - [保存配置并退出](#)

启用 flash 加密将增大引导加载程序，因而可能需更新分区表偏移量。请参考[引导加载程序大小](#)。

5. 运行以下命令来构建并烧录完整的镜像：

```
idf.py flash monitor
```

**备注：**这个命令不包括任何应该被写入 flash 上的分区用户文件。请在运行此命令前手动写入这些文件，否则在写入前应单独对这些文件进行加密。

该命令将向 flash 写入未加密的镜像：固件引导加载程序、分区表和应用程序。烧录完成后，ESP32-H2 将复位。在下次启动时，固件引导加载程序会加密：固件引导加载程序、应用程序分区和标记为加密的分区，然后复位。就地加密可能需要时间，对于大的分区来说可能耗时一分钟。之后，应用程序在运行时被解密并执行。

如果使用开发模式，那么更新和重新烧录二进制文件最简单的方法是[重新烧录更新后的分区](#)。

如果使用发布模式，那么可以在主机上预先加密二进制文件，然后将其作为密文烧录。具体请参考[手动加密文件](#)。

**重新烧录更新后的分区** 如果用户以明文方式更新了应用程序代码并需要重新烧录，则需要在烧录前对其进行加密。请运行以下命令一次完成应用程序的加密与烧录：

```
idf.py encrypted-app-flash monitor
```

如果所有分区都需要以加密形式更新，请运行：

```
idf.py encrypted-flash monitor
```

**发布模式** 在发布模式下，UART 引导加载程序无法执行 flash 加密操作，**只能**使用 OTA 方案下载新的明文镜像，该方案将在写入 flash 前加密明文镜像。

使用该模式需要执行以下步骤：

1. 确保你的 ESP32-H2 设备有[相关 eFuses](#) 中所示的 flash 加密 eFuse 的默认设置。  
请参考[如何检查 ESP32-H2 flash 加密状态](#)。



2. 在**项目配置菜单**，执行以下操作：

- 启动时使能 *flash* 加密
- 选择发布模式（注意一旦选择了发布模式，EFUSE\_DIS\_DOWNLOAD\_MANUAL\_ENCRYPT eFuse 位将被编程为在 ROM 下载模式下禁用 flash 加密硬件。）
- 选择 *UART ROM* 下载（推荐永久性的切换到安全模式）。这是默认且推荐使用的选项。如果不需要该模式，也可以改变此配置设置永久地禁用 UART ROM 下载模式。
- 选择适当详细程度的引导加载程序日志
- 保存配置并退出

启用 flash 加密将增大引导加载程序，因而可能需更新分区表偏移量。请参考[引导加载程序大小](#)。

3. 运行以下命令来构建并烧录完整的镜像：

```
idf.py flash monitor
```

**备注：** 这个命令不包括任何应该被写入 flash 分区的用户文件。请在运行此命令前手动写入这些文件，否则在写入前应单独对这些文件进行加密。

该命令将向 flash 写入未加密的镜像：固件引导加载程序、分区表和应用程序。烧录完成后，ESP32-H2 将复位。在下次启动时，固件引导加载程序会加密：固件引导加载程序、应用程序分区和标记为加密的分区，然后复位。就地加密可能需要时间，对于大的分区来说可能耗时一分钟。之后，应用程序在运行时被解密并执行。

一旦在发布模式下启用 flash 加密，引导加载程序将写保护 SPI\_BOOT\_CRYPT\_CNT eFuse。

请使用 [OTA 方案](#) 对字段中的明文进行后续更新。

**备注：** 如果用户已经预先生成了 flash 加密密钥并存储了一个副本，并且 UART 下载模式没有通过 [CONFIG\\_SECURE\\_UART\\_ROM\\_DL\\_MODE](#) 永久禁用，那么可以通过使用 `espsecure.py encrypt_flash_data --aes_xts` 预加密文件，从而在本地更新 flash，然后烧录密文。请参考[手动加密文件](#)。

**最佳实践** 在生产中使用 flash 加密时：

- 不要在多个设备之间重复使用同一个 flash 加密密钥，这样攻击者就无法从一台设备上复制加密数据后再将其转移到第二台设备上。
- 如果不需要 UART ROM 下载模式，则应完全禁用该模式，或者永久设置为“安全下载模式”。安全下载模式永久性地将可用的命令限制在更新 SPI 配置、更改波特率、基本的 flash 写入和使用 `get_security_info` 命令返回当前启用的安全功能摘要。默认在发布模式下第一次启动时设置为安全下载模式。要完全禁用下载模式，请选择 [CONFIG\\_SECURE\\_UART\\_ROM\\_DL\\_MODE](#) 为“永久禁用 ROM 下载模式（推荐）”或在运行时调用 `esp_efuse_disable_rom_download_mode()`。
- 启用 [安全启动](#) 作为额外的保护层，防止攻击者在启动前有选择地破坏 flash 中某部分。

### 外部启用 flash 加密

在上述过程中，对与 flash 加密相关的 eFuse 是通过固件引导加载程序烧写的，或者，也可以借助 `espefuse` 工具烧写 eFuse。如需了解详情，请参考[Enable Flash Encryption Externally](#)。

### 可能出现的错误

一旦启用 flash 加密，SPI\_BOOT\_CRYPT\_CNT 的 eFuse 值将设置为奇数位。这意味着所有标有加密标志的分区都会包含加密的密本。如果 ESP32-H2 错误地加载了明文数据，则会出现以下三种典型的错误情

况:

1. 如果通过 **明文固件引导加载程序镜像** 重新烧录了引导加载程序分区，则 ROM 加载器将无法加载固件引导加载程序，并会显示以下错误类型：

```
rst:0x3 (SW_RESET),boot:0x13 (SPI_FAST_FLASH_BOOT)
invalid header: 0xb414f76b
invalid header: 0xb414f76b
invalid header: 0xb414f76b
invalid header: 0xb414f76b
invalid header: 0xb414f76b
invalid header: 0xb414f76b
invalid header: 0xb414f76b
```

**备注：**不同应用程序中无效头文件的值不同。

**备注：**如果 flash 内容被擦除或损坏，也会出现这个错误。

2. 如果固件的引导加载程序已加密，但通过 **明文分区表镜像** 重新烧录了分区表，引导加载程序将无法读取分区表，从而出现以下错误：

```
rst:0x3 (SW_RESET),boot:0x13 (SPI_FAST_FLASH_BOOT)
configsip: 0, SPIWP:0xee
clk_drv:0x00,q_drv:0x00,d_drv:0x00,cs0_drv:0x00,hd_drv:0x00,wp_drv:0x00
mode:DIO, clock div:2
load:0x3fff0018,len:4
load:0x3fff001c,len:10464
ho 0 tail 12 room 4
load:0x40078000,len:19168
load:0x40080400,len:6664
entry 0x40080764
I (60) boot: ESP-IDF v4.0-dev-763-g2c55fae6c-dirty 2nd stage bootloader
I (60) boot: compile time 19:15:54
I (62) boot: Enabling RNG early entropy source...
I (67) boot: SPI Speed      : 40MHz
I (72) boot: SPI Mode      : DIO
I (76) boot: SPI Flash Size : 4MB
E (80) flash_parts: partition 0 invalid magic number 0x94f6
E (86) boot: Failed to verify partition table
E (91) boot: load partition table error!
```

3. 如果引导加载程序和分区表已加密，但使用 **明文应用程序镜像** 重新烧录了应用程序，引导加载程序将无法加载应用程序，从而出现以下错误：

```
rst:0x3 (SW_RESET),boot:0x13 (SPI_FAST_FLASH_BOOT)
configsip: 0, SPIWP:0xee
clk_drv:0x00,q_drv:0x00,d_drv:0x00,cs0_drv:0x00,hd_drv:0x00,wp_drv:0x00
mode:DIO, clock div:2
load:0x3fff0018,len:4
load:0x3fff001c,len:8452
load:0x40078000,len:13616
load:0x40080400,len:6664
entry 0x40080764
I (56) boot: ESP-IDF v4.0-dev-850-gc4447462d-dirty 2nd stage bootloader
I (56) boot: compile time 15:37:14
I (58) boot: Enabling RNG early entropy source...
I (64) boot: SPI Speed      : 40MHz
I (68) boot: SPI Mode      : DIO
I (72) boot: SPI Flash Size : 4MB
```

(下页继续)

(续上页)

```

I (76) boot: Partition Table:
I (79) boot: ## Label                Usage                Type ST Offset   Length
I (87) boot:  0 nvs                   WiFi data            01 02 0000a000 00006000
I (94) boot:  1 phy_init              RF data              01 01 00010000 00001000
I (102) boot:  2 factory              factory app          00 00 00020000 00100000
I (109) boot: End of partition table
E (113) esp_image: image at 0x20000 has invalid magic byte
W (120) esp_image: image at 0x20000 has invalid SPI mode 108
W (126) esp_image: image at 0x20000 has invalid SPI size 11
E (132) boot: Factory app partition is not bootable
E (138) boot: No bootable app partitions in the partition table

```

## ESP32-H2 flash 加密状态

1. 确保你的 ESP32-H2 设备有相关 *eFuses* 中所示的 flash 加密 eFuse 的默认设置。

要检查你的 ESP32-H2 设备上是否启用了 flash 加密，请执行以下操作之一：

- 将应用示例 [security/flash\\_encryption](#) 烧录到你的设备上。此应用程序会打印 SPI\_BOOT\_CRYPT\_CNT eFuse 值，以及是否启用了 flash 加密。
- 查询设备所连接的串口名称，在以下命令中将 PORT 替换为串口名称后运行：

```
espefuse.py -p PORT summary
```

## 在加密的 flash 中读写数据

ESP32-H2 应用程序代码可以通过调用函数 `esp_flash_encryption_enabled()` 来检查当前是否启用了 flash 加密。此外，设备可以通过调用函数 `esp_get_flash_encryption_mode()` 来识别 flash 加密模式。

一旦启用 flash 加密，使用代码访问 flash 内容时要更加小心。

**flash 加密范围** 当 SPI\_BOOT\_CRYPT\_CNT eFuse 设置为奇数位的值，所有通过 MMU 的 flash 缓存访问的 flash 内容都将被透明解密。包括：

- flash 中可执行的应用程序代码 (IROM)。
- 所有存储于 flash 中的只读数据 (DROM)。
- 通过函数 `spi_flash_mmap()` 访问的任意数据。
- ROM 引导加载程序读取的固件引导加载程序镜像。

**重要：** MMU flash 缓存将无条件解密所有数据。flash 中未加密存储的数据将通过 flash 缓存“被透明解密”，并在软件中存储为随机垃圾数据。

**读取加密的 flash** 如果需要在不使用 flash 缓存 MMU 映射的情况下读取数据，推荐使用分区读取函数 `esp_partition_read()`。该函数只会解密从加密分区读取的数据。从未加密分区读取的数据不会被解密。这样，软件便能以相同的方式访问加密和未加密的 flash。

也可以使用以下 SPI flash API 函数：

- 通过函数 `esp_flash_read()` 读取不会被解密的原（加密）数据。
- 通过函数 `esp_flash_read_encrypted()` 读取和解密数据。

使用非易失性存储器 (NVS) API 存储的数据始终从 flash 加密的角度进行存储和读取解密。如有需要，则由库提供加密功能。详情可参考 [NVS 加密](#)。

**写入加密的 flash** 推荐使用分区写入函数 `esp_partition_write()`。此函数只会在将数据写入加密分区时加密数据，而写入未加密分区的数据不会被加密。通过这种方式，软件可以以相同的方式访问加密和非加密 flash。

也可以使用函数 `esp_flash_write_encrypted()` 预加密和写入数据。

此外，`esp-idf` 应用程序中存在但不支持以下 ROM 函数：

- `esp_rom_spiflash_write_encrypted` 预加密并将数据写入 flash
- `SPIWrite` 将未加密的数据写入 flash

由于数据是按块加密的，加密数据最小的写入大小为 16 字节，对齐也是 16 字节。

## 更新加密的 flash

**OTA 更新** 如果使用函数 `esp_partition_write()`，对加密分区的 OTA 更新将自动以加密形式写入。

在为已加密设备的 OTA 更新构建应用程序镜像之前，启用项目配置菜单中的 **启动时使能 flash 加密** 选项。请参考 [OTA](#) 获取更多关于 ESP-IDF OTA 更新的信息。

**通过串口更新加密 flash** 通过串行引导加载程序烧录加密设备，需要串行引导加载程序下载接口没有通过 eFuse 被永久禁用。

在开发模式下，推荐的方法是 [重新烧录更新后的分区](#)。

在发布模式下，如果主机上有存储在 eFuse 中的相同密钥的副本，那么就可以在主机上对文件进行预加密，然后进行烧录，具体请参考 [手动加密文件](#)。

## 关闭 flash 加密

如果意外启用了 flash 加密，则明文数据的 flash 会使 ESP32-H2 无法正常启动。设备将不断重启，并报错 `flash read err, 1000` 或 `invalid header: 0xxxxxxx`。

对于开发模式下的 flash 加密，可以通过烧录 `SPI_BOOT_CRYPT_CNT` efuse 来关闭加密。每个芯片仅有 1 次机会，请执行以下步骤：

1. 在 **项目配置菜单** 中，禁用 **启动时使能 flash 加密** 选项，然后保存并退出。
2. 再次打开项目配置菜单，再次检查你是否已经禁用了该选项，如果这个选项仍被启用，引导加载程序在启动时将立即重新启用加密功能。
3. 在禁用 flash 加密后，通过运行 `idf.py flash` 来构建和烧录新的引导加载程序 and 应用程序。
4. 使用 `espefuse.py`（在 `components/esptool_py/esptool` 中）以关闭 `SPI_BOOT_CRYPT_CNT`，运行：

```
espefuse.py burn_efuse SPI_BOOT_CRYPT_CNT
```

重置 ESP32-H2，flash 加密应处于关闭状态，引导加载程序将正常启动。

## flash 加密的要点

- 通过 ESP32-H2 的 flash 缓存映射功能，flash 可支持透明访问——任何映射到地址空间的 flash 区域在读取时都将被透明地解密。  
为便于访问，某些数据分区最好保持未加密状态，或者也可使用对已加密数据无效的 flash 友好型更新算法。由于 NVS 库无法与 flash 加密直接兼容，因此无法加密非易失性存储器的 NVS 分区。详情可参见 [NVS 加密](#)。
- 如果以后可能需要启用 flash 加密，则编程人员在编写 [使用加密 flash](#) 代码时需小心谨慎。
- 如果已启用安全启动，重新烧录加密设备的引导加载程序则需要“可重新烧录”的安全启动摘要（可参考 [flash 加密与安全启动](#)）。

启用 flash 加密将增大引导加载程序，因此可能需更新分区表偏移量。请参考[引导加载程序大小](#)。

**重要：**在首次启动加密过程中，请勿切断 ESP32-H2 的电源。如果电源被切断，flash 的内容将受到破坏，并需要重新烧录未加密数据。而这类重新烧录将不计入烧录限制次数。

### flash 加密的局限性

flash 加密可以保护固件，防止未经授权的读取与修改。了解 flash 加密系统的局限之处亦十分重要：

- flash 加密功能与密钥同样稳固。因而，推荐在首次启动设备时，在设备上生成密钥（默认行为）。如果在设备外生成密钥，请确保遵循正确的后续步骤，不要在所有生产设备之间使用相同的密钥。
- 并非所有数据都是加密存储。因而在 flash 上存储数据时，请检查你使用的存储方式（库、API 等）是否支持 flash 加密。
- flash 加密无法防止攻击者获取 flash 的高层次布局信息。这是因为每对相邻的 16 字节 AES 块都使用相邻的 AES 密钥。当这些相邻的 16 字节块中包含相同内容时（如空白或填充区域），这些字节块将加密以产生匹配的加密块对。这让攻击者可在加密设备间进行高层次对比（例如，确认两设备是否可能运行相同的固件版本）。
- 单独使用 flash 加密可能无法防止攻击者修改本设备的固件。为防止设备上运行未经授权的固件，可搭配 flash 加密使用[安全启动](#)。

### flash 加密与安全启动

推荐 flash 加密与安全启动搭配使用。但是，如果已启用安全启动，则重新烧录设备时会受到其他限制：

- 如果新的应用程序已使用安全启动签名密钥正确签名，则[OTA 更新](#)不受限制。

### flash 加密的高级功能

以下部分介绍了 flash 加密的高级功能。

**加密分区标志** 部分分区默认为已加密。通过在分区的标志字段中添加“encrypted”标志，可在分区表描述中将其他分区标记为需要加密。在这些标记分区中的数据会和应用程序分区一样视为加密数据。

```
# Name, Type, SubType, Offset, Size, Flags
nvs, data, nvs, 0x9000, 0x6000
phy_init, data, phy, 0xf000, 0x1000
factory, app, factory, 0x10000, 1M
secret_data, 0x40, 0x01, 0x20000, 256K, encrypted
```

请参考[分区表](#)获取更多关于分区表描述的具体信息。

关于分区加密，还需了解以下信息：

- 默认分区表都不包含任何加密数据分区。
- 启用 flash 加密后，“app”分区一般都视为加密分区，因此无需标记。
- 如果未启用 flash 加密，则“encrypted”标记无效。
- 将可选 phy 分区标记为“encrypted”，可以防止物理访问读取或修改 phy\_init 数据。
- nvs 分区无法标记为“encrypted”因为 NVS 库与 flash 加密不直接兼容。

**启用 UART 引导加载程序加密/解密** 在第一次启动时，flash 加密过程默认会烧录以下 eFuse：

- DIS\_DOWNLOAD\_MANUAL\_ENCRYPT 在 UART 引导加载程序启动模式下运行时，禁止 flash 加密操作。



- `DIS_DIRECT_BOOT`` (即之前的 ``DIS_LEGACY_SPI_BOOT`) 禁用传统的 SPI 启动模式。

为了能启用这些功能，可在首次启动前仅烧录部分 eFuse，并用未设置值 0 写保护其他部分。例如：

```
espfuse.py --port PORT burn_efuse DIS_DOWNLOAD_MANUAL_ENCRYPT
espfuse.py --port PORT write_protect_efuse DIS_DOWNLOAD_MANUAL_ENCRYPT
```

**备注：** 请注意在写保护前设置所有适当的位！

一个位可以控制三个 eFuse 的写保护，这意味着写保护一个 eFuse 位将写保护所有未设置的 eFuse 位。

由于 `esptool.py` 目前不支持读取加密 flash，所以对这些 eFuse 进行写保护从而使其保持未设置目前来说并不是很有用。

**JTAG 调试** 默认情况下，当启用 flash 加密（开发或发布模式）时，将通过 eFuse 禁用 JTAG 调试。引导加载程序在首次启动时执行此操作，同时启用 flash 加密。

请参考 [JTAG 与 flash 加密和安全引导](#) 了解更多关于使用 JTAG 调试与 flash 加密的信息。

**手动加密文件** 手动加密或解密文件需要在 eFuse 中预烧录 flash 加密密钥（请参阅 [使用主机生成的密钥](#)）并在主机上保留一份副本。如果 flash 加密配置在开发模式下，那么则不需要保留密钥的副本或遵循这些步骤，可以使用更简单的 [重新烧录更新后的分区](#) 步骤。

密钥文件应该是单个原始二进制文件（例如：`key.bin`）。

例如，以下是将文件 `build/my-app.bin` 进行加密、烧录到偏移量 `0x10000` 的步骤。运行 `espsecure.py`，如下所示：

```
espsecure.py encrypt_flash_data --aes_xts --keyfile /path/to/key.bin --address_
↳0x10000 --output my-app-ciphertext.bin build/my-app.bin
```

然后可以使用 `esptool.py` 将文件 `my-app-ciphertext.bin` 写入偏移量 `0x10000`。关于为 `esptool.py` 推荐的所有命令行选项，请查看 `idf.py build` 成功时打印的输出。

**备注：**

如果 ESP32-H2 在启动时无法识别烧录进去的密文文件，请检查密钥是否匹配以及命令行参数是否完全匹配，包括偏移量是否正确。

`espsecure.py decrypt_flash_data` 命令可以使用同样的选项（和不同的输入/输出文件）来解密 flash 密文或之前加密的文件。

## 技术细节

以下章节将提供 flash 加密操作的相关信息。

- 有关在 Python 中实现的完整 flash 加密算法，可参见 `espsecure.py` 源代码中的函数 `_flash_encryption_operation()`。

## flash 加密算法

- ESP32-H2 使用 XTS-AES 块密码模式进行 flash 加密，密钥大小为 256 位。
- XTS-AES 是一种专门为光盘加密设计的块密码模式，它解决了其它潜在模式如 AES-CTR 在此使用情景下的不足。有关 XTS-AES 算法的详细描述，请参考 [IEEE Std 1619-2007](#)。
- flash 加密的密钥存储于一个 `BLOCK_KEYN` eFuse 中，默认受保护防止进一步写入或软件读取。
- 有关在 Python 中实现的完整 flash 加密算法，可参见 `espsecure.py` 源代码中的函数 `_flash_encryption_operation()`。

## 6.2.2 Secure Boot V2

**重要:** This document is about Secure Boot V2, supported on ESP32-H2

Secure Boot V2 uses RSA-PSS or ECDSA based app and bootloader (二级引导程序) verification. This document can also be used as a reference for signing apps using the RSA-PSS or ECDSA scheme without signing the bootloader.

---

### Background

Secure Boot protects a device from running any unauthorized (i.e., unsigned) code by checking that each piece of software that is being booted is signed. On an ESP32-H2, these pieces of software include the second stage bootloader and each application binary. Note that the first stage bootloader does not require signing as it is ROM code thus cannot be changed.

ESP32-H2 has provision to choose between a RSA-PSS or ECDSA based secure boot verification scheme.

The Secure Boot process on the ESP32-H2 involves the following steps:

1. When the first stage bootloader loads the second stage bootloader, the second stage bootloader's RSA-PSS or ECDSA signature is verified. If the verification is successful, the second stage bootloader is executed.
2. When the second stage bootloader loads a particular application image, the application's RSA-PSS or ECDSA signature is verified. If the verification is successful, the application image is executed.

### Advantages

- The RSA-PSS or ECDSA public key is stored on the device. The corresponding RSA-PSS or ECDSA private key is kept at a secret place and is never accessed by the device.
- Up to three public keys can be generated and stored in the chip during manufacturing.
- ESP32-H2 provides the facility to permanently revoke individual public keys. This can be configured conservatively or aggressively.
- Conservatively - The old key is revoked after the bootloader and application have successfully migrated to a new key. Aggressively - The key is revoked as soon as verification with this key fails.
- Same image format and signature verification method is applied for applications and software bootloader.
- No secrets are stored on the device. Therefore, it is immune to passive side-channel attacks (timing or power analysis, etc.)

### Secure Boot V2 Process

This is an overview of the Secure Boot V2 Process. Instructions how to enable Secure Boot are supplied in section [How To Enable Secure Boot V2](#).

Secure Boot V2 verifies the bootloader image and application binary images using a dedicated *signature block*. Each image has a separately generated signature block which is appended to the end of the image.

Up to 3 signature blocks can be appended to the bootloader or application image in ESP32-H2.

Each signature block contains a signature of the preceding image as well as the corresponding RSA-3072, ECDSA-256, or ECDSA-192 public key. For more details about the format, refer to [Signature Block Format](#). A digest of the RSA-3072, ECDSA-256, or ECDSA-192 public key is stored in the eFuse.

The application image is not only verified on every boot but also on each over the air (OTA) update. If the currently selected OTA app image cannot be verified, the bootloader will fall back and look for another correctly signed application image.

The Secure Boot V2 process follows these steps:

1. On startup, the ROM code checks the Secure Boot V2 bit in the eFuse. If Secure Boot is disabled, a normal boot will be executed. If Secure Boot is enabled, the boot will proceed according to the following steps.

2. The ROM code verifies the bootloader's signature block (*Verifying a Signature Block*). If this fails, the boot process will be aborted.
3. The ROM code verifies the bootloader image using the raw image data, its corresponding signature block(s), and the eFuse (*Verifying an Image*). If this fails, the boot process will be aborted.
4. The ROM code executes the bootloader.
5. The bootloader verifies the application image's signature block (*Verifying a Signature Block*). If this fails, the boot process will be aborted.
6. The bootloader verifies the application image using the raw image data, its corresponding signature blocks and the eFuse (*Verifying an Image*). If this fails, the boot process will be aborted. If the verification fails but another application image is found, the bootloader will then try to verify that other image using steps 5 to 7. This repeats until a valid image is found or no other images are found.
7. The bootloader executes the verified application image.

### Signature Block Format

The signature block starts on a 4 KB aligned boundary and has a flash sector of its own. The signature is calculated over all bytes in the image including the padding bytes (*Secure Padding*).

**备注:** ESP32-H2 has a provision to choose between RSA scheme and ECDSA scheme. Only one scheme can be used per device.

ECDSA provides similar security strength, compared to RSA, with shorter key lengths. Current estimates are that ECDSA with curve P-256 has an approximate equivalent strength to RSA with 3072-bit keys. However, ECDSA signature verification takes considerably more amount of time as compared to RSA signature verification.

RSA is recommended for use cases where fast bootup time is required whereas ECDSA is recommended for use cases where shorter key length is required.

表 2: Comparison between signature verification time

Verification scheme	Time	CPU Frequency
RSA-3072	~4.5 ms	96 MHz
ECDSA-P256	~36 ms	96 MHz

The above table compares the time taken to verify a signature in a particular scheme. It does not indicate the bootup time.

The content of each signature block is shown in the following table:

表 3: Content of a RSA Signature Block

Offset	Size (bytes)	Description
0	1	Magic byte
1	1	Version number byte (currently 0x02), 0x01 is for Secure Boot V1.
2	2	Padding bytes, Reserved. Should be zero.
4	32	SHA-256 hash of only the image content, not including the signature block.
36	384	RSA Public Modulus used for signature verification. (value 'n' in RFC8017).
420	4	RSA Public Exponent used for signature verification (value 'e' in RFC8017).
424	384	Pre-calculated R, derived from 'n'.
808	4	Pre-calculated M', derived from 'n'
812	384	RSA-PSS Signature result (section 8.1.1 of RFC8017) of image content, computed using following PSS parameters: SHA256 hash, MGF1 function, salt length 32 bytes, default trailer field (0xBC).
1196	4	CRC32 of the preceding 1196 bytes.
1200	16	Zero padding to length 1216 bytes.



备注: R and M' are used for hardware-assisted Montgomery Multiplication.

表 4: Content of a ECDSA Signature Block

Offset	Size (bytes)	Description
0	1	Magic byte.
1	1	Version number byte (currently 0x03).
2	2	Padding bytes, Reserved. Should be zero.
4	32	SHA-256 hash of only the image content, not including the signature block.
36	1	Curve ID (1 for NIST192p curve. 2 for NIST256p curve).
37	64	ECDSA Public key: 32 byte X coordinate followed by 32 byte Y coordinate.
101	64	ECDSA Signature result (section 5.3.2 of RFC6090) of the image content: 32 byte R component followed by 32 byte S component.
165	1031	Reserved.
1196	4	CRC32 of the preceding 1196 bytes.
1200	16	Zero padding to length 1216 bytes.

The remainder of the signature sector is erased flash (0xFF) which allows writing other signature blocks after previous signature block.

### Secure Padding

In Secure Boot V2 scheme, the application image is padded to the flash MMU page size boundary to ensure that only verified contents are mapped in the internal address space. This is known as secure padding. Signature of the image is calculated after padding and then signature block (4KB) gets appended to the image.

- Default flash MMU page size is 64KB
- ESP32-H2 supports configurable flash MMU page size, it (`CONFIG_MMU_PAGE_SIZE`) gets set based on the [CONFIG\\_ESPTOOLPY\\_FLASHSIZE](#)
- Secure padding is applied through the option `--secure-pad-v2` in the `elf2image` conversion using `esptool.py`

Following table explains the Secure Boot V2 signed image with secure padding and signature block appended:

表 5: Contents of a signed application

Offset	Size (KB)	Description
0	580	Unsigned application size (as an example)
580	60	Secure padding (aligned to next 64KB boundary)
640	4	Signature block

备注: Please note that the application image always starts on the next flash MMU page size boundary (default 64KB) and hence the space left over after the signature block shown above can be utilized to store any other data partitions (e.g., `nvs`).

### Verifying a Signature Block

A signature block is "valid" if the first byte is 0xe7 and a valid CRC32 is stored at offset 1196. Otherwise it is invalid.

## Verifying an Image

An image is "verified" if the public key stored in any signature block is valid for this device, and if the stored signature is valid for the image data read from flash.

1. Compare the SHA-256 hash digest of the public key embedded in the bootloader's signature block with the digest(s) saved in the eFuses. If public key's hash does not match any of the hashes from the eFuses, the verification fails.
2. Generate the application image digest and match it with the image digest in the signature block. If the digests do not match, the verification fails.
3. Use the public key to verify the signature of the bootloader image, using either RSA-PSS (section 8.1.2 of RFC8017) or ECDSA signature verification (section 5.3.3 of RFC6090) with the image digest calculated in step (2) for comparison.

## Bootloader Size

Enabling Secure boot and/or flash encryption will increase the size of bootloader, which might require updating partition table offset. See [引导加载程序大小](#).

In the case when `CONFIG_SECURE_BOOT_BUILD_SIGNED_BINARIES` is disabled, the bootloader is sector padded (4KB) using the `--pad-to-size` option in `elf2image` command of `esptool`.

## eFuse Usage

- `SECURE_BOOT_EN` - Enables Secure Boot protection on boot.
- `KEY_PURPOSE_X` - Set the purpose of the key block on ESP32-H2 by programming `SECURE_BOOT_DIGESTX` ( $X = 0, 1, 2$ ) into `KEY_PURPOSE_X` ( $X = 0, 1, 2, 3, 4, 5$ ). Example: If `KEY_PURPOSE_2` is set to `SECURE_BOOT_DIGEST1`, then `BLOCK_KEY2` will have the Secure Boot V2 public key digest. The write-protection bit must be set (this field does not have a read-protection bit).
- `BLOCK_KEYX` - The block contains the data corresponding to its purpose programmed in `KEY_PURPOSE_X`. Stores the SHA-256 digest of the public key. SHA-256 hash of public key modulus, exponent, pre-calculated R & M' values (represented as 776 bytes -offsets 36 to 812 - as per the [Signature Block Format](#)) is written to an eFuse key block. The write-protection bit must be set, but the read-protection bit must not.
- `KEY_REVOKEX` - The revocation bits corresponding to each of the 3 key block. Ex. Setting `KEY_REVOKE2` revokes the key block whose key purpose is `SECURE_BOOT_DIGEST2`.
- `SECURE_BOOT_AGGRESSIVE_REVOKE` - Enables aggressive revocation of keys. The key is revoked as soon as verification with this key fails.

To ensure no trusted keys can be added later by an attacker, each unused key digest slot should be revoked (`KEY_REVOKEX`). It will be checked during app startup in `esp_secure_boot_init_checks()` and fixed unless `CONFIG_SECURE_BOOT_ALLOW_UNUSED_DIGEST_SLOTS` is enabled.

The key(s) must be readable in order to give software access to it. If the key(s) is read-protected then the software reads the key(s) as all zeros and the signature verification process will fail, and the boot process will be aborted.

## How To Enable Secure Boot V2

1. Open the [项目配置菜单](#), in "Security features" set "Enable hardware Secure Boot in bootloader" to enable Secure Boot.
2. The "Secure Boot V2" option will be selected and the "App Signing Scheme" would be set to RSA by default. RSA is recommended because of faster verification time. You can choose between RSA and ECDSA scheme from the menu.
3. Specify the path to Secure Boot signing key, relative to the project directory.

4. Select the desired UART ROM download mode in "UART ROM download mode". By default, it is set to "Permanently switch to Secure mode" which is generally recommended. For production devices, the most secure option is to set it to "Permanently disabled".
5. Set other menuconfig options (as desired). Then exit menuconfig and save your configuration.
6. The first time you run `idf.py build`, if the signing key is not found then an error message will be printed with a command to generate a signing key via `espsecure.py generate_signing_key`.

---

**重要:** A signing key generated this way will use the best random number source available to the OS and its Python installation (`/dev/urandom` on OSX/Linux and `CryptGenRandom()` on Windows). If this random number source is weak, then the private key will be weak.

---

**重要:** For production environments, we recommend generating the key pair using openssl or another industry standard encryption program. See [Generating Secure Boot Signing Key](#) for more details.

---

7. Run `idf.py bootloader` to build a Secure Boot enabled bootloader. The build output will include a prompt for a flashing command, using `esptool.py write_flash`.
8. When you are ready to flash the bootloader, run the specified command (you have to enter it yourself, this step is not performed by the build system) and then wait for flashing to complete.
9. Run `idf.py flash` to build and flash the partition table and the just-built app image. The app image will be signed using the signing key you generated in step 6.

---

**备注:** `idf.py flash` does not flash the bootloader if Secure Boot is enabled.

---

10. Reset the ESP32-H2 and it will boot the software bootloader you flashed. The software bootloader will enable Secure Boot on the chip, and then it verifies the app image signature and boots the app. You should watch the serial console output from the ESP32-H2 to verify that Secure Boot is enabled and no errors have occurred due to the build configuration.

---

**备注:** Secure boot will not be enabled until after a valid partition table and app image have been flashed. This is to prevent accidents before the system is fully configured.

---

---

**备注:** If the ESP32-H2 is reset or powered down during the first boot, it will start the process again on the next boot.

---

11. On subsequent boots, the Secure Boot hardware will verify the software bootloader has not changed and the software bootloader will verify the signed app image (using the validated public key portion of its appended signature block).

### Restrictions After Secure Boot Is Enabled

- Any updated bootloader or app will need to be signed with a key matching the digest already stored in eFuse.
- After Secure Boot is enabled, no further eFuses can be read protected. (If `flash 加密` is enabled then the bootloader will ensure that any flash encryption key generated on first boot will already be read protected.) If `CONFIG_SECURE_BOOT_INSECURE` is enabled then this behavior can be disabled, but this is not recommended.
- Please note that enabling Secure Boot or flash encryption disables the USB-OTG USB stack in the ROM, disallowing updates via the serial emulation or Device Firmware Update (DFU) on that port.

## Generating Secure Boot Signing Key

The build system will prompt you with a command to generate a new signing key via `espsecure.py generate_signing_key`.

The `--version 2` parameter will generate the RSA 3072 private key for Secure Boot V2. Additionally `--scheme rsa3072` can be passed as well to generate RSA 3072 private key

Select the ECDSA scheme by passing `--version 2 --scheme ecdsa256` or `--version 2 --scheme ecdsa192` to generate corresponding ECDSA private key

The strength of the signing key is proportional to (a) the random number source of the system, and (b) the correctness of the algorithm used. For production devices, we recommend generating signing keys from a system with a quality entropy source, and using the best available RSA-PSS or ECDSA key generation utilities.

For example, to generate a signing key using the `openssl` command line:

For RSA 3072

```
` openssl genrsa -out my_secure_boot_signing_key.pem 3072 `
```

For ECC NIST192p curve

```
` openssl ecparam -name prime192v1 -genkey -noout -out my_secure_boot_signing_key.pem `
```

For ECC NIST256p curve

```
` openssl ecparam -name prime256v1 -genkey -noout -out my_secure_boot_signing_key.pem `
```

Remember that the strength of the Secure Boot system depends on keeping the signing key private.

## Remote Signing of Images

**Signing Using `espsecure.py`** For production builds, it can be good practice to use a remote signing server rather than have the signing key on the build machine (which is the default `esp-idf` Secure Boot configuration). The `espsecure.py` command line program can be used to sign app images & partition table data for Secure Boot, on a remote system.

To use remote signing, disable the option `CONFIG_SECURE_BOOT_BUILD_SIGNED_BINARIES` and build the firmware. The private signing key does not need to be present on the build system.

After the app image and partition table are built, the build system will print signing steps using `espsecure.py`:

```
espsecure.py sign_data BINARY_FILE --version 2 --keyfile PRIVATE_SIGNING_KEY
```

The above command appends the image signature to the existing binary. You can use the `--output` argument to write the signed binary to a separate file:

```
espsecure.py sign_data --version 2 --keyfile PRIVATE_SIGNING_KEY --output SIGNED_
↳BINARY_FILE BINARY_FILE
```

**Signing Using Pre-calculated Signatures** If you have valid pre-calculated signatures generated for an image and their corresponding public keys, you can use these signatures to generate a signature sector and append it to the image. Note that the pre-calculated signature should be calculated over all bytes in the image including the secure-padding bytes.

In such cases, the firmware image should be built by disabling the option `CONFIG_SECURE_BOOT_BUILD_SIGNED_BINARIES`. This image will be secure-padded and to generate a signed binary use the following command:

```
espsecure.py sign_data --version 2 --pub-key PUBLIC_SIGNING_KEY --signature_
↳SIGNATURE_FILE --output SIGNED_BINARY_FILE BINARY_FILE
```

The above command verifies the signature, generates a signature block (refer to *Signature Block Format*) and appends it to the binary file.

**Signing Using an External Hardware Security Module (HSM)** For security reasons, you might also use an external Hardware Security Module (HSM) to store your private signing key, which cannot be accessed directly but has an interface to generate the signature of a binary file and its corresponding public key.

In such cases, disable the option `CONFIG_SECURE_BOOT_BUILD_SIGNED_BINARIES` and build the firmware. This secure-padded image then can be used to supply the external HSM for generating a signature. Refer to [Signing using an External HSM](#) to generate a signed image.

---

**备注:** For all the above three remote signing workflows, the signed binary is written to the filename provided to the `--output` argument and the option `--append_signatures` allows us to append multiple signatures (up to 3) the image.

---

### Secure Boot Best Practices

- Generate the signing key on a system with a quality source of entropy.
- Keep the signing key private at all times. A leak of this key will compromise the Secure Boot system.
- Do not allow any third party to observe any aspects of the key generation or signing process using `espssecure.py`. Both processes are vulnerable to timing or other side-channel attacks.
- Enable all Secure Boot options in the Secure Boot Configuration. These include flash encryption, disabling of JTAG, disabling BASIC ROM interpreter, and disabling the UART bootloader encrypted flash access.
- Use Secure Boot in combination with *flash 加密* to prevent local readout of the flash contents.

### Key Management

- Between 1 and 3 RSA-3072, ECDSA-256, or ECDSA-192 public key pairs (Keys #0, #1, #2) should be computed independently and stored separately.
- The KEY\_DIGEST eFuses should be write protected after being programmed.
- The unused KEY\_DIGEST slots must have their corresponding KEY\_REVOKE eFuse burned to permanently disable them. This must happen before the device leaves the factory.
- The eFuses can either be written by the software bootloader during first boot after enabling "Secure Boot V2" from menuconfig or can be done using `espefuse.py` which communicates with the serial bootloader program in ROM.
- The KEY\_DIGESTs should be numbered sequentially beginning at key digest #0. (i.e., if key digest #1 is used, key digest #0 should be used. If key digest #2 is used, key digest #0 & #1 must be used.)
- The software bootloader (non OTA upgradeable) is signed using at least one, possibly all three, private keys and flashed in the factory.
- Apps should only be signed with a single private key (the others being stored securely elsewhere), however they may be signed with multiple private keys if some are being revoked (see Key Revocation, below).

### Multiple Keys

- The bootloader should be signed with all the private key(s) that are needed for the life of the device, before it is flashed.
- The build system can sign with at most one private key, user has to run manual commands to append more signatures if necessary.
- **You can use the append functionality of `espssecure.py`, this command would also printed at the end of the Secure B**  
`espssecure.py sign_data -k secure_boot_signing_key2.pem -v 2 --append_signatures -o signed_bootloader.bin build/bootloader/bootloader.bin`
- While signing with multiple private keys, it is recommended that the private keys be signed independently, if possible on different servers and stored separately.
- **You can check the signatures attached to a binary using -** `espssecure.py signature_info_v2 datafile.bin`

## Key Revocation

- Keys are processed in a linear order. (key #0, key #1, key #2).
- Applications should be signed with only one key at a time, to minimize the exposure of unused private keys.
- The bootloader can be signed with multiple keys from the factory.

---

**备注:** Note that enabling the config `CONFIG_SECURE_BOOT_ALLOW_UNUSED_DIGEST_SLOTS` only makes sure that the **app** does not revoke the unused digest slots. But if you plan to enable secure boot during the first boot up, the bootloader will intentionally revoke the unused digest slots while enabling secure boot, even if the above config is enabled because keeping the unused key slots un-revoked would be a security hazard. In case for any development workflow if you need to avoid this revocation, you should enable secure boot externally (*Enable Secure Boot V2 Externally*) rather than enabling it during the boot up, so that the bootloader would not need to enable secure boot and thus you could avoid its revocation strategy.

---

**Conservative Approach:** Assuming a trusted private key (N-1) has been compromised, to update to new key pair (N).

1. Server sends an OTA update with an application signed with the new private key (#N).
  2. The new OTA update is written to an unused OTA app partition.
  3. The new application's signature block is validated. The public keys are checked against the digests programmed in the eFuse & the application is verified using the verified public key.
  4. The active partition is set to the new OTA application's partition.
  5. Device resets, loads the bootloader (verified with key #N-1 and #N) which then boots new app (verified with key #N).
  6. The new app verifies bootloader and application with key #N (as a final check) and then runs code to revoke key #N-1 (sets `KEY_REVOKE` eFuse bit).
  7. The API `esp_ota_revoke_secure_boot_public_key()` can be used to revoke the key #N-1.
- A similar approach can also be used to physically re-flash with a new key. For physical re-flashing, the bootloader content can also be changed at the same time.

**Aggressive Approach:** ROM code has an additional feature of revoking a public key digest if the signature verification fails.

To enable this feature, you need to burn `SECURE_BOOT_AGGRESSIVE_REVOKE` efuse or enable `CONFIG_SECURE_BOOT_ENABLE_AGGRESSIVE_KEY_REVOKE`

Key revocation is not applicable unless secure boot is successfully enabled. Also, a key is not revoked in case of invalid signature block or invalid image digest, it is only revoked in case the signature verification fails, i.e., revoke key only if failure in step 3 of *Verifying an Image*

Once a key is revoked, it can never be used for verifying a signature of an image. This feature provides strong resistance against physical attacks on the device. However, this could also brick the device permanently if all the keys are revoked because of signature verification failure.

## Technical Details

The following sections contain low-level reference descriptions of various Secure Boot elements:

**Manual Commands** Secure boot is integrated into the `esp-idf` build system, so `idf.py build` will sign an app image and `idf.py bootloader` will produce a signed bootloader if secure signed binaries on build is enabled.

However, it is possible to use the `espsecure.py` tool to make standalone signatures and digests.

To sign a binary image:

```
espsecure.py sign_data --version 2 --keyfile ./my_signing_key.pem --output ./image_
↳signed.bin image-unsigned.bin
```

Keyfile is the PEM file containing an RSA-3072, ECDSA-256, or ECDSA-192 private signing key.

### Secure Boot & Flash Encryption

If Secure Boot is used without *flash* 加密, it is possible to launch "time-of-check to time-of-use" attack, where flash contents are swapped after the image is verified and running. Therefore, it is recommended to use both the features together.

### Signed App Verification Without Hardware Secure Boot

The Secure Boot V2 signature of apps can be checked on OTA update, without enabling the hardware Secure Boot option. This option uses the same app signature scheme as Secure Boot V2, but unlike hardware Secure Boot it does not prevent an attacker who can write to flash from bypassing the signature protection.

This may be desirable in cases where the delay of Secure Boot verification on startup is unacceptable, and/or where the threat model does not include physical access or attackers writing to bootloader or app partitions in flash.

In this mode, the public key which is present in the signature block of the currently running app will be used to verify the signature of a newly updated app. (The signature on the running app is not verified during the update process, it is assumed to be valid.) In this way the system creates a chain of trust from the running app to the newly updated app.

For this reason, it is essential that the initial app flashed to the device is also signed. A check is run on app startup and the app will abort if no signatures are found. This is to try and prevent a situation where no update is possible. The app should have only one valid signature block in the first position. Note again that, unlike hardware Secure Boot V2, the signature of the running app is not verified on boot. The system only verifies a signature block in the first position and ignores any other appended signatures.

Although multiple trusted keys are supported when using hardware Secure Boot, only the first public key in the signature block is used to verify updates if signature checking without Secure Boot is configured. If multiple trusted public keys are required, it is necessary to enable the full Secure Boot feature instead.

---

**备注:** In general, it is recommended to use full hardware Secure Boot unless certain that this option is sufficient for application security needs.

---

### How To Enable Signed App Verification

1. Open [项目配置菜单](#) -> Security features
2. Choose *App Signing Scheme*. Either *RSA* or *ECDSA (V2)*
3. Enable *CONFIG\_SECURE\_SIGNED\_APPS\_NO\_SECURE\_BOOT*
4. By default, "Sign binaries during build" will be enabled on selecting "Require signed app images" option, which will sign binary files as a part of build process. The file named in "Secure boot private signing key" will be used to sign the image.
5. If you disable "Sign binaries during build" option then all app binaries must be manually signed by following instructions in [Remote Signing of Images](#).

**警告:** It is very important that all apps flashed have been signed, either during the build or after the build.



## Advanced Features

**JTAG Debugging** By default, when Secure Boot is enabled then JTAG debugging is disabled via eFuse. The bootloader does this on first boot, at the same time it enables Secure Boot.

See [JTAG 与 flash 加密和安全引导](#) for more information about using JTAG Debugging with either Secure Boot or signed app verification enabled.

## 6.3 流程

### 6.3.1 Host-Based Security Workflows

#### Introduction

It is recommended to have an uninterrupted power supply while enabling security features on ESP32 SoCs. Power failures during the secure manufacturing process could cause issues that are hard to debug and, in some cases, may cause permanent boot-up failures.

This guide highlights an approach where security features are enabled with the assistance of an external host machine. Security workflows are broken down into various stages and key material is generated on the host machine; thus, allowing greater recovery chances in case of power or other failures. It also offers better timings for secure manufacturing, e.g., in the case of encryption of firmware on the host machine vs. on the device.

#### Goals

1. Simplify the traditional workflow with stepwise instructions.
2. Design a more flexible workflow as compared to the traditional firmware-based workflow.
3. Improve reliability by dividing the workflow into small operations.
4. Eliminate dependency on [二级引导程序](#) (firmware bootloader).

#### Pre-requisite

- `esptool`: Please make sure the `esptool` has been installed. It can be installed by running:

```
pip install esptool
```

#### Scope

- [Enable Flash Encryption and Secure Boot V2 Externally](#)
- [Enable Flash Encryption Externally](#)
- [Enable Secure Boot V2 Externally](#)
- [Enable NVS Encryption Externally](#)

#### Security Workflows

##### Enable Flash Encryption and Secure Boot V2 Externally

**重要:** It is recommended to enable both Flash Encryption and Secure Boot V2 for a production use case.

---

When enabling the Flash Encryption and Secure Boot V2 together we need to enable them in the following order:

1. Enable the Flash Encryption feature by following the steps listed in [Enable Flash Encryption Externally](#).
2. Enable the Secure Boot V2 feature by following the steps listed in [Enable Secure Boot V2 Externally](#).



The reason for this order is as follows:

---

**备注:** To enable the Secure Boot (SB) V2, it is necessary to keep the SB V2 key readable. To protect the key's readability, the write protection for RD\_DIS (ESP\_EFUSE\_WR\_DIS\_RD\_DIS) is applied. However, this action poses a challenge when attempting to enable Flash Encryption, as the Flash Encryption (FE) key needs to remain unreadable. This conflict arises because the RD\_DIS is already write-protected, making it impossible to read protect the FE key.

---

**Enable Flash Encryption Externally** In this case, all the eFuses related to Flash Encryption are written with help of the `espefuse` tool. More details about flash encryption can be found in the [Flash Encryption Guide](#)

#### 1. Check device status

Ensure that you have an ESP32-H2 device with default Flash Encryption eFuse settings as shown in [相关 eFuses](#).

See how to check [ESP32-H2 flash 加密状态](#).

At this point, the Flash Encryption must not be already enabled on the chip. Additionally, the flash on the chip needs to be erased, which can be done by running:

```
esptool.py --port PORT erase_flash
```

#### 2. Generate a Flash Encryption key

A random Flash Encryption key can be generated by running:

```
espsecure.py generate_flash_encryption_key my_flash_encryption_key.bin
```

#### 3. Burn the Flash Encryption key into eFuse

This action **cannot be reverted**. It can be done by running:

```
espefuse.py --port PORT burn_key BLOCK my_flash_encryption_key.bin XTS_
↪AES_128_KEY
```

where BLOCK is a free keyblock between BLOCK\_KEY0 and BLOCK\_KEY5.

**警告:** For the ESP32-H2 BLOCK9 (BLOCK\_KEY5) can not be used by XTS\_AES keys.

#### 4. Burn the SPI\_BOOT\_CRYPT\_CNT eFuse

If you only want to enable Flash Encryption in **Development** mode and want to keep the ability to disable it in the future, Update the SPI\_BOOT\_CRYPT\_CNT value in the below command from 7 to 0x1 (not recommended for production).

```
espefuse.py --port PORT --chip esp32h2 burn_efuse SPI_BOOT_CRYPT_CNT 7
```

#### 5. Burn Flash Encryption-related security eFuses as listed below

##### A) Burn security eFuses

---

**重要:** For production use cases, it is highly recommended to burn all the eFuses listed below.

---

- DIS\_DIRECT\_BOOT: Disable direct boot (legacy SPI boot mode)
- DIS\_USB\_JTAG: Disable USB switch to JTAG
- DIS\_PAD\_JTAG: Disable JTAG permanently

- `DIS_DOWNLOAD_MANUAL_ENCRYPT`: Disable UART bootloader encryption access

The respective eFuses can be burned by running:

```
espefuse.py burn_efuse --port PORT EFUSE_NAME 0x1
```

**备注:** Please update the `EFUSE_NAME` with the eFuse that you need to burn. Multiple eFuses can be burned at the same time by appending them to the above command (e.g., `EFUSE_NAME VAL EFUSE_NAME2 VAL2`). More documentation about `espefuse.py` can be found [here](#).

## B) Write protect security eFuses

After burning the respective eFuses we need to write\_protect the security configurations. It can be done by burning following eFuse

```
espefuse.py --port PORT write_protect_efuse DIS_ICACHE
```

**备注:** The write protection of above eFuse also write protects multiple other eFuses, Please refer to the ESP32-H2 eFuse table for more details.

## 6. Configure the project

The bootloader and the application binaries for the project must be built with Flash Encryption Release mode with default configurations.

Flash encryption Release mode can be set in the menuconfig as follows:

- *Enable Flash Encryption on boot*
- *Select Release mode* (Note that once Release mode is selected, the `EFUSE_DIS_DOWNLOAD_MANUAL_ENCRYPT` eFuse bit will be burned to disable Flash Encryption hardware in ROM Download Mode)
- *Select UART ROM download mode (Permanently switch to Secure mode (recommended))*. This is the default option and is recommended. It is also possible to change this configuration setting to permanently disable UART ROM download mode, if this mode is not needed
- *Select the appropriate bootloader log verbosity*
- Save the configuration and exit

## 7. Build, Encrypt and Flash the binaries

The binaries can be encrypted on the host machine by running:

```
espsecure.py encrypt_flash_data --aes_xts --keyfile my_flash_encryption_
↪key.bin --address 0x1000 --output bootloader-enc.bin build/bootloader/
↪bootloader.bin

espsecure.py encrypt_flash_data --aes_xts --keyfile my_flash_encryption_
↪key.bin --address 0x8000 --output partition-table-enc.bin build/
↪partition_table/partition-table.bin

espsecure.py encrypt_flash_data --aes_xts --keyfile my_flash_encryption_
↪key.bin --address 0x10000 --output my-app-enc.bin build/my-app.bin
```

In the above command the offsets are used for a sample firmware, the actual offset for your firmware can be obtained by checking the partition table entry or by running `idf.py partition-table`. Please note that not all the binaries need to be encrypted, the encryption applies only to those generated from the partitions which are marked as `encrypted` in the partition table definition file. Other binaries are flashed unencrypted, i.e., as a plain output of the build process.

The above files can then be flashed to their respective offset using `esptool.py`. To see all of the command line options recommended for `esptool.py`, see the output printed when `idf.py build` succeeds.

When the application contains the following partition: `otadata`, `nvs_encryption_keys` they need to be encrypted as well. Please refer to [加密分区](#) for more details about encrypted partitions.

---

**备注:** If the flashed ciphertext file is not recognized by the ESP32-H2 when it boots, check that the keys match and that the command line arguments match exactly, including the correct offset. It is important to provide the correct offset as the ciphertext changes when the offset changes.

---

The command `espsecure.py decrypt_flash_data` can be used with the same options (and different input/output files), to decrypt ciphertext flash contents or a previously encrypted file.

#### 8. Secure the ROM Download mode

**警告:** Please perform the following step at the very end. After this eFuse is burned, the `espefuse` tool can no longer be used to burn additional eFuses.

Disable UART ROM DL mode:

- `UART_DOWNLOAD_DIS` : Disable the UART ROM Download mode

The eFuse can be burned by running:

```
espefuse.py --port PORT burn_efuse UART_DOWNLOAD_DIS
```

Enable Security Download mode:

- `ENABLE_SECURITY_DOWNLOAD`: Enable Secure ROM download mode

The eFuse can be burned by running:

```
espefuse.py --port PORT burn_efuse ENABLE_SECURITY_DOWNLOAD
```

---

**重要:**

#### 9. Delete Flash Encryption key on host

Once the Flash Encryption has been enabled for the device, the key **must be deleted immediately**.

This ensures that the host cannot produce encrypted binaries for the same device going forward.

This step is important to reduce the vulnerability of the flash encryption key.

---

### Flash Encryption Guidelines

- It is recommended to generate a unique Flash Encryption key for each device for production use-cases.
- It is recommended to ensure that the RNG used by host machine to generate the Flash Encryption key has good entropy.
- See [flash 加密的局限性](#) for more details.

**Enable Secure Boot V2 Externally** In this workflow, we shall use `espsecure` tool to generate signing keys and use the `espefuse` tool to burn the relevant eFuses. The details about the Secure Boot V2 process can be found at [Secure Boot V2 Guide](#)

#### 1. Generate Secure Boot V2 Signing Private Key

The Secure Boot V2 signing key for the RSA3072 scheme can be generated by running:

```
espsecure.py generate_signing_key --version 2 --scheme rsa3072 secure_
↳boot_signing_key.pem
```

The Secure Boot V2 signing key for ECDSA scheme can be generated by running:

```
espsecure.py generate_signing_key --version 2 --scheme ecdsa256 secure_
↳boot_signing_key.pem
```

The scheme in the above command can be changed to `ecdsa192` to generate `ecdsa192` private key.

A total of 3 keys can be used for Secure Boot V2 at once. These should be computed independently and stored separately. The same command with different key file names can be used to generate multiple Secure Boot V2 signing keys. It is recommended to use multiple keys in order to reduce dependency on a single key.

## 2. Generate Public Key Digest

The public key digest for the private key generated in the previous step can be generated by running:

```
espsecure.py digest_sbv2_public_key --keyfile secure_boot_signing_key.pem
↳--output digest.bin
```

In case of multiple digests, each digest should be kept in a separate file.

## 3. Burn the key digest in eFuse

The public key digest can be burned in the eFuse by running:

```
espefuse.py --port PORT --chip esp32h2 burn_key BLOCK digest.bin SECURE_
↳BOOT_DIGEST0
```

where `BLOCK` is a free keyblock between `BLOCK_KEY0` and `BLOCK_KEY5`.

In case of multiple digests, the other digests can be burned sequentially by changing the key purpose to `SECURE_BOOT_DIGEST1` and `SECURE_BOOT_DIGEST2` respectively.

## 4. Enable Secure Boot V2

Secure Boot V2 eFuse can be enabled by running:

```
espefuse.py --port PORT --chip esp32h2 burn_efuse SECURE_BOOT_EN
```

## 5. Burn relevant eFuses

### A) Burn security eFuses

---

**重要:** For production use cases, it is highly recommended to burn all the eFuses listed below.

---

- `SOFT_DIS_JTAG`: Disable software access to JTAG peripheral
- `DIS_DIRECT_BOOT`: Disable direct boot (legacy SPI boot mode)
- `DIS_USB_JTAG`: Disable USB switch to JTAG
- `DIS_PAD_JTAG`: Disable JTAG permanently
- `SECURE_BOOT_AGGRESSIVE_REVOKE`: Aggressive revocation of key digests, see [Aggressive Approach](#): for more details.

The respective eFuses can be burned by running:

```
espefuse.py burn_efuse --port PORT EFUSE_NAME 0x1
```

---

**备注:** Please update the `EFUSE_NAME` with the eFuse that you need to burn. Multiple eFuses can be burned at the same time by appending them to the above command (e.g., `EFUSE_NAME VAL EFUSE_NAME2 VAL2`). More documentation about `espefuse.py` can be found [here](#)

---

## B) Secure Boot V2-related eFuses

### i) Disable the read-protection option:

The Secure Boot digest burned in the eFuse must be kept readable otherwise the Secure Boot operation would result in a failure. To prevent the accidental enabling of read protection for this key block, the following eFuse needs to be burned:

---

**重要:** After burning above-mentioned eFuse, the read protection cannot be enabled for any key. E.g., if Flash Encryption which requires read protection for its key is not enabled at this point, then it cannot be enabled afterwards. Please ensure that no eFuse keys are going to need read protection after completing this step.

---

```
espefuse.py -p $ESPPORT write_protect_efuse RD_DIS
```

### ii) Revoke key digests:

The unused digest slots need to be revoked when we are burning the Secure Boot key. The respective slots can be revoked by running

```
espefuse.py --port PORT --chip esp32h2 burn_efuse EFUSE_REVOKE_BIT
```

The `EFUSE_REVOKE_BIT` in the above command can be `SECURE_BOOT_KEY_REVOKE0` or `SECURE_BOOT_KEY_REVOKE1` or `SECURE_BOOT_KEY_REVOKE2`. Please note that only the unused key digests must be revoked. Once revoked, the respective digest cannot be used again.

## 6. Configure the project

By default, the ROM bootloader would only verify the [二级引导程序](#) (firmware bootloader). The firmware bootloader would verify the app partition only when the `CONFIG_SECURE_BOOT` option is enabled (and `CONFIG_SECURE_BOOT_VERSION` is set to `SECURE_BOOT_V2_ENABLED`) while building the bootloader.

- a) Open the [项目配置菜单](#), in "Security features" set "Enable hardware Secure Boot in bootloader" to enable Secure Boot.

The "Secure Boot V2" option will be selected and the "App Signing Scheme" will be set to RSA by default.

- b) Disable the option `CONFIG_SECURE_BOOT_BUILD_SIGNED_BINARIES` for the project in the [项目配置菜单](#). This shall make sure that all the generated binaries are secure padded and unsigned. This step is done to avoid generating signed binaries as we are going to manually sign the binaries using `espssecure` tool.

## 7. Build, Sign and Flash the binaries

After the above configurations, the bootloader and application binaries can be built with `idf.py build` command.

The Secure Boot V2 workflow only verifies the `bootloader` and `application` binaries, hence only those binaries need to be signed. The other binaries (e.g., `partition-table.bin`) can be flashed as they are generated in the build stage.

The `bootloader.bin` and `app.bin` binaries can be signed by running:

```

espsecure.py sign_data --version 2 --keyfile secure_boot_signing_key.pem -
↳--output bootloader-signed.bin build/bootloader/bootloader.bin

espsecure.py sign_data --version 2 --keyfile secure_boot_signing_key.pem -
↳--output my-app-signed.bin build/my-app.bin

```

If multiple keys Secure Boot keys are to be used then the same signed binary can be appended with a signature block signed with the new key as follows:

```

espsecure.py sign_data --keyfile secure_boot_signing_key2.pem --version 2
↳--append_signatures -o bootloader-signed2.bin bootloader-signed.bin

espsecure.py sign_data --keyfile secure_boot_signing_key2.pem --version 2
↳--append_signatures -o my-app-signed2.bin my-app-signed.bin

```

The same process can be repeated for the third key. Note that the names of the input and output files must not be the same.

The signatures attached to a binary can be checked by running:

```

espsecure.py signature_info_v2 bootloader-signed.bin

```

The above files along with other binaries (e.g., partition table) can then be flashed to their respective offset using `esptool.py`. To see all of the command line options recommended for `esptool.py`, see the output printed when `idf.py build` succeeds. The flash offset for your firmware can be obtained by checking the partition table entry or by running `idf.py partition-table`.

#### 8. Secure the ROM Download mode:

**警告:** Please perform the following step at the very end. After this eFuse is burned, the `espefuse` tool can no longer be used to burn additional eFuses.

Disable UART ROM DL mode:

- `UART_DOWNLOAD_DIS`: Disable the UART ROM Download mode

The eFuse can be burned by running:

```

espefuse.py --port PORT burn_efuse UART_DOWNLOAD_DIS

```

Enable Security Download mode:

- `ENABLE_SECURITY_DOWNLOAD`: Enable Secure ROM download mode

The eFuse can be burned by running:

```

espefuse.py --port PORT burn_efuse ENABLE_SECURITY_DOWNLOAD

```

### Secure Boot V2 Guidelines

- It is recommended to store the Secure Boot key in a highly secure place. A physical or a cloud HSM may be used for secure storage of the Secure Boot private key. Please take a look at [Remote Signing of Images](#) for more details.
- It is recommended to use all the available digest slots to reduce dependency on a single private key.

**Enable NVS Encryption Externally** The details about NVS Encryption and related schemes can be found at [NVS Encryption](#).

### Enable NVS Encryption based on HMAC

#### 1. Generate the HMAC key and NVS Encryption key

In the HMAC based NVS scheme, there are two keys:

- HMAC key - this is a 256 bit HMAC key that shall be stored in the eFuse
- NVS Encryption key - This is the NVS Encryption key that is used to encrypt the NVS partition. This key is derived at run-time using the HMAC key.

The above keys can be generated with the `nvs_flash/nvs_partition_generator/nvs_partition_gen.py` script with help of the following command:

```
python3 nvs_partition_gen.py generate-key --key_protect_hmac --kp_hmac_
↪keygen --kp_hmac_keyfile hmac_key.bin --keyfile nvs_encr_key.bin
```

This shall generate the respective keys in the `keys` folder.

#### 2. Burn the HMAC key in the eFuse

The NVS key can be burned in the eFuse of ESP32-H2 with help of following command:

```
espefuse.py --port PORT burn_key BLOCK hmac_key.bin HMAC_UP
```

where `BLOCK` is a free keyblock between `BLOCK_KEY0` and `BLOCK_KEY5`.

#### 3. Generate the encrypted NVS partition

We shall generate the actual encrypted NVS partition on host. More details about generating the encryption NVS partition can be found at [生成 NVS 加密分区](#). For this purpose, the contents of the NVS file shall be available in a CSV file. Please check out [CSV 文件格式](#) for more details.

The encrypted NVS partition can be generated with following command:

```
python3 nvs_partition_gen.py encrypt sample_singlepage_blob.csv nvs_encr_
↪partition.bin 0x3000 --inputkey keys/nvs_encr_key.bin
```

Some command arguments are explained below:

- CSV file name - In this case `sample_singlepage_blob.csv` is the CSV file which contains the NVS data, Replace this with the file you wish to choose.
- NVS partition offset - This is the offset at which that NVS partition shall be stored in the flash of ESP32-H2. The offset of your `nvs-partition` can be found by executing `idf.py partition-table` in the project directory. Please update the sample value of `0x3000` in the above-provided command to the correct offset.

#### 4. Configure the project

- Enable *NVS Encryption* by enabling `CONFIG_NVS_ENCRYPTION`.
- Enable the HMAC based NVS Encryption by setting `CONFIG_NVS_SEC_KEY_PROTECTION_SCHEME` to `CONFIG_NVS_SEC_KEY_PROTECT_USING_HMAC`
- Set the HMAC efuse key id at `CONFIG_NVS_SEC_HMAC_EFUSE_KEY_ID` to the one in which the eFuse key was burned in Step 2.

#### 5. Flash NVS partition

The NVS partition (`nvs_encr_partition.bin`) generated in Step 3 can then be flashed to its respective offset using `esptool.py`. To see all of the command line options recommended for `esptool.py`, check the output printed when `idf.py build` succeeds. If Flash encryption is enabled for the chip then please encrypt the partition first before flashing. You may refer the flashing related steps of [Flash Encryption workflow](#).

**Enable NVS Encryption based on Flash Encryption** In this case we generate NVS Encryption keys on a host. This key is then flashed on the chip and protected with help of the *Flash Encryption* feature.

1. Generate the NVS Encryption key

For generation of respective keys, we shall use *NVS partition generator utility*. We shall generate the encryption key on host and this key shall be stored on the flash of ESP32-H2 in encrypted state.

The key can be generated with the `nvs_flash/nvs_partition_generator/nvs_partition_gen.py` script with help of the following command:

```
python3 nvs_partition_gen.py generate-key --keyfile nvs_encr_key.bin
```

This shall generate the respective key in the `keys` folder.

2. Generate the encrypted NVS partition

We shall generate the actual encrypted NVS partition on host. More details about generating the encryption NVS partition can be found at [生成 NVS 加密分区](#). For this, the contents of the NVS file shall be available in a CSV file. Please refer [CSV 文件格式](#) for more details.

The encrypted NVS partition can be generated with following command:

```
python3 nvs_partition_gen.py encrypt sample_singlepage_blob.csv nvs_encr_
↪partition.bin 0x3000 --inputkey keys/nvs_encr_key.bin
```

Some command arguments are explained below:

- CSV file name - In this case `sample_singlepage_blob.csv` is the CSV file which contains the NVS data, Replace this with the file you wish to choose.
- NVS partition offset - This is the offset at which that NVS partition shall be stored in the flash of ESP32-H2. The offset of your nvs-partition can be found by executing `idf.py partition-table` in the project directory. Please update the sample value of `0x3000` in the above-provided command to the correct offset.

3. Configure the project

- Enable *NVS Encryption* by enabling `CONFIG_NVS_ENCRYPTION`.
- Set NVS to use Flash Encryption based scheme by setting `CONFIG_NVS_SEC_KEY_PROTECTION_SCHEME` to `CONFIG_NVS_SEC_KEY_PROTECT_USING_FLASH_ENC`.

4. Flash NVS partition and NVS Encryption keys

The NVS partition (`nvs_encr_partition.bin`) and NVS Encryption key (`nvs_encr_key.bin`) can then be flashed to their respective offset using `esptool.py`. To see all of the command line options recommended for `esptool.py`, check the output printed when `idf.py build` succeeds. If Flash encryption is enabled for the chip then please encrypt the partition first before flashing. You may refer the flashing related steps of *Flash Encryption workflow*.





## Chapter 7

# 库与框架

### 7.1 云框架

ESP32-H2 可以使用构建在 ESP-IDF 之上的代理来支持多个云框架。以下是各种支持的云框架代理和示例：

#### 7.1.1 ESP RainMaker

ESP RainMaker 是用于加速 AIoT 开发的完整解决方案。更多信息见 [ESP RainMaker GitHub 仓库](#)。

#### 7.1.2 AWS IoT

<https://github.com/espressif/esp-aws-iot> 是 ESP32-H2 的开源仓库，基于亚马逊 Web 服务的 `aws-iot-device-sdk-embedded-C`。

#### 7.1.3 Azure IoT

<https://github.com/espressif/esp-azure> 是 ESP32-H2 的开源存储库，基于微软 Azure 的 `azure-iot-sdk-c` SDK。

#### 7.1.4 Google IoT Core

<https://github.com/espressif/esp-google-iot> 是 ESP32-H2 的开源存储库，基于谷歌的 `iot-device-sdk-embedded-c` SDK。

#### 7.1.5 阿里云 IoT

<https://github.com/espressif/esp-aliyun> 是 ESP32-H2 的开源存储库，基于阿里云的 `iotkit-embedded` SDK。

#### 7.1.6 Joylink IoT

<https://github.com/espressif/esp-joylink> 是 ESP32-H2 的开源存储库，基于 Joylink 的 `joylink_dev_sdk` SDK。

### 7.1.7 腾讯 IoT

<https://github.com/espressif/esp-welink> 是 ESP32-H2 的开源存储库，基于腾讯的 [welink SDK](#)。

### 7.1.8 腾讯云 IoT

<https://github.com/espressif/esp-qcloud> 是 ESP32-H2 的开源存储库，基于腾讯云的 [qcloud-iot-sdk-embedded-c SDK](#)。

### 7.1.9 百度 IoT

<https://github.com/espressif/esp-baidu-iot> 是 ESP32-H2 的开源存储库，基于百度的 [iot-sdk-c SDK](#)。

## 7.2 其他库和开发框架

本文展示了一系列乐鑫官方发布的库和框架。

### 7.2.1 ESP-ADF

ESP-ADF 是一个全方位的音频应用程序框架，该框架支持：

- CODEC 的 HAL
- 音乐播放器和录音机
- 音频处理
- 蓝牙扬声器
- 互联网收音机
- 免提设备
- 语音识别

该框架对应的 GitHub 仓库为 [ESP-ADF](#)。

### 7.2.2 ESP-CSI

ESP-CSI 是一个具有实验性的框架，它利用 Wi-Fi 信道状态信息来检测人体存在。

该框架对应的 GitHub 仓库为 [ESP-CSI](#)。

### 7.2.3 ESP-DSP

ESP-DSP 提供了针对数字信号处理应用优化的算法，该库支持：

- 矩阵乘法
- 点积
- 快速傅立叶变换 (FFT)
- 无限脉冲响应 (IIR)
- 有限脉冲响应 (FIR)
- 向量数学运算

该库对应的 GitHub 仓库为 [ESP-DSP 库](#)。

## 7.2.4 ESP-WIFI-MESH

ESP-WIFI-MESH 基于 ESP-WIFI-MESH 协议搭建，该框架支持：

- 快速网络配置
- 稳定升级
- 高效调试
- LAN 控制
- 多种应用示例

该框架对应的 GitHub 仓库为 [ESP-MDF](#)。

## 7.2.5 ESP-WHO

ESP-WHO 框架利用 ESP32 及摄像头实现人脸检测及识别。

该框架对应的 GitHub 仓库为 [ESP-WHO](#)。

## 7.2.6 ESP RainMaker

[ESP RainMaker](#) 提供了一个快速 AIoT 开发的完整解决方案。使用 ESP RainMaker，用户可以创建多种 AIoT 设备，包括固件 AIoT 以及集成了语音助手、手机应用程序和云后端的 AIoT 等。

该解决方案对应的 GitHub 仓库为 [GitHub 上的 ESP RainMaker](#)。

## 7.2.7 ESP-IoT-Solution

[ESP-IoT-Solution](#) 涵盖了开发 IoT 系统时常用的设备驱动程序及代码框架。在 ESP-IoT-Solution 中，设备驱动程序和代码框架以独立组件存在，可以轻松地集成到 ESP-IDF 项目中。

ESP-IoT-Solution 支持：

- 传感器、显示器、音频、GUI、输入、执行器等设备驱动程序
- 低功耗、安全、存储等框架和文档
- 从实际应用角度指导乐鑫开源解决方案

该解决方案对应的 GitHub 仓库为 [GitHub 上的 ESP-IoT-Solution](#)。

## 7.2.8 ESP-Protocols

[ESP-Protocols](#) 库包含 ESP-IDF 的协议组件集。ESP-Protocols 中的代码以独立组件存在，可以轻松地集成到 ESP-IDF 项目中。此外，每个组件都可以在 [ESP-IDF 组件注册表](#) 中找到。

ESP-Protocols 组件：

- [esp\\_modem](#) 使用 AT 命令或 PPP 协议与 GSM/LTE 调制解调器连接，详情请参阅 [esp\\_modem 文档](#)。
- [mdns](#) (mDNS) 是一种组播 UDP 服务，用于提供本地网络服务与主机发现，详情请参阅 [mdns 文档](#)。
- [esp\\_websocket\\_client](#) 是 ESP-IDF 的托管组件，可在 ESP32 上实现 WebSocket 协议客户端，详情请参阅 [esp\\_websocket\\_client 文档](#)。有关 WebSocket 协议客户端，请参阅 [WebSocket\\_protocol\\_client](#)。
- [asio](#) 是一个跨平台的 C++ 库，请参阅 <https://think-async.com/Asio/>。该库基于现代 C++ 提供一致的异步模型，请参阅 [asio 文档](#)。

## 7.2.9 ESP-BSP

[ESP-BSP](#) 库包含了各种乐鑫和第三方开发板的板级支持包 (BSP)，可以帮助快速上手特定的开发板。它们通常包含管脚定义和辅助函数，这些函数可用于初始化特定开发板的外设。此外，BSP 还提供了一些驱动程序，可用于开发版上的外部芯片，如传感器、显示屏、音频编解码器等。

### 7.2.10 ESP-IDF-CXX

ESP-IDF-CXX 包含了 ESP-IDF 的部分 C++ 封装, 重点在实现易用性、安全性、自动资源管理, 以及将错误检查转移到编译过程中, 以避免运行时失败。它还提供了 ESP 定时器、I2C、SPI、GPIO 等外设或 ESP-IDF 其他功能的 C++ 类。ESP-IDF-CXX 作为组件可以从 [组件注册表](#) 中获取。详情请参阅 [README.md](#)。

## Chapter 8

# 贡献指南

欢迎为 ESP-IDF 项目贡献内容！

### 8.1 如何贡献

欢迎为 ESP-IDF 贡献内容，如修复问题、新增功能、添加文档等。你可通过 [Github Pull Requests](#) 提交你的贡献内容。

### 8.2 准备工作

在提交 Pull Request 前，请检查以下要点：

- 贡献内容是否完全是自己的成果，或已获得与 Apache License 2.0 兼容的开源许可？如果不是，我们不能接受该内容。了解更多信息，请见 [版权标头指南](#)。
- 要提交的代码是否符合 ESP-IDF [Espressif IoT Development Framework Style Guide](#)？
- 是否安装了 ESP-IDF [pre-commit 钩子](#)？
- 代码文档是否符合 [编写文档](#) 的要求？
- 代码是否注释充分，便于读者理解其结构？
- 是否为贡献的代码提供文档或示例？要写出好的示例，请参考 [examples readme](#)。
- 注释或文档是否以英语书写并表达清晰，不存在拼写或语法错误？
- 欢迎贡献新的代码示例。了解更多信息，请参考 [创建示例项目](#)。
- 如果需提交多个内容，是否将所有内容按照改动的类型（每个 pull request 对应一个主要改动）进行分组？是否有命名类似“fixed typo”的提交 [压缩到了此前的提交中](#)？
- 如不能确定上述任意内容，请提交 Pull Request，并向我们寻求反馈。

### 8.3 Pull Request 提交流程

创建 Pull Request 后，PR 评论区中可能有一些关于该请求的讨论。

Pull Request 准备好待合并时，首先会合并到我们的内部 git 系统中进行内部自动化测试。

测试流程通过后，你贡献的内容将合并到公共 GitHub 库。

### 8.4 法律规范

在提交贡献内容前，你需签署 [贡献者协议](#)。该协议将在 Pull Request 过程中自动推送。

## 8.5 相关文档

### 8.5.1 Espressif IoT Development Framework Style Guide

#### About This Guide

Purpose of this style guide is to encourage use of common coding practices within the ESP-IDF.

Style guide is a set of rules which are aimed to help create readable, maintainable, and robust code. By writing code which looks the same way across the code base we help others read and comprehend the code. By using same conventions for spaces and newlines we reduce chances that future changes will produce huge unreadable diffs. By following common patterns for module structure and by using language features consistently we help others understand code behavior.

We try to keep rules simple enough, which means that they can not cover all potential cases. In some cases one has to bend these simple rules to achieve readability, maintainability, or robustness.

When doing modifications to third-party code used in ESP-IDF, follow the way that particular project is written. That will help propose useful changes for merging into upstream project.

#### C Code Formatting

##### Naming

- Any variable or function which is only used in a single source file should be declared `static`.
- Public names (non-static variables and functions) should be namespaced with a per-component or per-unit prefix, to avoid naming collisions. ie `esp_vfs_register()` or `esp_console_run()`. Starting the prefix with `esp_` for Espressif-specific names is optional, but should be consistent with any other names in the same component.
- Static variables should be prefixed with `s_` for easy identification. For example, `static bool s_invert`.
- Avoid unnecessary abbreviations (ie shortening `data` to `dat`), unless the resulting name would otherwise be very long.

**Indentation** Use 4 spaces for each indentation level. Do not use tabs for indentation. Configure the editor to emit 4 spaces each time you press tab key.

**Vertical Space** Place one empty line between functions. Do not begin or end a function with an empty line.

```
void function1()
{
    do_one_thing();
    do_another_thing();
}
// INCORRECT, do not place empty line here
// place empty line here
void function2()
{
    // INCORRECT, do not use an empty line here
    int var = 0;
    while (var < SOME_CONSTANT) {
        do_stuff(&var);
    }
}
```

The maximum line length is 120 characters as long as it does not seriously affect the readability.

**Horizontal Space** Always add single space after conditional and loop keywords:

```
if (condition) {    // correct
    // ...
}

switch (n) {        // correct
    case 0:
        // ...
}

for(int i = 0; i < CONST; ++i) {    // INCORRECT
    // ...
}
```

Add single space around binary operators. No space is necessary for unary operators. It is okay to drop space around multiply and divide operators:

```
const int y = y0 + (x - x0) * (y1 - y0) / (x1 - x0);    // correct

const int y = y0 + (x - x0)*(y1 - y0)/(x1 - x0);        // also okay

int y_cur = -y;                                          // correct
++y_cur;

const int y = y0+(x-x0)*(y1-y0)/(x1-x0);                // INCORRECT
```

No space is necessary around `.` and `->` operators.

Sometimes adding horizontal space within a line can help make code more readable. For example, you can add space to align function arguments:

```
esp_rom_gpio_connect_in_signal(PIN_CAM_D6,    I2S0I_DATA_IN14_IDX, false);
esp_rom_gpio_connect_in_signal(PIN_CAM_D7,    I2S0I_DATA_IN15_IDX, false);
esp_rom_gpio_connect_in_signal(PIN_CAM_HREF,   I2S0I_H_ENABLE_IDX,  false);
esp_rom_gpio_connect_in_signal(PIN_CAM_PCLK,   I2S0I_DATA_IN15_IDX, false);
```

Note however that if someone goes to add new line with a longer identifier as first argument (e.g., `PIN_CAM_VSYNC`), it will not fit. So other lines would have to be realigned, adding meaningless changes to the commit.

Therefore, use horizontal alignment sparingly, especially if you expect new lines to be added to the list later.

Never use TAB characters for horizontal alignment.

Never add trailing whitespace at the end of the line.

## Braces

- Function definition should have a brace on a separate line:

```
// This is correct:
void function(int arg)
{
}

// NOT like this:
void function(int arg) {
}
```

- Within a function, place opening brace on the same line with conditional and loop statements:



```

if (condition) {
    do_one();
} else if (other_condition) {
    do_two();
}

```

**Comments** Use `//` for single line comments. For multi-line comments it is okay to use either `//` on each line or a `/* */` block.

Although not directly related to formatting, here are a few notes about using comments effectively.

- Do not use single comments to disable some functionality:

```

void init_something()
{
    setup_dma();
    // load_resources();           // WHY is this thing commented, asks_
    →the reader?
    start_timer();
}

```

- If some code is no longer required, remove it completely. If you need it you can always look it up in git history of this file. If you disable some call because of temporary reasons, with an intention to restore it in the future, add explanation on the adjacent line:

```

void init_something()
{
    setup_dma();
    // TODO: we should load resources here, but loader is not fully integrated_
    →yet.
    // load_resources();
    start_timer();
}

```

- Same goes for `#if 0 ... #endif` blocks. Remove code block completely if it is not used. Otherwise, add comment explaining why the block is disabled. Do not use `#if 0 ... #endif` or comments to store code snippets which you may need in the future.
- Do not add trivial comments about authorship and change date. You can always look up who modified any given line using git. E.g., this comment adds clutter to the code without adding any useful information:

```

void init_something()
{
    setup_dma();
    // XXX add 2016-09-01
    init_dma_list();
    fill_dma_item(0);
    // end XXX add
    start_timer();
}

```

**Line Endings** Commits should only contain files with LF (Unix style) endings.

Windows users can configure git to check out CRLF (Windows style) endings locally and commit LF endings by setting the `core.autocrlf` setting. *Github has a document about setting this option* <[github-line-endings](#)>.

If you accidentally have some commits in your branch that add LF endings, you can convert them to Unix by running this command in an MSYS2 or Unix terminal (change directory to the IDF working directory and check the correct branch is currently checked out, beforehand):

```

git rebase --exec 'git diff-tree --no-commit-id --name-only -r HEAD | xargs_
→dos2unix && git commit -a --amend --no-edit --allow-empty' master

```

(Note that this line rebases on master, change the branch name at the end to rebase on another branch.)

For updating a single commit, it is possible to run `dos2unix FILENAME` and then run `git commit --amend`

**Formatting Your Code** ESP-IDF uses Astyle to format source code. The configuration is stored in [tools/ci/astyle-rules.yml](#) file.

Initially, all components are excluded from formatting checks. You can enable formatting checks for the component by removing it from `components_not_formatted_temporary` list. Then run:

```
pre-commit run --files <path_to_files> astyle_py
```

Alternatively, you can run `astyle_py` manually. You can install it with `pip install astyle_py==VERSION`. Make sure you have the same version installed as the one specified in [.pre-commit-config.yml](#) file. With `astyle_py` installed, run:

```
astyle_py --rules=$IDF_PATH/tools/ci/astyle-rules.yml <path-to-file>
```

**Type Definitions** Should be snake\_case, ending with `_t` suffix:

```
typedef int signed_32_bit_t;
```

**Enum** Enums should be defined through the `typedef` and be namespaced:

```
typedef enum
{
    MODULE_FOO_ONE,
    MODULE_FOO_TWO,
    MODULE_FOO_THREE
} module_foo_t;
```

**Assertions** The standard C `assert()` function, defined in `assert.h` should be used to check conditions that should be true in source code. In the default configuration, an assert condition that returns `false` or `0` will call `abort()` and trigger a *Fatal Error*.

`assert()` should only be used to detect unrecoverable errors due to a serious internal logic bug or corruption, where it is not possible for the program to continue. For recoverable errors, including errors that are possible due to invalid external input, an *error value should be returned*.

---

**备注:** When asserting a value of type `esp_err_t` is equal to `ESP_OK`, use the `ESP_ERROR_CHECK` 宏 instead of an `assert()`.

---

It is possible to configure ESP-IDF projects with assertions disabled (see [CONFIG\\_COMPILER\\_OPTIMIZATION\\_ASSERTION\\_LEVEL](#)). Therefore, functions called in an `assert()` statement should not have side-effects.

It is also necessary to use particular techniques to avoid "variable set but not used" warnings when assertions are disabled, due to code patterns such as:

```
int res = do_something();
assert(res == 0);
```

Once the `assert` is optimized out, the `res` value is unused and the compiler will warn about this. However the function `do_something()` must still be called, even if assertions are disabled.

When the variable is declared and initialized in a single statement, a good strategy is to cast it to `void` on a new line. The compiler will not produce a warning, and the variable can still be optimized out of the final binary:

```
int res = do_something();
assert(res == 0);
(void)res;
```

If the variable is declared separately, for example if it is used for multiple assertions, then it can be declared with the GCC attribute `__attribute__((unused))`. The compiler will not produce any unused variable warnings, but the variable can still be optimized out:

```
int res __attribute__((unused));

res = do_something();
assert(res == 0);

res = do_something_else();
assert(res != 0);
```

### Header File Guards

All public facing header files should have preprocessor guards. A pragma is preferred:

```
#pragma once
```

over the following pattern:

```
#ifndef FILE_NAME_H
#define FILE_NAME_H
...
#endif // FILE_NAME_H
```

In addition to guard macros, all C header files should have `extern "C"` guards to allow the header to be used from C++ code. Note that the following order should be used: `pragma once`, then any `#include` statements, then `extern "C"` guards:

```
#pragma once

#include <stdint.h>

#ifdef __cplusplus
extern "C" {
#endif

/* declarations go here */

#ifdef __cplusplus
}
#endif
```

### Include Statements

When writing `#include` statements, try to maintain the following order:

- C standard library headers.
- Other POSIX standard headers and common extensions to them (such as `sys/queue.h`.)
- Common IDF headers (`esp_log.h`, `esp_system.h`, `esp_timer.h`, `esp_sleep.h`, etc.)
- Headers of other components, such as FreeRTOS.
- Public headers of the current component.
- Private headers.

Use angle brackets for C standard library headers and other POSIX headers (`#include <stdio.h>`).

Use double quotes for all other headers (`#include "esp_log.h"`).

### C++ Code Formatting

The same rules as for C apply. Where they are not enough, apply the following rules.

**File Naming** C++ Header files have the extension `.hpp`. C++ source files have the extension `.cpp`. The latter is important for the compiler to distinguish them from normal C source files.

### Naming

- **Class and struct** names shall be written in `CamelCase` with a capital letter as beginning. Member variables and methods shall be in `snake_case`. An exception from `CamelCase` is if the readability is severely decreased, e.g., in `GPIOOutput`, then an underscore `_` is allowed to make it more readable: `GPIO_Output`.
- **Namespaces** shall be in lower `snake_case`.
- **Templates** are specified in the line above the function declaration.
- Interfaces in terms of Object-Oriented Programming shall be named without the suffix `...Interface`. Later, this makes it easier to extract interfaces from normal classes and vice versa without making a breaking change.

**Member Order in Classes** In order of precedence:

- First put the public members, then the protected, then private ones. Omit public, protected or private sections without any members.
- First put constructors/destructors, then member functions, then member variables.

For example:

```
class ForExample {
public:
    // first constructors, then default constructor, then destructor
    ForExample(double example_factor_arg);
    ForExample();
    ~ForExample();

    // then remaining public methods
    set_example_factor(double example_factor_arg);

    // then public member variables
    uint32_t public_data_member;

private:
    // first private methods
    void internal_method();

    // then private member variables
    double example_factor;
};
```

### Spacing

- Do not indent inside namespaces.
- Put public, protected and private labels at the same indentation level as the corresponding class label.

**Simple Example**

```

// file spaceship.h
#ifndef SPACESHIP_H_
#define SPACESHIP_H_
#include <cstdlib>

namespace spaceships {

class SpaceShip {
public:
    SpaceShip(size_t crew);
    size_t get_crew_size() const;

private:
    const size_t crew;
};

class SpaceShuttle : public SpaceShip {
public:
    SpaceShuttle();
};

class Sojuz : public SpaceShip {
public:
    Sojuz();
};

template <typename T>
class CargoShip {
public:
    CargoShip(const T &cargo);

private:
    T cargo;
};

} // namespace spaceships

#endif // SPACESHIP_H_

// file spaceship.cpp
#include "spaceship.h"

namespace spaceships {

// Putting the curly braces in the same line for constructors is OK if it only_
↪initializes
// values in the initializer list
SpaceShip::SpaceShip(size_t crew) : crew(crew) { }

size_t SpaceShip::get_crew_size() const
{
    return crew;
}

SpaceShuttle::SpaceShuttle() : SpaceShip(7)
{
    // doing further initialization
}

Sojuz::Sojuz() : SpaceShip(3)
{

```

(下页继续)

```
    // doing further initialization
}

template <typename T>
CargoShip<T>::CargoShip(const T &cargo) : cargo(cargo) { }

} // namespace spaceships
```

## CMake Code Style

- Indent with four spaces.
- Maximum line length 120 characters. When splitting lines, try to focus on readability where possible (for example, by pairing up keyword/argument pairs on individual lines).
- Do not put anything in the optional parentheses after `endforeach()`, `endif()`, etc.
- Use lowercase (`with_underscores`) for command, function, and macro names.
- For locally scoped variables, use lowercase (`with_underscores`).
- For globally scoped variables, use uppercase (`WITH_UNDERSCORES`).
- Otherwise follow the defaults of the [cmake-lint](#) project.

## Configuring the Code Style for a Project Using EditorConfig

EditorConfig helps developers define and maintain consistent coding styles between different editors and IDEs. The EditorConfig project consists of a file format for defining coding styles and a collection of text editor plugins that enable editors to read the file format and adhere to defined styles. EditorConfig files are easily readable and they work nicely with version control systems.

For more information, see [EditorConfig Website](#).

## Third Party Component Code Styles

ESP-IDF integrates a number of third party components where these components may have differing code styles.

**FreeRTOS** The code style adopted by FreeRTOS is described in the [FreeRTOS style guide](#). Formatting of FreeRTOS source code is automated using [Uncrustify](#), thus a copy of the FreeRTOS code style's Uncrustify configuration (`uncrustify.cfg`) is stored within ESP-IDF FreeRTOS component.

If a FreeRTOS source file is modified, the updated file can be formatted again by following the steps below:

1. Ensure that Uncrustify (v0.69.0) is installed on your system
2. Run the following command on the update FreeRTOS source file (where `source.c` is the path to the source file that requires formatting).

```
uncrustify -c $IDF_PATH/components/freertos/FreeRTOS-Kernel/uncrustify.cfg --
↪replace source.c --no-backup
```

## Documenting Code

Please see the guide here: [编写文档](#).

## Structure

To be written.

## Language Features

To be written.

### 8.5.2 为 ESP-IDF 安装 pre-commit 钩子

#### 环境依赖

我们向 IDF 开发人员推荐 Python 3.8.\* 及以上版本。

如果你已安装了不兼容的 Python 版本，应在安装 pre-commit 工具前进行更新。

#### 安装 pre-commit 工具

运行 `pip install pre-commit`。

#### 安装 pre-commit 钩子

1. 切换到 IDF 项目路径。
2. 运行 `pre-commit install --allow-missing-config -t pre-commit -t commit-msg` 命令。使用这种方式安装钩子后，即使在没有 `.pre-commit-config.yaml` 的分支中也能成功提交。
3. 在运行 `git commit` 命令时，pre-commit 钩子会自动运行。

#### 卸载 pre-commit 钩子

运行 `pre-commit uninstall`。

#### 更多

更多详细使用方法，请参考 [pre-commit](#) 文档。

#### Windows 用户常见问题

`/usr/bin/env: python: Permission denied.`

如果使用 Git Bash，请运行 `which python` 检查 Python 的可执行位置。

如果该可执行文件位于 `~/AppData/Local/Microsoft/WindowsApps/`，这其实是一个到 Windows 应用商店的链接，而不是真正的可执行文件。

请手动安装 Python，并在 PATH 环境变量中进行更新。

你的 USERPROFILE 中包含非 ASCII 字符

如果 pre-commit 的缓存路径包含非 ASCII 字符，用 pre-commit 为特定钩子初始化环境时可能会失败。解决方案是，将 `PRE_COMMIT_HOME` 设置为一个仅包含标准字符的路径，然后再运行 pre-commit。

- **CMD:** `set PRE_COMMIT_HOME=C:\somepath\pre-commit`
- **PowerShell:** `$Env:PRE_COMMIT_HOME = "C:\somepath\pre-commit"`
- **git bash:** `export PRE_COMMIT_HOME="/c/somepath/pre-commit"`

### 8.5.3 编写文档

本文档简要总结了 `espressif/esp-idf` 库中的文档风格，并介绍了如何添加新文档。

#### 概述

为本仓库代码编写文档时，请遵循 [Doxygen style](#)，即在标准注释块中插入特殊命令，如 `@param`：

```
/**
 * @param ratio this is oxygen to air ratio
 */
```

Doxygen 能够解析代码，提取此类特殊命令及其后续文本，并基于提取的信息构建文档。

下图为一个包含函数文档的典型注释块：

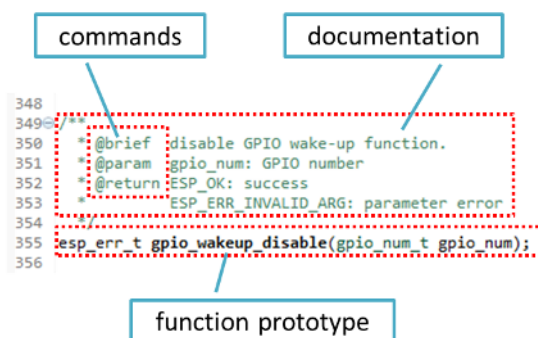

Doxygen 支持多种格式，并支持文档内部的多个详情级别，具有很强的灵活性。要了解更多可用功能，请参考 [Doxygen Manual](#)。

#### 为什么要用 Doxygen?

我们的最终目的是保证代码文档的一致性。因此，我们可以使用 [Sphinx](#) 和 [Breathe](#) 等工具，在代码变更时自动更新 API 文档。

借助这些工具，以上代码的渲染效果如下：

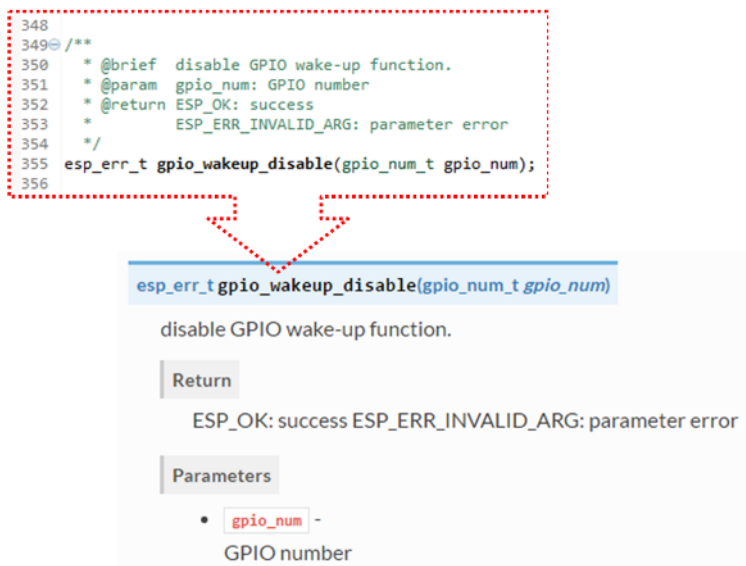



## 试一试!

为 ESP-IDF 库添加代码时，请遵循以下标准：

1. 为代码的所有构件提供文档说明，包括函数、结构体、类型定义、枚举、宏等。对其目的、功能和局限性进行充分介绍，提供符合读者预期的良好体验。
2. 函数文档应说明该函数的作用。如果函数接受输入参数并返回值，也需要对输入参数和返回值进行解释。
3. 请勿在参数前添加数据类型或除空格外的任何字符。所有空格和换行符都会压缩为一个空格。如需换行，请换行两次。

```

41 @
42 /**
43  * @brief Set log level for given tag
44  * If logging for given component has already been enabled, changes previous setting.
45  *
46  * @param tag Tag of the log entries to enable. Must be a non-NULL zero terminated string.
47  * Value "" resets log level for all tags to the given value.
48  *
49  * @param level Selects log level to enable.
50  * Only logs at this and lower levels will be shown.
51  */
52 void esp_log_level_set(const char* tag, esp_log_level_t level);

```

do not add data type

white spaces are compressed

a line break that will render

this line break will not render

```

void esp_log_level_set(const char*tag, esp_log_level_t level)

```

Set log level for given tag.

If logging for given component has already been enabled, changes previous setting.

Parameters

- **tag** - Tag of the log entries to enable. Must be a non-NULL zero terminated string. Value "" resets log level for all tags to the given value.
- **level** - Selects log level to enable. Only logs at this and lower levels will be shown.

4. 在函数输入为空或不返回值时，无需插入 @param 或 @return 命令。

```

26 @
27 /**
28  * @brief Initialize BT controller
29  * This function should be called only once,
30  * before any other BT functions are called.
31  */
32 void bt_controller_init(void);

```

```

void bt_controller_init(void)

```

Initialize BT controller.

This function should be called only once, before any other BT functions are called.

5. 为 define struct 或 enum 的成员撰写文档时，需遵循以下格式在每个成员后添加注释。

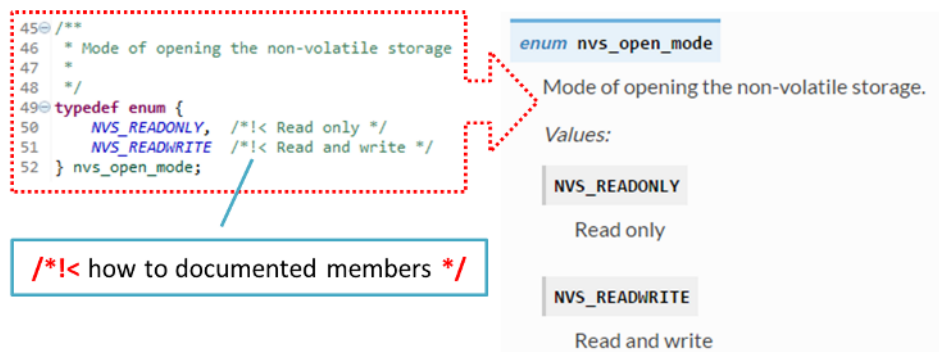

6. 要渲染出整齐的列表，可在命令后换行（如以下代码示例中的 @return 命令）。

```

*
* @return
* - ESP_OK if erase operation was successful
* - ESP_ERR_NVS_INVALID_HANDLE if handle has been closed or is NULL
* - ESP_ERR_NVS_READ_ONLY if handle was opened as read only
* - ESP_ERR_NVS_NOT_FOUND if the requested key doesn't exist
* - other error codes from the underlying storage driver

```

7. 头文件或一组文件库的功能概述需在同一路径下单独的 README.rst 文档中进行描述。如该路径下还有其他 API 的头文件，则应将此头文件对应的 README 文件命名为 apiname-readme.rst。

## 进阶用法

也可以使用以下进阶技巧，产出更加优质使用的文档。

在编写代码时，请遵循以下标准：

1. 使用 @code{c} 和 @endcode 命令添加代码示例片段，阐述实现过程。

```

*
* @code{c}
* // Example of using nvs_get_i32:
* int32_t max_buffer_size = 4096; // default value
* esp_err_t err = nvs_get_i32(my_handle, "max_buffer_size", &max_buffer_size);
* assert(err == ESP_OK || err == ESP_ERR_NVS_NOT_FOUND);
* // if ESP_ERR_NVS_NOT_FOUND was returned, max_buffer_size will still
* // have its default value.
* @endcode
*

```

该代码片段应添加在其所说明的函数的注释区中。

2. 要高亮重点信息，可使用 @attention 或 @note 命令。

```

*
* @attention
* 1. This API only impact WIFI_MODE_STA or WIFI_MODE_APSTA mode
* 2. If the ESP32 is connected to an AP, call esp_wifi_disconnect to
* ↪disconnect.
*

```

以上示例也展示了有序列表的用法。

3. 要描述一组具有相似功能的函数，可使用 /\*\*@{\*/ 和 /\*\*@}\*/ 标记命令。

```

/**@{*/
/**
* @brief common description of similar functions
*
* /

```

(下页继续)

(续上页)

```
void first_similar_function (void);
void second_similar_function (void);
/**@}*/
```

如需更多应用示例，请参考 [nvs\\_flash/include/nvs.h](#)。

- 如需进一步跳过重复定义或枚举等代码，可使用 `/** @cond */` 和 `/** @endcond */` 命令附上该代码。相关应用实例，请参考 [esp\\_driver\\_gpio/include/driver/gpio.h](#)。
- 使用 `markdown` 添加标题、链接和表格等，增强文档的可读性。

```
*
* [ESP32-H2 Technical Reference Manual] (https://www.espressif.com/sites/
* ↪default/files/documentation/esp32-h2_technical_reference_manual_en.pdf)
*
```

**备注：** 如果没有将代码片段、说明或链接等内容包含在一个文档对象相关联的注释块中，则文档中不会出现相关内容。

- 为一个或多个完整代码示例提供说明。将说明写入单独的 `README.md` 文件中并放在 `examples` 路径下对应文件夹。

## 文档格式标准化

撰写代码文档文本时，请遵循以下标准，提供格式良好的 Markdown (.md) 或 reST (.rst) 文档。

- 确保将一个段落写在同一行。通过换行加强可读性仅适用于代码，请勿在文本中以下图形式换行。为方便阅读，建议在段落之间空一行。



图 1: 一个段落写在同一行 (点击放大)



图 2: 同一段落中请勿换行 (点击放大)

- 中英文文档行号需对齐，如下所示。这样做的好处是为作者和译者节省时间。非双语作者更新文档时，仅需更新对应中文或英文文档的同一行。对译者来说，如果英文文档出现更新，可快速定位对应中文文档需更新的位置。另外，通过比较英文和中文文档的总行数，可以快速检查文档的中文版是否落后于英文版本。

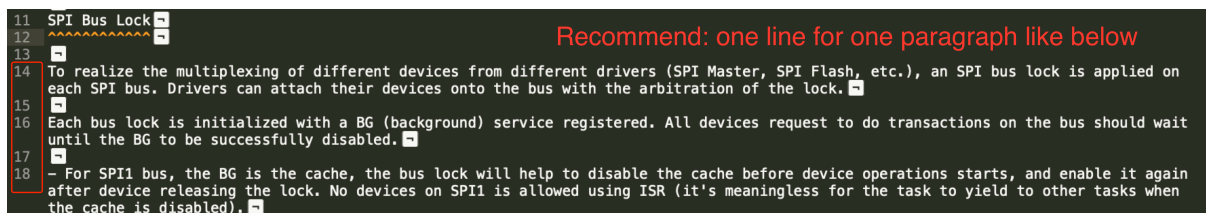

图 3: 对齐中英文文档行号 (点击放大)

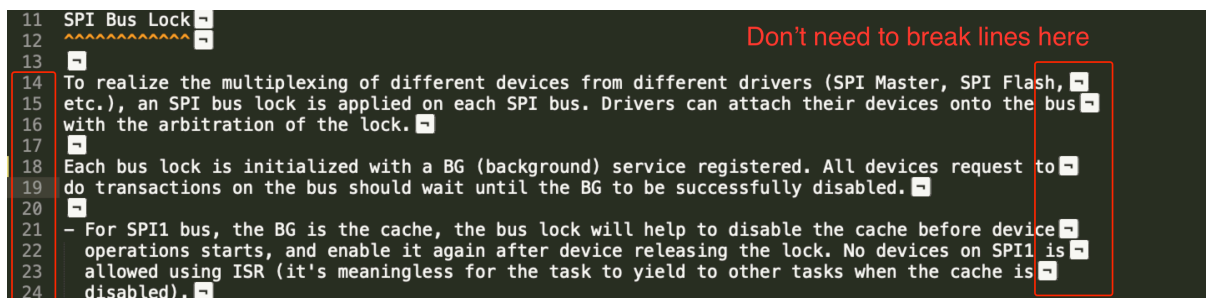
## 构建文档

文档由基于 [Sphinx](#) 的 Python 包 `esp-docs` 进行构建。

安装命令:

```
pip install esp-docs
```

安装成功后, 使用如下命令在 `docs` 文件夹中构建文档:

```
build-docs build
```

或使用以下命令指定目标芯片和语言:

```
build-docs -t esp32 -l en build
```

如需深入了解 `esp-docs` 的功能, 请参考 [esp-docs](#)。

## 小结

出色的代码可以实现令人赞叹的功能, 精心编写的文档则让开发者们如虎添翼。

期待你的贡献!

## 相关文章

- [API 文档模板](#)

## 8.5.4 创建示例项目

每个 ESP-IDF 的示例都是一个完整的项目, 其他人可以将示例复制至本地, 并根据实际情况进行一定修改。请注意, 示例项目主要是为了展示 ESP-IDF 的功能。

### 示例项目结构

- `main` 目录需要包含一个名为 `(something)_example_main.c` 的源文件, 里面包含示例项目的主要功能。

- 如果该示例项目的子任务比较多，请根据逻辑将其拆分为 main 目录下的多个 C 或者 C++ 源文件，并将对应的头文件也放在同一目录下。
- 如果该示例项目具有多种功能，可以考虑在项目中增加一个 components 子目录，通过库功能，将示例项目的不同功能划分为不同的组件。注意，如果该组件提供的功能相对完整，且具有一定的通用性，则应该将它们添加到 ESP-IDF 的 components 目录中，使其成为 ESP-IDF 的一部分。
- 示例项目需要包含一个 README.md 文件，建议使用 [示例项目 README 模板](#)，并根据项目实际情况进行修改。
- 示例项目需要包含一个 example\_test.py 文件，用于进行自动化测试。如果在 GitHub 上初次提交 Pull Request 时，可以先不包含这个脚本文件。具体细节，请见有关 [Pull Request](#) 的相关内容。

### 一般准则

示例代码需要遵循《[乐鑫物联网开发框架风格指南](#)》。

### 检查清单

提交一个新的示例项目之前，需要检查以下内容：

- 每个示例项目只能有一个主要功能。如果某个示例项目有多个主要功能，请将其拆分为两个或更多示例项目。
- 每个示例项目应包含一个 README.md 文件，建议使用 [示例项目 README 模板](#)。
- 示例项目中的函数和变量的命令要遵循[命名规范](#)中的要求。对于仅在示例项目源文件中使用的非静态变量/函数，请使用 example 或其他类似的前缀。
- 示例项目中的所有代码结构良好，关键代码要有详细注释。
- 示例项目中所有不必要的代码（旧的调试日志，注释掉的代码等）都必须清除掉。
- 示例项目中使用的选项（比如网络名称，地址等）不得直接硬编码，应尽可能地使用配置项，或者定义为宏或常量。
- 配置项可见 KConfig.projbuild 文件，该文件中包含一个名为“Example Configuration”的菜单。具体情况，请查看现有示例项目。
- 所有的源代码都需要在文件开头指定许可信息（表示该代码是 in the public domain CC0）和免责声明。或者，源代码也可以应用 Apache License 2.0 许可条款。请查看现有示例项目的许可信息和免责声明，并根据实际情况进行修改。
- 任何第三方代码（无论是直接使用，还是进行了一些改进）均应保留原始代码中的许可信息，且这些代码的许可必须兼容 Apache License 2.0 协议。

## 8.5.5 API 文档模板

---

### 备注：说明

1. 使用此文件 ([docs/zh\\_CN/api-reference/template.rst](#)) 作为 API 参考文档模板。
  2. API 参考文档需和 API 的头文件名称保持一致。
  3. 使用 `..include::` 从 API 文件夹中添加相应的说明文件。
    - README.rst
    - example.rst
    - ...
  4. 可选择在此文件中直接提供描述。
  5. 完成后，删除所有的说明信息（类似本说明）和多余的头部信息。
- 

### 概述

---

### 备注：撰写说明

1. 提供概述，简要说明 API 的用途和使用方法。
2. 必要时提供代码片段，以说明特定函数的功能。
3. 用此 [文档](#) 中介绍的方式区分不同的章节标题：
  - # 用于设置各部分，标题上下同时标记
  - \* 用于设置章标题，标题上下同时标记
  - = 用于设置节标题
  - - 用于设置小节标题
  - ^ 用于设置小小节标题
  - " 用于设置段落标题

## 应用示例

### 备注：撰写说明

1. 准备一个或多个实际示例，展示此 API 的功能。
2. 每个示例应遵循 esp-idf/examples/ 文件夹中项目的模式。
3. 将示例放在此文件夹中，添加 README.md 文件。
4. 在 README.md 中对展示的功能进行概述。
5. 良好的概述让读者能够充分理解示例，而无需参考源代码。
6. 按照示例的复杂程度，将代码描述分解成几个部分，并对每部分的功能进行概述。
7. 必要时，添加流程图和应用程序的输出截图。
8. 最后为本章节的每个示例添加对应链接，示例文件夹应位于 esp-idf/examples/ 中。

## API 参考

### 备注：撰写说明

1. ESP-IDF 仓库通过用 [Doxygen](#) 从头文件中检索代码标记的方式自动更新 API 参考文档。
2. 通过调用 Sphinx 扩展工具 esp\_extensions/run\_doxygen.py，对 [docs/doxygen/Doxyfile](#) 中 INPUT 语句列出的所有头文件进行更新。
3. INPUT 语句的每一行（以 ## 开头的注释除外）都包含一个到头文件 \*.h 的路径，用于生成相应的 \*.inc 文件：

```
##
## Wi-Fi - API Reference
##
../components/esp32/include/esp_wifi.h \
../components/esp32/include/esp_smartconfig.h \
```

4. 头文件被展开时，sdkconfig.h 中默认定义的宏以及在 SOC 特定 include/soc/\*\_caps.h 头文件中定义的宏都会被展开。这样，头文件就可以根据 IDF\_TARGET 的值来添加或排除相关内容。
5. \*.inc 文件中包含每次文档构建时自动生成的 API 成员格式化参考。所有 \*.inc 文件都位于 Sphinx 的 \_build 路径下。如需查看生成指令，以 esp\_wifi.h 为例，运行 python gen-dxd.py esp32/include/esp\_wifi.h。
6. 用以下语句在文档中显示 \*.inc 文件的内容：

```
.. include-build-file:: inc/esp_wifi.inc
```

参考示例：[docs/en/api-reference/network/esp\\_wifi.rst](#)

7. 你也可以不用 \*.inc 文件，而使用自己的方式描述 API。参考示例：[docs/en/api-reference/storage/fatfs.rst](#)。

以下为常见的 .. doxygen...:: 指令：

- 函数 - .. doxygenfunction:: name\_of\_function
- 联合体 - .. doxygenunion:: name\_of\_union
- 结构体 - .. doxygenstruct:: name\_of\_structure 和 :members:



- 宏 -... doxygendefine:: name\_of\_define
- 类定义 -... doxygentypedef:: name\_of\_type
- 枚举 -... doxygenenum:: name\_of\_enumeration

如需更多信息，请参考 [Breathe 文档](#)。

使用 `link custom role` 指令添加指向头文件的链接，如下所示：

```
* :component_file:`path_to/header_file.h`
```

8. 在任何情况下，要生成 API 参考文档，应该更新文件 `docs/doxygen/Doxyfile` 并将其中的路径更新为正在添加文档的 \*.h 头文件的路径。
9. 更改提交并构建文档后，可以查看文档的渲染效果。如有需要，为相应的头文件 [纠正注释](#)。

## 8.5.6 贡献者协议

### 个人贡献者非独占性许可协议（包含传统专利许可选项）

感谢您以贡献者身份为托管在 GitHub 上的乐鑫项目（以下简称“乐鑫”）做出贡献。

本贡献者协议（以下简称“协议”）旨在将贡献者授予乐鑫的权利明确写入文档。要有效利用这份文档，请遵循 [贡献指南](#)。

**1. 定义** **贡献者**是指向乐鑫提交贡献的个人版权所有人，本文中称“贡献者”或“您”。如果您以雇员身份提交贡献，且该贡献属于您的部分工作内容，您的雇主须已批准此协议，或作为实体签署此协议。

**贡献**是指您向乐鑫提交的、您拥有版权的原创作品（软件/文档），包括对既有工作进行的任何修改或补充。如果您没有该原创作品的完整版权，请在 GitHub 上向乐鑫提交评论。

**版权**是指在原创作品的整个存续期内（包括许可的延期），保护您所拥有或控制的原创作品的所有权利，包括版权、精神权、邻接权等，视具体情况而定。

**材料**是指乐鑫向第三方提供的软件或文档。当本协议涉及多个软件项目时，材料指您的贡献内容所提交到的软件或文档。在您提交贡献后，此贡献可能被包含在材料中。

**提交**是指向乐鑫发送的任何形式的实体、电子、或书面交流信息，包括但不限于由乐鑫管理或代表乐鑫管理的电子邮件列表、源代码控制系统和问题跟踪系统，但不包括您以显著方式标记或以其他书面形式指定为“非贡献”的交流内容。

**提交日期**是指您向乐鑫提交贡献的日期。

**文档**是指贡献中任何非软件的部分。

### 2. 版权许可 2.1 向乐鑫授予版权许可

根据本协议的条款和条件，对包含您贡献的版权，您在此授予乐鑫全球范围内免版权授权费、非独占、永久且不可撤销的版权许可，允许乐鑫无限次转让非独占性版权许可或向第三方转许可，以任何方式使用您的贡献，使用方式包括但不限于：

- 公开发布您的贡献
- 修改您的贡献内容，制作基于或包含贡献内容的衍生作品，以及将贡献内容并入其他软件代码中
- 复制原始或修改后的贡献内容
- 分发、公开、展示和公开演示您的原始贡献或修改后贡献

2.2 精神权在其受到承认的范围内不受影响，不受适用法免除。尽管如此，您仍可在贡献的源代码文件中添加自己的姓名。在使用您的贡献时，乐鑫尊重这一归属。

**3. 专利许可** 3.1 向乐鑫授予专利许可

根据本协议的条款和条件，您在此授予乐鑫全球范围内免专利授权费、非独占、永久且不可撤销（3.2 节所述情况除外）的专利许可，允许乐鑫无限次转让非独占性专利许可或向第三方转许可，从而制作、委托制作、使用、出售、许诺出售、进口、以其他方式转让贡献以及并入材料的贡献（或此结合产物的一部分）。本许可适用于您现在或此后拥有或控制的所有专利，如未经您的许可而制作、委托制作、使用、出售、许诺出售、进口、或以其他方式转让贡献本身或并入材料中的贡献，都将构成侵权。

## 3.2 撤回专利许可

如果乐鑫对您的贡献提出任何不出于防卫目的的侵权索赔，您保留撤回专利许可（如 3.1 条所述）的权利。如果某实体已向乐鑫或乐鑫的任何被许可人提出、维持或威胁进行专利侵权诉讼，或已自愿参与专利侵权诉讼，则乐鑫在此情况下向该实体提出的索赔应被视为出于“防卫目的”。

**4. 免责声明** 贡献以“原样”提供。具体地，所有明示和默示的保证条款，包括但不限于任何默示适销性保证、特定用途适用性和非侵权性保证条款，均由您对乐鑫和乐鑫对您双方互相明确表示免责。在任何此类保证不能被免责的情况下，此类保证的适用期限为法律允许的最短期限。

**5. 间接损害豁免** 在所适用的法律允许的最大范围内，对于本协议引起的任何利润损失、预期存款损失、数据丢失以及间接性、特殊性、偶然性、后果性和惩戒性损害，无论索赔所依据的法律或衡平法理论（合同、侵权或其他）如何，乐鑫或您在任何情况下均不承担责任。

**6. 近似免责声明和损害豁免** 如果第 4 节和第 5 节中提及的免责声明和间接损害豁免声明在当地适用法律下不具有法律效力，则复审法院应采用最接近于绝对免除所有与该贡献相关的民事责任的当地法律。

**7. 协议期限** 7.1 本协议在您接受条款和条件后生效。

7.2 如果本协议终止，第 4、5、6、7、8 条在本协议终止后仍然完全有效。为避免疑义，在本协议终止日前获得自由开源许可的贡献，在本协议终止后仍然完全有效。

**8. 其他条款** 8.1 本协议以及由本协议引起、或以任何方式与本协议有关的所有争议、索赔、法律行动、诉讼或其他程序，均应受中华人民共和国法律管辖，但不包括其国际私法条款。

8.2 本协议规定了您与乐鑫之间、关于您向乐鑫提供的贡献内容的完整协议，并且此协议的优先级高于其他所有正式或非正式协议。

8.3 如果本协议的任何条款被认定为无效或不可执行条款，该条款将尽量由最接近原始条款含义且可执行的条款取代。即使在本协议的基本目的或有限的补救措施失效的情况下，本协议中规定的条款和条件应仍在法律允许的最大范围内适用。

8.4 如果您了解到任何事实或情况可能影响本协议在某方面的准确性，您都同意将此事实或情况告知乐鑫。

**贡献者**

日期	
姓名	
称谓	
地址	



## 乐鑫

日期	
姓名	
称谓	
地址	

## 8.5.7 版权标头指南

ESP-IDF 基于 [the Apache License 2.0](#)，并包含一些不同许可证下的第三方版权代码。要了解更多信息，请参考 [Copyrights and Licenses](#)。

本页面介绍了如何在源代码中正确标注版权标头。ESP-IDF 使用 [Software Package Data Exchange \(SPDX\)](#) 格式，简短易读，能够方便自动化工具处理及进行版权检查。

## 如何检查版权标头

请确保你已安装了包含版权标头检查器的 [pre-commit hooks](#)。若该检查器无法检测到格式正确的 [SPDX](#) 标头，则会提供标头建议。

## 检查器的建议不正确怎么办

再好的自动化检查工具都无法取代人工检查。因此，开发者有责任修改检查器提供的标头，使其符合源代码的法律规范和许可证要求。某些许可证可能并不兼容，请参考后文示例。

检查器由 `tools/ci/check_copyright_config.yaml` 进行配置。请检查该配置文件提供的选项，并根据实际情况进行更新，以正确匹配标头。

## 常见版权标头示例

最简单的情况是，你的代码不基于任何此前已获得许可的代码，例如你完全独立完成的代码。此类代码可以使用如下版权标头，并放在 [ESP-IDF](#) 许可证下：

```
/*
 * SPDX-FileCopyrightText: 2015-2023 Espressif Systems (Shanghai) CO LTD
 *
 * SPDX-License-Identifier: Apache-2.0
 */
```

**ESP-IDF 限制性较小的部分** ESP-IDF 的某些部分特意采用了限制性较小的许可证，方便在商业闭源代码项目中重复使用。例如公有域下或免费知识共享 (CC0) 许可下的 [ESP-IDF examples](#)。此类源文件可使用如下标头：

```
/*
 * SPDX-FileCopyrightText: 2015-2023 Espressif Systems (Shanghai) CO LTD
 *
 * SPDX-License-Identifier: Unlicense OR CC0-1.0
 */
```

如允许使用多个许可证，可采用关键字 `OR` 连接，如上例所示。这可以通过在 `tools/ci/check_copyright_config.yaml` 配置文件中定义多个许可证实现。但是，请谨慎使用该方法，并仅在 [ESP-IDF](#) 项目限制性较小的部分中选择性使用。

**第三方许可证** 受到不同许可证许可，经乐鑫修改，并包含在 ESP-IDF 中的代码不能使用 Apache License 2.0 进行许可，即便检查器可能提出此类建议。建议保留原有版权标头，并在前面添加 SPDX 标识。

例如，对于一个由“GNU General Public License v2.0 及以上”许可证许可、John Doe 持有、且由 Espressif Systems 做出额外修改的代码文件，请按照如下示例提供标头：

```
/*
 * SPDX-FileCopyrightText: 1991 John Doe
 *
 * SPDX-License-Identifier: GPL-2.0-or-later
 *
 * SPDX-FileContributor: 2019-2023 Espressif Systems (Shanghai) CO LTD
 */
```

这些许可证能够得到识别，并且可以在官方 [SPDX license list](#) 中找到 SPDX 标识符。其他常见许可证还包括 GPL-2.0-only, BSD-3-Clause 和 BSD-2-Clause。

特殊情况下，如果一个许可证没有包含在 [SPDX license list](#) 中，可使用 `LicenseRef-[idString]` 自定义许可证标识符，如以下示例中的 `LicenseRef-Special-License`。另外，必须把完整的许可文本添加到 `Special-License` 文件夹下的 `LICENSES` 路径中：

```
/*
 * SPDX-FileCopyrightText: 2015-2023 Espressif Systems (Shanghai) CO LTD
 *
 * SPDX-License-Identifier: LicenseRef-Special-License
 */
```

如果自定义许可证直接包含在源文件中，可使用专门的自定义许可证标识符 `LicenseRef-Included` 进行说明：

```
/*
 * SPDX-FileCopyrightText: 2015-2023 Espressif Systems (Shanghai) CO LTD
 *
 * SPDX-License-Identifier: LicenseRef-Included
 *
 * <Full custom license text>
 */
```

`tools/ci/check_copyright_config.yaml` 中的配置为第三方许可证提供了许多有用的功能：

- 对第三方程序库的文件部分，可以定义一个不同的许可证。
- 可以永久禁用对选定文件集的检查。请谨慎使用该选项，并且仅在其他选项都不适用时，才可使用该选项。

## 8.5.8 ESP-IDF pytest 指南

ESP-IDF 有多种类型的测试需在 ESP 芯片上执行（即 **目标测试**）。目标测试通常作为 IDF 测试项目（即 **测试应用程序**）的一部分进行编译，在这个过程中，测试应用程序和其他标准 IDF 项目遵循同样的构建、烧写和监控流程。

通常，目标测试需要连接一台主机（如个人电脑），负责触发特定的测试用例、提供测试数据、检查测试结果。

ESP-IDF 在主机端使用 `pytest` 框架（以及一些 `pytest` 插件）来自动进行目标测试。本文档介绍 ESP-IDF 中的 `pytest`，并介绍以下内容：

1. ESP-IDF 中不同类型的测试应用程序。
2. 将 `pytest` 框架应用于 Python 测试脚本，进行自动化目标测试。
3. ESP-IDF CI (Continuous Integration) 板载测试流程。
4. 使用 `pytest` 在本地执行目标测试。
5. `pytest` 的使用技巧。

**备注:** ESP-IDF 默认使用以下插件:

- [pytest-embedded](#) 和默认服务 `esp,idf`
- [pytest-rerunfailures](#)

本文档介绍的所有概念和用法都基于 ESP-IDF 的默认配置, 并非都适用于原生 `pytest`。

---

## 安装

所有依赖项都可以通过执行安装脚本的 `--enable-pytest` 进行安装:

```
$ install.sh --enable-pytest
```

## 安装过程常见问题

### No Package 'dbus-1' Found

```
configure: error: Package requirements (dbus-1 >= 1.8) were not met:
No package 'dbus-1' found
Consider adjusting the PKG_CONFIG_PATH environment variable if you
installed software in a non-standard prefix.
```

如果遇到上述错误信息, 可能需要安装一些缺失的软件包。

如果使用 Ubuntu 系统, 可能需要执行:

```
sudo apt-get install libdbus-glib-1-dev
```

或

```
sudo apt-get install libdbus-1-dev
```

如使用 Linux 其他发行版本, 请在搜索引擎中查询上述错误信息, 并查找对应发行版需安装哪些缺失的软件包。

### Invalid command 'bdist\_wheel'

```
error: invalid command 'bdist_wheel'
```

如果遇到上述错误信息, 可能需要安装一些缺失的 Python 包, 例如:

```
python -m pip install -U pip
```

或

```
python -m pip install wheel
```

---

**备注:** 执行 `pip` 命令前, 请确保使用的环境为 IDF Python 虚拟环境。

---

## 测试应用程序

ESP-IDF 包含不同类型的测试应用程序, 可用 `pytest` 自动完成。

**组件测试** ESP-IDF 组件通常包含针对特定组件的测试应用程序，执行针对特定组件的单元测试。推荐通过组件测试应用程序来测试组件。所有测试应用程序都应位于 `${IDF_PATH}/components/<COMPONENT_NAME>/test_apps` 下，例如：

```

components/
├── my_component/
│   ├── include/
│   │   └── ...
│   ├── test_apps/
│   │   ├── test_app_1
│   │   │   ├── main/
│   │   │   │   └── ...
│   │   │   ├── CMakeLists.txt
│   │   │   └── pytest_my_component_app_1.py
│   │   ├── test_app_2
│   │   │   ├── ...
│   │   │   └── pytest_my_component_app_2.py
│   │   └── parent_folder
│   │       ├── test_app_3
│   │       │   ├── ...
│   │       │   └── pytest_my_component_app_3.py
│   │       └── ...
│   ├── my_component.c
│   └── CMakeLists.txt

```

**例程测试** 例程测试是为了向用户展示 ESP-IDF 的部分功能（要了解更多信息，请参考 [Examples Readme](#)）。

但是，要确保这些例程正确运行，可将例程看作测试应用，并用 `pytest` 自动执行。所有例程都应和已测试的例程，包括 Python 测试脚本一起放在 `${IDF_PATH}/examples` 路径下，例如：

```

examples/
├── parent_folder/
│   └── example_1/
│       ├── main/
│       │   └── ...
│       ├── CMakeLists.txt
│       └── pytest_example_1.py

```

**自定义测试** 自定义测试是为了测试 ESP-IDF 的一些任意功能，这些测试不是为了向用户展示 ESP-IDF 的功能。

所有自定义测试应用都位于 `${IDF_PATH}/tools/test_apps` 路径下。要了解更多信息，请参考 [Custom Test Readme](#)。

## 在 ESP-IDF 中使用 `pytest`

### pytest 执行步骤

#### 1. 引导阶段

创建会话缓存：

- 端口目标缓存
- 端口应用缓存

#### 2. 数据获取阶段

- 获取所有前缀为 `pytest_` 的 Python 文件。
- 获取所有前缀为 `test_` 的测试函数。
- 应用 `params`，并复制测试函数。
- 利用 CLI 选项筛选测试用例。详细用法请参考 [筛选测试用例](#)。

## 3. 运行阶段

- A. 创建 `fixture`。在 ESP-IDF 中，常见 `fixture` 的初始化顺序如下：
  - a. `pexpect_proc`: `pexpect` 实例
  - b. `app`: `IdfApp` 实例  
此阶段会解析测试应用程序的相关信息，如 `sdkconfig`、`flash_files`、`partition_table` 等。
  - c. `serial`: `IdfSerial` 实例  
此阶段会自动检测目标芯片所连接的主机端口。考虑到主机可能连接了多个目标芯片，应用程序会解析测试目标芯片的类型。测试程序的二进制文件会自动烧写到测试目标芯片上。
  - d. `dut`: `IdfDut` 实例
- B. 运行测试函数。
- C. 析构 `fixture`。析构顺序如下：
  - a. `dut`
    - i. 关闭 `serial` 端口。
    - ii. (仅适用于使用了 `Unity` 测试框架 的应用程序) 生成 `Unity` 测试用例的 JUnit 报告。
  - b. `serial`
  - c. `app`
  - d. `pexpect_proc`: 关闭文件描述符
- D. (仅适用于使用了 `Unity` 测试框架 的应用程序)  
如果调用了 `dut.expect_from_unity_output()`，那么检测到 `Unity` 测试失败时会触发 `AssertionError`。

## 4. 报告阶段

- A. 为测试函数生成 Junit 报告。
  - B. 将 JUnit 报告中的测试用例名修改为 ESP-IDF 测试用例 ID 格式: `<target>.<config>.<test function name>`。
5. 完成阶段 (仅适用于使用了 `Unity` 测试框架 的应用程序)  
如果生成了 `Unity` 测试用例的 JUnit 报告，这些报告会被合并。

**入门示例** 以下 Python 测试脚本示例来自 `pytest_console_basic.py`。

```
@pytest.mark.esp32
@pytest.mark.esp32c3
@pytest.mark.generic
@pytest.mark.parametrize('config', [
    'history',
    'nohistory',
], indirect=True)
def test_console_advanced(config: str, dut: IdfDut) -> None:
    if config == 'history':
        dut.expect('Command history enabled')
    elif config == 'nohistory':
        dut.expect('Command history disabled')
```

下面的小节对这个简单的测试脚本进行了逐行讲解，以说明 `pytest` 在 ESP-IDF 测试脚本中的典型使用方法。

**目标芯片 marker** 使用 `Pytest marker` 可以指出某个特定测试用例应在哪个目标芯片 (即 ESP 芯片) 上运行。例如:

```
@pytest.mark.esp32      # <-- support esp32
@pytest.mark.esp32c3   # <-- support esp32c3
@pytest.mark.generic    # <-- test env "generic"
```

上例表明，某一测试用例可以在 ESP32 和 ESP32-C3 上运行。此外，目标芯片的类型应为 `generic`。要了解有关 `generic` 类型，运行 `pytest --markers` 以获取所有 `marker` 的详细信息。

**备注：**如果测试用例可以在 ESP-IDF 官方支持的所有目标芯片上运行(调用 `idf.py --list-targets` 了解详情)，则可以使用特殊 `marker supported_targets` 指定所有目标芯片。

**参数化 marker** 可使用 `pytest.mark.parametrize` 和 `config` 参数对包含不同 `sdkconfig` 文件的不同应用程序进行相同的测试。如需了解关于 `sdkconfig.ci.xxx` 文件的更多信息，请参考 `readme` 下的 `Configuration Files` 章节。

```
@pytest.mark.parametrize('config', [
    'history',      # <-- run with app built by sdkconfig.ci.history
    'nohistory',   # <-- run with app built by sdkconfig.ci.nohistory
], indirect=True) # <-- `indirect=True` is required
```

总体而言，这一测试函数会复制为 4 个测试用例：

- `esp32.history.test_console_advanced`
- `esp32.nohistory.test_console_advanced`
- `esp32c3.history.test_console_advanced`
- `esp32c3.nohistory.test_console_advanced`

**测试串行输出** 为确保测试在目标芯片上顺利执行，测试脚本可使用 `dut.expect()` 函数来测试目标芯片上的串行输出：

```
def test_console_advanced(config: str, dut: IdfDut) -> None: # The value of _
    <-- argument `config` is assigned by the parameterization.
    if config == 'history':
        dut.expect('Command history enabled')
    elif config == 'nohistory':
        dut.expect('Command history disabled')
```

在执行 `dut.expect(...)` 时，首先会将预期字符串编译成正则表达式用于搜索串行输出结果，直到找到与该编译后的正则表达式匹配的结果或运行超时。

如果预期字符串中包含正则表达式关键字（如括号或方括号），则需格外注意。或者，也可以使用 `dut.expect_exact(...)`，它会尝试直接匹配字符串，而不将其转换为正则表达式。

如需了解关于 `expect` 函数类型的更多信息，请参考 [pytest-embedded Expecting documentation](#)。

## 进阶示例

**用同一应用程序进行多个 DUT 测试** 有时，一个测试可能涉及多个运行同一测试程序的目标芯片。在这种情况下，可以使用 `parameterize` 将多个 DUT 实例化，例如：

```
@pytest.mark.esp32s2
@pytest.mark.esp32s3
@pytest.mark.usb_host
@pytest.mark.parametrize('count', [
    2,
], indirect=True)
def test_usb_host(dut: Tuple[IdfDut, IdfDut]) -> None:
    device = dut[0] # <-- assume the first dut is the device
    host = dut[1]  # <-- and the second dut is the host
    ...
```

将参数 `count` 设置为 2 后，所有 `fixture` 都会改为元组。

**用不同应用程序进行多个 DUT 测试** 有时（特别是协议测试），一个测试可能涉及多个运行不同测试程序的目标芯片（例如不同目标芯片作为主机和从机）。在这种情况下，可以使用 `parameterize` 将针对不同测试应用程序的多个 DUT 实例化。

以下代码示例来自 `pytest_wifi_getting_started.py`。

```
@pytest.mark.esp32
@pytest.mark.multi_dut_generic
@pytest.mark.parametrize(
    'count, app_path', [
        (2,
         f'{os.path.join(os.path.dirname(__file__), "softAP")}|{os.path.join(os.
↪path.dirname(__file__), "station")}'),
        ], indirect=True
)
def test_wifi_getting_started(dut: Tuple[IdfDut, IdfDut]) -> None:
    softap = dut[0]
    station = dut[1]
    ...
```

以上示例中，第一个 DUT 用 `softAP` 应用程序烧录，第二个 DUT 用 `station` 应用程序烧录。

**备注：** 这里的 `app_path` 应设置为绝对路径。Python 中的 `__file__` 宏会返回测试脚本自身的绝对路径。

**用不同应用程序和目标芯片进行多目标测试** 以下代码示例来自 `pytest_wifi_getting_started.py`。如注释所述，该代码目前尚未在 ESP-IDF CI 中运行。

```
@pytest.mark.parametrize(
    'count, app_path, target', [
        (2,
         f'{os.path.join(os.path.dirname(__file__), "softAP")}|{os.path.join(os.
↪path.dirname(__file__), "station")}|',
         'esp32|esp32s2'),
        (2,
         f'{os.path.join(os.path.dirname(__file__), "softAP")}|{os.path.join(os.
↪path.dirname(__file__), "station")}|',
         'esp32s2|esp32'),
        ],
        indirect=True,
)
def test_wifi_getting_started(dut: Tuple[IdfDut, IdfDut]) -> None:
    softap = dut[0]
    station = dut[1]
    ...
```

总体而言，此测试函数会被复制为 2 个测试用例：

- 在 ESP32 上烧录 `softAP`，在 ESP32-S2 上烧录 `station`
- 在 ESP32-S2 上烧录 `softAP`，在 ESP32 上烧录 `station`

**支持对不同 `sdkconfig` 文件及目标芯片的组合测试** 以下进阶代码示例来自 `pytest_panic.py`。

```
CONFIGS = [
    pytest.param('coredump_flash_bin_crc', marks=[pytest.mark.esp32, pytest.mark.
↪esp32s2]),
    pytest.param('coredump_flash_elf_sha', marks=[pytest.mark.esp32]), # sha256_
↪only supported on esp32
    pytest.param('coredump_uart_bin_crc', marks=[pytest.mark.esp32, pytest.mark.
↪esp32s2]),
```

(下页继续)



(续上页)

```

    pytest.param('coredump_uart_elf_crc', marks=[pytest.mark.esp32, pytest.mark.
↳ esp32s2]),
    pytest.param('gdbstub', marks=[pytest.mark.esp32, pytest.mark.esp32s2]),
    pytest.param('panic', marks=[pytest.mark.esp32, pytest.mark.esp32s2]),
]

@pytest.mark.parametrize('config', CONFIGS, indirect=True)
...

```

**自定义类** 通常，可能会在下列情况下编写自定义类：

1. 向一定数量的 DUT 添加更多可复用功能。
2. 为不同阶段添加自定义的前置和后置函数，请参考章节 [pytest 执行步骤](#)。

以下代码示例来自 `panic/confstest.py`。

```

class PanicTestDut (IdfDut):
    ...

@pytest.fixture(scope='module')
def monkeypatch_module(request: FixtureRequest) -> MonkeyPatch:
    mp = MonkeyPatch()
    request.addfinalizer(mp.undo)
    return mp

@pytest.fixture(scope='module', autouse=True)
def replace_dut_class(monkeypatch_module: MonkeyPatch) -> None:
    monkeypatch_module setattr('pytest_embedded_idf.dut.IdfDut', PanicTestDut)

```

`monkeypatch_module` 提供了一个 **基于模块** 的 `monkeypatch` fixture。

`replace_dut_class` 是一个 **基于模块** 的 **自动执行** fixture。该函数会用你的自定义类替换 `IdfDut` 类。

**标记不稳定测试** 某些测试用例基于以太网或 Wi-Fi。然而由于网络问题，测试可能会不稳定。此时，可以将某个测试用例标记为不稳定的测试用例。

以下代码示例来自 `pytest_esp_eth.py`。

```

@pytest.mark.flaky(reruns=3, reruns_delay=5)
def test_esp_eth_ip101(dut: IdfDut) -> None:
    ...

```

这一 marker 表示，如果该测试函数失败，其测试用例会每隔 5 秒钟再运行一次，最多运行三次。

**标记已知失败** 有时，测试会因以下原因而持续失败：

- 测试的功能（或测试本身）存在错误。
- 测试环境不稳定（例如网络问题），导致失败率较高。

可使用 `xfail` marker 来标记此测试用例，并写出原因。

以下代码来自 `pytest_panic.py`。

```

@pytest.mark.xfail('config.getvalue("target") == "esp32s2"', reason='raised_
↳ IllegalInstruction instead')
def test_cache_error(dut: PanicTestDut, config: str, test_func_name: str) -> None:

```

这一 marker 表示该测试在 ESP32-S2 上是一个已知失败。



**标记夜间运行的测试用例** 在缺少 runner 时，一些测试用例仅在夜间运行的管道中触发。

```
@pytest.mark.nightly_run
```

这一 marker 表示，此测试用例仅在环境变量为 NIGHTLY\_RUN 或 INCLUDE\_NIGHTLY\_RUN 时运行。

**标记在 CI 中暂时禁用的测试用例** 在缺少 runner 时，可以在 CI 中禁用一些本地能够通过测试的测试用例。

```
@pytest.mark.temp_skip_ci(targets=['esp32', 'esp32s2'], reason='lack of runners')
```

这一 marker 表明，此测试用例仍可以在本地用 `pytest --target esp32` 执行，但不会在 CI 中执行。

**运行 Unity 测试用例** 对基于组件的单元测试应用程序，以下代码即可执行所有的单板测试用例，包括普通测试用例和多阶段测试用例：

```
def test_component_ut(dut: IdfDut):
    dut.run_all_single_board_cases()
```

此代码还会跳过所有 tag 为 [ignore] 的测试用例。

如需按组执行测试用例，可运行：

```
def test_component_ut(dut: IdfDut):
    dut.run_all_single_board_cases(group='psram')
```

此代码会触发模块包含 [psram] tag 的所有测试用例。

你可能还会看到一些包含以下语句的测试脚本，这些脚本已被弃用。请使用上述建议的方法。

```
def test_component_ut(dut: IdfDut):
    dut.expect_exact('Press ENTER to see the list of tests')
    dut.write('*')
    dut.expect_unity_test_output()
```

如需了解关于 ESP-IDF 单元测试的更多内容，请参考 [ESP32-H2 中的单元测试](#)。

## 在 CI 中执行测试

CI 的工作流程很简单，即编译任务 -> 板载测试任务。

## 编译任务

### 编译任务命名

- 基于组件的单元测试: `build_pytest_components_<target>`
- 例程测试: `build_pytest_examples_<target>`
- 自定义测试: `build_pytest_test_apps_<target>`

**编译任务命令** CI 用于创建所有相关测试的命令为: `python $IDF_PATH/tools/ci/ci_build_apps.py <parent_dir> --target <target> -vv --pytest-apps`

所有支持指定目标芯片的应用程序都使用 `build_<target>_<config>` 下支持的 `sdkconfig` 文件创建。

例如，如果运行 `python $IDF_PATH/tools/ci/ci_build_apps.py $IDF_PATH/examples/system/console/basic --target esp32 --pytest-apps` 指令，文件夹结构将如下所示：

```

basic
├── build_esp32_history/
│   └── ...
├── build_esp32_nohistory/
│   └── ...
├── main/
├── CMakeLists.txt
├── pytest_console_basic.py
└── ...

```

所有编译文件的文件夹都会上传到同一路径。

## 板载测试任务

### 板载测试任务命名

- 基于部件的单元测试: `component_ut_pytest_<target>_<test_env>`
- 例程测试: `example_test_pytest_<target>_<test_env>`
- 自定义测试: `test_app_test_pytest_<target>_<test_env>`

**板载测试任务命令** CI 用于执行所有相关测试的命令为: `pytest <parent_dir> --target <target> -m <test_env_marker>`

这一命令将执行父文件夹下所有具有指定目标芯片 `marker` 和测试环境 `marker` 的测试用例。

板载测试任务中的二进制文件是从编译任务中下载的，相应文件会放在同一路径下。

### 本地测试

首先，你需为 ESP-IDF 安装 Python 依赖：

```

$ cd $IDF_PATH
$ bash install.sh --enable-pytest
$ ./export.sh

```

默认情况下，`pytest` 脚本会按照以下顺序查找编译目录：

- `build_<target>_<sdkconfig>`
- `build_<target>`
- `build_<sdkconfig>`
- `build`

因此，运行 `pytest` 最简单的方式是调用 `idf.py build`。

例如，如果你要执行 `$IDF_PATH/examples/get-started/hello_world` 文件夹下的所有 ESP32 测试，你可执行：

```

$ cd examples/get-started/hello_world
$ idf.py build
$ pytest --target esp32

```

如果你的测试应用程序中有多个 `sdkconfig` 文件，例如那些 `sdkconfig.ci.*` 文件，仅使用 `idf.py build` 命令并不能调用这些额外的 `sdkconfig` 文件。下文以 `$IDF_PATH/examples/system/console/basic` 为例进行说明。

如果要用 `history` 配置测试此应用程序，并用 `idf.py build` 进行编译，你需运行：

```

$ cd examples/system/console/basic
$ idf.py -DSDKCONFIG_DEFAULTS="sdkconfig.defaults;sdkconfig.ci.history" build
$ pytest --target esp32 --sdkconfig history

```

如果你想同时编译测试所有 `sdkconfig` 文件，则需运行我们的 CI 脚本 (`ci_build_apps.py`) 作为辅助脚本：

```
$ cd examples/system/console/basic
$ python $IDF_PATH/tools/ci/ci_build_apps.py . --target esp32 -vv --pytest-apps
$ pytest --target esp32
```

包含 `sdkconfig.ci.history` 配置的应用程序会编译到 `build_esp32_history` 中，而包含 `sdkconfig.ci.nohistory` 配置的应用程序会编译到 `build_esp32_nohistory` 中。`pytest --target esp32` 命令会在这两个应用程序上运行测试。

## 使用技巧

### 筛选测试用例

- 根据目标芯片筛选：`pytest --target <target>`  
`pytest` 会执行所有支持指定目标芯片的测试用例。
- 根据 `sdkconfig` 文件筛选：`pytest --sdkconfig <sdkconfig>`  
如果 `<sdkconfig>` 为 `default`，`pytest` 会执行所有 `sdkconfig` 文件包含 `sdkconfig.defaults` 的测试用例。  
如果是其他情况，`pytest` 会执行所有 `sdkconfig` 文件包含 `sdkconfig.ci.<sdkconfig>` 的测试用例。
- 使用 `pytest -k <test-case name>` 按测试用例名称筛选，可以运行单个测试用例，例如 `pytest -k test_int_wdt_cache_disabled`。

**添加新 marker** 我们目前使用两种自定义 marker。`target marker` 是指测试用例支持此目标芯片，`env marker` 是指测试用例应分配到 CI 中具有相应 tag 的 runner 上。

你可以在 `${IDF_PATH}/conftest.py` 文件后添加一行新的 marker。如果该 marker 是 `target marker`，应将其添加到 `TARGET_MARKERS` 中。如果该 marker 指定了一类测试环境，应将其添加到 `ENV_MARKERS` 中。自定义 marker 格式：`<marker_name>: <marker_description>`。

**生成 JUnit 报告** 你可调用 `pytest` 执行 `--junitxml <filepath>` 生成 JUnit 报告。在 ESP-IDF 中，测试用例命名会统一为 `<target>.<config>.<function_name>`。

**跳过自动烧录二进制文件** 调试测试脚本时最好跳过自动烧录二进制文件。

调用 `pytest` 执行 `--skip-autoflash y` 即可实现。

**记录数据** 在执行测试时，你有时需要记录一些数据，例如性能测试数据。

在测试脚本中使用 `record_xml_attribute` fixture，数据就会记录在 JUnit 报告的属性中。

**日志系统** 在执行测试用例时，你有时可能需要添加一些额外的日志行。

这可通过使用 [Python 日志模块](#) 实现。

### 其他日志函数（作为 fixture）

#### log\_performance

```
def test_hello_world(
    dut: IdfDut,
    log_performance: Callable[[str, object], None],
) -> None:
    log_performance('test', 1)
```

以上示例可实现用预定义格式 [performance][test]: 1 记录性能数据，并在指定 --junitxml <filepath> 的情况下将其记录在 JUnit 报告的 properties tag 下。相应的 JUnit 测试用例节点如下所示：

```
<testcase classname="examples.get-started.hello_world.pytest_hello_world" file=
↳"examples/get-started/hello_world/pytest_hello_world.py" line="13" name="esp32.
↳default.test_hello_world" time="8.389">
  <properties>
    <property name="test" value="1"/>
  </properties>
</testcase>
```

**check\_performance** 我们提供了 TEST\_PERFORMANCE\_LESS\_THAN 和 TEST\_PERFORMANCE\_GREATER\_THAN 宏来记录性能项，并检测性能项的数值是否在有效范围内。有时 C 宏无法检测一些性能项的值，为此，我们提供了 Python 函数实现相同的目的。注意，由于 Python 函数不能很好地识别不同的 ifdef 块下同一性能项的阈值，请尽量使用 C 宏。

```
def test_hello_world(
    dut: IdfDut,
    check_performance: Callable[[str, float, str], None],
) -> None:
    check_performance('RSA_2048KEY_PUBLIC_OP', 123, 'esp32')
    check_performance('RSA_2048KEY_PUBLIC_OP', 19001, 'esp32')
```

以上示例会首先从 [components/idf\\_test/include/idf\\_performance.h](#) 和指定目标芯片的 [components/idf\\_test/include/esp32/idf\\_performance\\_target.h](#) 头文件中获取性能项 RSA\_2048KEY\_PUBLIC\_OP 的阈值，然后检查该值是否达到了最小值或超过了最大值。

例如，假设 IDF\_PERFORMANCE\_MAX\_RSA\_2048KEY\_PUBLIC\_OP 的值为 19000，则上例中第一行 check\_performance 会通过测试，第二行会失败并警告：[Performance] RSA\_2048KEY\_PUBLIC\_OP value is 19001, doesn't meet pass standard 19000. 0。

### 扩展阅读

- pytest: <https://docs.pytest.org/en/latest/contents.html>
- pytest-embedded: <https://docs.espressif.com/projects/pytest-embedded/en/latest/>



## Chapter 9

# ESP-IDF 版本简介

ESP-IDF 的 GitHub 仓库时常更新，特别是用于开发新特性的 master 分支。  
如有量产需求，请使用稳定版本。

### 9.1 发布版本

通过以下链接，可以访问各个版本的配套文档：

- 最新稳定版 ESP-IDF：[https://docs.espressif.com/projects/esp-idf/zh\\_CN/stable/](https://docs.espressif.com/projects/esp-idf/zh_CN/stable/)
- 最新版 ESP-IDF（即 master 分支）：[https://docs.espressif.com/projects/esp-idf/zh\\_CN/latest/](https://docs.espressif.com/projects/esp-idf/zh_CN/latest/)

ESP-IDF 在 GitHub 平台上的完整发布历史请见 [发布说明页面](#)。该页面支持查看各个版本的发布说明、配套文档及相应获取方式。

### 9.2 我该选择哪个版本？

- 如有量产需求，请使用 [最新稳定版本](#)。稳定版本已通过人工测试，后续更新仅修复 bug，主要特性不受影响（更多详情，请见 [版本管理](#)）。请访问 [发布说明页面](#) 界面查看每一个稳定发布版本。另外，为确保使用的 ESP-IDF 版本与需生产的芯片版本兼容，可参考 [ESP-IDF 版本与乐鑫芯片版本兼容性](#)。
- 如需尝试/测试 ESP-IDF 的最新特性，请使用 [最新版本（在 master 分支上）](#)。最新版本包含 ESP-IDF 的所有最新特性，已通过自动化测试，但尚未全部完成人工测试（因此存在一定风险）。
- 如需使用稳定版本中没有的新特性，但同时又不希望受到 master 分支更新的影响，可以按照需求选择一个最适合的稳定版本，将其 [更新至一个预发布版本](#) 或 [更新至一个发布分支](#)。
- 如需使用其他基于 ESP-IDF 的项目，请先查看该项目的文档，以确定其兼容的 ESP-IDF 版本。

有关如何更新 ESP-IDF 本地副本的内容，请参考 [更新 ESP-IDF](#) 章节。

### 9.3 版本管理

ESP-IDF 采用了 [语义版本管理方法](#)，你可以从字面含义理解每个版本的差异。其中

- 主要版本（例 v3.0）代表有重大更新，包括增加新特性、改变现有特性及移除已弃用的特性。升级至一个新的主要版本（例 v2.1 升级至 v3.0）意味着你可能需要更新工程代码，并重新测试工程，具体可参考 [发布说明页面](#) 的重大变更 (Breaking Change) 部分。
- 次要版本（例 v3.1）代表有新增特性和 bug 修复，但现有特性不受影响，公开 API 的使用也不受影响。

升级至一个新的次要版本（例 v3.0 升级至 v3.1）意味着你可能不需要更新工程代码，但需重新测试工程，特别是 [发布说明页面](#) 中专门提到的部分。

- **Bugfix** 版本（例 v3.0.1）仅修复 bug，并不增加任何新特性。  
升级至一个新的 **Bugfix** 版本（例 v3.0 升级至 v3.0.1）意味着你不需要更新工程代码，仅需测试与本次发布修复 bug（列表见 [发布说明页面](#)）直接相关的特性。

## 9.4 支持期限

ESP-IDF 的每个主要版本和次要版本都有相应的支持期限。支持期限满后，版本停止更新维护，将不再提供支持。

[支持期限政策](#) 对此有具体描述，并介绍了每个版本的支持期限是如何界定的。

[发布说明页面](#) 界面上的每一个发布版本都提供了该版本的支持期限信息。

一般而言：

- 如果你刚开始一个新项目，建议使用最新稳定版本。
- 如果你有 GitHub 账号，请点击 [发布说明页面](#) 界面右上角的“Watch”按钮，并选中“Releases only”选项。GitHub 将会在新版本发布的时候发送通知。当你所使用的版本有 **Bugfix** 版本发布时，请做好升级至该 **Bugfix** 版本的规划。
- 如可能，请定期（如每年一次）将项目的 IDF 版本升级至一个新的主要版本或次要版本。对于次要版本更新，更新过程应该比较简单，但对于主要版本更新，可能需要细致查看发布说明并做对应的更新规划。
- 请确保你所使用的版本停止更新维护前，已做好升级至新版本的规划。

ESP-IDF 的每个主要版本和次要版本（V4.1、V4.2 等）的支持期限为 30 个月，从最初的稳定版发布日期起。

在支持期限内意味着 ESP-IDF 团队将继续在 GitHub 的发布分支上进行 bug 修复、安全修复等，并根据需要定期发布新的 **Bugfix** 版本。

支持期限分为“服务期”和“维护期”：

周期	时长	是否推荐新工程使用
服务期	12 个月	是
维护期	18 个月	否

在服务期内，**Bugfix** 版本的发布更为频繁。某些情况下，在服务期内会增加新特性，这些特性主要是为了满足新产品特定监管要求或标准，并且回归风险非常低。

在维护期内，该版本仍受支持，但只会对严重性较高的问题或安全问题进行 bug 修复。

当开始一个新项目时，建议使用在服务期内的版本。

鼓励用户在所用版本支持期限结束之前，将所有的工程升级到最新的 ESP-IDF 版本。在版本支持期限满后，我们将不再继续进行 bug 修复。

支持期限不包括预发布版本（betas、预览版、-rc 和 -dev 版等），有时会将某个特性在发布版中标记为“预览版”，这意味着该特性也不在支持期限内。

关于 [不同版本的 ESP-IDF](#)（主要版本、次要版本、**Bugfix** 版本等）的更多信息，请参考 ESP-IDF 编程指南。

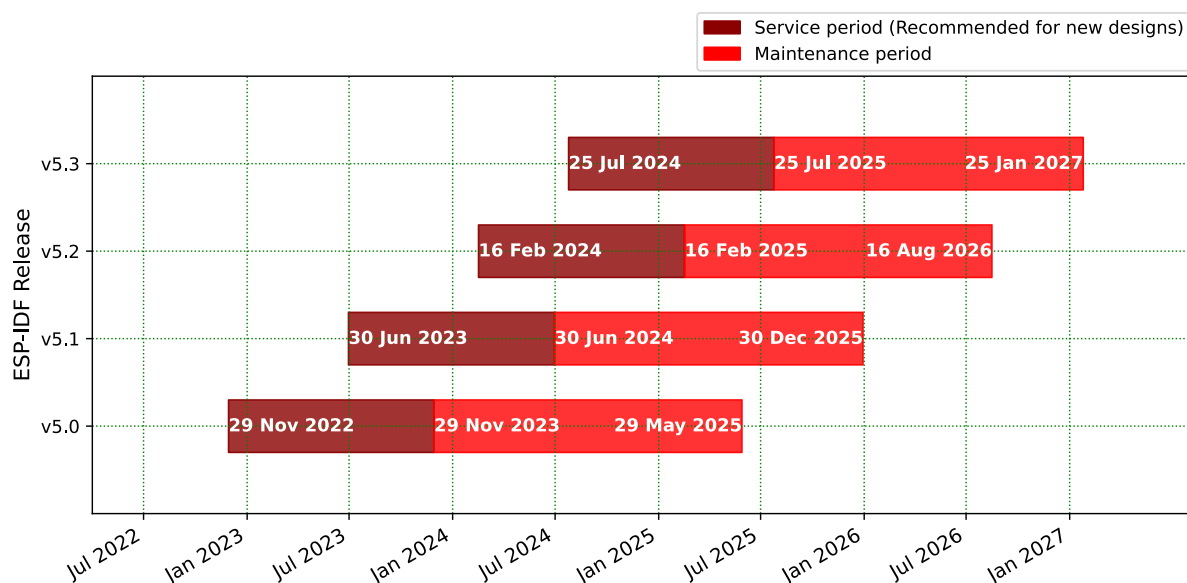

## 9.5 查看当前版本

查看 ESP-IDF 本地副本的版本，请使用 `idf.py` 命令：

```
idf.py --version
```

此外，由于 ESP-IDF 的版本也已编译至固件中，因此你也可以使用宏 `IDF_VER` 查看 ESP-IDF 的版本（以字符串的格式）。ESP-IDF 默认引导程序会在设备启动时打印 ESP-IDF 的版本。请注意，在 GitHub 仓库中的代码更新时，代码中的版本信息仅会在源代码重新编译或在清除编译时才会更新，因此打印出来的版本可能并不是最新的。

如果编写的代码需要支持多个 ESP-IDF 版本，可以在编译时使用 *compile-time macros* 检查版本。

几个 ESP-IDF 版本的例子：

版本字符串	含义
v3.2-dev-306-gbeb3611ca	<p>master 分支上的预发布版本。</p> <ul style="list-style-type: none"> <li>- v3.2-dev: 为 v3.2 进行的开发。</li> <li>- 306: v3.2 开发启动后的 commit 数量。</li> <li>- beb3611ca: commit 标识符。</li> </ul>
v3.0.2	稳定版本，标签为 v3.0.2。
v3.1-beta1-75-g346d6b0ea	<p>v3.1 的 beta 测试版本（可参考<a href="#">更新至一个发布分支</a>）。</p> <ul style="list-style-type: none"> <li>- v3.1-beta1 - 预发布标签。</li> <li>- 75: 添加预发布 beta 标签后的 commit 数量。</li> <li>- 346d6b0ea: commit 标识符。</li> </ul>
v3.0.1-dirty	<p>稳定版本，标签为 v3.0.1。</p> <ul style="list-style-type: none"> <li>- dirty 代表 ESP-IDF 的本地副本有修改。</li> </ul>



## 9.6 Git 工作流

乐鑫 ESP-IDF 团队的 (Git) 开发工作流程如下：

- 新的改动总是在 `master` 分支（最新版本）上进行。`master` 分支上的 ESP-IDF 版本总带有 `-dev` 标签，表示“正在开发中”，例 `v3.1-dev`。
- 这些改动将首先在乐鑫的内部 Git 仓库进行代码审阅与测试，而后在自动化测试完成后推至 GitHub。
- 新版本一旦完成特性开发（在 `master` 分支上进行）并达到进入 `beta` 测试的标准，则将该版本切换至一个新分支（例 `release/v3.1`）。此外，该分支还打上预发布标签（例 `v3.1-beta1`）。你可以在 GitHub 平台上查看 ESP-IDF 的完整 [分支列表](#) 和 [标签列表](#)。`Beta` 预发布版本可能仍存在大量“已知问题”（Known Issue）。
- 随着对 `beta` 版本的不断测试，`bug` 修复将同时增加至该发布分支和 `master` 分支。而且，`master` 分支可能也已经开始为下个版本开发新特性了。
- 当测试快结束时，该发布分支上将增加一个 `rc` 标签，代表候选发布（Release Candidate），例 `v3.1-rc1`。此时，该分支仍属于预发布版本。
- 如果一直未发现或报告重大 `bug`，则该预发布版本将最终增加“主要版本”（例 `v4.0`）或“次要版本”标记（例 `v3.1`），成为正式发布版本，并体现在 [发布说明页面](#)。
- 后续，发布版本中发现的 `bug` 都将在该发布分支上进行修复。
- 发布分支上会定期进行 `bug` 修复，人工测试完成后，该分支将增加一个 `Bugfix` 版本标签（例 `v3.1.1`），并体现在 [发布说明页面](#)。

## 9.7 更新 ESP-IDF

请根据实际情况，对 ESP-IDF 进行更新。

- 如有量产用途，建议参考[更新至一个稳定发布版本](#)。
- 如需测试/研发/尝试最新特性，建议参考[更新至 `master` 分支](#)。
- 两者折衷建议参考[更新至一个发布分支](#)。

---

**备注：** 在参考本指南时，请首先获得 ESP-IDF 的本地副本，具体步骤请参考[入门指南](#) 中的介绍。

---

### 9.7.1 更新至一个稳定发布版本

对于量产用户，推荐更新至一个新的 ESP-IDF 发布版本，请参考以下步骤：

- 请定期查看 [发布说明页面](#)，了解最新发布情况。
- 如有新发布的 `Bugfix` 版本（例 `v3.0.1` 或 `v3.0.2`）时，请将新的 `Bugfix` 版本更新至你的 ESP-IDF 目录。
- 在 Linux 或 macOS 系统中，请运行如下命令将分支更新至 `vX.Y.Z`：

```
cd $IDF_PATH
git fetch
git checkout vX.Y.Z
git submodule update --init --recursive
```

- 在 Windows 系统中，需要将 `cd $IDF_PATH` 替换为 `cd %IDF_PATH%`。
- 在主要版本或次要版本新发布时，请查看发布说明中的具体描述，并决定是否升级版本。具体命令与上方描述一致。

---

**备注：** 如果你在安装 ESP-IDF 时使用的是 `zip` 文件包，而非通过 `Git` 命令，则将无法使用 `Git` 命令进行版本升级，此属正常情况。这种情况下，请重新下载最新 `zip` 文件包，并替换掉之前 `IDF_PATH` 下的全部内容。

---

## 9.7.2 更新至一个预发布版本

你也可以将你的本地副本切换（命令 `git checkout`）至一个预发布版本或 rc 版本，具体方法请参考[更新至一个稳定发布版本](#)中的描述。

预发布版本通常不体现在[发布说明页面](#)。更多详情，请查看完整[标签列表](#)。使用预发布版本的注意事项，请参考[更新至一个发布分支](#)中的描述。

## 9.7.3 更新至 master 分支

---

**备注：**ESP-IDF 中 master 分支上的代码会时时更新，因此使用 master 分支相当在“流血的边缘试探”，存在一定风险。

---

如需使用 ESP-IDF 的 master 分支，请参考以下步骤：

- 在 Linux 或 macOS 系统中，使用如下命令在本地切换至 master 分支：

```
cd $IDF_PATH
git checkout master
git pull
git submodule update --init --recursive
```

- 在 Windows 系统中，需要将 `cd $IDF_PATH` 替换为 `cd %IDF_PATH%`。
- 此外，你还应在后续工作中不时使用 `git pull` 命令，将远端 master 上的更新同步到本地。注意，在更新 master 分支后，你可能需要更改工程代码，也可能遇到新的 bug。
- 如需从 master 分支切换至一个发布分支或稳定版本，请使用 `git checkout` 命令。

---

**重要：**强烈建议定期使用 `git pull` 和 `git submodule update --init --recursive` 命令，确保本地副本得到及时更新。旧的 master 分支相当于一个“快照”，可能存在未记录的问题，且无法获得支持。对于半稳定版本，请参考[更新至一个发布分支](#)。

---

## 9.7.4 更新至一个发布分支

从稳定性来说，使用“发布分支”相当于在使用 master 分支和稳定版本之间进行折衷，包含一些 master 分支上的新特性，但也同时保证可通过 beta 测试且基本完成了 bug 修复。

更多详情，请前往 GitHub 查看完整[标签列表](#)。

例如，在 Linux 或 macOS 系统中，可以运行以下命令更新至 ESP-IDF v3.1，随时关注该分支上的 Bugfix 版本发布（如 v3.1.1 等）：

```
cd $IDF_PATH
git fetch
git checkout release/v3.1
git pull
git submodule update --init --recursive
```

在 Windows 系统中，需要将 `cd $IDF_PATH` 替换为 `cd %IDF_PATH%`。

每次在该分支上使用 `git pull` 时，都相当于把最新的 Bugfix 版本发布更新至你的本地副本中。

---

**备注：**发布分支并不会会有专门的配套文档，建议使用与本分支最接近版本的文档。

---



## Chapter 10

# 资源

### 10.1 PlatformIO



- [什么是 PlatformIO ?](#)
- [安装](#)
- [配置](#)
- [教程](#)
- [项目示例](#)
- [更多内容](#)

#### 10.1.1 什么是 PlatformIO ?

PlatformIO 是一个跨平台的嵌入式开发环境，能直接支持 ESP-IDF。

由于 PlatformIO 对 ESP-IDF 的支持并非由 Espressif 团队维护，如果遇到 PlatformIO 相关的问题，请通过 [官方 PlatformIO 库](#) 联系其开发人员。

要了解关于 PlatformIO 生态系统及其理念的详细概述，请参考 [官方 PlatformIO 文档](#)。

#### 10.1.2 安装

- [PlatformIO IDE](#) 是一个可在 Windows, macOS 和 Linux 平台上使用的嵌入式 C/C++ 开发工具集。
- [PlatformIO Core \(CLI\)](#) 是一个命令行工具，包含多平台编译系统，平台和库管理器以及其他集成组件。它可以与各种代码开发环境一起使用，还可以集成云平台和网络服务。

### 10.1.3 配置

请参阅 [PlatformIO 官方的 ESP-IDF 配置指南](#)。

### 10.1.4 教程

- [ESP-IDF and ESP32-DevKitC: debugging, unit testing, project analysis](#)

### 10.1.5 项目示例

请参阅 [PlatformIO 官方文档](#) 中 ESP-IDF 相关内容。

### 10.1.6 更多内容

访问以下链接探索 PlatformIO 生态系统：

- 了解更多 [与其他 IDE 或文本编辑器集成](#) 的信息。
- 从 [PlatformIO 社区](#) 获取帮助。

## 10.2 CLion

### 10.2.1 CLion 是什么？

CLion 是用于 C 和 C++ 编程的跨平台集成开发环境 (IDE)。CLion 还提供了专门支持 ESP-IDF 的功能，使开发人员能够无缝使用 ESP-IDF 框架。

### 10.2.2 安装

安装 CLion，请参考 [CLion 安装指南](#)，可根据操作系统（Windows, macOS, or Linux）选择适用的版本。

### 10.2.3 配置

要在 CLion 中配置一个 ESP-IDF 项目，请参考 [在 CLion 中配置 ESP CMake 项目](#)。本指南将带您逐步完成配置项目的必要步骤。

### 10.2.4 资源

有关 CLion 和 ESP-IDF 集成的更多信息，请参考以下资源：

- [CLion 文档](#)：CLion 官方文档提供了有关 IDE 各方面内容的详细信息，包括 ESP-IDF 集成。

## 10.3 VisualGDB

### 10.3.1 VisualGDB 是什么?

VisualGDB 是 Microsoft Visual Studio 的一个强大扩展，为嵌入式系统提供包括支持 ESP-IDF 框架在内的一系列先进的开发工具和功能。通过 VisualGDB，能够在 ESP-IDF 项目中利用熟悉且功能丰富的 Visual Studio 环境，从而实现高效的编码、调试与部署。

### 10.3.2 安装

请参照 [下载和安装 VisualGDB](#)，下载和安装 VisualGDB。

### 10.3.3 配置

请参照 [使用 ESP-IDF 在 VisualGDB 中创建高级 ESP32 项目](#)，在 VisualGDB 中配置 ESP-IDF 项目。

也可以参考 [高级 ESP-IDF 项目结构](#)，了解更多关于使用 VisualGDB 开发 ESP-IDF 项目的信息。

### 10.3.4 资源

有关 VisualGDB 和 ESP-IDF 集成的更多信息，请参阅以下资源：

- [VisualGDB 文档](#): VisualGDB 的官方文档提供了关于使用 VisualGDB 与 ESP-IDF 的全面指南和教程。

有关这些第三方工具的问题，请寻求该工具的支持渠道或用户社区的帮助。

## 10.4 有用的链接

- 请在 [ESP32 论坛](#) 中提出问题，访问社区资源。
- 请通过 GitHub 的 [Issues](#) 版块提交 bug 或功能请求。在提交新 Issue 之前，请先查看现有的 [Issues](#)。
- 请在 [ESP IoT Solution](#) 库中找到基于 ESP-IDF 的 [解决方案](#)、[应用实例](#)、[组件和驱动](#) 等内容。多数文档均提供中英文版本。
- 通过 Arduino 平台开发应用，请参考 [ESP32](#)、[ESP32-S2](#) 和 [ESP32-C3](#) 芯片的 [Arduino 内核](#)。
- 关于 ESP32 的书籍列表，请查看 [乐鑫](#) 网站。
- 如果你有兴趣参与到 ESP-IDF 的开发，请查阅 [贡献指南](#)。
- 关于 ESP32-H2 的其它信息，请查看官网 [文档](#) 版块。
- 关于本文档的 PDF 和 HTML 格式下载（最新版本和早期版本），请点击 [下载](#)。



# Chapter 11

## Copyrights and Licenses

### 11.1 Software Copyrights

All original source code in this repository is Copyright (C) 2015-2023 Espressif Systems. This source code is licensed under the Apache License 2.0 as described in the file LICENSE.

Additional third party copyrighted code is included under the following licenses.

Where source code headers specify Copyright & License information, this information takes precedence over the summaries made here.

Some examples use external components which are not Apache licensed, please check the copyright description in each example source code.

#### 11.1.1 Firmware Components

These third party libraries can be included into the application (firmware) produced by ESP-IDF.

- [Newlib](#) is licensed under the BSD License and is Copyright of various parties, as described in [COPYING.NEWLIB](#) .
- [Xtensa header files](#) are Copyright (C) 2013 Tensilica Inc and are licensed under the MIT License as reproduced in the individual header files.
- Original parts of [FreeRTOS](#) (components/freertos) are Copyright (C) 2017 Amazon.com, Inc. or its affiliates are licensed under the MIT License, as described in [license.txt](#) .
- Original parts of [LWIP](#) (components/lwip) are Copyright (C) 2001, 2002 Swedish Institute of Computer Science and are licensed under the BSD License as described in [COPYING file](#) .
- [wpa\\_supplicant](#) Copyright (c) 2003-2022 Jouni Malinen <[j@w1.fi](mailto:j@w1.fi)> and contributors and licensed under the BSD license.
- [Fast PBKDF2](#) Copyright (c) 2015 Joseph Birr-Pixton and licensed under CC0 Public Domain Dedication license.
- [FreeBSD net80211](#) Copyright (c) 2004-2008 Sam Leffler, Errno Consulting and licensed under the BSD license.
- [argtable3](#) argument parsing library Copyright (C) 1998-2001,2003-2011,2013 Stewart Heitmann and licensed under 3-clause BSD license. [argtable3](#) also includes the following software components. For details, please see [argtable3 LICENSE file](#) .
  - C Hash Table library, Copyright (c) 2002, Christopher Clark and licensed under 3-clause BSD license.
  - The Better String library, Copyright (c) 2014, Paul Hsieh and licensed under 3-clause BSD license.
  - TCL library, Copyright the Regents of the University of California, Sun Microsystems, Inc., Scriptics Corporation, ActiveState Corporation and other parties, and licensed under TCL/TK License.
- [linenoise](#) line editing library Copyright (c) 2010-2014 Salvatore Sanfilippo, Copyright (c) 2010-2013 Pieter Noordhuis, licensed under 2-clause BSD license.
- [FatFS](#) library, Copyright (C) 2017 ChaN, is licensed under [a BSD-style license](#) .



- [cJSON](#) library, Copyright (c) 2009-2017 Dave Gamble and cJSON contributors, is licensed under MIT license as described in [LICENSE file](#) .
- [micro-ecc](#) library, Copyright (c) 2014 Kenneth MacKay, is licensed under 2-clause BSD license.
- [Mbed TLS](#) library, Copyright (C) 2006-2018 ARM Limited, is licensed under Apache License 2.0 as described in [LICENSE file](#) .
- [SPIFFS](#) library, Copyright (c) 2013-2017 Peter Andersson, is licensed under MIT license as described in [LICENSE file](#) .
- [SD/MMC driver](#) is derived from [OpenBSD SD/MMC driver](#), Copyright (c) 2006 Uwe Stuehler, and is licensed under BSD license.
- [ESP-MQTT](#) MQTT Package (contiki-mqtt) - Copyright (c) 2014, Stephen Robinson, MQTT-ESP - Tuan PM <tuanpm at live dot com> is licensed under Apache License 2.0 as described in [LICENSE file](#) .
- [BLE Mesh](#) is adapted from Zephyr Project, Copyright (c) 2017-2018 Intel Corporation and licensed under Apache License 2.0.
- [mynewt-nimble](#) Apache Mynewt NimBLE, Copyright 2015-2018, The Apache Software Foundation, is licensed under Apache License 2.0 as described in [LICENSE file](#) .
- [TLSF allocator](#) Two Level Segregated Fit memory allocator, Copyright (c) 2006-2016, Matthew Conte, and licensed under the BSD 3-clause license.
- [openthread](#), Copyright (c) The OpenThread Authors, is licensed under BSD License as described in [LICENSE file](#) .
- [UBSAN runtime](#) —Copyright (c) 2016, Linaro Limited and Jiří Závěručky, licensed under the BSD 2-clause license.
- [HTTP Parser](#) Based on src/http/nginx\_http\_parse.c from NGINX copyright Igor Sysoev. Additional changes are licensed under the same terms as NGINX and Joyent, Inc. and other Node contributors. For details please check [LICENSE file](#) .
- [SEGGER SystemView](#) target-side library, Copyright (c) 1995-2021 SEGGER Microcontroller GmbH, is licensed under BSD 1-clause license.
- [protobuf-c](#) Protocol Buffers implementation in C, Copyright (c) 2008-2022, Dave Benson and the protobuf-c authors. For details please check [LICENSE file](#) .
- [CMock](#) Mock/stub generator for C, Copyright (c) 2007-14 Mike Karlesky, Mark VanderVoord, Greg Williams, is licensed under MIT license as described in [LICENSE file](#) .
- [Unity](#) Simple Unit Testing library, Copyright (c) 2007-23 Mike Karlesky, Mark VanderVoord, Greg Williams, is licensed under MIT license as described in [LICENSE file](#) .

### 11.1.2 Documentation

- HTML version of the [ESP-IDF Programming Guide](#) uses the Sphinx theme [sphinx\\_idf\\_theme](#), which is Copyright (c) 2013-2020 Dave Snider, Read the Docs, Inc. & contributors, and Espressif Systems (Shanghai) CO., LTD. It is based on [sphinx\\_rtd\\_theme](#). Both are licensed under MIT license.

## 11.2 ROM Source Code Copyrights

Espressif SoCs mask ROM hardware includes binaries compiled from portions of the following third party software:

- [Newlib](#) , licensed under the BSD License and is Copyright of various parties, as described in [COPYING.NEWLIB](#) .
- Xtensa libhal, Copyright (c) Tensilica Inc and licensed under the MIT license (see below).
- [TinyBasic Plus](#), Copyright Mike Field & Scott Lawrence and licensed under the MIT license (see below).
- [miniz](#), by Rich Geldreich - placed into the public domain.
- [TJpgDec](#) Copyright (C) 2011, ChaN, all right reserved. See below for license.
- **Parts of Zephyr RTOS USB stack:**
  - [DesignWare USB device driver](#) Copyright (c) 2016 Intel Corporation and licensed under Apache 2.0 license.
  - [Generic USB device driver](#) Copyright (c) 2006 Bertrik Sikken ([bertrik@sikken.nl](mailto:bertrik@sikken.nl)), 2016 Intel Corporation and licensed under BSD 3-clause license.
  - [USB descriptors functionality](#) Copyright (c) 2017 PHYTEC Messtechnik GmbH, 2017-2018 Intel Corporation and licensed under Apache 2.0 license.

- [USB DFU class driver](#) Copyright (c) 2015-2016 Intel Corporation, 2017 PHYTEC Messtechnik GmbH and licensed under BSD 3-clause license.
- [USB CDC ACM class driver](#) Copyright (c) 2015-2016 Intel Corporation and licensed under Apache 2.0 license.

### 11.3 Xtensa libhal MIT License

Copyright (c) 2003, 2006, 2010 Tensilica Inc.

Permission is hereby granted, free of charge, to any person obtaining a copy of this software and associated documentation files (the "Software"), to deal in the Software without restriction, including without limitation the rights to use, copy, modify, merge, publish, distribute, sublicense, and/or sell copies of the Software, and to permit persons to whom the Software is furnished to do so, subject to the following conditions:

The above copyright notice and this permission notice shall be included in all copies or substantial portions of the Software.

THE SOFTWARE IS PROVIDED "AS IS", WITHOUT WARRANTY OF ANY KIND, EXPRESS OR IMPLIED, INCLUDING BUT NOT LIMITED TO THE WARRANTIES OF MERCHANTABILITY, FITNESS FOR A PARTICULAR PURPOSE AND NONINFRINGEMENT. IN NO EVENT SHALL THE AUTHORS OR COPYRIGHT HOLDERS BE LIABLE FOR ANY CLAIM, DAMAGES OR OTHER LIABILITY, WHETHER IN AN ACTION OF CONTRACT, TORT OR OTHERWISE, ARISING FROM, OUT OF OR IN CONNECTION WITH THE SOFTWARE OR THE USE OR OTHER DEALINGS IN THE SOFTWARE.

### 11.4 TinyBasic Plus MIT License

Copyright (c) 2012-2013

Permission is hereby granted, free of charge, to any person obtaining a copy of this software and associated documentation files (the "Software"), to deal in the Software without restriction, including without limitation the rights to use, copy, modify, merge, publish, distribute, sublicense, and/or sell copies of the Software, and to permit persons to whom the Software is furnished to do so, subject to the following conditions:

The above copyright notice and this permission notice shall be included in all copies or substantial portions of the Software.

THE SOFTWARE IS PROVIDED "AS IS", WITHOUT WARRANTY OF ANY KIND, EXPRESS OR IMPLIED, INCLUDING BUT NOT LIMITED TO THE WARRANTIES OF MERCHANTABILITY, FITNESS FOR A PARTICULAR PURPOSE AND NONINFRINGEMENT. IN NO EVENT SHALL THE AUTHORS OR COPYRIGHT HOLDERS BE LIABLE FOR ANY CLAIM, DAMAGES OR OTHER LIABILITY, WHETHER IN AN ACTION OF CONTRACT, TORT OR OTHERWISE, ARISING FROM, OUT OF OR IN CONNECTION WITH THE SOFTWARE OR THE USE OR OTHER DEALINGS IN THE SOFTWARE.

### 11.5 TJpgDec License

TJpgDec - Tiny JPEG Decompressor R0.01 (C) ChaN, 2011 The TJpgDec is a generic JPEG decompressor module for tiny embedded systems. This is a free software that opened for education, research and commercial developments under license policy of following terms.

Copyright (C) 2011, ChaN, all right reserved.

- The TJpgDec module is a free software and there is NO WARRANTY.
- No restriction on use. You can use, modify and redistribute it for personal, non-profit or commercial products UNDER YOUR RESPONSIBILITY.
- Redistributions of source code must retain the above copyright notice.



## Chapter 12

# 关于本指南

本指南为 ESP32-H2 官方应用开发框架 [ESP-IDF](#) 的配套文档。

ESP32-H2 是一款支持 802.15.4 Thread/Zigbee 和低功耗蓝牙的芯片，搭载 RISC-V RV32IMAC 32 位单核处理器。



图 1: 乐鑫物联网综合开发框架

ESP-IDF 即乐鑫物联网开发框架，可为在 Windows、Linux 和 macOS 系统平台上开发 ESP32-H2 应用程序提供工具链、API、组件和工作流程的支持。

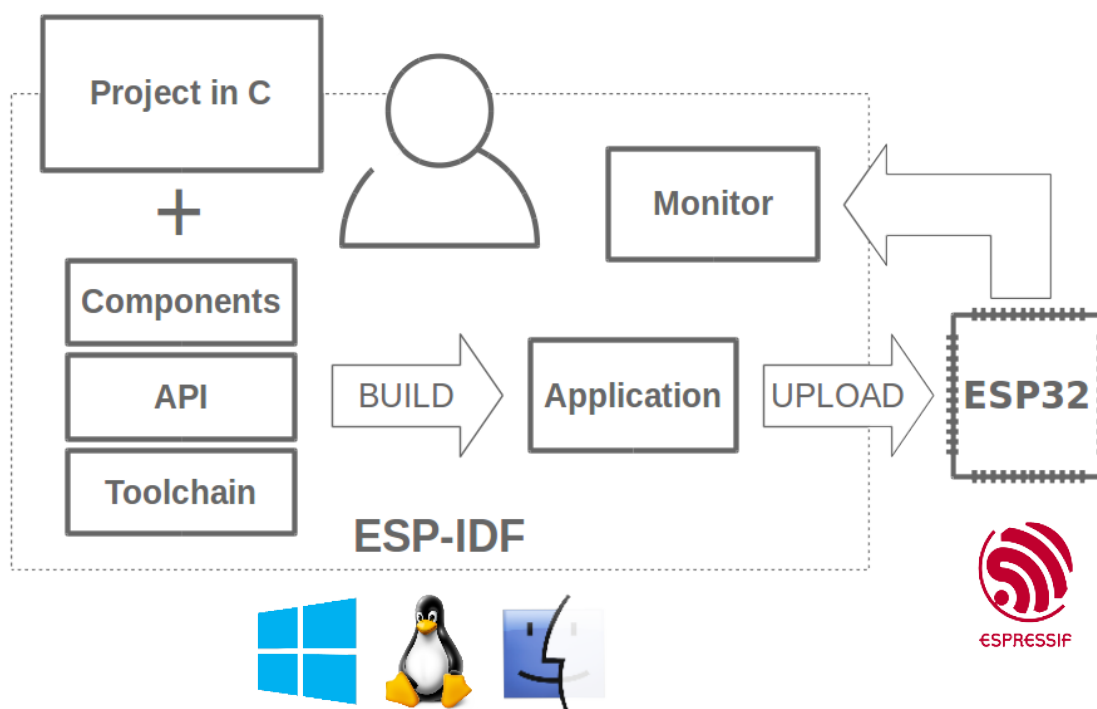

## Chapter 13

# 切换语言

《ESP-IDF 编程指南》部分文档现在有两种语言的版本。如有出入，请以英文版本为准。

- 英文
- 中文

如下图所示，如果该文档两种语言版本均具备，可以通过点击文档上方的语言链接，轻松进行语言切换。

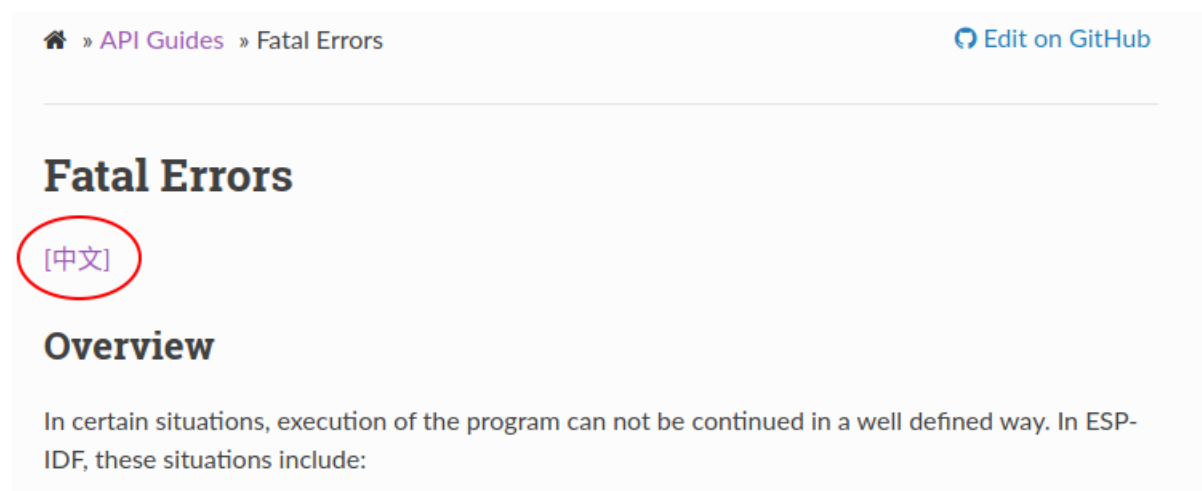



# 索引

## 符号

`_ESP_LOG_EARLY_ENABLED` (*C macro*), 1978

`_ip_addr` (*C++ struct*), 775

`_ip_addr::ip4` (*C++ member*), 776

`_ip_addr::ip6` (*C++ member*), 776

`_ip_addr::type` (*C++ member*), 776

`_ip_addr::u_addr` (*C++ member*), 776

[anonymous] (*C++ enum*), 391, 1143, 2038

[anonymous]::ESP\_BLE\_MESH\_SERVER\_FLAG\_MAX  
(*C++ enumerator*), 391

[anonymous]::ESP\_BLE\_MESH\_SERVER\_TRANS\_TIMER\_START  
(*C++ enumerator*), 391

[anonymous]::ESP\_ERR\_FLASH\_NO\_RESPONSE  
(*C++ enumerator*), 1144

[anonymous]::ESP\_ERR\_FLASH\_SIZE\_NOT\_MATCH  
(*C++ enumerator*), 1143

[anonymous]::ESP\_ERR\_SLEEP\_REJECT  
(*C++ enumerator*), 2038

[anonymous]::ESP\_ERR\_SLEEP\_TOO\_SHORT\_SLEEP\_DURATION  
(*C++ enumerator*), 2038

## A

`adc_atten_t` (*C++ enum*), 787

`adc_atten_t::ADC_ATTEN_DB_0` (*C++ enumerator*), 787

`adc_atten_t::ADC_ATTEN_DB_11` (*C++ enumerator*), 787

`adc_atten_t::ADC_ATTEN_DB_12` (*C++ enumerator*), 787

`adc_atten_t::ADC_ATTEN_DB_2_5` (*C++ enumerator*), 787

`adc_atten_t::ADC_ATTEN_DB_6` (*C++ enumerator*), 787

`adc_bitwidth_t` (*C++ enum*), 787

`adc_bitwidth_t::ADC_BITWIDTH_10` (*C++ enumerator*), 787

`adc_bitwidth_t::ADC_BITWIDTH_11` (*C++ enumerator*), 787

`adc_bitwidth_t::ADC_BITWIDTH_12` (*C++ enumerator*), 787

`adc_bitwidth_t::ADC_BITWIDTH_13` (*C++ enumerator*), 787

`adc_bitwidth_t::ADC_BITWIDTH_9` (*C++ enumerator*), 787

`adc_bitwidth_t::ADC_BITWIDTH_DEFAULT`  
(*C++ enumerator*), 787

`adc_cali_check_scheme` (*C++ function*), 803

`adc_cali_handle_t` (*C++ type*), 803

`adc_cali_raw_to_voltage` (*C++ function*), 803

`adc_cali_scheme_ver_t` (*C++ enum*), 803

`adc_cali_scheme_ver_t::ADC_CALI_SCHEME_VER_CURVE`  
(*C++ enumerator*), 803

`adc_cali_scheme_ver_t::ADC_CALI_SCHEME_VER_LINE_F`  
(*C++ enumerator*), 803

`adc_channel_t` (*C++ enum*), 786

`adc_channel_t::ADC_CHANNEL_0` (*C++ enumerator*), 786

`adc_channel_t::ADC_CHANNEL_1` (*C++ enumerator*), 786

`adc_channel_t::ADC_CHANNEL_2` (*C++ enumerator*), 786

`adc_channel_t::ADC_CHANNEL_3` (*C++ enumerator*), 786

`adc_channel_t::ADC_CHANNEL_4` (*C++ enumerator*), 786

`adc_channel_t::ADC_CHANNEL_5` (*C++ enumerator*), 786

`adc_channel_t::ADC_CHANNEL_6` (*C++ enumerator*), 786

`adc_channel_t::ADC_CHANNEL_7` (*C++ enumerator*), 786

`adc_channel_t::ADC_CHANNEL_8` (*C++ enumerator*), 786

`adc_channel_t::ADC_CHANNEL_9` (*C++ enumerator*), 786

`adc_continuous_callback_t` (*C++ type*), 800

`adc_continuous_channel_to_io` (*C++ function*), 799

`adc_continuous_clk_src_t` (*C++ type*), 786

`adc_continuous_config` (*C++ function*), 797

`adc_continuous_config_t` (*C++ struct*), 799

`adc_continuous_config_t::adc_pattern`  
(*C++ member*), 799

`adc_continuous_config_t::conv_mode`  
(*C++ member*), 799

`adc_continuous_config_t::format` (*C++ member*), 800

`adc_continuous_config_t::pattern_num`  
(*C++ member*), 799

`adc_continuous_config_t::sample_freq_hz`  
(*C++ member*), 799

`adc_continuous_deinit` (*C++ function*), 798

`adc_continuous_evt_cbs_t` (*C++ struct*), 800

`adc_continuous_evt_cbs_t::on_conv_done`



- (C++ member), 800
- adc\_continuous\_evt\_cbs\_t::on\_pool\_ovf (C++ member), 800
- adc\_continuous\_evt\_data\_t (C++ struct), 800
- adc\_continuous\_evt\_data\_t::conv\_frame\_buffer (C++ member), 800
- adc\_continuous\_evt\_data\_t::size (C++ member), 800
- adc\_continuous\_flush\_pool (C++ function), 798
- adc\_continuous\_handle\_cfg\_t (C++ struct), 799
- adc\_continuous\_handle\_cfg\_t::conv\_frame\_size (C++ member), 799
- adc\_continuous\_handle\_cfg\_t::flags (C++ member), 799
- adc\_continuous\_handle\_cfg\_t::flush\_pool (C++ member), 799
- adc\_continuous\_handle\_cfg\_t::max\_store\_buf\_size (C++ member), 799
- adc\_continuous\_handle\_t (C++ type), 800
- adc\_continuous\_io\_to\_channel (C++ function), 798
- adc\_continuous\_new\_handle (C++ function), 797
- adc\_continuous\_read (C++ function), 798
- adc\_continuous\_register\_event\_callbacks (C++ function), 797
- adc\_continuous\_start (C++ function), 797
- adc\_continuous\_stop (C++ function), 798
- adc\_digi\_convert\_mode\_t (C++ enum), 788
- adc\_digi\_convert\_mode\_t::ADC\_CONV\_ALTERNATE\_UNIT (C++ enumerator), 788
- adc\_digi\_convert\_mode\_t::ADC\_CONV\_BOTH\_UNIT (C++ enumerator), 788
- adc\_digi\_convert\_mode\_t::ADC\_CONV\_SINGLE\_UNIT (C++ enumerator), 788
- adc\_digi\_convert\_mode\_t::ADC\_CONV\_SINGLE\_UNIT\_2 (C++ enumerator), 788
- adc\_digi\_iir\_filter\_coeff\_t (C++ enum), 788
- adc\_digi\_iir\_filter\_coeff\_t::ADC\_DIGI\_IIR\_FILTER\_COEFF\_1 (C++ enumerator), 789
- adc\_digi\_iir\_filter\_coeff\_t::ADC\_DIGI\_IIR\_FILTER\_COEFF\_2 (C++ enumerator), 788
- adc\_digi\_iir\_filter\_coeff\_t::ADC\_DIGI\_IIR\_FILTER\_COEFF\_4 (C++ enumerator), 788
- adc\_digi\_iir\_filter\_coeff\_t::ADC\_DIGI\_IIR\_FILTER\_COEFF\_64 (C++ enumerator), 789
- adc\_digi\_iir\_filter\_coeff\_t::ADC\_DIGI\_IIR\_FILTER\_COEFF\_8 (C++ enumerator), 789
- adc\_digi\_iir\_filter\_t (C++ enum), 788
- adc\_digi\_iir\_filter\_t::ADC\_DIGI\_IIR\_FILTER\_0 (C++ enumerator), 788
- adc\_digi\_iir\_filter\_t::ADC\_DIGI\_IIR\_FILTER\_1 (C++ enumerator), 788
- adc\_digi\_output\_data\_t (C++ struct), 785
- adc\_digi\_output\_data\_t::channel (C++ member), 785
- adc\_digi\_output\_data\_t::data (C++ member), 785
- adc\_digi\_output\_data\_t::reserved12 (C++ member), 785
- adc\_digi\_output\_data\_t::reserved17\_31 (C++ member), 785
- adc\_digi\_output\_data\_t::type2 (C++ member), 785
- adc\_digi\_output\_data\_t::val (C++ member), 785
- adc\_digi\_output\_format\_t (C++ enum), 788
- adc\_digi\_output\_format\_t::ADC\_DIGI\_OUTPUT\_FORMAT\_0 (C++ enumerator), 788
- adc\_digi\_output\_format\_t::ADC\_DIGI\_OUTPUT\_FORMAT\_1 (C++ enumerator), 788
- adc\_digi\_pattern\_config\_t (C++ struct), 785
- adc\_digi\_pattern\_config\_t::atten (C++ member), 785
- adc\_digi\_pattern\_config\_t::bit\_width (C++ member), 785
- adc\_digi\_pattern\_config\_t::channel (C++ member), 785
- adc\_digi\_pattern\_config\_t::unit (C++ member), 785
- ADC\_MAX\_DELAY (C macro), 800
- adc\_monitor\_id\_t (C++ enum), 789
- adc\_monitor\_id\_t::ADC\_MONITOR\_0 (C++ enumerator), 789
- adc\_monitor\_id\_t::ADC\_MONITOR\_1 (C++ enumerator), 789
- adc\_monitor\_mode\_t (C++ enum), 789
- adc\_monitor\_mode\_t::ADC\_MONITOR\_MODE\_HIGH (C++ enumerator), 789
- adc\_monitor\_mode\_t::ADC\_MONITOR\_MODE\_LOW (C++ enumerator), 789
- adc\_oneshot\_chan\_cfg\_t (C++ struct), 792
- adc\_oneshot\_chan\_cfg\_t::atten (C++ member), 792
- adc\_oneshot\_chan\_cfg\_t::bitwidth (C++ member), 792
- adc\_oneshot\_chan\_cfg\_t::calibrated\_result (C++ member), 791
- adc\_oneshot\_chan\_cfg\_t::channel (C++ member), 791
- adc\_oneshot\_new\_unit (C++ function), 789
- adc\_oneshot\_read (C++ function), 790
- adc\_oneshot\_unit\_handle\_t (C++ type), 792
- adc\_oneshot\_unit\_init\_cfg\_t (C++ struct), 791
- adc\_oneshot\_unit\_init\_cfg\_t::clk\_src (C++ member), 791

- adc\_oneshot\_unit\_init\_cfg\_t::ulp\_mode (C++ member), 792  
 adc\_oneshot\_unit\_init\_cfg\_t::unit\_id (C++ member), 791  
 adc\_ulp\_mode\_t (C++ enum), 787  
 adc\_ulp\_mode\_t::ADC\_ULP\_MODE\_DISABLE (C++ enumerator), 787  
 adc\_ulp\_mode\_t::ADC\_ULP\_MODE\_FSM (C++ enumerator), 787  
 adc\_ulp\_mode\_t::ADC\_ULP\_MODE\_RISCV (C++ enumerator), 788  
 adc\_unit\_t (C++ enum), 786  
 adc\_unit\_t::ADC\_UNIT\_1 (C++ enumerator), 786  
 adc\_unit\_t::ADC\_UNIT\_2 (C++ enumerator), 786  
 ADD\_DEV\_FLUSHABLE\_DEV\_FLAG (C macro), 362  
 ADD\_DEV\_RM\_AFTER\_PROV\_FLAG (C macro), 361  
 ADD\_DEV\_START\_PROV\_NOW\_FLAG (C macro), 362  
 ana\_cmpr\_channel\_type\_t (C++ enum), 812  
 ana\_cmpr\_channel\_type\_t::ANA\_CMPR\_EXT\_REF\_CHAN (C++ enumerator), 813  
 ana\_cmpr\_channel\_type\_t::ANA\_CMPR\_SOURCE\_CHAN (C++ enumerator), 812  
 ana\_cmpr\_clk\_src\_t (C++ type), 812  
 ana\_cmpr\_config\_t (C++ struct), 810  
 ana\_cmpr\_config\_t::clk\_src (C++ member), 810  
 ana\_cmpr\_config\_t::cross\_type (C++ member), 810  
 ana\_cmpr\_config\_t::flags (C++ member), 810  
 ana\_cmpr\_config\_t::intr\_priority (C++ member), 810  
 ana\_cmpr\_config\_t::io\_loop\_back (C++ member), 810  
 ana\_cmpr\_config\_t::ref\_src (C++ member), 810  
 ana\_cmpr\_config\_t::unit (C++ member), 810  
 ana\_cmpr\_cross\_cb\_t (C++ type), 812  
 ana\_cmpr\_cross\_event\_data\_t (C++ struct), 811  
 ana\_cmpr\_cross\_event\_data\_t::cross\_type (C++ member), 811  
 ana\_cmpr\_cross\_type\_t (C++ enum), 813  
 ana\_cmpr\_cross\_type\_t::ANA\_CMPR\_CROSS\_ANY (C++ enumerator), 813  
 ana\_cmpr\_cross\_type\_t::ANA\_CMPR\_CROSS\_DISABLE (C++ member), 2065  
 ana\_cmpr\_cross\_type\_t::ANA\_CMPR\_CROSS\_NEG (C++ enumerator), 813  
 ana\_cmpr\_cross\_type\_t::ANA\_CMPR\_CROSS\_POS (C++ enumerator), 813  
 ana\_cmpr\_debounce\_config\_t (C++ struct), 810  
 ana\_cmpr\_debounce\_config\_t::wait\_us (C++ member), 811  
 ana\_cmpr\_del\_unit (C++ function), 808  
 ana\_cmpr\_disable (C++ function), 809  
 ana\_cmpr\_enable (C++ function), 809  
 ana\_cmpr\_event\_callbacks\_t (C++ struct), 811  
 ana\_cmpr\_event\_callbacks\_t::on\_cross (C++ member), 811  
 ana\_cmpr\_get\_gpio (C++ function), 809  
 ana\_cmpr\_handle\_t (C++ type), 812  
 ana\_cmpr\_internal\_ref\_config\_t (C++ struct), 810  
 ana\_cmpr\_internal\_ref\_config\_t::ref\_volt (C++ member), 810  
 ana\_cmpr\_new\_unit (C++ function), 807  
 ana\_cmpr\_ref\_source\_t (C++ enum), 812  
 ana\_cmpr\_ref\_source\_t::ANA\_CMPR\_REF\_SRC\_EXTERNAL (C++ enumerator), 812  
 ana\_cmpr\_ref\_source\_t::ANA\_CMPR\_REF\_SRC\_INTERNAL (C++ enumerator), 812  
 ana\_cmpr\_ref\_voltage\_t (C++ enum), 813  
 ana\_cmpr\_ref\_voltage\_t::ANA\_CMPR\_REF\_VOLT\_0\_PCT\_V (C++ enumerator), 813  
 ana\_cmpr\_ref\_voltage\_t::ANA\_CMPR\_REF\_VOLT\_10\_PCT\_V (C++ enumerator), 813  
 ana\_cmpr\_ref\_voltage\_t::ANA\_CMPR\_REF\_VOLT\_20\_PCT\_V (C++ enumerator), 813  
 ana\_cmpr\_ref\_voltage\_t::ANA\_CMPR\_REF\_VOLT\_30\_PCT\_V (C++ enumerator), 813  
 ana\_cmpr\_ref\_voltage\_t::ANA\_CMPR\_REF\_VOLT\_40\_PCT\_V (C++ enumerator), 813  
 ana\_cmpr\_ref\_voltage\_t::ANA\_CMPR\_REF\_VOLT\_50\_PCT\_V (C++ enumerator), 813  
 ana\_cmpr\_ref\_voltage\_t::ANA\_CMPR\_REF\_VOLT\_60\_PCT\_V (C++ enumerator), 813  
 ana\_cmpr\_ref\_voltage\_t::ANA\_CMPR\_REF\_VOLT\_70\_PCT\_V (C++ enumerator), 813  
 ana\_cmpr\_register\_event\_callbacks (C++ function), 809  
 ana\_cmpr\_set\_cross\_type (C++ function), 808  
 ana\_cmpr\_set\_debounce (C++ function), 808  
 ana\_cmpr\_set\_internal\_reference (C++ function), 808  
 ANA\_CMPR\_UNIT\_0 (C macro), 812  
 ana\_cmpr\_unit\_t (C++ type), 812  
 async\_memcpy\_config\_t (C++ struct), 2065  
 async\_memcpy\_config\_t::backlog (C++ member), 2065  
 async\_memcpy\_config\_t::dma\_burst\_size (C++ member), 2065  
 async\_memcpy\_config\_t::flags (C++ member), 2065  
 async\_memcpy\_config\_t::psram\_trans\_align (C++ member), 2065  
 async\_memcpy\_config\_t::sram\_trans\_align (C++ member), 2065  
 ASYNC\_MEMCPY\_DEFAULT\_CONFIG (C macro), 2066  
 async\_memcpy\_etm\_event\_t (C++ enum), 2066

async\_memcpy\_etm\_event\_t::ASYNC\_MEMCPY\_EVENT\_STOP (C macro), 305  
(C++ enumerator), 2066

async\_memcpy\_event\_t (C++ struct), 2065

async\_memcpy\_event\_t::data (C++ member), 2065

async\_memcpy\_handle\_t (C++ type), 2066

async\_memcpy\_isr\_cb\_t (C++ type), 2066

## B

BD\_ADDR (C++ type), 381

BD\_ADDR\_LEN (C macro), 360

BLE\_ADDR\_LEN (C macro), 1607

BLE\_BIT (C macro), 226

BLE\_DTM\_PKT\_PAYLOAD\_0x00 (C macro), 225

BLE\_DTM\_PKT\_PAYLOAD\_0x01 (C macro), 225

BLE\_DTM\_PKT\_PAYLOAD\_0x02 (C macro), 225

BLE\_DTM\_PKT\_PAYLOAD\_0x03 (C macro), 225

BLE\_DTM\_PKT\_PAYLOAD\_0x04 (C macro), 225

BLE\_DTM\_PKT\_PAYLOAD\_0x05 (C macro), 225

BLE\_DTM\_PKT\_PAYLOAD\_0x06 (C macro), 225

BLE\_DTM\_PKT\_PAYLOAD\_0x07 (C macro), 225

BLE\_DTM\_PKT\_PAYLOAD\_MAX (C macro), 226

BLE\_HCI\_UART\_H4\_ACL (C macro), 691

BLE\_HCI\_UART\_H4\_CMD (C macro), 691

BLE\_HCI\_UART\_H4\_EVT (C macro), 691

BLE\_HCI\_UART\_H4\_NONE (C macro), 691

BLE\_HCI\_UART\_H4\_SCO (C macro), 691

BLE\_UUID128\_VAL\_LENGTH (C macro), 1607

bootloader\_fill\_random (C++ function), 2023

bootloader\_random\_disable (C++ function), 2023

bootloader\_random\_enable (C++ function), 2023

bridgeif\_config (C++ struct), 768

bridgeif\_config::max\_fdb\_dyn\_entries (C++ member), 768

bridgeif\_config::max\_fdb\_sta\_entries (C++ member), 768

bridgeif\_config::max\_ports (C++ member), 768

bridgeif\_config\_t (C++ type), 771

BT\_BLUEDROID\_INIT\_CONFIG\_DEFAULT (C macro), 165

BT\_CONTROLLER\_INIT\_CONFIG\_DEFAULT (C macro), 305

BT\_OCTET32 (C++ type), 381

BT\_OCTET32\_LEN (C macro), 360

## C

CHIP\_FEATURE\_BLE (C macro), 1989

CHIP\_FEATURE\_BT (C macro), 1989

CHIP\_FEATURE\_EMB\_FLASH (C macro), 1989

CHIP\_FEATURE\_EMB\_PSRAM (C macro), 1989

CHIP\_FEATURE\_IEEE802154 (C macro), 1989

CHIP\_FEATURE\_WIFI\_BGN (C macro), 1989

CONFIG\_HEAP\_TRACING\_STACK\_DEPTH (C macro), 1957

CONFIG\_MAGIC (C macro), 305

## D

dedic\_gpio\_bundle\_config\_t (C++ struct), 877

dedic\_gpio\_bundle\_config\_t::array\_size (C++ member), 878

dedic\_gpio\_bundle\_config\_t::flags (C++ member), 878

dedic\_gpio\_bundle\_config\_t::gpio\_array (C++ member), 877

dedic\_gpio\_bundle\_config\_t::in\_en (C++ member), 878

dedic\_gpio\_bundle\_config\_t::in\_invert (C++ member), 878

dedic\_gpio\_bundle\_config\_t::out\_en (C++ member), 878

dedic\_gpio\_bundle\_config\_t::out\_invert (C++ member), 878

dedic\_gpio\_bundle\_handle\_t (C++ type), 878

dedic\_gpio\_bundle\_read\_in (C++ function), 877

dedic\_gpio\_bundle\_read\_out (C++ function), 877

dedic\_gpio\_bundle\_write (C++ function), 877

dedic\_gpio\_del\_bundle (C++ function), 877

dedic\_gpio\_get\_in\_mask (C++ function), 876

dedic\_gpio\_get\_in\_offset (C++ function), 876

dedic\_gpio\_get\_out\_mask (C++ function), 876

dedic\_gpio\_get\_out\_offset (C++ function), 876

dedic\_gpio\_new\_bundle (C++ function), 876

DEFAULT\_HTTP\_BUF\_SIZE (C macro), 85

DEL\_DEV\_ADDR\_FLAG (C macro), 362

DEL\_DEV\_UUID\_FLAG (C macro), 362

## E

EFD\_SUPPORT\_ISR (C macro), 1695

efuse\_hal\_blk\_version (C++ function), 1716

efuse\_hal\_chip\_revision (C++ function), 1716

efuse\_hal\_flash\_encryption\_enabled (C++ function), 1717

efuse\_hal\_get\_disable\_wafer\_version\_major (C++ function), 1717

efuse\_hal\_get\_mac (C++ function), 1716

efuse\_hal\_get\_major\_chip\_version (C++ function), 1717

efuse\_hal\_get\_minor\_chip\_version (C++ function), 1717

efuse\_hal\_set\_ecdsa\_key (C++ function), 1717

eNotifyAction (C++ enum), 1819

eNotifyAction::eIncrement (C++ enumerator), 1819

eNotifyAction::eNoAction (C++ enumerator), 1819

- eNotifyAction::eSetBits (C++ *enumerator*), 1819  
 eNotifyAction::eSetValueWithoutOverwrite (C++ *enumerator*), 1819  
 eNotifyAction::eSetValueWithOverwrite (C++ *enumerator*), 1819  
 eSleepModeStatus (C++ *enum*), 1820  
 eSleepModeStatus::eAbortSleep (C++ *enumerator*), 1820  
 eSleepModeStatus::eStandardSleep (C++ *enumerator*), 1820  
 esp\_alloc\_failed\_hook\_t (C++ *type*), 1934  
 ESP\_APP\_DESC\_MAGIC\_WORD (C *macro*), 1997  
 esp\_app\_desc\_t (C++ *struct*), 1996  
 esp\_app\_desc\_t::app\_elf\_sha256 (C++ *member*), 1996  
 esp\_app\_desc\_t::date (C++ *member*), 1996  
 esp\_app\_desc\_t::idf\_ver (C++ *member*), 1996  
 esp\_app\_desc\_t::magic\_word (C++ *member*), 1996  
 esp\_app\_desc\_t::project\_name (C++ *member*), 1996  
 esp\_app\_desc\_t::reserv1 (C++ *member*), 1996  
 esp\_app\_desc\_t::reserv2 (C++ *member*), 1996  
 esp\_app\_desc\_t::secure\_version (C++ *member*), 1996  
 esp\_app\_desc\_t::time (C++ *member*), 1996  
 esp\_app\_desc\_t::version (C++ *member*), 1996  
 esp\_app\_get\_description (C++ *function*), 1995  
 esp\_app\_get\_elf\_sha256 (C++ *function*), 1995  
 esp\_app\_get\_elf\_sha256\_str (C++ *function*), 1996  
 ESP\_APP\_ID\_MAX (C *macro*), 158  
 ESP\_APP\_ID\_MIN (C *macro*), 158  
 esp\_apptrace\_buffer\_get (C++ *function*), 1707  
 esp\_apptrace\_buffer\_put (C++ *function*), 1708  
 esp\_apptrace\_dest\_t (C++ *enum*), 1710  
 esp\_apptrace\_dest\_t::ESP\_APPTRACE\_DEST\_JTAG (C++ *enumerator*), 1711  
 esp\_apptrace\_dest\_t::ESP\_APPTRACE\_DEST\_MAX (C++ *enumerator*), 1711  
 esp\_apptrace\_dest\_t::ESP\_APPTRACE\_DEST\_NUM (C++ *enumerator*), 1711  
 esp\_apptrace\_dest\_t::ESP\_APPTRACE\_DEST\_SFR (C++ *enumerator*), 1711  
 esp\_apptrace\_dest\_t::ESP\_APPTRACE\_DEST\_UART (C++ *enumerator*), 1711  
 esp\_apptrace\_down\_buffer\_config (C++ *function*), 1707  
 esp\_apptrace\_down\_buffer\_get (C++ *function*), 1709  
 esp\_apptrace\_down\_buffer\_put (C++ *function*), 1709  
 esp\_apptrace\_fclose (C++ *function*), 1709  
 esp\_apptrace\_feof (C++ *function*), 1710  
 esp\_apptrace\_flush (C++ *function*), 1708  
 esp\_apptrace\_flush\_nolock (C++ *function*), 1708  
 esp\_apptrace\_fopen (C++ *function*), 1709  
 esp\_apptrace\_fread (C++ *function*), 1710  
 esp\_apptrace\_fseek (C++ *function*), 1710  
 esp\_apptrace\_fstop (C++ *function*), 1710  
 esp\_apptrace\_ftell (C++ *function*), 1710  
 esp\_apptrace\_fwrite (C++ *function*), 1710  
 esp\_apptrace\_host\_is\_connected (C++ *function*), 1709  
 esp\_apptrace\_init (C++ *function*), 1707  
 esp\_apptrace\_read (C++ *function*), 1709  
 esp\_apptrace\_vprintf (C++ *function*), 1708  
 esp\_apptrace\_vprintf\_to (C++ *function*), 1708  
 esp\_apptrace\_write (C++ *function*), 1708  
 esp\_async\_memcpy (C++ *function*), 2064  
 esp\_async\_memcpy\_install (C++ *function*), 2064  
 esp\_async\_memcpy\_install\_gdma\_ahb (C++ *function*), 2063  
 esp\_async\_memcpy\_new\_etm\_event (C++ *function*), 2065  
 esp\_async\_memcpy\_uninstall (C++ *function*), 2064  
 esp\_attr\_control\_t (C++ *struct*), 246  
 esp\_attr\_control\_t::auto\_rsp (C++ *member*), 246  
 esp\_attr\_desc\_t (C++ *struct*), 246  
 esp\_attr\_desc\_t::length (C++ *member*), 246  
 esp\_attr\_desc\_t::max\_length (C++ *member*), 246  
 esp\_attr\_desc\_t::perm (C++ *member*), 246  
 esp\_attr\_desc\_t::uuid\_length (C++ *member*), 246  
 esp\_attr\_desc\_t::uuid\_p (C++ *member*), 246  
 esp\_attr\_desc\_t::value (C++ *member*), 246  
 esp\_attr\_value\_t (C++ *struct*), 247  
 esp\_attr\_value\_t::attr\_len (C++ *member*), 247  
 esp\_attr\_value\_t::attr\_max\_len (C++ *member*), 247  
 esp\_attr\_value\_t::attr\_value (C++ *member*), 247  
 esp\_base\_mac\_addr\_get (C++ *function*), 1986  
 esp\_base\_mac\_addr\_set (C++ *function*), 1986  
 ESP\_BD\_ADDR\_HEX (C *macro*), 158  
 ESP\_BD\_ADDR\_LEN (C *macro*), 158  
 ESP\_BD\_ADDR\_STR (C *macro*), 158  
 esp\_bd\_addr\_t (C++ *type*), 159  
 esp\_ble\_addr\_t (C++ *struct*), 301  
 esp\_ble\_addr\_t::type (C++ *member*), 301  
 esp\_ble\_addr\_t::val (C++ *member*), 301

- esp\_ble\_addr\_type\_t (C++ enum), 163  
 esp\_ble\_addr\_type\_t::BLE\_ADDR\_TYPE\_PUBLIC (C++ enumerator), 163  
 esp\_ble\_addr\_type\_t::BLE\_ADDR\_TYPE\_RANDOM (C++ enumerator), 163  
 esp\_ble\_addr\_type\_t::BLE\_ADDR\_TYPE\_RPA\_PUBLIC (C++ enumerator), 163  
 esp\_ble\_addr\_type\_t::BLE\_ADDR\_TYPE\_RPA\_RANDOM (C++ enumerator), 163  
 esp\_ble\_adv\_channel\_t (C++ enum), 237  
 esp\_ble\_adv\_channel\_t::ADV\_CHNL\_37 (C++ enumerator), 237  
 esp\_ble\_adv\_channel\_t::ADV\_CHNL\_38 (C++ enumerator), 237  
 esp\_ble\_adv\_channel\_t::ADV\_CHNL\_39 (C++ enumerator), 237  
 esp\_ble\_adv\_channel\_t::ADV\_CHNL\_ALL (C++ enumerator), 237  
 ESP\_BLE\_ADV\_DATA\_LEN\_MAX (C macro), 226  
 esp\_ble\_adv\_data\_t (C++ struct), 206  
 esp\_ble\_adv\_data\_t::appearance (C++ member), 206  
 esp\_ble\_adv\_data\_t::flag (C++ member), 207  
 esp\_ble\_adv\_data\_t::include\_name (C++ member), 206  
 esp\_ble\_adv\_data\_t::include\_txpower (C++ member), 206  
 esp\_ble\_adv\_data\_t::manufacturer\_len (C++ member), 206  
 esp\_ble\_adv\_data\_t::max\_interval (C++ member), 206  
 esp\_ble\_adv\_data\_t::min\_interval (C++ member), 206  
 esp\_ble\_adv\_data\_t::p\_manufacturer\_data (C++ member), 206  
 esp\_ble\_adv\_data\_t::p\_service\_data (C++ member), 206  
 esp\_ble\_adv\_data\_t::p\_service\_uuid (C++ member), 206  
 esp\_ble\_adv\_data\_t::service\_data\_len (C++ member), 206  
 esp\_ble\_adv\_data\_t::service\_uuid\_len (C++ member), 206  
 esp\_ble\_adv\_data\_t::set\_scan\_rsp (C++ member), 206  
 esp\_ble\_adv\_data\_type (C++ enum), 235  
 esp\_ble\_adv\_data\_type::ESP\_BLE\_AD\_MANUFACTURER\_SPECIFIC (C++ enumerator), 237  
 esp\_ble\_adv\_data\_type::ESP\_BLE\_AD\_TYPE\_16SRV\_PART (C++ enumerator), 235  
 esp\_ble\_adv\_data\_type::ESP\_BLE\_AD\_TYPE\_16SRV\_COMPLETE (C++ enumerator), 235  
 esp\_ble\_adv\_data\_type::ESP\_BLE\_AD\_TYPE\_32SERVICE\_DATA (C++ enumerator), 236  
 esp\_ble\_adv\_data\_type::ESP\_BLE\_AD\_TYPE\_32SOL\_SRV\_UUID (C++ enumerator), 236  
 esp\_ble\_adv\_data\_type::ESP\_BLE\_AD\_TYPE\_32SOL\_SRV\_UUID\_2 (C++ enumerator), 236  
 esp\_ble\_adv\_data\_type::ESP\_BLE\_AD\_TYPE\_32SRV\_CMPL (C++ enumerator), 235  
 esp\_ble\_adv\_data\_type::ESP\_BLE\_AD\_TYPE\_32SRV\_PART (C++ enumerator), 235  
 esp\_ble\_adv\_data\_type::ESP\_BLE\_AD\_TYPE\_ADV\_INT (C++ enumerator), 236  
 esp\_ble\_adv\_data\_type::ESP\_BLE\_AD\_TYPE\_APPEARANCE (C++ enumerator), 236  
 esp\_ble\_adv\_data\_type::ESP\_BLE\_AD\_TYPE\_CHAN\_MAP\_U (C++ enumerator), 237  
 esp\_ble\_adv\_data\_type::ESP\_BLE\_AD\_TYPE\_DEV\_CLASS (C++ enumerator), 236  
 esp\_ble\_adv\_data\_type::ESP\_BLE\_AD\_TYPE\_FLAG (C++ enumerator), 235  
 esp\_ble\_adv\_data\_type::ESP\_BLE\_AD\_TYPE\_INDOOR\_POS (C++ enumerator), 237  
 esp\_ble\_adv\_data\_type::ESP\_BLE\_AD\_TYPE\_INT\_RANGE (C++ enumerator), 236  
 esp\_ble\_adv\_data\_type::ESP\_BLE\_AD\_TYPE\_LE\_DEV\_ADD (C++ enumerator), 236  
 esp\_ble\_adv\_data\_type::ESP\_BLE\_AD\_TYPE\_LE\_ROLE (C++ enumerator), 236  
 esp\_ble\_adv\_data\_type::ESP\_BLE\_AD\_TYPE\_LE\_SECURE (C++ enumerator), 236  
 esp\_ble\_adv\_data\_type::ESP\_BLE\_AD\_TYPE\_LE\_SECURE (C++ enumerator), 236  
 esp\_ble\_adv\_data\_type::ESP\_BLE\_AD\_TYPE\_LE\_SUPPORT (C++ enumerator), 237  
 esp\_ble\_adv\_data\_type::ESP\_BLE\_AD\_TYPE\_NAME\_CMPL (C++ enumerator), 236  
 esp\_ble\_adv\_data\_type::ESP\_BLE\_AD\_TYPE\_NAME\_SHORT (C++ enumerator), 235  
 esp\_ble\_adv\_data\_type::ESP\_BLE\_AD\_TYPE\_PUBLIC\_TAR (C++ enumerator), 236  
 esp\_ble\_adv\_data\_type::ESP\_BLE\_AD\_TYPE\_RANDOM\_TAR (C++ enumerator), 236  
 esp\_ble\_adv\_data\_type::ESP\_BLE\_AD\_TYPE\_SERVICE\_DA (C++ enumerator), 236  
 esp\_ble\_adv\_data\_type::ESP\_BLE\_AD\_TYPE\_SM\_OOB\_FL (C++ enumerator), 236  
 esp\_ble\_adv\_data\_type::ESP\_BLE\_AD\_TYPE\_SM\_TK (C++ enumerator), 236  
 esp\_ble\_adv\_data\_type::ESP\_BLE\_AD\_TYPE\_SOL\_SRV\_UUID (C++ enumerator), 236  
 esp\_ble\_adv\_data\_type::ESP\_BLE\_AD\_TYPE\_SPAIR\_C256 (C++ enumerator), 236  
 esp\_ble\_adv\_data\_type::ESP\_BLE\_AD\_TYPE\_SPAIR\_R256 (C++ enumerator), 236  
 esp\_ble\_adv\_data\_type::ESP\_BLE\_AD\_TYPE\_TRANS\_DISC (C++ enumerator), 237  
 esp\_ble\_adv\_data\_type::ESP\_BLE\_AD\_TYPE\_TX\_PWR (C++ enumerator), 236





- (*C macro*), 222
- ESP\_BLE\_APPEARANCE\_GENERIC\_WALKING (*C macro*), 223
- ESP\_BLE\_APPEARANCE\_GENERIC\_WATCH (*C macro*), 221
- ESP\_BLE\_APPEARANCE\_GENERIC\_WEIGHT (*C macro*), 224
- ESP\_BLE\_APPEARANCE\_HEART\_RATE\_BELT (*C macro*), 222
- ESP\_BLE\_APPEARANCE\_HID\_BARCODE\_SCANNER (*C macro*), 223
- ESP\_BLE\_APPEARANCE\_HID\_CARD\_READER (*C macro*), 223
- ESP\_BLE\_APPEARANCE\_HID\_DIGITAL\_PEN (*C macro*), 223
- ESP\_BLE\_APPEARANCE\_HID\_DIGITIZER\_TABLET (*C macro*), 223
- ESP\_BLE\_APPEARANCE\_HID\_GAMEPAD (*C macro*), 223
- ESP\_BLE\_APPEARANCE\_HID\_JOYSTICK (*C macro*), 223
- ESP\_BLE\_APPEARANCE\_HID\_KEYBOARD (*C macro*), 223
- ESP\_BLE\_APPEARANCE\_HID\_MOUSE (*C macro*), 223
- ESP\_BLE\_APPEARANCE\_INSULIN\_PEN (*C macro*), 225
- ESP\_BLE\_APPEARANCE\_INSULIN\_PUMP\_DURABLE\_PUMP (*C macro*), 224
- ESP\_BLE\_APPEARANCE\_INSULIN\_PUMP\_PATCH\_PUMP (*C macro*), 224
- ESP\_BLE\_APPEARANCE\_MOBILITY\_SCOOTER (*C macro*), 224
- ESP\_BLE\_APPEARANCE\_OUTDOOR\_SPORTS\_LOCATION (*C macro*), 225
- ESP\_BLE\_APPEARANCE\_OUTDOOR\_SPORTS\_LOCATION\_AND\_CNA (*C macro*), 225
- ESP\_BLE\_APPEARANCE\_OUTDOOR\_SPORTS\_LOCATION\_POSITION (*C macro*), 225
- ESP\_BLE\_APPEARANCE\_OUTDOOR\_SPORTS\_LOCATION\_POSITION\_AND\_CNA (*C macro*), 225
- ESP\_BLE\_APPEARANCE\_POWERED\_WHEELCHAIR (*C macro*), 224
- ESP\_BLE\_APPEARANCE\_PULSE\_OXIMETER\_FINGERTIP (*C macro*), 224
- ESP\_BLE\_APPEARANCE\_PULSE\_OXIMETER\_WRIST (*C macro*), 224
- ESP\_BLE\_APPEARANCE\_SPORTS\_WATCH (*C macro*), 222
- ESP\_BLE\_APPEARANCE\_STANDALONE\_SPEAKER (*C macro*), 224
- ESP\_BLE\_APPEARANCE\_THERMOMETER\_EAR (*C macro*), 222
- ESP\_BLE\_APPEARANCE\_UNKNOWN (*C macro*), 221
- ESP\_BLE\_APPEARANCE\_WALKING\_IN\_SHOE (*C macro*), 223
- ESP\_BLE\_APPEARANCE\_WALKING\_ON\_HIP (*C macro*), 223
- ESP\_BLE\_APPEARANCE\_WALKING\_ON\_SHOE (*C macro*), 223
- esp\_ble\_auth\_cmpl\_t (*C++ struct*), 212
- esp\_ble\_auth\_cmpl\_t::addr\_type (*C++ member*), 212
- esp\_ble\_auth\_cmpl\_t::auth\_mode (*C++ member*), 212
- esp\_ble\_auth\_cmpl\_t::bd\_addr (*C++ member*), 212
- esp\_ble\_auth\_cmpl\_t::dev\_type (*C++ member*), 212
- esp\_ble\_auth\_cmpl\_t::fail\_reason (*C++ member*), 212
- esp\_ble\_auth\_cmpl\_t::key (*C++ member*), 212
- esp\_ble\_auth\_cmpl\_t::key\_present (*C++ member*), 212
- esp\_ble\_auth\_cmpl\_t::key\_type (*C++ member*), 212
- esp\_ble\_auth\_cmpl\_t::success (*C++ member*), 212
- esp\_ble\_auth\_fail\_rsn\_t (*C++ enum*), 240
- esp\_ble\_auth\_fail\_rsn\_t::ESP\_AUTH\_SMP\_BR\_PARING\_I (*C++ enumerator*), 241
- esp\_ble\_auth\_fail\_rsn\_t::ESP\_AUTH\_SMP\_BUSY (*C++ enumerator*), 241
- esp\_ble\_auth\_fail\_rsn\_t::ESP\_AUTH\_SMP\_CONFIRM\_FAI (*C++ enumerator*), 241
- esp\_ble\_auth\_fail\_rsn\_t::ESP\_AUTH\_SMP\_CONFIRM\_VAL (*C++ enumerator*), 241
- esp\_ble\_auth\_fail\_rsn\_t::ESP\_AUTH\_SMP\_CONN\_TOUT (*C++ enumerator*), 242
- esp\_ble\_auth\_fail\_rsn\_t::ESP\_AUTH\_SMP\_DHKEY\_CHK\_F (*C++ enumerator*), 241
- esp\_ble\_auth\_fail\_rsn\_t::ESP\_AUTH\_SMP\_DIV\_NOT\_AVA (*C++ enumerator*), 242
- esp\_ble\_auth\_fail\_rsn\_t::ESP\_AUTH\_SMP\_ENC\_FAIL (*C++ enumerator*), 241
- esp\_ble\_auth\_fail\_rsn\_t::ESP\_AUTH\_SMP\_ENC\_KEY\_SIZ (*C++ enumerator*), 241
- esp\_ble\_auth\_fail\_rsn\_t::ESP\_AUTH\_SMP\_INIT\_FAIL (*C++ enumerator*), 241
- esp\_ble\_auth\_fail\_rsn\_t::ESP\_AUTH\_SMP\_INTERNAL\_ER (*C++ enumerator*), 241
- esp\_ble\_auth\_fail\_rsn\_t::ESP\_AUTH\_SMP\_INVALID\_CMD (*C++ enumerator*), 241
- esp\_ble\_auth\_fail\_rsn\_t::ESP\_AUTH\_SMP\_INVALID\_PAR (*C++ enumerator*), 241
- esp\_ble\_auth\_fail\_rsn\_t::ESP\_AUTH\_SMP\_NUM\_COMP\_FA (*C++ enumerator*), 241
- esp\_ble\_auth\_fail\_rsn\_t::ESP\_AUTH\_SMP\_OOB\_FAIL (*C++ enumerator*), 240
- esp\_ble\_auth\_fail\_rsn\_t::ESP\_AUTH\_SMP\_PAIR\_AUTH\_F (*C++ enumerator*), 240
- esp\_ble\_auth\_fail\_rsn\_t::ESP\_AUTH\_SMP\_PAIR\_NOT\_SU (*C++ enumerator*), 241
- esp\_ble\_auth\_fail\_rsn\_t::ESP\_AUTH\_SMP\_PASSKEY\_FAI (*C++ enumerator*), 240

- esp\_ble\_auth\_fail\_rsn\_t::ESP\_AUTH\_SMP\_REPEATED\_MEMBER (C++ enumerator), 241  
 esp\_ble\_auth\_fail\_rsn\_t::ESP\_AUTH\_SMP\_RSP\_TIMEOUT (C++ enumerator), 242  
 esp\_ble\_auth\_fail\_rsn\_t::ESP\_AUTH\_SMP\_STARTLE (C++ enumerator), 242  
 esp\_ble\_auth\_fail\_rsn\_t::ESP\_AUTH\_SMP\_UNKNOWN\_ERR (C++ enumerator), 241  
 esp\_ble\_auth\_fail\_rsn\_t::ESP\_AUTH\_SMP\_UNKNOWN\_ID (C++ enumerator), 241  
 esp\_ble\_auth\_fail\_rsn\_t::ESP\_AUTH\_SMP\_UNEXPECTED\_ERR (C++ enumerator), 242  
 esp\_ble\_auth\_fail\_rsn\_t::ESP\_AUTH\_SMP\_UNSUPPORTED\_TRANS\_DEFIVE\_NOT\_ALLOWED (C++ enumerator), 241  
 esp\_ble\_auth\_req\_t (C++ type), 229  
 esp\_ble\_bond\_dev\_t (C++ struct), 211  
 esp\_ble\_bond\_dev\_t::bd\_addr (C++ member), 211  
 esp\_ble\_bond\_dev\_t::bond\_key (C++ member), 211  
 esp\_ble\_bond\_key\_info\_t (C++ struct), 210  
 esp\_ble\_bond\_key\_info\_t::key\_mask (C++ member), 211  
 esp\_ble\_bond\_key\_info\_t::pcsrk\_key (C++ member), 211  
 esp\_ble\_bond\_key\_info\_t::penc\_key (C++ member), 211  
 esp\_ble\_bond\_key\_info\_t::pid\_key (C++ member), 211  
 esp\_ble\_confirm\_reply (C++ function), 175  
 ESP\_BLE\_CONN\_INT\_MAX (C macro), 157  
 ESP\_BLE\_CONN\_INT\_MIN (C macro), 157  
 ESP\_BLE\_CONN\_LATENCY\_MAX (C macro), 158  
 ESP\_BLE\_CONN\_SUP\_TOUT\_MAX (C macro), 158  
 ESP\_BLE\_CONN\_SUP\_TOUT\_MIN (C macro), 158  
 esp\_ble\_conn\_update\_params\_t (C++ struct), 208  
 esp\_ble\_conn\_update\_params\_t::bda (C++ member), 208  
 esp\_ble\_conn\_update\_params\_t::latency (C++ member), 208  
 esp\_ble\_conn\_update\_params\_t::max\_int (C++ member), 208  
 esp\_ble\_conn\_update\_params\_t::min\_int (C++ member), 208  
 esp\_ble\_conn\_update\_params\_t::timeout (C++ member), 208  
 esp\_ble\_create\_sc\_oob\_data (C++ function), 176  
 ESP\_BLE\_CSR\_KEY\_MASK (C macro), 158  
 esp\_ble\_dtm\_enh\_rx\_start (C++ function), 181  
 esp\_ble\_dtm\_enh\_rx\_t (C++ struct), 219  
 esp\_ble\_dtm\_enh\_rx\_t::modulation\_idx (C++ member), 219  
 esp\_ble\_dtm\_enh\_rx\_t::phy (C++ member), 219  
 esp\_ble\_dtm\_enh\_rx\_t::rx\_channel (C++ member), 219  
 esp\_ble\_dtm\_enh\_tx\_start (C++ function), 181  
 esp\_ble\_dtm\_enh\_tx\_t (C++ struct), 218  
 esp\_ble\_dtm\_enh\_tx\_t::len\_of\_data (C++ member), 218  
 esp\_ble\_dtm\_enh\_tx\_t::phy (C++ member), 219  
 esp\_ble\_dtm\_enh\_tx\_t::pkt\_payload (C++ member), 218  
 esp\_ble\_dtm\_enh\_tx\_t::tx\_channel (C++ member), 218  
 esp\_ble\_dtm\_rx\_start (C++ function), 181  
 esp\_ble\_dtm\_rx\_t (C++ struct), 205  
 esp\_ble\_dtm\_rx\_t::rx\_channel (C++ member), 205  
 esp\_ble\_dtm\_stop (C++ function), 182  
 esp\_ble\_dtm\_tx\_start (C++ function), 181  
 esp\_ble\_dtm\_tx\_t (C++ struct), 204  
 esp\_ble\_dtm\_tx\_t::len\_of\_data (C++ member), 205  
 esp\_ble\_dtm\_tx\_t::pkt\_payload (C++ member), 205  
 esp\_ble\_dtm\_tx\_t::tx\_channel (C++ member), 205  
 esp\_ble\_dtm\_update\_evt\_t (C++ enum), 239  
 esp\_ble\_dtm\_update\_evt\_t::DTM\_RX\_START\_EVT (C++ enumerator), 239  
 esp\_ble\_dtm\_update\_evt\_t::DTM\_TEST\_STOP\_EVT (C++ enumerator), 239  
 esp\_ble\_dtm\_update\_evt\_t::DTM\_TX\_START\_EVT (C++ enumerator), 239  
 esp\_ble\_duplicate\_exceptional\_info\_type\_t (C++ enum), 243  
 esp\_ble\_duplicate\_exceptional\_info\_type\_t::ESP\_BLE\_DUPLICATE\_EXCEPTIONAL\_INFO\_TYPE\_T\_INVALID (C++ enumerator), 243  
 esp\_ble\_duplicate\_exceptional\_info\_type\_t::ESP\_BLE\_DUPLICATE\_EXCEPTIONAL\_INFO\_TYPE\_T\_INVALID\_LEN (C++ enumerator), 243  
 esp\_ble\_duplicate\_exceptional\_info\_type\_t::ESP\_BLE\_DUPLICATE\_EXCEPTIONAL\_INFO\_TYPE\_T\_INVALID\_PARAM (C++ enumerator), 244  
 esp\_ble\_duplicate\_exceptional\_info\_type\_t::ESP\_BLE\_DUPLICATE\_EXCEPTIONAL\_INFO\_TYPE\_T\_INVALID\_PARAM\_LEN (C++ enumerator), 244  
 esp\_ble\_duplicate\_exceptional\_info\_type\_t::ESP\_BLE\_DUPLICATE\_EXCEPTIONAL\_INFO\_TYPE\_T\_INVALID\_PARAM\_LEN\_LEN (C++ enumerator), 244  
 esp\_ble\_duplicate\_exceptional\_info\_type\_t::ESP\_BLE\_DUPLICATE\_EXCEPTIONAL\_INFO\_TYPE\_T\_INVALID\_PARAM\_LEN\_LEN\_LEN (C++ enumerator), 244  
 esp\_ble\_duplicate\_exceptional\_info\_type\_t::ESP\_BLE\_DUPLICATE\_EXCEPTIONAL\_INFO\_TYPE\_T\_INVALID\_PARAM\_LEN\_LEN\_LEN\_LEN (C++ enumerator), 244  
 ESP\_BLE\_ENC\_KEY\_MASK (C macro), 158  
 esp\_ble\_enhanced\_power\_type\_t (C++ enum), 308  
 esp\_ble\_enhanced\_power\_type\_t::ESP\_BLE\_ENHANCED\_POWER\_TYPE\_T\_INVALID (C++ enumerator), 308  
 esp\_ble\_enhanced\_power\_type\_t::ESP\_BLE\_ENHANCED\_POWER\_TYPE\_T\_INVALID\_LEN (C++ enumerator), 308  
 esp\_ble\_enhanced\_power\_type\_t::ESP\_BLE\_ENHANCED\_POWER\_TYPE\_T\_INVALID\_PARAM (C++ enumerator), 308  
 esp\_ble\_enhanced\_power\_type\_t::ESP\_BLE\_ENHANCED\_POWER\_TYPE\_T\_INVALID\_PARAM\_LEN (C++ enumerator), 308



esp\_ble\_enhanced\_power\_type\_t::ESP\_BLE\_ENHANCED\_POWER\_TYPE\_ADV (C++ enumerator), 308  
 esp\_ble\_enhanced\_power\_type\_t::ESP\_BLE\_ENHANCED\_POWER\_TYPE\_MAX (C++ enumerator), 308  
 esp\_ble\_enhanced\_power\_type\_t::ESP\_BLE\_ENHANCED\_POWER\_TYPE\_SCAN (C++ enumerator), 308  
 esp\_ble\_evt\_type\_t (C++ enum), 242  
 esp\_ble\_evt\_type\_t::ESP\_BLE\_EVT\_CONN\_ADV (C++ enumerator), 242  
 esp\_ble\_evt\_type\_t::ESP\_BLE\_EVT\_CONN\_DIR\_ADV (C++ enumerator), 243  
 esp\_ble\_evt\_type\_t::ESP\_BLE\_EVT\_DISC\_ADV (C++ enumerator), 243  
 esp\_ble\_evt\_type\_t::ESP\_BLE\_EVT\_NON\_CONN\_ADV (C++ enumerator), 243  
 esp\_ble\_evt\_type\_t::ESP\_BLE\_EVT\_SCAN\_RSP (C++ enumerator), 243  
 esp\_ble\_ext\_adv\_type\_mask\_t (C++ type), 229  
 esp\_ble\_ext\_scan\_cfg\_mask\_t (C++ type), 230  
 esp\_ble\_ext\_scan\_cfg\_t (C++ struct), 214  
 esp\_ble\_ext\_scan\_cfg\_t::scan\_interval (C++ member), 214  
 esp\_ble\_ext\_scan\_cfg\_t::scan\_type (C++ member), 214  
 esp\_ble\_ext\_scan\_cfg\_t::scan\_window (C++ member), 214  
 esp\_ble\_ext\_scan\_params\_t (C++ struct), 214  
 esp\_ble\_ext\_scan\_params\_t::cfg\_mask (C++ member), 214  
 esp\_ble\_ext\_scan\_params\_t::coded\_cfg (C++ member), 214  
 esp\_ble\_ext\_scan\_params\_t::filter\_policy (C++ member), 214  
 esp\_ble\_ext\_scan\_params\_t::own\_addr\_type (C++ member), 214  
 esp\_ble\_ext\_scan\_params\_t::scan\_duplicate (C++ member), 214  
 esp\_ble\_ext\_scan\_params\_t::uncoded\_cfg (C++ member), 214  
 esp\_ble\_gap\_add\_device\_to\_resolving\_list (C++ function), 171  
 esp\_ble\_gap\_add\_duplicate\_scan\_exceptional\_device (C++ function), 173  
 esp\_ble\_gap\_addr\_create\_nrpa (C++ function), 170  
 esp\_ble\_gap\_addr\_create\_static (C++ function), 170  
 esp\_ble\_gap\_adv\_type\_t (C++ type), 230  
 esp\_ble\_gap\_all\_phys\_t (C++ type), 230  
 esp\_ble\_gap\_cb\_param\_t (C++ union), 183  
 esp\_ble\_gap\_cb\_param\_t::add\_dev\_to\_resolving\_list (C++ member), 184  
 esp\_ble\_gap\_cb\_param\_t::adv\_clear\_cmpl (C++ member), 184  
 esp\_ble\_gap\_cb\_param\_t::adv\_data\_cmpl (C++ member), 183  
 esp\_ble\_gap\_cb\_param\_t::adv\_terminate (C++ member), 186  
 esp\_ble\_gap\_cb\_param\_t::ble\_add\_dev\_to\_resolving\_list (C++ member), 188  
 esp\_ble\_gap\_cb\_param\_t::ble\_add\_dev\_to\_resolving\_list (C++ member), 188  
 esp\_ble\_gap\_cb\_param\_t::ble\_adv\_clear\_cmpl\_evt\_param (C++ member), 188  
 esp\_ble\_gap\_cb\_param\_t::ble\_adv\_clear\_cmpl\_evt\_param (C++ member), 188  
 esp\_ble\_gap\_cb\_param\_t::ble\_adv\_data\_cmpl\_evt\_param (C++ member), 188  
 esp\_ble\_gap\_cb\_param\_t::ble\_adv\_data\_cmpl\_evt\_param (C++ member), 188  
 esp\_ble\_gap\_cb\_param\_t::ble\_adv\_data\_raw\_cmpl\_evt\_param (C++ member), 188  
 esp\_ble\_gap\_cb\_param\_t::ble\_adv\_data\_raw\_cmpl\_evt\_param (C++ member), 188  
 esp\_ble\_gap\_cb\_param\_t::ble\_adv\_start\_cmpl\_evt\_param (C++ member), 188  
 esp\_ble\_gap\_cb\_param\_t::ble\_adv\_start\_cmpl\_evt\_param (C++ member), 188  
 esp\_ble\_gap\_cb\_param\_t::ble\_adv\_stop\_cmpl\_evt\_param (C++ member), 188  
 esp\_ble\_gap\_cb\_param\_t::ble\_adv\_stop\_cmpl\_evt\_param (C++ member), 188  
 esp\_ble\_gap\_cb\_param\_t::ble\_adv\_stop\_cmpl\_evt\_param (C++ member), 188  
 esp\_ble\_gap\_cb\_param\_t::ble\_adv\_terminate\_param (C++ member), 188  
 esp\_ble\_gap\_cb\_param\_t::ble\_adv\_terminate\_param (C++ member), 189  
 esp\_ble\_gap\_cb\_param\_t::ble\_adv\_terminate\_param (C++ member), 189  
 esp\_ble\_gap\_cb\_param\_t::ble\_adv\_terminate\_param (C++ member), 189  
 esp\_ble\_gap\_cb\_param\_t::ble\_adv\_terminate\_param (C++ member), 189  
 esp\_ble\_gap\_cb\_param\_t::ble\_adv\_terminate\_param (C++ member), 189  
 esp\_ble\_gap\_cb\_param\_t::ble\_adv\_terminate\_param (C++ member), 189  
 esp\_ble\_gap\_cb\_param\_t::ble\_adv\_terminate\_param (C++ member), 189  
 esp\_ble\_gap\_cb\_param\_t::ble\_adv\_terminate\_param (C++ member), 189  
 esp\_ble\_gap\_cb\_param\_t::ble\_adv\_terminate\_param (C++ member), 189  
 esp\_ble\_gap\_cb\_param\_t::ble\_adv\_terminate\_param (C++ member), 189  
 esp\_ble\_gap\_cb\_param\_t::ble\_channel\_sel\_alg\_param (C++ member), 189  
 esp\_ble\_gap\_cb\_param\_t::ble\_channel\_sel\_alg\_param (C++ member), 189  
 esp\_ble\_gap\_cb\_param\_t::ble\_channel\_sel\_alg\_param (C++ member), 189  
 esp\_ble\_gap\_cb\_param\_t::ble\_channel\_sel\_alg\_param (C++ member), 189  
 esp\_ble\_gap\_cb\_param\_t::ble\_clear\_bond\_dev\_cmpl\_evt\_param (C++ member), 189  
 esp\_ble\_gap\_cb\_param\_t::ble\_clear\_bond\_dev\_cmpl\_evt\_param (C++ member), 189  
 esp\_ble\_gap\_cb\_param\_t::ble\_clear\_bond\_dev\_cmpl\_evt\_param (C++ member), 189  
 esp\_ble\_gap\_cb\_param\_t::ble\_dtm\_state\_update\_evt\_param (C++ member), 189  
 esp\_ble\_gap\_cb\_param\_t::ble\_dtm\_state\_update\_evt\_param (C++ member), 189  
 esp\_ble\_gap\_cb\_param\_t::ble\_dtm\_state\_update\_evt\_param (C++ member), 189  
 esp\_ble\_gap\_cb\_param\_t::ble\_dtm\_state\_update\_evt\_param (C++ member), 189

esp\_ble\_gap\_cb\_param\_t::ble\_dtm\_state\_update\_evt\_param::ble\_ext\_conn\_params\_set\_c  
 (C++ member), 189 (C++ struct), 192  
 esp\_ble\_gap\_cb\_param\_t::ble\_ext\_adv\_data\_settle\_evt\_param::ble\_ext\_conn\_params\_set\_c  
 (C++ struct), 190 (C++ member), 192  
 esp\_ble\_gap\_cb\_param\_t::ble\_ext\_adv\_data\_settle\_evt\_param::ble\_ext\_scan\_start\_cmpl\_p  
 (C++ member), 190 (C++ struct), 192  
 esp\_ble\_gap\_cb\_param\_t::ble\_ext\_adv\_data\_settle\_evt\_param::ble\_ext\_scan\_start\_cmpl\_p  
 (C++ member), 190 (C++ member), 192  
 esp\_ble\_gap\_cb\_param\_t::ble\_ext\_adv\_repost\_ble\_gap\_cb\_param\_t::ble\_ext\_scan\_stop\_cmpl\_pa  
 (C++ struct), 190 (C++ struct), 192  
 esp\_ble\_gap\_cb\_param\_t::ble\_ext\_adv\_repost\_ble\_gap\_cb\_param\_t::ble\_ext\_scan\_stop\_cmpl\_pa  
 (C++ member), 190 (C++ member), 192  
 esp\_ble\_gap\_cb\_param\_t::ble\_ext\_adv\_scan\_rsp\_settle\_evt\_param::ble\_get\_bond\_dev\_cmpl\_evt  
 (C++ struct), 190 (C++ struct), 192  
 esp\_ble\_gap\_cb\_param\_t::ble\_ext\_adv\_scan\_rsp\_settle\_evt\_param::ble\_get\_bond\_dev\_cmpl\_evt  
 (C++ member), 190 (C++ member), 192  
 esp\_ble\_gap\_cb\_param\_t::ble\_ext\_adv\_settle\_evt\_param::ble\_get\_bond\_dev\_cmpl\_evt  
 (C++ struct), 190 (C++ member), 192  
 esp\_ble\_gap\_cb\_param\_t::ble\_ext\_adv\_settle\_evt\_param::ble\_get\_bond\_dev\_cmpl\_evt  
 (C++ member), 190 (C++ struct), 193  
 esp\_ble\_gap\_cb\_param\_t::ble\_ext\_adv\_settle\_evt\_param::ble\_get\_dev\_name\_cmpl\_evt  
 (C++ member), 190 (C++ member), 193  
 esp\_ble\_gap\_cb\_param\_t::ble\_ext\_adv\_settle\_evt\_param::ble\_get\_dev\_name\_cmpl\_evt  
 (C++ struct), 190 (C++ member), 193  
 esp\_ble\_gap\_cb\_param\_t::ble\_ext\_adv\_settle\_evt\_param::ble\_get\_dev\_name\_cmpl\_evt  
 (C++ member), 191 (C++ struct), 193  
 esp\_ble\_gap\_cb\_param\_t::ble\_ext\_adv\_settle\_evt\_param::ble\_get\_dev\_name\_cmpl\_evt  
 (C++ member), 191 (C++ member), 193  
 esp\_ble\_gap\_cb\_param\_t::ble\_ext\_adv\_settle\_evt\_param::ble\_period\_adv\_add\_dev\_cm  
 (C++ struct), 191 (C++ struct), 193  
 esp\_ble\_gap\_cb\_param\_t::ble\_ext\_adv\_settle\_evt\_param::ble\_period\_adv\_add\_dev\_cm  
 (C++ member), 191 (C++ member), 193  
 esp\_ble\_gap\_cb\_param\_t::ble\_ext\_adv\_settle\_evt\_param::ble\_period\_adv\_clear\_dev\_  
 (C++ member), 191 (C++ struct), 193  
 esp\_ble\_gap\_cb\_param\_t::ble\_ext\_adv\_settle\_evt\_param::ble\_period\_adv\_clear\_dev\_  
 (C++ struct), 191 (C++ member), 193  
 esp\_ble\_gap\_cb\_param\_t::ble\_ext\_adv\_settle\_evt\_param::ble\_period\_adv\_create\_syn  
 (C++ member), 191 (C++ struct), 193  
 esp\_ble\_gap\_cb\_param\_t::ble\_ext\_adv\_settle\_evt\_param::ble\_period\_adv\_create\_syn  
 (C++ member), 191 (C++ member), 193  
 esp\_ble\_gap\_cb\_param\_t::ble\_ext\_adv\_start\_evt\_param::ble\_period\_adv\_remove\_dev  
 (C++ struct), 191 (C++ struct), 193  
 esp\_ble\_gap\_cb\_param\_t::ble\_ext\_adv\_start\_evt\_param::ble\_period\_adv\_remove\_dev  
 (C++ member), 191 (C++ member), 194  
 esp\_ble\_gap\_cb\_param\_t::ble\_ext\_adv\_start\_evt\_param::ble\_period\_adv\_sync\_cance  
 (C++ member), 191 (C++ struct), 194  
 esp\_ble\_gap\_cb\_param\_t::ble\_ext\_adv\_start\_evt\_param::ble\_period\_adv\_sync\_cance  
 (C++ member), 191 (C++ member), 194  
 esp\_ble\_gap\_cb\_param\_t::ble\_ext\_adv\_stop\_evt\_param::ble\_period\_adv\_sync\_termi  
 (C++ struct), 191 (C++ struct), 194  
 esp\_ble\_gap\_cb\_param\_t::ble\_ext\_adv\_stop\_evt\_param::ble\_period\_adv\_sync\_termi  
 (C++ member), 192 (C++ member), 194  
 esp\_ble\_gap\_cb\_param\_t::ble\_ext\_adv\_stop\_evt\_param::ble\_periodic\_adv\_data\_set  
 (C++ member), 192 (C++ struct), 194  
 esp\_ble\_gap\_cb\_param\_t::ble\_ext\_adv\_stop\_evt\_param::ble\_periodic\_adv\_data\_set  
 (C++ member), 192 (C++ member), 194



esp\_ble\_gap\_cb\_param\_t::ble\_read\_rssi\_evt\_param\_t::ble\_scan\_start\_cmpl\_evt\_param\_t (C++ member), 198 (C++ struct), 201  
 esp\_ble\_gap\_cb\_param\_t::ble\_remove\_bond\_evt\_param\_t::ble\_scan\_start\_cmpl\_evt\_param\_t (C++ struct), 199 (C++ member), 201  
 esp\_ble\_gap\_cb\_param\_t::ble\_remove\_bond\_evt\_param\_t::ble\_scan\_stop\_cmpl\_evt\_param\_t (C++ member), 199 (C++ struct), 201  
 esp\_ble\_gap\_cb\_param\_t::ble\_remove\_bond\_evt\_param\_t::ble\_scan\_stop\_cmpl\_evt\_param\_t (C++ member), 199 (C++ member), 201  
 esp\_ble\_gap\_cb\_param\_t::ble\_rpa\_timeout\_evt\_param\_t::ble\_security\_evt\_param\_t (C++ struct), 199 (C++ member), 184  
 esp\_ble\_gap\_cb\_param\_t::ble\_rpa\_timeout\_evt\_param\_t::ble\_set\_channels\_evt\_param\_t (C++ member), 199 (C++ member), 185  
 esp\_ble\_gap\_cb\_param\_t::ble\_scan\_param\_evt\_param\_t::ble\_set\_channels\_evt\_param\_t (C++ struct), 199 (C++ struct), 201  
 esp\_ble\_gap\_cb\_param\_t::ble\_scan\_param\_evt\_param\_t::ble\_set\_channels\_evt\_param\_t (C++ member), 199 (C++ member), 201  
 esp\_ble\_gap\_cb\_param\_t::ble\_scan\_req\_recv\_evt\_param\_t::ble\_set\_ext\_scan\_params\_cmpl\_evt\_param\_t (C++ struct), 199 (C++ struct), 201  
 esp\_ble\_gap\_cb\_param\_t::ble\_scan\_req\_recv\_evt\_param\_t::ble\_set\_ext\_scan\_params\_cmpl\_evt\_param\_t (C++ member), 199 (C++ member), 202  
 esp\_ble\_gap\_cb\_param\_t::ble\_scan\_req\_recv\_evt\_param\_t::ble\_set\_past\_params\_cmpl\_evt\_param\_t (C++ member), 200 (C++ struct), 202  
 esp\_ble\_gap\_cb\_param\_t::ble\_scan\_req\_recv\_evt\_param\_t::ble\_set\_past\_params\_cmpl\_evt\_param\_t (C++ member), 199 (C++ member), 202  
 esp\_ble\_gap\_cb\_param\_t::ble\_scan\_results\_evt\_param\_t::ble\_set\_past\_params\_cmpl\_evt\_param\_t (C++ struct), 200 (C++ member), 202  
 esp\_ble\_gap\_cb\_param\_t::ble\_scan\_results\_evt\_param\_t::ble\_set\_perf\_def\_phy\_cmpl\_evt\_param\_t (C++ member), 200 (C++ struct), 202  
 esp\_ble\_gap\_cb\_param\_t::ble\_scan\_results\_evt\_param\_t::ble\_set\_perf\_def\_phy\_cmpl\_evt\_param\_t (C++ member), 200 (C++ member), 202  
 esp\_ble\_gap\_cb\_param\_t::ble\_scan\_results\_evt\_param\_t::ble\_set\_perf\_phy\_cmpl\_evt\_param\_t (C++ member), 200 (C++ struct), 202  
 esp\_ble\_gap\_cb\_param\_t::ble\_scan\_results\_evt\_param\_t::ble\_set\_perf\_phy\_cmpl\_evt\_param\_t (C++ member), 200 (C++ member), 202  
 esp\_ble\_gap\_cb\_param\_t::ble\_scan\_results\_evt\_param\_t::ble\_set\_privacy\_mode\_cmpl\_evt\_param\_t (C++ member), 200 (C++ struct), 202  
 esp\_ble\_gap\_cb\_param\_t::ble\_scan\_results\_evt\_param\_t::ble\_set\_privacy\_mode\_cmpl\_evt\_param\_t (C++ member), 200 (C++ member), 202  
 esp\_ble\_gap\_cb\_param\_t::ble\_scan\_results\_evt\_param\_t::ble\_set\_rand\_cmpl\_evt\_param\_t (C++ member), 200 (C++ struct), 202  
 esp\_ble\_gap\_cb\_param\_t::ble\_scan\_results\_evt\_param\_t::ble\_set\_rand\_cmpl\_evt\_param\_t (C++ member), 200 (C++ member), 203  
 esp\_ble\_gap\_cb\_param\_t::ble\_scan\_results\_evt\_param\_t::ble\_update\_conn\_params\_evt\_param\_t (C++ member), 200 (C++ struct), 203  
 esp\_ble\_gap\_cb\_param\_t::ble\_scan\_results\_evt\_param\_t::ble\_update\_conn\_params\_evt\_param\_t (C++ member), 200 (C++ member), 203  
 esp\_ble\_gap\_cb\_param\_t::ble\_scan\_results\_evt\_param\_t::ble\_update\_conn\_params\_evt\_param\_t (C++ member), 200 (C++ member), 203  
 esp\_ble\_gap\_cb\_param\_t::ble\_scan\_results\_evt\_param\_t::ble\_update\_conn\_params\_evt\_param\_t (C++ member), 200 (C++ member), 203  
 esp\_ble\_gap\_cb\_param\_t::ble\_scan\_rsp\_data\_evt\_param\_t::ble\_update\_conn\_params\_evt\_param\_t (C++ struct), 200 (C++ member), 203  
 esp\_ble\_gap\_cb\_param\_t::ble\_scan\_rsp\_data\_evt\_param\_t::ble\_update\_conn\_params\_evt\_param\_t (C++ member), 201 (C++ member), 203  
 esp\_ble\_gap\_cb\_param\_t::ble\_scan\_rsp\_data\_evt\_param\_t::ble\_update\_conn\_params\_evt\_param\_t (C++ struct), 201 (C++ member), 203  
 esp\_ble\_gap\_cb\_param\_t::ble\_scan\_rsp\_data\_evt\_param\_t::ble\_update\_conn\_params\_evt\_param\_t (C++ member), 201 (C++ member), 203





- esp\_ble\_gap\_cb\_param\_t::set\_perf\_phy (C++ member), 215  
 (C++ member), 185
- esp\_ble\_gap\_cb\_param\_t::set\_privacy\_mode\_cmpl (C++ member), 214  
 (C++ member), 187
- esp\_ble\_gap\_cb\_param\_t::set\_rand\_addr\_cmpl (C++ member), 215  
 (C++ member), 184
- esp\_ble\_gap\_cb\_param\_t::set\_rpa\_timeout\_cmpl (C++ member), 215  
 (C++ member), 184
- esp\_ble\_gap\_cb\_param\_t::update\_conn\_params (C++ member), 184  
 (C++ member), 184
- esp\_ble\_gap\_cb\_param\_t::update\_duplicate\_scan\_exception\_cmpl (C++ member), 185  
 (C++ member), 185
- esp\_ble\_gap\_cb\_param\_t::update\_whitelist\_cmpl (C++ member), 185  
 (C++ member), 185
- esp\_ble\_gap\_cb\_param\_t::vendor\_cmd\_cmpl (C++ member), 187  
 (C++ member), 187
- esp\_ble\_gap\_cb\_param\_t::vendor\_cmd\_cmpl\_evt\_params\_t (C++ struct), 204  
 (C++ struct), 204
- esp\_ble\_gap\_cb\_param\_t::vendor\_cmd\_cmpl\_evt\_params\_t::channel\_map (C++ member), 213  
 (C++ member), 213
- esp\_ble\_gap\_cb\_param\_t::vendor\_cmd\_cmpl\_evt\_params\_t::filter\_policy (C++ member), 213  
 (C++ member), 213
- esp\_ble\_gap\_cb\_param\_t::vendor\_cmd\_cmpl\_evt\_params\_t::interval\_max (C++ member), 213  
 (C++ member), 213
- esp\_ble\_gap\_clean\_duplicate\_scan\_exception\_cmpl (C++ function), 174  
 (C++ function), 174
- esp\_ble\_gap\_clear\_advertising (C++ function), 182  
 (C++ function), 182
- esp\_ble\_gap\_clear\_rand\_addr (C++ function), 171  
 (C++ function), 171
- esp\_ble\_gap\_clear\_whitelist (C++ function), 172  
 (C++ function), 172
- esp\_ble\_gap\_config\_adv\_data (C++ function), 169  
 (C++ function), 169
- esp\_ble\_gap\_config\_adv\_data\_raw (C++ function), 173  
 (C++ function), 173
- esp\_ble\_gap\_config\_ext\_adv\_data\_raw (C++ function), 177  
 (C++ function), 177
- esp\_ble\_gap\_config\_ext\_scan\_rsp\_data\_raw (C++ function), 178  
 (C++ function), 178
- esp\_ble\_gap\_config\_local\_icon (C++ function), 171  
 (C++ function), 171
- esp\_ble\_gap\_config\_local\_privacy (C++ function), 171  
 (C++ function), 171
- esp\_ble\_gap\_config\_periodic\_adv\_data\_raw (C++ function), 178  
 (C++ function), 178
- esp\_ble\_gap\_config\_scan\_rsp\_data\_raw (C++ function), 173  
 (C++ function), 173
- esp\_ble\_gap\_conn\_params\_t (C++ struct), 214  
 (C++ struct), 214
- esp\_ble\_gap\_conn\_params\_t::interval\_max (C++ member), 215  
 (C++ member), 215
- esp\_ble\_gap\_conn\_params\_t::interval\_min (C++ member), 215  
 (C++ member), 215
- esp\_ble\_gap\_conn\_params\_t::latency (C++ member), 215  
 (C++ member), 215
- esp\_ble\_gap\_conn\_params\_t::max\_ce\_len (C++ member), 215  
 (C++ member), 215
- esp\_ble\_gap\_conn\_params\_t::min\_ce\_len (C++ member), 215  
 (C++ member), 215
- esp\_ble\_gap\_conn\_params\_t::scan\_interval (C++ member), 214  
 (C++ member), 214
- esp\_ble\_gap\_conn\_params\_t::scan\_window (C++ member), 215  
 (C++ member), 215
- esp\_ble\_gap\_conn\_params\_t::supervision\_timeout (C++ member), 215  
 (C++ member), 215
- esp\_ble\_gap\_disconnect (C++ function), 176  
 (C++ function), 176
- ESP\_BLE\_GAP\_EXT\_ADV\_DATA\_COMPLETE (C macro), 228  
 (C macro), 228
- ESP\_BLE\_GAP\_EXT\_ADV\_DATA\_INCOMPLETE (C macro), 228  
 (C macro), 228
- esp\_ble\_gap\_ext\_adv\_data\_status\_t (C++ type), 230  
 (C++ type), 230
- ESP\_BLE\_GAP\_EXT\_ADV\_DATA\_TRUNCATED (C macro), 228  
 (C macro), 228
- esp\_ble\_gap\_ext\_adv\_params\_t (C++ struct), 213  
 (C++ struct), 213
- esp\_ble\_gap\_ext\_adv\_params\_t::channel\_map (C++ member), 213  
 (C++ member), 213
- esp\_ble\_gap\_ext\_adv\_params\_t::filter\_policy (C++ member), 213  
 (C++ member), 213
- esp\_ble\_gap\_ext\_adv\_params\_t::interval\_max (C++ member), 213  
 (C++ member), 213
- esp\_ble\_gap\_ext\_adv\_params\_t::interval\_min (C++ member), 213  
 (C++ member), 213
- esp\_ble\_gap\_ext\_adv\_params\_t::max\_skip (C++ member), 213  
 (C++ member), 213
- esp\_ble\_gap\_ext\_adv\_params\_t::own\_addr\_type (C++ member), 213  
 (C++ member), 213
- esp\_ble\_gap\_ext\_adv\_params\_t::peer\_addr (C++ member), 213  
 (C++ member), 213
- esp\_ble\_gap\_ext\_adv\_params\_t::peer\_addr\_type (C++ member), 213  
 (C++ member), 213
- esp\_ble\_gap\_ext\_adv\_params\_t::primary\_phy (C++ member), 213  
 (C++ member), 213
- esp\_ble\_gap\_ext\_adv\_params\_t::scan\_req\_notif (C++ member), 213  
 (C++ member), 213
- esp\_ble\_gap\_ext\_adv\_params\_t::secondary\_phy (C++ member), 213  
 (C++ member), 213
- esp\_ble\_gap\_ext\_adv\_params\_t::sid (C++ member), 213  
 (C++ member), 213
- esp\_ble\_gap\_ext\_adv\_params\_t::tx\_power (C++ member), 213  
 (C++ member), 213
- esp\_ble\_gap\_ext\_adv\_params\_t::type (C++ member), 213  
 (C++ member), 213
- esp\_ble\_gap\_ext\_adv\_report\_t (C++ struct), 216  
 (C++ struct), 216
- esp\_ble\_gap\_ext\_adv\_report\_t::addr (C++ member), 216  
 (C++ member), 216
- esp\_ble\_gap\_ext\_adv\_report\_t::addr\_type (C++ member), 216  
 (C++ member), 216
- esp\_ble\_gap\_ext\_adv\_report\_t::adv\_data (C++ member), 217  
 (C++ member), 217
- esp\_ble\_gap\_ext\_adv\_report\_t::adv\_data\_len (C++ member), 217  
 (C++ member), 217
- esp\_ble\_gap\_ext\_adv\_report\_t::data\_status (C++ member), 217  
 (C++ member), 217

esp\_ble\_gap\_ext\_adv\_report\_t::dir\_addr (C++ member), 217  
 esp\_ble\_gap\_ext\_adv\_report\_t::dir\_addr\_type (C++ member), 217  
 esp\_ble\_gap\_ext\_adv\_report\_t::event\_type (C++ member), 216  
 esp\_ble\_gap\_ext\_adv\_report\_t::per\_adv\_interval (C++ member), 217  
 esp\_ble\_gap\_ext\_adv\_report\_t::primary\_phy (C++ member), 216  
 esp\_ble\_gap\_ext\_adv\_report\_t::rssi (C++ member), 217  
 esp\_ble\_gap\_ext\_adv\_report\_t::secondly\_phy (C++ member), 216  
 esp\_ble\_gap\_ext\_adv\_report\_t::sid (C++ member), 217  
 esp\_ble\_gap\_ext\_adv\_report\_t::tx\_power (C++ member), 217  
 esp\_ble\_gap\_ext\_adv\_set\_clear (C++ function), 178  
 esp\_ble\_gap\_ext\_adv\_set\_params (C++ function), 177  
 esp\_ble\_gap\_ext\_adv\_set\_rand\_addr (C++ function), 177  
 esp\_ble\_gap\_ext\_adv\_set\_remove (C++ function), 178  
 esp\_ble\_gap\_ext\_adv\_start (C++ function), 178  
 esp\_ble\_gap\_ext\_adv\_stop (C++ function), 178  
 esp\_ble\_gap\_ext\_adv\_t (C++ struct), 215  
 esp\_ble\_gap\_ext\_adv\_t::duration (C++ member), 215  
 esp\_ble\_gap\_ext\_adv\_t::instance (C++ member), 215  
 esp\_ble\_gap\_ext\_adv\_t::max\_events (C++ member), 215  
 ESP\_BLE\_GAP\_EXT\_SCAN\_CFG\_CODE\_MASK (C macro), 228  
 ESP\_BLE\_GAP\_EXT\_SCAN\_CFG\_UNCODE\_MASK (C macro), 228  
 esp\_ble\_gap\_get\_callback (C++ function), 169  
 esp\_ble\_gap\_get\_device\_name (C++ function), 172  
 esp\_ble\_gap\_get\_local\_used\_addr (C++ function), 172  
 esp\_ble\_gap\_get\_whitelist\_size (C++ function), 172  
 ESP\_BLE\_GAP\_NO\_PREFER\_RECEIVE\_PHY (C macro), 227  
 ESP\_BLE\_GAP\_NO\_PREFER\_TRANSMIT\_PHY (C macro), 227  
 ESP\_BLE\_GAP\_PAST\_MODE\_DUP\_FILTER\_DISABLED (C macro), 229  
 ESP\_BLE\_GAP\_PAST\_MODE\_DUP\_FILTER\_ENABLED (C macro), 229  
 ESP\_BLE\_GAP\_PAST\_MODE\_NO\_REPORT\_EVT (C macro), 229  
 ESP\_BLE\_GAP\_PAST\_MODE\_NO\_SYNC\_EVT (C macro), 229  
 esp\_ble\_gap\_past\_mode\_t (C++ type), 230  
 esp\_ble\_gap\_past\_params\_t (C++ struct), 219  
 esp\_ble\_gap\_past\_params\_t::cte\_type (C++ member), 219  
 esp\_ble\_gap\_past\_params\_t::mode (C++ member), 219  
 esp\_ble\_gap\_past\_params\_t::skip (C++ member), 219  
 esp\_ble\_gap\_past\_params\_t::sync\_timeout (C++ member), 219  
 esp\_ble\_gap\_periodic\_adv\_add\_dev\_to\_list (C++ function), 180  
 esp\_ble\_gap\_periodic\_adv\_clear\_dev (C++ function), 180  
 esp\_ble\_gap\_periodic\_adv\_create\_sync (C++ function), 179  
 esp\_ble\_gap\_periodic\_adv\_params\_t (C++ struct), 215  
 esp\_ble\_gap\_periodic\_adv\_params\_t::interval\_max (C++ member), 215  
 esp\_ble\_gap\_periodic\_adv\_params\_t::interval\_min (C++ member), 215  
 esp\_ble\_gap\_periodic\_adv\_params\_t::properties (C++ member), 216  
 esp\_ble\_gap\_periodic\_adv\_rcv\_enable (C++ function), 180  
 esp\_ble\_gap\_periodic\_adv\_remove\_dev\_from\_list (C++ function), 180  
 esp\_ble\_gap\_periodic\_adv\_report\_t (C++ struct), 217  
 esp\_ble\_gap\_periodic\_adv\_report\_t::data (C++ member), 218  
 esp\_ble\_gap\_periodic\_adv\_report\_t::data\_length (C++ member), 217  
 esp\_ble\_gap\_periodic\_adv\_report\_t::data\_status (C++ member), 217  
 esp\_ble\_gap\_periodic\_adv\_report\_t::rssi (C++ member), 217  
 esp\_ble\_gap\_periodic\_adv\_report\_t::sync\_handle (C++ member), 217  
 esp\_ble\_gap\_periodic\_adv\_report\_t::tx\_power (C++ member), 217  
 esp\_ble\_gap\_periodic\_adv\_set\_info\_trans (C++ function), 181  
 esp\_ble\_gap\_periodic\_adv\_set\_params (C++ function), 178  
 esp\_ble\_gap\_periodic\_adv\_start (C++ function), 179  
 esp\_ble\_gap\_periodic\_adv\_stop (C++ function), 179  
 esp\_ble\_gap\_periodic\_adv\_sync\_cancel (C++ function), 179  
 esp\_ble\_gap\_periodic\_adv\_sync\_estab\_t (C++ struct), 218  
 esp\_ble\_gap\_periodic\_adv\_sync\_estab\_t::addr\_type (C++ member), 218

- (C++ member), 218
- esp\_ble\_gap\_periodic\_adv\_sync\_estab\_t:esp\_ble\_gap\_remove\_duplicate\_scan\_exceptional\_dev (C++ member), 218
- esp\_ble\_gap\_periodic\_adv\_sync\_estab\_t:esp\_ble\_gap\_security\_rsp (C++ member), 218
- esp\_ble\_gap\_periodic\_adv\_sync\_estab\_t:esp\_ble\_gap\_set\_ext\_adv\_prop (C++ member), 218
- esp\_ble\_gap\_periodic\_adv\_sync\_estab\_t:ESP\_BLE\_GAP\_SET\_EXT\_ADV\_PROP\_ANON\_ADV (C++ member), 218
- esp\_ble\_gap\_periodic\_adv\_sync\_estab\_t:ESP\_BLE\_GAP\_SET\_EXT\_ADV\_PROP\_CONNECTABLE (C++ member), 218
- esp\_ble\_gap\_periodic\_adv\_sync\_estab\_t:ESP\_BLE\_GAP\_SET\_EXT\_ADV\_PROP\_DIRECTED (C++ member), 218
- esp\_ble\_gap\_periodic\_adv\_sync\_params\_t ESP\_BLE\_GAP\_SET\_EXT\_ADV\_PROP\_HD\_DIRECTED (C++ struct), 216
- esp\_ble\_gap\_periodic\_adv\_sync\_params\_t:ESP\_BLE\_GAP\_SET\_EXT\_ADV\_PROP\_INCLUDE\_TX\_PWR (C++ member), 216
- esp\_ble\_gap\_periodic\_adv\_sync\_params\_t:ESP\_BLE\_GAP\_SET\_EXT\_ADV\_PROP\_LEGACY (C++ member), 216
- esp\_ble\_gap\_periodic\_adv\_sync\_params\_t:ESP\_BLE\_GAP\_SET\_EXT\_ADV\_PROP\_LEGACY\_HD\_DIR (C++ member), 216
- esp\_ble\_gap\_periodic\_adv\_sync\_params\_t:ESP\_BLE\_GAP\_SET\_EXT\_ADV\_PROP\_LEGACY\_IND (C++ member), 216
- esp\_ble\_gap\_periodic\_adv\_sync\_params\_t:ESP\_BLE\_GAP\_SET\_EXT\_ADV\_PROP\_LEGACY\_LD\_DIR (C++ member), 216
- esp\_ble\_gap\_periodic\_adv\_sync\_params\_t:ESP\_BLE\_GAP\_SET\_EXT\_ADV\_PROP\_LEGACY\_NONCONN (C++ member), 216
- esp\_ble\_gap\_periodic\_adv\_sync\_terminate (C++ function), 179
- esp\_ble\_gap\_periodic\_adv\_sync\_trans (C++ function), 181
- ESP\_BLE\_GAP\_PHY\_1M (C macro), 227
- ESP\_BLE\_GAP\_PHY\_1M\_PREF\_MASK (C macro), 227
- ESP\_BLE\_GAP\_PHY\_2M (C macro), 227
- ESP\_BLE\_GAP\_PHY\_2M\_PREF\_MASK (C macro), 227
- ESP\_BLE\_GAP\_PHY\_CODED (C macro), 227
- ESP\_BLE\_GAP\_PHY\_CODED\_PREF\_MASK (C macro), 227
- esp\_ble\_gap\_phy\_mask\_t (C++ type), 230
- ESP\_BLE\_GAP\_PHY\_OPTIONS\_NO\_PREF (C macro), 227
- ESP\_BLE\_GAP\_PHY\_OPTIONS\_PREF\_S2\_CODING (C macro), 227
- ESP\_BLE\_GAP\_PHY\_OPTIONS\_PREF\_S8\_CODING (C macro), 228
- esp\_ble\_gap\_phy\_t (C++ type), 230
- esp\_ble\_gap\_prefer\_ext\_connect\_params\_set (C++ function), 180
- esp\_ble\_gap\_prefer\_phy\_options\_t (C++ type), 230
- ESP\_BLE\_GAP\_PRI\_PHY\_1M (C macro), 227
- ESP\_BLE\_GAP\_PRI\_PHY\_CODED (C macro), 227
- esp\_ble\_gap\_pri\_phy\_t (C++ type), 230
- esp\_ble\_gap\_read\_phy (C++ function), 176
- esp\_ble\_gap\_read\_rssi (C++ function), 173
- esp\_ble\_gap\_register\_callback (C++ function), 169
- esp\_ble\_gap\_remove\_duplicate\_scan\_exceptional\_dev (C++ function), 173
- esp\_ble\_gap\_security\_rsp (C++ function), 174
- esp\_ble\_gap\_set\_ext\_adv\_prop (C++ function), 172
- ESP\_BLE\_GAP\_SET\_EXT\_ADV\_PROP\_ANON\_ADV (C macro), 226
- ESP\_BLE\_GAP\_SET\_EXT\_ADV\_PROP\_CONNECTABLE (C macro), 226
- ESP\_BLE\_GAP\_SET\_EXT\_ADV\_PROP\_DIRECTED (C macro), 226
- ESP\_BLE\_GAP\_SET\_EXT\_ADV\_PROP\_HD\_DIRECTED (C macro), 226
- ESP\_BLE\_GAP\_SET\_EXT\_ADV\_PROP\_INCLUDE\_TX\_PWR (C macro), 226
- ESP\_BLE\_GAP\_SET\_EXT\_ADV\_PROP\_LEGACY (C macro), 226
- ESP\_BLE\_GAP\_SET\_EXT\_ADV\_PROP\_LEGACY\_HD\_DIR (C macro), 227
- ESP\_BLE\_GAP\_SET\_EXT\_ADV\_PROP\_LEGACY\_IND (C macro), 226
- ESP\_BLE\_GAP\_SET\_EXT\_ADV\_PROP\_LEGACY\_LD\_DIR (C macro), 227
- ESP\_BLE\_GAP\_SET\_EXT\_ADV\_PROP\_LEGACY\_NONCONN (C macro), 227
- ESP\_BLE\_GAP\_SET\_EXT\_ADV\_PROP\_LEGACY\_SCAN (C macro), 227
- ESP\_BLE\_GAP\_SET\_EXT\_ADV\_PROP\_MASK (C macro), 226
- ESP\_BLE\_GAP\_SET\_EXT\_ADV\_PROP\_NONCONN\_NONSCANNABLE (C macro), 226
- ESP\_BLE\_GAP\_SET\_EXT\_ADV\_PROP\_SCANNABLE (C macro), 226
- esp\_ble\_gap\_set\_ext\_scan\_params (C++ function), 179
- esp\_ble\_gap\_set\_periodic\_adv\_sync\_trans\_params (C++ function), 181
- esp\_ble\_gap\_set\_pkt\_data\_len (C++ function), 170
- esp\_ble\_gap\_set\_prefer\_conn\_params (C++ function), 172
- esp\_ble\_gap\_set\_preferred\_default\_phy (C++ function), 177
- esp\_ble\_gap\_set\_preferred\_phy (C++ function), 177
- esp\_ble\_gap\_set\_privacy\_mode (C++ function), 182
- esp\_ble\_gap\_set\_rand\_addr (C++ function), 170
- esp\_ble\_gap\_set\_resolvable\_private\_address\_timeout (C++ function), 170
- esp\_ble\_gap\_set\_scan\_params (C++ function), 169
- esp\_ble\_gap\_set\_security\_param (C++









esp\_ble\_gatts\_cb\_param\_t::gatts\_add\_char\_desc\_rsp\_evt\_param\_t::gatts\_connect\_evt\_param  
 (C++ member), 270 (C++ member), 272  
 esp\_ble\_gatts\_cb\_param\_t::gatts\_add\_char\_desc\_rsp\_evt\_param\_t::gatts\_connect\_evt\_param  
 (C++ member), 270 (C++ member), 272  
 esp\_ble\_gatts\_cb\_param\_t::gatts\_add\_char\_desc\_evt\_param\_t::gatts\_connect\_evt\_param  
 (C++ struct), 270 (C++ member), 272  
 esp\_ble\_gatts\_cb\_param\_t::gatts\_add\_char\_desc\_evt\_param\_t::gatts\_create\_evt\_param  
 (C++ member), 271 (C++ struct), 273  
 esp\_ble\_gatts\_cb\_param\_t::gatts\_add\_char\_desc\_evt\_param\_t::gatts\_create\_evt\_param:  
 (C++ member), 271 (C++ member), 273  
 esp\_ble\_gatts\_cb\_param\_t::gatts\_add\_char\_desc\_evt\_param\_t::gatts\_create\_evt\_param:  
 (C++ member), 271 (C++ member), 273  
 esp\_ble\_gatts\_cb\_param\_t::gatts\_add\_char\_desc\_evt\_param\_t::gatts\_create\_evt\_param:  
 (C++ member), 270 (C++ member), 273  
 esp\_ble\_gatts\_cb\_param\_t::gatts\_add\_incl\_service\_evt\_param\_t::gatts\_delete\_evt\_param  
 (C++ struct), 271 (C++ struct), 273  
 esp\_ble\_gatts\_cb\_param\_t::gatts\_add\_incl\_service\_evt\_param\_t::gatts\_delete\_evt\_param:  
 (C++ member), 271 (C++ member), 273  
 esp\_ble\_gatts\_cb\_param\_t::gatts\_add\_incl\_service\_evt\_param\_t::gatts\_delete\_evt\_param:  
 (C++ member), 271 (C++ member), 273  
 esp\_ble\_gatts\_cb\_param\_t::gatts\_add\_incl\_service\_evt\_param\_t::gatts\_delete\_evt\_param:  
 (C++ member), 270 (C++ member), 273  
 esp\_ble\_gatts\_cb\_param\_t::gatts\_cancel\_evt\_param\_t::gatts\_disconnect\_evt\_param  
 (C++ struct), 271 (C++ member), 273  
 esp\_ble\_gatts\_cb\_param\_t::gatts\_cancel\_evt\_param\_t::gatts\_disconnect\_evt\_param  
 (C++ member), 271 (C++ member), 273  
 esp\_ble\_gatts\_cb\_param\_t::gatts\_close\_evt\_param\_t::gatts\_disconnect\_evt\_param  
 (C++ struct), 271 (C++ member), 273  
 esp\_ble\_gatts\_cb\_param\_t::gatts\_close\_evt\_param\_t::gatts\_disconnect\_evt\_param  
 (C++ member), 271 (C++ struct), 273  
 esp\_ble\_gatts\_cb\_param\_t::gatts\_close\_evt\_param\_t::gatts\_exec\_write\_evt\_param  
 (C++ member), 271 (C++ member), 274  
 esp\_ble\_gatts\_cb\_param\_t::gatts\_conf\_evt\_param\_t::gatts\_exec\_write\_evt\_param  
 (C++ struct), 271 (C++ member), 274  
 esp\_ble\_gatts\_cb\_param\_t::gatts\_conf\_evt\_param\_t::gatts\_exec\_write\_evt\_param  
 (C++ member), 272 (C++ member), 274  
 esp\_ble\_gatts\_cb\_param\_t::gatts\_conf\_evt\_param\_t::gatts\_exec\_write\_evt\_param  
 (C++ member), 272 (C++ member), 274  
 esp\_ble\_gatts\_cb\_param\_t::gatts\_conf\_evt\_param\_t::gatts\_mtu\_evt\_param  
 (C++ member), 272 (C++ struct), 274  
 esp\_ble\_gatts\_cb\_param\_t::gatts\_conf\_evt\_param\_t::gatts\_mtu\_evt\_param::co  
 (C++ member), 272 (C++ member), 274  
 esp\_ble\_gatts\_cb\_param\_t::gatts\_conf\_evt\_param\_t::gatts\_mtu\_evt\_param::mt  
 (C++ member), 272 (C++ member), 274  
 esp\_ble\_gatts\_cb\_param\_t::gatts\_congest\_evt\_param\_t::gatts\_open\_evt\_param  
 (C++ struct), 272 (C++ struct), 274  
 esp\_ble\_gatts\_cb\_param\_t::gatts\_congest\_evt\_param\_t::gatts\_open\_evt\_param::s  
 (C++ member), 272 (C++ member), 274  
 esp\_ble\_gatts\_cb\_param\_t::gatts\_congest\_evt\_param\_t::gatts\_read\_evt\_param  
 (C++ member), 272 (C++ struct), 274  
 esp\_ble\_gatts\_cb\_param\_t::gatts\_connect\_evt\_param\_t::gatts\_read\_evt\_param::b  
 (C++ struct), 272 (C++ member), 274  
 esp\_ble\_gatts\_cb\_param\_t::gatts\_connect\_evt\_param\_t::gatts\_read\_evt\_param::c  
 (C++ member), 272 (C++ member), 274  
 esp\_ble\_gatts\_cb\_param\_t::gatts\_connect\_evt\_param\_t::gatts\_read\_evt\_param::h  
 (C++ member), 273 (C++ member), 275  
 esp\_ble\_gatts\_cb\_param\_t::gatts\_connect\_evt\_param\_t::gatts\_read\_evt\_param::i  
 (C++ member), 272 (C++ member), 275





- esp\_ble\_hw\_get\_static\_addr (C++ function), 301
- ESP\_BLE\_ID\_KEY\_MASK (C macro), 158
- esp\_ble\_io\_cap\_t (C++ type), 229
- ESP\_BLE\_IS\_VALID\_PARAM (C macro), 158
- esp\_ble\_key\_mask\_t (C++ type), 159
- esp\_ble\_key\_t (C++ struct), 211
- esp\_ble\_key\_t::bd\_addr (C++ member), 211
- esp\_ble\_key\_t::key\_type (C++ member), 211
- esp\_ble\_key\_t::p\_key\_value (C++ member), 211
- esp\_ble\_key\_type\_t (C++ type), 229
- esp\_ble\_key\_value\_t (C++ union), 182
- esp\_ble\_key\_value\_t::lcsr\_key (C++ member), 183
- esp\_ble\_key\_value\_t::lenc\_key (C++ member), 182
- esp\_ble\_key\_value\_t::pcsr\_key (C++ member), 182
- esp\_ble\_key\_value\_t::penc\_key (C++ member), 182
- esp\_ble\_key\_value\_t::pid\_key (C++ member), 182
- esp\_ble\_lcsr\_keys (C++ struct), 210
- esp\_ble\_lcsr\_keys::counter (C++ member), 210
- esp\_ble\_lcsr\_keys::csr\_key (C++ member), 210
- esp\_ble\_lcsr\_keys::div (C++ member), 210
- esp\_ble\_lcsr\_keys::sec\_level (C++ member), 210
- ESP\_BLE\_LEGACY\_ADV\_TYPE\_DIRECT\_IND (C macro), 228
- ESP\_BLE\_LEGACY\_ADV\_TYPE\_IND (C macro), 228
- ESP\_BLE\_LEGACY\_ADV\_TYPE\_NONCON\_IND (C macro), 229
- ESP\_BLE\_LEGACY\_ADV\_TYPE\_SCAN\_IND (C macro), 228
- ESP\_BLE\_LEGACY\_ADV\_TYPE\_SCAN\_RSP\_TO\_ADV\_IND (C macro), 229
- ESP\_BLE\_LEGACY\_ADV\_TYPE\_SCAN\_RSP\_TO\_ADV\_SCAN\_IND (C macro), 229
- esp\_ble\_lenc\_keys\_t (C++ struct), 209
- esp\_ble\_lenc\_keys\_t::div (C++ member), 209
- esp\_ble\_lenc\_keys\_t::key\_size (C++ member), 210
- esp\_ble\_lenc\_keys\_t::ltk (C++ member), 209
- esp\_ble\_lenc\_keys\_t::sec\_level (C++ member), 210
- ESP\_BLE\_LINK\_KEY\_MASK (C macro), 158
- esp\_ble\_local\_id\_keys\_t (C++ struct), 211
- esp\_ble\_local\_id\_keys\_t::dhk (C++ member), 212
- esp\_ble\_local\_id\_keys\_t::ir (C++ member), 211
- esp\_ble\_local\_id\_keys\_t::irk (C++ member), 211
- esp\_ble\_local\_oob\_data\_t (C++ struct), 212
- esp\_ble\_local\_oob\_data\_t::oob\_c (C++ member), 212
- esp\_ble\_local\_oob\_data\_t::oob\_r (C++ member), 212
- esp\_ble\_log\_buf\_t (C++ enum), 308
- esp\_ble\_log\_buf\_t::ESP\_BLE\_LOG\_BUF\_CONTROLLER (C++ enumerator), 308
- esp\_ble\_log\_buf\_t::ESP\_BLE\_LOG\_BUF\_HCI (C++ enumerator), 308
- ESP\_BLE\_MESH\_ACTUATOR\_BLOCKED\_ERROR (C macro), 456
- ESP\_BLE\_MESH\_ACTUATOR\_BLOCKED\_WARNING (C macro), 456
- ESP\_BLE\_MESH\_ADDR\_ALL\_NODES (C macro), 356
- ESP\_BLE\_MESH\_ADDR\_FRIENDS (C macro), 356
- ESP\_BLE\_MESH\_ADDR\_IS\_GROUP (C macro), 358
- ESP\_BLE\_MESH\_ADDR\_IS\_RFU (C macro), 358
- ESP\_BLE\_MESH\_ADDR\_IS\_UNICAST (C macro), 358
- ESP\_BLE\_MESH\_ADDR\_IS\_VIRTUAL (C macro), 358
- ESP\_BLE\_MESH\_ADDR\_PROXIES (C macro), 356
- ESP\_BLE\_MESH\_ADDR\_RELAYS (C macro), 356
- ESP\_BLE\_MESH\_ADDR\_TYPE\_PUBLIC (C macro), 360
- ESP\_BLE\_MESH\_ADDR\_TYPE\_RANDOM (C macro), 360
- ESP\_BLE\_MESH\_ADDR\_TYPE\_RPA\_PUBLIC (C macro), 360
- ESP\_BLE\_MESH\_ADDR\_TYPE\_RPA\_RANDOM (C macro), 360
- esp\_ble\_mesh\_addr\_type\_t (C++ type), 381
- ESP\_BLE\_MESH\_ADDR\_UNASSIGNED (C macro), 356
- ESP\_BLE\_MESH\_ADDR\_UNASSIGNED\_ELT\_ (C macro), 356
- esp\_ble\_mesh\_agg\_client\_cb\_event\_t (C++ enum), 680
- esp\_ble\_mesh\_agg\_client\_cb\_event\_t::ESP\_BLE\_MESH\_ (C++ enumerator), 680
- esp\_ble\_mesh\_agg\_client\_cb\_event\_t::ESP\_BLE\_MESH\_ (C++ enumerator), 680
- esp\_ble\_mesh\_agg\_client\_cb\_event\_t::ESP\_BLE\_MESH\_ (C++ enumerator), 680
- esp\_ble\_mesh\_agg\_client\_cb\_event\_t::ESP\_BLE\_MESH\_ (C++ enumerator), 680
- esp\_ble\_mesh\_agg\_client\_cb\_event\_t::ESP\_BLE\_MESH\_ (C++ enumerator), 680
- esp\_ble\_mesh\_agg\_client\_cb\_param\_t (C++ struct), 678
- esp\_ble\_mesh\_agg\_client\_cb\_param\_t::params (C++ member), 678
- esp\_ble\_mesh\_agg\_client\_cb\_param\_t::recv (C++ member), 678

- esp\_ble\_mesh\_agg\_client\_cb\_param\_t::send (C++ member), 677  
 (C++ member), 678
- esp\_ble\_mesh\_agg\_client\_cb\_param\_t::[anonymous]mesh\_agg\_srv\_t::model (C++ member), 678  
 (C++ member), 677
- esp\_ble\_mesh\_agg\_client\_cb\_t (C++ type), 680  
 ESP\_BLE\_MESH\_AGG\_STATUS\_INVALID\_ADDRESS (C macro), 679
- esp\_ble\_mesh\_agg\_client\_msg\_t (C++ union), 676  
 ESP\_BLE\_MESH\_AGG\_STATUS\_INVALID\_MODEL (C macro), 679
- esp\_ble\_mesh\_agg\_client\_msg\_t::agg\_sequence (C++ member), 676  
 ESP\_BLE\_MESH\_AGG\_STATUS\_MSG\_NOT\_UNDERSTOOD (C macro), 679
- esp\_ble\_mesh\_agg\_client\_rcv\_cb\_t (C++ union), 676  
 ESP\_BLE\_MESH\_AGG\_STATUS\_SUCCESS (C macro), 679
- esp\_ble\_mesh\_agg\_client\_rcv\_cb\_t::agg\_status (C++ member), 676  
 esp\_ble\_mesh\_agg\_status\_t (C++ struct), 677
- esp\_ble\_mesh\_agg\_client\_send (C++ function), 676  
 esp\_ble\_mesh\_agg\_status\_t::element\_addr (C++ member), 678
- esp\_ble\_mesh\_agg\_client\_send\_cb\_t (C++ struct), 678  
 esp\_ble\_mesh\_agg\_status\_t::items (C++ member), 678
- esp\_ble\_mesh\_agg\_client\_send\_cb\_t::err\_code (C++ member), 678  
 esp\_ble\_mesh\_agg\_status\_t::status (C++ member), 677
- ESP\_BLE\_MESH\_AGG\_ITEM\_LENGTH\_FORMAT\_LONG (C macro), 679  
 ESP\_BLE\_MESH\_AGG\_STATUS\_WRONG\_ACCESS\_KEY (C macro), 679
- ESP\_BLE\_MESH\_AGG\_ITEM\_LENGTH\_FORMAT\_SHORT (C macro), 679  
 ESP\_BLE\_MESH\_AGG\_STATUS\_WRONG\_OPCODE (C macro), 679
- esp\_ble\_mesh\_agg\_item\_t (C++ struct), 677  
 ESP\_BLE\_MESH\_BATTERY\_LOW\_ERROR (C macro), 454
- esp\_ble\_mesh\_agg\_item\_t::data (C++ member), 677  
 ESP\_BLE\_MESH\_BATTERY\_LOW\_WARNING (C macro), 454
- esp\_ble\_mesh\_agg\_item\_t::length (C++ member), 677  
 esp\_ble\_mesh\_bd\_addr\_t (C++ type), 381
- esp\_ble\_mesh\_agg\_item\_t::length\_format (C++ member), 677  
 ESP\_BLE\_MESH\_BEACON\_DISABLED (C macro), 357
- esp\_ble\_mesh\_agg\_sequence\_t (C++ struct), 677  
 ESP\_BLE\_MESH\_BEACON\_ENABLED (C macro), 357
- esp\_ble\_mesh\_agg\_sequence\_t::element\_addr (C++ member), 677  
 esp\_ble\_mesh\_brc\_client\_cb\_event\_t (C++ enum), 653
- esp\_ble\_mesh\_agg\_sequence\_t::items (C++ member), 677  
 esp\_ble\_mesh\_brc\_client\_cb\_event\_t::ESP\_BLE\_MESH\_ (C++ enumerator), 653
- esp\_ble\_mesh\_agg\_server\_cb\_event\_t (C++ enum), 680  
 esp\_ble\_mesh\_brc\_client\_cb\_event\_t::ESP\_BLE\_MESH\_ (C++ enumerator), 653
- esp\_ble\_mesh\_agg\_server\_cb\_event\_t::ESP\_BLE\_MESH\_ (C++ enumerator), 680  
 esp\_ble\_mesh\_brc\_client\_cb\_event\_t::ESP\_BLE\_MESH\_ (C++ enumerator), 653
- esp\_ble\_mesh\_agg\_server\_cb\_event\_t::ESP\_BLE\_MESH\_ (C++ enumerator), 680  
 esp\_ble\_mesh\_brc\_client\_cb\_event\_t::ESP\_BLE\_MESH\_ (C++ enumerator), 653
- esp\_ble\_mesh\_agg\_server\_cb\_param\_t (C++ struct), 678  
 esp\_ble\_mesh\_brc\_client\_cb\_event\_t::ESP\_BLE\_MESH\_ (C++ enumerator), 653
- esp\_ble\_mesh\_agg\_server\_cb\_param\_t::ctx (C++ member), 678  
 esp\_ble\_mesh\_brc\_client\_cb\_param\_t (C++ struct), 650
- esp\_ble\_mesh\_agg\_server\_cb\_param\_t::model (C++ member), 678  
 esp\_ble\_mesh\_brc\_client\_cb\_param\_t::params (C++ member), 650
- esp\_ble\_mesh\_agg\_server\_cb\_param\_t::rcv (C++ member), 678  
 esp\_ble\_mesh\_brc\_client\_cb\_param\_t::rcv (C++ member), 650
- esp\_ble\_mesh\_agg\_server\_cb\_param\_t::[anonymous] (C++ member), 679  
 esp\_ble\_mesh\_brc\_client\_cb\_param\_t::send (C++ member), 650
- esp\_ble\_mesh\_agg\_server\_cb\_t (C++ type), 680  
 esp\_ble\_mesh\_brc\_client\_cb\_param\_t::[anonymous] (C++ member), 650
- esp\_ble\_mesh\_agg\_server\_rcv\_msg\_t (C++ union), 676  
 esp\_ble\_mesh\_brc\_client\_cb\_t (C++ type), 653
- esp\_ble\_mesh\_agg\_server\_rcv\_msg\_t::agg\_sequence (C++ member), 644  
 esp\_ble\_mesh\_brc\_client\_msg\_t (C++ union), 644





esp\_ble\_mesh\_bridging\_table\_list\_t::bridge\_table\_list\_cfg\_app\_key\_add\_t::net\_idx  
 (C++ member), 650 (C++ member), 426  
 esp\_ble\_mesh\_bridging\_table\_list\_t::bridge\_table\_list\_cfg\_app\_key\_delete\_t  
 (C++ member), 650 (C++ struct), 431  
 esp\_ble\_mesh\_bridging\_table\_list\_t::status esp\_ble\_mesh\_cfg\_app\_key\_delete\_t::app\_idx  
 (C++ member), 649 (C++ member), 431  
 esp\_ble\_mesh\_bridging\_table\_remove\_t esp\_ble\_mesh\_cfg\_app\_key\_delete\_t::net\_idx  
 (C++ struct), 647 (C++ member), 431  
 esp\_ble\_mesh\_bridging\_table\_remove\_t::bridge\_table\_1\_cfg\_app\_key\_get\_t (C++  
 (C++ member), 647 struct), 423  
 esp\_ble\_mesh\_bridging\_table\_remove\_t::bridge\_table\_2\_cfg\_app\_key\_get\_t::net\_idx  
 (C++ member), 647 (C++ member), 423  
 esp\_ble\_mesh\_bridging\_table\_remove\_t::bridge\_table\_idx\_cfg\_app\_key\_list\_cb\_t  
 (C++ member), 647 (C++ struct), 438  
 esp\_ble\_mesh\_bridging\_table\_remove\_t::bridge\_table\_idx\_cfg\_app\_key\_list\_cb\_t::app\_idx  
 (C++ member), 647 (C++ member), 438  
 esp\_ble\_mesh\_bridging\_table\_size\_status esp\_ble\_mesh\_cfg\_app\_key\_list\_cb\_t::net\_idx  
 (C++ struct), 650 (C++ member), 438  
 esp\_ble\_mesh\_bridging\_table\_size\_status::bridge\_table\_idx\_cfg\_app\_key\_list\_cb\_t::status  
 (C++ member), 650 (C++ member), 438  
 esp\_ble\_mesh\_bridging\_table\_status\_t esp\_ble\_mesh\_cfg\_app\_key\_status\_cb\_t  
 (C++ struct), 648 (C++ struct), 435  
 esp\_ble\_mesh\_bridging\_table\_status\_t::bridge\_table\_1\_cfg\_app\_key\_status\_cb\_t::app\_idx  
 (C++ member), 648 (C++ member), 435  
 esp\_ble\_mesh\_bridging\_table\_status\_t::bridge\_table\_2\_cfg\_app\_key\_status\_cb\_t::net\_idx  
 (C++ member), 648 (C++ member), 435  
 esp\_ble\_mesh\_bridging\_table\_status\_t::bridge\_table\_idx\_cfg\_app\_key\_status\_cb\_t::status  
 (C++ member), 648 (C++ member), 435  
 esp\_ble\_mesh\_bridging\_table\_status\_t::bridge\_table\_idx\_cfg\_app\_key\_update\_t  
 (C++ member), 648 (C++ struct), 430  
 esp\_ble\_mesh\_bridging\_table\_status\_t::bridge\_table\_idx\_cfg\_app\_key\_update\_t::app\_idx  
 (C++ member), 648 (C++ member), 430  
 esp\_ble\_mesh\_bridging\_table\_status\_t::status esp\_ble\_mesh\_cfg\_app\_key\_update\_t::app\_key  
 (C++ member), 648 (C++ member), 430  
 esp\_ble\_mesh\_cb\_t (C++ type), 381 esp\_ble\_mesh\_cfg\_app\_key\_update\_t::net\_idx  
 esp\_ble\_mesh\_cb\_type\_t (C++ enum), 383 (C++ member), 430  
 esp\_ble\_mesh\_cb\_type\_t::ESP\_BLE\_MESH\_TYPE\_COMPLETE esp\_ble\_mesh\_cfg\_beacon\_set\_t (C++  
 (C++ enumerator), 383 struct), 424  
 esp\_ble\_mesh\_cb\_type\_t::ESP\_BLE\_MESH\_TYPE\_INTERRUPT esp\_ble\_mesh\_cfg\_beacon\_set\_t::beacon  
 (C++ enumerator), 383 (C++ member), 424  
 esp\_ble\_mesh\_cb\_type\_t::ESP\_BLE\_MESH\_TYPE\_LINK\_SETUP esp\_ble\_mesh\_cfg\_beacon\_status\_cb\_t  
 (C++ enumerator), 383 (C++ struct), 433  
 esp\_ble\_mesh\_cb\_type\_t::ESP\_BLE\_MESH\_TYPE\_LINK\_SETUP esp\_ble\_mesh\_cfg\_beacon\_status\_cb\_t::beacon  
 (C++ enumerator), 383 (C++ member), 433  
 esp\_ble\_mesh\_cb\_type\_t::ESP\_BLE\_MESH\_TYPE\_UPDATE\_NUM\_CFG esp\_ble\_mesh\_cfg\_client\_cb\_event\_t  
 (C++ enumerator), 383 (C++ enum), 446  
 esp\_ble\_mesh\_cb\_type\_t::ESP\_BLE\_MESH\_TYPE\_UPDATE\_STR\_CFG esp\_ble\_mesh\_cfg\_client\_cb\_event\_t::ESP\_BLE\_MESH  
 (C++ enumerator), 383 (C++ enumerator), 446  
 esp\_ble\_mesh\_cb\_type\_t::ESP\_BLE\_MESH\_TYPE\_PROXY esp\_ble\_mesh\_cfg\_client\_cb\_event\_t::ESP\_BLE\_MESH  
 (C++ enumerator), 383 (C++ enumerator), 446  
 esp\_ble\_mesh\_cb\_type\_t::ESP\_BLE\_MESH\_TYPE\_REMOTE esp\_ble\_mesh\_cfg\_client\_cb\_event\_t::ESP\_BLE\_MESH  
 (C++ enumerator), 383 (C++ enumerator), 446  
 esp\_ble\_mesh\_cfg\_app\_key\_add\_t (C++ esp\_ble\_mesh\_cfg\_client\_cb\_event\_t::ESP\_BLE\_MESH  
 struct), 425 (C++ enumerator), 446  
 esp\_ble\_mesh\_cfg\_app\_key\_add\_t::app\_idx esp\_ble\_mesh\_cfg\_client\_cb\_event\_t::ESP\_BLE\_MESH  
 (C++ member), 426 (C++ enumerator), 446  
 esp\_ble\_mesh\_cfg\_app\_key\_add\_t::app\_key esp\_ble\_mesh\_cfg\_client\_cb\_param\_t  
 (C++ member), 426 (C++ struct), 440

esp\_ble\_mesh\_cfg\_client\_cb\_param\_t::err\_resp\_code (C++ member), 440  
 esp\_ble\_mesh\_cfg\_client\_cb\_param\_t::err\_resp\_code (C++ member), 416  
 esp\_ble\_mesh\_cfg\_client\_cb\_param\_t::params (C++ member), 440  
 esp\_ble\_mesh\_cfg\_client\_cb\_param\_t::params (C++ member), 416  
 esp\_ble\_mesh\_cfg\_client\_cb\_param\_t::status (C++ member), 440  
 esp\_ble\_mesh\_cfg\_client\_cb\_param\_t::status (C++ member), 415  
 esp\_ble\_mesh\_cfg\_client\_cb\_t (C++ type), 445  
 esp\_ble\_mesh\_cfg\_client\_cb\_t (C++ type), 416  
 esp\_ble\_mesh\_cfg\_client\_common\_cb\_param\_t (C++ union), 418  
 esp\_ble\_mesh\_cfg\_client\_common\_cb\_param\_t (C++ member), 416  
 esp\_ble\_mesh\_cfg\_client\_common\_cb\_param\_t::ble\_mesh\_cfg\_client\_get\_state\_t::sig\_model\_ap (C++ member), 419  
 esp\_ble\_mesh\_cfg\_client\_common\_cb\_param\_t::ble\_mesh\_cfg\_client\_get\_state\_t::sig\_model\_su (C++ member), 415  
 esp\_ble\_mesh\_cfg\_client\_common\_cb\_param\_t::ble\_mesh\_cfg\_client\_get\_state\_t::vnd\_model\_ap (C++ member), 418  
 esp\_ble\_mesh\_cfg\_client\_common\_cb\_param\_t::ble\_mesh\_cfg\_client\_get\_state\_t::vnd\_model\_su (C++ member), 415  
 esp\_ble\_mesh\_cfg\_client\_common\_cb\_param\_t::ble\_mesh\_cfg\_client\_set\_state\_t (C++ member), 418  
 esp\_ble\_mesh\_cfg\_client\_common\_cb\_param\_t::ble\_mesh\_cfg\_client\_set\_state\_t (C++ union), 416  
 esp\_ble\_mesh\_cfg\_client\_common\_cb\_param\_t::ble\_mesh\_cfg\_client\_set\_state\_t::app\_key\_add (C++ member), 418  
 esp\_ble\_mesh\_cfg\_client\_common\_cb\_param\_t::ble\_mesh\_cfg\_client\_set\_state\_t::app\_key\_add (C++ member), 417  
 esp\_ble\_mesh\_cfg\_client\_common\_cb\_param\_t::ble\_mesh\_cfg\_client\_set\_state\_t::app\_key\_dele (C++ member), 419  
 esp\_ble\_mesh\_cfg\_client\_common\_cb\_param\_t::ble\_mesh\_cfg\_client\_set\_state\_t::app\_key\_dele (C++ member), 418  
 esp\_ble\_mesh\_cfg\_client\_common\_cb\_param\_t::ble\_mesh\_cfg\_client\_set\_state\_t::app\_key\_upda (C++ member), 418  
 esp\_ble\_mesh\_cfg\_client\_common\_cb\_param\_t::ble\_mesh\_cfg\_client\_set\_state\_t::app\_key\_upda (C++ member), 417  
 esp\_ble\_mesh\_cfg\_client\_common\_cb\_param\_t::ble\_mesh\_cfg\_client\_set\_state\_t::beacon\_set (C++ member), 419  
 esp\_ble\_mesh\_cfg\_client\_common\_cb\_param\_t::ble\_mesh\_cfg\_client\_set\_state\_t::beacon\_set (C++ member), 416  
 esp\_ble\_mesh\_cfg\_client\_common\_cb\_param\_t::ble\_mesh\_cfg\_client\_set\_state\_t::default\_ttl (C++ member), 419  
 esp\_ble\_mesh\_cfg\_client\_common\_cb\_param\_t::ble\_mesh\_cfg\_client\_set\_state\_t::default\_ttl (C++ member), 416  
 esp\_ble\_mesh\_cfg\_client\_common\_cb\_param\_t::ble\_mesh\_cfg\_client\_set\_state\_t::friend\_set (C++ member), 419  
 esp\_ble\_mesh\_cfg\_client\_common\_cb\_param\_t::ble\_mesh\_cfg\_client\_set\_state\_t::friend\_set (C++ member), 416  
 esp\_ble\_mesh\_cfg\_client\_common\_cb\_param\_t::ble\_mesh\_cfg\_client\_set\_state\_t::gatt\_proxy\_s (C++ member), 419  
 esp\_ble\_mesh\_cfg\_client\_common\_cb\_param\_t::ble\_mesh\_cfg\_client\_set\_state\_t::gatt\_proxy\_s (C++ member), 416  
 esp\_ble\_mesh\_cfg\_client\_common\_cb\_param\_t::ble\_mesh\_cfg\_client\_set\_state\_t::heartbeat\_pu (C++ member), 419  
 esp\_ble\_mesh\_cfg\_client\_common\_cb\_param\_t::ble\_mesh\_cfg\_client\_set\_state\_t::heartbeat\_pu (C++ member), 417  
 esp\_ble\_mesh\_cfg\_client\_common\_cb\_param\_t::ble\_mesh\_cfg\_client\_set\_state\_t::heartbeat\_su (C++ member), 419  
 esp\_ble\_mesh\_cfg\_client\_common\_cb\_param\_t::ble\_mesh\_cfg\_client\_set\_state\_t::heartbeat\_su (C++ member), 417  
 esp\_ble\_mesh\_cfg\_client\_common\_cb\_param\_t::ble\_mesh\_cfg\_client\_set\_state\_t::kr\_phase\_set (C++ member), 418  
 esp\_ble\_mesh\_cfg\_client\_common\_cb\_param\_t::ble\_mesh\_cfg\_client\_set\_state\_t::kr\_phase\_set (C++ member), 418  
 esp\_ble\_mesh\_cfg\_client\_common\_cb\_param\_t::ble\_mesh\_cfg\_client\_set\_state\_t::model\_app\_bi (C++ member), 419  
 esp\_ble\_mesh\_cfg\_client\_common\_cb\_param\_t::ble\_mesh\_cfg\_client\_set\_state\_t::model\_app\_bi (C++ member), 417  
 esp\_ble\_mesh\_cfg\_client\_common\_cb\_param\_t::ble\_mesh\_cfg\_client\_set\_state\_t::model\_app\_un (C++ member), 418  
 esp\_ble\_mesh\_cfg\_client\_common\_cb\_param\_t::ble\_mesh\_cfg\_client\_set\_state\_t::model\_app\_un (C++ member), 418  
 esp\_ble\_mesh\_cfg\_client\_common\_cb\_param\_t::ble\_mesh\_cfg\_client\_set\_state\_t::model\_pub\_se (C++ member), 419  
 esp\_ble\_mesh\_cfg\_client\_common\_cb\_param\_t::ble\_mesh\_cfg\_client\_set\_state\_t::model\_pub\_se (C++ member), 417  
 esp\_ble\_mesh\_cfg\_client\_common\_cb\_param\_t::ble\_mesh\_cfg\_client\_set\_state\_t::model\_pub\_va (C++ member), 419  
 esp\_ble\_mesh\_cfg\_client\_common\_cb\_param\_t::ble\_mesh\_cfg\_client\_set\_state\_t::model\_pub\_va (C++ member), 417  
 esp\_ble\_mesh\_cfg\_client\_common\_cb\_param\_t::ble\_mesh\_cfg\_client\_set\_state\_t::model\_sub\_ad (C++ member), 418  
 esp\_ble\_mesh\_cfg\_client\_common\_cb\_param\_t::ble\_mesh\_cfg\_client\_set\_state\_t::model\_sub\_ad (C++ member), 417  
 esp\_ble\_mesh\_cfg\_client\_common\_cb\_param\_t::ble\_mesh\_cfg\_client\_set\_state\_t::model\_sub\_de (C++ member), 419  
 esp\_ble\_mesh\_cfg\_client\_common\_cb\_param\_t::ble\_mesh\_cfg\_client\_set\_state\_t::model\_sub\_de (C++ member), 417  
 esp\_ble\_mesh\_cfg\_client\_common\_cb\_param\_t::ble\_mesh\_cfg\_client\_set\_state\_t::model\_sub\_de (C++ member), 418  
 esp\_ble\_mesh\_cfg\_client\_common\_cb\_param\_t::ble\_mesh\_cfg\_client\_set\_state\_t::model\_sub\_de (C++ member), 417  
 esp\_ble\_mesh\_cfg\_client\_get\_state\_t (C++ union), 415  
 esp\_ble\_mesh\_cfg\_client\_get\_state\_t (C++ member), 417  
 esp\_ble\_mesh\_cfg\_client\_get\_state\_t::app\_key\_get (C++ member), 416  
 esp\_ble\_mesh\_cfg\_client\_get\_state\_t::app\_key\_get (C++ member), 417  
 esp\_ble\_mesh\_cfg\_client\_get\_state\_t::comp\_data\_mesh (C++ member), 415  
 esp\_ble\_mesh\_cfg\_client\_get\_state\_t::comp\_data\_mesh (C++ member), 417

esp\_ble\_mesh\_cfg\_client\_set\_state\_t::mode esp\_ble\_mesh\_cfg\_hb\_pub\_status\_cb\_t::period  
 (C++ member), 417 (C++ member), 436  
 esp\_ble\_mesh\_cfg\_client\_set\_state\_t::net\_key\_idx esp\_ble\_mesh\_cfg\_hb\_pub\_status\_cb\_t::status  
 (C++ member), 416 (C++ member), 436  
 esp\_ble\_mesh\_cfg\_client\_set\_state\_t::net\_key\_len esp\_ble\_mesh\_cfg\_hb\_pub\_status\_cb\_t::ttl  
 (C++ member), 417 (C++ member), 436  
 esp\_ble\_mesh\_cfg\_client\_set\_state\_t::net\_key\_len esp\_ble\_mesh\_cfg\_hb\_sub\_status\_cb\_t  
 (C++ member), 417 (C++ struct), 437  
 esp\_ble\_mesh\_cfg\_client\_set\_state\_t::net\_key\_len esp\_ble\_mesh\_cfg\_hb\_sub\_status\_cb\_t::count  
 (C++ member), 418 (C++ member), 437  
 esp\_ble\_mesh\_cfg\_client\_set\_state\_t::net\_key\_len esp\_ble\_mesh\_cfg\_hb\_sub\_status\_cb\_t::dst  
 (C++ member), 418 (C++ member), 437  
 esp\_ble\_mesh\_cfg\_client\_set\_state\_t::relay\_idx esp\_ble\_mesh\_cfg\_hb\_sub\_status\_cb\_t::max\_hops  
 (C++ member), 416 (C++ member), 437  
 esp\_ble\_mesh\_cfg\_comp\_data\_status\_cb\_t esp\_ble\_mesh\_cfg\_hb\_sub\_status\_cb\_t::min\_hops  
 (C++ struct), 433 (C++ member), 437  
 esp\_ble\_mesh\_cfg\_comp\_data\_status\_cb\_t::period esp\_ble\_mesh\_cfg\_hb\_sub\_status\_cb\_t::period  
 (C++ member), 433 (C++ member), 437  
 esp\_ble\_mesh\_cfg\_comp\_data\_status\_cb\_t::src esp\_ble\_mesh\_cfg\_hb\_sub\_status\_cb\_t::src  
 (C++ member), 433 (C++ member), 437  
 esp\_ble\_mesh\_cfg\_composition\_data\_get\_t esp\_ble\_mesh\_cfg\_hb\_sub\_status\_cb\_t::status  
 (C++ struct), 422 (C++ member), 437  
 esp\_ble\_mesh\_cfg\_composition\_data\_get\_t::src esp\_ble\_mesh\_cfg\_heartbeat\_pub\_set\_t  
 (C++ member), 422 (C++ struct), 432  
 esp\_ble\_mesh\_cfg\_default\_ttl\_set\_t esp\_ble\_mesh\_cfg\_heartbeat\_pub\_set\_t::count  
 (C++ struct), 424 (C++ member), 432  
 esp\_ble\_mesh\_cfg\_default\_ttl\_set\_t::ttl esp\_ble\_mesh\_cfg\_heartbeat\_pub\_set\_t::dst  
 (C++ member), 425 (C++ member), 432  
 esp\_ble\_mesh\_cfg\_default\_ttl\_status\_cb\_t esp\_ble\_mesh\_cfg\_heartbeat\_pub\_set\_t::feature  
 (C++ struct), 433 (C++ member), 432  
 esp\_ble\_mesh\_cfg\_default\_ttl\_status\_cb\_t::src esp\_ble\_mesh\_cfg\_heartbeat\_pub\_set\_t::net\_idx  
 (C++ member), 433 (C++ member), 432  
 esp\_ble\_mesh\_cfg\_friend\_set\_t (C++ esp\_ble\_mesh\_cfg\_heartbeat\_pub\_set\_t::period  
 struct), 425 (C++ member), 432  
 esp\_ble\_mesh\_cfg\_friend\_set\_t::friend\_status esp\_ble\_mesh\_cfg\_heartbeat\_pub\_set\_t::ttl  
 (C++ member), 425 (C++ member), 432  
 esp\_ble\_mesh\_cfg\_friend\_status\_cb\_t esp\_ble\_mesh\_cfg\_heartbeat\_sub\_set\_t  
 (C++ struct), 436 (C++ struct), 432  
 esp\_ble\_mesh\_cfg\_friend\_status\_cb\_t::friend\_status esp\_ble\_mesh\_cfg\_heartbeat\_sub\_set\_t::dst  
 (C++ member), 436 (C++ member), 432  
 esp\_ble\_mesh\_cfg\_gatt\_proxy\_set\_t esp\_ble\_mesh\_cfg\_heartbeat\_sub\_set\_t::period  
 (C++ struct), 425 (C++ member), 433  
 esp\_ble\_mesh\_cfg\_gatt\_proxy\_set\_t::gatt\_proxy esp\_ble\_mesh\_cfg\_heartbeat\_sub\_set\_t::src  
 (C++ member), 425 (C++ member), 432  
 esp\_ble\_mesh\_cfg\_gatt\_proxy\_status\_cb\_t esp\_ble\_mesh\_cfg\_kr\_phase\_get\_t (C++  
 (C++ struct), 433 struct), 424  
 esp\_ble\_mesh\_cfg\_gatt\_proxy\_status\_cb\_t::gatt\_proxy esp\_ble\_mesh\_cfg\_kr\_phase\_get\_t::net\_idx  
 (C++ member), 433 (C++ member), 424  
 esp\_ble\_mesh\_cfg\_hb\_pub\_status\_cb\_t esp\_ble\_mesh\_cfg\_kr\_phase\_set\_t (C++  
 (C++ struct), 436 struct), 431  
 esp\_ble\_mesh\_cfg\_hb\_pub\_status\_cb\_t::count esp\_ble\_mesh\_cfg\_kr\_phase\_set\_t::net\_idx  
 (C++ member), 436 (C++ member), 432  
 esp\_ble\_mesh\_cfg\_hb\_pub\_status\_cb\_t::dst esp\_ble\_mesh\_cfg\_kr\_phase\_set\_t::transition  
 (C++ member), 436 (C++ member), 432  
 esp\_ble\_mesh\_cfg\_hb\_pub\_status\_cb\_t::feature esp\_ble\_mesh\_cfg\_kr\_phase\_status\_cb\_t  
 (C++ member), 436 (C++ struct), 439  
 esp\_ble\_mesh\_cfg\_hb\_pub\_status\_cb\_t::net\_idx esp\_ble\_mesh\_cfg\_kr\_phase\_status\_cb\_t::net\_idx  
 (C++ member), 436 (C++ member), 439

esp\_ble\_mesh\_cfg\_kr\_phase\_status\_cb\_t: esp\_ble\_mesh\_cfg\_model\_pub\_get\_t (C++  
 (C++ member), 439 (C++ struct), 422  
 esp\_ble\_mesh\_cfg\_kr\_phase\_status\_cb\_t: esp\_ble\_mesh\_cfg\_model\_pub\_get\_t::company\_id  
 (C++ member), 439 (C++ member), 422  
 esp\_ble\_mesh\_cfg\_lpn\_polltimeout\_get\_t esp\_ble\_mesh\_cfg\_model\_pub\_get\_t::element\_addr  
 (C++ struct), 424 (C++ member), 422  
 esp\_ble\_mesh\_cfg\_lpn\_polltimeout\_get\_t: esp\_ble\_mesh\_cfg\_model\_pub\_get\_t::model\_id  
 (C++ member), 424 (C++ member), 422  
 esp\_ble\_mesh\_cfg\_lpn\_pollto\_status\_cb\_t esp\_ble\_mesh\_cfg\_model\_pub\_set\_t (C++  
 (C++ struct), 439 (C++ struct), 426  
 esp\_ble\_mesh\_cfg\_lpn\_pollto\_status\_cb\_t: esp\_ble\_mesh\_cfg\_model\_pub\_set\_t::company\_id  
 (C++ member), 439 (C++ member), 427  
 esp\_ble\_mesh\_cfg\_lpn\_pollto\_status\_cb\_t: esp\_ble\_mesh\_cfg\_model\_pub\_set\_t::cred\_flag  
 (C++ member), 440 (C++ member), 426  
 esp\_ble\_mesh\_cfg\_mod\_app\_status\_cb\_t esp\_ble\_mesh\_cfg\_model\_pub\_set\_t::element\_addr  
 (C++ struct), 435 (C++ member), 426  
 esp\_ble\_mesh\_cfg\_mod\_app\_status\_cb\_t: esp\_ble\_mesh\_cfg\_model\_pub\_set\_t::model\_id  
 (C++ member), 436 (C++ member), 427  
 esp\_ble\_mesh\_cfg\_mod\_app\_status\_cb\_t: esp\_ble\_mesh\_cfg\_model\_pub\_set\_t::publish\_addr  
 (C++ member), 436 (C++ member), 426  
 esp\_ble\_mesh\_cfg\_mod\_app\_status\_cb\_t: esp\_ble\_mesh\_cfg\_model\_pub\_set\_t::publish\_app\_idx  
 (C++ member), 436 (C++ member), 426  
 esp\_ble\_mesh\_cfg\_mod\_app\_status\_cb\_t: esp\_ble\_mesh\_cfg\_model\_pub\_set\_t::publish\_period  
 (C++ member), 436 (C++ member), 426  
 esp\_ble\_mesh\_cfg\_mod\_app\_status\_cb\_t: status esp\_ble\_mesh\_cfg\_model\_pub\_set\_t::publish\_retrans  
 (C++ member), 436 (C++ member), 427  
 esp\_ble\_mesh\_cfg\_model\_app\_bind\_t esp\_ble\_mesh\_cfg\_model\_pub\_set\_t::publish\_ttl  
 (C++ struct), 426 (C++ member), 426  
 esp\_ble\_mesh\_cfg\_model\_app\_bind\_t: company\_id esp\_ble\_mesh\_cfg\_model\_pub\_status\_cb\_t  
 (C++ member), 426 (C++ struct), 434  
 esp\_ble\_mesh\_cfg\_model\_app\_bind\_t: element\_addr esp\_ble\_mesh\_cfg\_model\_pub\_status\_cb\_t::app\_idx  
 (C++ member), 426 (C++ member), 434  
 esp\_ble\_mesh\_cfg\_model\_app\_bind\_t: model\_id esp\_ble\_mesh\_cfg\_model\_pub\_status\_cb\_t::company\_id  
 (C++ member), 426 (C++ member), 434  
 esp\_ble\_mesh\_cfg\_model\_app\_bind\_t: model\_id esp\_ble\_mesh\_cfg\_model\_pub\_status\_cb\_t::cred\_flag  
 (C++ member), 426 (C++ member), 434  
 esp\_ble\_mesh\_cfg\_model\_app\_list\_cb\_t esp\_ble\_mesh\_cfg\_model\_pub\_status\_cb\_t::element\_a  
 (C++ struct), 439 (C++ member), 434  
 esp\_ble\_mesh\_cfg\_model\_app\_list\_cb\_t: app\_idx esp\_ble\_mesh\_cfg\_model\_pub\_status\_cb\_t::model\_id  
 (C++ member), 439 (C++ member), 434  
 esp\_ble\_mesh\_cfg\_model\_app\_list\_cb\_t: company\_id esp\_ble\_mesh\_cfg\_model\_pub\_status\_cb\_t::period  
 (C++ member), 439 (C++ member), 434  
 esp\_ble\_mesh\_cfg\_model\_app\_list\_cb\_t: element\_addr esp\_ble\_mesh\_cfg\_model\_pub\_status\_cb\_t::publish\_a  
 (C++ member), 439 (C++ member), 434  
 esp\_ble\_mesh\_cfg\_model\_app\_list\_cb\_t: esp\_ble\_mesh\_cfg\_model\_pub\_status\_cb\_t::status  
 (C++ member), 439 (C++ member), 434  
 esp\_ble\_mesh\_cfg\_model\_app\_list\_cb\_t: status esp\_ble\_mesh\_cfg\_model\_pub\_status\_cb\_t::transmit  
 (C++ member), 439 (C++ member), 434  
 esp\_ble\_mesh\_cfg\_model\_app\_unbind\_t esp\_ble\_mesh\_cfg\_model\_pub\_status\_cb\_t::ttl  
 (C++ struct), 431 (C++ member), 434  
 esp\_ble\_mesh\_cfg\_model\_app\_unbind\_t: company\_id esp\_ble\_mesh\_cfg\_model\_pub\_va\_set\_t  
 (C++ member), 431 (C++ struct), 429  
 esp\_ble\_mesh\_cfg\_model\_app\_unbind\_t: element\_addr esp\_ble\_mesh\_cfg\_model\_pub\_va\_set\_t::company\_id  
 (C++ member), 431 (C++ member), 429  
 esp\_ble\_mesh\_cfg\_model\_app\_unbind\_t: model\_id esp\_ble\_mesh\_cfg\_model\_pub\_va\_set\_t::cred\_flag  
 (C++ member), 431 (C++ member), 429  
 esp\_ble\_mesh\_cfg\_model\_app\_unbind\_t: model\_id esp\_ble\_mesh\_cfg\_model\_pub\_va\_set\_t::element\_addr  
 (C++ member), 431 (C++ member), 429

esp\_ble\_mesh\_cfg\_model\_pub\_va\_set\_t::label\_uid esp\_ble\_mesh\_cfg\_model\_sub\_overwrite\_t::model\_id  
 (C++ member), 429 (C++ member), 428  
 esp\_ble\_mesh\_cfg\_model\_pub\_va\_set\_t::model\_id esp\_ble\_mesh\_cfg\_model\_sub\_overwrite\_t::sub\_addr  
 (C++ member), 429 (C++ member), 428  
 esp\_ble\_mesh\_cfg\_model\_pub\_va\_set\_t::pub\_addr esp\_ble\_mesh\_cfg\_model\_sub\_status\_cb\_t  
 (C++ member), 429 (C++ struct), 434  
 esp\_ble\_mesh\_cfg\_model\_pub\_va\_set\_t::pub\_addr esp\_ble\_mesh\_cfg\_model\_sub\_status\_cb\_t::company\_id  
 (C++ member), 429 (C++ member), 435  
 esp\_ble\_mesh\_cfg\_model\_pub\_va\_set\_t::pub\_addr esp\_ble\_mesh\_cfg\_model\_sub\_status\_cb\_t::element\_addr  
 (C++ member), 429 (C++ member), 435  
 esp\_ble\_mesh\_cfg\_model\_pub\_va\_set\_t::pub\_addr esp\_ble\_mesh\_cfg\_model\_sub\_status\_cb\_t::model\_id  
 (C++ member), 429 (C++ member), 435  
 esp\_ble\_mesh\_cfg\_model\_sub\_add\_t (C++ esp\_ble\_mesh\_cfg\_model\_sub\_status\_cb\_t::status  
 struct), 427 (C++ member), 435  
 esp\_ble\_mesh\_cfg\_model\_sub\_add\_t::company\_id esp\_ble\_mesh\_cfg\_model\_sub\_status\_cb\_t::sub\_addr  
 (C++ member), 427 (C++ member), 435  
 esp\_ble\_mesh\_cfg\_model\_sub\_add\_t::element\_addr esp\_ble\_mesh\_cfg\_model\_sub\_va\_add\_t  
 (C++ member), 427 (C++ struct), 428  
 esp\_ble\_mesh\_cfg\_model\_sub\_add\_t::model\_id esp\_ble\_mesh\_cfg\_model\_sub\_va\_add\_t::company\_id  
 (C++ member), 427 (C++ member), 428  
 esp\_ble\_mesh\_cfg\_model\_sub\_add\_t::sub\_addr esp\_ble\_mesh\_cfg\_model\_sub\_va\_add\_t::element\_addr  
 (C++ member), 427 (C++ member), 428  
 esp\_ble\_mesh\_cfg\_model\_sub\_delete\_all\_t esp\_ble\_mesh\_cfg\_model\_sub\_va\_add\_t::label\_uid  
 (C++ struct), 430 (C++ member), 428  
 esp\_ble\_mesh\_cfg\_model\_sub\_delete\_all\_t::company\_id esp\_ble\_mesh\_cfg\_model\_sub\_va\_add\_t::model\_id  
 (C++ member), 430 (C++ member), 428  
 esp\_ble\_mesh\_cfg\_model\_sub\_delete\_all\_t::element\_addr esp\_ble\_mesh\_cfg\_model\_sub\_va\_delete\_t  
 (C++ member), 430 (C++ struct), 428  
 esp\_ble\_mesh\_cfg\_model\_sub\_delete\_all\_t::model\_id esp\_ble\_mesh\_cfg\_model\_sub\_va\_delete\_t::company\_id  
 (C++ member), 430 (C++ member), 428  
 esp\_ble\_mesh\_cfg\_model\_sub\_delete\_t esp\_ble\_mesh\_cfg\_model\_sub\_va\_delete\_t::element\_addr  
 (C++ struct), 427 (C++ member), 428  
 esp\_ble\_mesh\_cfg\_model\_sub\_delete\_t::company\_id esp\_ble\_mesh\_cfg\_model\_sub\_va\_delete\_t::label\_uid  
 (C++ member), 427 (C++ member), 428  
 esp\_ble\_mesh\_cfg\_model\_sub\_delete\_t::element\_addr esp\_ble\_mesh\_cfg\_model\_sub\_va\_delete\_t::model\_id  
 (C++ member), 427 (C++ member), 428  
 esp\_ble\_mesh\_cfg\_model\_sub\_delete\_t::model\_id esp\_ble\_mesh\_cfg\_model\_sub\_va\_overwrite\_t  
 (C++ member), 427 (C++ struct), 428  
 esp\_ble\_mesh\_cfg\_model\_sub\_delete\_t::sub\_addr esp\_ble\_mesh\_cfg\_model\_sub\_va\_overwrite\_t::company\_id  
 (C++ member), 427 (C++ member), 429  
 esp\_ble\_mesh\_cfg\_model\_sub\_list\_cb\_t esp\_ble\_mesh\_cfg\_model\_sub\_va\_overwrite\_t::element\_addr  
 (C++ struct), 437 (C++ member), 429  
 esp\_ble\_mesh\_cfg\_model\_sub\_list\_cb\_t::company\_id esp\_ble\_mesh\_cfg\_model\_sub\_va\_overwrite\_t::label\_uid  
 (C++ member), 438 (C++ member), 429  
 esp\_ble\_mesh\_cfg\_model\_sub\_list\_cb\_t::element\_addr esp\_ble\_mesh\_cfg\_model\_sub\_va\_overwrite\_t::model\_id  
 (C++ member), 438 (C++ member), 429  
 esp\_ble\_mesh\_cfg\_model\_sub\_list\_cb\_t::model\_id esp\_ble\_mesh\_cfg\_net\_key\_add\_t (C++  
 struct), 425  
 esp\_ble\_mesh\_cfg\_model\_sub\_list\_cb\_t::status esp\_ble\_mesh\_cfg\_net\_key\_add\_t::net\_idx  
 (C++ member), 437 (C++ member), 425  
 esp\_ble\_mesh\_cfg\_model\_sub\_list\_cb\_t::sub\_addr esp\_ble\_mesh\_cfg\_net\_key\_add\_t::net\_key  
 (C++ member), 438 (C++ member), 425  
 esp\_ble\_mesh\_cfg\_model\_sub\_overwrite\_t esp\_ble\_mesh\_cfg\_net\_key\_delete\_t  
 (C++ struct), 427 (C++ struct), 430  
 esp\_ble\_mesh\_cfg\_model\_sub\_overwrite\_t::company\_id esp\_ble\_mesh\_cfg\_net\_key\_delete\_t::net\_idx  
 (C++ member), 428 (C++ member), 430  
 esp\_ble\_mesh\_cfg\_model\_sub\_overwrite\_t::element\_addr esp\_ble\_mesh\_cfg\_net\_key\_list\_cb\_t  
 (C++ member), 428 (C++ struct), 438





- member), 421  
 esp\_ble\_mesh\_cfg\_srv\_t::count (C++ member), 421  
 esp\_ble\_mesh\_cfg\_srv\_t::default\_ttl (C++ member), 421  
 esp\_ble\_mesh\_cfg\_srv\_t::dst (C++ member), 421  
 esp\_ble\_mesh\_cfg\_srv\_t::expiry (C++ member), 422  
 esp\_ble\_mesh\_cfg\_srv\_t::feature (C++ member), 421  
 esp\_ble\_mesh\_cfg\_srv\_t::friend\_state (C++ member), 421  
 esp\_ble\_mesh\_cfg\_srv\_t::gatt\_proxy (C++ member), 421  
 esp\_ble\_mesh\_cfg\_srv\_t::heartbeat\_pub (C++ member), 421  
 esp\_ble\_mesh\_cfg\_srv\_t::heartbeat\_recv (C++ member), 422  
 esp\_ble\_mesh\_cfg\_srv\_t::heartbeat\_sub (C++ member), 422  
 esp\_ble\_mesh\_cfg\_srv\_t::max\_hops (C++ member), 422  
 esp\_ble\_mesh\_cfg\_srv\_t::min\_hops (C++ member), 422  
 esp\_ble\_mesh\_cfg\_srv\_t::model (C++ member), 421  
 esp\_ble\_mesh\_cfg\_srv\_t::net\_idx (C++ member), 421  
 esp\_ble\_mesh\_cfg\_srv\_t::net\_transmit (C++ member), 421  
 esp\_ble\_mesh\_cfg\_srv\_t::period (C++ member), 421  
 esp\_ble\_mesh\_cfg\_srv\_t::relay (C++ member), 421  
 esp\_ble\_mesh\_cfg\_srv\_t::relay\_retransmit (C++ member), 421  
 esp\_ble\_mesh\_cfg\_srv\_t::src (C++ member), 422  
 esp\_ble\_mesh\_cfg\_srv\_t::timer (C++ member), 421  
 esp\_ble\_mesh\_cfg\_srv\_t::ttl (C++ member), 421  
 ESP\_BLE\_MESH\_CFG\_STATUS\_CANNOT\_BIND (C macro), 370  
 ESP\_BLE\_MESH\_CFG\_STATUS\_CANNOT\_GET (C macro), 370  
 ESP\_BLE\_MESH\_CFG\_STATUS\_CANNOT\_REMOVE (C macro), 370  
 ESP\_BLE\_MESH\_CFG\_STATUS\_CANNOT\_SET (C macro), 370  
 ESP\_BLE\_MESH\_CFG\_STATUS\_CANNOT\_UPDATE (C macro), 370  
 ESP\_BLE\_MESH\_CFG\_STATUS\_FEATURE\_NOT\_SUPPORTED (C macro), 370  
 ESP\_BLE\_MESH\_CFG\_STATUS\_INSUFFICIENT\_RESOURCES (C macro), 370  
 ESP\_BLE\_MESH\_CFG\_STATUS\_INVALID\_ADDRESS (C macro), 369  
 ESP\_BLE\_MESH\_CFG\_STATUS\_INVALID\_APPKEY (C macro), 370  
 ESP\_BLE\_MESH\_CFG\_STATUS\_INVALID\_BEARER (C macro), 370  
 ESP\_BLE\_MESH\_CFG\_STATUS\_INVALID\_BINDING (C macro), 370  
 ESP\_BLE\_MESH\_CFG\_STATUS\_INVALID\_MODEL (C macro), 370  
 ESP\_BLE\_MESH\_CFG\_STATUS\_INVALID\_NETKEY (C macro), 370  
 ESP\_BLE\_MESH\_CFG\_STATUS\_INVALID\_PATH\_ENTRY (C macro), 370  
 ESP\_BLE\_MESH\_CFG\_STATUS\_INVALID\_PUBLISH\_PARAMETER (C macro), 370  
 ESP\_BLE\_MESH\_CFG\_STATUS\_KEY\_INDEX\_ALREADY\_STORED (C macro), 370  
 ESP\_BLE\_MESH\_CFG\_STATUS\_NOT\_A\_SUBSCRIBE\_MODEL (C macro), 370  
 ESP\_BLE\_MESH\_CFG\_STATUS\_OBSOLETE\_INFO (C macro), 370  
 ESP\_BLE\_MESH\_CFG\_STATUS\_STORAGE\_FAILURE (C macro), 370  
 ESP\_BLE\_MESH\_CFG\_STATUS\_SUCCESS (C macro), 369  
 esp\_ble\_mesh\_cfg\_status\_t (C++ type), 382  
 ESP\_BLE\_MESH\_CFG\_STATUS\_TEMP\_UNABLE\_TO\_CHANGE\_STATE (C macro), 370  
 ESP\_BLE\_MESH\_CFG\_STATUS\_UNSPECIFIED\_ERROR (C macro), 370  
 esp\_ble\_mesh\_cfg\_vnd\_model\_app\_get\_t (C++ struct), 424  
 esp\_ble\_mesh\_cfg\_vnd\_model\_app\_get\_t::company\_id (C++ member), 424  
 esp\_ble\_mesh\_cfg\_vnd\_model\_app\_get\_t::element\_address (C++ member), 424  
 esp\_ble\_mesh\_cfg\_vnd\_model\_app\_get\_t::model\_id (C++ member), 424  
 esp\_ble\_mesh\_cfg\_vnd\_model\_sub\_get\_t (C++ struct), 423  
 esp\_ble\_mesh\_cfg\_vnd\_model\_sub\_get\_t::company\_id (C++ member), 423  
 esp\_ble\_mesh\_cfg\_vnd\_model\_sub\_get\_t::element\_address (C++ member), 423  
 esp\_ble\_mesh\_cfg\_vnd\_model\_sub\_get\_t::model\_id (C++ member), 423  
 ESP\_BLE\_MESH\_CID\_NVAL (C macro), 356  
 esp\_ble\_mesh\_client\_common\_param\_t (C++ struct), 353  
 esp\_ble\_mesh\_client\_common\_param\_t::ctx (C++ member), 353  
 esp\_ble\_mesh\_client\_common\_param\_t::model\_id (C++ member), 353  
 esp\_ble\_mesh\_client\_common\_param\_t::msg\_role (C++ member), 353  
 esp\_ble\_mesh\_client\_common\_param\_t::msg\_timeout (C++ member), 353  
 esp\_ble\_mesh\_client\_common\_param\_t::opcode

- (C++ member), 353
- esp\_ble\_mesh\_client\_model\_deinit (C++ function), 398
- esp\_ble\_mesh\_client\_model\_init (C++ function), 398
- esp\_ble\_mesh\_client\_model\_send\_msg (C++ function), 399
- esp\_ble\_mesh\_client\_op\_pair\_t (C++ struct), 352
- esp\_ble\_mesh\_client\_op\_pair\_t::cli\_op (C++ member), 352
- esp\_ble\_mesh\_client\_op\_pair\_t::status\_op (C++ member), 352
- esp\_ble\_mesh\_client\_t (C++ struct), 352
- esp\_ble\_mesh\_client\_t::internal\_data (C++ member), 353
- esp\_ble\_mesh\_client\_t::model (C++ member), 352
- esp\_ble\_mesh\_client\_t::msg\_role (C++ member), 353
- esp\_ble\_mesh\_client\_t::op\_pair (C++ member), 353
- esp\_ble\_mesh\_client\_t::op\_pair\_size (C++ member), 352
- esp\_ble\_mesh\_client\_t::publish\_status (C++ member), 353
- esp\_ble\_mesh\_client\_t::vendor\_data (C++ member), 353
- esp\_ble\_mesh\_comp\_1\_elem\_t (C++ struct), 687
- esp\_ble\_mesh\_comp\_1\_elem\_t::model\_items (C++ member), 687
- esp\_ble\_mesh\_comp\_1\_elem\_t::model\_items\_size (C++ member), 687
- esp\_ble\_mesh\_comp\_1\_elem\_t::num\_s (C++ member), 687
- esp\_ble\_mesh\_comp\_1\_elem\_t::num\_v (C++ member), 687
- esp\_ble\_mesh\_comp\_1\_register (C++ function), 686
- esp\_ble\_mesh\_comp\_1\_t (C++ struct), 687
- esp\_ble\_mesh\_comp\_1\_t::element\_count (C++ member), 687
- esp\_ble\_mesh\_comp\_1\_t::elements (C++ member), 687
- esp\_ble\_mesh\_comp\_t (C++ struct), 349
- esp\_ble\_mesh\_comp\_t::cid (C++ member), 349
- esp\_ble\_mesh\_comp\_t::element\_count (C++ member), 349
- esp\_ble\_mesh\_comp\_t::elements (C++ member), 349
- esp\_ble\_mesh\_comp\_t::pid (C++ member), 349
- esp\_ble\_mesh\_comp\_t::vid (C++ member), 349
- ESP\_BLE\_MESH\_CONDENSATION\_ERROR (C macro), 455
- ESP\_BLE\_MESH\_CONDENSATION\_WARNING (C macro), 455
- esp\_ble\_mesh\_config\_client\_get\_state (C++ function), 415
- esp\_ble\_mesh\_config\_client\_set\_state (C++ function), 415
- ESP\_BLE\_MESH\_CONFIGURATION\_ERROR (C macro), 455
- ESP\_BLE\_MESH\_CONFIGURATION\_WARNING (C macro), 455
- esp\_ble\_mesh\_deinit (C++ function), 393
- esp\_ble\_mesh\_deinit\_param\_t (C++ struct), 344
- esp\_ble\_mesh\_deinit\_param\_t::erase\_flash (C++ member), 344
- esp\_ble\_mesh\_dev\_add\_flag\_t (C++ type), 381
- esp\_ble\_mesh\_dev\_role\_t (C++ enum), 385
- esp\_ble\_mesh\_dev\_role\_t::ROLE\_FAST\_PROV (C++ enumerator), 385
- esp\_ble\_mesh\_dev\_role\_t::ROLE\_NODE (C++ enumerator), 385
- esp\_ble\_mesh\_dev\_role\_t::ROLE\_PROVISIONER (C++ enumerator), 385
- esp\_ble\_mesh\_device\_delete\_t (C++ struct), 349
- esp\_ble\_mesh\_device\_delete\_t::addr (C++ member), 350
- esp\_ble\_mesh\_device\_delete\_t::addr\_type (C++ member), 350
- esp\_ble\_mesh\_device\_delete\_t::flag (C++ member), 350
- esp\_ble\_mesh\_device\_delete\_t::uuid (C++ member), 350
- esp\_ble\_mesh\_device\_delete\_t::[anonymous] (C++ member), 350
- ESP\_BLE\_MESH\_DEVICE\_DROPPED\_ERROR (C macro), 456
- ESP\_BLE\_MESH\_DEVICE\_DROPPED\_WARNING (C macro), 456
- ESP\_BLE\_MESH\_DEVICE\_MOVED\_ERROR (C macro), 456
- ESP\_BLE\_MESH\_DEVICE\_MOVED\_WARNING (C macro), 456
- ESP\_BLE\_MESH\_DEVICE\_NAME\_MAX\_LEN (C macro), 355
- esp\_ble\_mesh\_df\_client\_cb\_event\_t (C++ enum), 643
- esp\_ble\_mesh\_df\_client\_cb\_event\_t::ESP\_BLE\_MESH\_DROPPED (C++ enumerator), 643
- esp\_ble\_mesh\_df\_client\_cb\_event\_t::ESP\_BLE\_MESH\_MOVED (C++ enumerator), 643
- esp\_ble\_mesh\_df\_client\_cb\_event\_t::ESP\_BLE\_MESH\_PROVISIONED (C++ enumerator), 643
- esp\_ble\_mesh\_df\_client\_cb\_event\_t::ESP\_BLE\_MESH\_STARTED (C++ enumerator), 643
- esp\_ble\_mesh\_df\_client\_cb\_event\_t::ESP\_BLE\_MESH\_STOPPED (C++ enumerator), 643



esp\_ble\_mesh\_df\_client\_cb\_event\_t::ESP\_BLE\_MESH\_DF\_CLIENT\_SEND\_EVT forwarding\_table  
 (C++ enumerator), 643 (C++ member), 619  
 esp\_ble\_mesh\_df\_client\_cb\_param\_t esp\_ble\_mesh\_df\_client\_rcv\_cb\_t::forwarding\_table  
 (C++ struct), 638 (C++ member), 619  
 esp\_ble\_mesh\_df\_client\_cb\_param\_t::param esp\_ble\_mesh\_df\_client\_rcv\_cb\_t::forwarding\_table  
 (C++ member), 638 (C++ member), 619  
 esp\_ble\_mesh\_df\_client\_cb\_param\_t::rcv esp\_ble\_mesh\_df\_client\_rcv\_cb\_t::forwarding\_table  
 (C++ member), 638 (C++ member), 619  
 esp\_ble\_mesh\_df\_client\_cb\_param\_t::send esp\_ble\_mesh\_df\_client\_rcv\_cb\_t::path\_disc\_timing  
 (C++ member), 638 (C++ member), 619  
 esp\_ble\_mesh\_df\_client\_cb\_param\_t::[anc esp\_ble\_mesh\_df\_client\_rcv\_cb\_t::path\_echo\_inter  
 (C++ member), 638 (C++ member), 619  
 esp\_ble\_mesh\_df\_client\_cb\_t (C++ type), esp\_ble\_mesh\_df\_client\_rcv\_cb\_t::path\_metric\_sta  
 643 (C++ member), 618  
 esp\_ble\_mesh\_df\_client\_get\_state (C++ esp\_ble\_mesh\_df\_client\_rcv\_cb\_t::rssi\_threshold  
 function), 616 (C++ member), 619  
 esp\_ble\_mesh\_df\_client\_get\_t (C++ esp\_ble\_mesh\_df\_client\_rcv\_cb\_t::two\_way\_path\_sta  
 union), 616 (C++ member), 619  
 esp\_ble\_mesh\_df\_client\_get\_t::directed esp\_ble\_mesh\_df\_client\_rcv\_cb\_t::wanted\_lanes\_sta  
 (C++ member), 616 (C++ member), 619  
 esp\_ble\_mesh\_df\_client\_get\_t::directed esp\_ble\_mesh\_df\_client\_send\_cb\_t (C++  
 (C++ member), 617 struct), 637  
 esp\_ble\_mesh\_df\_client\_get\_t::disc\_table esp\_ble\_mesh\_df\_client\_send\_cb\_t::err\_code  
 (C++ member), 617 (C++ member), 638  
 esp\_ble\_mesh\_df\_client\_get\_t::forwarding esp\_ble\_mesh\_df\_client\_set\_state (C++  
 (C++ member), 617 function), 616  
 esp\_ble\_mesh\_df\_client\_get\_t::forwarding esp\_ble\_mesh\_df\_client\_set\_t (C++  
 (C++ member), 617 union), 617  
 esp\_ble\_mesh\_df\_client\_get\_t::forwarding esp\_ble\_mesh\_df\_client\_set\_t::directed\_control\_se  
 (C++ member), 617 (C++ member), 617  
 esp\_ble\_mesh\_df\_client\_get\_t::path\_echo esp\_ble\_mesh\_df\_client\_set\_t::directed\_ctl\_net\_tr  
 (C++ member), 617 (C++ member), 618  
 esp\_ble\_mesh\_df\_client\_get\_t::path\_metric esp\_ble\_mesh\_df\_client\_set\_t::directed\_ctl\_relay  
 (C++ member), 616 (C++ member), 618  
 esp\_ble\_mesh\_df\_client\_get\_t::two\_way\_path esp\_ble\_mesh\_df\_client\_set\_t::directed\_net\_transm  
 (C++ member), 617 (C++ member), 618  
 esp\_ble\_mesh\_df\_client\_get\_t::wanted\_lanes esp\_ble\_mesh\_df\_client\_set\_t::directed\_pub\_policy  
 (C++ member), 617 (C++ member), 618  
 esp\_ble\_mesh\_df\_client\_rcv\_cb\_t (C++ esp\_ble\_mesh\_df\_client\_set\_t::directed\_relay\_retr  
 union), 618 (C++ member), 618  
 esp\_ble\_mesh\_df\_client\_rcv\_cb\_t::direct esp\_ble\_mesh\_df\_client\_set\_t::disc\_table\_caps\_set  
 (C++ member), 618 (C++ member), 617  
 esp\_ble\_mesh\_df\_client\_rcv\_cb\_t::direct esp\_ble\_mesh\_df\_transmits\_status::forwarding\_table\_ad  
 (C++ member), 619 (C++ member), 617  
 esp\_ble\_mesh\_df\_client\_rcv\_cb\_t::direct esp\_ble\_mesh\_df\_transmits\_status::forwarding\_table\_de  
 (C++ member), 619 (C++ member), 617  
 esp\_ble\_mesh\_df\_client\_rcv\_cb\_t::direct esp\_ble\_mesh\_df\_transmits\_status::forwarding\_table\_de  
 (C++ member), 619 (C++ member), 617  
 esp\_ble\_mesh\_df\_client\_rcv\_cb\_t::direct esp\_ble\_mesh\_df\_transmits\_status::forwarding\_table\_de  
 (C++ member), 619 (C++ member), 618  
 esp\_ble\_mesh\_df\_client\_rcv\_cb\_t::direct esp\_ble\_mesh\_df\_transmits\_status::path\_disc\_timing\_ct  
 (C++ member), 619 (C++ member), 618  
 esp\_ble\_mesh\_df\_client\_rcv\_cb\_t::direct esp\_ble\_mesh\_df\_transmits\_status::path\_echo\_interval  
 (C++ member), 619 (C++ member), 618  
 esp\_ble\_mesh\_df\_client\_rcv\_cb\_t::disc esp\_ble\_mesh\_df\_transmits\_status::path\_metric\_set  
 (C++ member), 618 (C++ member), 617  
 esp\_ble\_mesh\_df\_client\_rcv\_cb\_t::forward esp\_ble\_mesh\_df\_transmits\_status::rssi\_threshold\_set  
 (C++ member), 619 (C++ member), 618

esp\_ble\_mesh\_df\_client\_set\_t::two\_way\_path\_islet (C++ member), 618  
 esp\_ble\_mesh\_df\_client\_set\_t::wanted\_lane\_islet (C++ member), 618  
 esp\_ble\_mesh\_df\_server\_cb\_event\_t (C++ enum), 643  
 esp\_ble\_mesh\_df\_server\_cb\_event\_t::ESP\_BLE\_MESH\_DF\_SERVER\_EVT\_MAX (C++ enumerator), 644  
 esp\_ble\_mesh\_df\_server\_cb\_event\_t::ESP\_BLE\_MESH\_DF\_SERVER\_EVT\_TABLE\_CHANGE\_EVT (C++ enumerator), 643  
 esp\_ble\_mesh\_df\_server\_cb\_event\_t::ESP\_BLE\_MESH\_DF\_SERVER\_EVT\_TABLE\_CHANGE\_EVT (C++ member), 620  
 esp\_ble\_mesh\_df\_server\_cb\_param\_t (C++ struct), 639  
 esp\_ble\_mesh\_df\_server\_cb\_param\_t::ctx (C++ member), 639  
 esp\_ble\_mesh\_df\_server\_cb\_param\_t::model (C++ member), 639  
 esp\_ble\_mesh\_df\_server\_cb\_param\_t::value (C++ member), 639  
 esp\_ble\_mesh\_df\_server\_cb\_t (C++ type), 643  
 esp\_ble\_mesh\_df\_server\_cb\_value\_t (C++ union), 620  
 esp\_ble\_mesh\_df\_server\_cb\_value\_t::state\_change (C++ member), 620  
 esp\_ble\_mesh\_df\_server\_cb\_value\_t::table\_change (C++ member), 620  
 esp\_ble\_mesh\_df\_server\_state\_change\_t (C++ union), 620  
 esp\_ble\_mesh\_df\_server\_state\_change\_t::dummy (C++ member), 620  
 esp\_ble\_mesh\_df\_server\_table\_change\_t (C++ struct), 638  
 esp\_ble\_mesh\_df\_server\_table\_change\_t::action (C++ member), 621  
 esp\_ble\_mesh\_df\_server\_table\_change\_t::action (C++ member), 638  
 esp\_ble\_mesh\_df\_server\_table\_change\_t::bw\_path (C++ member), 621  
 esp\_ble\_mesh\_df\_server\_table\_change\_t::bw\_path (C++ member), 639  
 esp\_ble\_mesh\_df\_server\_table\_change\_t::dep\_or (C++ member), 620  
 esp\_ble\_mesh\_df\_server\_table\_change\_t::dep\_or (C++ member), 638  
 esp\_ble\_mesh\_df\_server\_table\_change\_t::dep\_or (C++ member), 643  
 esp\_ble\_mesh\_df\_server\_table\_change\_t::dep\_or (C++ member), 643  
 esp\_ble\_mesh\_df\_server\_table\_change\_t::dep\_or (C++ member), 643  
 esp\_ble\_mesh\_df\_server\_table\_change\_t::dep\_or (C++ member), 643  
 esp\_ble\_mesh\_df\_server\_table\_change\_t::df\_table (C++ member), 639  
 esp\_ble\_mesh\_df\_server\_table\_change\_t::df\_table (C++ member), 639  
 esp\_ble\_mesh\_df\_server\_table\_change\_t::df\_table (C++ member), 639  
 esp\_ble\_mesh\_df\_server\_table\_change\_t::dummy (C++ struct), 621  
 esp\_ble\_mesh\_df\_server\_table\_change\_t::dummy (C++ member), 639  
 esp\_ble\_mesh\_df\_server\_table\_change\_t::fixed (C++ member), 621  
 esp\_ble\_mesh\_df\_server\_table\_change\_t::fixed (C++ member), 638  
 esp\_ble\_mesh\_df\_server\_table\_change\_t::forward (C++ struct), 621  
 esp\_ble\_mesh\_df\_server\_table\_change\_t::forward (C++ member), 639  
 esp\_ble\_mesh\_df\_server\_table\_change\_t::lane\_count (C++ member), 639  
 esp\_ble\_mesh\_df\_server\_table\_change\_t::path\_not\_r (C++ member), 639  
 esp\_ble\_mesh\_df\_server\_table\_change\_t::path\_origi (C++ member), 638  
 esp\_ble\_mesh\_df\_server\_table\_change\_t::path\_targe (C++ member), 638  
 esp\_ble\_mesh\_df\_srv\_t::default\_rssi\_threshold (C++ member), 620  
 esp\_ble\_mesh\_df\_srv\_t::directed\_ctl\_net\_transmit (C++ member), 621  
 esp\_ble\_mesh\_df\_srv\_t::directed\_ctl\_relay\_retrans (C++ member), 621  
 esp\_ble\_mesh\_df\_srv\_t::directed\_friend\_paths (C++ member), 621  
 esp\_ble\_mesh\_df\_srv\_t::directed\_net\_transmit (C++ member), 620  
 esp\_ble\_mesh\_df\_srv\_t::directed\_node\_paths (C++ member), 620  
 esp\_ble\_mesh\_df\_srv\_t::directed\_proxy\_paths (C++ member), 621  
 esp\_ble\_mesh\_df\_srv\_t::directed\_relay\_paths (C++ member), 621  
 esp\_ble\_mesh\_df\_srv\_t::directed\_relay\_retransmit (C++ member), 620  
 esp\_ble\_mesh\_df\_srv\_t::lane\_disc\_guard\_interval (C++ member), 621  
 esp\_ble\_mesh\_df\_srv\_t::model (C++ member), 620  
 esp\_ble\_mesh\_df\_srv\_t::path\_disc\_interval (C++ member), 621  
 esp\_ble\_mesh\_df\_srv\_t::path\_disc\_retry\_interval (C++ member), 621  
 esp\_ble\_mesh\_df\_srv\_t::path\_monitor\_interval (C++ member), 621  
 esp\_ble\_mesh\_df\_srv\_t::rssi\_margin (C++ member), 620  
 esp\_ble\_mesh\_df\_table\_action\_t (C++ struct), 643  
 esp\_ble\_mesh\_df\_table\_action\_t::ESP\_BLE\_MESH\_DF\_T (C++ enumerator), 643  
 esp\_ble\_mesh\_df\_table\_action\_t::ESP\_BLE\_MESH\_DF\_T (C++ enumerator), 643  
 esp\_ble\_mesh\_df\_table\_action\_t::ESP\_BLE\_MESH\_DF\_T (C++ enumerator), 643  
 esp\_ble\_mesh\_df\_table\_action\_t::ESP\_BLE\_MESH\_DF\_T (C++ enumerator), 643  
 esp\_ble\_mesh\_df\_table\_action\_t::ESP\_BLE\_MESH\_DF\_T (C++ enumerator), 643  
 esp\_ble\_mesh\_directed\_control\_get\_t (C++ struct), 621  
 esp\_ble\_mesh\_directed\_control\_get\_t::net\_idx (C++ member), 621  
 esp\_ble\_mesh\_directed\_control\_set\_t (C++ struct), 621  
 esp\_ble\_mesh\_directed\_control\_set\_t::directed\_for

(C++ member), 621  
 esp\_ble\_mesh\_directed\_control\_set\_t::directed (C++ member), 627  
 (C++ member), 622  
 esp\_ble\_mesh\_directed\_control\_set\_t::directed (C++ struct), 635  
 (C++ member), 622  
 esp\_ble\_mesh\_directed\_control\_set\_t::directed (C++ member), 635  
 (C++ member), 622  
 esp\_ble\_mesh\_directed\_control\_set\_t::directed (C++ struct), 636  
 (C++ member), 621  
 esp\_ble\_mesh\_directed\_control\_set\_t::net\_idx (C++ member), 636  
 (C++ member), 621  
 esp\_ble\_mesh\_directed\_control\_status\_t (C++ struct), 629  
 esp\_ble\_mesh\_directed\_control\_status\_t::direct (C++ member), 636  
 (C++ member), 629  
 esp\_ble\_mesh\_directed\_control\_status\_t::direct (C++ member), 636  
 (C++ member), 630  
 esp\_ble\_mesh\_directed\_control\_status\_t::direct (C++ macro), 360  
 (C++ member), 630  
 esp\_ble\_mesh\_directed\_control\_status\_t::direct (C++ macro), 360  
 (C++ member), 630  
 esp\_ble\_mesh\_directed\_control\_status\_t::direct (C++ macro), 360  
 (C++ member), 629  
 esp\_ble\_mesh\_directed\_control\_status\_t::net\_idx (C++ member), 629  
 (C++ member), 629  
 esp\_ble\_mesh\_directed\_control\_status\_t::status (C macro), 360  
 (C++ member), 629  
 ESP\_BLE\_MESH\_DIRECTED\_CRED (C macro), 361  
 esp\_ble\_mesh\_directed\_ctl\_net\_transmit (C++ struct), 629  
 esp\_ble\_mesh\_directed\_ctl\_net\_transmit (C++ member), 629  
 esp\_ble\_mesh\_directed\_ctl\_net\_transmit (C++ struct), 637  
 esp\_ble\_mesh\_directed\_ctl\_net\_transmit (C++ member), 637  
 esp\_ble\_mesh\_directed\_ctl\_relay\_retransmit (C++ struct), 629  
 (C++ member), 629  
 esp\_ble\_mesh\_directed\_ctl\_relay\_retransmit (C++ member), 629  
 (C++ member), 629  
 esp\_ble\_mesh\_directed\_ctl\_relay\_retransmit (C++ struct), 637  
 (C++ member), 637  
 esp\_ble\_mesh\_directed\_ctl\_relay\_retransmit (C++ member), 637  
 (C++ member), 637  
 ESP\_BLE\_MESH\_DIRECTED\_FORWARDING\_DISABLED (C macro), 360  
 ESP\_BLE\_MESH\_DIRECTED\_FORWARDING\_ENABLED (C macro), 360  
 ESP\_BLE\_MESH\_DIRECTED\_FRIEND\_DISABLED (C macro), 360  
 ESP\_BLE\_MESH\_DIRECTED\_FRIEND\_ENABLED (C macro), 360  
 ESP\_BLE\_MESH\_DIRECTED\_FRIEND\_IGNORE (C macro), 360  
 ESP\_BLE\_MESH\_DIRECTED\_FRIEND\_NOT\_SUPPORTED (C macro), 360  
 esp\_ble\_mesh\_directed\_net\_transmit\_set (C++ struct), 627  
 esp\_ble\_mesh\_directed\_net\_transmit\_set\_t::net\_tra  
 (C++ member), 627  
 esp\_ble\_mesh\_directed\_net\_transmit\_status\_t  
 (C++ struct), 635  
 esp\_ble\_mesh\_directed\_net\_transmit\_status\_t::net\_  
 fault  
 esp\_ble\_mesh\_directed\_paths\_status\_t  
 (C++ struct), 636  
 esp\_ble\_mesh\_directed\_paths\_status\_t::directed\_fr  
 (C++ member), 636  
 esp\_ble\_mesh\_directed\_paths\_status\_t::directed\_no  
 (C++ member), 636  
 esp\_ble\_mesh\_directed\_paths\_status\_t::directed\_pr  
 (C++ member), 636  
 esp\_ble\_mesh\_directed\_paths\_status\_t::directed\_re  
 (C++ member), 636  
 ESP\_BLE\_MESH\_DIRECTED\_PROXY\_DISABLED (C  
 macro), 360  
 ESP\_BLE\_MESH\_DIRECTED\_PROXY\_ENABLED (C  
 macro), 360  
 ESP\_BLE\_MESH\_DIRECTED\_PROXY\_USE\_DEFAULT  
 (C macro), 360  
 ESP\_BLE\_MESH\_DIRECTED\_PROXY\_IGNORE (C  
 macro), 360  
 ESP\_BLE\_MESH\_DIRECTED\_PROXY\_NOT\_SUPPORTED  
 (C macro), 360  
 ESP\_BLE\_MESH\_DIRECTED\_PROXY\_USE\_DEF\_DISABLED  
 (C macro), 360  
 ESP\_BLE\_MESH\_DIRECTED\_PROXY\_USE\_DEF\_ENABLED  
 (C macro), 360  
 ESP\_BLE\_MESH\_DIRECTED\_PROXY\_USE\_DEF\_NOT\_SUPPORTED  
 (C macro), 360  
 ESP\_BLE\_MESH\_DIRECTED\_PROXY\_USE\_DEFAULT\_IGNORE  
 (C macro), 360  
 ESP\_BLE\_MESH\_DIRECTED\_PUB\_POLICY\_DIRECTED\_FORWARD  
 (C macro), 642  
 ESP\_BLE\_MESH\_DIRECTED\_PUB\_POLICY\_FLOODING  
 (C macro), 360  
 ESP\_BLE\_MESH\_DIRECTED\_PUB\_POLICY\_FORWARD  
 (C macro), 361  
 ESP\_BLE\_MESH\_DIRECTED\_PUB\_POLICY\_MANAGED\_FLOODING  
 (C macro), 642  
 esp\_ble\_mesh\_directed\_public\_key\_status\_t  
 (C++ struct), 636  
 esp\_ble\_mesh\_directed\_public\_key\_status\_t::compan  
 (C++ member), 637  
 esp\_ble\_mesh\_directed\_public\_key\_status\_t::direct  
 (C++ member), 636  
 esp\_ble\_mesh\_directed\_public\_key\_status\_t::elemen  
 (C++ member), 637  
 esp\_ble\_mesh\_directed\_public\_key\_status\_t::model\_  
 (C++ member), 637  
 esp\_ble\_mesh\_directed\_public\_key\_status\_t::status  
 (C++ member), 636  
 esp\_ble\_mesh\_directed\_publish\_policy\_get\_t  
 (C++ struct), 628  
 esp\_ble\_mesh\_directed\_publish\_policy\_get\_t::compa  
 (C++ member), 628  
 esp\_ble\_mesh\_directed\_publish\_policy\_get\_t::elemen  
 (C++ member), 628

---

esp\_ble\_mesh\_directed\_publish\_policy\_get\_esp\_ble\_mesh\_element\_not\_calibrated\_error  
 (C++ member), 628 (C macro), 455

esp\_ble\_mesh\_directed\_publish\_policy\_set\_esp\_ble\_mesh\_element\_not\_calibrated\_warning  
 (C++ struct), 628 (C macro), 455

esp\_ble\_mesh\_directed\_publish\_policy\_set\_esp\_ble\_mesh\_empty\_error (C macro), 456  
 (C++ member), 628 ESP\_BLE\_MESH\_EMPTY\_WARNING (C macro), 456

esp\_ble\_mesh\_directed\_publish\_policy\_set\_esp\_ble\_mesh\_ext\_model\_item\_t  
 (C++ member), 628 (C++ struct), 686

esp\_ble\_mesh\_directed\_publish\_policy\_set\_esp\_ble\_mesh\_ext\_model\_item\_t::element\_offset  
 (C++ member), 628 (C++ member), 686

esp\_ble\_mesh\_directed\_publish\_policy\_set\_esp\_ble\_mesh\_ext\_model\_item\_t::long\_fmt  
 (C++ member), 628 (C++ member), 686

ESP\_BLE\_MESH\_DIRECTED\_RELAY\_DISABLED esp\_ble\_mesh\_extended\_model\_item\_t::model\_item\_id  
 (C macro), 360 (C++ member), 686

ESP\_BLE\_MESH\_DIRECTED\_RELAY\_ENABLED (C esp\_ble\_mesh\_extended\_model\_item\_t::[anonymous]  
 macro), 360 (C++ member), 686

esp\_ble\_mesh\_directed\_relay\_retransmit\_esp\_ble\_mesh\_fast\_prov\_action\_t (C++  
 (C++ struct), 627 enum), 385

esp\_ble\_mesh\_directed\_relay\_retransmit\_esp\_ble\_mesh\_fast\_prov\_action\_t::FAST\_PROV\_ACT\_EN  
 (C++ member), 628 (C++ enumerator), 385

esp\_ble\_mesh\_directed\_relay\_retransmit\_esp\_ble\_mesh\_fast\_prov\_action\_t::FAST\_PROV\_ACT\_EX  
 (C++ struct), 636 (C++ enumerator), 385

esp\_ble\_mesh\_directed\_relay\_retransmit\_esp\_ble\_mesh\_fast\_prov\_action\_t::FAST\_PROV\_ACT\_MA  
 (C++ member), 636 (C++ enumerator), 385

esp\_ble\_mesh\_discovery\_table\_caps\_get\_esp\_ble\_mesh\_fast\_prov\_action\_t::FAST\_PROV\_ACT\_NO  
 (C++ struct), 622 (C++ enumerator), 385

esp\_ble\_mesh\_discovery\_table\_caps\_get\_esp\_ble\_mesh\_fast\_prov\_action\_t::FAST\_PROV\_ACT\_SU  
 (C++ member), 622 (C++ enumerator), 385

esp\_ble\_mesh\_discovery\_table\_caps\_set\_esp\_ble\_mesh\_fast\_prov\_info\_t (C++  
 (C++ struct), 622 struct), 351

esp\_ble\_mesh\_discovery\_table\_caps\_set\_esp\_ble\_mesh\_fast\_prov\_info\_t::flags  
 (C++ member), 623 (C++ member), 351

esp\_ble\_mesh\_discovery\_table\_caps\_set\_esp\_ble\_mesh\_fast\_prov\_info\_t::iv\_index  
 (C++ member), 623 (C++ member), 352

esp\_ble\_mesh\_discovery\_table\_caps\_status\_esp\_ble\_mesh\_fast\_prov\_info\_t::match\_len  
 (C++ struct), 630 (C++ member), 352

esp\_ble\_mesh\_discovery\_table\_caps\_status\_esp\_ble\_mesh\_fast\_prov\_info\_t::match\_val  
 (C++ member), 630 (C++ member), 352

esp\_ble\_mesh\_discovery\_table\_caps\_status\_esp\_ble\_mesh\_fast\_prov\_info\_t::net\_idx  
 (C++ member), 630 (C++ member), 351

esp\_ble\_mesh\_discovery\_table\_caps\_status\_esp\_ble\_mesh\_fast\_prov\_info\_t::offset  
 (C++ member), 630 (C++ member), 352

esp\_ble\_mesh\_discovery\_table\_caps\_status\_esp\_ble\_mesh\_fast\_prov\_info\_t::unicast\_max  
 (C++ member), 630 (C++ member), 351

esp\_ble\_mesh\_discovery\_table\_caps\_status\_esp\_ble\_mesh\_fast\_prov\_info\_t::unicast\_min  
 (C++ member), 630 (C++ member), 351

esp\_ble\_mesh\_elem\_t (C++ struct), 344

esp\_ble\_mesh\_elem\_t::element\_addr  
 (C++ member), 344

esp\_ble\_mesh\_elem\_t::location (C++  
 member), 344

esp\_ble\_mesh\_elem\_t::sig\_model\_count  
 (C++ member), 344

esp\_ble\_mesh\_elem\_t::sig\_models (C++  
 member), 344

esp\_ble\_mesh\_elem\_t::vnd\_model\_count  
 (C++ member), 344

esp\_ble\_mesh\_elem\_t::vnd\_models (C++  
 member), 345

ESP\_BLE\_MESH\_ELEMENT (C macro), 359

esp\_ble\_mesh\_fast\_prov\_info\_t::unicast\_max  
 (C++ member), 351

esp\_ble\_mesh\_fast\_prov\_info\_t::unicast\_min  
 (C++ member), 351

ESP\_BLE\_MESH\_FEATURE\_ALL\_SUPPORTED (C  
 macro), 358

ESP\_BLE\_MESH\_FEATURE\_FRIEND (C macro),  
 358

ESP\_BLE\_MESH\_FEATURE\_LOW\_POWER (C  
 macro), 358

ESP\_BLE\_MESH\_FEATURE\_PROXY (C macro), 358

ESP\_BLE\_MESH\_FEATURE\_RELAY (C macro), 358

esp\_ble\_mesh\_find\_element (C++ function),  
 394

esp\_ble\_mesh\_find\_sig\_model (C++ func-  
 tion), 395







(*C macro*), 357  
 esp\_ble\_mesh\_gen\_admin\_prop\_access\_t (*C++ enum*), 497  
 esp\_ble\_mesh\_gen\_admin\_prop\_access\_t::ESP\_BLE\_MESH\_GEN\_ADMIN\_ACCESS\_READ (*C++ enumerator*), 497  
 esp\_ble\_mesh\_gen\_admin\_prop\_access\_t::ESP\_BLE\_MESH\_GEN\_ADMIN\_ACCESS\_READ\_WRITE (*C++ enumerator*), 497  
 esp\_ble\_mesh\_gen\_admin\_prop\_access\_t::ESP\_BLE\_MESH\_GEN\_ADMIN\_ACCESS\_WRITE (*C++ enumerator*), 497  
 esp\_ble\_mesh\_gen\_admin\_prop\_access\_t::ESP\_BLE\_MESH\_GEN\_ADMIN\_NOT\_USERS\_PROP (*C++ enumerator*), 497  
 esp\_ble\_mesh\_gen\_admin\_prop\_srv\_t (*C++ struct*), 481  
 esp\_ble\_mesh\_gen\_admin\_prop\_srv\_t::model (*C++ member*), 481  
 esp\_ble\_mesh\_gen\_admin\_prop\_srv\_t::property\_id (*C++ member*), 481  
 esp\_ble\_mesh\_gen\_admin\_prop\_srv\_t::property\_name (*C++ member*), 481  
 esp\_ble\_mesh\_gen\_admin\_prop\_srv\_t::rsp\_ctrl (*C++ member*), 481  
 esp\_ble\_mesh\_gen\_admin\_properties\_status\_cb\_t (*C++ struct*), 473  
 esp\_ble\_mesh\_gen\_admin\_properties\_status\_cb\_t::property\_id (*C++ member*), 473  
 esp\_ble\_mesh\_gen\_admin\_property\_get\_t (*C++ struct*), 468  
 esp\_ble\_mesh\_gen\_admin\_property\_get\_t::property\_id (*C++ member*), 468  
 esp\_ble\_mesh\_gen\_admin\_property\_set\_t (*C++ struct*), 468  
 esp\_ble\_mesh\_gen\_admin\_property\_set\_t::property\_id (*C++ member*), 468  
 esp\_ble\_mesh\_gen\_admin\_property\_set\_t::property\_name (*C++ member*), 468  
 esp\_ble\_mesh\_gen\_admin\_property\_set\_t::property\_value (*C++ member*), 468  
 esp\_ble\_mesh\_gen\_admin\_property\_set\_t::rsp\_ctrl (*C++ member*), 468  
 esp\_ble\_mesh\_gen\_admin\_property\_status\_cb\_t (*C++ struct*), 473  
 esp\_ble\_mesh\_gen\_admin\_property\_status\_cb\_t::admin\_property\_id (*C++ member*), 473  
 esp\_ble\_mesh\_gen\_admin\_property\_status\_cb\_t::property\_id (*C++ member*), 473  
 esp\_ble\_mesh\_gen\_admin\_property\_status\_cb\_t::property\_name (*C++ member*), 473  
 esp\_ble\_mesh\_gen\_admin\_property\_status\_cb\_t::property\_value (*C++ member*), 473  
 esp\_ble\_mesh\_gen\_admin\_property\_status\_cb\_t::user\_message (*C++ member*), 473  
 esp\_ble\_mesh\_gen\_battery\_srv\_t (*C++ struct*), 479  
 esp\_ble\_mesh\_gen\_battery\_srv\_t::model (*C++ member*), 479  
 esp\_ble\_mesh\_gen\_battery\_srv\_t::rsp\_ctrl (*C++ member*), 479  
 esp\_ble\_mesh\_gen\_battery\_srv\_t::state (*C++ member*), 479  
 esp\_ble\_mesh\_gen\_battery\_state\_t (*C++ struct*), 479  
 esp\_ble\_mesh\_gen\_battery\_state\_t::battery\_level (*C++ member*), 479  
 esp\_ble\_mesh\_gen\_battery\_state\_t::battery\_status (*C++ member*), 479  
 esp\_ble\_mesh\_gen\_battery\_state\_t::time\_to\_charge (*C++ member*), 479  
 esp\_ble\_mesh\_gen\_battery\_state\_t::time\_to\_discharge (*C++ member*), 479  
 esp\_ble\_mesh\_gen\_client\_prop\_srv\_t (*C++ struct*), 482  
 esp\_ble\_mesh\_gen\_client\_prop\_srv\_t::id\_count (*C++ member*), 482  
 esp\_ble\_mesh\_gen\_client\_prop\_srv\_t::model (*C++ member*), 482  
 esp\_ble\_mesh\_gen\_client\_prop\_srv\_t::property\_ids (*C++ member*), 482  
 esp\_ble\_mesh\_gen\_client\_prop\_srv\_t::rsp\_ctrl (*C++ member*), 482  
 esp\_ble\_mesh\_gen\_client\_properties\_get\_t (*C++ struct*), 469  
 esp\_ble\_mesh\_gen\_client\_properties\_get\_t::property\_id (*C++ member*), 469  
 esp\_ble\_mesh\_gen\_client\_properties\_status\_cb\_t (*C++ struct*), 474  
 esp\_ble\_mesh\_gen\_client\_properties\_status\_cb\_t::property\_id (*C++ member*), 474  
 esp\_ble\_mesh\_gen\_client\_status\_cb\_t (*C++ union*), 460  
 esp\_ble\_mesh\_gen\_client\_status\_cb\_t::admin\_property\_id (*C++ member*), 461  
 esp\_ble\_mesh\_gen\_client\_status\_cb\_t::admin\_property\_name (*C++ member*), 461  
 esp\_ble\_mesh\_gen\_client\_status\_cb\_t::battery\_status (*C++ member*), 461  
 esp\_ble\_mesh\_gen\_client\_status\_cb\_t::client\_property\_id (*C++ member*), 461  
 esp\_ble\_mesh\_gen\_client\_status\_cb\_t::def\_trans\_time (*C++ member*), 460  
 esp\_ble\_mesh\_gen\_client\_status\_cb\_t::level\_status (*C++ member*), 460  
 esp\_ble\_mesh\_gen\_client\_status\_cb\_t::location\_global (*C++ member*), 461  
 esp\_ble\_mesh\_gen\_client\_status\_cb\_t::location\_local (*C++ member*), 461  
 esp\_ble\_mesh\_gen\_client\_status\_cb\_t::manufacturer (*C++ member*), 461  
 esp\_ble\_mesh\_gen\_client\_status\_cb\_t::manufacturer\_name (*C++ member*), 461  
 esp\_ble\_mesh\_gen\_client\_status\_cb\_t::onoff\_status (*C++ member*), 461

(C++ member), 460  
 esp\_ble\_mesh\_gen\_client\_status\_cb\_t::on\_profile\_reset\_use (C++ struct),  
 (C++ member), 460  
 esp\_ble\_mesh\_gen\_client\_status\_cb\_t::on\_profile\_reset\_use\_level\_srv\_t::last  
 (C++ member), 461  
 esp\_ble\_mesh\_gen\_client\_status\_cb\_t::on\_profile\_reset\_use\_level\_srv\_t::model  
 (C++ member), 460  
 esp\_ble\_mesh\_gen\_client\_status\_cb\_t::on\_profile\_reset\_use\_level\_srv\_t::rsp\_ctrl  
 (C++ member), 460  
 esp\_ble\_mesh\_gen\_client\_status\_cb\_t::on\_profile\_reset\_use\_level\_srv\_t::state  
 (C++ member), 461  
 esp\_ble\_mesh\_gen\_client\_status\_cb\_t::on\_profile\_reset\_use\_level\_srv\_t::transition  
 (C++ member), 461  
 esp\_ble\_mesh\_gen\_client\_status\_cb\_t::on\_profile\_reset\_use\_level\_srv\_t::tt\_delta\_level  
 (C++ member), 461  
 esp\_ble\_mesh\_gen\_def\_trans\_time\_set\_t esp\_ble\_mesh\_gen\_level\_state\_t (C++  
 (C++ struct), 466  
 struct), 475  
 esp\_ble\_mesh\_gen\_def\_trans\_time\_set\_t::start\_time esp\_ble\_mesh\_gen\_level\_state\_t::last\_delta  
 (C++ member), 466  
 (C++ member), 475  
 esp\_ble\_mesh\_gen\_def\_trans\_time\_srv\_t esp\_ble\_mesh\_gen\_level\_state\_t::last\_level  
 (C++ struct), 476  
 (C++ member), 475  
 esp\_ble\_mesh\_gen\_def\_trans\_time\_srv\_t::model esp\_ble\_mesh\_gen\_level\_state\_t::level  
 (C++ member), 476  
 (C++ member), 475  
 esp\_ble\_mesh\_gen\_def\_trans\_time\_srv\_t::move\_start esp\_ble\_mesh\_gen\_level\_state\_t::move\_start  
 (C++ member), 476  
 (C++ member), 475  
 esp\_ble\_mesh\_gen\_def\_trans\_time\_srv\_t::state esp\_ble\_mesh\_gen\_level\_state\_t::positive  
 (C++ member), 476  
 (C++ member), 475  
 esp\_ble\_mesh\_gen\_def\_trans\_time\_state\_t esp\_ble\_mesh\_gen\_level\_state\_t::target\_level  
 (C++ struct), 476  
 (C++ member), 475  
 esp\_ble\_mesh\_gen\_def\_trans\_time\_state\_t::start\_time esp\_ble\_mesh\_gen\_level\_status\_cb\_t  
 (C++ member), 476  
 (C++ struct), 469  
 esp\_ble\_mesh\_gen\_def\_trans\_time\_status\_cb\_t esp\_ble\_mesh\_gen\_level\_status\_cb\_t::op\_en  
 (C++ struct), 470  
 (C++ member), 470  
 esp\_ble\_mesh\_gen\_def\_trans\_time\_status\_cb\_t::present\_level esp\_ble\_mesh\_gen\_level\_status\_cb\_t::present\_level  
 (C++ member), 470  
 (C++ member), 470  
 esp\_ble\_mesh\_gen\_delta\_set\_t (C++ struct), esp\_ble\_mesh\_gen\_level\_status\_cb\_t::remain\_time  
 465  
 (C++ member), 470  
 esp\_ble\_mesh\_gen\_delta\_set\_t::delay esp\_ble\_mesh\_gen\_level\_status\_cb\_t::target\_level  
 (C++ member), 465  
 (C++ member), 470  
 esp\_ble\_mesh\_gen\_delta\_set\_t::level esp\_ble\_mesh\_gen\_loc\_global\_set\_t  
 (C++ member), 465  
 (C++ struct), 467  
 esp\_ble\_mesh\_gen\_delta\_set\_t::op\_en esp\_ble\_mesh\_gen\_loc\_global\_set\_t::global\_altitud  
 (C++ member), 465  
 (C++ member), 467  
 esp\_ble\_mesh\_gen\_delta\_set\_t::tid esp\_ble\_mesh\_gen\_loc\_global\_set\_t::global\_latitud  
 (C++ member), 465  
 (C++ member), 467  
 esp\_ble\_mesh\_gen\_delta\_set\_t::trans\_time esp\_ble\_mesh\_gen\_loc\_global\_set\_t::global\_longitu  
 (C++ member), 465  
 (C++ member), 467  
 esp\_ble\_mesh\_gen\_level\_set\_t (C++ struct), esp\_ble\_mesh\_gen\_loc\_global\_status\_cb\_t  
 464  
 (C++ struct), 471  
 esp\_ble\_mesh\_gen\_level\_set\_t::delay esp\_ble\_mesh\_gen\_loc\_global\_status\_cb\_t::global\_a  
 (C++ member), 465  
 (C++ member), 472  
 esp\_ble\_mesh\_gen\_level\_set\_t::level esp\_ble\_mesh\_gen\_loc\_global\_status\_cb\_t::global\_l  
 (C++ member), 465  
 (C++ member), 472  
 esp\_ble\_mesh\_gen\_level\_set\_t::op\_en esp\_ble\_mesh\_gen\_loc\_global\_status\_cb\_t::global\_l  
 (C++ member), 465  
 (C++ member), 472  
 esp\_ble\_mesh\_gen\_level\_set\_t::tid esp\_ble\_mesh\_gen\_loc\_local\_set\_t (C++  
 (C++ member), 465  
 struct), 467  
 esp\_ble\_mesh\_gen\_level\_set\_t::trans\_time esp\_ble\_mesh\_gen\_loc\_local\_set\_t::floor\_number



(C++ member), 467  
 esp\_ble\_mesh\_gen\_loc\_local\_set\_t::local\_status\_t::ESP\_BLE\_MESH\_GEN\_LOC\_LOCAL\_STATUS\_T (C++ member), 467  
 esp\_ble\_mesh\_gen\_loc\_local\_set\_t::local\_status\_t::ESP\_BLE\_MESH\_GEN\_LOC\_LOCAL\_STATUS\_T (C++ member), 467  
 esp\_ble\_mesh\_gen\_loc\_local\_set\_t::local\_status\_t::ESP\_BLE\_MESH\_GEN\_LOC\_LOCAL\_STATUS\_T (C++ member), 467  
 esp\_ble\_mesh\_gen\_loc\_local\_set\_t::uncertainty\_t::ESP\_BLE\_MESH\_GEN\_LOC\_LOCAL\_STATUS\_T::uncertainty\_t (C++ member), 467  
 esp\_ble\_mesh\_gen\_loc\_local\_status\_cb\_t esp\_ble\_mesh\_gen\_manu\_prop\_srv\_t::property\_count (C++ struct), 472  
 esp\_ble\_mesh\_gen\_loc\_local\_status\_cb\_t::esp\_ble\_mesh\_gen\_manu\_prop\_srv\_t::rsp\_ctrl (C++ member), 472  
 esp\_ble\_mesh\_gen\_loc\_local\_status\_cb\_t::esp\_ble\_mesh\_gen\_manu\_prop\_srv\_t::rsp\_ctrl (C++ member), 472  
 esp\_ble\_mesh\_gen\_loc\_local\_status\_cb\_t::esp\_ble\_mesh\_gen\_manu\_prop\_srv\_t::rsp\_ctrl (C++ member), 472  
 esp\_ble\_mesh\_gen\_loc\_local\_status\_cb\_t::esp\_ble\_mesh\_gen\_manu\_prop\_srv\_t::rsp\_ctrl (C++ member), 472  
 esp\_ble\_mesh\_gen\_loc\_local\_status\_cb\_t::esp\_ble\_mesh\_gen\_manu\_prop\_srv\_t::rsp\_ctrl (C++ member), 472  
 esp\_ble\_mesh\_gen\_loc\_local\_status\_cb\_t::esp\_ble\_mesh\_gen\_manu\_prop\_srv\_t::rsp\_ctrl (C++ member), 472  
 esp\_ble\_mesh\_gen\_loc\_local\_status\_cb\_t::esp\_ble\_mesh\_gen\_manu\_prop\_srv\_t::rsp\_ctrl (C++ member), 472  
 esp\_ble\_mesh\_gen\_loc\_local\_status\_cb\_t::esp\_ble\_mesh\_gen\_manu\_prop\_srv\_t::rsp\_ctrl (C++ member), 472  
 esp\_ble\_mesh\_gen\_location\_setup\_srv\_t esp\_ble\_mesh\_gen\_manufacturer\_property\_set\_t (C++ struct), 480  
 esp\_ble\_mesh\_gen\_location\_setup\_srv\_t::model esp\_ble\_mesh\_gen\_manufacturer\_property\_set\_t::model (C++ member), 480  
 esp\_ble\_mesh\_gen\_location\_setup\_srv\_t::rsp\_ctrl esp\_ble\_mesh\_gen\_manufacturer\_property\_set\_t::use (C++ member), 480  
 esp\_ble\_mesh\_gen\_location\_setup\_srv\_t::state esp\_ble\_mesh\_gen\_manufacturer\_property\_status\_cb\_t (C++ member), 480  
 esp\_ble\_mesh\_gen\_location\_srv\_t (C++ struct), 480  
 esp\_ble\_mesh\_gen\_location\_srv\_t::model esp\_ble\_mesh\_gen\_manufacturer\_property\_status\_cb\_t (C++ member), 480  
 esp\_ble\_mesh\_gen\_location\_srv\_t::rsp\_ctrl esp\_ble\_mesh\_gen\_manufacturer\_property\_status\_cb\_t (C++ member), 480  
 esp\_ble\_mesh\_gen\_location\_srv\_t::state esp\_ble\_mesh\_gen\_manufacturer\_property\_status\_cb\_t (C++ member), 480  
 esp\_ble\_mesh\_gen\_location\_state\_t esp\_ble\_mesh\_gen\_move\_set\_t (C++ struct), 479  
 esp\_ble\_mesh\_gen\_location\_state\_t::floor\_number esp\_ble\_mesh\_gen\_move\_set\_t::delay (C++ member), 480  
 esp\_ble\_mesh\_gen\_location\_state\_t::global\_latitude esp\_ble\_mesh\_gen\_move\_set\_t::delta\_level (C++ member), 479  
 esp\_ble\_mesh\_gen\_location\_state\_t::global\_latitude esp\_ble\_mesh\_gen\_move\_set\_t::delta\_level (C++ member), 479  
 esp\_ble\_mesh\_gen\_location\_state\_t::global\_latitude esp\_ble\_mesh\_gen\_move\_set\_t::op\_en (C++ member), 479  
 esp\_ble\_mesh\_gen\_location\_state\_t::global\_longitude esp\_ble\_mesh\_gen\_move\_set\_t::tid (C++ member), 479  
 esp\_ble\_mesh\_gen\_location\_state\_t::local\_latitude esp\_ble\_mesh\_gen\_move\_set\_t::trans\_time (C++ member), 480  
 esp\_ble\_mesh\_gen\_location\_state\_t::local\_latitude esp\_ble\_mesh\_gen\_move\_set\_t::trans\_time (C++ member), 480  
 esp\_ble\_mesh\_gen\_location\_state\_t::local\_status\_t::ESP\_BLE\_MESH\_GEN\_ONOFF\_SET\_T (C++ struct), 480  
 esp\_ble\_mesh\_gen\_location\_state\_t::local\_status\_t::ESP\_BLE\_MESH\_GEN\_ONOFF\_SET\_T (C++ member), 480  
 esp\_ble\_mesh\_gen\_location\_state\_t::uncertainty\_t::ESP\_BLE\_MESH\_GEN\_ONOFF\_SET\_T::onoff (C++ member), 480  
 esp\_ble\_mesh\_gen\_manu\_prop\_access\_t esp\_ble\_mesh\_gen\_onoff\_set\_t::op\_en (C++ enum), 497  
 esp\_ble\_mesh\_gen\_manu\_prop\_access\_t::ESP\_BLE\_MESH\_GEN\_MANU\_PROP\_ACCESS\_READ

(C++ member), 464

esp\_ble\_mesh\_gen\_onoff\_set\_t::trans\_time (C++ member), 464

esp\_ble\_mesh\_gen\_onoff\_srv\_t (C++ struct), 475

esp\_ble\_mesh\_gen\_onoff\_srv\_t::last (C++ member), 475

esp\_ble\_mesh\_gen\_onoff\_srv\_t::model (C++ member), 475

esp\_ble\_mesh\_gen\_onoff\_srv\_t::rsp\_ctrl (C++ member), 475

esp\_ble\_mesh\_gen\_onoff\_srv\_t::state (C++ member), 475

esp\_ble\_mesh\_gen\_onoff\_srv\_t::transition (C++ member), 475

esp\_ble\_mesh\_gen\_onoff\_state\_t (C++ struct), 474

esp\_ble\_mesh\_gen\_onoff\_state\_t::onoff (C++ member), 474

esp\_ble\_mesh\_gen\_onoff\_state\_t::target\_power (C++ member), 474

esp\_ble\_mesh\_gen\_onoff\_status\_cb\_t (C++ struct), 469

esp\_ble\_mesh\_gen\_onoff\_status\_cb\_t::op\_err (C++ member), 469

esp\_ble\_mesh\_gen\_onoff\_status\_cb\_t::present (C++ member), 469

esp\_ble\_mesh\_gen\_onoff\_status\_cb\_t::remain\_time (C++ member), 469

esp\_ble\_mesh\_gen\_onoff\_status\_cb\_t::target\_power (C++ member), 469

esp\_ble\_mesh\_gen\_onpowerup\_set\_t (C++ struct), 466

esp\_ble\_mesh\_gen\_onpowerup\_set\_t::onpowerup (C++ member), 466

esp\_ble\_mesh\_gen\_onpowerup\_state\_t (C++ struct), 476

esp\_ble\_mesh\_gen\_onpowerup\_state\_t::onpowerup (C++ member), 477

esp\_ble\_mesh\_gen\_onpowerup\_status\_cb\_t (C++ struct), 470

esp\_ble\_mesh\_gen\_onpowerup\_status\_cb\_t::onpowerup (C++ member), 470

esp\_ble\_mesh\_gen\_onpowerup\_status\_cb\_t::present (C++ member), 470

esp\_ble\_mesh\_gen\_onpowerup\_status\_cb\_t::remain\_time (C++ member), 470

esp\_ble\_mesh\_gen\_onpowerup\_status\_cb\_t::target\_power (C++ member), 470

esp\_ble\_mesh\_gen\_power\_default\_set\_t (C++ struct), 466

esp\_ble\_mesh\_gen\_power\_default\_set\_t::power (C++ member), 467

esp\_ble\_mesh\_gen\_power\_default\_status\_cb\_t (C++ struct), 471

esp\_ble\_mesh\_gen\_power\_default\_status\_cb\_t::power (C++ member), 471

esp\_ble\_mesh\_gen\_power\_last\_status\_cb\_t (C++ struct), 470

esp\_ble\_mesh\_gen\_power\_last\_status\_cb\_t::power (C++ member), 471

esp\_ble\_mesh\_gen\_power\_level\_set\_t (C++ struct), 466

esp\_ble\_mesh\_gen\_power\_level\_set\_t::delays (C++ member), 466

esp\_ble\_mesh\_gen\_power\_level\_set\_t::op\_err (C++ member), 466

esp\_ble\_mesh\_gen\_power\_level\_set\_t::power (C++ member), 466

esp\_ble\_mesh\_gen\_power\_level\_set\_t::tid (C++ member), 466

esp\_ble\_mesh\_gen\_power\_level\_set\_t::trans\_time (C++ member), 466

esp\_ble\_mesh\_gen\_power\_level\_setup\_srv\_t (C++ struct), 478

esp\_ble\_mesh\_gen\_power\_level\_setup\_srv\_t::model (C++ member), 478

esp\_ble\_mesh\_gen\_power\_level\_setup\_srv\_t::rsp\_ctrl (C++ member), 478

esp\_ble\_mesh\_gen\_power\_level\_setup\_srv\_t::state (C++ member), 478

esp\_ble\_mesh\_gen\_power\_level\_srv\_t (C++ struct), 478

esp\_ble\_mesh\_gen\_power\_level\_srv\_t::last (C++ member), 478

esp\_ble\_mesh\_gen\_power\_level\_srv\_t::model (C++ member), 478

esp\_ble\_mesh\_gen\_power\_level\_srv\_t::rsp\_ctrl (C++ member), 478

esp\_ble\_mesh\_gen\_power\_level\_srv\_t::state (C++ member), 478

esp\_ble\_mesh\_gen\_power\_level\_srv\_t::transition (C++ member), 478

esp\_ble\_mesh\_gen\_power\_level\_srv\_t::tt\_delta\_level (C++ member), 478

esp\_ble\_mesh\_gen\_power\_level\_state\_t (C++ struct), 477

esp\_ble\_mesh\_gen\_power\_level\_state\_t::power\_actual (C++ member), 477

esp\_ble\_mesh\_gen\_power\_level\_state\_t::power\_default (C++ member), 477

esp\_ble\_mesh\_gen\_power\_level\_state\_t::power\_last (C++ member), 477

esp\_ble\_mesh\_gen\_power\_level\_state\_t::power\_range (C++ member), 478

esp\_ble\_mesh\_gen\_power\_level\_state\_t::power\_range\_min (C++ member), 478

esp\_ble\_mesh\_gen\_power\_level\_state\_t::status\_code (C++ member), 478

esp\_ble\_mesh\_gen\_power\_level\_state\_t::target\_power (C++ member), 477

esp\_ble\_mesh\_gen\_power\_level\_status\_cb\_t (C++ struct), 470

esp\_ble\_mesh\_gen\_power\_level\_status\_cb\_t::op\_err (C++ member), 470

esp\_ble\_mesh\_gen\_power\_level\_status\_cb\_t::present (C++ member), 470

esp\_ble\_mesh\_gen\_power\_level\_status\_cb\_t::remain\_time (C++ member), 470

esp\_ble\_mesh\_gen\_power\_level\_status\_cb\_t::target\_power (C++ member), 470

esp\_ble\_mesh\_gen\_power\_onoff\_setup\_srv\_t (C++ struct), 478

(C++ struct), 477  
 esp\_ble\_mesh\_gen\_power\_onoff\_setup\_srv\_t (C++ member), 477  
 esp\_ble\_mesh\_gen\_power\_onoff\_setup\_srv\_t::mode (C++ member), 477  
 esp\_ble\_mesh\_gen\_power\_onoff\_setup\_srv\_t::rsp (C++ member), 477  
 esp\_ble\_mesh\_gen\_power\_onoff\_setup\_srv\_t::state (C++ member), 477  
 esp\_ble\_mesh\_gen\_power\_onoff\_srv\_t (C++ struct), 477  
 esp\_ble\_mesh\_gen\_power\_onoff\_srv\_t::mode (C++ member), 477  
 esp\_ble\_mesh\_gen\_power\_onoff\_srv\_t::rsp (C++ member), 477  
 esp\_ble\_mesh\_gen\_power\_onoff\_srv\_t::state (C++ member), 477  
 esp\_ble\_mesh\_gen\_power\_range\_set\_t (C++ struct), 467  
 esp\_ble\_mesh\_gen\_power\_range\_set\_t::range (C++ member), 467  
 esp\_ble\_mesh\_gen\_power\_range\_set\_t::range (C++ member), 467  
 esp\_ble\_mesh\_gen\_power\_range\_status\_cb\_t (C++ struct), 471  
 esp\_ble\_mesh\_gen\_power\_range\_status\_cb\_t (C++ member), 471  
 esp\_ble\_mesh\_gen\_power\_range\_status\_cb\_t (C++ member), 471  
 esp\_ble\_mesh\_gen\_power\_range\_status\_cb\_t (C++ member), 471  
 esp\_ble\_mesh\_gen\_power\_range\_status\_cb\_t (C++ member), 471  
 esp\_ble\_mesh\_gen\_power\_range\_status\_cb\_t (C++ member), 471  
 esp\_ble\_mesh\_gen\_user\_prop\_access\_t (C++ enum), 497  
 esp\_ble\_mesh\_gen\_user\_prop\_access\_t::ESP\_BLE\_MESH\_GEN\_USER\_PROP\_ACCESS\_READ (C++ enumerator), 497  
 esp\_ble\_mesh\_gen\_user\_prop\_access\_t::ESP\_BLE\_MESH\_GEN\_USER\_PROP\_ACCESS\_READ\_WRITE (C++ enumerator), 497  
 esp\_ble\_mesh\_gen\_user\_prop\_access\_t::ESP\_BLE\_MESH\_GEN\_USER\_PROP\_ACCESS\_WRITE (C++ enumerator), 497  
 esp\_ble\_mesh\_gen\_user\_prop\_srv\_t (C++ struct), 481  
 esp\_ble\_mesh\_gen\_user\_prop\_srv\_t::mode (C++ member), 481  
 esp\_ble\_mesh\_gen\_user\_prop\_srv\_t::properties (C++ member), 481  
 esp\_ble\_mesh\_gen\_user\_prop\_srv\_t::properties (C++ member), 481  
 esp\_ble\_mesh\_gen\_user\_prop\_srv\_t::rsp (C++ member), 481  
 esp\_ble\_mesh\_gen\_user\_properties\_status\_cb\_t (C++ struct), 472  
 esp\_ble\_mesh\_gen\_user\_properties\_status\_cb\_t (C++ member), 472  
 esp\_ble\_mesh\_gen\_user\_property\_get\_t (C++ struct), 468  
 esp\_ble\_mesh\_gen\_user\_property\_get\_t::property (C++ member), 468  
 esp\_ble\_mesh\_gen\_user\_property\_set\_t (C++ struct), 468  
 esp\_ble\_mesh\_gen\_user\_property\_set\_t::property\_id (C++ member), 468  
 esp\_ble\_mesh\_gen\_user\_property\_set\_t::property\_value (C++ member), 468  
 esp\_ble\_mesh\_gen\_user\_property\_status\_cb\_t (C++ struct), 472  
 esp\_ble\_mesh\_gen\_user\_property\_status\_cb\_t::open (C++ member), 473  
 esp\_ble\_mesh\_gen\_user\_property\_status\_cb\_t::prop (C++ member), 473  
 esp\_ble\_mesh\_gen\_user\_property\_status\_cb\_t::prop (C++ member), 473  
 esp\_ble\_mesh\_gen\_user\_property\_status\_cb\_t::user (C++ member), 473  
 esp\_ble\_mesh\_generic\_client\_cb\_event\_t (C++ enum), 496  
 esp\_ble\_mesh\_generic\_client\_cb\_event\_t::ESP\_BLE\_MESH\_GENERIC\_CLIENT\_CB\_EVENT\_CONNECTED (C++ enumerator), 497  
 esp\_ble\_mesh\_generic\_client\_cb\_event\_t::ESP\_BLE\_MESH\_GENERIC\_CLIENT\_CB\_EVENT\_DISCONNECTED (C++ enumerator), 497  
 esp\_ble\_mesh\_generic\_client\_cb\_event\_t::ESP\_BLE\_MESH\_GENERIC\_CLIENT\_CB\_EVENT\_DISCONNECTING (C++ enumerator), 497  
 esp\_ble\_mesh\_generic\_client\_cb\_event\_t::ESP\_BLE\_MESH\_GENERIC\_CLIENT\_CB\_EVENT\_FAILED (C++ enumerator), 497  
 esp\_ble\_mesh\_generic\_client\_cb\_param\_t (C++ struct), 474  
 esp\_ble\_mesh\_generic\_client\_cb\_param\_t::error\_code (C++ member), 474  
 esp\_ble\_mesh\_generic\_client\_get\_state\_t::params (C++ member), 474  
 esp\_ble\_mesh\_generic\_client\_get\_state\_t::status\_cb (C++ member), 474  
 esp\_ble\_mesh\_generic\_client\_get\_state\_t (type), 496  
 esp\_ble\_mesh\_generic\_client\_get\_state\_t::state (C++ function), 458  
 esp\_ble\_mesh\_generic\_client\_get\_state\_t (C++ union), 459  
 esp\_ble\_mesh\_generic\_client\_get\_state\_t::admin\_priv (C++ member), 459  
 esp\_ble\_mesh\_generic\_client\_get\_state\_t::client\_priv (C++ member), 459  
 esp\_ble\_mesh\_generic\_client\_get\_state\_t::manufact (C++ member), 459  
 esp\_ble\_mesh\_generic\_client\_get\_state\_t::user\_priv (C++ member), 459  
 esp\_ble\_mesh\_generic\_client\_set\_state (C++ function), 458  
 esp\_ble\_mesh\_generic\_client\_set\_state\_t (C++ union), 459  
 esp\_ble\_mesh\_generic\_client\_set\_state\_t::admin\_priv (C++ member), 460  
 esp\_ble\_mesh\_generic\_client\_set\_state\_t::def\_tran (C++ member), 459  
 esp\_ble\_mesh\_generic\_client\_set\_state\_t::delta\_se









- esp\_ble\_mesh\_health\_test\_t::company\_id (C++ member), 449  
 esp\_ble\_mesh\_health\_test\_t::current\_faults (C++ member), 450  
 esp\_ble\_mesh\_health\_test\_t::id\_count (C++ member), 449  
 esp\_ble\_mesh\_health\_test\_t::prev\_test\_id (C++ member), 449  
 esp\_ble\_mesh\_health\_test\_t::registered\_faults (C++ member), 450  
 esp\_ble\_mesh\_health\_test\_t::test\_ids (C++ member), 449  
 ESP\_BLE\_MESH\_HEARTBEAT\_FILTER\_ACCEPTLIST (C macro), 362  
 ESP\_BLE\_MESH\_HEARTBEAT\_FILTER\_ADD (C macro), 362  
 esp\_ble\_mesh\_heartbeat\_filter\_info\_t (C++ struct), 352  
 esp\_ble\_mesh\_heartbeat\_filter\_info\_t::hb\_dst (C++ member), 352  
 esp\_ble\_mesh\_heartbeat\_filter\_info\_t::hb\_src (C++ member), 352  
 ESP\_BLE\_MESH\_HEARTBEAT\_FILTER\_REJECTLIST (C macro), 362  
 ESP\_BLE\_MESH\_HEARTBEAT\_FILTER\_REMOVE (C macro), 362  
 ESP\_BLE\_MESH\_HOUSING\_OPENED\_ERROR (C macro), 456  
 ESP\_BLE\_MESH\_HOUSING\_OPENED\_WARNING (C macro), 456  
 esp\_ble\_mesh\_init (C++ function), 393  
 esp\_ble\_mesh\_input\_action\_t (C++ enum), 383  
 esp\_ble\_mesh\_input\_action\_t::ESP\_BLE\_MESH\_INPUT\_ACTION\_PUSH (C++ enumerator), 384  
 esp\_ble\_mesh\_input\_action\_t::ESP\_BLE\_MESH\_INPUT\_ACTION\_PULL (C++ enumerator), 384  
 esp\_ble\_mesh\_input\_action\_t::ESP\_BLE\_MESH\_INPUT\_ACTION\_NO\_CHANGE (C++ enumerator), 384  
 esp\_ble\_mesh\_input\_action\_t::ESP\_BLE\_MESH\_INPUT\_ACTION\_RESET (C++ enumerator), 384  
 esp\_ble\_mesh\_input\_action\_t::ESP\_BLE\_MESH\_INPUT\_ACTION\_TEST (C++ enumerator), 384  
 ESP\_BLE\_MESH\_INPUT\_NO\_CHANGE\_ERROR (C macro), 456  
 ESP\_BLE\_MESH\_INPUT\_NO\_CHANGE\_WARNING (C macro), 455  
 ESP\_BLE\_MESH\_INPUT\_TOO\_HIGH\_ERROR (C macro), 455  
 ESP\_BLE\_MESH\_INPUT\_TOO\_HIGH\_WARNING (C macro), 455  
 ESP\_BLE\_MESH\_INPUT\_TOO\_LOW\_ERROR (C macro), 455  
 ESP\_BLE\_MESH\_INPUT\_TOO\_LOW\_WARNING (C macro), 455  
 ESP\_BLE\_MESH\_INTERNAL\_BUS\_ERROR (C macro), 456  
 ESP\_BLE\_MESH\_INTERNAL\_BUS\_WARNING (C macro), 456  
 macro), 456  
 ESP\_BLE\_MESH\_INVALID\_NODE\_INDEX (C macro), 358  
 ESP\_BLE\_MESH\_INVALID\_SCENE\_NUMBER (C macro), 543  
 ESP\_BLE\_MESH\_INVALID\_SENSOR\_PROPERTY\_ID (C macro), 514  
 ESP\_BLE\_MESH\_INVALID\_SENSOR\_SETTING\_PROPERTY\_ID (C macro), 514  
 ESP\_BLE\_MESH\_INVALID\_SETTINGS\_IDX (C macro), 355  
 esp\_ble\_mesh\_is\_model\_subscribed\_to\_group (C++ function), 394  
 ESP\_BLE\_MESH\_KEY\_ANY (C macro), 356  
 ESP\_BLE\_MESH\_KEY\_DEV (C macro), 356  
 ESP\_BLE\_MESH\_KEY\_PRIMARY (C macro), 356  
 ESP\_BLE\_MESH\_KEY\_UNUSED (C macro), 356  
 ESP\_BLE\_MESH\_KEY\_UNUSED\_ELT\_ (C macro), 356  
 ESP\_BLE\_MESH\_LANE\_DISC\_GUARD\_INTERVAL\_10\_SEC (C macro), 642  
 ESP\_BLE\_MESH\_LANE\_DISC\_GUARD\_INTERVAL\_2\_SEC (C macro), 642  
 esp\_ble\_mesh\_large\_comp\_data\_get\_t (C++ struct), 682  
 esp\_ble\_mesh\_large\_comp\_data\_get\_t::offset (C++ member), 682  
 esp\_ble\_mesh\_large\_comp\_data\_get\_t::page (C++ member), 682  
 esp\_ble\_mesh\_large\_comp\_data\_status\_t (C++ struct), 683  
 esp\_ble\_mesh\_large\_comp\_data\_status\_t::data (C++ member), 683  
 esp\_ble\_mesh\_large\_comp\_data\_status\_t::offset (C++ member), 683  
 esp\_ble\_mesh\_large\_comp\_data\_status\_t::page (C++ member), 683  
 esp\_ble\_mesh\_large\_comp\_data\_status\_t::total\_size (C++ member), 683  
 esp\_ble\_mesh\_last\_msg\_info\_t (C++ struct), 354  
 esp\_ble\_mesh\_last\_msg\_info\_t::dst (C++ member), 354  
 esp\_ble\_mesh\_last\_msg\_info\_t::src (C++ member), 354  
 esp\_ble\_mesh\_last\_msg\_info\_t::tid (C++ member), 354  
 esp\_ble\_mesh\_last\_msg\_info\_t::timestamp (C++ member), 354  
 esp\_ble\_mesh\_lc\_state\_t (C++ enum), 601  
 esp\_ble\_mesh\_lc\_state\_t::ESP\_BLE\_MESH\_LC\_FADE (C++ enumerator), 602  
 esp\_ble\_mesh\_lc\_state\_t::ESP\_BLE\_MESH\_LC\_FADE\_ON (C++ enumerator), 602  
 esp\_ble\_mesh\_lc\_state\_t::ESP\_BLE\_MESH\_LC\_FADE\_STA (C++ enumerator), 602  
 esp\_ble\_mesh\_lc\_state\_t::ESP\_BLE\_MESH\_LC\_FADE\_STA (C++ enumerator), 602











(C++ member), 566  
 esp\_ble\_mesh\_light\_hsl\_saturation\_status\_cb\_t (C++ member), 566  
 esp\_ble\_mesh\_light\_hsl\_saturation\_status\_cb\_t::lightness (C++ member), 574  
 esp\_ble\_mesh\_light\_hsl\_saturation\_status\_cb\_t::remain\_time (C++ member), 574  
 esp\_ble\_mesh\_light\_hsl\_saturation\_status\_cb\_t::saturation (C++ member), 574  
 esp\_ble\_mesh\_light\_hsl\_set\_t (C++ struct), 557  
 esp\_ble\_mesh\_light\_hsl\_set\_t::delay (C++ member), 558  
 esp\_ble\_mesh\_light\_hsl\_set\_t::hsl\_hue (C++ member), 557  
 esp\_ble\_mesh\_light\_hsl\_set\_t::hsl\_lightness (C++ member), 557  
 esp\_ble\_mesh\_light\_hsl\_set\_t::hsl\_saturation (C++ member), 558  
 esp\_ble\_mesh\_light\_hsl\_set\_t::op\_en (C++ member), 557  
 esp\_ble\_mesh\_light\_hsl\_set\_t::tid (C++ member), 558  
 esp\_ble\_mesh\_light\_hsl\_set\_t::trans\_time (C++ member), 558  
 esp\_ble\_mesh\_light\_hsl\_setup\_srv\_t (C++ struct), 575  
 esp\_ble\_mesh\_light\_hsl\_setup\_srv\_t::mode (C++ member), 576  
 esp\_ble\_mesh\_light\_hsl\_setup\_srv\_t::rsp\_ctrl (C++ member), 576  
 esp\_ble\_mesh\_light\_hsl\_setup\_srv\_t::state (C++ member), 576  
 esp\_ble\_mesh\_light\_hsl\_srv\_t (C++ struct), 575  
 esp\_ble\_mesh\_light\_hsl\_srv\_t::last (C++ member), 575  
 esp\_ble\_mesh\_light\_hsl\_srv\_t::model (C++ member), 575  
 esp\_ble\_mesh\_light\_hsl\_srv\_t::rsp\_ctrl (C++ member), 575  
 esp\_ble\_mesh\_light\_hsl\_srv\_t::state (C++ member), 575  
 esp\_ble\_mesh\_light\_hsl\_srv\_t::transition (C++ member), 575  
 esp\_ble\_mesh\_light\_hsl\_srv\_t::tt\_delta\_time (C++ member), 575  
 esp\_ble\_mesh\_light\_hsl\_srv\_t::tt\_delta\_time\_min (C++ member), 575  
 esp\_ble\_mesh\_light\_hsl\_state\_t (C++ struct), 574  
 esp\_ble\_mesh\_light\_hsl\_state\_t::hue (C++ member), 574  
 esp\_ble\_mesh\_light\_hsl\_state\_t::hue\_default (C++ member), 574  
 esp\_ble\_mesh\_light\_hsl\_state\_t::hue\_range (C++ member), 575  
 esp\_ble\_mesh\_light\_hsl\_state\_t::hue\_range\_min (C++ member), 575  
 esp\_ble\_mesh\_light\_hsl\_status\_cb\_t (C++ struct), 565  
 esp\_ble\_mesh\_light\_hsl\_status\_cb\_t::hsl\_hue (C++ member), 565  
 esp\_ble\_mesh\_light\_hsl\_status\_cb\_t::hsl\_lightness (C++ member), 565  
 esp\_ble\_mesh\_light\_hsl\_status\_cb\_t::hsl\_saturation (C++ member), 565  
 esp\_ble\_mesh\_light\_hsl\_status\_cb\_t::op\_en (C++ member), 565  
 esp\_ble\_mesh\_light\_hsl\_status\_cb\_t::remain\_time (C++ member), 565  
 esp\_ble\_mesh\_light\_hsl\_target\_status\_cb\_t (C++ struct), 565  
 esp\_ble\_mesh\_light\_hsl\_target\_status\_cb\_t::hsl\_hue (C++ member), 566  
 esp\_ble\_mesh\_light\_hsl\_target\_status\_cb\_t::hsl\_lightness (C++ member), 566  
 esp\_ble\_mesh\_light\_hsl\_target\_status\_cb\_t::hsl\_saturation (C++ member), 566  
 esp\_ble\_mesh\_light\_hsl\_target\_status\_cb\_t::op\_en (C++ member), 566  
 esp\_ble\_mesh\_light\_hsl\_target\_status\_cb\_t::remain\_time (C++ member), 566  
 esp\_ble\_mesh\_light\_lc\_light\_onoff\_set\_t (C++ struct), 561  
 esp\_ble\_mesh\_light\_lc\_light\_onoff\_set\_t::delay (C++ member), 561  
 esp\_ble\_mesh\_light\_lc\_light\_onoff\_set\_t::light\_on (C++ member), 561  
 esp\_ble\_mesh\_light\_lc\_light\_onoff\_set\_t::op\_en (C++ member), 561  
 esp\_ble\_mesh\_light\_lc\_light\_onoff\_set\_t::tid (C++ member), 561  
 esp\_ble\_mesh\_light\_lc\_light\_onoff\_set\_t::trans\_time (C++ member), 561  
 esp\_ble\_mesh\_light\_lc\_light\_onoff\_status\_cb\_t (C++ struct), 561







(C++ member), 570  
 esp\_ble\_mesh\_light\_lightness\_state\_t::status\_code esp\_ble\_mesh\_light\_xyl\_set\_t::delay  
 (C++ member), 570 (C++ member), 560  
 esp\_ble\_mesh\_light\_lightness\_state\_t::target\_lightness esp\_ble\_mesh\_light\_xyl\_set\_t::op\_en  
 (C++ member), 570 (C++ member), 559  
 esp\_ble\_mesh\_light\_lightness\_state\_t::target\_lightness esp\_ble\_mesh\_light\_xyl\_set\_t::tid  
 (C++ member), 570 (C++ member), 560  
 esp\_ble\_mesh\_light\_lightness\_status\_cb esp\_ble\_mesh\_light\_xyl\_set\_t::trans\_time  
 (C++ struct), 562 (C++ member), 560  
 esp\_ble\_mesh\_light\_lightness\_status\_cb esp\_ble\_mesh\_light\_xyl\_set\_t::xyl\_lightness  
 (C++ member), 562 (C++ member), 560  
 esp\_ble\_mesh\_light\_lightness\_status\_cb esp\_ble\_mesh\_light\_xyl\_set\_t::xyl\_x  
 (C++ member), 562 (C++ member), 560  
 esp\_ble\_mesh\_light\_lightness\_status\_cb esp\_ble\_mesh\_light\_xyl\_set\_t::xyl\_y  
 (C++ member), 562 (C++ member), 560  
 esp\_ble\_mesh\_light\_lightness\_status\_cb esp\_ble\_mesh\_light\_xyl\_setup\_srv\_t  
 (C++ member), 562 (C++ struct), 578  
 esp\_ble\_mesh\_light\_message\_opcode\_t esp\_ble\_mesh\_light\_xyl\_setup\_srv\_t::model  
 (C++ type), 382 (C++ member), 578  
 esp\_ble\_mesh\_light\_xyl\_default\_set\_t esp\_ble\_mesh\_light\_xyl\_setup\_srv\_t::rsp\_ctrl  
 (C++ struct), 560 (C++ member), 578  
 esp\_ble\_mesh\_light\_xyl\_default\_set\_t::lightness esp\_ble\_mesh\_light\_xyl\_setup\_srv\_t::state  
 (C++ member), 560 (C++ member), 579  
 esp\_ble\_mesh\_light\_xyl\_default\_set\_t::xyl esp\_ble\_mesh\_light\_xyl\_srv\_t (C++ struct),  
 (C++ member), 560 578  
 esp\_ble\_mesh\_light\_xyl\_default\_set\_t::xyl esp\_ble\_mesh\_light\_xyl\_srv\_t::last  
 (C++ member), 560 (C++ member), 578  
 esp\_ble\_mesh\_light\_xyl\_default\_status\_cb esp\_ble\_mesh\_light\_xyl\_srv\_t::model  
 (C++ struct), 568 (C++ member), 578  
 esp\_ble\_mesh\_light\_xyl\_default\_status\_cb esp\_ble\_mesh\_light\_xyl\_srv\_t::rsp\_ctrl  
 (C++ member), 568 (C++ member), 578  
 esp\_ble\_mesh\_light\_xyl\_default\_status\_cb esp\_ble\_mesh\_light\_xyl\_srv\_t::state  
 (C++ member), 568 (C++ member), 578  
 esp\_ble\_mesh\_light\_xyl\_default\_status\_cb esp\_ble\_mesh\_light\_xyl\_srv\_t::transition  
 (C++ member), 568 (C++ member), 578  
 esp\_ble\_mesh\_light\_xyl\_range\_set\_t esp\_ble\_mesh\_light\_xyl\_srv\_t::tt\_delta\_lightness  
 (C++ struct), 560 (C++ member), 578  
 esp\_ble\_mesh\_light\_xyl\_range\_set\_t::xyl esp\_ble\_mesh\_light\_xyl\_srv\_t::tt\_delta\_x  
 (C++ member), 560 (C++ member), 578  
 esp\_ble\_mesh\_light\_xyl\_range\_set\_t::xyl esp\_ble\_mesh\_light\_xyl\_srv\_t::tt\_delta\_y  
 (C++ member), 560 (C++ member), 578  
 esp\_ble\_mesh\_light\_xyl\_range\_set\_t::xyl esp\_ble\_mesh\_light\_xyl\_state\_t (C++  
 (C++ member), 561 struct), 577  
 esp\_ble\_mesh\_light\_xyl\_range\_set\_t::xyl esp\_ble\_mesh\_light\_xyl\_state\_t::lightness  
 (C++ member), 560 (C++ member), 577  
 esp\_ble\_mesh\_light\_xyl\_range\_status\_cb esp\_ble\_mesh\_light\_xyl\_state\_t::lightness\_default  
 (C++ struct), 568 (C++ member), 577  
 esp\_ble\_mesh\_light\_xyl\_range\_status\_cb esp\_ble\_mesh\_light\_xyl\_state\_t::status\_code  
 (C++ member), 568 (C++ member), 577  
 esp\_ble\_mesh\_light\_xyl\_range\_status\_cb esp\_ble\_mesh\_light\_xyl\_state\_t::target\_lightness  
 (C++ member), 569 (C++ member), 577  
 esp\_ble\_mesh\_light\_xyl\_range\_status\_cb esp\_ble\_mesh\_light\_xyl\_state\_t::target\_x  
 (C++ member), 568 (C++ member), 577  
 esp\_ble\_mesh\_light\_xyl\_range\_status\_cb esp\_ble\_mesh\_light\_xyl\_state\_t::target\_y  
 (C++ member), 569 (C++ member), 577  
 esp\_ble\_mesh\_light\_xyl\_range\_status\_cb esp\_ble\_mesh\_light\_xyl\_state\_t::x  
 (C++ member), 569 (C++ member), 577  
 esp\_ble\_mesh\_light\_xyl\_set\_t (C++ struct), esp\_ble\_mesh\_light\_xyl\_state\_t::x\_default

(C++ member), 577  
 esp\_ble\_mesh\_light\_xyl\_state\_t::x\_range\_size (C++ member), 577  
 esp\_ble\_mesh\_light\_xyl\_state\_t::x\_range\_start (C++ member), 577  
 esp\_ble\_mesh\_light\_xyl\_state\_t::y (C++ member), 577  
 esp\_ble\_mesh\_light\_xyl\_state\_t::y\_default (C++ member), 577  
 esp\_ble\_mesh\_light\_xyl\_state\_t::y\_range\_size (C++ member), 578  
 esp\_ble\_mesh\_light\_xyl\_state\_t::y\_range\_start (C++ member), 578  
 esp\_ble\_mesh\_light\_xyl\_status\_cb\_t (C++ struct), 567  
 esp\_ble\_mesh\_light\_xyl\_status\_cb\_t::op (C++ member), 567  
 esp\_ble\_mesh\_light\_xyl\_status\_cb\_t::remove\_line (C++ member), 567  
 esp\_ble\_mesh\_light\_xyl\_status\_cb\_t::xylesp (C++ member), 567  
 esp\_ble\_mesh\_light\_xyl\_status\_cb\_t::xylesp (C++ member), 567  
 esp\_ble\_mesh\_light\_xyl\_status\_cb\_t::xylesp (C++ member), 567  
 esp\_ble\_mesh\_light\_xyl\_target\_status\_cb\_t (C++ struct), 568  
 esp\_ble\_mesh\_light\_xyl\_target\_status\_cb\_t::role (C++ member), 568  
 esp\_ble\_mesh\_light\_xyl\_target\_status\_cb\_t::role\_name (C++ member), 568  
 esp\_ble\_mesh\_light\_xyl\_target\_status\_cb\_t::role\_name (C++ member), 568  
 esp\_ble\_mesh\_light\_xyl\_target\_status\_cb\_t::role\_name (C++ member), 568  
 esp\_ble\_mesh\_light\_xyl\_target\_status\_cb\_t::role\_name (C++ member), 568  
 esp\_ble\_mesh\_light\_xyl\_target\_status\_cb\_t::role\_name (C++ member), 568  
 esp\_ble\_mesh\_lighting\_server\_cb\_event\_t (C++ enum), 602  
 esp\_ble\_mesh\_lighting\_server\_cb\_event\_t::ESP\_BLE\_MESH\_LIGHTING\_SERVER\_CB\_EVT\_MAX (C++ enumerator), 602  
 esp\_ble\_mesh\_lighting\_server\_cb\_event\_t::ESP\_BLE\_MESH\_LIGHTING\_SERVER\_CB\_EVT\_GET\_MSG (C++ enumerator), 602  
 esp\_ble\_mesh\_lighting\_server\_cb\_event\_t::ESP\_BLE\_MESH\_LIGHTING\_SERVER\_CB\_EVT\_SET\_MSG (C++ enumerator), 602  
 esp\_ble\_mesh\_lighting\_server\_cb\_event\_t::ESP\_BLE\_MESH\_LIGHTING\_SERVER\_CB\_EVT\_STATUS\_MSG (C++ enumerator), 602  
 esp\_ble\_mesh\_lighting\_server\_cb\_event\_t::ESP\_BLE\_MESH\_LIGHTING\_SERVER\_CB\_EVT\_STATE\_CHANGE (C++ enumerator), 602  
 esp\_ble\_mesh\_lighting\_server\_cb\_param\_t (C++ struct), 596  
 esp\_ble\_mesh\_lighting\_server\_cb\_param\_t::xyl (C++ member), 596  
 esp\_ble\_mesh\_lighting\_server\_cb\_param\_t::xyl (C++ member), 596  
 esp\_ble\_mesh\_lighting\_server\_cb\_param\_t::xyl (C++ member), 596  
 esp\_ble\_mesh\_lighting\_server\_cb\_param\_t::xyl (C++ member), 596  
 esp\_ble\_mesh\_lighting\_server\_cb\_t (C++ type), 601  
 esp\_ble\_mesh\_lighting\_server\_cb\_value\_t (C++ union), 554  
 esp\_ble\_mesh\_lighting\_server\_cb\_value\_t::get (C++ member), 554  
 esp\_ble\_mesh\_lighting\_server\_cb\_value\_t::set (C++ member), 554  
 esp\_ble\_mesh\_lighting\_server\_cb\_value\_t::state\_change (C++ member), 554  
 esp\_ble\_mesh\_lighting\_server\_cb\_value\_t::status (C++ member), 554  
 esp\_ble\_mesh\_lighting\_server\_recv\_get\_msg\_t (C++ union), 552  
 esp\_ble\_mesh\_lighting\_server\_recv\_get\_msg\_t::lc (C++ member), 552  
 esp\_ble\_mesh\_lighting\_server\_recv\_set\_msg\_t (C++ union), 552  
 esp\_ble\_mesh\_lighting\_server\_recv\_set\_msg\_t::ctl (C++ member), 553  
 esp\_ble\_mesh\_lighting\_server\_recv\_set\_msg\_t::ctl (C++ member), 553  
 esp\_ble\_mesh\_lighting\_server\_recv\_set\_msg\_t::ctl (C++ member), 553  
 esp\_ble\_mesh\_lighting\_server\_recv\_set\_msg\_t::hsl (C++ member), 553  
 esp\_ble\_mesh\_lighting\_server\_recv\_set\_msg\_t::hsl (C++ member), 553  
 esp\_ble\_mesh\_lighting\_server\_recv\_set\_msg\_t::hsl (C++ member), 553  
 esp\_ble\_mesh\_lighting\_server\_recv\_set\_msg\_t::hsl (C++ member), 553  
 esp\_ble\_mesh\_lighting\_server\_recv\_set\_msg\_t::hsl (C++ member), 553  
 esp\_ble\_mesh\_lighting\_server\_recv\_set\_msg\_t::lc (C++ member), 554  
 esp\_ble\_mesh\_lighting\_server\_recv\_set\_msg\_t::lc (C++ member), 554  
 esp\_ble\_mesh\_lighting\_server\_recv\_set\_msg\_t::lc (C++ member), 554  
 esp\_ble\_mesh\_lighting\_server\_recv\_set\_msg\_t::lc (C++ member), 554  
 esp\_ble\_mesh\_lighting\_server\_recv\_set\_msg\_t::lc (C++ member), 554  
 esp\_ble\_mesh\_lighting\_server\_recv\_set\_msg\_t::xyl (C++ member), 553  
 esp\_ble\_mesh\_lighting\_server\_recv\_set\_msg\_t::xyl (C++ member), 553  
 esp\_ble\_mesh\_lighting\_server\_recv\_set\_msg\_t::xyl (C++ member), 553  
 esp\_ble\_mesh\_lighting\_server\_recv\_set\_msg\_t::xyl (C++ member), 553  
 esp\_ble\_mesh\_lighting\_server\_recv\_status\_msg\_t (C++ member), 553







- (*C macro*), 491
- ESP\_BLE\_MESH\_MODEL\_GEN\_DEF\_TRANS\_TIME\_SRV (*C macro*), 493
- ESP\_BLE\_MESH\_MODEL\_GEN\_LEVEL\_CLI (*C macro*), 491
- ESP\_BLE\_MESH\_MODEL\_GEN\_LEVEL\_SRV (*C macro*), 493
- ESP\_BLE\_MESH\_MODEL\_GEN\_LOCATION\_CLI (*C macro*), 492
- ESP\_BLE\_MESH\_MODEL\_GEN\_LOCATION\_SETUP\_SRV (*C macro*), 495
- ESP\_BLE\_MESH\_MODEL\_GEN\_LOCATION\_SRV (*C macro*), 495
- ESP\_BLE\_MESH\_MODEL\_GEN\_MANUFACTURER\_PROP\_SRV (*C macro*), 496
- ESP\_BLE\_MESH\_MODEL\_GEN\_ONOFF\_CLI (*C macro*), 491
- ESP\_BLE\_MESH\_MODEL\_GEN\_ONOFF\_SRV (*C macro*), 493
- ESP\_BLE\_MESH\_MODEL\_GEN\_POWER\_LEVEL\_CLI (*C macro*), 492
- ESP\_BLE\_MESH\_MODEL\_GEN\_POWER\_LEVEL\_SETUP\_SRV (*C macro*), 494
- ESP\_BLE\_MESH\_MODEL\_GEN\_POWER\_LEVEL\_SRV (*C macro*), 494
- ESP\_BLE\_MESH\_MODEL\_GEN\_POWER\_ONOFF\_CLI (*C macro*), 492
- ESP\_BLE\_MESH\_MODEL\_GEN\_POWER\_ONOFF\_SETUP\_SRV (*C macro*), 494
- ESP\_BLE\_MESH\_MODEL\_GEN\_POWER\_ONOFF\_SRV (*C macro*), 493
- ESP\_BLE\_MESH\_MODEL\_GEN\_PROPERTY\_CLI (*C macro*), 492
- ESP\_BLE\_MESH\_MODEL\_GEN\_USER\_PROP\_SRV (*C macro*), 495
- ESP\_BLE\_MESH\_MODEL\_GROUPS\_UNASSIGNED (*C macro*), 356
- ESP\_BLE\_MESH\_MODEL\_HEALTH\_CLI (*C macro*), 454
- ESP\_BLE\_MESH\_MODEL\_HEALTH\_SRV (*C macro*), 454
- ESP\_BLE\_MESH\_MODEL\_ID\_AGG\_CLI (*C macro*), 363
- ESP\_BLE\_MESH\_MODEL\_ID\_AGG\_SRV (*C macro*), 363
- ESP\_BLE\_MESH\_MODEL\_ID\_BRC\_CLI (*C macro*), 363
- ESP\_BLE\_MESH\_MODEL\_ID\_BRC\_SRV (*C macro*), 362
- ESP\_BLE\_MESH\_MODEL\_ID\_CONFIG\_CLI (*C macro*), 362
- ESP\_BLE\_MESH\_MODEL\_ID\_CONFIG\_SRV (*C macro*), 362
- ESP\_BLE\_MESH\_MODEL\_ID\_DF\_CLI (*C macro*), 362
- ESP\_BLE\_MESH\_MODEL\_ID\_DF\_SRV (*C macro*), 362
- ESP\_BLE\_MESH\_MODEL\_ID\_GEN\_ADMIN\_PROP\_SRV (*C macro*), 364
- (*C macro*), 364
- ESP\_BLE\_MESH\_MODEL\_ID\_GEN\_BATTERY\_CLI (*C macro*), 364
- ESP\_BLE\_MESH\_MODEL\_ID\_GEN\_BATTERY\_SRV (*C macro*), 364
- ESP\_BLE\_MESH\_MODEL\_ID\_GEN\_CLIENT\_PROP\_SRV (*C macro*), 364
- ESP\_BLE\_MESH\_MODEL\_ID\_GEN\_DEF\_TRANS\_TIME\_CLI (*C macro*), 363
- ESP\_BLE\_MESH\_MODEL\_ID\_GEN\_DEF\_TRANS\_TIME\_SRV (*C macro*), 363
- ESP\_BLE\_MESH\_MODEL\_ID\_GEN\_LEVEL\_CLI (*C macro*), 363
- ESP\_BLE\_MESH\_MODEL\_ID\_GEN\_LEVEL\_SRV (*C macro*), 363
- ESP\_BLE\_MESH\_MODEL\_ID\_GEN\_LOCATION\_CLI (*C macro*), 364
- ESP\_BLE\_MESH\_MODEL\_ID\_GEN\_LOCATION\_SETUP\_SRV (*C macro*), 364
- ESP\_BLE\_MESH\_MODEL\_ID\_GEN\_LOCATION\_SRV (*C macro*), 364
- ESP\_BLE\_MESH\_MODEL\_ID\_GEN\_MANUFACTURER\_PROP\_SRV (*C macro*), 364
- ESP\_BLE\_MESH\_MODEL\_ID\_GEN\_ONOFF\_CLI (*C macro*), 363
- ESP\_BLE\_MESH\_MODEL\_ID\_GEN\_ONOFF\_SRV (*C macro*), 363
- ESP\_BLE\_MESH\_MODEL\_ID\_GEN\_POWER\_LEVEL\_CLI (*C macro*), 364
- ESP\_BLE\_MESH\_MODEL\_ID\_GEN\_POWER\_LEVEL\_SETUP\_SRV (*C macro*), 364
- ESP\_BLE\_MESH\_MODEL\_ID\_GEN\_POWER\_LEVEL\_SRV (*C macro*), 363
- ESP\_BLE\_MESH\_MODEL\_ID\_GEN\_POWER\_ONOFF\_CLI (*C macro*), 363
- ESP\_BLE\_MESH\_MODEL\_ID\_GEN\_POWER\_ONOFF\_SETUP\_SRV (*C macro*), 364
- ESP\_BLE\_MESH\_MODEL\_ID\_GEN\_POWER\_ONOFF\_SRV (*C macro*), 364
- ESP\_BLE\_MESH\_MODEL\_ID\_GEN\_PROP\_CLI (*C macro*), 364
- ESP\_BLE\_MESH\_MODEL\_ID\_GEN\_USER\_PROP\_SRV (*C macro*), 364
- ESP\_BLE\_MESH\_MODEL\_ID\_HEALTH\_CLI (*C macro*), 362
- ESP\_BLE\_MESH\_MODEL\_ID\_HEALTH\_SRV (*C macro*), 362
- ESP\_BLE\_MESH\_MODEL\_ID\_LCD\_CLI (*C macro*), 363
- ESP\_BLE\_MESH\_MODEL\_ID\_LCD\_SRV (*C macro*), 363
- ESP\_BLE\_MESH\_MODEL\_ID\_LIGHT\_CTL\_CLI (*C macro*), 365
- ESP\_BLE\_MESH\_MODEL\_ID\_LIGHT\_CTL\_SETUP\_SRV (*C macro*), 365
- ESP\_BLE\_MESH\_MODEL\_ID\_LIGHT\_CTL\_SRV (*C macro*), 365
- ESP\_BLE\_MESH\_MODEL\_ID\_LIGHT\_CTL\_TEMP\_SRV (*C macro*), 365

- (*C macro*), 365
- ESP\_BLE\_MESH\_MODEL\_ID\_LIGHT\_HSL\_CLI (*C macro*), 365
- ESP\_BLE\_MESH\_MODEL\_ID\_LIGHT\_HSL\_HUE\_SRV (*C macro*), 365
- ESP\_BLE\_MESH\_MODEL\_ID\_LIGHT\_HSL\_SAT\_SRV (*C macro*), 365
- ESP\_BLE\_MESH\_MODEL\_ID\_LIGHT\_HSL\_SETUP\_SRV (*C macro*), 365
- ESP\_BLE\_MESH\_MODEL\_ID\_LIGHT\_HSL\_SRV (*C macro*), 365
- ESP\_BLE\_MESH\_MODEL\_ID\_LIGHT\_LC\_CLI (*C macro*), 365
- ESP\_BLE\_MESH\_MODEL\_ID\_LIGHT\_LC\_SETUP\_SRV (*C macro*), 365
- ESP\_BLE\_MESH\_MODEL\_ID\_LIGHT\_LC\_SRV (*C macro*), 365
- ESP\_BLE\_MESH\_MODEL\_ID\_LIGHT\_LIGHTNESS\_CLI (*C macro*), 365
- ESP\_BLE\_MESH\_MODEL\_ID\_LIGHT\_LIGHTNESS\_SETUP\_SRV (*C macro*), 365
- ESP\_BLE\_MESH\_MODEL\_ID\_LIGHT\_LIGHTNESS\_SRV (*C macro*), 365
- ESP\_BLE\_MESH\_MODEL\_ID\_LIGHT\_XYL\_CLI (*C macro*), 365
- ESP\_BLE\_MESH\_MODEL\_ID\_LIGHT\_XYL\_SETUP\_SRV (*C macro*), 365
- ESP\_BLE\_MESH\_MODEL\_ID\_LIGHT\_XYL\_SRV (*C macro*), 365
- ESP\_BLE\_MESH\_MODEL\_ID\_MBT\_CLI (*C macro*), 365
- ESP\_BLE\_MESH\_MODEL\_ID\_MBT\_SRV (*C macro*), 365
- ESP\_BLE\_MESH\_MODEL\_ID\_ODP\_CLI (*C macro*), 363
- ESP\_BLE\_MESH\_MODEL\_ID\_ODP\_SRV (*C macro*), 363
- ESP\_BLE\_MESH\_MODEL\_ID\_PRB\_CLI (*C macro*), 363
- ESP\_BLE\_MESH\_MODEL\_ID\_PRB\_SRV (*C macro*), 363
- ESP\_BLE\_MESH\_MODEL\_ID\_RPR\_CLI (*C macro*), 362
- ESP\_BLE\_MESH\_MODEL\_ID\_RPR\_SRV (*C macro*), 362
- ESP\_BLE\_MESH\_MODEL\_ID\_SAR\_CLI (*C macro*), 363
- ESP\_BLE\_MESH\_MODEL\_ID\_SAR\_SRV (*C macro*), 363
- ESP\_BLE\_MESH\_MODEL\_ID\_SCENE\_CLI (*C macro*), 364
- ESP\_BLE\_MESH\_MODEL\_ID\_SCENE\_SETUP\_SRV (*C macro*), 364
- ESP\_BLE\_MESH\_MODEL\_ID\_SCENE\_SRV (*C macro*), 364
- ESP\_BLE\_MESH\_MODEL\_ID\_SCHEDULER\_CLI (*C macro*), 365
- ESP\_BLE\_MESH\_MODEL\_ID\_SCHEDULER\_SETUP\_SRV (*C macro*), 365
- ESP\_BLE\_MESH\_MODEL\_ID\_SCHEDULER\_SRV (*C macro*), 364
- ESP\_BLE\_MESH\_MODEL\_ID\_SENSOR\_CLI (*C macro*), 364
- ESP\_BLE\_MESH\_MODEL\_ID\_SENSOR\_SETUP\_SRV (*C macro*), 364
- ESP\_BLE\_MESH\_MODEL\_ID\_SENSOR\_SRV (*C macro*), 364
- ESP\_BLE\_MESH\_MODEL\_ID\_SRPL\_CLI (*C macro*), 363
- ESP\_BLE\_MESH\_MODEL\_ID\_SRPL\_SRV (*C macro*), 363
- ESP\_BLE\_MESH\_MODEL\_ID\_TIME\_CLI (*C macro*), 364
- ESP\_BLE\_MESH\_MODEL\_ID\_TIME\_SETUP\_SRV (*C macro*), 364
- ESP\_BLE\_MESH\_MODEL\_ID\_TIME\_SRV (*C macro*), 364
- ESP\_BLE\_MESH\_MODEL\_ITEM\_LONG (*C macro*), 689
- ESP\_BLE\_MESH\_MODEL\_ITEM\_SHORT (*C macro*), 689
- esp\_ble\_mesh\_model\_item\_t (*C++ struct*), 687
- esp\_ble\_mesh\_model\_item\_t::corresponding\_group\_id (*C++ member*), 687
- esp\_ble\_mesh\_model\_item\_t::corresponding\_present (*C++ member*), 687
- esp\_ble\_mesh\_model\_item\_t::extended\_items\_count (*C++ member*), 687
- esp\_ble\_mesh\_model\_item\_t::extended\_model\_items (*C++ member*), 687
- esp\_ble\_mesh\_model\_item\_t::format (*C++ member*), 687
- ESP\_BLE\_MESH\_MODEL\_KEYS\_UNUSED (*C macro*), 356
- ESP\_BLE\_MESH\_MODEL\_LCD\_CLI (*C macro*), 684
- ESP\_BLE\_MESH\_MODEL\_LCD\_SRV (*C macro*), 684
- ESP\_BLE\_MESH\_MODEL\_LIGHT\_CTL\_CLI (*C macro*), 596
- ESP\_BLE\_MESH\_MODEL\_LIGHT\_CTL\_SETUP\_SRV (*C macro*), 598
- ESP\_BLE\_MESH\_MODEL\_LIGHT\_CTL\_SRV (*C macro*), 598
- ESP\_BLE\_MESH\_MODEL\_LIGHT\_CTL\_TEMP\_SRV (*C macro*), 598
- ESP\_BLE\_MESH\_MODEL\_LIGHT\_HSL\_CLI (*C macro*), 597
- ESP\_BLE\_MESH\_MODEL\_LIGHT\_HSL\_HUE\_SRV (*C macro*), 599
- ESP\_BLE\_MESH\_MODEL\_LIGHT\_HSL\_SAT\_SRV (*C macro*), 599
- ESP\_BLE\_MESH\_MODEL\_LIGHT\_HSL\_SETUP\_SRV (*C macro*), 599
- ESP\_BLE\_MESH\_MODEL\_LIGHT\_HSL\_SRV (*C macro*), 599
- ESP\_BLE\_MESH\_MODEL\_LIGHT\_LC\_CLI (*C macro*), 597

- ESP\_BLE\_MESH\_MODEL\_LIGHT\_LC\_SETUP\_SRV (C macro), 601
- ESP\_BLE\_MESH\_MODEL\_LIGHT\_LC\_SRV (C macro), 600
- ESP\_BLE\_MESH\_MODEL\_LIGHT\_LIGHTNESS\_CLI (C macro), 596
- ESP\_BLE\_MESH\_MODEL\_LIGHT\_LIGHTNESS\_SETUP\_SRV (C macro), 598
- ESP\_BLE\_MESH\_MODEL\_LIGHT\_LIGHTNESS\_SRV (C macro), 597
- ESP\_BLE\_MESH\_MODEL\_LIGHT\_XYL\_CLI (C macro), 597
- ESP\_BLE\_MESH\_MODEL\_LIGHT\_XYL\_SETUP\_SRV (C macro), 600
- ESP\_BLE\_MESH\_MODEL\_LIGHT\_XYL\_SRV (C macro), 600
- esp\_ble\_mesh\_model\_msg\_opcode\_init (C++ function), 398
- ESP\_BLE\_MESH\_MODEL\_NONE (C macro), 361
- ESP\_BLE\_MESH\_MODEL\_ODP\_CLI (C macro), 664
- ESP\_BLE\_MESH\_MODEL\_ODP\_SRV (C macro), 664
- ESP\_BLE\_MESH\_MODEL\_OP (C macro), 361
- ESP\_BLE\_MESH\_MODEL\_OP\_1 (C macro), 359
- ESP\_BLE\_MESH\_MODEL\_OP\_2 (C macro), 359
- ESP\_BLE\_MESH\_MODEL\_OP\_3 (C macro), 359
- ESP\_BLE\_MESH\_MODEL\_OP\_AGG\_SEQUENCE (C macro), 679
- ESP\_BLE\_MESH\_MODEL\_OP\_AGG\_STATUS (C macro), 679
- ESP\_BLE\_MESH\_MODEL\_OP\_APP\_KEY\_ADD (C macro), 367
- ESP\_BLE\_MESH\_MODEL\_OP\_APP\_KEY\_DELETE (C macro), 368
- ESP\_BLE\_MESH\_MODEL\_OP\_APP\_KEY\_GET (C macro), 366
- ESP\_BLE\_MESH\_MODEL\_OP\_APP\_KEY\_LIST (C macro), 369
- ESP\_BLE\_MESH\_MODEL\_OP\_APP\_KEY\_STATUS (C macro), 369
- ESP\_BLE\_MESH\_MODEL\_OP\_APP\_KEY\_UPDATE (C macro), 368
- ESP\_BLE\_MESH\_MODEL\_OP\_ATTENTION\_GET (C macro), 371
- ESP\_BLE\_MESH\_MODEL\_OP\_ATTENTION\_SET (C macro), 371
- ESP\_BLE\_MESH\_MODEL\_OP\_ATTENTION\_SET\_UNACK (C macro), 371
- ESP\_BLE\_MESH\_MODEL\_OP\_ATTENTION\_STATUS (C macro), 371
- ESP\_BLE\_MESH\_MODEL\_OP\_BEACON\_GET (C macro), 365
- ESP\_BLE\_MESH\_MODEL\_OP\_BEACON\_SET (C macro), 367
- ESP\_BLE\_MESH\_MODEL\_OP\_BEACON\_STATUS (C macro), 368
- ESP\_BLE\_MESH\_MODEL\_OP\_BRIDGED\_SUBNETS\_GET (C macro), 652
- ESP\_BLE\_MESH\_MODEL\_OP\_BRIDGED\_SUBNETS\_LIST (C macro), 652
- ESP\_BLE\_MESH\_MODEL\_OP\_BRIDGING\_TABLE\_ADD (C macro), 652
- ESP\_BLE\_MESH\_MODEL\_OP\_BRIDGING\_TABLE\_GET (C macro), 652
- ESP\_BLE\_MESH\_MODEL\_OP\_BRIDGING\_TABLE\_LIST (C macro), 652
- ESP\_BLE\_MESH\_MODEL\_OP\_BRIDGING\_TABLE\_REMOVE (C macro), 652
- ESP\_BLE\_MESH\_MODEL\_OP\_BRIDGING\_TABLE\_SIZE\_GET (C macro), 652
- ESP\_BLE\_MESH\_MODEL\_OP\_BRIDGING\_TABLE\_SIZE\_STATUS (C macro), 652
- ESP\_BLE\_MESH\_MODEL\_OP\_BRIDGING\_TABLE\_STATUS (C macro), 652
- ESP\_BLE\_MESH\_MODEL\_OP\_COMPOSITION\_DATA\_GET (C macro), 366
- ESP\_BLE\_MESH\_MODEL\_OP\_COMPOSITION\_DATA\_STATUS (C macro), 368
- ESP\_BLE\_MESH\_MODEL\_OP\_DEFAULT\_TTL\_GET (C macro), 366
- ESP\_BLE\_MESH\_MODEL\_OP\_DEFAULT\_TTL\_SET (C macro), 367
- ESP\_BLE\_MESH\_MODEL\_OP\_DEFAULT\_TTL\_STATUS (C macro), 368
- ESP\_BLE\_MESH\_MODEL\_OP\_DIRECTED\_CONTROL\_GET (C macro), 639
- ESP\_BLE\_MESH\_MODEL\_OP\_DIRECTED\_CONTROL\_SET (C macro), 639
- ESP\_BLE\_MESH\_MODEL\_OP\_DIRECTED\_CONTROL\_STATUS (C macro), 639
- ESP\_BLE\_MESH\_MODEL\_OP\_DIRECTED\_CTL\_NET\_TRANSMIT\_GET (C macro), 641
- ESP\_BLE\_MESH\_MODEL\_OP\_DIRECTED\_CTL\_NET\_TRANSMIT\_SET (C macro), 641
- ESP\_BLE\_MESH\_MODEL\_OP\_DIRECTED\_CTL\_NET\_TRANSMIT\_STATUS (C macro), 642
- ESP\_BLE\_MESH\_MODEL\_OP\_DIRECTED\_CTL\_RELAY\_RETRANSMIT\_GET (C macro), 642
- ESP\_BLE\_MESH\_MODEL\_OP\_DIRECTED\_CTL\_RELAY\_RETRANSMIT\_SET (C macro), 642
- ESP\_BLE\_MESH\_MODEL\_OP\_DIRECTED\_CTL\_RELAY\_RETRANSMIT\_STATUS (C macro), 642
- ESP\_BLE\_MESH\_MODEL\_OP\_DIRECTED\_NET\_TRANSMIT\_GET (C macro), 641
- ESP\_BLE\_MESH\_MODEL\_OP\_DIRECTED\_NET\_TRANSMIT\_SET (C macro), 641
- ESP\_BLE\_MESH\_MODEL\_OP\_DIRECTED\_NET\_TRANSMIT\_STATUS (C macro), 641
- ESP\_BLE\_MESH\_MODEL\_OP\_DIRECTED\_PATHS\_GET (C macro), 641
- ESP\_BLE\_MESH\_MODEL\_OP\_DIRECTED\_PATHS\_STATUS (C macro), 641
- ESP\_BLE\_MESH\_MODEL\_OP\_DIRECTED\_PUB\_POLICY\_GET (C macro), 641
- ESP\_BLE\_MESH\_MODEL\_OP\_DIRECTED\_PUB\_POLICY\_SET (C macro), 641
- ESP\_BLE\_MESH\_MODEL\_OP\_DIRECTED\_PUB\_POLICY\_STATUS (C macro), 641





ESP\_BLE\_MESH\_MODEL\_OP\_GEN\_MANUFACTURER\_PROPERTY\_STATUS (C macro), 374

ESP\_BLE\_MESH\_MODEL\_OP\_GEN\_MOVE\_SET (C macro), 372

ESP\_BLE\_MESH\_MODEL\_OP\_GEN\_MOVE\_SET\_UNACK (C macro), 372

ESP\_BLE\_MESH\_MODEL\_OP\_GEN\_ONOFF\_GET (C macro), 371

ESP\_BLE\_MESH\_MODEL\_OP\_GEN\_ONOFF\_SET (C macro), 371

ESP\_BLE\_MESH\_MODEL\_OP\_GEN\_ONOFF\_SET\_UNACK (C macro), 371

ESP\_BLE\_MESH\_MODEL\_OP\_GEN\_ONOFF\_STATUS (C macro), 371

ESP\_BLE\_MESH\_MODEL\_OP\_GEN\_ONPOWERUP\_GET (C macro), 372

ESP\_BLE\_MESH\_MODEL\_OP\_GEN\_ONPOWERUP\_SET (C macro), 372

ESP\_BLE\_MESH\_MODEL\_OP\_GEN\_ONPOWERUP\_SET\_UNACK (C macro), 372

ESP\_BLE\_MESH\_MODEL\_OP\_GEN\_ONPOWERUP\_STATUS (C macro), 372

ESP\_BLE\_MESH\_MODEL\_OP\_GEN\_POWER\_DEFAULT\_SET (C macro), 373

ESP\_BLE\_MESH\_MODEL\_OP\_GEN\_POWER\_DEFAULT\_SET\_UNACK (C macro), 373

ESP\_BLE\_MESH\_MODEL\_OP\_GEN\_POWER\_DEFAULT\_STATUS (C macro), 373

ESP\_BLE\_MESH\_MODEL\_OP\_GEN\_POWER\_DEFAULT\_UNACK (C macro), 373

ESP\_BLE\_MESH\_MODEL\_OP\_GEN\_POWER\_LAST\_GET (C macro), 372

ESP\_BLE\_MESH\_MODEL\_OP\_GEN\_POWER\_LAST\_STATUS (C macro), 372

ESP\_BLE\_MESH\_MODEL\_OP\_GEN\_POWER\_LEVEL\_GET (C macro), 372

ESP\_BLE\_MESH\_MODEL\_OP\_GEN\_POWER\_LEVEL\_SET (C macro), 372

ESP\_BLE\_MESH\_MODEL\_OP\_GEN\_POWER\_LEVEL\_SET\_UNACK (C macro), 372

ESP\_BLE\_MESH\_MODEL\_OP\_GEN\_POWER\_LEVEL\_STATUS (C macro), 372

ESP\_BLE\_MESH\_MODEL\_OP\_GEN\_POWER\_LEVEL\_UNACK (C macro), 372

ESP\_BLE\_MESH\_MODEL\_OP\_GEN\_POWER\_RANGE\_GET (C macro), 373

ESP\_BLE\_MESH\_MODEL\_OP\_GEN\_POWER\_RANGE\_SET (C macro), 373

ESP\_BLE\_MESH\_MODEL\_OP\_GEN\_POWER\_RANGE\_SET\_UNACK (C macro), 373

ESP\_BLE\_MESH\_MODEL\_OP\_GEN\_POWER\_RANGE\_STATUS (C macro), 373

ESP\_BLE\_MESH\_MODEL\_OP\_GEN\_POWER\_RANGE\_UNACK (C macro), 373

ESP\_BLE\_MESH\_MODEL\_OP\_GEN\_USER\_PROPERTY\_GET (C macro), 374

ESP\_BLE\_MESH\_MODEL\_OP\_GEN\_USER\_PROPERTY\_SET (C macro), 374

ESP\_BLE\_MESH\_MODEL\_OP\_GEN\_USER\_PROPERTY\_SET\_UNACK (C macro), 374

ESP\_BLE\_MESH\_MODEL\_OP\_GEN\_USER\_PROPERTY\_STATUS (C macro), 374

ESP\_BLE\_MESH\_MODEL\_OP\_HEALTH\_CURRENT\_STATUS (C macro), 371

ESP\_BLE\_MESH\_MODEL\_OP\_HEALTH\_FAULT\_CLEAR (C macro), 371

ESP\_BLE\_MESH\_MODEL\_OP\_HEALTH\_FAULT\_CLEAR\_UNACK (C macro), 371

ESP\_BLE\_MESH\_MODEL\_OP\_HEALTH\_FAULT\_GET (C macro), 370

ESP\_BLE\_MESH\_MODEL\_OP\_HEALTH\_FAULT\_STATUS (C macro), 371

ESP\_BLE\_MESH\_MODEL\_OP\_HEALTH\_FAULT\_TEST (C macro), 371

ESP\_BLE\_MESH\_MODEL\_OP\_HEALTH\_FAULT\_TEST\_UNACK (C macro), 371

ESP\_BLE\_MESH\_MODEL\_OP\_HEALTH\_PERIOD\_GET (C macro), 370

ESP\_BLE\_MESH\_MODEL\_OP\_HEALTH\_PERIOD\_SET (C macro), 371

ESP\_BLE\_MESH\_MODEL\_OP\_HEALTH\_PERIOD\_SET\_UNACK (C macro), 371

ESP\_BLE\_MESH\_MODEL\_OP\_HEALTH\_PERIOD\_STATUS (C macro), 371

ESP\_BLE\_MESH\_MODEL\_OP\_HEARTBEAT\_PUB\_GET (C macro), 366

ESP\_BLE\_MESH\_MODEL\_OP\_HEARTBEAT\_PUB\_SET (C macro), 368

ESP\_BLE\_MESH\_MODEL\_OP\_HEARTBEAT\_PUB\_STATUS (C macro), 369

ESP\_BLE\_MESH\_MODEL\_OP\_HEARTBEAT\_SUB\_GET (C macro), 366

ESP\_BLE\_MESH\_MODEL\_OP\_HEARTBEAT\_SUB\_SET (C macro), 368

ESP\_BLE\_MESH\_MODEL\_OP\_HEARTBEAT\_SUB\_STATUS (C macro), 369

ESP\_BLE\_MESH\_MODEL\_OP\_KEY\_REFRESH\_PHASE\_GET (C macro), 366

ESP\_BLE\_MESH\_MODEL\_OP\_KEY\_REFRESH\_PHASE\_SET (C macro), 368

ESP\_BLE\_MESH\_MODEL\_OP\_KEY\_REFRESH\_PHASE\_STATUS (C macro), 369

ESP\_BLE\_MESH\_MODEL\_OP\_LARGE\_COMP\_DATA\_GET (C macro), 684

ESP\_BLE\_MESH\_MODEL\_OP\_LARGE\_COMP\_DATA\_STATUS (C macro), 684

ESP\_BLE\_MESH\_MODEL\_OP\_LIGHT\_CTL\_DEFAULT\_GET (C macro), 378

ESP\_BLE\_MESH\_MODEL\_OP\_LIGHT\_CTL\_DEFAULT\_SET (C macro), 378

ESP\_BLE\_MESH\_MODEL\_OP\_LIGHT\_CTL\_DEFAULT\_SET\_UNACK (C macro), 378

ESP\_BLE\_MESH\_MODEL\_OP\_LIGHT\_CTL\_DEFAULT\_STATUS (C macro), 378

ESP\_BLE\_MESH\_MODEL\_OP\_LIGHT\_CTL\_GET (C macro), 377





ESP\_BLE\_MESH\_MODEL\_OP\_LIGHT\_LIGHTNESS\_ENABLE\_MESH\_MACR  
 (C macro), 377

ESP\_BLE\_MESH\_MODEL\_OP\_LIGHT\_LIGHTNESS\_ENABLE\_MESH\_MACR  
 (C macro), 377

ESP\_BLE\_MESH\_MODEL\_OP\_LIGHT\_LIGHTNESS\_ENABLE\_MESH\_MODEL\_OP\_MODEL\_PUB\_VIRTUAL\_ADDR\_SET  
 (C macro), 377

ESP\_BLE\_MESH\_MODEL\_OP\_LIGHT\_LIGHTNESS\_ENABLE\_MESH\_MODEL\_OP\_MODEL\_SUB\_ADD (C  
 (C macro), 377

ESP\_BLE\_MESH\_MODEL\_OP\_LIGHT\_LIGHTNESS\_ENABLE\_MESH\_MODEL\_OP\_MODEL\_SUB\_DELETE  
 (C macro), 377

ESP\_BLE\_MESH\_MODEL\_OP\_LIGHT\_LIGHTNESS\_ENABLE\_MESH\_MODEL\_OP\_MODEL\_SUB\_DELETE\_ALL  
 (C macro), 377

ESP\_BLE\_MESH\_MODEL\_OP\_LIGHT\_LIGHTNESS\_ENABLE\_MESH\_MODEL\_OP\_MODEL\_SUB\_OVERWRITE  
 (C macro), 376

ESP\_BLE\_MESH\_MODEL\_OP\_LIGHT\_LIGHTNESS\_ENABLE\_MESH\_MODEL\_OP\_MODEL\_SUB\_STATUS  
 (C macro), 377

ESP\_BLE\_MESH\_MODEL\_OP\_LIGHT\_LIGHTNESS\_ENABLE\_MESH\_MODEL\_OP\_MODEL\_SUB\_VIRTUAL\_ADDR\_ADD  
 (C macro), 377

ESP\_BLE\_MESH\_MODEL\_OP\_LIGHT\_XYL\_DEFAULT\_ENABLE\_MESH\_MODEL\_OP\_MODEL\_SUB\_VIRTUAL\_ADDR\_DELETE  
 (C macro), 379

ESP\_BLE\_MESH\_MODEL\_OP\_LIGHT\_XYL\_DEFAULT\_ENABLE\_MESH\_MODEL\_OP\_MODEL\_SUB\_VIRTUAL\_ADDR\_OVERWRITE  
 (C macro), 379

ESP\_BLE\_MESH\_MODEL\_OP\_LIGHT\_XYL\_DEFAULT\_ENABLE\_MESH\_MODEL\_OP\_MODELS\_METADATA\_GET  
 (C macro), 379

ESP\_BLE\_MESH\_MODEL\_OP\_LIGHT\_XYL\_DEFAULT\_ENABLE\_MESH\_MODEL\_OP\_MODELS\_METADATA\_STATUS  
 (C macro), 379

ESP\_BLE\_MESH\_MODEL\_OP\_LIGHT\_XYL\_GET (C ESP\_BLE\_MESH\_MODEL\_OP\_NET\_KEY\_ADD (C  
 macro), 379 macro), 367

ESP\_BLE\_MESH\_MODEL\_OP\_LIGHT\_XYL\_RANGE\_GET ESP\_BLE\_MESH\_MODEL\_OP\_NET\_KEY\_DELETE  
 (C macro), 379 (C macro), 368

ESP\_BLE\_MESH\_MODEL\_OP\_LIGHT\_XYL\_RANGE\_SET ESP\_BLE\_MESH\_MODEL\_OP\_NET\_KEY\_GET (C  
 (C macro), 380 macro), 366

ESP\_BLE\_MESH\_MODEL\_OP\_LIGHT\_XYL\_RANGE\_SET ESP\_BLE\_MESH\_MODEL\_OP\_NET\_KEY\_LIST (C  
 (C macro), 380 macro), 369

ESP\_BLE\_MESH\_MODEL\_OP\_LIGHT\_XYL\_RANGE\_SET ESP\_BLE\_MESH\_MODEL\_OP\_NET\_KEY\_STATUS  
 (C macro), 379 (C macro), 369

ESP\_BLE\_MESH\_MODEL\_OP\_LIGHT\_XYL\_SET (C ESP\_BLE\_MESH\_MODEL\_OP\_NET\_KEY\_UPDATE  
 macro), 379 (C macro), 368

ESP\_BLE\_MESH\_MODEL\_OP\_LIGHT\_XYL\_SET\_UNACK ESP\_BLE\_MESH\_MODEL\_OP\_NETWORK\_TRANSMIT\_GET  
 (C macro), 379 (C macro), 367

ESP\_BLE\_MESH\_MODEL\_OP\_LIGHT\_XYL\_STATUS ESP\_BLE\_MESH\_MODEL\_OP\_NETWORK\_TRANSMIT\_SET  
 (C macro), 379 (C macro), 368

ESP\_BLE\_MESH\_MODEL\_OP\_LIGHT\_XYL\_TARGET\_GET ESP\_BLE\_MESH\_MODEL\_OP\_NETWORK\_TRANSMIT\_STATUS  
 (C macro), 379 (C macro), 369

ESP\_BLE\_MESH\_MODEL\_OP\_LIGHT\_XYL\_TARGET\_SET ESP\_BLE\_MESH\_MODEL\_OP\_NODE\_IDENTITY\_GET  
 (C macro), 379 (C macro), 366

ESP\_BLE\_MESH\_MODEL\_OP\_LPN\_POLLTIMEOUT\_GET ESP\_BLE\_MESH\_MODEL\_OP\_NODE\_IDENTITY\_SET  
 (C macro), 367 (C macro), 368

ESP\_BLE\_MESH\_MODEL\_OP\_LPN\_POLLTIMEOUT\_SET ESP\_BLE\_MESH\_MODEL\_OP\_NODE\_IDENTITY\_STATUS  
 (C macro), 369 (C macro), 369

ESP\_BLE\_MESH\_MODEL\_OP\_MODEL\_APP\_BIND ESP\_BLE\_MESH\_MODEL\_OP\_NODE\_RESET (C  
 (C macro), 367 macro), 368

ESP\_BLE\_MESH\_MODEL\_OP\_MODEL\_APP\_STATUS ESP\_BLE\_MESH\_MODEL\_OP\_NODE\_RESET\_STATUS  
 (C macro), 369 (C macro), 369

ESP\_BLE\_MESH\_MODEL\_OP\_MODEL\_APP\_UNBIND ESP\_BLE\_MESH\_MODEL\_OP\_OD\_PRIV\_PROXY\_GET  
 (C macro), 368 (C macro), 664

ESP\_BLE\_MESH\_MODEL\_OP\_MODEL\_PUB\_GET (C ESP\_BLE\_MESH\_MODEL\_OP\_OD\_PRIV\_PROXY\_SET  
 macro), 366 (C macro), 664

ESP\_BLE\_MESH\_MODEL\_OP\_OD\_PRIV\_PROXY\_STATUS (C macro), 664

ESP\_BLE\_MESH\_MODEL\_OP\_OD\_PRIV\_PROXY\_STATUS (C macro), 612

ESP\_BLE\_MESH\_MODEL\_OP\_PATH\_DISCOVERY\_TIMEOUT (C macro), 641

ESP\_BLE\_MESH\_MODEL\_OP\_PATH\_DISCOVERY\_TIMEOUT (C macro), 612

ESP\_BLE\_MESH\_MODEL\_OP\_PATH\_DISCOVERY\_TIMEOUT (C macro), 641

ESP\_BLE\_MESH\_MODEL\_OP\_PATH\_DISCOVERY\_TIMEOUT (C macro), 612

ESP\_BLE\_MESH\_MODEL\_OP\_PATH\_ECHO\_INTERVAL\_GET (C macro), 641

ESP\_BLE\_MESH\_MODEL\_OP\_PATH\_ECHO\_INTERVAL\_GET (C macro), 611

ESP\_BLE\_MESH\_MODEL\_OP\_PATH\_ECHO\_INTERVAL\_GET (C macro), 641

ESP\_BLE\_MESH\_MODEL\_OP\_PATH\_ECHO\_INTERVAL\_GET (C macro), 611

ESP\_BLE\_MESH\_MODEL\_OP\_PATH\_ECHO\_INTERVAL\_STATUS (C macro), 640

ESP\_BLE\_MESH\_MODEL\_OP\_PATH\_ECHO\_INTERVAL\_STATUS (C macro), 611

ESP\_BLE\_MESH\_MODEL\_OP\_PATH\_METRIC\_GET (C macro), 640

ESP\_BLE\_MESH\_MODEL\_OP\_PATH\_METRIC\_GET (C macro), 611

ESP\_BLE\_MESH\_MODEL\_OP\_PATH\_METRIC\_SET (C macro), 640

ESP\_BLE\_MESH\_MODEL\_OP\_PATH\_METRIC\_SET (C macro), 611

ESP\_BLE\_MESH\_MODEL\_OP\_PATH\_METRIC\_STATUS (C macro), 640

ESP\_BLE\_MESH\_MODEL\_OP\_PATH\_METRIC\_STATUS (C macro), 611

ESP\_BLE\_MESH\_MODEL\_OP\_PRIV\_BEACON\_GET (C macro), 659

ESP\_BLE\_MESH\_MODEL\_OP\_PRIV\_BEACON\_GET (C macro), 641

ESP\_BLE\_MESH\_MODEL\_OP\_PRIV\_BEACON\_SET (C macro), 659

ESP\_BLE\_MESH\_MODEL\_OP\_PRIV\_BEACON\_SET (C macro), 641

ESP\_BLE\_MESH\_MODEL\_OP\_PRIV\_BEACON\_STATUS (C macro), 659

ESP\_BLE\_MESH\_MODEL\_OP\_PRIV\_BEACON\_STATUS (C macro), 641

ESP\_BLE\_MESH\_MODEL\_OP\_PRIV\_GATT\_PROXY\_GET (C macro), 659

ESP\_BLE\_MESH\_MODEL\_OP\_PRIV\_GATT\_PROXY\_GET (C macro), 670

ESP\_BLE\_MESH\_MODEL\_OP\_PRIV\_GATT\_PROXY\_SET (C macro), 659

ESP\_BLE\_MESH\_MODEL\_OP\_PRIV\_GATT\_PROXY\_SET (C macro), 670

ESP\_BLE\_MESH\_MODEL\_OP\_PRIV\_GATT\_PROXY\_STATUS (C macro), 659

ESP\_BLE\_MESH\_MODEL\_OP\_PRIV\_GATT\_PROXY\_STATUS (C macro), 670

ESP\_BLE\_MESH\_MODEL\_OP\_PRIV\_NODE\_IDENTITY\_GET (C macro), 659

ESP\_BLE\_MESH\_MODEL\_OP\_PRIV\_NODE\_IDENTITY\_GET (C macro), 670

ESP\_BLE\_MESH\_MODEL\_OP\_PRIV\_NODE\_IDENTITY\_SET (C macro), 659

ESP\_BLE\_MESH\_MODEL\_OP\_PRIV\_NODE\_IDENTITY\_SET (C macro), 670

ESP\_BLE\_MESH\_MODEL\_OP\_PRIV\_NODE\_IDENTITY\_STATUS (C macro), 659

ESP\_BLE\_MESH\_MODEL\_OP\_PRIV\_NODE\_IDENTITY\_STATUS (C macro), 670

ESP\_BLE\_MESH\_MODEL\_OP\_RELAY\_GET (C macro), 366

ESP\_BLE\_MESH\_MODEL\_OP\_RELAY\_GET (C macro), 376

ESP\_BLE\_MESH\_MODEL\_OP\_RELAY\_SET (C macro), 367

ESP\_BLE\_MESH\_MODEL\_OP\_RELAY\_SET (C macro), 376

ESP\_BLE\_MESH\_MODEL\_OP\_RELAY\_STATUS (C macro), 369

ESP\_BLE\_MESH\_MODEL\_OP\_RELAY\_STATUS (C macro), 376

ESP\_BLE\_MESH\_MODEL\_OP\_RPR\_EXT\_SCAN\_REPORT (C macro), 612

ESP\_BLE\_MESH\_MODEL\_OP\_RPR\_EXT\_SCAN\_REPORT (C macro), 376

ESP\_BLE\_MESH\_MODEL\_OP\_RPR\_EXT\_SCAN\_START (C macro), 611

ESP\_BLE\_MESH\_MODEL\_OP\_RPR\_EXT\_SCAN\_START (C macro), 376

ESP\_BLE\_MESH\_MODEL\_OP\_RPR\_LINK\_CLOSE (C macro), 612

ESP\_BLE\_MESH\_MODEL\_OP\_RPR\_LINK\_CLOSE (C macro), 376

ESP\_BLE\_MESH\_MODEL\_OP\_RPR\_LINK\_GET (C macro), 612

ESP\_BLE\_MESH\_MODEL\_OP\_RPR\_LINK\_GET (C macro), 376

ESP\_BLE\_MESH\_MODEL\_OP\_RPR\_LINK\_OPEN (C macro), 612

ESP\_BLE\_MESH\_MODEL\_OP\_RPR\_LINK\_OPEN (C macro), 376

ESP\_BLE\_MESH\_MODEL\_OP\_RPR\_LINK\_REPORT (C macro), 612

ESP\_BLE\_MESH\_MODEL\_OP\_RPR\_LINK\_REPORT (C macro), 376

ESP\_BLE\_MESH\_MODEL\_OP\_RPR\_LINK\_STATUS (C macro), 612

ESP\_BLE\_MESH\_MODEL\_OP\_RPR\_LINK\_STATUS (C macro), 376

ESP\_BLE\_MESH\_MODEL\_OP\_RPR\_PDU\_OUTBOUND\_REPORT (C macro), 612

ESP\_BLE\_MESH\_MODEL\_OP\_RPR\_PDU\_REPORT (C macro), 612

ESP\_BLE\_MESH\_MODEL\_OP\_RPR\_PDU\_SEND (C macro), 612

ESP\_BLE\_MESH\_MODEL\_OP\_RPR\_SCAN\_CAPS\_GET (C macro), 611

ESP\_BLE\_MESH\_MODEL\_OP\_RPR\_SCAN\_CAPS\_STATUS (C macro), 611

ESP\_BLE\_MESH\_MODEL\_OP\_RPR\_SCAN\_GET (C macro), 611

ESP\_BLE\_MESH\_MODEL\_OP\_RPR\_SCAN\_REPORT (C macro), 611

ESP\_BLE\_MESH\_MODEL\_OP\_RPR\_SCAN\_START (C macro), 611

ESP\_BLE\_MESH\_MODEL\_OP\_RPR\_SCAN\_STATUS (C macro), 611

ESP\_BLE\_MESH\_MODEL\_OP\_RPR\_SCAN\_STOP (C macro), 611

ESP\_BLE\_MESH\_MODEL\_OP\_RSSI\_THRESHOLD\_GET (C macro), 641

ESP\_BLE\_MESH\_MODEL\_OP\_RSSI\_THRESHOLD\_SET (C macro), 641

ESP\_BLE\_MESH\_MODEL\_OP\_RSSI\_THRESHOLD\_STATUS (C macro), 641

ESP\_BLE\_MESH\_MODEL\_OP\_SAR\_RECEIVER\_GET (C macro), 670

ESP\_BLE\_MESH\_MODEL\_OP\_SAR\_RECEIVER\_SET (C macro), 670

ESP\_BLE\_MESH\_MODEL\_OP\_SAR\_RECEIVER\_STATUS (C macro), 670

ESP\_BLE\_MESH\_MODEL\_OP\_SAR\_TRANSMITTER\_GET (C macro), 670

ESP\_BLE\_MESH\_MODEL\_OP\_SAR\_TRANSMITTER\_SET (C macro), 670

ESP\_BLE\_MESH\_MODEL\_OP\_SAR\_TRANSMITTER\_STATUS (C macro), 670

ESP\_BLE\_MESH\_MODEL\_OP\_SCENE\_DELETE (C macro), 376

ESP\_BLE\_MESH\_MODEL\_OP\_SCENE\_DELETE\_UNACK (C macro), 376

ESP\_BLE\_MESH\_MODEL\_OP\_SCENE\_GET (C macro), 376

ESP\_BLE\_MESH\_MODEL\_OP\_SCENE\_RECALL (C macro), 376

ESP\_BLE\_MESH\_MODEL\_OP\_SCENE\_RECALL\_UNACK (C macro), 376

ESP\_BLE\_MESH\_MODEL\_OP\_SCENE\_REGISTER\_GET (C macro), 376

ESP\_BLE\_MESH\_MODEL\_OP\_SCENE\_REGISTER\_STATUS (C macro), 376

ESP\_BLE\_MESH\_MODEL\_OP\_SCENE\_STATUS (C macro), 376

ESP\_BLE\_MESH\_MODEL\_OP\_SCENE\_STORE (C macro), 376

ESP\_BLE\_MESH\_MODEL\_OP\_SCENE\_STORE\_UNACK (C macro), 376

ESP\_BLE\_MESH\_MODEL\_OP\_SCHEDULER\_ACT\_GET (C macro), 376  
 ESP\_BLE\_MESH\_MODEL\_OP\_SCHEDULER\_ACT\_GET (C macro), 376  
 ESP\_BLE\_MESH\_MODEL\_OP\_SCHEDULER\_ACT\_SET (C macro), 376  
 ESP\_BLE\_MESH\_MODEL\_OP\_SCHEDULER\_ACT\_SET (C macro), 376  
 ESP\_BLE\_MESH\_MODEL\_OP\_SCHEDULER\_ACT\_STATUS (C macro), 376  
 ESP\_BLE\_MESH\_MODEL\_OP\_SCHEDULER\_STATUS (C macro), 376  
 ESP\_BLE\_MESH\_MODEL\_OP\_SENSOR\_CADENCE\_GET (C macro), 375  
 ESP\_BLE\_MESH\_MODEL\_OP\_SENSOR\_CADENCE\_SET (C macro), 375  
 ESP\_BLE\_MESH\_MODEL\_OP\_SENSOR\_CADENCE\_SET\_UNACK (C macro), 375  
 ESP\_BLE\_MESH\_MODEL\_OP\_SENSOR\_CADENCE\_STATUS (C macro), 375  
 ESP\_BLE\_MESH\_MODEL\_OP\_SENSOR\_COLUMN\_GET (C macro), 374  
 ESP\_BLE\_MESH\_MODEL\_OP\_SENSOR\_COLUMN\_STATUS (C macro), 375  
 ESP\_BLE\_MESH\_MODEL\_OP\_SENSOR\_DESCRIPTOR\_GET (C macro), 374  
 ESP\_BLE\_MESH\_MODEL\_OP\_SENSOR\_DESCRIPTOR\_STATUS (C macro), 374  
 ESP\_BLE\_MESH\_MODEL\_OP\_SENSOR\_GET (C macro), 374  
 ESP\_BLE\_MESH\_MODEL\_OP\_SENSOR\_SERIES\_GET (C macro), 375  
 ESP\_BLE\_MESH\_MODEL\_OP\_SENSOR\_SERIES\_STATUS (C macro), 375  
 ESP\_BLE\_MESH\_MODEL\_OP\_SENSOR\_SETTING\_GET (C macro), 375  
 ESP\_BLE\_MESH\_MODEL\_OP\_SENSOR\_SETTING\_SET (C macro), 375  
 ESP\_BLE\_MESH\_MODEL\_OP\_SENSOR\_SETTING\_SET\_UNACK (C macro), 375  
 ESP\_BLE\_MESH\_MODEL\_OP\_SENSOR\_SETTING\_STATUS (C macro), 375  
 ESP\_BLE\_MESH\_MODEL\_OP\_SENSOR\_SETTINGS\_GET (C macro), 375  
 ESP\_BLE\_MESH\_MODEL\_OP\_SENSOR\_SETTINGS\_STATUS (C macro), 375  
 ESP\_BLE\_MESH\_MODEL\_OP\_SENSOR\_STATUS (C macro), 374  
 ESP\_BLE\_MESH\_MODEL\_OP\_SIG\_MODEL\_APP\_GET (C macro), 366  
 ESP\_BLE\_MESH\_MODEL\_OP\_SIG\_MODEL\_APP\_LIST (C macro), 369  
 ESP\_BLE\_MESH\_MODEL\_OP\_SIG\_MODEL\_SUB\_GET (C macro), 366  
 ESP\_BLE\_MESH\_MODEL\_OP\_SIG\_MODEL\_SUB\_LIST (C macro), 369  
 ESP\_BLE\_MESH\_MODEL\_OP\_SRPL\_ITEMS\_CLEAR (C macro), 674  
 ESP\_BLE\_MESH\_MODEL\_OP\_SRPL\_ITEMS\_CLEAR\_UNACK (C macro), 674  
 ESP\_BLE\_MESH\_MODEL\_OP\_SRPL\_ITEMS\_STATUS (C macro), 674  
 ESP\_BLE\_MESH\_MODEL\_OP\_SUBNET\_BRIDGE\_GET (C macro), 652  
 ESP\_BLE\_MESH\_MODEL\_OP\_SUBNET\_BRIDGE\_SET (C macro), 652  
 ESP\_BLE\_MESH\_MODEL\_OP\_SUBNET\_BRIDGE\_STATUS (C macro), 652  
 esp\_ble\_mesh\_model\_op\_t (C++ struct), 346  
 esp\_ble\_mesh\_model\_op\_t::min\_len (C++ member), 346  
 esp\_ble\_mesh\_model\_op\_t::opcode (C++ member), 346  
 esp\_ble\_mesh\_model\_op\_t::param\_cb (C++ member), 346  
 ESP\_BLE\_MESH\_MODEL\_OP\_TAI\_UTC\_DELTA\_GET (C macro), 376  
 ESP\_BLE\_MESH\_MODEL\_OP\_TAI\_UTC\_DELTA\_SET (C macro), 376  
 ESP\_BLE\_MESH\_MODEL\_OP\_TAI\_UTC\_DELTA\_STATUS (C macro), 376  
 ESP\_BLE\_MESH\_MODEL\_OP\_TIME\_GET (C macro), 375  
 ESP\_BLE\_MESH\_MODEL\_OP\_TIME\_ROLE\_GET (C macro), 375  
 ESP\_BLE\_MESH\_MODEL\_OP\_TIME\_ROLE\_SET (C macro), 375  
 ESP\_BLE\_MESH\_MODEL\_OP\_TIME\_ROLE\_STATUS (C macro), 375  
 ESP\_BLE\_MESH\_MODEL\_OP\_TIME\_SET (C macro), 375  
 ESP\_BLE\_MESH\_MODEL\_OP\_TIME\_STATUS (C macro), 375  
 ESP\_BLE\_MESH\_MODEL\_OP\_TIME\_ZONE\_GET (C macro), 375  
 ESP\_BLE\_MESH\_MODEL\_OP\_TIME\_ZONE\_SET (C macro), 375  
 ESP\_BLE\_MESH\_MODEL\_OP\_TIME\_ZONE\_STATUS (C macro), 375  
 ESP\_BLE\_MESH\_MODEL\_OP\_TWO\_WAY\_PATH\_GET (C macro), 640  
 ESP\_BLE\_MESH\_MODEL\_OP\_TWO\_WAY\_PATH\_SET (C macro), 640  
 ESP\_BLE\_MESH\_MODEL\_OP\_TWO\_WAY\_PATH\_STATUS (C macro), 641  
 ESP\_BLE\_MESH\_MODEL\_OP\_VENDOR\_MODEL\_APP\_GET (C macro), 366  
 ESP\_BLE\_MESH\_MODEL\_OP\_VENDOR\_MODEL\_APP\_LIST (C macro), 369  
 ESP\_BLE\_MESH\_MODEL\_OP\_VENDOR\_MODEL\_SUB\_GET (C macro), 366  
 ESP\_BLE\_MESH\_MODEL\_OP\_VENDOR\_MODEL\_SUB\_LIST (C macro), 369  
 ESP\_BLE\_MESH\_MODEL\_OP\_WANTED\_LANES\_GET (C macro), 640  
 ESP\_BLE\_MESH\_MODEL\_OP\_WANTED\_LANES\_SET (C macro), 640

- (*C macro*), 640
- ESP\_BLE\_MESH\_MODEL\_OP\_WANTED\_LANES\_STATUS (*C macro*), 640
- ESP\_BLE\_MESH\_MODEL\_PRB\_CLI (*C macro*), 660
- ESP\_BLE\_MESH\_MODEL\_PRB\_SRV (*C macro*), 659
- ESP\_BLE\_MESH\_MODEL\_PUB\_DEFINE (*C macro*), 361
- esp\_ble\_mesh\_model\_pub\_t (*C++ struct*), 345
- esp\_ble\_mesh\_model\_pub\_t::app\_idx (*C++ member*), 345
- esp\_ble\_mesh\_model\_pub\_t::count (*C++ member*), 345
- esp\_ble\_mesh\_model\_pub\_t::cred (*C++ member*), 345
- esp\_ble\_mesh\_model\_pub\_t::dev\_role (*C++ member*), 346
- esp\_ble\_mesh\_model\_pub\_t::fast\_period (*C++ member*), 345
- esp\_ble\_mesh\_model\_pub\_t::model (*C++ member*), 345
- esp\_ble\_mesh\_model\_pub\_t::msg (*C++ member*), 346
- esp\_ble\_mesh\_model\_pub\_t::period (*C++ member*), 345
- esp\_ble\_mesh\_model\_pub\_t::period\_div (*C++ member*), 345
- esp\_ble\_mesh\_model\_pub\_t::period\_start (*C++ member*), 345
- esp\_ble\_mesh\_model\_pub\_t::publish\_addr (*C++ member*), 345
- esp\_ble\_mesh\_model\_pub\_t::retransmit (*C++ member*), 345
- esp\_ble\_mesh\_model\_pub\_t::send\_rel (*C++ member*), 345
- esp\_ble\_mesh\_model\_pub\_t::send\_szmic (*C++ member*), 345
- esp\_ble\_mesh\_model\_pub\_t::timer (*C++ member*), 346
- esp\_ble\_mesh\_model\_pub\_t::ttl (*C++ member*), 345
- esp\_ble\_mesh\_model\_pub\_t::update (*C++ member*), 346
- esp\_ble\_mesh\_model\_publish (*C++ function*), 399
- ESP\_BLE\_MESH\_MODEL\_RPR\_CLI (*C macro*), 614
- ESP\_BLE\_MESH\_MODEL\_RPR\_SRV (*C macro*), 613
- ESP\_BLE\_MESH\_MODEL\_SAR\_CLI (*C macro*), 670
- ESP\_BLE\_MESH\_MODEL\_SAR\_SRV (*C macro*), 670
- ESP\_BLE\_MESH\_MODEL\_SCENE\_CLI (*C macro*), 541
- ESP\_BLE\_MESH\_MODEL\_SCENE\_SETUP\_SRV (*C macro*), 542
- ESP\_BLE\_MESH\_MODEL\_SCENE\_SRV (*C macro*), 542
- ESP\_BLE\_MESH\_MODEL\_SCHEDULER\_CLI (*C macro*), 541
- ESP\_BLE\_MESH\_MODEL\_SCHEDULER\_SETUP\_SRV (*C macro*), 543
- ESP\_BLE\_MESH\_MODEL\_SCHEDULER\_SRV (*C macro*), 542
- ESP\_BLE\_MESH\_MODEL\_SENSOR\_CLI (*C macro*), 513
- ESP\_BLE\_MESH\_MODEL\_SENSOR\_SETUP\_SRV (*C macro*), 513
- ESP\_BLE\_MESH\_MODEL\_SENSOR\_SRV (*C macro*), 513
- ESP\_BLE\_MESH\_MODEL\_SRPL\_CLI (*C macro*), 674
- ESP\_BLE\_MESH\_MODEL\_SRPL\_SRV (*C macro*), 674
- ESP\_BLE\_MESH\_MODEL\_STATUS\_CANNOT\_SET\_RANGE\_MAX (*C macro*), 380
- ESP\_BLE\_MESH\_MODEL\_STATUS\_CANNOT\_SET\_RANGE\_MIN (*C macro*), 380
- ESP\_BLE\_MESH\_MODEL\_STATUS\_SUCCESS (*C macro*), 380
- esp\_ble\_mesh\_model\_status\_t (*C++ type*), 382
- esp\_ble\_mesh\_model\_subscribe\_group\_addr (*C++ function*), 395
- esp\_ble\_mesh\_model\_t (*C++ type*), 381
- ESP\_BLE\_MESH\_MODEL\_TIME\_CLI (*C macro*), 541
- ESP\_BLE\_MESH\_MODEL\_TIME\_SETUP\_SRV (*C macro*), 542
- ESP\_BLE\_MESH\_MODEL\_TIME\_SRV (*C macro*), 541
- esp\_ble\_mesh\_model\_unsubscribe\_group\_addr (*C++ function*), 395
- esp\_ble\_mesh\_models\_metadata\_get\_t (*C++ struct*), 682
- esp\_ble\_mesh\_models\_metadata\_get\_t::metadata\_page (*C++ member*), 682
- esp\_ble\_mesh\_models\_metadata\_get\_t::offset (*C++ member*), 682
- esp\_ble\_mesh\_models\_metadata\_register (*C++ function*), 686
- esp\_ble\_mesh\_models\_metadata\_status\_t (*C++ struct*), 683
- esp\_ble\_mesh\_models\_metadata\_status\_t::data (*C++ member*), 683
- esp\_ble\_mesh\_models\_metadata\_status\_t::metadata\_page (*C++ member*), 683
- esp\_ble\_mesh\_models\_metadata\_status\_t::offset (*C++ member*), 683
- esp\_ble\_mesh\_models\_metadata\_status\_t::total\_size (*C++ member*), 683
- esp\_ble\_mesh\_models\_metadata\_t (*C++ struct*), 689
- esp\_ble\_mesh\_models\_metadata\_t::element\_count (*C++ member*), 689
- esp\_ble\_mesh\_models\_metadata\_t::elements (*C++ member*), 689
- esp\_ble\_mesh\_msg\_ctx\_t (*C++ struct*), 347
- esp\_ble\_mesh\_msg\_ctx\_t::addr (*C++ member*), 348

- esp\_ble\_mesh\_msg\_ctx\_t::app\_idx (C++ member), 348  
 esp\_ble\_mesh\_msg\_ctx\_t::model (C++ member), 348  
 esp\_ble\_mesh\_msg\_ctx\_t::net\_idx (C++ member), 348  
 esp\_ble\_mesh\_msg\_ctx\_t::rcv\_cred (C++ member), 348  
 esp\_ble\_mesh\_msg\_ctx\_t::rcv\_dst (C++ member), 348  
 esp\_ble\_mesh\_msg\_ctx\_t::rcv\_op (C++ member), 348  
 esp\_ble\_mesh\_msg\_ctx\_t::rcv\_rssi (C++ member), 348  
 esp\_ble\_mesh\_msg\_ctx\_t::rcv\_tag (C++ member), 348  
 esp\_ble\_mesh\_msg\_ctx\_t::rcv\_ttl (C++ member), 348  
 esp\_ble\_mesh\_msg\_ctx\_t::send\_cred (C++ member), 348  
 esp\_ble\_mesh\_msg\_ctx\_t::send\_rel (C++ member), 348  
 esp\_ble\_mesh\_msg\_ctx\_t::send\_szmic (C++ member), 348  
 esp\_ble\_mesh\_msg\_ctx\_t::send\_tag (C++ member), 348  
 esp\_ble\_mesh\_msg\_ctx\_t::send\_ttl (C++ member), 348  
 esp\_ble\_mesh\_msg\_ctx\_t::srv\_send (C++ member), 348  
 ESP\_BLE\_MESH\_NET\_PRIMARY (C macro), 356  
 ESP\_BLE\_MESH\_NO\_FAULT (C macro), 454  
 ESP\_BLE\_MESH\_NO\_LOAD\_ERROR (C macro), 455  
 ESP\_BLE\_MESH\_NO\_LOAD\_WARNING (C macro), 455  
 esp\_ble\_mesh\_node\_add\_local\_app\_key (C++ function), 396  
 esp\_ble\_mesh\_node\_add\_local\_net\_key (C++ function), 396  
 esp\_ble\_mesh\_node\_bind\_app\_key\_to\_local\_app\_key (C++ function), 396  
 esp\_ble\_mesh\_node\_get\_local\_app\_key (C++ function), 396  
 esp\_ble\_mesh\_node\_get\_local\_net\_key (C++ function), 396  
 ESP\_BLE\_MESH\_NODE\_IDENTITY\_NOT\_SUPPORTED (C macro), 357  
 ESP\_BLE\_MESH\_NODE\_IDENTITY\_RUNNING (C macro), 357  
 ESP\_BLE\_MESH\_NODE\_IDENTITY\_STOPPED (C macro), 357  
 esp\_ble\_mesh\_node\_input\_number (C++ function), 407  
 esp\_ble\_mesh\_node\_input\_string (C++ function), 407  
 esp\_ble\_mesh\_node\_is\_provisioned (C++ function), 406  
 esp\_ble\_mesh\_node\_local\_reset (C++ function), 400  
 ESP\_BLE\_MESH\_NODE\_NAME\_MAX\_LEN (C macro), 355  
 esp\_ble\_mesh\_node\_prov\_disable (C++ function), 406  
 esp\_ble\_mesh\_node\_prov\_enable (C++ function), 406  
 esp\_ble\_mesh\_node\_set\_oob\_pub\_key (C++ function), 406  
 esp\_ble\_mesh\_node\_t (C++ struct), 350  
 esp\_ble\_mesh\_node\_t::addr (C++ member), 350  
 esp\_ble\_mesh\_node\_t::addr\_type (C++ member), 350  
 esp\_ble\_mesh\_node\_t::comp\_data (C++ member), 351  
 esp\_ble\_mesh\_node\_t::comp\_length (C++ member), 351  
 esp\_ble\_mesh\_node\_t::dev\_key (C++ member), 351  
 esp\_ble\_mesh\_node\_t::dev\_uuid (C++ member), 350  
 esp\_ble\_mesh\_node\_t::element\_num (C++ member), 351  
 esp\_ble\_mesh\_node\_t::flags (C++ member), 351  
 esp\_ble\_mesh\_node\_t::iv\_index (C++ member), 351  
 esp\_ble\_mesh\_node\_t::name (C++ member), 351  
 esp\_ble\_mesh\_node\_t::net\_idx (C++ member), 351  
 esp\_ble\_mesh\_node\_t::oob\_info (C++ member), 351  
 esp\_ble\_mesh\_node\_t::unicast\_addr (C++ member), 351  
 ESP\_BLE\_MESH\_OCTET16\_LEN (C macro), 356  
 esp\_ble\_mesh\_octet16\_t (C++ type), 381  
 ESP\_BLE\_MESH\_OCTET8\_LEN (C macro), 356  
 esp\_ble\_mesh\_octet8\_t (C++ type), 381  
 esp\_ble\_mesh\_od\_priv\_proxy\_set\_t (C++ struct), 662  
 esp\_ble\_mesh\_od\_priv\_proxy\_set\_t::gatt\_proxy (C++ member), 662  
 esp\_ble\_mesh\_od\_priv\_proxy\_status\_t (C++ struct), 662  
 esp\_ble\_mesh\_od\_priv\_proxy\_status\_t::gatt\_proxy (C++ member), 663  
 esp\_ble\_mesh\_odp\_client\_cb\_event\_t (C++ enum), 664  
 esp\_ble\_mesh\_odp\_client\_cb\_event\_t::ESP\_BLE\_MESH\_ODP\_CLIENT\_CB\_EVENT\_CONNECTED (C++ enumerator), 665  
 esp\_ble\_mesh\_odp\_client\_cb\_event\_t::ESP\_BLE\_MESH\_ODP\_CLIENT\_CB\_EVENT\_DISCONNECTED (C++ enumerator), 665  
 esp\_ble\_mesh\_odp\_client\_cb\_event\_t::ESP\_BLE\_MESH\_ODP\_CLIENT\_CB\_EVENT\_FAILED (C++ enumerator), 665  
 esp\_ble\_mesh\_odp\_client\_cb\_event\_t::ESP\_BLE\_MESH\_ODP\_CLIENT\_CB\_EVENT\_TIMEOUT (C++ enumerator), 665



esp\_ble\_mesh\_odp\_client\_cb\_event\_t::ESP\_BLE\_MESH\_ODP\_CLIENT\_CB\_EVENT\_SEND: **ESP\_BLE\_MESH\_INPUT\_OOB**  
 (C++ enumerator), 665 (C++ enumerator), 383  
 esp\_ble\_mesh\_odp\_client\_cb\_param\_t esp\_ble\_mesh\_oob\_method\_t::ESP\_BLE\_MESH\_NO\_OOB  
 (C++ struct), 663 (C++ enumerator), 383  
 esp\_ble\_mesh\_odp\_client\_cb\_param\_t::params esp\_ble\_mesh\_oob\_method\_t::ESP\_BLE\_MESH\_OUTPUT\_OOB  
 (C++ member), 663 (C++ enumerator), 383  
 esp\_ble\_mesh\_odp\_client\_cb\_param\_t::recv esp\_ble\_mesh\_oob\_method\_t::ESP\_BLE\_MESH\_STATIC\_OOB  
 (C++ member), 663 (C++ enumerator), 383  
 esp\_ble\_mesh\_odp\_client\_cb\_param\_t::send esp\_ble\_mesh\_opcode\_config\_client\_get\_t  
 (C++ member), 663 (C++ type), 381  
 esp\_ble\_mesh\_odp\_client\_cb\_param\_t::[anonymous] esp\_ble\_mesh\_opcode\_config\_client\_set\_t  
 (C++ member), 663 (C++ type), 381  
 esp\_ble\_mesh\_odp\_client\_cb\_t (C++ type), esp\_ble\_mesh\_opcode\_config\_status\_t  
 664 (C++ type), 381  
 esp\_ble\_mesh\_odp\_client\_msg\_t (C++ union), 661 esp\_ble\_mesh\_opcode\_health\_client\_get\_t  
 (C++ member), 661 (C++ type), 382  
 esp\_ble\_mesh\_odp\_client\_msg\_t::od\_priv esp\_ble\_mesh\_opcode\_health\_client\_set\_t  
 (C++ member), 661 (C++ type), 382  
 esp\_ble\_mesh\_odp\_client\_msg\_t::od\_priv esp\_ble\_mesh\_opcode\_t (C++ type), 382  
 esp\_ble\_mesh\_odp\_client\_rcv\_cb\_t esp\_ble\_mesh\_output\_action\_t (C++ enum),  
 (C++ union), 661 383  
 esp\_ble\_mesh\_odp\_client\_rcv\_cb\_t::od\_priv\_priv\_status  
 (C++ member), 661 (C++ enumerator), 383  
 esp\_ble\_mesh\_odp\_client\_send (C++ func-  
 tion), 661 esp\_ble\_mesh\_output\_action\_t::ESP\_BLE\_MESH\_BEEP  
 (C++ enumerator), 383  
 esp\_ble\_mesh\_odp\_client\_send\_cb\_t  
 (C++ struct), 663 esp\_ble\_mesh\_output\_action\_t::ESP\_BLE\_MESH\_BLINK  
 (C++ enumerator), 383  
 esp\_ble\_mesh\_odp\_client\_send\_cb\_t::err\_code (C++ enumerator), 383  
 (C++ member), 663 esp\_ble\_mesh\_output\_action\_t::ESP\_BLE\_MESH\_DISPLAY  
 (C++ enumerator), 383  
 esp\_ble\_mesh\_odp\_server\_cb\_event\_t  
 (C++ enum), 665 esp\_ble\_mesh\_output\_action\_t::ESP\_BLE\_MESH\_DISPLAY  
 (C++ enumerator), 383  
 esp\_ble\_mesh\_odp\_server\_cb\_event\_t::ESP\_BLE\_MESH\_CLIENT\_EVT\_MAX  
 (C++ enumerator), 665 esp\_ble\_mesh\_output\_action\_t::ESP\_BLE\_MESH\_NO\_OUT  
 (C++ enumerator), 383  
 esp\_ble\_mesh\_odp\_server\_cb\_event\_t::ESP\_BLE\_MESH\_CLIENT\_EVT\_MAX  
 (C++ enumerator), 665 esp\_ble\_mesh\_output\_action\_t::ESP\_BLE\_MESH\_VIBRATE  
 (C++ enumerator), 383  
 esp\_ble\_mesh\_odp\_server\_cb\_event\_t::ESP\_BLE\_MESH\_STATE\_CHANGE\_EVT  
 (C++ enumerator), 665 ESP\_BLE\_MESH\_OVERFLOW\_ERROR (C macro),  
 456  
 esp\_ble\_mesh\_odp\_server\_cb\_param\_t  
 (C++ struct), 663 ESP\_BLE\_MESH\_OVERFLOW\_WARNING (C macro),  
 456  
 esp\_ble\_mesh\_odp\_server\_cb\_param\_t::ctx 456  
 (C++ member), 663 ESP\_BLE\_MESH\_OVERHEAT\_ERROR (C macro),  
 455  
 esp\_ble\_mesh\_odp\_server\_cb\_param\_t::model 455  
 (C++ member), 663 ESP\_BLE\_MESH\_OVERHEAT\_WARNING (C macro),  
 455  
 esp\_ble\_mesh\_odp\_server\_cb\_param\_t::value 455  
 (C++ member), 663 ESP\_BLE\_MESH\_OVERLOAD\_ERROR (C macro),  
 455  
 esp\_ble\_mesh\_odp\_server\_cb\_t (C++ type),  
 664 ESP\_BLE\_MESH\_OVERLOAD\_WARNING (C macro),  
 455  
 esp\_ble\_mesh\_odp\_server\_cb\_value\_t  
 (C++ union), 662 ESP\_BLE\_MESH\_PATH\_DISC\_INTERVAL\_30\_SEC  
 (C macro), 642  
 esp\_ble\_mesh\_odp\_server\_cb\_value\_t::state\_change  
 (C++ member), 662 ESP\_BLE\_MESH\_PATH\_DISC\_INTERVAL\_5\_SEC  
 (C macro), 642  
 esp\_ble\_mesh\_odp\_server\_state\_change\_t  
 (C++ union), 662 esp\_ble\_mesh\_path\_disc\_timing\_ctl\_status\_cb\_t  
 (C++ struct), 637  
 (C++ member), 662 esp\_ble\_mesh\_path\_disc\_timing\_ctl\_status\_cb\_t::la  
 (C++ member), 637  
 esp\_ble\_mesh\_odp\_srv\_t (C++ struct), 662 (C++ member), 637  
 esp\_ble\_mesh\_odp\_srv\_t::model (C++ member), 662 (C++ member), 637  
 esp\_ble\_mesh\_odp\_srv\_t::on\_demand\_private esp\_ble\_mesh\_path\_disc\_timing\_ctl\_status\_cb\_t::pa  
 (C++ member), 662 (C++ member), 637  
 esp\_ble\_mesh\_oob\_method\_t (C++ enum), 383 esp\_ble\_mesh\_path\_disc\_timing\_ctl\_status\_cb\_t::pa



- (C++ member), 659
- esp\_ble\_mesh\_prb\_server\_cb\_param\_t::model (C++ member), 659
- (C++ member), 659
- esp\_ble\_mesh\_prb\_server\_cb\_param\_t::value (C++ member), 659
- (C++ member), 659
- esp\_ble\_mesh\_prb\_server\_cb\_t (C++ type), 660
- esp\_ble\_mesh\_prb\_server\_cb\_value\_t (C++ union), 655
- esp\_ble\_mesh\_prb\_server\_cb\_value\_t::state\_change (C++ member), 655
- (C++ member), 655
- esp\_ble\_mesh\_prb\_server\_state\_change\_t (C++ union), 655
- esp\_ble\_mesh\_prb\_server\_state\_change\_t::private\_beacon\_set (C++ member), 655
- (C++ member), 655
- esp\_ble\_mesh\_prb\_server\_state\_change\_t::private\_gatt\_proxy\_set (C++ member), 655
- (C++ member), 655
- esp\_ble\_mesh\_prb\_server\_state\_change\_t::private\_gatt\_proxy\_set (C++ member), 655
- (C++ member), 655
- esp\_ble\_mesh\_prb\_srv\_t (C++ struct), 655
- esp\_ble\_mesh\_prb\_srv\_t::model (C++ member), 656
- esp\_ble\_mesh\_prb\_srv\_t::private\_beacon (C++ member), 656
- esp\_ble\_mesh\_prb\_srv\_t::private\_gatt\_proxy (C++ member), 656
- esp\_ble\_mesh\_prb\_srv\_t::random\_update\_interval (C++ member), 656
- esp\_ble\_mesh\_prb\_srv\_t::update\_timer (C++ member), 656
- esp\_ble\_mesh\_priv\_beacon\_set\_t (C++ struct), 656
- esp\_ble\_mesh\_priv\_beacon\_set\_t::is\_effective (C++ member), 656
- esp\_ble\_mesh\_priv\_beacon\_set\_t::private\_beacon (C++ member), 656
- esp\_ble\_mesh\_priv\_beacon\_set\_t::update\_interval (C++ member), 656
- esp\_ble\_mesh\_priv\_beacon\_status\_cb\_t (C++ struct), 657
- esp\_ble\_mesh\_priv\_beacon\_status\_cb\_t::private\_beacon (C++ member), 657
- esp\_ble\_mesh\_priv\_beacon\_status\_cb\_t::update\_interval (C++ member), 657
- esp\_ble\_mesh\_priv\_gatt\_proxy\_set\_t (C++ struct), 656
- esp\_ble\_mesh\_priv\_gatt\_proxy\_set\_t::private\_gatt\_proxy (C++ member), 656
- esp\_ble\_mesh\_priv\_gatt\_proxy\_status\_cb\_t (C++ struct), 657
- esp\_ble\_mesh\_priv\_gatt\_proxy\_status\_cb\_t::private\_gatt\_proxy (C++ member), 657
- esp\_ble\_mesh\_priv\_node\_id\_get\_t (C++ struct), 656
- esp\_ble\_mesh\_priv\_node\_id\_get\_t::net\_idx (C++ member), 656
- esp\_ble\_mesh\_priv\_node\_id\_set\_t (C++ struct), 656
- esp\_ble\_mesh\_priv\_node\_id\_set\_t::net\_idx (C++ member), 657
- esp\_ble\_mesh\_priv\_node\_id\_set\_t::private\_node\_id (C++ member), 657
- esp\_ble\_mesh\_priv\_node\_identity\_status\_cb\_t (C++ struct), 657
- esp\_ble\_mesh\_priv\_node\_identity\_status\_cb\_t::net\_idx (C++ member), 657
- esp\_ble\_mesh\_priv\_node\_identity\_status\_cb\_t::private\_node\_id (C++ member), 657
- esp\_ble\_mesh\_priv\_node\_identity\_status\_cb\_t::state\_change (C++ member), 657
- (C++ member), 657
- ESP\_BLE\_MESH\_PRIVATE\_BEACON\_DISABLE (C macro), 357
- ESP\_BLE\_MESH\_PRIVATE\_BEACON\_ENABLE (C macro), 357
- ESP\_BLE\_MESH\_PRIVATE\_GATT\_PROXY\_DISABLED (C macro), 357
- ESP\_BLE\_MESH\_PRIVATE\_GATT\_PROXY\_ENABLED (C macro), 357
- ESP\_BLE\_MESH\_PRIVATE\_GATT\_PROXY\_NOT\_SUPPORTED (C macro), 357
- ESP\_BLE\_MESH\_PRIVATE\_NODE\_IDENTITY\_DISABLED (C macro), 357
- ESP\_BLE\_MESH\_PRIVATE\_NODE\_IDENTITY\_ENABLED (C macro), 357
- ESP\_BLE\_MESH\_PRIVATE\_NODE\_IDENTITY\_NOT\_SUPPORTED (C macro), 357
- esp\_ble\_mesh\_private\_proxy\_identity\_disable (C++ function), 412
- esp\_ble\_mesh\_private\_proxy\_identity\_enable (C++ function), 412
- ESP\_BLE\_MESH\_PROV (C macro), 360
- esp\_ble\_mesh\_prov\_adv\_cb\_t (C++ type), 411
- esp\_ble\_mesh\_prov\_bearer\_t (C++ enum), 384
- esp\_ble\_mesh\_prov\_bearer\_t::ESP\_BLE\_MESH\_PROV\_ADV (C++ enumerator), 384
- esp\_ble\_mesh\_prov\_bearer\_t::ESP\_BLE\_MESH\_PROV\_GATT\_PROXY (C++ enumerator), 384
- esp\_ble\_mesh\_prov\_cb\_event\_t (C++ enum), 385
- esp\_ble\_mesh\_prov\_cb\_event\_t::ESP\_BLE\_MESH\_DEINIT (C++ enumerator), 391
- esp\_ble\_mesh\_prov\_cb\_event\_t::ESP\_BLE\_MESH\_FRIEND (C++ enumerator), 390
- esp\_ble\_mesh\_prov\_cb\_event\_t::ESP\_BLE\_MESH\_FRIEND (C++ enumerator), 390
- esp\_ble\_mesh\_prov\_cb\_event\_t::ESP\_BLE\_MESH\_HEARTBEAT (C++ enumerator), 390
- esp\_ble\_mesh\_prov\_cb\_event\_t::ESP\_BLE\_MESH\_LP\_NDI (C++ enumerator), 390
- esp\_ble\_mesh\_prov\_cb\_event\_t::ESP\_BLE\_MESH\_LP\_NEN (C++ enumerator), 390
- esp\_ble\_mesh\_prov\_cb\_event\_t::ESP\_BLE\_MESH\_LP\_NFR (C++ enumerator), 390
- esp\_ble\_mesh\_prov\_cb\_event\_t::ESP\_BLE\_MESH\_LP\_NFR (C++ enumerator), 390





- esp\_ble\_mesh\_prov\_cb\_event\_t::ESP\_BLE\_MESH\_PROVISIONER\_RECV\_ACCEPTABLE\_MESH\_SET\_FA  
(C++ enumerator), 387 (C++ enumerator), 390
- esp\_ble\_mesh\_prov\_cb\_event\_t::ESP\_BLE\_MESH\_PROVISIONER\_SEND\_LINK\_CLOSE\_EVT  
(C++ enumerator), 388 (C++ union), 309
- esp\_ble\_mesh\_prov\_cb\_event\_t::ESP\_BLE\_MESH\_PROVISIONER\_SEND\_PARAM\_INVAL\_EVT  
(C++ enumerator), 388 (C++ struct), 318
- esp\_ble\_mesh\_prov\_cb\_event\_t::ESP\_BLE\_MESH\_PROVISIONER\_SEND\_PARAM\_RECORD\_REFRESH\_EVT  
(C++ enumerator), 387 (C++ member), 318
- esp\_ble\_mesh\_prov\_cb\_event\_t::ESP\_BLE\_MESH\_PROVISIONER\_SEND\_PARAM\_RECORDS\_REFRESH\_EVT  
(C++ enumerator), 387 (C++ struct), 318
- esp\_ble\_mesh\_prov\_cb\_event\_t::ESP\_BLE\_MESH\_PROVISIONER\_SEND\_PARAM\_UUID\_MATCH\_COMP\_EVT  
(C++ enumerator), 388 (C++ member), 318
- esp\_ble\_mesh\_prov\_cb\_event\_t::ESP\_BLE\_MESH\_PROVISIONER\_SEND\_PARAM\_UUID\_MISMATCH\_COMP\_EVT  
(C++ enumerator), 389 (C++ struct), 318
- esp\_ble\_mesh\_prov\_cb\_event\_t::ESP\_BLE\_MESH\_PROVISIONER\_SEND\_PARAM\_UUID\_TYPE\_COMP\_EVT  
(C++ enumerator), 389 (C++ member), 319
- esp\_ble\_mesh\_prov\_cb\_event\_t::ESP\_BLE\_MESH\_PROVISIONER\_SEND\_PARAM\_UUID\_COMP\_EVT  
(C++ enumerator), 388 (C++ member), 319
- esp\_ble\_mesh\_prov\_cb\_event\_t::ESP\_BLE\_MESH\_PROVISIONER\_SEND\_PRIMARY\_ELEM\_ADDR\_COMP\_EVT  
(C++ enumerator), 388 (C++ enum), 319
- esp\_ble\_mesh\_prov\_cb\_event\_t::ESP\_BLE\_MESH\_PROVISIONER\_SEND\_PROVIDA\_BLINE\_COMP\_EVT  
(C++ enumerator), 388 (C++ enumerator), 319
- esp\_ble\_mesh\_prov\_cb\_event\_t::ESP\_BLE\_MESH\_PROVISIONER\_SEND\_STATIC\_TOOB\_MALINES\_COMP\_EVT  
(C++ enumerator), 388 (C++ enumerator), 319
- esp\_ble\_mesh\_prov\_cb\_event\_t::ESP\_BLE\_MESH\_PROVISIONER\_STORE\_NAME\_COMPLETE\_EVT  
(C++ enumerator), 389 (C++ enumerator), 319
- esp\_ble\_mesh\_prov\_cb\_event\_t::ESP\_BLE\_MESH\_PROVISIONER\_UPDATE\_LOCAL\_ADR\_COMP\_EVT  
(C++ enumerator), 388 (C++ enumerator), 319
- esp\_ble\_mesh\_prov\_cb\_event\_t::ESP\_BLE\_MESH\_PROVISIONER\_UPDATE\_LOCAL\_NAME\_COMP\_EVT  
(C++ enumerator), 389 (C++ enumerator), 319
- esp\_ble\_mesh\_prov\_cb\_event\_t::ESP\_BLE\_MESH\_PROXIESH\_IPNV\_ADD\_PRIMARY\_ADDR\_COMP\_EVT  
(C++ enumerator), 391 (C++ struct), 319
- esp\_ble\_mesh\_prov\_cb\_event\_t::ESP\_BLE\_MESH\_PROXIESH\_IPNV\_CONNECTION\_EVT  
(C++ enumerator), 390 (C++ member), 319
- esp\_ble\_mesh\_prov\_cb\_event\_t::ESP\_BLE\_MESH\_PROXIESH\_IPNV\_CONNECTION\_EVT  
(C++ enumerator), 390 (C++ member), 319
- esp\_ble\_mesh\_prov\_cb\_event\_t::ESP\_BLE\_MESH\_PROXIESH\_IPNV\_DISCONNECT\_COMPLETE\_EVT  
(C++ enumerator), 391 (C++ struct), 319
- esp\_ble\_mesh\_prov\_cb\_event\_t::ESP\_BLE\_MESH\_PROXIESH\_IPNV\_DISCONNECT\_COMPLETE\_EVT  
(C++ enumerator), 390 (C++ member), 320
- esp\_ble\_mesh\_prov\_cb\_event\_t::ESP\_BLE\_MESH\_PROXIESH\_IPNV\_DISCONNECTED\_EVT  
(C++ enumerator), 390 (C++ member), 320
- esp\_ble\_mesh\_prov\_cb\_event\_t::ESP\_BLE\_MESH\_PROXIESH\_IPNV\_RECV\_PARAM\_PKT\_EVT  
(C++ enumerator), 390 (C++ struct), 320
- esp\_ble\_mesh\_prov\_cb\_event\_t::ESP\_BLE\_MESH\_PROXIESH\_IPNV\_RECV\_PARAM\_STATUS\_EVT  
(C++ enumerator), 390 (C++ member), 320
- esp\_ble\_mesh\_prov\_cb\_event\_t::ESP\_BLE\_MESH\_PROXIESH\_IPNV\_REMOVE\_INTERFACE\_COMP\_EVT  
(C++ enumerator), 391 (C++ struct), 320
- esp\_ble\_mesh\_prov\_cb\_event\_t::ESP\_BLE\_MESH\_PROXIESH\_IPNV\_SEND\_STATIC\_PUB\_COMP\_EVT  
(C++ enumerator), 391 (C++ member), 320
- esp\_ble\_mesh\_prov\_cb\_event\_t::ESP\_BLE\_MESH\_PROXIESH\_IPNV\_SET\_PRIMARY\_IP\_COMP\_EVT  
(C++ enumerator), 391 (C++ struct), 320
- esp\_ble\_mesh\_prov\_cb\_event\_t::ESP\_BLE\_MESH\_PROXIESH\_IPNV\_SERVER\_CONNECTION\_EVT  
(C++ enumerator), 391 (C++ member), 320
- esp\_ble\_mesh\_prov\_cb\_event\_t::ESP\_BLE\_MESH\_PROXIESH\_IPNV\_SERVER\_DISCONNECTED\_EVT  
(C++ enumerator), 391 (C++ member), 320
- esp\_ble\_mesh\_prov\_cb\_event\_t::ESP\_BLE\_MESH\_SETUP\_PROV\_ACTION\_COMP\_EVT  
(C++ enumerator), 390 (C++ struct), 320











esp\_ble\_mesh\_prov\_cb\_param\_t::ble\_mesh\_establishment\_req\_param\_t::conn\_handle  
 (C++ member), 338 (C++ member), 316  
 esp\_ble\_mesh\_prov\_cb\_param\_t::ble\_mesh\_establishment\_req\_param\_t::delete\_sub\_group\_add  
 (C++ member), 338 (C++ member), 318  
 esp\_ble\_mesh\_prov\_cb\_param\_t::ble\_mesh\_establishment\_req\_param\_t::model\_unsub\_group\_a  
 (C++ struct), 338 (C++ member), 318  
 esp\_ble\_mesh\_prov\_cb\_param\_t::ble\_mesh\_establishment\_req\_param\_t::status\_action  
 (C++ member), 339 (C++ member), 318  
 esp\_ble\_mesh\_prov\_cb\_param\_t::ble\_mesh\_establishment\_req\_param\_t::node\_add\_app\_key\_co  
 (C++ struct), 339 (C++ member), 311  
 esp\_ble\_mesh\_prov\_cb\_param\_t::ble\_mesh\_establishment\_req\_param\_t::node\_add\_matchkey\_co  
 (C++ member), 339 (C++ member), 311  
 esp\_ble\_mesh\_prov\_cb\_param\_t::ble\_mesh\_establishment\_req\_param\_t::node\_add\_privkey\_t  
 (C++ member), 339 (C++ member), 311  
 esp\_ble\_mesh\_prov\_cb\_param\_t::ble\_mesh\_establishment\_req\_param\_t::node\_add\_public\_key\_t  
 (C++ member), 339 (C++ member), 311  
 esp\_ble\_mesh\_prov\_cb\_param\_t::ble\_mesh\_establishment\_req\_param\_t::node\_private\_proxy  
 (C++ struct), 339 (C++ member), 311  
 esp\_ble\_mesh\_prov\_cb\_param\_t::ble\_mesh\_establishment\_req\_param\_t::err\_code\_prov\_complete  
 (C++ member), 339 (C++ member), 310  
 esp\_ble\_mesh\_prov\_cb\_param\_t::ble\_mesh\_establishment\_req\_param\_t::mode\_prov\_disable\_c  
 (C++ struct), 339 (C++ member), 310  
 esp\_ble\_mesh\_prov\_cb\_param\_t::ble\_mesh\_establishment\_req\_param\_t::mode\_prov\_enable\_co  
 (C++ member), 339 (C++ member), 310  
 esp\_ble\_mesh\_prov\_cb\_param\_t::deinit\_mesh\_done esp\_ble\_mesh\_prov\_cb\_param\_t::node\_prov\_input  
 (C++ member), 318 (C++ member), 310  
 esp\_ble\_mesh\_prov\_cb\_param\_t::dst esp\_ble\_mesh\_prov\_cb\_param\_t::node\_prov\_input\_num  
 (C++ member), 318 (C++ member), 310  
 esp\_ble\_mesh\_prov\_cb\_param\_t::enable esp\_ble\_mesh\_prov\_cb\_param\_t::node\_prov\_input\_str  
 (C++ member), 314 (C++ member), 310  
 esp\_ble\_mesh\_prov\_cb\_param\_t::err\_code esp\_ble\_mesh\_prov\_cb\_param\_t::node\_prov\_link\_clos  
 (C++ member), 314 (C++ member), 310  
 esp\_ble\_mesh\_prov\_cb\_param\_t::feature esp\_ble\_mesh\_prov\_cb\_param\_t::node\_prov\_link\_open  
 (C++ member), 315 (C++ member), 310  
 esp\_ble\_mesh\_prov\_cb\_param\_t::frnd\_friendship\_establishment\_req\_param\_t::node\_prov\_output\_nu  
 (C++ member), 317 (C++ member), 310  
 esp\_ble\_mesh\_prov\_cb\_param\_t::frnd\_friendship\_establishment\_req\_param\_t::node\_prov\_output\_st  
 (C++ member), 317 (C++ member), 310  
 esp\_ble\_mesh\_prov\_cb\_param\_t::hb\_dst esp\_ble\_mesh\_prov\_cb\_param\_t::node\_prov\_reset  
 (C++ member), 315 (C++ member), 310  
 esp\_ble\_mesh\_prov\_cb\_param\_t::hb\_src esp\_ble\_mesh\_prov\_cb\_param\_t::node\_prov\_set\_oob\_p  
 (C++ member), 314 (C++ member), 310  
 esp\_ble\_mesh\_prov\_cb\_param\_t::heartbeat\_req\_param\_t::node\_proxy\_gatt\_dis  
 (C++ member), 316 (C++ member), 311  
 esp\_ble\_mesh\_prov\_cb\_param\_t::hops esp\_ble\_mesh\_prov\_cb\_param\_t::node\_proxy\_gatt\_ena  
 (C++ member), 315 (C++ member), 311  
 esp\_ble\_mesh\_prov\_cb\_param\_t::index esp\_ble\_mesh\_prov\_cb\_param\_t::node\_proxy\_identity  
 (C++ member), 315 (C++ member), 310  
 esp\_ble\_mesh\_prov\_cb\_param\_t::init\_ttl esp\_ble\_mesh\_prov\_cb\_param\_t::node\_set\_unprov\_dev  
 (C++ member), 315 (C++ member), 310  
 esp\_ble\_mesh\_prov\_cb\_param\_t::lpn\_disable\_mesh\_done esp\_ble\_mesh\_prov\_cb\_param\_t::op (C++  
 (C++ member), 316 (C++ member), 314  
 esp\_ble\_mesh\_prov\_cb\_param\_t::lpn\_enable\_mesh\_done esp\_ble\_mesh\_prov\_cb\_param\_t::prov\_register\_comp  
 (C++ member), 316 (C++ member), 310  
 esp\_ble\_mesh\_prov\_cb\_param\_t::lpn\_friendship\_establishment\_req\_param\_t::provisioner\_add\_app  
 (C++ member), 316 (C++ member), 313  
 esp\_ble\_mesh\_prov\_cb\_param\_t::lpn\_friendship\_establishment\_req\_param\_t::provisioner\_add\_net  
 (C++ member), 316 (C++ member), 313

---

esp\_ble\_mesh\_prov\_cb\_param\_t::provisioner\_send\_dev\_comp (C++ member), 312  
 esp\_ble\_mesh\_prov\_cb\_param\_t::provisioner\_send\_dev\_comp (C++ member), 312  
 esp\_ble\_mesh\_prov\_cb\_param\_t::provisioner\_send\_dev\_comp (C++ member), 312  
 esp\_ble\_mesh\_prov\_cb\_param\_t::provisioner\_send\_dev\_comp (C++ member), 316  
 esp\_ble\_mesh\_prov\_cb\_param\_t::provisioner\_send\_dev\_comp (C++ member), 316  
 esp\_ble\_mesh\_prov\_cb\_param\_t::provisioner\_send\_dev\_comp (C++ member), 312  
 esp\_ble\_mesh\_prov\_cb\_param\_t::provisioner\_send\_dev\_comp (C++ member), 314  
 esp\_ble\_mesh\_prov\_cb\_param\_t::provisioner\_send\_dev\_comp (C++ member), 314  
 esp\_ble\_mesh\_prov\_cb\_param\_t::provisioner\_send\_dev\_comp (C++ member), 316  
 esp\_ble\_mesh\_prov\_cb\_param\_t::provisioner\_send\_dev\_comp (C++ member), 316  
 esp\_ble\_mesh\_prov\_cb\_param\_t::provisioner\_send\_dev\_comp (C++ member), 315  
 esp\_ble\_mesh\_prov\_cb\_param\_t::provisioner\_send\_dev\_comp (C++ member), 314  
 esp\_ble\_mesh\_prov\_cb\_param\_t::provisioner\_send\_dev\_comp (C++ member), 314  
 esp\_ble\_mesh\_prov\_cb\_param\_t::provisioner\_send\_dev\_comp (C++ member), 315  
 esp\_ble\_mesh\_prov\_cb\_param\_t::provisioner\_send\_dev\_comp (C++ member), 315  
 esp\_ble\_mesh\_prov\_cb\_param\_t::provisioner\_send\_dev\_comp (C++ member), 312  
 esp\_ble\_mesh\_prov\_cb\_param\_t::provisioner\_send\_dev\_comp (C++ member), 312  
 esp\_ble\_mesh\_prov\_cb\_param\_t::provisioner\_send\_dev\_comp (C++ member), 311  
 esp\_ble\_mesh\_prov\_cb\_param\_t::provisioner\_send\_dev\_comp (C++ member), 311  
 esp\_ble\_mesh\_prov\_cb\_param\_t::provisioner\_send\_dev\_comp (C++ member), 311  
 esp\_ble\_mesh\_prov\_cb\_param\_t::provisioner\_send\_dev\_comp (C++ member), 313  
 esp\_ble\_mesh\_prov\_cb\_param\_t::provisioner\_send\_dev\_comp (C++ member), 313  
 esp\_ble\_mesh\_prov\_cb\_param\_t::provisioner\_send\_dev\_comp (C++ member), 312  
 esp\_ble\_mesh\_prov\_cb\_param\_t::provisioner\_send\_dev\_comp (C++ member), 312  
 esp\_ble\_mesh\_prov\_cb\_param\_t::provisioner\_send\_dev\_comp (C++ member), 315  
 esp\_ble\_mesh\_prov\_cb\_param\_t::provisioner\_send\_dev\_comp (C++ member), 315  
 esp\_ble\_mesh\_prov\_cb\_param\_t::provisioner\_send\_dev\_comp (C++ member), 311  
 esp\_ble\_mesh\_prov\_cb\_param\_t::provisioner\_send\_dev\_comp (C++ member), 315





---

esp\_ble\_mesh\_provisioner\_open\_settings\_disable (C++ function), 404  
 esp\_ble\_mesh\_provisioner\_open\_settings\_enable (C++ function), 412  
 esp\_ble\_mesh\_provisioner\_prov\_device\_wid\_enable (C++ function), 409  
 esp\_ble\_mesh\_provisioner\_prov\_disable ESP\_BLE\_MESH\_PROXY\_USE\_DIRECTED\_DISABLED (C++ function), 408 (C macro), 361  
 esp\_ble\_mesh\_provisioner\_prov\_enable ESP\_BLE\_MESH\_PROXY\_USE\_DIRECTED\_ENABLED (C++ function), 408 (C macro), 361  
 esp\_ble\_mesh\_provisioner\_read\_oob\_pub\_key ESP\_BLE\_MESH\_PUBLISH\_TRANSMIT (C++ function), 407 (C macro), 358  
 esp\_ble\_mesh\_provisioner\_rcv\_heartbeat ESP\_BLE\_MESH\_RAND\_UPDATE\_INTERVAL\_DEFAULT (C++ function), 403 (C macro), 355  
 esp\_ble\_mesh\_provisioner\_set\_dev\_uuid\_mesh\_register\_agg\_client\_callback (C++ function), 410 (C++ function), 676  
 esp\_ble\_mesh\_provisioner\_set\_heartbeat\_mesh\_register\_agg\_server\_callback (C++ function), 403 (C++ function), 676  
 esp\_ble\_mesh\_provisioner\_set\_heartbeat\_type\_mesh\_register\_brc\_client\_callback (C++ function), 403 (C++ function), 644  
 esp\_ble\_mesh\_provisioner\_set\_node\_name esp\_ble\_mesh\_register\_brc\_server\_callback (C++ function), 400 (C++ function), 644  
 esp\_ble\_mesh\_provisioner\_set\_primary\_element esp\_ble\_mesh\_register\_config\_client\_callback (C++ function), 411 (C++ function), 414  
 esp\_ble\_mesh\_provisioner\_set\_prov\_data esp\_ble\_mesh\_register\_config\_server\_callback (C++ function), 410 (C++ function), 414  
 esp\_ble\_mesh\_provisioner\_set\_static\_oob\_value esp\_ble\_mesh\_register\_custom\_model\_callback (C++ function), 410 (C++ function), 398  
 esp\_ble\_mesh\_provisioner\_store\_node\_comp\_data esp\_ble\_mesh\_register\_df\_client\_callback (C++ function), 400 (C++ function), 616  
 esp\_ble\_mesh\_provisioner\_update\_local\_app\_key esp\_ble\_mesh\_register\_df\_server\_callback (C++ function), 402 (C++ function), 616  
 esp\_ble\_mesh\_provisioner\_update\_local\_net\_key esp\_ble\_mesh\_register\_generic\_client\_callback (C++ function), 402 (C++ function), 458  
 ESP\_BLE\_MESH\_PROXY\_CLI\_DIRECTED\_FORWARDING\_DISABLE esp\_ble\_mesh\_register\_generic\_server\_callback (C macro), 414 (C++ function), 458  
 ESP\_BLE\_MESH\_PROXY\_CLI\_DIRECTED\_FORWARDING\_ENABLE esp\_ble\_mesh\_register\_health\_client\_callback (C macro), 414 (C++ function), 446  
 esp\_ble\_mesh\_proxy\_client\_add\_filter\_add esp\_ble\_mesh\_register\_health\_server\_callback (C++ function), 413 (C++ function), 446  
 esp\_ble\_mesh\_proxy\_client\_connect esp\_ble\_mesh\_register\_lcd\_client\_callback (C++ function), 412 (C++ function), 681  
 esp\_ble\_mesh\_proxy\_client\_directed\_provision esp\_ble\_mesh\_register\_lcd\_server\_callback (C++ function), 413 (C++ function), 681  
 esp\_ble\_mesh\_proxy\_client\_disconnect esp\_ble\_mesh\_register\_light\_client\_callback (C++ function), 413 (C++ function), 547  
 esp\_ble\_mesh\_proxy\_client\_remove\_filter\_remove esp\_ble\_mesh\_register\_lighting\_server\_callback (C++ function), 413 (C++ function), 547  
 esp\_ble\_mesh\_proxy\_client\_send\_solic\_pkt esp\_ble\_mesh\_register\_odp\_client\_callback (C++ function), 413 (C++ function), 661  
 esp\_ble\_mesh\_proxy\_client\_set\_filter\_type esp\_ble\_mesh\_register\_odp\_server\_callback (C++ function), 413 (C++ function), 661  
 esp\_ble\_mesh\_proxy\_filter\_type\_t (C++ enum), 385 esp\_ble\_mesh\_register\_prb\_client\_callback (C++ function), 654  
 esp\_ble\_mesh\_proxy\_filter\_type\_t::PROXY\_FILTER\_MAX\_CLIENTS esp\_ble\_mesh\_register\_prb\_server\_callback (C++ enumerator), 385 (C++ function), 654  
 esp\_ble\_mesh\_proxy\_filter\_type\_t::PROXY\_FILTER\_MESH\_PROV esp\_ble\_mesh\_register\_prov\_callback (C++ enumerator), 385 (C++ function), 406

esp\_ble\_mesh\_register\_rpr\_client\_callback (C++ enumerator), 615  
 (C++ function), 603  
 esp\_ble\_mesh\_register\_rpr\_server\_callback (C++ enumerator), 615  
 (C++ function), 603  
 esp\_ble\_mesh\_register\_sar\_client\_callback (C++ enumerator), 615  
 (C++ function), 665  
 esp\_ble\_mesh\_register\_sar\_server\_callback (C++ enumerator), 615  
 (C++ function), 666  
 esp\_ble\_mesh\_register\_sensor\_client\_callback (C++ union), 605  
 (C++ function), 498  
 esp\_ble\_mesh\_register\_sensor\_server\_callback (C++ member), 605  
 (C++ function), 499  
 esp\_ble\_mesh\_register\_srpl\_client\_callback (C++ member), 606  
 (C++ function), 671  
 esp\_ble\_mesh\_register\_srpl\_server\_callback (C++ member), 605  
 (C++ function), 672  
 esp\_ble\_mesh\_register\_time\_scene\_client\_callback (C++ member), 606  
 (C++ function), 518  
 esp\_ble\_mesh\_register\_time\_scene\_server\_callback (C++ member), 605  
 (C++ function), 519  
 ESP\_BLE\_MESH\_RELAY\_DISABLED (C macro), 356  
 ESP\_BLE\_MESH\_RELAY\_ENABLED (C macro), 356  
 ESP\_BLE\_MESH\_RELAY\_NOT\_SUPPORTED (C macro), 357  
 ESP\_BLE\_MESH\_RPR\_AD\_TYPE\_FILTER\_CNT\_MAX (C macro), 612  
 ESP\_BLE\_MESH\_RPR\_AD\_TYPE\_FILTER\_CNT\_MIN (C macro), 612  
 esp\_ble\_mesh\_rpr\_client\_act\_evt\_t (C++ enum), 614  
 esp\_ble\_mesh\_rpr\_client\_act\_evt\_t::ESP\_BLE\_MESH\_RPR\_CLIENT\_ACT\_EVT\_REASON (C++ enumerator), 614  
 esp\_ble\_mesh\_rpr\_client\_act\_param\_t (C++ union), 604  
 esp\_ble\_mesh\_rpr\_client\_act\_param\_t::start\_rpr (C++ member), 604  
 esp\_ble\_mesh\_rpr\_client\_act\_type\_t (C++ enum), 614  
 esp\_ble\_mesh\_rpr\_client\_act\_type\_t::ESP\_BLE\_MESH\_RPR\_CLIENT\_ACT\_TYPE\_MAX (C++ enumerator), 614  
 esp\_ble\_mesh\_rpr\_client\_act\_type\_t::ESP\_BLE\_MESH\_RPR\_CLIENT\_ACT\_TYPE\_START\_RPR (C++ enumerator), 614  
 esp\_ble\_mesh\_rpr\_client\_action (C++ function), 603  
 esp\_ble\_mesh\_rpr\_client\_cb\_event\_t (C++ enum), 615  
 esp\_ble\_mesh\_rpr\_client\_cb\_event\_t::ESP\_BLE\_MESH\_RPR\_CLIENT\_CB\_EVENT\_COMP\_EVT (C++ enumerator), 615  
 esp\_ble\_mesh\_rpr\_client\_cb\_event\_t::ESP\_BLE\_MESH\_RPR\_CLIENT\_CB\_EVENT\_LINK\_CLOSE\_EVT (C++ enumerator), 615  
 esp\_ble\_mesh\_rpr\_client\_cb\_event\_t::ESP\_BLE\_MESH\_RPR\_CLIENT\_CB\_EVENT\_LINK\_OPEN\_EVT (C++ enumerator), 615  
 esp\_ble\_mesh\_rpr\_client\_cb\_event\_t::ESP\_BLE\_MESH\_RPR\_CLIENT\_CB\_EVENT\_PROMS\_COMP\_EVT (C++ enumerator), 615  
 esp\_ble\_mesh\_rpr\_client\_cb\_event\_t::ESP\_BLE\_MESH\_RPR\_CLIENT\_CB\_EVENT\_RECVS\_PUB\_EVT (C++ enumerator), 615  
 esp\_ble\_mesh\_rpr\_client\_cb\_event\_t::ESP\_BLE\_MESH\_RPR\_CLIENT\_CB\_EVENT\_SCAN\_START\_EVT (C++ enumerator), 615  
 esp\_ble\_mesh\_rpr\_client\_cb\_event\_t::ESP\_BLE\_MESH\_RPR\_CLIENT\_CB\_EVENT\_LINK\_CLOSE\_EVT (C++ member), 604  
 esp\_ble\_mesh\_rpr\_client\_cb\_event\_t::ESP\_BLE\_MESH\_RPR\_CLIENT\_CB\_EVENT\_LINK\_OPEN\_EVT (C++ member), 604  
 esp\_ble\_mesh\_rpr\_client\_cb\_event\_t::ESP\_BLE\_MESH\_RPR\_CLIENT\_CB\_EVENT\_PROMS\_COMP\_EVT (C++ member), 604  
 esp\_ble\_mesh\_rpr\_client\_cb\_event\_t::ESP\_BLE\_MESH\_RPR\_CLIENT\_CB\_EVENT\_RECVS\_PUB\_EVT (C++ member), 604  
 esp\_ble\_mesh\_rpr\_client\_cb\_event\_t::ESP\_BLE\_MESH\_RPR\_CLIENT\_CB\_EVENT\_SCAN\_START\_EVT (C++ member), 604  
 esp\_ble\_mesh\_rpr\_client\_cb\_event\_t::ESP\_BLE\_MESH\_RPR\_CLIENT\_CB\_EVENT\_REASON (C++ member), 605  
 esp\_ble\_mesh\_rpr\_client\_cb\_event\_t::recv (C++ member), 605  
 esp\_ble\_mesh\_rpr\_client\_cb\_event\_t::rpr\_srv\_addr (C++ member), 605  
 esp\_ble\_mesh\_rpr\_client\_cb\_event\_t::send (C++ member), 605  
 esp\_ble\_mesh\_rpr\_client\_cb\_event\_t::start\_rpr\_com (C++ member), 605  
 esp\_ble\_mesh\_rpr\_client\_cb\_event\_t::sub\_evt (C++ member), 605  
 esp\_ble\_mesh\_rpr\_client\_cb\_event\_t::unicast\_addr (C++ member), 606  
 esp\_ble\_mesh\_rpr\_client\_cb\_event\_t::uuid (C++ member), 606  
 esp\_ble\_mesh\_rpr\_client\_cb\_event\_t::val (C++ member), 605  
 esp\_ble\_mesh\_rpr\_client\_cb\_event\_t::MAX (C++ type), 614  
 esp\_ble\_mesh\_rpr\_client\_cb\_param\_t (C++ union), 604  
 esp\_ble\_mesh\_rpr\_client\_cb\_param\_t::act (C++ member), 605  
 esp\_ble\_mesh\_rpr\_client\_cb\_param\_t::element\_num (C++ member), 605  
 esp\_ble\_mesh\_rpr\_client\_cb\_param\_t::err\_code (C++ member), 606  
 esp\_ble\_mesh\_rpr\_client\_cb\_param\_t::index (C++ member), 606  
 esp\_ble\_mesh\_rpr\_client\_cb\_param\_t::link\_close (C++ member), 605  
 esp\_ble\_mesh\_rpr\_client\_cb\_param\_t::link\_open (C++ member), 605  
 esp\_ble\_mesh\_rpr\_client\_cb\_param\_t::model (C++ member), 605  
 esp\_ble\_mesh\_rpr\_client\_cb\_param\_t::net\_idx (C++ member), 606  
 esp\_ble\_mesh\_rpr\_client\_cb\_param\_t::nppi (C++ member), 606  
 esp\_ble\_mesh\_rpr\_client\_cb\_param\_t::params (C++ member), 605  
 esp\_ble\_mesh\_rpr\_client\_cb\_param\_t::prov (C++ member), 606  
 esp\_ble\_mesh\_rpr\_client\_cb\_param\_t::reason (C++ member), 605  
 esp\_ble\_mesh\_rpr\_client\_cb\_param\_t::recv (C++ member), 605  
 esp\_ble\_mesh\_rpr\_client\_cb\_param\_t::rpr\_srv\_addr (C++ member), 605  
 esp\_ble\_mesh\_rpr\_client\_cb\_param\_t::send (C++ member), 605  
 esp\_ble\_mesh\_rpr\_client\_cb\_param\_t::start\_rpr\_com (C++ member), 605  
 esp\_ble\_mesh\_rpr\_client\_cb\_param\_t::sub\_evt (C++ member), 605  
 esp\_ble\_mesh\_rpr\_client\_cb\_param\_t::unicast\_addr (C++ member), 606  
 esp\_ble\_mesh\_rpr\_client\_cb\_param\_t::uuid (C++ member), 606

- (C++ member), 604
- esp\_ble\_mesh\_rpr\_client\_msg\_t::scan\_status (C++ member), 604
- esp\_ble\_mesh\_rpr\_client\_recv\_cb\_t (C++ union), 604
- esp\_ble\_mesh\_rpr\_client\_recv\_cb\_t::ext\_scan\_report (C++ member), 604
- esp\_ble\_mesh\_rpr\_client\_recv\_cb\_t::link\_report (C++ member), 604
- esp\_ble\_mesh\_rpr\_client\_recv\_cb\_t::link\_status (C++ member), 604
- esp\_ble\_mesh\_rpr\_client\_recv\_cb\_t::scan\_caps\_status (C++ member), 604
- esp\_ble\_mesh\_rpr\_client\_recv\_cb\_t::scan\_report (C++ member), 604
- esp\_ble\_mesh\_rpr\_client\_recv\_cb\_t::scan\_status (C++ member), 604
- esp\_ble\_mesh\_rpr\_client\_send (C++ function), 603
- esp\_ble\_mesh\_rpr\_client\_start\_rpr\_t (C++ struct), 609
- esp\_ble\_mesh\_rpr\_client\_start\_rpr\_t::model (C++ member), 609
- esp\_ble\_mesh\_rpr\_client\_start\_rpr\_t::rpr\_srv\_status (C++ member), 609
- esp\_ble\_mesh\_rpr\_ext\_scan\_report\_t (C++ struct), 610
- esp\_ble\_mesh\_rpr\_ext\_scan\_report\_t::adv\_struct (C++ member), 610
- esp\_ble\_mesh\_rpr\_ext\_scan\_report\_t::oob\_info (C++ member), 610
- esp\_ble\_mesh\_rpr\_ext\_scan\_report\_t::oob\_info\_status (C++ member), 610
- esp\_ble\_mesh\_rpr\_ext\_scan\_report\_t::status (C++ member), 610
- esp\_ble\_mesh\_rpr\_ext\_scan\_report\_t::uuid (C++ member), 610
- esp\_ble\_mesh\_rpr\_ext\_scan\_report\_t::uuid\_en (C++ member), 608
- ESP\_BLE\_MESH\_RPR\_EXT\_SCAN\_TIMEOUT\_MAX (C macro), 612
- ESP\_BLE\_MESH\_RPR\_EXT\_SCAN\_TIMEOUT\_MIN (C macro), 612
- ESP\_BLE\_MESH\_RPR\_LINK\_ACTIVE (C macro), 613
- esp\_ble\_mesh\_rpr\_link\_close\_t (C++ struct), 609
- esp\_ble\_mesh\_rpr\_link\_close\_t::reason (C++ member), 609
- ESP\_BLE\_MESH\_RPR\_LINK\_CLOSING (C macro), 613
- ESP\_BLE\_MESH\_RPR\_LINK\_IDLE (C macro), 613
- esp\_ble\_mesh\_rpr\_link\_open\_t (C++ struct), 608
- esp\_ble\_mesh\_rpr\_link\_open\_t::nppi (C++ member), 609
- esp\_ble\_mesh\_rpr\_link\_open\_t::timeout (C++ member), 609
- esp\_ble\_mesh\_rpr\_link\_open\_t::timeout\_en (C++ member), 609
- esp\_ble\_mesh\_rpr\_link\_open\_t::uuid (C++ member), 608
- esp\_ble\_mesh\_rpr\_link\_open\_t::uuid\_en (C++ member), 608
- ESP\_BLE\_MESH\_RPR\_LINK\_OPEN\_TIMEOUT\_MAX (C macro), 612
- ESP\_BLE\_MESH\_RPR\_LINK\_OPEN\_TIMEOUT\_MIN (C macro), 612
- ESP\_BLE\_MESH\_RPR\_LINK\_OPENING (C macro), 613
- esp\_ble\_mesh\_rpr\_link\_report\_t (C++ struct), 611
- esp\_ble\_mesh\_rpr\_link\_report\_t::reason (C++ member), 611
- esp\_ble\_mesh\_rpr\_link\_report\_t::reason\_en (C++ member), 611
- esp\_ble\_mesh\_rpr\_link\_report\_t::rpr\_state (C++ member), 611
- esp\_ble\_mesh\_rpr\_link\_report\_t::status (C++ member), 611
- esp\_ble\_mesh\_rpr\_link\_status\_t (C++ struct), 611
- esp\_ble\_mesh\_rpr\_link\_status\_t::rpr\_state (C++ member), 611
- esp\_ble\_mesh\_rpr\_link\_status\_t::status (C++ member), 611
- ESP\_BLE\_MESH\_RPR\_LINK\_TIMEOUT\_DEFAULT (C macro), 613
- ESP\_BLE\_MESH\_RPR\_NOT\_SUPPORT\_ACTIVE\_SCAN (C macro), 612
- ESP\_BLE\_MESH\_RPR\_OUTBOUND\_PACKET\_TRANSFER (C macro), 612
- ESP\_BLE\_MESH\_RPR\_PROHIBIT\_SCAN\_TIMEOUT (C macro), 612
- ESP\_BLE\_MESH\_RPR\_REASON\_FAIL (C macro), 613
- ESP\_BLE\_MESH\_RPR\_REASON\_SUCCESS (C macro), 613
- esp\_ble\_mesh\_rpr\_scan\_caps\_status\_t (C++ struct), 609
- esp\_ble\_mesh\_rpr\_scan\_caps\_status\_t::active\_scan (C++ member), 609
- esp\_ble\_mesh\_rpr\_scan\_caps\_status\_t::max\_scan\_iter (C++ member), 609
- ESP\_BLE\_MESH\_RPR\_SCAN\_IDLE (C macro), 612
- ESP\_BLE\_MESH\_RPR\_SCAN\_MULTIPLE\_DEVICE (C macro), 612





(C macro), 613  
 ESP\_BLE\_MESH\_RPR\_STATUS\_LINK\_OPEN\_FAILED (C macro), 613  
 ESP\_BLE\_MESH\_RPR\_STATUS\_SCANNING\_CANNOT\_START (C macro), 613  
 ESP\_BLE\_MESH\_RPR\_STATUS\_SUCCESS (C macro), 613  
 ESP\_BLE\_MESH\_RPR\_SUPPORT\_ACTIVE\_SCAN (C macro), 612  
 esp\_ble\_mesh\_rssi\_threshold\_set\_t (C++ struct), 628  
 esp\_ble\_mesh\_rssi\_threshold\_set\_t::rssi\_threshold (C++ member), 628  
 esp\_ble\_mesh\_rssi\_threshold\_status\_t (C++ struct), 636  
 esp\_ble\_mesh\_rssi\_threshold\_status\_t::default\_rssi\_threshold (C++ member), 636  
 esp\_ble\_mesh\_rssi\_threshold\_status\_t::rssi\_threshold (C++ member), 636  
 esp\_ble\_mesh\_sar\_client\_cb\_event\_t (C++ enum), 671  
 esp\_ble\_mesh\_sar\_client\_cb\_event\_t::ESP\_BLE\_MESH\_SAR\_CLIENT\_CB\_EVENT\_MAX (C++ enumerator), 671  
 esp\_ble\_mesh\_sar\_client\_cb\_event\_t::ESP\_BLE\_MESH\_SAR\_CLIENT\_CB\_EVENT\_RECV\_PUB\_KEYS (C++ enumerator), 671  
 esp\_ble\_mesh\_sar\_client\_cb\_event\_t::ESP\_BLE\_MESH\_SAR\_CLIENT\_CB\_EVENT\_RECV\_RSP\_KEYS (C++ enumerator), 671  
 esp\_ble\_mesh\_sar\_client\_cb\_event\_t::ESP\_BLE\_MESH\_SAR\_CLIENT\_CB\_EVENT\_SEND\_COMPLETE (C++ enumerator), 671  
 esp\_ble\_mesh\_sar\_client\_cb\_event\_t::ESP\_BLE\_MESH\_SAR\_CLIENT\_CB\_EVENT\_TIMEOUT\_EVENT (C++ enumerator), 671  
 esp\_ble\_mesh\_sar\_client\_cb\_param\_t (C++ struct), 669  
 esp\_ble\_mesh\_sar\_client\_cb\_param\_t::params (C++ member), 669  
 esp\_ble\_mesh\_sar\_client\_cb\_param\_t::recv (C++ member), 669  
 esp\_ble\_mesh\_sar\_client\_cb\_param\_t::send (C++ member), 669  
 esp\_ble\_mesh\_sar\_client\_cb\_param\_t::[anonymous] (C++ member), 669  
 esp\_ble\_mesh\_sar\_client\_cb\_t (C++ type), 670  
 esp\_ble\_mesh\_sar\_client\_msg\_t (C++ union), 666  
 esp\_ble\_mesh\_sar\_client\_msg\_t::sar\_receive\_complete (C++ member), 666  
 esp\_ble\_mesh\_sar\_client\_msg\_t::sar\_transmit\_complete (C++ member), 666  
 esp\_ble\_mesh\_sar\_client\_rcv\_cb\_t (C++ union), 666  
 esp\_ble\_mesh\_sar\_client\_rcv\_cb\_t::sar\_receive\_complete (C++ member), 666  
 esp\_ble\_mesh\_sar\_client\_rcv\_cb\_t::sar\_transmit\_complete (C++ member), 666  
 esp\_ble\_mesh\_sar\_client\_send (C++ function), 665  
 esp\_ble\_mesh\_sar\_client\_send\_cb\_t (C++ struct), 669  
 esp\_ble\_mesh\_sar\_client\_send\_cb\_t::err\_code (C++ member), 669  
 esp\_ble\_mesh\_sar\_receiver\_set\_t (C++ struct), 667  
 esp\_ble\_mesh\_sar\_receiver\_set\_t::sar\_ack\_delay\_in (C++ member), 667  
 esp\_ble\_mesh\_sar\_receiver\_set\_t::sar\_ack\_retrans (C++ member), 668  
 esp\_ble\_mesh\_sar\_receiver\_set\_t::sar\_discard\_time (C++ member), 667  
 esp\_ble\_mesh\_sar\_receiver\_set\_t::sar\_receiver\_seg (C++ member), 668  
 esp\_ble\_mesh\_sar\_receiver\_set\_t::sar\_segments\_thr (C++ member), 667  
 esp\_ble\_mesh\_sar\_receiver\_set\_t::sar\_segments\_thr (C++ member), 667  
 esp\_ble\_mesh\_sar\_receiver\_status\_t (C++ struct), 668  
 esp\_ble\_mesh\_sar\_receiver\_status\_t::sar\_ack\_delay (C++ member), 668  
 esp\_ble\_mesh\_sar\_receiver\_status\_t::sar\_ack\_retra (C++ member), 669  
 esp\_ble\_mesh\_sar\_receiver\_status\_t::sar\_discard\_t (C++ member), 668  
 esp\_ble\_mesh\_sar\_receiver\_status\_t::sar\_receiver\_ (C++ member), 669  
 esp\_ble\_mesh\_sar\_receiver\_status\_t::sar\_segments\_ (C++ member), 668  
 esp\_ble\_mesh\_sar\_server\_cb\_event\_t (C++ enum), 671  
 esp\_ble\_mesh\_sar\_server\_cb\_event\_t::ESP\_BLE\_MESH\_SAR\_SERVER\_CB\_EVENT\_RECV\_PUB\_KEYS (C++ enumerator), 671  
 esp\_ble\_mesh\_sar\_server\_cb\_event\_t::ESP\_BLE\_MESH\_SAR\_SERVER\_CB\_EVENT\_RECV\_RSP\_KEYS (C++ enumerator), 671  
 esp\_ble\_mesh\_sar\_server\_cb\_event\_t::ESP\_BLE\_MESH\_SAR\_SERVER\_CB\_EVENT\_SEND\_COMPLETE (C++ enumerator), 671  
 esp\_ble\_mesh\_sar\_server\_cb\_event\_t::ESP\_BLE\_MESH\_SAR\_SERVER\_CB\_EVENT\_TIMEOUT\_EVENT (C++ enumerator), 671  
 esp\_ble\_mesh\_sar\_server\_cb\_param\_t (C++ struct), 669  
 esp\_ble\_mesh\_sar\_server\_cb\_param\_t::ctx (C++ member), 669  
 esp\_ble\_mesh\_sar\_server\_cb\_param\_t::model (C++ member), 669  
 esp\_ble\_mesh\_sar\_server\_cb\_param\_t::value (C++ member), 669  
 esp\_ble\_mesh\_sar\_server\_cb\_t (C++ type), 670  
 esp\_ble\_mesh\_sar\_server\_cb\_value\_t (C++ union), 666  
 esp\_ble\_mesh\_sar\_server\_cb\_value\_t::state\_change (C++ member), 666  
 esp\_ble\_mesh\_sar\_server\_state\_change\_t (C++ union), 666  
 esp\_ble\_mesh\_sar\_server\_state\_change\_t::dummy (C++ member), 666  
 esp\_ble\_mesh\_sar\_srv\_t (C++ struct), 667  
 esp\_ble\_mesh\_sar\_srv\_t::model (C++ member), 667  
 esp\_ble\_mesh\_sar\_transmitter\_set\_t (C++ struct), 667  
 esp\_ble\_mesh\_sar\_transmitter\_set\_t::sar\_multicast (C++ member), 667

esp\_ble\_mesh\_sar\_transmitter\_set\_t::sar\_scene\_number (C++ member), 667  
 esp\_ble\_mesh\_sar\_transmitter\_set\_t::sar\_scene\_setup\_step (C++ member), 667  
 esp\_ble\_mesh\_sar\_transmitter\_set\_t::sar\_scene\_type (C++ member), 667  
 esp\_ble\_mesh\_sar\_transmitter\_set\_t::sar\_scene\_integral\_increment\_value (C++ member), 667  
 esp\_ble\_mesh\_sar\_transmitter\_set\_t::sar\_scene\_interval\_step (C++ member), 667  
 esp\_ble\_mesh\_sar\_transmitter\_set\_t::sar\_scene\_without\_progress\_count (C++ member), 667  
 esp\_ble\_mesh\_sar\_transmitter\_status\_t esp\_ble\_mesh\_scene\_setup\_srv\_t::rsp\_ctrl (C++ struct), 668  
 esp\_ble\_mesh\_sar\_transmitter\_status\_t::esp\_ble\_mesh\_sar\_transmitter\_status\_t::state (C++ member), 668  
 esp\_ble\_mesh\_sar\_transmitter\_status\_t::esp\_ble\_mesh\_sar\_transmitter\_status\_t::last (C++ member), 668  
 esp\_ble\_mesh\_sar\_transmitter\_status\_t::sar\_scene\_interval\_step (C++ member), 668  
 esp\_ble\_mesh\_sar\_transmitter\_status\_t::sar\_scene\_trans\_count (C++ member), 668  
 esp\_ble\_mesh\_sar\_transmitter\_status\_t::sar\_scene\_interval\_increment (C++ member), 668  
 esp\_ble\_mesh\_sar\_transmitter\_status\_t::sar\_scene\_without\_progress\_count (C++ member), 668  
 esp\_ble\_mesh\_scene\_delete\_t (C++ struct), 524  
 esp\_ble\_mesh\_scene\_delete\_t::scene\_number (C++ member), 524  
 ESP\_BLE\_MESH\_SCENE\_NOT\_FOUND (C macro), 545  
 ESP\_BLE\_MESH\_SCENE\_NUMBER\_LEN (C macro), 543  
 esp\_ble\_mesh\_scene\_recall\_t (C++ struct), 524  
 esp\_ble\_mesh\_scene\_recall\_t::delay (C++ member), 524  
 esp\_ble\_mesh\_scene\_recall\_t::op\_en (C++ member), 524  
 esp\_ble\_mesh\_scene\_recall\_t::scene\_number (C++ member), 524  
 esp\_ble\_mesh\_scene\_recall\_t::tid (C++ member), 524  
 esp\_ble\_mesh\_scene\_recall\_t::trans\_time (C++ member), 524  
 ESP\_BLE\_MESH\_SCENE\_REG\_FULL (C macro), 545  
 esp\_ble\_mesh\_scene\_register\_status\_cb\_t (C++ struct), 527  
 esp\_ble\_mesh\_scene\_register\_status\_cb\_t::current\_scene (C++ member), 527  
 esp\_ble\_mesh\_scene\_register\_status\_cb\_t::scene (C++ member), 527  
 esp\_ble\_mesh\_scene\_register\_status\_cb\_t::status\_code (C++ member), 527  
 esp\_ble\_mesh\_scene\_register\_status\_cb\_t::target\_scene (C++ member), 527  
 esp\_ble\_mesh\_scenes\_registered\_t (C++ struct), 530  
 esp\_ble\_mesh\_scenes\_registered\_t::scene\_number (C++ member), 531  
 esp\_ble\_mesh\_scenes\_registered\_t::scene\_type (C++ member), 531  
 esp\_ble\_mesh\_scenes\_registered\_t::scene\_integral\_increment\_value (C++ member), 531  
 esp\_ble\_mesh\_scenes\_registered\_t::scene\_interval\_step (C++ member), 532  
 esp\_ble\_mesh\_scenes\_registered\_t::scene\_without\_progress\_count (C++ member), 532  
 esp\_ble\_mesh\_scene\_srv\_t::last (C++ member), 532  
 esp\_ble\_mesh\_scene\_srv\_t::model (C++ member), 532  
 esp\_ble\_mesh\_scene\_srv\_t::rsp\_ctrl (C++ member), 532  
 esp\_ble\_mesh\_scene\_srv\_t::state (C++ member), 532  
 esp\_ble\_mesh\_scene\_srv\_t::transition (C++ member), 532  
 esp\_ble\_mesh\_scene\_status\_cb\_t (C++ struct), 527  
 esp\_ble\_mesh\_scene\_status\_cb\_t::current\_scene (C++ member), 527  
 esp\_ble\_mesh\_scene\_status\_cb\_t::op\_en (C++ member), 527  
 esp\_ble\_mesh\_scene\_status\_cb\_t::remain\_time (C++ member), 527  
 esp\_ble\_mesh\_scene\_status\_cb\_t::status\_code (C++ member), 527  
 esp\_ble\_mesh\_scene\_status\_cb\_t::target\_scene (C++ member), 527  
 esp\_ble\_mesh\_scene\_store\_t (C++ struct), 524  
 esp\_ble\_mesh\_scene\_store\_t::scene\_number (C++ member), 524  
 ESP\_BLE\_MESH\_SCENE\_SUCCESS (C macro), 545  
 esp\_ble\_mesh\_scenes\_state\_t (C++ struct), 531  
 esp\_ble\_mesh\_scenes\_state\_t::current\_scene (C++ member), 531  
 esp\_ble\_mesh\_scenes\_state\_t::in\_progress (C++ member), 532  
 esp\_ble\_mesh\_scenes\_state\_t::scene\_count (C++ member), 531  
 esp\_ble\_mesh\_scenes\_state\_t::scenes (C++ member), 531  
 esp\_ble\_mesh\_scenes\_state\_t::status\_code (C++ member), 532  
 esp\_ble\_mesh\_scenes\_state\_t::target\_scene (C++ member), 531

---

ESP\_BLE\_MESH\_SCHEDULE\_ACT\_NO\_ACTION (C macro), 544

ESP\_BLE\_MESH\_SCHEDULE\_ACT\_SCENE\_RECALL (C macro), 544

ESP\_BLE\_MESH\_SCHEDULE\_ACT\_TURN\_OFF (C macro), 544

ESP\_BLE\_MESH\_SCHEDULE\_ACT\_TURN\_ON (C macro), 544

ESP\_BLE\_MESH\_SCHEDULE\_DAY\_ANY\_DAY (C macro), 544

ESP\_BLE\_MESH\_SCHEDULE\_ENTRY\_MAX\_INDEX (C macro), 545

ESP\_BLE\_MESH\_SCHEDULE\_HOUR\_ANY\_HOUR (C macro), 544

ESP\_BLE\_MESH\_SCHEDULE\_HOUR\_ONCE\_A\_DAY (C macro), 544

esp\_ble\_mesh\_schedule\_register\_t (C++ struct), 532

esp\_ble\_mesh\_schedule\_register\_t::action (C++ member), 533

esp\_ble\_mesh\_schedule\_register\_t::day (C++ member), 533

esp\_ble\_mesh\_schedule\_register\_t::day\_of\_week (C++ member), 533

esp\_ble\_mesh\_schedule\_register\_t::hour (C++ member), 533

esp\_ble\_mesh\_schedule\_register\_t::in\_use (C++ member), 533

esp\_ble\_mesh\_schedule\_register\_t::minutes (C++ member), 533

esp\_ble\_mesh\_schedule\_register\_t::months (C++ member), 533

esp\_ble\_mesh\_schedule\_register\_t::scene\_number (C++ member), 533

esp\_ble\_mesh\_schedule\_register\_t::seconds (C++ member), 533

esp\_ble\_mesh\_schedule\_register\_t::trans\_time (C++ member), 533

esp\_ble\_mesh\_schedule\_register\_t::year (C++ member), 533

ESP\_BLE\_MESH\_SCHEDULE\_SCENE\_NO\_SCENE (C macro), 545

ESP\_BLE\_MESH\_SCHEDULE\_SEC\_ANY\_OF\_HOUR (C macro), 544

ESP\_BLE\_MESH\_SCHEDULE\_SEC\_ANY\_OF\_MIN (C macro), 544

ESP\_BLE\_MESH\_SCHEDULE\_SEC EVERY\_15\_MIN (C macro), 544

ESP\_BLE\_MESH\_SCHEDULE\_SEC EVERY\_15\_SEC (C macro), 544

ESP\_BLE\_MESH\_SCHEDULE\_SEC EVERY\_20\_MIN (C macro), 544

ESP\_BLE\_MESH\_SCHEDULE\_SEC EVERY\_20\_SEC (C macro), 544

ESP\_BLE\_MESH\_SCHEDULE\_SEC\_ONCE\_AN\_HOUR (C macro), 544

ESP\_BLE\_MESH\_SCHEDULE\_SEC\_ONCE\_AN\_MIN (C macro), 544

ESP\_BLE\_MESH\_SCHEDULE\_YEAR\_ANY\_YEAR (C macro), 544

esp\_ble\_mesh\_scheduler\_act\_get\_t (C++ struct), 524

esp\_ble\_mesh\_scheduler\_act\_get\_t::index (C++ member), 525

esp\_ble\_mesh\_scheduler\_act\_set\_t (C++ struct), 525

esp\_ble\_mesh\_scheduler\_act\_set\_t::action (C++ member), 525

esp\_ble\_mesh\_scheduler\_act\_set\_t::day (C++ member), 525

esp\_ble\_mesh\_scheduler\_act\_set\_t::day\_of\_week (C++ member), 525

esp\_ble\_mesh\_scheduler\_act\_set\_t::hour (C++ member), 525

esp\_ble\_mesh\_scheduler\_act\_set\_t::index (C++ member), 525

esp\_ble\_mesh\_scheduler\_act\_set\_t::minute (C++ member), 525

esp\_ble\_mesh\_scheduler\_act\_set\_t::month (C++ member), 525

esp\_ble\_mesh\_scheduler\_act\_set\_t::scene\_number (C++ member), 525

esp\_ble\_mesh\_scheduler\_act\_set\_t::second (C++ member), 525

esp\_ble\_mesh\_scheduler\_act\_set\_t::trans\_time (C++ member), 525

esp\_ble\_mesh\_scheduler\_act\_set\_t::year (C++ member), 525

esp\_ble\_mesh\_scheduler\_act\_status\_cb\_t (C++ struct), 528

esp\_ble\_mesh\_scheduler\_act\_status\_cb\_t::action (C++ member), 528

esp\_ble\_mesh\_scheduler\_act\_status\_cb\_t::day (C++ member), 528

esp\_ble\_mesh\_scheduler\_act\_status\_cb\_t::day\_of\_week (C++ member), 528

esp\_ble\_mesh\_scheduler\_act\_status\_cb\_t::hour (C++ member), 528

esp\_ble\_mesh\_scheduler\_act\_status\_cb\_t::index (C++ member), 528

esp\_ble\_mesh\_scheduler\_act\_status\_cb\_t::minute (C++ member), 528

esp\_ble\_mesh\_scheduler\_act\_status\_cb\_t::month (C++ member), 528

esp\_ble\_mesh\_scheduler\_act\_status\_cb\_t::scene\_number (C++ member), 528

esp\_ble\_mesh\_scheduler\_act\_status\_cb\_t::second (C++ member), 528

esp\_ble\_mesh\_scheduler\_act\_status\_cb\_t::trans\_time (C++ member), 528

esp\_ble\_mesh\_scheduler\_act\_status\_cb\_t::year (C++ member), 528

esp\_ble\_mesh\_scheduler\_setup\_srv\_t (C++ struct), 534

esp\_ble\_mesh\_scheduler\_setup\_srv\_t::model (C++ member), 534









- esp\_ble\_mesh\_sensor\_setting\_t::access (C macro), 514  
 (C++ member), 507  
 esp\_ble\_mesh\_sensor\_setting\_t::property\_id (C macro), 515  
 (C++ member), 507  
 esp\_ble\_mesh\_sensor\_setting\_t::raw (C macro), 515  
 (C++ member), 507  
 esp\_ble\_mesh\_sensor\_settings\_get\_t (C macro), 514  
 (C++ struct), 503  
 esp\_ble\_mesh\_sensor\_settings\_get\_t::sensor\_property\_id (C macro), 514  
 (C++ member), 503  
 esp\_ble\_mesh\_sensor\_settings\_status\_cb\_t 381  
 (C++ struct), 505  
 esp\_ble\_mesh\_sensor\_settings\_status\_cb\_t::send\_data (C++ function), 398  
 (C++ member), 505  
 esp\_ble\_mesh\_sensor\_settings\_status\_cb\_t::send\_data (C++ function), 399  
 (C++ member), 505  
 esp\_ble\_mesh\_sensor\_setup\_srv\_t (C++ struct), 509  
 esp\_ble\_mesh\_sensor\_setup\_srv\_t::model (C++ member), 509  
 (C++ member), 509  
 esp\_ble\_mesh\_sensor\_setup\_srv\_t::rsp\_ctrl (C++ struct), 490  
 (C++ member), 509  
 esp\_ble\_mesh\_sensor\_setup\_srv\_t::state\_count (C++ member), 490  
 (C++ member), 509  
 esp\_ble\_mesh\_sensor\_setup\_srv\_t::states (C++ member), 490  
 (C++ member), 509  
 esp\_ble\_mesh\_sensor\_srv\_t (C++ struct), 509  
 esp\_ble\_mesh\_sensor\_srv\_t::model (C++ member), 509  
 (C++ member), 509  
 esp\_ble\_mesh\_sensor\_srv\_t::rsp\_ctrl (C++ member), 509  
 (C++ member), 509  
 esp\_ble\_mesh\_sensor\_srv\_t::state\_count (C++ member), 509  
 (C++ member), 509  
 esp\_ble\_mesh\_sensor\_srv\_t::states (C++ member), 509  
 (C++ member), 509  
 esp\_ble\_mesh\_sensor\_state\_t (C++ struct), 508  
 esp\_ble\_mesh\_sensor\_state\_t::cadence (C++ member), 508  
 (C++ member), 508  
 esp\_ble\_mesh\_sensor\_state\_t::descriptor (C++ member), 508  
 (C++ member), 508  
 esp\_ble\_mesh\_sensor\_state\_t::sensor\_data (C++ member), 509  
 (C++ member), 509  
 esp\_ble\_mesh\_sensor\_state\_t::sensor\_property\_id (C++ member), 508  
 (C++ member), 508  
 esp\_ble\_mesh\_sensor\_state\_t::series\_color (C++ member), 509  
 (C++ member), 509  
 esp\_ble\_mesh\_sensor\_state\_t::setting\_count (C++ member), 508  
 (C++ member), 508  
 esp\_ble\_mesh\_sensor\_state\_t::settings (C++ member), 508  
 (C++ member), 508  
 esp\_ble\_mesh\_sensor\_status\_cb\_t (C++ struct), 505  
 (C++ member), 505  
 esp\_ble\_mesh\_sensor\_status\_cb\_t::marshal\_data (C++ member), 505  
 (C++ member), 505  
 ESP\_BLE\_MESH\_SENSOR\_STATUS\_MIN\_INTERVAL (C macro), 514  
 ESP\_BLE\_MESH\_SENSOR\_STATUS\_MIN\_INTERVAL\_MAX (C macro), 514  
 ESP\_BLE\_MESH\_SENSOR\_STATUS\_TRIGGER\_TYPE\_CHAR (C macro), 515  
 ESP\_BLE\_MESH\_SENSOR\_STATUS\_TRIGGER\_TYPE\_UINT16 (C macro), 515  
 ESP\_BLE\_MESH\_SENSOR\_UNSPECIFIED\_NEG\_TOLERANCE (C macro), 514  
 ESP\_BLE\_MESH\_SENSOR\_UNSPECIFIED\_POS\_TOLERANCE (C macro), 514  
 ESP\_BLE\_MESH\_SERVER\_AUTO\_RSP (C macro), 381  
 esp\_ble\_mesh\_server\_model\_send\_msg (C++ function), 398  
 (C++ member), 486  
 esp\_ble\_mesh\_server\_model\_update\_state (C++ function), 399  
 (C++ member), 486  
 esp\_ble\_mesh\_server\_recv\_gen\_admin\_property\_get\_t (C++ struct), 486  
 (C++ member), 486  
 esp\_ble\_mesh\_server\_recv\_gen\_admin\_property\_get\_t (C++ member), 486  
 (C++ member), 486  
 esp\_ble\_mesh\_server\_recv\_gen\_admin\_property\_set\_t (C++ struct), 490  
 (C++ member), 490  
 esp\_ble\_mesh\_server\_recv\_gen\_admin\_property\_set\_t (C++ member), 490  
 (C++ member), 490  
 esp\_ble\_mesh\_server\_recv\_gen\_admin\_property\_set\_t (C++ member), 490  
 (C++ member), 490  
 esp\_ble\_mesh\_server\_recv\_gen\_admin\_property\_set\_t (C++ member), 490  
 (C++ member), 490  
 esp\_ble\_mesh\_server\_recv\_gen\_admin\_property\_set\_t (C++ member), 490  
 (C++ member), 490  
 esp\_ble\_mesh\_server\_recv\_gen\_client\_properties\_get\_t (C++ struct), 486  
 (C++ member), 486  
 esp\_ble\_mesh\_server\_recv\_gen\_client\_properties\_get\_t (C++ member), 486  
 (C++ member), 486  
 esp\_ble\_mesh\_server\_recv\_gen\_def\_trans\_time\_set\_t (C++ struct), 488  
 (C++ member), 488  
 esp\_ble\_mesh\_server\_recv\_gen\_def\_trans\_time\_set\_t (C++ member), 488  
 (C++ member), 488  
 esp\_ble\_mesh\_server\_recv\_gen\_delta\_set\_t (C++ struct), 487  
 (C++ member), 487  
 esp\_ble\_mesh\_server\_recv\_gen\_delta\_set\_t::delay (C++ member), 487  
 (C++ member), 487  
 esp\_ble\_mesh\_server\_recv\_gen\_delta\_set\_t::delta\_1 (C++ member), 487  
 (C++ member), 487  
 esp\_ble\_mesh\_server\_recv\_gen\_delta\_set\_t::open\_time (C++ member), 487  
 (C++ member), 487  
 esp\_ble\_mesh\_server\_recv\_gen\_delta\_set\_t::tid (C++ member), 487  
 (C++ member), 487  
 esp\_ble\_mesh\_server\_recv\_gen\_delta\_set\_t::trans\_time (C++ member), 487  
 (C++ member), 487  
 esp\_ble\_mesh\_server\_recv\_gen\_level\_set\_t (C++ struct), 487  
 (C++ member), 487  
 esp\_ble\_mesh\_server\_recv\_gen\_level\_set\_t::delay (C++ member), 487  
 (C++ member), 487  
 esp\_ble\_mesh\_server\_recv\_gen\_level\_set\_t::level (C++ member), 487  
 (C++ member), 487  
 esp\_ble\_mesh\_server\_recv\_gen\_level\_set\_t::open\_time (C++ member), 487  
 (C++ member), 487  
 esp\_ble\_mesh\_server\_recv\_gen\_level\_set\_t::tid (C++ member), 487  
 (C++ member), 487  
 esp\_ble\_mesh\_server\_recv\_gen\_level\_set\_t::trans\_time (C++ member), 487  
 (C++ member), 487

(C++ member), 487  
 esp\_ble\_mesh\_server\_rcv\_gen\_loc\_global\_set\_t (C++ struct), 489  
 esp\_ble\_mesh\_server\_rcv\_gen\_loc\_global\_set\_t::mesh\_attribute (C++ member), 489  
 esp\_ble\_mesh\_server\_rcv\_gen\_loc\_global\_set\_t::mesh\_derived\_attribute (C++ member), 489  
 esp\_ble\_mesh\_server\_rcv\_gen\_loc\_global\_set\_t::mesh\_divergence (C++ member), 489  
 esp\_ble\_mesh\_server\_rcv\_gen\_loc\_global\_set\_t::mesh\_divergence\_id (C++ member), 489  
 esp\_ble\_mesh\_server\_rcv\_gen\_loc\_local\_set\_t (C++ struct), 489  
 esp\_ble\_mesh\_server\_rcv\_gen\_loc\_local\_set\_t::mesh\_number (C++ member), 490  
 esp\_ble\_mesh\_server\_rcv\_gen\_loc\_local\_set\_t::mesh\_service\_id (C++ member), 490  
 esp\_ble\_mesh\_server\_rcv\_gen\_loc\_local\_set\_t::mesh\_start (C++ member), 489  
 esp\_ble\_mesh\_server\_rcv\_gen\_loc\_local\_set\_t::mesh\_start\_time (C++ member), 489  
 esp\_ble\_mesh\_server\_rcv\_gen\_loc\_local\_set\_t::mesh\_start\_time\_interval (C++ member), 490  
 esp\_ble\_mesh\_server\_rcv\_gen\_manufacture\_specific\_mesh\_get\_server\_rcv\_gen\_power\_range\_set\_t::range (C++ struct), 486  
 esp\_ble\_mesh\_server\_rcv\_gen\_manufacture\_specific\_mesh\_get\_server\_property\_id (C++ member), 486  
 esp\_ble\_mesh\_server\_rcv\_gen\_manufacture\_specific\_mesh\_get\_server\_user\_property\_get\_t::property\_id (C++ struct), 486  
 esp\_ble\_mesh\_server\_rcv\_gen\_manufacture\_specific\_mesh\_get\_server\_property\_id (C++ member), 490  
 esp\_ble\_mesh\_server\_rcv\_gen\_manufacture\_specific\_mesh\_get\_server\_property\_id (C++ struct), 490  
 esp\_ble\_mesh\_server\_rcv\_gen\_manufacture\_specific\_mesh\_get\_server\_user\_agreement (C++ member), 490  
 esp\_ble\_mesh\_server\_rcv\_gen\_move\_set\_t (C++ struct), 487  
 esp\_ble\_mesh\_server\_rcv\_gen\_move\_set\_t::delay (C++ member), 488  
 esp\_ble\_mesh\_server\_rcv\_gen\_move\_set\_t::delta\_time (C++ member), 488  
 esp\_ble\_mesh\_server\_rcv\_gen\_move\_set\_t::period (C++ member), 488  
 esp\_ble\_mesh\_server\_rcv\_gen\_move\_set\_t::idle (C++ member), 488  
 esp\_ble\_mesh\_server\_rcv\_gen\_move\_set\_t::start\_time (C++ member), 488  
 esp\_ble\_mesh\_server\_rcv\_gen\_onoff\_set\_t (C++ struct), 486  
 esp\_ble\_mesh\_server\_rcv\_gen\_onoff\_set\_t::delay (C++ member), 486  
 esp\_ble\_mesh\_server\_rcv\_gen\_onoff\_set\_t::on\_time (C++ member), 486  
 esp\_ble\_mesh\_server\_rcv\_gen\_onoff\_set\_t::off\_time (C++ member), 486  
 esp\_ble\_mesh\_server\_rcv\_gen\_onoff\_set\_t::open (C++ member), 486  
 esp\_ble\_mesh\_server\_rcv\_gen\_onoff\_set\_t::temperature (C++ member), 486  
 esp\_ble\_mesh\_server\_rcv\_gen\_onoff\_set\_t::transmission\_time (C++ member), 486  
 esp\_ble\_mesh\_server\_rcv\_gen\_onpowerup\_set\_t (C++ struct), 488  
 esp\_ble\_mesh\_server\_rcv\_gen\_onpowerup\_set\_t::mesh\_number (C++ member), 488



- (C++ struct), 591
- esp\_ble\_mesh\_server\_rcv\_light\_ctl\_temperature\_range\_get\_t (C++ member), 591
- esp\_ble\_mesh\_server\_rcv\_light\_ctl\_temperature\_range\_set\_t (C++ member), 591
- esp\_ble\_mesh\_server\_rcv\_light\_ctl\_temperature\_range\_hsl\_saturation\_set\_t (C++ struct), 591
- esp\_ble\_mesh\_server\_rcv\_light\_ctl\_temperature\_range\_hsl\_set\_t::delay (C++ member), 592
- esp\_ble\_mesh\_server\_rcv\_light\_ctl\_temperature\_range\_hsl\_set\_t::hue (C++ member), 591
- esp\_ble\_mesh\_server\_rcv\_light\_ctl\_temperature\_range\_hsl\_set\_t::lightness (C++ member), 591
- esp\_ble\_mesh\_server\_rcv\_light\_ctl\_temperature\_range\_hsl\_set\_t::open (C++ member), 591
- esp\_ble\_mesh\_server\_rcv\_light\_ctl\_temperature\_range\_hsl\_set\_t::saturation (C++ member), 592
- esp\_ble\_mesh\_server\_rcv\_light\_ctl\_temperature\_range\_hsl\_set\_t::tid (C++ member), 592
- esp\_ble\_mesh\_server\_rcv\_light\_ctl\_temperature\_range\_hsl\_set\_t::transmission (C++ member), 592
- esp\_ble\_mesh\_server\_rcv\_light\_hsl\_default\_hsl (C++ struct), 593
- esp\_ble\_mesh\_server\_rcv\_light\_hsl\_default\_hsl\_hue (C++ member), 593
- esp\_ble\_mesh\_server\_rcv\_light\_hsl\_default\_hsl\_lightness (C++ member), 593
- esp\_ble\_mesh\_server\_rcv\_light\_hsl\_default\_hsl\_saturation (C++ member), 593
- esp\_ble\_mesh\_server\_rcv\_light\_hsl\_hue\_get\_t (C++ struct), 592
- esp\_ble\_mesh\_server\_rcv\_light\_hsl\_hue\_set\_t (C++ member), 592
- esp\_ble\_mesh\_server\_rcv\_light\_hsl\_hue\_hsl (C++ struct), 595
- esp\_ble\_mesh\_server\_rcv\_light\_hsl\_hue\_hsl\_set\_t::mode (C++ member), 595
- esp\_ble\_mesh\_server\_rcv\_light\_hsl\_hue\_hsl\_set\_t (C++ struct), 595
- esp\_ble\_mesh\_server\_rcv\_light\_hsl\_hue\_hsl\_set\_t::mode (C++ member), 595
- esp\_ble\_mesh\_server\_rcv\_light\_hsl\_range\_get\_t (C++ struct), 593
- esp\_ble\_mesh\_server\_rcv\_light\_hsl\_range\_set\_max (C++ member), 588
- esp\_ble\_mesh\_server\_rcv\_light\_hsl\_range\_set\_min (C++ struct), 595
- esp\_ble\_mesh\_server\_rcv\_light\_hsl\_range\_set\_max\_min (C++ member), 596
- esp\_ble\_mesh\_server\_rcv\_light\_hsl\_range\_set\_max\_min (C++ member), 596
- esp\_ble\_mesh\_server\_rcv\_light\_hsl\_saturation\_get\_t (C++ struct), 592
- esp\_ble\_mesh\_server\_rcv\_light\_hsl\_saturation\_set\_t (C++ member), 593
- esp\_ble\_mesh\_server\_rcv\_light\_hsl\_saturation\_set\_t (C++ struct), 589
- esp\_ble\_mesh\_server\_rcv\_light\_hsl\_saturation\_set\_t::saturation (C++ member), 592
- esp\_ble\_mesh\_server\_rcv\_light\_hsl\_saturation\_set\_t (C++ member), 589
- esp\_ble\_mesh\_server\_rcv\_light\_hsl\_saturation\_set\_t (C++ member), 589



- (C++ member), 512
- esp\_ble\_mesh\_server\_rcv\_sensor\_column\_desc\_t (C++ struct), 511
- esp\_ble\_mesh\_server\_rcv\_sensor\_column\_desc\_t::prop\_start\_view (C++ member), 512
- esp\_ble\_mesh\_server\_rcv\_sensor\_column\_desc\_t::max\_value (C++ member), 512
- esp\_ble\_mesh\_server\_rcv\_sensor\_desc\_t (C++ struct), 510
- esp\_ble\_mesh\_server\_rcv\_sensor\_desc\_t::mesh\_server\_rcv\_time\_set\_t::tai\_seconds (C++ member), 537
- esp\_ble\_mesh\_server\_rcv\_sensor\_desc\_t::mesh\_server\_rcv\_time\_set\_t::tai\_utc\_delta (C++ member), 537
- esp\_ble\_mesh\_server\_rcv\_sensor\_desc\_t::mesh\_server\_rcv\_time\_set\_t::time\_authority (C++ member), 537
- esp\_ble\_mesh\_server\_rcv\_sensor\_get\_t (C++ struct), 511
- esp\_ble\_mesh\_server\_rcv\_sensor\_get\_t::esp\_ble\_mesh\_server\_rcv\_time\_set\_t::uncertainty (C++ member), 537
- esp\_ble\_mesh\_server\_rcv\_sensor\_get\_t::esp\_ble\_mesh\_server\_rcv\_time\_status\_t (C++ member), 511
- esp\_ble\_mesh\_server\_rcv\_sensor\_series\_desc\_t (C++ struct), 512
- esp\_ble\_mesh\_server\_rcv\_sensor\_series\_desc\_t::mesh\_server\_rcv\_time\_status\_t::tai\_seconds (C++ member), 540
- esp\_ble\_mesh\_server\_rcv\_sensor\_series\_desc\_t::prop\_start\_view (C++ member), 540
- esp\_ble\_mesh\_server\_rcv\_sensor\_series\_desc\_t::max\_value (C++ member), 540
- esp\_ble\_mesh\_server\_rcv\_sensor\_series\_desc\_t::mesh\_server\_rcv\_time\_status\_t::time\_authority (C++ member), 540
- esp\_ble\_mesh\_server\_rcv\_sensor\_setting\_set\_t (C++ struct), 511
- esp\_ble\_mesh\_server\_rcv\_sensor\_setting\_set\_t::mesh\_server\_rcv\_time\_status\_t::uncertainty (C++ member), 540
- esp\_ble\_mesh\_server\_rcv\_sensor\_setting\_set\_t::mesh\_server\_rcv\_time\_zone\_set\_t (C++ member), 511
- esp\_ble\_mesh\_server\_rcv\_sensor\_setting\_set\_t::mesh\_server\_rcv\_time\_zone\_set\_t::tai\_zone (C++ member), 538
- esp\_ble\_mesh\_server\_rcv\_sensor\_setting\_set\_t::mesh\_server\_rcv\_time\_zone\_set\_t::time\_zone (C++ member), 538
- esp\_ble\_mesh\_server\_rcv\_sensor\_setting\_set\_t::ESP\_BLE\_MESH\_SERVER\_PROP\_BY\_APP (C++ member), 512
- esp\_ble\_mesh\_server\_rcv\_sensor\_setting\_set\_t::mesh\_server\_rsp\_ctrl\_t (C++ member), 512
- esp\_ble\_mesh\_server\_rcv\_sensor\_setting\_set\_t::mesh\_server\_rsp\_ctrl\_t::get\_auto\_rsp (C++ member), 511
- esp\_ble\_mesh\_server\_rcv\_sensor\_setting\_set\_t::mesh\_server\_rsp\_ctrl\_t::set\_auto\_rsp (C++ member), 511
- esp\_ble\_mesh\_server\_rcv\_sensor\_status\_t (C++ struct), 596
- esp\_ble\_mesh\_server\_rcv\_sensor\_status\_t::esp\_data\_mesh\_server\_state\_type\_t (C++ member), 596
- esp\_ble\_mesh\_server\_rcv\_tai\_utc\_delta\_desc\_t (C++ struct), 538
- esp\_ble\_mesh\_server\_rcv\_tai\_utc\_delta\_desc\_t::mesh\_server\_state\_type\_t::ESP\_BLE\_MESH\_GE (C++ member), 538
- esp\_ble\_mesh\_server\_rcv\_tai\_utc\_delta\_desc\_t::mesh\_server\_state\_type\_t::ESP\_BLE\_MESH\_GE (C++ member), 538
- esp\_ble\_mesh\_server\_rcv\_tai\_utc\_delta\_desc\_t::mesh\_server\_state\_type\_t::ESP\_BLE\_MESH\_GE (C++ member), 538
- esp\_ble\_mesh\_server\_rcv\_tai\_utc\_delta\_desc\_t::mesh\_server\_state\_type\_t::ESP\_BLE\_MESH\_GE (C++ member), 538
- esp\_ble\_mesh\_server\_rcv\_time\_role\_set\_t (C++ struct), 538
- esp\_ble\_mesh\_server\_rcv\_time\_role\_set\_t::time\_role (C++ member), 538
- esp\_ble\_mesh\_server\_rcv\_time\_role\_set\_t::mesh\_server\_rcv\_time\_set\_t (C++ member), 537
- esp\_ble\_mesh\_server\_rcv\_time\_role\_set\_t::mesh\_server\_rcv\_time\_set\_t::subsecond (C++ member), 537
- esp\_ble\_mesh\_server\_rcv\_time\_role\_set\_t::mesh\_server\_rcv\_time\_set\_t::tai\_seconds (C++ member), 537
- esp\_ble\_mesh\_server\_rcv\_time\_role\_set\_t::mesh\_server\_rcv\_time\_set\_t::tai\_utc\_delta (C++ member), 537
- esp\_ble\_mesh\_server\_rcv\_time\_role\_set\_t::mesh\_server\_rcv\_time\_set\_t::time\_authority (C++ member), 537
- esp\_ble\_mesh\_server\_rcv\_time\_role\_set\_t::time\_zone\_of (C++ member), 538
- esp\_ble\_mesh\_server\_rcv\_time\_role\_set\_t::uncertainty (C++ member), 537
- esp\_ble\_mesh\_server\_rcv\_time\_status\_t (C++ struct), 540
- esp\_ble\_mesh\_server\_rcv\_time\_status\_t::subsecond (C++ member), 540
- esp\_ble\_mesh\_server\_rcv\_time\_status\_t::tai\_seconds (C++ member), 540
- esp\_ble\_mesh\_server\_rcv\_time\_status\_t::tai\_utc\_delta (C++ member), 540
- esp\_ble\_mesh\_server\_rcv\_time\_status\_t::time\_auth (C++ member), 540
- esp\_ble\_mesh\_server\_rcv\_time\_status\_t::time\_zone (C++ member), 540
- esp\_ble\_mesh\_server\_rcv\_time\_status\_t::uncertainty (C++ member), 540
- ESP\_BLE\_MESH\_SERVER\_PROP\_BY\_APP (C++ macro), 380
- esp\_ble\_mesh\_server\_rsp\_ctrl\_t (C++ struct), 354
- esp\_ble\_mesh\_server\_rsp\_ctrl\_t::get\_auto\_rsp (C++ member), 355
- esp\_ble\_mesh\_server\_rsp\_ctrl\_t::set\_auto\_rsp (C++ member), 355
- esp\_ble\_mesh\_server\_rsp\_ctrl\_t::status\_auto\_rsp (C++ member), 355
- esp\_data\_mesh\_server\_state\_type\_t (C++ enum), 391
- esp\_ble\_mesh\_server\_state\_type\_t::ESP\_BLE\_MESH\_GE (C++ enumerator), 392
- esp\_ble\_mesh\_server\_state\_type\_t::ESP\_BLE\_MESH\_GE (C++ enumerator), 391
- esp\_ble\_mesh\_server\_state\_type\_t::ESP\_BLE\_MESH\_GE (C++ enumerator), 392
- esp\_ble\_mesh\_server\_state\_type\_t::ESP\_BLE\_MESH\_GE (C++ enumerator), 392
- esp\_ble\_mesh\_server\_state\_type\_t::ESP\_BLE\_MESH\_GE (C++ enumerator), 392
- esp\_ble\_mesh\_server\_state\_type\_t::ESP\_BLE\_MESH\_GE (C++ enumerator), 392



- (C++ *enumerator*), 392
- `esp_ble_mesh_server_state_type_t::ESP_BLE_MESH_SERVER_TEMP_DELTA_UV_STATE` (C++ *member*), 340
- `esp_ble_mesh_server_state_type_t::ESP_BLE_MESH_SERVER_TEMP_DELTA_UV_STATE` (C++ *enumerator*), 392
- `esp_ble_mesh_server_state_type_t::ESP_BLE_MESH_SERVER_HUE_STATE` (C++ *member*), 339
- `esp_ble_mesh_server_state_type_t::ESP_BLE_MESH_SERVER_HUE_STATE` (C++ *enumerator*), 392
- `esp_ble_mesh_server_state_type_t::ESP_BLE_MESH_SERVER_LIGHTNESS_STATE` (C++ *member*), 340
- `esp_ble_mesh_server_state_type_t::ESP_BLE_MESH_SERVER_LIGHTNESS_STATE` (C++ *enumerator*), 392
- `esp_ble_mesh_server_state_type_t::ESP_BLE_MESH_SERVER_SATURATION_STATE` (C++ *member*), 340
- `esp_ble_mesh_server_state_type_t::ESP_BLE_MESH_SERVER_SATURATION_STATE` (C++ *enumerator*), 392
- `esp_ble_mesh_server_state_type_t::ESP_BLE_MESH_SERVER_STATE_value_t::temperature` (C++ *member*), 340
- `esp_ble_mesh_server_state_type_t::ESP_BLE_MESH_SERVER_STATE_value_t::temperature` (C++ *enumerator*), 392
- `esp_ble_mesh_server_state_type_t::ESP_BLE_MESH_SERVER_FLASH_PRODUCTION` (C++ *function*), 411
- `esp_ble_mesh_server_state_type_t::ESP_BLE_MESH_SERVER_FLASH_PRODUCTION` (C++ *enumerator*), 392
- `esp_ble_mesh_server_state_type_t::ESP_BLE_MESH_SERVER_FLASH_PRODUCTION` (C++ *function*), 411
- `esp_ble_mesh_server_state_type_t::ESP_BLE_MESH_SERVER_FLASH_PRODUCTION` (C++ *enumerator*), 392
- `esp_ble_mesh_server_state_type_t::ESP_BLE_MESH_SERVER_FLASH_PRODUCTION` (C++ *function*), 407
- `esp_ble_mesh_server_state_type_t::ESP_BLE_MESH_SERVER_FLASH_PRODUCTION` (C++ *enumerator*), 392
- `ESP_BLE_MESH_SERVER_FLASH_PRODUCTION` (C++ *macro*), 355
- `ESP_BLE_MESH_SERVER_FLASH_PRODUCTION` (C++ *macro*), 359
- `esp_ble_mesh_server_state_value_t` (C++ *union*), 339
- `esp_ble_mesh_server_state_value_t::delta_uv` (C++ *member*), 340
- `esp_ble_mesh_server_state_value_t::delta_uv` (C++ *enumerator*), 675
- `esp_ble_mesh_server_state_value_t::gen_level` (C++ *member*), 340
- `esp_ble_mesh_server_state_value_t::gen_level` (C++ *enumerator*), 675
- `esp_ble_mesh_server_state_value_t::gen_onoff` (C++ *member*), 339
- `esp_ble_mesh_server_state_value_t::gen_onoff` (C++ *enumerator*), 675
- `esp_ble_mesh_server_state_value_t::gen_onpower` (C++ *member*), 340
- `esp_ble_mesh_server_state_value_t::gen_onpower` (C++ *enumerator*), 675
- `esp_ble_mesh_server_state_value_t::gen_power` (C++ *member*), 340
- `esp_ble_mesh_server_state_value_t::gen_power` (C++ *enumerator*), 675
- `esp_ble_mesh_server_state_value_t::hue` (C++ *member*), 340
- `esp_ble_mesh_server_state_value_t::hue` (C++ *struct*), 673
- `esp_ble_mesh_server_state_value_t::level` (C++ *member*), 673
- `esp_ble_mesh_server_state_value_t::level` (C++ *member*), 339
- `esp_ble_mesh_server_state_value_t::light_ctl` (C++ *member*), 673
- `esp_ble_mesh_server_state_value_t::light_ctl` (C++ *member*), 340
- `esp_ble_mesh_server_state_value_t::light_ctl` (C++ *member*), 673
- `esp_ble_mesh_server_state_value_t::light_ctl` (C++ *member*), 340
- `esp_ble_mesh_server_state_value_t::light_hsl` (C++ *member*), 674
- `esp_ble_mesh_server_state_value_t::light_hsl` (C++ *member*), 340
- `esp_ble_mesh_server_state_value_t::light_hsl` (C++ *type*), 675
- `esp_ble_mesh_server_state_value_t::light_hsl` (C++ *member*), 341
- `esp_ble_mesh_server_state_value_t::light_hsl` (C++ *union*), 673
- `esp_ble_mesh_server_state_value_t::light_hsl` (C++ *member*), 341
- `esp_ble_mesh_server_state_value_t::light_hsl` (C++ *member*), 672
- `esp_ble_mesh_server_state_value_t::light_hsl` (C++ *member*), 341
- `esp_ble_mesh_server_state_value_t::light_lc_l1` (C++ *union*), 672
- `esp_ble_mesh_server_state_value_t::light_lc_l1` (C++ *member*), 341
- `esp_ble_mesh_server_state_value_t::light_light` (C++ *member*), 672
- `esp_ble_mesh_server_state_value_t::light_light` (C++ *member*), 340
- `esp_ble_mesh_server_state_value_t::light_light` (C++ *member*), 672
- `esp_ble_mesh_server_state_value_t::light_light` (C++ *member*), 340
- `esp_ble_mesh_server_state_value_t::light_xyl` (C++ *struct*), 673
- `esp_ble_mesh_server_state_value_t::light_xyl` (C++ *member*), 341
- `esp_ble_mesh_server_state_value_t::lightness` (C++ *member*), 673





(C++ struct), 482  
 esp\_ble\_mesh\_state\_change\_gen\_onoff\_set\_t (C++ member), 482  
 esp\_ble\_mesh\_state\_change\_gen\_onpowerup\_set\_t (C++ struct), 483  
 esp\_ble\_mesh\_state\_change\_gen\_onpowerup\_set\_t::hue (C++ member), 483  
 esp\_ble\_mesh\_state\_change\_gen\_power\_default\_set\_t (C++ struct), 483  
 esp\_ble\_mesh\_state\_change\_gen\_power\_default\_set\_t::hue (C++ member), 484  
 esp\_ble\_mesh\_state\_change\_gen\_power\_level\_set\_t (C++ struct), 483  
 esp\_ble\_mesh\_state\_change\_gen\_power\_level\_set\_t::hue (C++ member), 483  
 esp\_ble\_mesh\_state\_change\_gen\_power\_range\_set\_t (C++ struct), 484  
 esp\_ble\_mesh\_state\_change\_gen\_power\_range\_set\_t::hue (C++ member), 484  
 esp\_ble\_mesh\_state\_change\_gen\_power\_range\_set\_t::max (C++ struct), 484  
 esp\_ble\_mesh\_state\_change\_gen\_power\_range\_set\_t::min (C++ member), 484  
 esp\_ble\_mesh\_state\_change\_gen\_user\_property\_set\_t (C++ struct), 485  
 esp\_ble\_mesh\_state\_change\_gen\_user\_property\_set\_t::hue (C++ member), 485  
 esp\_ble\_mesh\_state\_change\_gen\_user\_property\_set\_t::sat (C++ member), 485  
 esp\_ble\_mesh\_state\_change\_light\_ctl\_default\_set\_t (C++ struct), 584  
 esp\_ble\_mesh\_state\_change\_light\_ctl\_default\_set\_t::saturation (C++ member), 585  
 esp\_ble\_mesh\_state\_change\_light\_ctl\_default\_set\_t::lightness (C++ struct), 587  
 esp\_ble\_mesh\_state\_change\_light\_ctl\_default\_set\_t::stratagem (C++ member), 585  
 esp\_ble\_mesh\_state\_change\_light\_ctl\_set\_t (C++ struct), 584  
 esp\_ble\_mesh\_state\_change\_light\_ctl\_set\_t::mode (C++ member), 584  
 esp\_ble\_mesh\_state\_change\_light\_ctl\_set\_t::brightness (C++ struct), 587  
 esp\_ble\_mesh\_state\_change\_light\_ctl\_set\_t::temp (C++ member), 584  
 esp\_ble\_mesh\_state\_change\_light\_ctl\_set\_t::temp (C++ member), 587  
 esp\_ble\_mesh\_state\_change\_light\_ctl\_temperature\_set\_t (C++ struct), 584  
 esp\_ble\_mesh\_state\_change\_light\_ctl\_temperature\_set\_t::max (C++ member), 588  
 esp\_ble\_mesh\_state\_change\_light\_ctl\_temperature\_set\_t::min (C++ member), 588  
 esp\_ble\_mesh\_state\_change\_light\_ctl\_temperature\_set\_t (C++ struct), 584  
 esp\_ble\_mesh\_state\_change\_light\_ctl\_temperature\_set\_t::hue (C++ member), 584  
 esp\_ble\_mesh\_state\_change\_light\_hsl\_default\_set\_t (C++ struct), 585  
 esp\_ble\_mesh\_state\_change\_light\_hsl\_default\_set\_t::hue (C++ member), 583

(C++ struct), 583  
 esp\_ble\_mesh\_state\_change\_light\_lightness esp\_ble\_mesh\_state\_change\_scene\_recall\_t::scene\_n  
 (C++ member), 584 (C++ member), 536  
 esp\_ble\_mesh\_state\_change\_light\_lightness esp\_ble\_mesh\_state\_change\_scene\_store\_t  
 (C++ member), 584 (C++ struct), 536  
 esp\_ble\_mesh\_state\_change\_light\_lightness esp\_ble\_mesh\_state\_change\_scene\_store\_t::scene\_nu  
 (C++ struct), 583 (C++ member), 536  
 esp\_ble\_mesh\_state\_change\_light\_lightness esp\_ble\_mesh\_state\_change\_scheduler\_act\_set\_t  
 (C++ member), 583 (C++ struct), 536  
 esp\_ble\_mesh\_state\_change\_light\_xyl\_def esp\_ble\_mesh\_state\_change\_scheduler\_act\_set\_t::ac  
 (C++ struct), 586 (C++ member), 537  
 esp\_ble\_mesh\_state\_change\_light\_xyl\_def esp\_ble\_mesh\_state\_change\_scheduler\_act\_set\_t::da  
 (C++ member), 587 (C++ member), 536  
 esp\_ble\_mesh\_state\_change\_light\_xyl\_def esp\_ble\_mesh\_state\_change\_scheduler\_act\_set\_t::da  
 (C++ member), 587 (C++ member), 537  
 esp\_ble\_mesh\_state\_change\_light\_xyl\_def esp\_ble\_mesh\_state\_change\_scheduler\_act\_set\_t::ho  
 (C++ member), 587 (C++ member), 536  
 esp\_ble\_mesh\_state\_change\_light\_xyl\_range esp\_ble\_mesh\_state\_change\_scheduler\_act\_set\_t::in  
 (C++ struct), 587 (C++ member), 536  
 esp\_ble\_mesh\_state\_change\_light\_xyl\_range esp\_ble\_mesh\_state\_change\_scheduler\_act\_set\_t::mi  
 (C++ member), 587 (C++ member), 537  
 esp\_ble\_mesh\_state\_change\_light\_xyl\_range esp\_ble\_mesh\_state\_change\_scheduler\_act\_set\_t::mo  
 (C++ member), 587 (C++ member), 536  
 esp\_ble\_mesh\_state\_change\_light\_xyl\_range esp\_ble\_mesh\_state\_change\_scheduler\_act\_set\_t::sc  
 (C++ member), 587 (C++ member), 537  
 esp\_ble\_mesh\_state\_change\_light\_xyl\_range esp\_ble\_mesh\_state\_change\_scheduler\_act\_set\_t::se  
 (C++ member), 587 (C++ member), 537  
 esp\_ble\_mesh\_state\_change\_light\_xyl\_set esp\_ble\_mesh\_state\_change\_scheduler\_act\_set\_t::tr  
 (C++ struct), 586 (C++ member), 537  
 esp\_ble\_mesh\_state\_change\_light\_xyl\_set esp\_ble\_mesh\_state\_change\_scheduler\_act\_set\_t::ye  
 (C++ member), 586 (C++ member), 536  
 esp\_ble\_mesh\_state\_change\_light\_xyl\_set esp\_ble\_mesh\_state\_change\_sensor\_cadence\_set\_t  
 (C++ member), 586 (C++ struct), 509  
 esp\_ble\_mesh\_state\_change\_light\_xyl\_set esp\_ble\_mesh\_state\_change\_sensor\_cadence\_set\_t::f  
 (C++ member), 586 (C++ member), 510  
 esp\_ble\_mesh\_state\_change\_priv\_beacon esp\_ble\_mesh\_state\_change\_sensor\_cadence\_set\_t::f  
 (C++ struct), 658 (C++ member), 510  
 esp\_ble\_mesh\_state\_change\_priv\_beacon esp\_ble\_mesh\_state\_change\_sensor\_cadence\_set\_t::m  
 (C++ member), 658 (C++ member), 510  
 esp\_ble\_mesh\_state\_change\_priv\_beacon esp\_ble\_mesh\_state\_change\_sensor\_cadence\_set\_t::p  
 (C++ member), 658 (C++ member), 510  
 esp\_ble\_mesh\_state\_change\_priv\_beacon esp\_ble\_mesh\_state\_change\_sensor\_cadence\_set\_t::p  
 (C++ member), 658 (C++ member), 510  
 esp\_ble\_mesh\_state\_change\_priv\_gatt\_prop esp\_ble\_mesh\_state\_change\_sensor\_cadence\_set\_t::t  
 (C++ struct), 658 (C++ member), 510  
 esp\_ble\_mesh\_state\_change\_priv\_gatt\_prop esp\_ble\_mesh\_state\_change\_sensor\_cadence\_set\_t::t  
 (C++ member), 658 (C++ member), 510  
 esp\_ble\_mesh\_state\_change\_priv\_node\_id esp\_ble\_mesh\_state\_change\_sensor\_cadence\_set\_t::t  
 (C++ struct), 658 (C++ member), 510  
 esp\_ble\_mesh\_state\_change\_priv\_node\_id esp\_ble\_mesh\_state\_change\_sensor\_setting\_set\_t  
 (C++ member), 659 (C++ struct), 510  
 esp\_ble\_mesh\_state\_change\_priv\_node\_id esp\_ble\_mesh\_state\_change\_sensor\_setting\_set\_t::p  
 (C++ member), 659 (C++ member), 510  
 esp\_ble\_mesh\_state\_change\_scene\_delete esp\_ble\_mesh\_state\_change\_sensor\_setting\_set\_t::s  
 (C++ struct), 536 (C++ member), 510  
 esp\_ble\_mesh\_state\_change\_scene\_delete esp\_ble\_mesh\_state\_change\_sensor\_setting\_set\_t::s  
 (C++ member), 536 (C++ member), 510  
 esp\_ble\_mesh\_state\_change\_scene\_recall esp\_ble\_mesh\_state\_change\_sensor\_status\_t



(C++ struct), 588  
 esp\_ble\_mesh\_state\_change\_sensor\_status\_t::ble\_mesh\_state\_transition\_t::counter  
 (C++ member), 588 (C++ member), 354  
 esp\_ble\_mesh\_state\_change\_sensor\_status\_t::ble\_mesh\_state\_transition\_t::delay  
 (C++ member), 588 (C++ member), 354  
 esp\_ble\_mesh\_state\_change\_sensor\_status\_t::ble\_mesh\_state\_transition\_t::just\_started  
 (C++ member), 588 (C++ member), 354  
 esp\_ble\_mesh\_state\_change\_sensor\_status\_t::ble\_mesh\_state\_transition\_t::quot\_t  
 (C++ member), 588 (C++ member), 354  
 esp\_ble\_mesh\_state\_change\_sensor\_status\_t::ble\_mesh\_state\_transition\_t::remain\_time  
 (C++ member), 588 (C++ member), 354  
 esp\_ble\_mesh\_state\_change\_tai\_utc\_delta\_set\_t::ble\_mesh\_state\_transition\_t::start\_timestamp  
 (C++ struct), 535 (C++ member), 354  
 esp\_ble\_mesh\_state\_change\_tai\_utc\_delta\_set\_t::ble\_mesh\_state\_transition\_t::timer  
 (C++ member), 535 (C++ member), 354  
 esp\_ble\_mesh\_state\_change\_tai\_utc\_delta\_set\_t::ble\_mesh\_state\_transition\_t::total\_duration  
 (C++ member), 535 (C++ member), 354  
 esp\_ble\_mesh\_state\_change\_time\_role\_set\_t::ble\_mesh\_state\_transition\_t::trans\_time  
 (C++ struct), 535 (C++ member), 354  
 esp\_ble\_mesh\_state\_change\_time\_role\_set\_t::ESP\_BLE\_MESH\_SUBNET\_BRIDGE\_DISABLED (C  
 (C++ member), 536 macro), 357  
 esp\_ble\_mesh\_state\_change\_time\_set\_t ESP\_BLE\_MESH\_SUBNET\_BRIDGE\_ENABLED (C  
 (C++ struct), 534 macro), 358  
 esp\_ble\_mesh\_state\_change\_time\_set\_t::subnet\_mesh\_subnet\_bridge\_set\_t (C++  
 (C++ member), 534 struct), 646  
 esp\_ble\_mesh\_state\_change\_time\_set\_t::esp\_ble\_mesh\_subnet\_bridge\_set\_t::subnet\_bridge  
 (C++ member), 534 (C++ member), 646  
 esp\_ble\_mesh\_state\_change\_time\_set\_t::esp\_ble\_mesh\_subnet\_bridge\_status\_t  
 (C++ member), 534 (C++ struct), 648  
 esp\_ble\_mesh\_state\_change\_time\_set\_t::esp\_ble\_mesh\_subnet\_bridge\_status\_t::subnet\_bridge  
 (C++ member), 534 (C++ member), 648  
 esp\_ble\_mesh\_state\_change\_time\_set\_t::esp\_ble\_mesh\_subnet\_bridge\_table\_t  
 (C++ member), 534 (C++ struct), 646  
 esp\_ble\_mesh\_state\_change\_time\_set\_t::esp\_ble\_mesh\_subnet\_bridge\_table\_t::bridge\_addr\_1  
 (C++ member), 534 (C++ member), 646  
 esp\_ble\_mesh\_state\_change\_time\_status\_t::esp\_ble\_mesh\_subnet\_bridge\_table\_t::bridge\_addr\_2  
 (C++ struct), 534 (C++ member), 646  
 esp\_ble\_mesh\_state\_change\_time\_status\_t::esp\_ble\_mesh\_subnet\_bridge\_table\_t::bridge\_direct  
 (C++ member), 535 (C++ member), 646  
 esp\_ble\_mesh\_state\_change\_time\_status\_t::esp\_ble\_mesh\_subnet\_bridge\_table\_t::bridge\_net\_id  
 (C++ member), 535 (C++ member), 646  
 esp\_ble\_mesh\_state\_change\_time\_status\_t::ESP\_BLE\_MESH\_SUPPLY\_VOLTAGE\_TOO\_HIGH\_ERROR  
 (C++ member), 535 (C macro), 454  
 esp\_ble\_mesh\_state\_change\_time\_status\_t::ESP\_BLE\_MESH\_SUPPLY\_VOLTAGE\_TOO\_HIGH\_WARNING  
 (C++ member), 535 (C macro), 454  
 esp\_ble\_mesh\_state\_change\_time\_status\_t::ESP\_BLE\_MESH\_SUPPLY\_VOLTAGE\_TOO\_LOW\_ERROR  
 (C++ member), 535 (C macro), 454  
 esp\_ble\_mesh\_state\_change\_time\_status\_t::ESP\_BLE\_MESH\_SUPPLY\_VOLTAGE\_TOO\_LOW\_WARNING  
 (C++ member), 535 (C macro), 454  
 esp\_ble\_mesh\_state\_change\_time\_zone\_set\_t::ESP\_BLE\_MESH\_TAG\_FRIENDSHIP (C macro),  
 (C++ struct), 535 361  
 esp\_ble\_mesh\_state\_change\_time\_zone\_set\_t::ESP\_BLE\_MESH\_TAG\_FRIEND\_MUTABLE\_CRED (C  
 (C++ member), 535 macro), 361  
 esp\_ble\_mesh\_state\_change\_time\_zone\_set\_t::ESP\_BLE\_MESH\_TAG\_RELAY (C macro), 361  
 (C++ member), 535 ESP\_BLE\_MESH\_TAG\_SEND\_SEGMENTED (C  
 (C++ member), 535 macro), 361  
 esp\_ble\_mesh\_state\_transition\_t (C++ struct), 353 ESP\_BLE\_MESH\_TAG\_USE\_DIRECTED (C macro),  
 (C++ member), 353 361  
 esp\_ble\_mesh\_state\_transition\_t::BLE\_MESH\_ATOM\_DEFINE



esp\_ble\_mesh\_time\_scene\_server\_cb\_event\_sta : BLE\_MESH\_TIME\_SCENE\_SERVER\_EVENT\_RECHARGE\_MSG\_T  
 (C++ enumerator), 546 (C++ member), 521  
 esp\_ble\_mesh\_time\_scene\_server\_cb\_event\_sta : BLE\_MESH\_TIME\_SCENE\_SERVER\_EVENT\_RECHARGE\_MSG\_T  
 (C++ enumerator), 546 (C++ member), 521  
 esp\_ble\_mesh\_time\_scene\_server\_cb\_event\_sta : BLE\_MESH\_TIME\_SCENE\_SERVER\_EVENT\_RECHARGE\_STATUS\_MSG\_T  
 (C++ enumerator), 546 (C++ member), 521  
 esp\_ble\_mesh\_time\_scene\_server\_cb\_event\_sta : BLE\_MESH\_TIME\_SCENE\_SERVER\_EVENT\_STATUS\_CHANGE\_MSG\_T  
 (C++ enumerator), 546 (C++ member), 521  
 esp\_ble\_mesh\_time\_scene\_server\_cb\_param\_t esp\_ble\_mesh\_time\_scene\_server\_state\_change\_t::time  
 (C++ struct), 540 (C++ member), 521  
 esp\_ble\_mesh\_time\_scene\_server\_cb\_param\_t esp\_ble\_mesh\_time\_scene\_server\_state\_change\_t::time  
 (C++ member), 541 (C++ member), 520  
 esp\_ble\_mesh\_time\_scene\_server\_cb\_param\_t esp\_ble\_mesh\_time\_scene\_server\_state\_change\_t::time  
 (C++ member), 541 (C++ member), 521  
 esp\_ble\_mesh\_time\_scene\_server\_cb\_param\_t esp\_ble\_mesh\_time\_scene\_server\_state\_change\_t::time  
 (C++ member), 541 (C++ member), 521  
 esp\_ble\_mesh\_time\_scene\_server\_cb\_t esp\_ble\_mesh\_time\_set\_t (C++ struct), 522  
 (C++ type), 545 esp\_ble\_mesh\_time\_set\_t::sub\_second  
 (C++ member), 523  
 esp\_ble\_mesh\_time\_scene\_server\_cb\_value\_t (C++ union), 522 esp\_ble\_mesh\_time\_set\_t::tai\_seconds  
 (C++ member), 523  
 esp\_ble\_mesh\_time\_scene\_server\_cb\_value\_t::get (C++ member), 523  
 (C++ member), 522 esp\_ble\_mesh\_time\_set\_t::tai\_utc\_delta  
 (C++ member), 523  
 esp\_ble\_mesh\_time\_scene\_server\_cb\_value\_t::set (C++ member), 523  
 (C++ member), 522 esp\_ble\_mesh\_time\_set\_t::time\_authority  
 (C++ member), 522 (C++ member), 523  
 esp\_ble\_mesh\_time\_scene\_server\_cb\_value\_t::state\_change (C++ member), 523  
 (C++ member), 522 esp\_ble\_mesh\_time\_set\_t::time\_zone\_offset  
 (C++ member), 522 (C++ member), 523  
 esp\_ble\_mesh\_time\_scene\_server\_cb\_value\_t::state (C++ member), 523  
 (C++ member), 522 esp\_ble\_mesh\_time\_set\_t::uncertainty  
 (C++ member), 522  
 esp\_ble\_mesh\_time\_scene\_server\_rcv\_get\_msg\_t (C++ member), 523  
 (C++ union), 521 esp\_ble\_mesh\_time\_setup\_srv\_t (C++  
 esp\_ble\_mesh\_time\_scene\_server\_rcv\_get\_msg\_t struct), 530 member), 530  
 (C++ member), 521 esp\_ble\_mesh\_time\_setup\_srv\_t::model  
 esp\_ble\_mesh\_time\_scene\_server\_rcv\_set\_msg\_t (C++ member), 530  
 (C++ union), 521 esp\_ble\_mesh\_time\_setup\_srv\_t::rsp\_ctrl  
 (C++ member), 522 (C++ member), 530  
 esp\_ble\_mesh\_time\_scene\_server\_rcv\_set\_msg\_t (C++ member), 530  
 (C++ member), 522 esp\_ble\_mesh\_time\_setup\_srv\_t::state  
 (C++ member), 522 (C++ member), 530  
 esp\_ble\_mesh\_time\_scene\_server\_rcv\_set\_msg\_t (C++ member), 530  
 (C++ member), 522 esp\_ble\_mesh\_time\_srv\_t (C++ struct), 530  
 esp\_ble\_mesh\_time\_scene\_server\_rcv\_set\_msg\_t (C++ member), 530  
 (C++ member), 522 esp\_ble\_mesh\_time\_srv\_t::model (C++  
 member), 530  
 esp\_ble\_mesh\_time\_scene\_server\_rcv\_set\_msg\_t (C++ member), 530  
 (C++ member), 522 esp\_ble\_mesh\_time\_srv\_t::rsp\_ctrl  
 (C++ member), 530  
 esp\_ble\_mesh\_time\_scene\_server\_rcv\_set\_msg\_t (C++ member), 530  
 (C++ member), 522 esp\_ble\_mesh\_time\_state\_t::state (C++  
 member), 530  
 esp\_ble\_mesh\_time\_scene\_server\_rcv\_set\_msg\_t (C++ member), 529  
 (C++ member), 521 esp\_ble\_mesh\_time\_state\_t (C++ struct), 529  
 (C++ member), 521 esp\_ble\_mesh\_time\_state\_t::subsecond  
 (C++ member), 522 (C++ member), 529  
 esp\_ble\_mesh\_time\_scene\_server\_rcv\_set\_msg\_t (C++ member), 529  
 (C++ member), 522 esp\_ble\_mesh\_time\_state\_t::tai\_delta\_change  
 (C++ member), 521 (C++ member), 530  
 esp\_ble\_mesh\_time\_scene\_server\_rcv\_set\_msg\_t (C++ member), 530  
 (C++ member), 521 esp\_ble\_mesh\_time\_state\_t::tai\_seconds  
 (C++ member), 529 (C++ member), 529  
 esp\_ble\_mesh\_time\_scene\_server\_rcv\_status\_msg\_t (C++ member), 529  
 (C++ union), 522 esp\_ble\_mesh\_time\_state\_t::tai\_utc\_delta\_curr  
 (C++ member), 522 (C++ member), 529  
 esp\_ble\_mesh\_time\_scene\_server\_rcv\_status\_msg\_t (C++ member), 529  
 (C++ member), 522 esp\_ble\_mesh\_time\_state\_t::tai\_utc\_delta\_new  
 (C++ member), 522 (C++ member), 529  
 esp\_ble\_mesh\_time\_scene\_server\_state\_change\_t (C++ member), 529  
 (C++ union), 520 esp\_ble\_mesh\_time\_state\_t::tai\_zone\_change  
 (C++ member), 521 (C++ member), 529  
 esp\_ble\_mesh\_time\_scene\_server\_state\_change\_t (C++ member), 529  
 (C++ member), 521 esp\_ble\_mesh\_time\_state\_t::time (C++



- member), 530  
 esp\_ble\_mesh\_time\_state\_t::time\_authority (C++ member), 635  
 (C++ member), 529  
 esp\_ble\_mesh\_time\_state\_t::time\_role (C++ member), 530  
 esp\_ble\_mesh\_time\_state\_t::time\_zone\_offset (C++ member), 529  
 (C++ member), 529  
 esp\_ble\_mesh\_time\_state\_t::time\_zone\_offset\_new (C++ member), 529  
 (C++ member), 529  
 esp\_ble\_mesh\_time\_state\_t::uncertainty (C++ member), 529  
 esp\_ble\_mesh\_time\_status\_cb\_t (C++ struct), 525  
 esp\_ble\_mesh\_time\_status\_cb\_t::sub\_seconds (C++ member), 526  
 esp\_ble\_mesh\_time\_status\_cb\_t::tai\_seconds (C++ member), 526  
 esp\_ble\_mesh\_time\_status\_cb\_t::tai\_utc\_delta (C++ member), 526  
 esp\_ble\_mesh\_time\_status\_cb\_t::time\_authority (C++ member), 526  
 esp\_ble\_mesh\_time\_status\_cb\_t::time\_zone\_offset (C++ member), 526  
 (C++ member), 526  
 esp\_ble\_mesh\_time\_status\_cb\_t::uncertainty (C++ member), 526  
 esp\_ble\_mesh\_time\_zone\_set\_t (C++ struct), 523  
 esp\_ble\_mesh\_time\_zone\_set\_t::tai\_zone (C++ member), 523  
 esp\_ble\_mesh\_time\_zone\_set\_t::time\_zone\_offset (C++ member), 523  
 (C++ member), 523  
 esp\_ble\_mesh\_time\_zone\_status\_cb\_t (C++ struct), 526  
 esp\_ble\_mesh\_time\_zone\_status\_cb\_t::tai\_zone (C++ member), 526  
 (C++ member), 526  
 esp\_ble\_mesh\_time\_zone\_status\_cb\_t::time\_zone (C++ member), 526  
 (C++ member), 526  
 esp\_ble\_mesh\_time\_zone\_status\_cb\_t::time\_zone\_offset\_new (C++ member), 526  
 (C++ member), 526  
 ESP\_BLE\_MESH\_TRANSMIT (C macro), 358  
 ESP\_BLE\_MESH\_TTL\_DEFAULT (C macro), 356  
 ESP\_BLE\_MESH\_TTL\_MAX (C macro), 356  
 esp\_ble\_mesh\_two\_way\_path\_get\_t (C++ struct), 626  
 esp\_ble\_mesh\_two\_way\_path\_get\_t::net\_idx (C++ member), 627  
 esp\_ble\_mesh\_two\_way\_path\_set\_t (C++ struct), 627  
 esp\_ble\_mesh\_two\_way\_path\_set\_t::net\_idx (C++ member), 627  
 esp\_ble\_mesh\_two\_way\_path\_set\_t::two\_way\_path (C++ member), 627  
 esp\_ble\_mesh\_two\_way\_path\_status\_t (C++ struct), 635  
 esp\_ble\_mesh\_two\_way\_path\_status\_t::net\_idx (C++ member), 635  
 esp\_ble\_mesh\_two\_way\_path\_status\_t::status (C++ member), 635  
 esp\_ble\_mesh\_two\_way\_path\_status\_t::two\_way\_path\_status\_t::two\_way\_path (C++ member), 635  
 esp\_ble\_mesh\_uar\_t (C++ struct), 344  
 esp\_ble\_mesh\_uar\_t::len\_present (C++ member), 344  
 esp\_ble\_mesh\_uar\_t::range\_length (C++ member), 344  
 esp\_ble\_mesh\_uar\_t::range\_start (C++ member), 344  
 ESP\_BLE\_MESH\_UNKNOWN\_TAI\_DELTA\_CHANGE (C macro), 543  
 ESP\_BLE\_MESH\_UNKNOWN\_TAI\_SECONDS (C macro), 543  
 ESP\_BLE\_MESH\_UNKNOWN\_TAI\_ZONE\_CHANGE (C macro), 543  
 esp\_ble\_mesh\_unprov\_dev\_add\_t (C++ struct), 349  
 esp\_ble\_mesh\_unprov\_dev\_add\_t::addr (C++ member), 349  
 esp\_ble\_mesh\_unprov\_dev\_add\_t::addr\_type (C++ member), 349  
 esp\_ble\_mesh\_unprov\_dev\_add\_t::bearer (C++ member), 349  
 esp\_ble\_mesh\_unprov\_dev\_add\_t::oob\_info (C++ member), 349  
 esp\_ble\_mesh\_unprov\_dev\_add\_t::uuid (C++ member), 349  
 ESP\_BLE\_MESH\_VENDOR\_MODEL (C macro), 359  
 ESP\_BLE\_MESH\_VIBRATION\_ERROR (C macro), 455  
 ESP\_BLE\_MESH\_VIBRATION\_WARNING (C macro), 455  
 esp\_ble\_mesh\_wanted\_lanes\_get\_t (C++ struct), 626  
 esp\_ble\_mesh\_wanted\_lanes\_get\_t::net\_idx (C++ member), 626  
 esp\_ble\_mesh\_wanted\_lanes\_set\_t (C++ struct), 626  
 esp\_ble\_mesh\_wanted\_lanes\_set\_t::net\_idx (C++ member), 626  
 esp\_ble\_mesh\_wanted\_lanes\_set\_t::wanted\_lanes (C++ member), 626  
 esp\_ble\_mesh\_wanted\_lanes\_status\_t (C++ struct), 634  
 esp\_ble\_mesh\_wanted\_lanes\_status\_t::net\_idx (C++ member), 635  
 esp\_ble\_mesh\_wanted\_lanes\_status\_t::status (C++ member), 634  
 esp\_ble\_mesh\_wanted\_lanes\_status\_t::wanted\_lanes (C++ member), 635  
 ESP\_BLE\_MESH\_ONLY\_ACCEPT\_SPECIFIED\_AUTH\_DISABLE (C macro), 221  
 ESP\_BLE\_MESH\_ONLY\_ACCEPT\_SPECIFIED\_AUTH\_ENABLE (C macro), 221  
 ESP\_BLE\_MESH\_OOB\_DISABLE (C macro), 221  
 ESP\_BLE\_MESH\_OOB\_ENABLE (C macro), 221  
 esp\_ble\_oob\_req\_reply (C++ function), 175  
 esp\_ble\_passkey\_reply (C++ function), 175



- esp\_ble\_sec\_key\_notif\_t::bd\_addr (C++ member), 210  
 esp\_ble\_sec\_key\_notif\_t::passkey (C++ member), 210  
 esp\_ble\_sec\_req\_t (C++ struct), 210  
 esp\_ble\_sec\_req\_t::bd\_addr (C++ member), 210  
 esp\_ble\_sec\_t (C++ union), 183  
 esp\_ble\_sec\_t::auth\_cmpl (C++ member), 183  
 esp\_ble\_sec\_t::ble\_id\_keys (C++ member), 183  
 esp\_ble\_sec\_t::ble\_key (C++ member), 183  
 esp\_ble\_sec\_t::ble\_req (C++ member), 183  
 esp\_ble\_sec\_t::key\_notif (C++ member), 183  
 esp\_ble\_sec\_t::oob\_data (C++ member), 183  
 esp\_ble\_set\_encryption (C++ function), 174  
 esp\_ble\_sm\_param\_t (C++ enum), 238  
 esp\_ble\_sm\_param\_t::ESP\_BLE\_APP\_ENC\_KEY\_SET (C++ enumerator), 239  
 esp\_ble\_sm\_param\_t::ESP\_BLE\_SM\_AUTHEN\_REQ\_MODE (C++ enumerator), 238  
 esp\_ble\_sm\_param\_t::ESP\_BLE\_SM\_CLEAR\_STATIC\_PKEY (C++ enumerator), 239  
 esp\_ble\_sm\_param\_t::ESP\_BLE\_SM\_IOCAP\_MODE (C++ enumerator), 238  
 esp\_ble\_sm\_param\_t::ESP\_BLE\_SM\_MAX\_KEY\_SIZE (C++ enumerator), 238  
 esp\_ble\_sm\_param\_t::ESP\_BLE\_SM\_MAX\_PARAM (C++ enumerator), 239  
 esp\_ble\_sm\_param\_t::ESP\_BLE\_SM\_MIN\_KEY\_SIZE (C++ enumerator), 238  
 esp\_ble\_sm\_param\_t::ESP\_BLE\_SM\_ONLY\_ACCEPT\_SPECIFIC\_SEC\_AUTH (C++ enumerator), 239  
 esp\_ble\_sm\_param\_t::ESP\_BLE\_SM\_OOB\_SUPPORT (C++ enumerator), 239  
 esp\_ble\_sm\_param\_t::ESP\_BLE\_SM\_PASSKEY (C++ enumerator), 238  
 esp\_ble\_sm\_param\_t::ESP\_BLE\_SM\_SET\_INIT\_KEY (C++ enumerator), 238  
 esp\_ble\_sm\_param\_t::ESP\_BLE\_SM\_SET\_RSP\_KEY (C++ enumerator), 238  
 esp\_ble\_sm\_param\_t::ESP\_BLE\_SM\_SET\_STATIC\_PASSKEY (C++ enumerator), 239  
 esp\_ble\_tx\_power\_get (C++ function), 299  
 esp\_ble\_tx\_power\_get\_enhanced (C++ function), 299  
 esp\_ble\_tx\_power\_set (C++ function), 299  
 esp\_ble\_tx\_power\_set\_enhanced (C++ function), 299  
 esp\_ble\_vendor\_cmd\_params\_t (C++ struct), 204  
 esp\_ble\_vendor\_cmd\_params\_t::opcode (C++ member), 204  
 esp\_ble\_vendor\_cmd\_params\_t::p\_param\_buf (C++ member), 204  
 esp\_ble\_vendor\_cmd\_params\_t::param\_len (C++ member), 204  
 esp\_ble\_wl\_addr\_type\_t (C++ enum), 163  
 esp\_ble\_wl\_addr\_type\_t::BLE\_WL\_ADDR\_TYPE\_PUBLIC (C++ enumerator), 163  
 esp\_ble\_wl\_addr\_type\_t::BLE\_WL\_ADDR\_TYPE\_RANDOM (C++ enumerator), 163  
 esp\_ble\_wl\_operation\_t (C++ enum), 243  
 esp\_ble\_wl\_operation\_t::ESP\_BLE\_WHITELIST\_ADD (C++ enumerator), 243  
 esp\_ble\_wl\_operation\_t::ESP\_BLE\_WHITELIST\_CLEAR (C++ enumerator), 243  
 esp\_ble\_wl\_operation\_t::ESP\_BLE\_WHITELIST\_REMOVE (C++ enumerator), 243  
 esp\_bluedroid\_config\_t (C++ struct), 165  
 esp\_bluedroid\_config\_t::ssp\_en (C++ member), 165  
 esp\_bluedroid\_deinit (C++ function), 164  
 esp\_bluedroid\_disable (C++ function), 164  
 esp\_bluedroid\_enable (C++ function), 164  
 esp\_bluedroid\_get\_status (C++ function), 164  
 esp\_bluedroid\_init (C++ function), 164  
 esp\_bluedroid\_init\_with\_cfg (C++ function), 164  
 ESP\_BLUEDROID\_STATUS\_CHECK (C macro), 157  
 esp\_bluedroid\_status\_t (C++ enum), 165  
 esp\_bluedroid\_status\_t::ESP\_BLUEDROID\_STATUS\_ENABLED (C++ enumerator), 165  
 esp\_bluedroid\_status\_t::ESP\_BLUEDROID\_STATUS\_INIT (C++ enumerator), 165  
 esp\_bluedroid\_status\_t::ESP\_BLUEDROID\_STATUS\_UNINITIALIZED (C++ enumerator), 165  
 ESP\_BOOTLOADER\_DESC\_MAGIC\_BYTE (C macro), 1706  
 esp\_bootloader\_desc\_t (C++ struct), 1706  
 esp\_bootloader\_desc\_t::date\_time (C++ member), 1706  
 esp\_bootloader\_desc\_t::idf\_ver (C++ member), 1706  
 esp\_bootloader\_desc\_t::magic\_byte (C++ member), 1706  
 esp\_bootloader\_desc\_t::reserved (C++ member), 1706  
 esp\_bootloader\_desc\_t::reserved2 (C++ member), 1706  
 esp\_bootloader\_desc\_t::version (C++ member), 1706  
 esp\_bootloader\_get\_description (C++ function), 1706  
 esp\_bt\_config\_file\_path\_update (C++ function), 166  
 esp\_bt\_controller\_config\_t (C++ struct), 301  
 esp\_bt\_controller\_config\_t::ble\_acl\_buf\_count (C++ member), 303  
 esp\_bt\_controller\_config\_t::ble\_acl\_buf\_size (C++ member), 303  
 esp\_bt\_controller\_config\_t::ble\_ext\_adv\_max\_size (C++ member), 303

(C++ member), 303  
 esp\_bt\_controller\_config\_t::ble\_hci\_evt\_size (C++ member), 303  
 esp\_bt\_controller\_config\_t::ble\_hci\_evt\_size (C++ member), 303  
 esp\_bt\_controller\_config\_t::ble\_hci\_evt\_size (C++ member), 302  
 esp\_bt\_controller\_config\_t::ble\_hci\_evt\_size (C++ member), 303  
 esp\_bt\_controller\_config\_t::ble\_hci\_evt\_size (C++ member), 302  
 esp\_bt\_controller\_config\_t::ble\_ll\_adv\_evt\_size (C++ member), 302  
 esp\_bt\_controller\_config\_t::ble\_ll\_adv\_evt\_size (C++ member), 304  
 esp\_bt\_controller\_config\_t::ble\_ll\_cfg\_evt\_size (C++ member), 303  
 esp\_bt\_controller\_config\_t::ble\_ll\_cfg\_evt\_size (C++ member), 304  
 esp\_bt\_controller\_config\_t::ble\_ll\_conn\_evt\_size (C++ member), 302  
 esp\_bt\_controller\_config\_t::ble\_ll\_conn\_evt\_size (C++ member), 303  
 esp\_bt\_controller\_config\_t::ble\_ll\_ctrl\_evt\_size (C++ member), 303  
 esp\_bt\_controller\_config\_t::ble\_ll\_ctrl\_evt\_size (C++ member), 304  
 esp\_bt\_controller\_config\_t::ble\_ll\_jitter\_evt\_size (C++ member), 302  
 esp\_bt\_controller\_config\_t::ble\_ll\_jitter\_evt\_size (C++ member), 303  
 esp\_bt\_controller\_config\_t::ble\_ll\_res\_evt\_size (C++ member), 302  
 esp\_bt\_controller\_config\_t::ble\_ll\_res\_evt\_size (C++ member), 303  
 esp\_bt\_controller\_config\_t::ble\_ll\_rsp\_evt\_size (C++ member), 302  
 esp\_bt\_controller\_config\_t::ble\_ll\_rsp\_evt\_size (C++ member), 304  
 esp\_bt\_controller\_config\_t::ble\_ll\_sca\_evt\_size (C++ member), 302  
 esp\_bt\_controller\_config\_t::ble\_ll\_sca\_evt\_size (C++ member), 304  
 esp\_bt\_controller\_config\_t::ble\_ll\_scan\_evt\_size (C++ member), 302  
 esp\_bt\_controller\_config\_t::ble\_ll\_scan\_evt\_size (C++ member), 303  
 esp\_bt\_controller\_config\_t::ble\_ll\_sched\_evt\_size (C++ member), 302  
 esp\_bt\_controller\_config\_t::ble\_ll\_sched\_evt\_size (C++ member), 302  
 esp\_bt\_controller\_config\_t::ble\_ll\_sched\_evt\_size (C++ member), 302  
 esp\_bt\_controller\_config\_t::ble\_ll\_sched\_evt\_size (C++ member), 304  
 esp\_bt\_controller\_config\_t::ble\_ll\_sched\_evt\_size (C++ member), 302  
 esp\_bt\_controller\_config\_t::ble\_ll\_sched\_evt\_size (C++ member), 299  
 esp\_bt\_controller\_config\_t::ble\_ll\_sync\_evt\_size (C++ member), 302  
 esp\_bt\_controller\_config\_t::ble\_ll\_sync\_evt\_size (C++ member), 300  
 esp\_bt\_controller\_config\_t::ble\_ll\_sync\_evt\_size (C++ member), 302  
 esp\_bt\_controller\_config\_t::ble\_ll\_sync\_evt\_size (C++ member), 300  
 esp\_bt\_controller\_config\_t::ble\_ll\_tx\_evt\_size (C++ member), 302  
 esp\_bt\_controller\_config\_t::ble\_ll\_tx\_evt\_size (C++ member), 299  
 esp\_bt\_controller\_config\_t::ble\_multi\_adv\_instances (C++ member), 303  
 esp\_bt\_controller\_config\_t::ble\_multi\_adv\_instances (C++ member), 300  
 esp\_bt\_controller\_config\_t::ble\_scan\_classify (C++ member), 304  
 esp\_bt\_controller\_config\_t::ble\_scan\_classify (C++ member), 300  
 esp\_bt\_controller\_config\_t::ble\_scan\_rsp\_data\_max\_len (C++ member), 303  
 esp\_bt\_controller\_config\_t::ble\_scan\_rsp\_data\_max\_len (C++ member), 305  
 esp\_bt\_controller\_config\_t::ble\_whitelist\_size (C++ member), 303  
 esp\_bt\_controller\_config\_t::ble\_whitelist\_size (C++ member), 305  
 esp\_bt\_controller\_config\_t::cca\_drop\_mode (C++ member), 304  
 esp\_bt\_controller\_config\_t::cca\_drop\_mode (C++ member), 305  
 esp\_bt\_controller\_config\_t::cca\_low\_tx\_pwr (C++ member), 304  
 esp\_bt\_controller\_config\_t::cca\_low\_tx\_pwr (C++ member), 305  
 esp\_bt\_controller\_config\_t::cca\_rssi\_thresh (C++ member), 304  
 esp\_bt\_controller\_config\_t::cca\_rssi\_thresh (C++ member), 305  
 esp\_bt\_controller\_config\_t::coex\_phy\_coex\_tx\_dev\_time\_val (C++ member), 304  
 esp\_bt\_controller\_config\_t::coex\_phy\_coex\_tx\_dev\_time\_val (C++ member), 168  
 esp\_bt\_controller\_config\_t::config\_magic (C++ member), 304  
 esp\_bt\_controller\_config\_t::config\_magic (C++ member), 168  
 esp\_bt\_controller\_config\_t::config\_version (C++ member), 302  
 esp\_bt\_controller\_config\_t::config\_version (C++ member), 167  
 esp\_bt\_controller\_config\_t::controller\_run\_cpu (C++ member), 167

- esp\_bt\_dev\_cb\_param\_t::name\_res\_param (C++ struct), 167
- esp\_bt\_dev\_cb\_param\_t::name\_res\_param (C++ member), 167
- esp\_bt\_dev\_cb\_param\_t::name\_res\_param (C++ member), 167
- esp\_bt\_dev\_cb\_t (C++ type), 167
- ESP\_BT\_DEV\_COEX\_BLE\_ST\_MESH\_CONFIG (C macro), 167
- ESP\_BT\_DEV\_COEX\_BLE\_ST\_MESH\_STANDBY (C macro), 167
- ESP\_BT\_DEV\_COEX\_BLE\_ST\_MESH\_TRAFFIC (C macro), 167
- ESP\_BT\_DEV\_COEX\_BT\_ST\_A2DP\_PAUSED (C macro), 167
- ESP\_BT\_DEV\_COEX\_BT\_ST\_A2DP\_STREAMING (C macro), 167
- ESP\_BT\_DEV\_COEX\_OP\_CLEAR (C macro), 167
- ESP\_BT\_DEV\_COEX\_OP\_SET (C macro), 167
- esp\_bt\_dev\_coex\_op\_t (C++ type), 167
- esp\_bt\_dev\_coex\_status\_config (C++ function), 166
- esp\_bt\_dev\_coex\_type\_t (C++ enum), 168
- esp\_bt\_dev\_coex\_type\_t::ESP\_BT\_DEV\_COEX\_TYPE\_BLE (C++ enumerator), 168
- esp\_bt\_dev\_coex\_type\_t::ESP\_BT\_DEV\_COEX\_TYPE\_BT (C++ enumerator), 168
- esp\_bt\_dev\_get\_address (C++ function), 166
- esp\_bt\_dev\_get\_device\_name (C++ function), 166
- esp\_bt\_dev\_register\_callback (C++ function), 166
- esp\_bt\_dev\_set\_device\_name (C++ function), 166
- esp\_bt\_dev\_type\_t (C++ enum), 163
- esp\_bt\_dev\_type\_t::ESP\_BT\_DEVICE\_TYPE\_BLE (C++ enumerator), 163
- esp\_bt\_dev\_type\_t::ESP\_BT\_DEVICE\_TYPE\_BREDR (C++ enumerator), 163
- esp\_bt\_dev\_type\_t::ESP\_BT\_DEVICE\_TYPE\_DUMO (C++ enumerator), 163
- esp\_bt\_duplicate\_exceptional\_subcode\_type\_t (C++ enum), 243
- esp\_bt\_duplicate\_exceptional\_subcode\_type\_t::ESP\_BT\_EXCEPTIONAL\_LIST\_ADD (C++ enumerator), 243
- esp\_bt\_duplicate\_exceptional\_subcode\_type\_t::ESP\_BT\_EXCEPTIONAL\_LIST\_CLEAN (C++ enumerator), 243
- esp\_bt\_duplicate\_exceptional\_subcode\_type\_t::ESP\_BT\_EXCEPTIONAL\_LIST\_REMOVE (C++ enumerator), 243
- esp\_bt\_mem\_release (C++ function), 301
- esp\_bt\_mode\_t (C++ enum), 305
- esp\_bt\_mode\_t::ESP\_BT\_MODE\_BLE (C++ enumerator), 305
- esp\_bt\_mode\_t::ESP\_BT\_MODE\_BTDM (C++ enumerator), 305
- esp\_bt\_mode\_t::ESP\_BT\_MODE\_CLASSIC\_BT (C++ enumerator), 305
- esp\_bt\_mode\_t::ESP\_BT\_MODE\_IDLE (C++ enumerator), 305
- ESP\_BT\_OCTET16\_LEN (C macro), 157
- esp\_bt\_octet16\_t (C++ type), 159
- ESP\_BT\_OCTET8\_LEN (C macro), 157
- esp\_bt\_octet8\_t (C++ type), 159
- ESP\_BT\_STATUS\_BASE\_FOR\_HCI\_ERR (C macro), 157
- esp\_bt\_status\_t (C++ enum), 159
- esp\_bt\_status\_t::ESP\_BT\_STATUS\_AUTH\_FAILURE (C++ enumerator), 159
- esp\_bt\_status\_t::ESP\_BT\_STATUS\_AUTH\_REJECTED (C++ enumerator), 159
- esp\_bt\_status\_t::ESP\_BT\_STATUS\_BUSY (C++ enumerator), 159
- esp\_bt\_status\_t::ESP\_BT\_STATUS\_CONTROL\_LE\_DATA\_LEN (C++ enumerator), 160
- esp\_bt\_status\_t::ESP\_BT\_STATUS\_DONE (C++ enumerator), 159
- esp\_bt\_status\_t::ESP\_BT\_STATUS\_EIR\_TOO\_LARGE (C++ enumerator), 160
- esp\_bt\_status\_t::ESP\_BT\_STATUS\_ERR\_ILLEGAL\_PARAMETER (C++ enumerator), 160
- esp\_bt\_status\_t::ESP\_BT\_STATUS\_FAIL (C++ enumerator), 159
- esp\_bt\_status\_t::ESP\_BT\_STATUS\_HCI\_AUTH\_FAILURE (C++ enumerator), 160
- esp\_bt\_status\_t::ESP\_BT\_STATUS\_HCI\_CHAN\_CLASSIFIED (C++ enumerator), 162
- esp\_bt\_status\_t::ESP\_BT\_STATUS\_HCI\_COMMAND\_DISALLOWED (C++ enumerator), 160
- esp\_bt\_status\_t::ESP\_BT\_STATUS\_HCI\_CONN\_CAUSE\_LOCAL\_LIMIT (C++ enumerator), 161
- esp\_bt\_status\_t::ESP\_BT\_STATUS\_HCI\_CONN\_FAILED\_ESTABLISHMENT (C++ enumerator), 163
- esp\_bt\_status\_t::ESP\_BT\_STATUS\_HCI\_CONN\_TOUT\_DUE\_TO\_BUSY (C++ enumerator), 162
- esp\_bt\_status\_t::ESP\_BT\_STATUS\_HCI\_CONNECTION\_EXPIRED (C++ enumerator), 160
- esp\_bt\_status\_t::ESP\_BT\_STATUS\_HCI\_CONNECTION\_TIMEOUT (C++ enumerator), 160
- esp\_bt\_status\_t::ESP\_BT\_STATUS\_HCI\_CONTROLLER\_BUSY (C++ enumerator), 162
- esp\_bt\_status\_t::ESP\_BT\_STATUS\_HCI\_DIFF\_TRANSACTION\_COLLISION (C++ enumerator), 162
- esp\_bt\_status\_t::ESP\_BT\_STATUS\_HCI\_EXCEPTIONAL\_LIST\_ADD (C++ enumerator), 162
- esp\_bt\_status\_t::ESP\_BT\_STATUS\_HCI\_DIRECTED\_ADVERTISEMENT (C++ enumerator), 162
- esp\_bt\_status\_t::ESP\_BT\_STATUS\_HCI\_ENCRYPT\_MODE\_NOT\_ALLOWED (C++ enumerator), 162
- esp\_bt\_status\_t::ESP\_BT\_STATUS\_HCI\_HOST\_BUSY\_PAIRING (C++ enumerator), 162
- esp\_bt\_status\_t::ESP\_BT\_STATUS\_HCI\_HOST\_REJECT\_DEVICE (C++ enumerator), 160
- esp\_bt\_status\_t::ESP\_BT\_STATUS\_HCI\_HOST\_REJECT\_REQUEST (C++ enumerator), 160
- esp\_bt\_status\_t::ESP\_BT\_STATUS\_HCI\_HOST\_REJECT\_SECURITY (C++ enumerator), 160
- esp\_bt\_status\_t::ESP\_BT\_STATUS\_HCI\_HOST\_TIMEOUT (C++ enumerator), 161





- esp\_bt\_status\_t::ESP\_BT\_STATUS\_UNACCEPTED\_COMMAND\_INTERVAL (C++ enumerator), 159  
 esp\_bt\_status\_t::ESP\_BT\_STATUS\_UNHANDLED (C++ enumerator), 159  
 esp\_bt\_status\_t::ESP\_BT\_STATUS\_UNSUPPORTED (C++ enumerator), 159  
 esp\_bt\_uuid\_t (C++ struct), 157  
 esp\_bt\_uuid\_t::len (C++ member), 157  
 esp\_bt\_uuid\_t::uuid (C++ member), 157  
 esp\_bt\_uuid\_t::uuid128 (C++ member), 157  
 esp\_bt\_uuid\_t::uuid16 (C++ member), 157  
 esp\_bt\_uuid\_t::uuid32 (C++ member), 157  
 esp\_btbb\_disable (C++ function), 2276  
 esp\_btbb\_enable (C++ function), 2276  
 esp\_chip\_id\_t (C++ enum), 1702  
 esp\_chip\_id\_t::ESP\_CHIP\_ID\_ESP32 (C++ enumerator), 1702  
 esp\_chip\_id\_t::ESP\_CHIP\_ID\_ESP32C2 (C++ enumerator), 1702  
 esp\_chip\_id\_t::ESP\_CHIP\_ID\_ESP32C3 (C++ enumerator), 1702  
 esp\_chip\_id\_t::ESP\_CHIP\_ID\_ESP32C6 (C++ enumerator), 1702  
 esp\_chip\_id\_t::ESP\_CHIP\_ID\_ESP32H2 (C++ enumerator), 1703  
 esp\_chip\_id\_t::ESP\_CHIP\_ID\_ESP32P4 (C++ enumerator), 1703  
 esp\_chip\_id\_t::ESP\_CHIP\_ID\_ESP32S2 (C++ enumerator), 1702  
 esp\_chip\_id\_t::ESP\_CHIP\_ID\_ESP32S3 (C++ enumerator), 1702  
 esp\_chip\_id\_t::ESP\_CHIP\_ID\_INVALID (C++ enumerator), 1703  
 esp\_chip\_info (C++ function), 1988  
 esp\_chip\_info\_t (C++ struct), 1988  
 esp\_chip\_info\_t::cores (C++ member), 1989  
 esp\_chip\_info\_t::features (C++ member), 1989  
 esp\_chip\_info\_t::model (C++ member), 1989  
 esp\_chip\_info\_t::revision (C++ member), 1989  
 esp\_chip\_model\_t (C++ enum), 1989  
 esp\_chip\_model\_t::CHIP\_ESP32 (C++ enumerator), 1989  
 esp\_chip\_model\_t::CHIP\_ESP32C2 (C++ enumerator), 1990  
 esp\_chip\_model\_t::CHIP\_ESP32C3 (C++ enumerator), 1989  
 esp\_chip\_model\_t::CHIP\_ESP32C6 (C++ enumerator), 1990  
 esp\_chip\_model\_t::CHIP\_ESP32C61 (C++ enumerator), 1990  
 esp\_chip\_model\_t::CHIP\_ESP32H2 (C++ enumerator), 1990  
 esp\_chip\_model\_t::CHIP\_ESP32P4 (C++ enumerator), 1990  
 esp\_chip\_model\_t::CHIP\_ESP32S2 (C++ enumerator), 1989  
 esp\_console\_cmd\_func\_t (C++ type), 1726  
 esp\_console\_cmd\_func\_with\_context\_t (C++ type), 1726  
 esp\_console\_cmd\_register (C++ function), 1721  
 esp\_console\_cmd\_t (C++ struct), 1725  
 esp\_console\_cmd\_t::argtable (C++ member), 1725  
 esp\_console\_cmd\_t::command (C++ member), 1725  
 esp\_console\_cmd\_t::context (C++ member), 1726  
 esp\_console\_cmd\_t::func (C++ member), 1725  
 esp\_console\_cmd\_t::func\_w\_context (C++ member), 1725  
 esp\_console\_cmd\_t::help (C++ member), 1725  
 esp\_console\_cmd\_t::hint (C++ member), 1725  
 ESP\_CONSOLE\_CONFIG\_DEFAULT (C macro), 1726  
 esp\_console\_config\_t (C++ struct), 1724  
 esp\_console\_config\_t::heap\_alloc\_caps (C++ member), 1724  
 esp\_console\_config\_t::hint\_bold (C++ member), 1724  
 esp\_console\_config\_t::hint\_color (C++ member), 1724  
 esp\_console\_config\_t::max\_cmdline\_args (C++ member), 1724  
 esp\_console\_config\_t::max\_cmdline\_length (C++ member), 1724  
 esp\_console\_deinit (C++ function), 1721  
 ESP\_CONSOLE\_DEV\_UART\_CONFIG\_DEFAULT (C macro), 1726  
 esp\_console\_dev\_uart\_config\_t (C++ struct), 1724  
 esp\_console\_dev\_uart\_config\_t::baud\_rate (C++ member), 1725  
 esp\_console\_dev\_uart\_config\_t::channel (C++ member), 1725  
 esp\_console\_dev\_uart\_config\_t::rx\_gpio\_num (C++ member), 1725







- tion), 1751
- esp\_efuse\_batch\_write\_cancel (C++ function), 1752
- esp\_efuse\_batch\_write\_commit (C++ function), 1752
- esp\_efuse\_block\_is\_empty (C++ function), 1753
- esp\_efuse\_block\_t (C++ enum), 1744
- esp\_efuse\_block\_t::EFUSE\_BLK0 (C++ enumerator), 1744
- esp\_efuse\_block\_t::EFUSE\_BLK1 (C++ enumerator), 1744
- esp\_efuse\_block\_t::EFUSE\_BLK10 (C++ enumerator), 1745
- esp\_efuse\_block\_t::EFUSE\_BLK2 (C++ enumerator), 1744
- esp\_efuse\_block\_t::EFUSE\_BLK3 (C++ enumerator), 1744
- esp\_efuse\_block\_t::EFUSE\_BLK4 (C++ enumerator), 1744
- esp\_efuse\_block\_t::EFUSE\_BLK5 (C++ enumerator), 1744
- esp\_efuse\_block\_t::EFUSE\_BLK6 (C++ enumerator), 1744
- esp\_efuse\_block\_t::EFUSE\_BLK7 (C++ enumerator), 1745
- esp\_efuse\_block\_t::EFUSE\_BLK8 (C++ enumerator), 1745
- esp\_efuse\_block\_t::EFUSE\_BLK9 (C++ enumerator), 1745
- esp\_efuse\_block\_t::EFUSE\_BLK\_KEY0 (C++ enumerator), 1744
- esp\_efuse\_block\_t::EFUSE\_BLK\_KEY1 (C++ enumerator), 1744
- esp\_efuse\_block\_t::EFUSE\_BLK\_KEY2 (C++ enumerator), 1745
- esp\_efuse\_block\_t::EFUSE\_BLK\_KEY3 (C++ enumerator), 1745
- esp\_efuse\_block\_t::EFUSE\_BLK\_KEY4 (C++ enumerator), 1745
- esp\_efuse\_block\_t::EFUSE\_BLK\_KEY5 (C++ enumerator), 1745
- esp\_efuse\_block\_t::EFUSE\_BLK\_KEY\_MAX (C++ enumerator), 1745
- esp\_efuse\_block\_t::EFUSE\_BLK\_MAX (C++ enumerator), 1745
- esp\_efuse\_block\_t::EFUSE\_BLK\_SYS\_DATA\_PART1 (C++ enumerator), 1744
- esp\_efuse\_block\_t::EFUSE\_BLK\_SYS\_DATA\_PART2 (C++ enumerator), 1745
- esp\_efuse\_block\_t::EFUSE\_BLK\_USER\_DATA (C++ enumerator), 1744
- esp\_efuse\_check\_errors (C++ function), 1756
- esp\_efuse\_check\_secure\_version (C++ function), 1751
- esp\_efuse\_coding\_scheme\_t (C++ enum), 1745
- esp\_efuse\_coding\_scheme\_t::EFUSE\_CODING\_SCHEME\_NONE (C++ enumerator), 1745
- esp\_efuse\_coding\_scheme\_t::EFUSE\_CODING\_SCHEME\_RS (C++ enumerator), 1745
- esp\_efuse\_count\_unused\_key\_blocks (C++ function), 1755
- esp\_efuse\_desc\_t (C++ struct), 1757
- esp\_efuse\_desc\_t::bit\_count (C++ member), 1757
- esp\_efuse\_desc\_t::bit\_start (C++ member), 1757
- esp\_efuse\_desc\_t::efuse\_block (C++ member), 1757
- esp\_efuse\_destroy\_block (C++ function), 1757
- esp\_efuse\_disable\_rom\_download\_mode (C++ function), 1750
- esp\_efuse\_enable\_rom\_secure\_download\_mode (C++ function), 1751
- esp\_efuse\_find\_purpose (C++ function), 1753
- esp\_efuse\_find\_unused\_key\_block (C++ function), 1755
- esp\_efuse\_get\_coding\_scheme (C++ function), 1749
- esp\_efuse\_get\_digest\_revoke (C++ function), 1755
- esp\_efuse\_get\_field\_size (C++ function), 1749
- esp\_efuse\_get\_key (C++ function), 1754
- esp\_efuse\_get\_key\_dis\_read (C++ function), 1753
- esp\_efuse\_get\_key\_dis\_write (C++ function), 1753
- esp\_efuse\_get\_key\_purpose (C++ function), 1754
- esp\_efuse\_get\_keypurpose\_dis\_write (C++ function), 1754
- esp\_efuse\_get\_pkg\_ver (C++ function), 1750
- esp\_efuse\_get\_purpose\_field (C++ function), 1754
- esp\_efuse\_get\_write\_protect\_of\_digest\_revoke (C++ function), 1755
- esp\_efuse\_key\_block\_unused (C++ function), 1753
- esp\_efuse\_mac\_get\_custom (C++ function), 1986
- esp\_efuse\_mac\_get\_default (C++ function), 1986
- esp\_efuse\_purpose\_t (C++ enum), 1745
- esp\_efuse\_purpose\_t::ESP\_EFUSE\_KEY\_PURPOSE\_ECDSA (C++ enumerator), 1746
- esp\_efuse\_purpose\_t::ESP\_EFUSE\_KEY\_PURPOSE\_HMAC\_D (C++ enumerator), 1746
- esp\_efuse\_purpose\_t::ESP\_EFUSE\_KEY\_PURPOSE\_HMAC\_D (C++ enumerator), 1746
- esp\_efuse\_purpose\_t::ESP\_EFUSE\_KEY\_PURPOSE\_HMAC\_D (C++ enumerator), 1746
- esp\_efuse\_purpose\_t::ESP\_EFUSE\_KEY\_PURPOSE\_HMAC\_U (C++ enumerator), 1746

esp\_efuse\_purpose\_t::ESP\_EFUSE\_KEY\_PURPOSE\_MAX\_write\_field\_blob (C++ function),  
 (C++ enumerator), 1746 1747  
 esp\_efuse\_purpose\_t::ESP\_EFUSE\_KEY\_PURPOSE\_SECURE\_WRITE\_write\_field\_cnt (C++ function),  
 (C++ enumerator), 1746 1748  
 esp\_efuse\_purpose\_t::ESP\_EFUSE\_KEY\_PURPOSE\_SECURE\_WRITE\_DIGEST (C++ function), 1755  
 (C++ enumerator), 1746 esp\_efuse\_write\_keys (C++ function), 1756  
 esp\_efuse\_purpose\_t::ESP\_EFUSE\_KEY\_PURPOSE\_SECURE\_WRITE\_DIGEST4 (C++ function), 1749  
 (C++ enumerator), 1746 ESP\_ERR\_CODING (C macro), 1758  
 esp\_efuse\_purpose\_t::ESP\_EFUSE\_KEY\_PURPOSE\_SECURE\_WRITE\_DIGEST2 (C++ function), 1758  
 (C++ enumerator), 1746 ESP\_ERR\_EFUSE (C macro), 1758  
 esp\_efuse\_purpose\_t::ESP\_EFUSE\_KEY\_PURPOSE\_SECURE\_WRITE\_DIGEST4 (C++ function), 1749  
 (C++ enumerator), 1745 ESP\_ERR\_EFUSE\_CNT\_IS\_FULL (C macro), 1758  
 esp\_efuse\_purpose\_t::ESP\_EFUSE\_KEY\_PURPOSE\_SECURE\_WRITE\_DIGEST4 (C++ function), 1749  
 (C++ enumerator), 1746 ESP\_ERR\_EFUSE\_REPEATED\_PROG (C macro),  
 1758  
 esp\_efuse\_read\_block (C++ function), 1749 ESP\_ERR\_ES\_128\_KEY  
 esp\_efuse\_read\_field\_bit (C++ function), 1747 ESP\_ERR\_ES\_NETIF\_BASE (C macro), 770  
 esp\_efuse\_read\_field\_blob (C++ function), 1747 ESP\_ERR\_ES\_NETIF\_DHCP\_ALREADY\_STARTED  
 (C macro), 771  
 esp\_efuse\_read\_field\_cnt (C++ function), 1747 ESP\_ERR\_ES\_NETIF\_DHCP\_ALREADY\_STOPPED  
 (C macro), 771  
 esp\_efuse\_read\_reg (C++ function), 1749 ESP\_ERR\_ES\_NETIF\_DHCP\_NOT\_STOPPED (C  
 macro), 771  
 esp\_efuse\_read\_secure\_version (C++ function), 1751 ESP\_ERR\_ES\_NETIF\_DHCPC\_START\_FAILED  
 (C macro), 771  
 esp\_efuse\_reset (C++ function), 1750 ESP\_ERR\_ES\_NETIF\_DHCPS\_START\_FAILED  
 (C macro), 771  
 esp\_efuse\_rom\_log\_scheme\_t (C++ enum), 1758 ESP\_ERR\_ES\_NETIF\_DNS\_NOT\_CONFIGURED  
 (C macro), 771  
 esp\_efuse\_rom\_log\_scheme\_t::ESP\_EFUSE\_ROM\_LOG\_ALREADY\_DONE (C++ enumerator), 1758  
 (C++ enumerator), 1758 ESP\_ERR\_ES\_NETIF\_DRIVER\_ATTACH\_FAILED  
 (C macro), 771  
 esp\_efuse\_rom\_log\_scheme\_t::ESP\_EFUSE\_ROM\_LOG\_ALREADY\_DONE (C++ enumerator), 1758  
 (C++ enumerator), 1751 ESP\_ERR\_ES\_NETIF\_IF\_NOT\_READY (C  
 macro), 771  
 esp\_efuse\_rom\_log\_scheme\_t::ESP\_EFUSE\_ROM\_LOG\_ALREADY\_DONE (C++ enumerator), 1758  
 (C++ enumerator), 1758 ESP\_ERR\_ES\_NETIF\_INIT\_FAILED (C macro),  
 771  
 esp\_efuse\_rom\_log\_scheme\_t::ESP\_EFUSE\_ROM\_LOG\_ALREADY\_DONE (C++ enumerator), 1758  
 (C++ enumerator), 1758 ESP\_ERR\_ES\_NETIF\_INVALID\_PARAMS (C  
 macro), 770  
 esp\_efuse\_rom\_log\_scheme\_t::ESP\_EFUSE\_ROM\_LOG\_ALREADY\_DONE (C++ enumerator), 1758  
 (C++ enumerator), 1758 ESP\_ERR\_ES\_NETIF\_IP6\_ADDR\_FAILED (C  
 macro), 771  
 esp\_efuse\_set\_digest\_revoke (C++ function), 1755 ESP\_ERR\_ES\_NETIF\_MLD6\_FAILED (C macro),  
 771  
 esp\_efuse\_set\_key\_dis\_read (C++ function), 1753 ESP\_ERR\_ES\_NETIF\_NO\_MEM (C macro), 771  
 esp\_efuse\_set\_key\_dis\_write (C++ function), 1753 ESP\_ERR\_ES\_TLS\_BASE (C macro), 69  
 esp\_efuse\_set\_key\_purpose (C++ function), 1754 ESP\_ERR\_ES\_TLS\_CANNOT\_CREATE\_SOCKET  
 (C macro), 70  
 esp\_efuse\_set\_keypurpose\_dis\_write (C++ function), 1754 ESP\_ERR\_ES\_TLS\_CANNOT\_RESOLVE\_HOSTNAME  
 (C macro), 69  
 esp\_efuse\_set\_read\_protect (C++ function), 1748 ESP\_ERR\_ES\_TLS\_CONNECTION\_TIMEOUT (C  
 macro), 70  
 esp\_efuse\_set\_rom\_log\_scheme (C++ function), 1750 ESP\_ERR\_ES\_TLS\_FAILED\_CONNECT\_TO\_HOST  
 (C macro), 70  
 esp\_efuse\_set\_write\_protect (C++ function), 1748 ESP\_ERR\_ES\_TLS\_SE\_FAILED (C macro), 70  
 (C++ function), 1755 ESP\_ERR\_ES\_TLS\_SOCKET\_SETOPT\_FAILED  
 (C macro), 70  
 esp\_efuse\_set\_write\_protect\_of\_digest\_revoke (C++ function), 1755 ESP\_ERR\_ES\_TLS\_TCP\_CLOSED\_FIN (C  
 macro), 70  
 esp\_efuse\_update\_secure\_version (C++ function), 1751 ESP\_ERR\_ES\_TLS\_UNSUPPORTED\_PROTOCOL\_FAMILY  
 (C macro), 70  
 esp\_efuse\_write\_block (C++ function), 1750 ESP\_ERR\_FLASH\_BASE (C macro), 1761  
 esp\_efuse\_write\_field\_bit (C++ function), 1748 ESP\_ERR\_FLASH\_NOT\_INITIALISED (C macro),  
 1143

- ESP\_ERR\_FLASH\_OP\_FAIL (*C macro*), 1136  
ESP\_ERR\_FLASH\_OP\_TIMEOUT (*C macro*), 1136  
ESP\_ERR\_FLASH\_PROTECTED (*C macro*), 1143  
ESP\_ERR\_FLASH\_UNSUPPORTED\_CHIP (*C macro*), 1143  
ESP\_ERR\_FLASH\_UNSUPPORTED\_HOST (*C macro*), 1143  
ESP\_ERR\_HTTP\_BASE (*C macro*), 85  
ESP\_ERR\_HTTP\_CONNECT (*C macro*), 86  
ESP\_ERR\_HTTP\_CONNECTING (*C macro*), 86  
ESP\_ERR\_HTTP\_CONNECTION\_CLOSED (*C macro*), 86  
ESP\_ERR\_HTTP\_EAGAIN (*C macro*), 86  
ESP\_ERR\_HTTP\_FETCH\_HEADER (*C macro*), 86  
ESP\_ERR\_HTTP\_INVALID\_TRANSPORT (*C macro*), 86  
ESP\_ERR\_HTTP\_MAX\_REDIRECT (*C macro*), 85  
ESP\_ERR\_HTTP\_WRITE\_DATA (*C macro*), 86  
ESP\_ERR\_HTTPD\_ALLOC\_MEM (*C macro*), 140  
ESP\_ERR\_HTTPD\_BASE (*C macro*), 140  
ESP\_ERR\_HTTPD\_HANDLER\_EXISTS (*C macro*), 140  
ESP\_ERR\_HTTPD\_HANDLERS\_FULL (*C macro*), 140  
ESP\_ERR\_HTTPD\_INVALID\_REQ (*C macro*), 140  
ESP\_ERR\_HTTPD\_RESP\_HDR (*C macro*), 140  
ESP\_ERR\_HTTPD\_RESP\_SEND (*C macro*), 140  
ESP\_ERR\_HTTPD\_RESULT\_TRUNC (*C macro*), 140  
ESP\_ERR\_HTTPD\_TASK (*C macro*), 140  
ESP\_ERR\_HTTPS\_OTA\_BASE (*C macro*), 1768  
ESP\_ERR\_HTTPS\_OTA\_IN\_PROGRESS (*C macro*), 1768  
ESP\_ERR\_HW\_CRYPTO\_BASE (*C macro*), 1761  
ESP\_ERR\_INVALID\_ARG (*C macro*), 1760  
ESP\_ERR\_INVALID\_CRC (*C macro*), 1761  
ESP\_ERR\_INVALID\_MAC (*C macro*), 1761  
ESP\_ERR\_INVALID\_RESPONSE (*C macro*), 1761  
ESP\_ERR\_INVALID\_SIZE (*C macro*), 1760  
ESP\_ERR\_INVALID\_STATE (*C macro*), 1760  
ESP\_ERR\_INVALID\_VERSION (*C macro*), 1761  
ESP\_ERR\_MBEDTLS\_CERT\_PARTLY\_OK (*C macro*), 70  
ESP\_ERR\_MBEDTLS\_CTR\_DRBG\_SEED\_FAILED (*C macro*), 70  
ESP\_ERR\_MBEDTLS\_PK\_PARSE\_KEY\_FAILED (*C macro*), 70  
ESP\_ERR\_MBEDTLS\_SSL\_CONF\_ALPN\_PROTOCOLS\_FAILED (*C macro*), 70  
ESP\_ERR\_MBEDTLS\_SSL\_CONF\_OWN\_CERT\_FAILED (*C macro*), 70  
ESP\_ERR\_MBEDTLS\_SSL\_CONF\_PSK\_FAILED (*C macro*), 71  
ESP\_ERR\_MBEDTLS\_SSL\_CONFIG\_DEFAULTS\_FAILED (*C macro*), 70  
ESP\_ERR\_MBEDTLS\_SSL\_HANDSHAKE\_FAILED (*C macro*), 71  
ESP\_ERR\_MBEDTLS\_SSL\_SET\_HOSTNAME\_FAILED (*C macro*), 70  
ESP\_ERR\_MBEDTLS\_SSL\_SETUP\_FAILED (*C macro*), 70  
ESP\_ERR\_MBEDTLS\_SSL\_TICKET\_SETUP\_FAILED (*C macro*), 71  
ESP\_ERR\_MBEDTLS\_SSL\_WRITE\_FAILED (*C macro*), 70  
ESP\_ERR\_MBEDTLS\_X509\_CRT\_PARSE\_FAILED (*C macro*), 70  
ESP\_ERR\_MEMPROT\_BASE (*C macro*), 1761  
ESP\_ERR\_MESH\_BASE (*C macro*), 1761  
ESP\_ERR\_NO\_MEM (*C macro*), 1760  
ESP\_ERR\_NOT\_ALLOWED (*C macro*), 1761  
ESP\_ERR\_NOT\_ENOUGH\_UNUSED\_KEY\_BLOCKS (*C macro*), 1758  
ESP\_ERR\_NOT\_FINISHED (*C macro*), 1761  
ESP\_ERR\_NOT\_FOUND (*C macro*), 1760  
ESP\_ERR\_NOT\_SUPPORTED (*C macro*), 1760  
ESP\_ERR\_NVS\_BASE (*C macro*), 1643  
ESP\_ERR\_NVS\_CONTENT\_DIFFERS (*C macro*), 1644  
ESP\_ERR\_NVS\_CORRUPT\_KEY\_PART (*C macro*), 1644  
ESP\_ERR\_NVS\_ENCR\_NOT\_SUPPORTED (*C macro*), 1644  
ESP\_ERR\_NVS\_INVALID\_HANDLE (*C macro*), 1643  
ESP\_ERR\_NVS\_INVALID\_LENGTH (*C macro*), 1643  
ESP\_ERR\_NVS\_INVALID\_NAME (*C macro*), 1643  
ESP\_ERR\_NVS\_INVALID\_STATE (*C macro*), 1643  
ESP\_ERR\_NVS\_KEY\_TOO\_LONG (*C macro*), 1643  
ESP\_ERR\_NVS\_KEYS\_NOT\_INITIALIZED (*C macro*), 1644  
ESP\_ERR\_NVS\_NEW\_VERSION\_FOUND (*C macro*), 1643  
ESP\_ERR\_NVS\_NO\_FREE\_PAGES (*C macro*), 1643  
ESP\_ERR\_NVS\_NOT\_ENOUGH\_SPACE (*C macro*), 1643  
ESP\_ERR\_NVS\_NOT\_FOUND (*C macro*), 1643  
ESP\_ERR\_NVS\_NOT\_INITIALIZED (*C macro*), 1643  
ESP\_ERR\_NVS\_PAGE\_FULL (*C macro*), 1643  
ESP\_ERR\_NVS\_PART\_NOT\_FOUND (*C macro*), 1643  
ESP\_ERR\_NVS\_READ\_ONLY (*C macro*), 1643  
ESP\_ERR\_NVS\_REMOVE\_FAILED (*C macro*), 1643  
ESP\_ERR\_NVS\_SEC\_BASE (*C macro*), 1651  
ESP\_ERR\_NVS\_SEC\_HMAC\_KEY\_BLK\_ALREADY\_USED (*C macro*), 1651  
ESP\_ERR\_NVS\_SEC\_HMAC\_KEY\_GENERATION\_FAILED (*C macro*), 1651  
ESP\_ERR\_NVS\_SEC\_HMAC\_KEY\_NOT\_FOUND (*C macro*), 1651  
ESP\_ERR\_NVS\_SEC\_HMAC\_XTS\_KEYS\_DERIV\_FAILED (*C macro*), 1651  
ESP\_ERR\_NVS\_TYPE\_MISMATCH (*C macro*), 1643  
ESP\_ERR\_NVS\_VALUE\_TOO\_LONG (*C macro*), 1643  
ESP\_ERR\_NVS\_WRONG\_ENCRYPTION (*C macro*), 1644  
ESP\_ERR\_NVS\_XTS\_CFG\_FAILED (*C macro*), 1644  
ESP\_ERR\_NVS\_XTS\_CFG\_NOT\_FOUND (*C macro*), 1644

- 1644
- ESP\_ERR\_NVS\_XTS\_DECR\_FAILED (C macro), 1644
- ESP\_ERR\_NVS\_XTS\_ENCR\_FAILED (C macro), 1644
- ESP\_ERR\_OTA\_BASE (C macro), 2008
- ESP\_ERR\_OTA\_PARTITION\_CONFLICT (C macro), 2008
- ESP\_ERR\_OTA\_ROLLBACK\_FAILED (C macro), 2008
- ESP\_ERR\_OTA\_ROLLBACK\_INVALID\_STATE (C macro), 2008
- ESP\_ERR\_OTA\_SELECT\_INFO\_INVALID (C macro), 2008
- ESP\_ERR\_OTA\_SMALL\_SEC\_VER (C macro), 2008
- ESP\_ERR\_OTA\_VALIDATE\_FAILED (C macro), 2008
- esp\_err\_t (C++ type), 1762
- ESP\_ERR\_TIMEOUT (C macro), 1761
- esp\_err\_to\_name (C++ function), 1760
- esp\_err\_to\_name\_r (C++ function), 1760
- ESP\_ERR\_WIFI\_BASE (C macro), 1761
- ESP\_ERR\_WOLFSSL\_CERT\_VERIFY\_SETUP\_FAILED (C macro), 71
- ESP\_ERR\_WOLFSSL\_CTX\_SETUP\_FAILED (C macro), 71
- ESP\_ERR\_WOLFSSL\_KEY\_VERIFY\_SETUP\_FAILED (C macro), 71
- ESP\_ERR\_WOLFSSL\_SSL\_CONF\_ALPN\_PROTOCOLS\_FAILED (C macro), 71
- ESP\_ERR\_WOLFSSL\_SSL\_HANDSHAKE\_FAILED (C macro), 71
- ESP\_ERR\_WOLFSSL\_SSL\_SET\_HOSTNAME\_FAILED (C macro), 71
- ESP\_ERR\_WOLFSSL\_SSL\_SETUP\_FAILED (C macro), 71
- ESP\_ERR\_WOLFSSL\_SSL\_WRITE\_FAILED (C macro), 71
- ESP\_ERROR\_CHECK (C macro), 1761
- ESP\_ERROR\_CHECK\_WITHOUT\_ABORT (C macro), 1761
- esp\_eth\_config\_t (C++ struct), 710
- esp\_eth\_config\_t::check\_link\_period\_ms (C++ member), 710
- esp\_eth\_config\_t::mac (C++ member), 710
- esp\_eth\_config\_t::on\_lowlevel\_deinit\_done (C++ member), 711
- esp\_eth\_config\_t::on\_lowlevel\_init\_done (C++ member), 710
- esp\_eth\_config\_t::phy (C++ member), 710
- esp\_eth\_config\_t::read\_phy\_reg (C++ member), 711
- esp\_eth\_config\_t::stack\_input (C++ member), 710
- esp\_eth\_config\_t::write\_phy\_reg (C++ member), 711
- esp\_eth\_decrease\_reference (C++ function), 710
- esp\_eth\_del\_netif\_glue (C++ function), 734
- esp\_eth\_driver\_install (C++ function), 707
- esp\_eth\_driver\_uninstall (C++ function), 707
- esp\_eth\_get\_mac\_instance (C++ function), 709
- esp\_eth\_get\_phy\_instance (C++ function), 709
- esp\_eth\_handle\_t (C++ type), 712
- esp\_eth\_increase\_reference (C++ function), 710
- esp\_eth\_io\_cmd\_t (C++ enum), 712
- esp\_eth\_io\_cmd\_t::ETH\_CMD\_CUSTOM\_MAC\_CMDS (C++ enumerator), 713
- esp\_eth\_io\_cmd\_t::ETH\_CMD\_CUSTOM\_PHY\_CMDS (C++ enumerator), 713
- esp\_eth\_io\_cmd\_t::ETH\_CMD\_G\_AUTONEGO (C++ enumerator), 712
- esp\_eth\_io\_cmd\_t::ETH\_CMD\_G\_DUPLEX\_MODE (C++ enumerator), 713
- esp\_eth\_io\_cmd\_t::ETH\_CMD\_G\_MAC\_ADDR (C++ enumerator), 712
- esp\_eth\_io\_cmd\_t::ETH\_CMD\_G\_PHY\_ADDR (C++ enumerator), 712
- esp\_eth\_io\_cmd\_t::ETH\_CMD\_G\_SPEED (C++ enumerator), 712
- esp\_eth\_io\_cmd\_t::ETH\_CMD\_READ\_PHY\_REG (C++ enumerator), 713
- esp\_eth\_io\_cmd\_t::ETH\_CMD\_S\_AUTONEGO (C++ enumerator), 712
- esp\_eth\_io\_cmd\_t::ETH\_CMD\_S\_DUPLEX\_MODE (C++ enumerator), 713
- esp\_eth\_io\_cmd\_t::ETH\_CMD\_S\_FLOW\_CTRL (C++ enumerator), 712
- esp\_eth\_io\_cmd\_t::ETH\_CMD\_S\_MAC\_ADDR (C++ enumerator), 712
- esp\_eth\_io\_cmd\_t::ETH\_CMD\_S\_PHY\_ADDR (C++ enumerator), 712
- esp\_eth\_io\_cmd\_t::ETH\_CMD\_S\_PHY\_LOOPBACK (C++ enumerator), 713
- esp\_eth\_io\_cmd\_t::ETH\_CMD\_S\_PROMISCUOUS (C++ enumerator), 712
- esp\_eth\_io\_cmd\_t::ETH\_CMD\_S\_SPEED (C++ enumerator), 712
- esp\_eth\_io\_cmd\_t::ETH\_CMD\_WRITE\_PHY\_REG (C++ enumerator), 713
- esp\_eth\_ioctl (C++ function), 708
- esp\_eth\_mac\_s (C++ struct), 716
- esp\_eth\_mac\_s::custom\_ioctl (C++ member), 719
- esp\_eth\_mac\_s::deinit (C++ member), 716
- esp\_eth\_mac\_s::del (C++ member), 720
- esp\_eth\_mac\_s::enable\_flow\_ctrl (C++ member), 719
- esp\_eth\_mac\_s::get\_addr (C++ member), 718
- esp\_eth\_mac\_s::init (C++ member), 716
- esp\_eth\_mac\_s::read\_phy\_reg (C++ member), 717



- esp\_eth\_mac\_s::receive (C++ member), 717  
 esp\_eth\_mac\_s::set\_addr (C++ member), 718  
 esp\_eth\_mac\_s::set\_duplex (C++ member), 718  
 esp\_eth\_mac\_s::set\_link (C++ member), 719  
 esp\_eth\_mac\_s::set\_mediator (C++ member), 716  
 esp\_eth\_mac\_s::set\_peer\_pause\_ability (C++ member), 719  
 esp\_eth\_mac\_s::set\_promiscuous (C++ member), 719  
 esp\_eth\_mac\_s::set\_speed (C++ member), 718  
 esp\_eth\_mac\_s::start (C++ member), 716  
 esp\_eth\_mac\_s::stop (C++ member), 716  
 esp\_eth\_mac\_s::transmit (C++ member), 716  
 esp\_eth\_mac\_s::transmit\_vars (C++ member), 717  
 esp\_eth\_mac\_s::write\_phy\_reg (C++ member), 718  
 esp\_eth\_mac\_t (C++ type), 720  
 esp\_eth\_mediator\_s (C++ struct), 713  
 esp\_eth\_mediator\_s::on\_state\_changed (C++ member), 714  
 esp\_eth\_mediator\_s::phy\_reg\_read (C++ member), 713  
 esp\_eth\_mediator\_s::phy\_reg\_write (C++ member), 714  
 esp\_eth\_mediator\_s::stack\_input (C++ member), 714  
 esp\_eth\_mediator\_t (C++ type), 714  
 esp\_eth\_netif\_glue\_handle\_t (C++ type), 734  
 esp\_eth\_new\_netif\_glue (C++ function), 734  
 esp\_eth\_phy\_802\_3\_advertise\_pause\_ability (C++ function), 729  
 esp\_eth\_phy\_802\_3\_autonego\_ctrl (C++ function), 728  
 esp\_eth\_phy\_802\_3\_basic\_phy\_deinit (C++ function), 730  
 esp\_eth\_phy\_802\_3\_basic\_phy\_init (C++ function), 730  
 esp\_eth\_phy\_802\_3\_deinit (C++ function), 730  
 esp\_eth\_phy\_802\_3\_del (C++ function), 730  
 esp\_eth\_phy\_802\_3\_detect\_phy\_addr (C++ function), 730  
 esp\_eth\_phy\_802\_3\_get\_addr (C++ function), 729  
 esp\_eth\_phy\_802\_3\_get\_mmd\_addr (C++ function), 731  
 esp\_eth\_phy\_802\_3\_init (C++ function), 730  
 esp\_eth\_phy\_802\_3\_loopback (C++ function), 729  
 esp\_eth\_phy\_802\_3\_mmd\_func\_t (C++ enum), 734  
 esp\_eth\_phy\_802\_3\_mmd\_func\_t::MMD\_FUNC\_ADDR\_ (C++ enumerator), 734  
 esp\_eth\_phy\_802\_3\_mmd\_func\_t::MMD\_FUNC\_DATA\_NOINC (C++ enumerator), 734  
 esp\_eth\_phy\_802\_3\_mmd\_func\_t::MMD\_FUNC\_DATA\_RWINC (C++ enumerator), 734  
 esp\_eth\_phy\_802\_3\_mmd\_func\_t::MMD\_FUNC\_DATA\_WINCR (C++ enumerator), 734  
 esp\_eth\_phy\_802\_3\_obj\_config\_init (C++ function), 733  
 esp\_eth\_phy\_802\_3\_pwrctl (C++ function), 728  
 esp\_eth\_phy\_802\_3\_read\_manufac\_info (C++ function), 731  
 esp\_eth\_phy\_802\_3\_read\_mmd\_data (C++ function), 732  
 esp\_eth\_phy\_802\_3\_read\_mmd\_register (C++ function), 732  
 esp\_eth\_phy\_802\_3\_read\_oui (C++ function), 731  
 esp\_eth\_phy\_802\_3\_reset (C++ function), 728  
 esp\_eth\_phy\_802\_3\_reset\_hw (C++ function), 730  
 esp\_eth\_phy\_802\_3\_set\_addr (C++ function), 728  
 esp\_eth\_phy\_802\_3\_set\_duplex (C++ function), 729  
 esp\_eth\_phy\_802\_3\_set\_link (C++ function), 729  
 esp\_eth\_phy\_802\_3\_set\_mediator (C++ function), 728  
 esp\_eth\_phy\_802\_3\_set\_mmd\_addr (C++ function), 731  
 esp\_eth\_phy\_802\_3\_set\_speed (C++ function), 729  
 esp\_eth\_phy\_802\_3\_write\_mmd\_data (C++ function), 732  
 esp\_eth\_phy\_802\_3\_write\_mmd\_register (C++ function), 732  
 ESP\_ETH\_PHY\_ADDR\_AUTO (C macro), 727  
 esp\_eth\_phy\_into\_phy\_802\_3 (C++ function), 733  
 esp\_eth\_phy\_new\_dp83848 (C++ function), 723  
 esp\_eth\_phy\_new\_ip101 (C++ function), 723  
 esp\_eth\_phy\_new\_ksz80xx (C++ function), 723  
 esp\_eth\_phy\_new\_lan87xx (C++ function), 723  
 esp\_eth\_phy\_new\_rtl8201 (C++ function), 723  
 esp\_eth\_phy\_reg\_rw\_data\_t (C++ struct), 711  
 esp\_eth\_phy\_reg\_rw\_data\_t::reg\_addr (C++ member), 712  
 esp\_eth\_phy\_reg\_rw\_data\_t::reg\_value\_p (C++ member), 712  
 esp\_eth\_phy\_s (C++ struct), 723  
 esp\_eth\_phy\_s::advertise\_pause\_ability (C++ member), 725  
 esp\_eth\_phy\_s::autonego\_ctrl (C++ member), 724  
 esp\_eth\_phy\_s::custom\_ioctl (C++ member), 726  
 esp\_eth\_phy\_s::deinit (C++ member), 724

- esp\_eth\_phy\_s::del (C++ member), 726  
 esp\_eth\_phy\_s::get\_addr (C++ member), 725  
 esp\_eth\_phy\_s::get\_link (C++ member), 725  
 esp\_eth\_phy\_s::init (C++ member), 724  
 esp\_eth\_phy\_s::loopback (C++ member), 725  
 esp\_eth\_phy\_s::pwrctl (C++ member), 725  
 esp\_eth\_phy\_s::reset (C++ member), 724  
 esp\_eth\_phy\_s::reset\_hw (C++ member), 724  
 esp\_eth\_phy\_s::set\_addr (C++ member), 725  
 esp\_eth\_phy\_s::set\_duplex (C++ member), 726  
 esp\_eth\_phy\_s::set\_link (C++ member), 725  
 esp\_eth\_phy\_s::set\_mediator (C++ member), 723  
 esp\_eth\_phy\_s::set\_speed (C++ member), 726  
 esp\_eth\_phy\_t (C++ type), 727  
 esp\_eth\_start (C++ function), 707  
 esp\_eth\_state\_t (C++ enum), 714  
 esp\_eth\_state\_t::ETH\_STATE\_DEINIT (C++ enumerator), 715  
 esp\_eth\_state\_t::ETH\_STATE\_DUPLEX (C++ enumerator), 715  
 esp\_eth\_state\_t::ETH\_STATE\_LINK (C++ enumerator), 715  
 esp\_eth\_state\_t::ETH\_STATE\_LLIMIT (C++ enumerator), 714  
 esp\_eth\_state\_t::ETH\_STATE\_PAUSE (C++ enumerator), 715  
 esp\_eth\_state\_t::ETH\_STATE\_SPEED (C++ enumerator), 715  
 esp\_eth\_stop (C++ function), 707  
 esp\_eth\_transmit (C++ function), 708  
 esp\_eth\_transmit\_vargs (C++ function), 708  
 esp\_eth\_update\_input\_path (C++ function), 708  
 esp\_etm\_channel\_config\_t (C++ struct), 836  
 esp\_etm\_channel\_connect (C++ function), 834  
 esp\_etm\_channel\_disable (C++ function), 834  
 esp\_etm\_channel\_enable (C++ function), 834  
 esp\_etm\_channel\_handle\_t (C++ type), 836  
 esp\_etm\_del\_channel (C++ function), 834  
 esp\_etm\_del\_event (C++ function), 835  
 esp\_etm\_del\_task (C++ function), 835  
 esp\_etm\_dump (C++ function), 835  
 esp\_etm\_event\_handle\_t (C++ type), 836  
 esp\_etm\_new\_channel (C++ function), 834  
 esp\_etm\_task\_handle\_t (C++ type), 836  
 ESP\_EVENT\_ANY\_BASE (C macro), 1781  
 ESP\_EVENT\_ANY\_ID (C macro), 1781  
 ESP\_EVENT\_DECLARE\_BASE (C macro), 1781  
 ESP\_EVENT\_DEFINE\_BASE (C macro), 1781  
 esp\_event\_dump (C++ function), 1780  
 esp\_event\_handler\_instance\_register (C++ function), 1776  
 esp\_event\_handler\_instance\_register\_with (C++ function), 1775  
 esp\_event\_handler\_instance\_t (C++ type), 1781  
 esp\_event\_handler\_instance\_unregister (C++ function), 1778  
 esp\_event\_handler\_instance\_unregister\_with (C++ function), 1777  
 esp\_event\_handler\_register (C++ function), 1774  
 esp\_event\_handler\_register\_with (C++ function), 1774  
 esp\_event\_handler\_t (C++ type), 1781  
 esp\_event\_handler\_unregister (C++ function), 1776  
 esp\_event\_handler\_unregister\_with (C++ function), 1777  
 esp\_event\_isr\_post (C++ function), 1779  
 esp\_event\_isr\_post\_to (C++ function), 1779  
 esp\_event\_loop\_args\_t (C++ struct), 1780  
 esp\_event\_loop\_args\_t::queue\_size (C++ member), 1780  
 esp\_event\_loop\_args\_t::task\_core\_id (C++ member), 1781  
 esp\_event\_loop\_args\_t::task\_name (C++ member), 1780  
 esp\_event\_loop\_args\_t::task\_priority (C++ member), 1781  
 esp\_event\_loop\_args\_t::task\_stack\_size (C++ member), 1781  
 esp\_event\_loop\_create (C++ function), 1773  
 esp\_event\_loop\_create\_default (C++ function), 1773  
 esp\_event\_loop\_delete (C++ function), 1773  
 esp\_event\_loop\_delete\_default (C++ function), 1773  
 esp\_event\_loop\_handle\_t (C++ type), 1781  
 esp\_event\_loop\_run (C++ function), 1773  
 esp\_event\_post (C++ function), 1778  
 esp\_event\_post\_to (C++ function), 1778  
 ESP\_EXECUTE\_EXPRESSION\_WITH\_STACK (C macro), 1714  
 esp\_execute\_shared\_stack\_function (C++ function), 1713  
 ESP\_FAIL (C macro), 1760  
 esp\_fill\_random (C++ function), 2022  
 esp\_flash\_chip\_driver\_initialized (C++ function), 1127  
 esp\_flash\_counter\_t (C++ struct), 1144  
 esp\_flash\_counter\_t::bytes (C++ member), 1144  
 esp\_flash\_counter\_t::count (C++ member), 1144  
 esp\_flash\_counter\_t::time (C++ member), 1144  
 esp\_flash\_counters\_t (C++ struct), 1144  
 esp\_flash\_counters\_t::erase (C++ member), 1145  
 esp\_flash\_counters\_t::read (C++ member), 1145

- esp\_flash\_counters\_t::write (C++ member), 1145  
 esp\_flash\_dump\_counters (C++ function), 1144  
 esp\_flash\_enc\_mode\_t (C++ enum), 1147  
 esp\_flash\_enc\_mode\_t::ESP\_FLASH\_ENC\_MODE\_DEVELOPMENT (C++ enumerator), 1147  
 esp\_flash\_enc\_mode\_t::ESP\_FLASH\_ENC\_MODE\_DISABLED (C++ enumerator), 1147  
 esp\_flash\_enc\_mode\_t::ESP\_FLASH\_ENC\_MODE\_RELEASE (C++ enumerator), 1147  
 esp\_flash\_encrypt\_check\_and\_update (C++ function), 1145  
 esp\_flash\_encrypt\_contents (C++ function), 1146  
 esp\_flash\_encrypt\_enable (C++ function), 1146  
 esp\_flash\_encrypt\_init (C++ function), 1146  
 esp\_flash\_encrypt\_initialized\_once (C++ function), 1145  
 esp\_flash\_encrypt\_is\_write\_protected (C++ function), 1146  
 esp\_flash\_encrypt\_region (C++ function), 1146  
 esp\_flash\_encrypt\_state (C++ function), 1145  
 esp\_flash\_encryption\_cfg\_verify\_release\_mode (C++ function), 1147  
 esp\_flash\_encryption\_enabled (C++ function), 1145  
 esp\_flash\_encryption\_init\_checks (C++ function), 1146  
 esp\_flash\_encryption\_set\_release\_mode (C++ function), 1147  
 esp\_flash\_erase\_chip (C++ function), 1128  
 esp\_flash\_erase\_region (C++ function), 1128  
 esp\_flash\_get\_chip\_write\_protect (C++ function), 1129  
 esp\_flash\_get\_counters (C++ function), 1144  
 esp\_flash\_get\_physical\_size (C++ function), 1128  
 esp\_flash\_get\_protectable\_regions (C++ function), 1129  
 esp\_flash\_get\_protected\_region (C++ function), 1130  
 esp\_flash\_get\_size (C++ function), 1127  
 esp\_flash\_init (C++ function), 1127  
 esp\_flash\_io\_mode\_t (C++ enum), 1142  
 esp\_flash\_io\_mode\_t::SPI\_FLASH\_DIO (C++ enumerator), 1143  
 esp\_flash\_io\_mode\_t::SPI\_FLASH\_DOUT (C++ enumerator), 1143  
 esp\_flash\_io\_mode\_t::SPI\_FLASH\_FASTRD (C++ enumerator), 1142  
 esp\_flash\_io\_mode\_t::SPI\_FLASH\_OPI\_DTR (C++ enumerator), 1143  
 esp\_flash\_io\_mode\_t::SPI\_FLASH\_OPI\_STR (C++ enumerator), 1143  
 esp\_flash\_io\_mode\_t::SPI\_FLASH\_QIO (C++ enumerator), 1143  
 esp\_flash\_io\_mode\_t::SPI\_FLASH\_QOUT (C++ enumerator), 1143  
 esp\_flash\_io\_mode\_t::SPI\_FLASH\_READ\_MODE\_MAX (C++ enumerator), 1143  
 esp\_flash\_io\_mode\_t::SPI\_FLASH\_SLOWRD (C++ enumerator), 1142  
 esp\_flash\_is\_quad\_mode (C++ function), 1132  
 esp\_flash\_os\_functions\_t (C++ struct), 1132  
 esp\_flash\_os\_functions\_t::check\_yield (C++ member), 1133  
 esp\_flash\_os\_functions\_t::delay\_us (C++ member), 1133  
 esp\_flash\_os\_functions\_t::end (C++ member), 1132  
 esp\_flash\_os\_functions\_t::get\_system\_time (C++ member), 1133  
 esp\_flash\_os\_functions\_t::get\_temp\_buffer (C++ member), 1133  
 esp\_flash\_os\_functions\_t::region\_protected (C++ member), 1133  
 esp\_flash\_os\_functions\_t::release\_temp\_buffer (C++ member), 1133  
 esp\_flash\_os\_functions\_t::set\_flash\_op\_status (C++ member), 1133  
 esp\_flash\_os\_functions\_t::start (C++ member), 1132  
 esp\_flash\_os\_functions\_t::yield (C++ member), 1133  
 esp\_flash\_read (C++ function), 1130  
 esp\_flash\_read\_encrypted (C++ function), 1132  
 esp\_flash\_read\_id (C++ function), 1127  
 esp\_flash\_read\_unique\_chip\_id (C++ function), 1128  
 esp\_flash\_region\_t (C++ struct), 1132  
 esp\_flash\_region\_t::offset (C++ member), 1132  
 esp\_flash\_region\_t::size (C++ member), 1132  
 esp\_flash\_reset\_counters (C++ function), 1144  
 esp\_flash\_set\_chip\_write\_protect (C++ function), 1129  
 esp\_flash\_set\_protected\_region (C++ function), 1130  
 esp\_flash\_speed\_s (C++ enum), 1142  
 esp\_flash\_speed\_s::ESP\_FLASH\_10MHZ (C++ enumerator), 1142  
 esp\_flash\_speed\_s::ESP\_FLASH\_120MHZ (C++ enumerator), 1142  
 esp\_flash\_speed\_s::ESP\_FLASH\_20MHZ (C++ enumerator), 1142  
 esp\_flash\_speed\_s::ESP\_FLASH\_26MHZ (C++ enumerator), 1142  
 esp\_flash\_speed\_s::ESP\_FLASH\_40MHZ (C++ enumerator), 1142



- esp\_flash\_speed\_s::ESP\_FLASH\_5MHZ  
 (C++ enumerator), 1142
- esp\_flash\_speed\_s::ESP\_FLASH\_80MHZ  
 (C++ enumerator), 1142
- esp\_flash\_speed\_s::ESP\_FLASH\_SPEED\_MAX  
 (C++ enumerator), 1142
- esp\_flash\_speed\_t (C++ type), 1141
- esp\_flash\_spi\_device\_config\_t (C++ struct), 1126
- esp\_flash\_spi\_device\_config\_t::cs\_id  
 (C++ member), 1126
- esp\_flash\_spi\_device\_config\_t::cs\_io\_num  
 (C++ member), 1126
- esp\_flash\_spi\_device\_config\_t::freq\_mhz  
 (C++ member), 1126
- esp\_flash\_spi\_device\_config\_t::host\_id  
 (C++ member), 1126
- esp\_flash\_spi\_device\_config\_t::input\_delay\_us  
 (C++ member), 1126
- esp\_flash\_spi\_device\_config\_t::io\_mode  
 (C++ member), 1126
- esp\_flash\_spi\_device\_config\_t::speed  
 (C++ member), 1126
- esp\_flash\_t (C++ struct), 1133
- esp\_flash\_t::busy (C++ member), 1134
- esp\_flash\_t::chip\_drv (C++ member), 1133
- esp\_flash\_t::chip\_id (C++ member), 1134
- esp\_flash\_t::host (C++ member), 1133
- esp\_flash\_t::hpm\_dummy\_ena (C++ member),  
 1134
- esp\_flash\_t::os\_func (C++ member), 1133
- esp\_flash\_t::os\_func\_data (C++ member),  
 1133
- esp\_flash\_t::read\_mode (C++ member), 1134
- esp\_flash\_t::reserved\_flags (C++ mem-  
 ber), 1134
- esp\_flash\_t::size (C++ member), 1134
- esp\_flash\_write (C++ function), 1131
- esp\_flash\_write\_encrypted (C++ function),  
 1131
- esp\_flash\_write\_protect\_crypt\_cnt  
 (C++ function), 1146
- esp\_freertos\_idle\_cb\_t (C++ type), 1919
- esp\_freertos\_tick\_cb\_t (C++ type), 1919
- ESP\_GAP\_BLE\_ADD\_WHITELIST\_COMPLETE\_EVT  
 (C macro), 226
- esp\_gap\_ble\_cb\_event\_t (C++ enum), 230
- esp\_gap\_ble\_cb\_event\_t::ESP\_GAP\_BLE\_ADD\_WHITE-  
 LIST\_COMPLETE\_EVT (C++ enumerator), 235
- esp\_gap\_ble\_cb\_event\_t::ESP\_GAP\_BLE\_ADV\_CLEAR-  
 COMPLETE\_EVT (C++ enumerator), 235
- esp\_gap\_ble\_cb\_event\_t::ESP\_GAP\_BLE\_ADV\_DATA-  
 PARAM\_SET\_COMPLETE\_EVT (C++ enumerator), 230
- esp\_gap\_ble\_cb\_event\_t::ESP\_GAP\_BLE\_ADV\_DATA-  
 SET\_COMPLETE\_EVT (C++ enumerator), 230
- esp\_gap\_ble\_cb\_event\_t::ESP\_GAP\_BLE\_ADV\_START-  
 COMPLETE\_EVT (C++ enumerator), 231
- esp\_gap\_ble\_cb\_event\_t::ESP\_GAP\_BLE\_ADV\_STOP-  
 COMPLETE\_EVT (C++ enumerator), 231
- esp\_gap\_ble\_cb\_event\_t::ESP\_FLASH\_WRITE-  
 COMPLETE\_EVT (C++ enumerator), 231
- esp\_gap\_ble\_cb\_event\_t::ESP\_FLASH\_WRITE-  
 ENCRYPTED\_COMPLETE\_EVT (C++ enumerator), 231
- esp\_gap\_ble\_cb\_event\_t::ESP\_FLASH\_WRITE-  
 PROTECT\_CRYPT\_CNT (C++ enumerator), 231
- esp\_gap\_ble\_cb\_event\_t::ESP\_GAP\_BLE\_ADV\_TERMINATE  
 (C++ enumerator), 234
- esp\_gap\_ble\_cb\_event\_t::ESP\_GAP\_BLE\_AUTH\_CMPL\_EVT  
 (C++ enumerator), 231
- esp\_gap\_ble\_cb\_event\_t::ESP\_GAP\_BLE\_CHANNEL\_SELEC  
 (C++ enumerator), 234
- esp\_gap\_ble\_cb\_event\_t::ESP\_GAP\_BLE\_CLEAR\_BOND\_DE  
 (C++ enumerator), 232
- esp\_gap\_ble\_cb\_event\_t::ESP\_GAP\_BLE\_DTM\_TEST\_UPDA  
 (C++ enumerator), 235
- esp\_gap\_ble\_cb\_event\_t::ESP\_GAP\_BLE\_EVT\_MAX  
 (C++ enumerator), 235
- esp\_gap\_ble\_cb\_event\_t::ESP\_GAP\_BLE\_EXT\_ADV\_DATA  
 (C++ enumerator), 232
- esp\_gap\_ble\_cb\_event\_t::ESP\_GAP\_BLE\_EXT\_ADV\_REPOR  
 (C++ enumerator), 234
- esp\_gap\_ble\_cb\_event\_t::ESP\_GAP\_BLE\_EXT\_ADV\_SET\_C  
 (C++ enumerator), 233
- esp\_gap\_ble\_cb\_event\_t::ESP\_GAP\_BLE\_EXT\_ADV\_SET\_P  
 (C++ enumerator), 232
- esp\_gap\_ble\_cb\_event\_t::ESP\_GAP\_BLE\_EXT\_ADV\_SET\_R  
 (C++ enumerator), 232
- esp\_gap\_ble\_cb\_event\_t::ESP\_GAP\_BLE\_EXT\_ADV\_SET\_R  
 (C++ enumerator), 233
- esp\_gap\_ble\_cb\_event\_t::ESP\_GAP\_BLE\_EXT\_ADV\_START  
 (C++ enumerator), 232
- esp\_gap\_ble\_cb\_event\_t::ESP\_GAP\_BLE\_EXT\_ADV\_STOP  
 (C++ enumerator), 233
- esp\_gap\_ble\_cb\_event\_t::ESP\_GAP\_BLE\_EXT\_SCAN\_RSP  
 (C++ enumerator), 232
- esp\_gap\_ble\_cb\_event\_t::ESP\_GAP\_BLE\_EXT\_SCAN\_STAR  
 (C++ enumerator), 233
- esp\_gap\_ble\_cb\_event\_t::ESP\_GAP\_BLE\_EXT\_SCAN\_STOP  
 (C++ enumerator), 233
- esp\_gap\_ble\_cb\_event\_t::ESP\_GAP\_BLE\_GET\_BOND\_DEV  
 (C++ enumerator), 232
- esp\_gap\_ble\_cb\_event\_t::ESP\_GAP\_BLE\_GET\_DEV\_NAME  
 (C++ enumerator), 234
- esp\_gap\_ble\_cb\_event\_t::ESP\_GAP\_BLE\_KEY\_EVT  
 (C++ enumerator), 231
- esp\_gap\_ble\_cb\_event\_t::ESP\_GAP\_BLE\_LOCAL\_ER\_EVT  
 (C++ enumerator), 231
- esp\_gap\_ble\_cb\_event\_t::ESP\_GAP\_BLE\_LOCAL\_IR\_EVT  
 (C++ enumerator), 231
- esp\_gap\_ble\_cb\_event\_t::ESP\_GAP\_BLE\_NC\_REQ\_EVT  
 (C++ enumerator), 231
- esp\_gap\_ble\_cb\_event\_t::ESP\_GAP\_BLE\_OOB\_REQ\_EVT  
 (C++ enumerator), 231
- esp\_gap\_ble\_cb\_event\_t::ESP\_GAP\_BLE\_PASSKEY\_NOTIF  
 (C++ enumerator), 231
- esp\_gap\_ble\_cb\_event\_t::ESP\_GAP\_BLE\_PASSKEY\_REQ\_E  
 (C++ enumerator), 231
- esp\_gap\_ble\_cb\_event\_t::ESP\_GAP\_BLE\_PERIODIC\_ADV  
 (C++ enumerator), 233
- esp\_gap\_ble\_cb\_event\_t::ESP\_GAP\_BLE\_PERIODIC\_ADV  
 (C++ enumerator), 233
- esp\_gap\_ble\_cb\_event\_t::ESP\_GAP\_BLE\_PERIODIC\_ADV  
 (C++ enumerator), 233

- (C++ *enumerator*), 233
- esp\_gap\_ble\_cb\_event\_t::ESP\_GAP\_BLE\_PERIODIC\_ADV\_DATA\_EVENT\_COMPLETE\_EVT (C++ *enumerator*), 231
- esp\_gap\_ble\_cb\_event\_t::ESP\_GAP\_BLE\_PERIODIC\_ADV\_ENABLE\_COMPLETE\_EVT (C++ *enumerator*), 232
- esp\_gap\_ble\_cb\_event\_t::ESP\_GAP\_BLE\_PERIODIC\_ADV\_REMOVE\_DEV\_COMPLETE\_EVT (C++ *enumerator*), 233
- esp\_gap\_ble\_cb\_event\_t::ESP\_GAP\_BLE\_PERIODIC\_ADV\_REMOVE\_EVT (C++ *enumerator*), 232
- esp\_gap\_ble\_cb\_event\_t::ESP\_GAP\_BLE\_PERIODIC\_ADV\_SETUP\_COMPLETE\_EVT (C++ *enumerator*), 232
- esp\_gap\_ble\_cb\_event\_t::ESP\_GAP\_BLE\_PERIODIC\_ADV\_SETUP\_FAILED\_EVT (C++ *enumerator*), 235
- esp\_gap\_ble\_cb\_event\_t::ESP\_GAP\_BLE\_PERIODIC\_ADV\_PARAMS\_COMPLETE\_EVT (C++ *enumerator*), 231
- esp\_gap\_ble\_cb\_event\_t::ESP\_GAP\_BLE\_PERIODIC\_ADV\_START\_COMPLETE\_EVT (C++ *enumerator*), 232
- esp\_gap\_ble\_cb\_event\_t::ESP\_GAP\_BLE\_PERIODIC\_ADV\_STOP\_COMPLETE\_EVT (C++ *enumerator*), 232
- esp\_gap\_ble\_cb\_event\_t::ESP\_GAP\_BLE\_PERIODIC\_ADV\_SYNC\_CANCEL\_COMPLETE\_EVT (C++ *enumerator*), 235
- esp\_gap\_ble\_cb\_event\_t::ESP\_GAP\_BLE\_PERIODIC\_ADV\_SYNC\_ESTAB\_EVT (C++ *enumerator*), 235
- esp\_gap\_ble\_cb\_event\_t::ESP\_GAP\_BLE\_PERIODIC\_ADV\_SYNC\_FAIL\_EVT (C++ *enumerator*), 231
- esp\_gap\_ble\_cb\_event\_t::ESP\_GAP\_BLE\_PERIODIC\_ADV\_SYNC\_TERMINATE\_COMPLETE\_EVT (C++ *enumerator*), 231
- esp\_gap\_ble\_cb\_event\_t::ESP\_GAP\_BLE\_PERIODIC\_ADV\_SYNC\_PARAMS\_COMPLETE\_EVT (C++ *enumerator*), 232
- esp\_gap\_ble\_cb\_event\_t::ESP\_GAP\_BLE\_PERIODIC\_ADV\_SYNC\_PARAMS\_RECEIVE\_EVT (C++ *enumerator*), 232
- esp\_gap\_ble\_cb\_event\_t::ESP\_GAP\_BLE\_PHY\_UPDATE\_COMPLETE\_EVT (C++ *enumerator*), 235
- esp\_gap\_ble\_cb\_event\_t::ESP\_GAP\_BLE\_PREPARE\_CONN\_PARAMS\_COMPLETE\_EVT (C++ *enumerator*), 234
- esp\_gap\_ble\_cb\_event\_t::ESP\_GAP\_BLE\_READ\_PHY\_COMPLETE\_EVT (C++ *enumerator*), 232
- esp\_gap\_ble\_cb\_event\_t::ESP\_GAP\_BLE\_READ\_RSSI\_COMPLETE\_EVT (C++ *enumerator*), 232
- esp\_gap\_ble\_cb\_event\_t::ESP\_GAP\_BLE\_REMOVE\_BOND\_DEV\_COMPLETE\_EVT (C++ *enumerator*), 232
- esp\_gap\_ble\_cb\_event\_t::ESP\_GAP\_BLE\_SC\_SCAN\_COMPLETE\_EVT (C++ *enumerator*), 234
- esp\_gap\_ble\_cb\_event\_t::ESP\_GAP\_BLE\_SC\_SCAN\_FAILED\_EVT (C++ *enumerator*), 234
- esp\_gap\_ble\_cb\_event\_t::ESP\_GAP\_BLE\_SCAN\_PARAM\_SET\_COMPLETE\_EVT (C++ *enumerator*), 230
- esp\_gap\_ble\_cb\_event\_t::ESP\_GAP\_BLE\_SCAN\_RESULT\_COMPLETE\_EVT (C++ *enumerator*), 242
- esp\_gap\_ble\_cb\_event\_t::ESP\_GAP\_BLE\_SCAN\_RSP\_FAIL\_COMPLETE\_EVT (C++ *enumerator*), 241
- esp\_gap\_ble\_cb\_event\_t::ESP\_GAP\_BLE\_SCAN\_RSP\_FAIL\_RETRY\_EVT (C++ *enumerator*), 241
- esp\_gap\_ble\_cb\_event\_t::ESP\_GAP\_BLE\_SCAN\_START\_COMPLETE\_EVT (C++ *enumerator*), 242
- esp\_gap\_ble\_cb\_event\_t::ESP\_GAP\_BLE\_SCAN\_STOP\_COMPLETE\_EVT (C++ *enumerator*), 242
- esp\_gap\_ble\_cb\_event\_t::ESP\_GAP\_BLE\_SCAN\_TIMEOUT\_EVT (C++ *enumerator*), 242
- esp\_gap\_ble\_cb\_event\_t::ESP\_GAP\_BLE\_SET\_LOCAL\_PRIVACY\_MASK\_COMPLETE\_EVT (C++ *enumerator*), 235
- esp\_gap\_ble\_cb\_event\_t::ESP\_GAP\_BLE\_SET\_LOCAL\_PRIVACY\_MASK\_FAILED\_EVT (C++ *enumerator*), 235
- esp\_gap\_ble\_cb\_event\_t::ESP\_GAP\_BLE\_SET\_STATIC\_RA\_ADDRESSES\_COMPLETE\_EVT (C++ *enumerator*), 231
- esp\_gap\_ble\_cb\_event\_t::ESP\_GAP\_BLE\_UPDATE\_CONN\_PARAMS\_COMPLETE\_EVT (C++ *enumerator*), 231
- esp\_gap\_ble\_cb\_event\_t::ESP\_GAP\_BLE\_UPDATE\_DUPLICATE\_PARAMS\_COMPLETE\_EVT (C++ *enumerator*), 232
- esp\_gap\_ble\_cb\_event\_t::ESP\_GAP\_BLE\_UPDATE\_WHITELIST\_COMPLETE\_EVT (C++ *enumerator*), 232
- esp\_gap\_ble\_cb\_event\_t::ESP\_GAP\_BLE\_VENDOR\_CMD\_CONFIRM\_COMPLETE\_EVT (C++ *enumerator*), 235
- esp\_gap\_ble\_channels (C++ *type*), 229
- esp\_gap\_ble\_set\_authorization (C++ *function*), 226
- esp\_gap\_ble\_set\_channels (C++ *function*), 226
- esp\_gap\_conn\_params\_t::interval (C++ *member*), 207
- esp\_gap\_conn\_params\_t::latency (C++ *member*), 207
- esp\_gap\_param\_set\_params\_timeout (C++ *member*), 207
- esp\_gap\_reserved\_evt (C++ *enum*), 242
- esp\_gap\_search\_evt\_t::ESP\_GAP\_SEARCH\_DI\_DISC\_CMPL\_EVT (C++ *enumerator*), 242
- esp\_gap\_search\_evt\_t::ESP\_GAP\_SEARCH\_DISC\_BLE\_RES\_EVT (C++ *enumerator*), 241
- esp\_gap\_search\_evt\_t::ESP\_GAP\_SEARCH\_DISC\_CMPL\_EVT (C++ *enumerator*), 241
- esp\_gap\_search\_evt\_t::ESP\_GAP\_SEARCH\_DISC\_RES\_EVT (C++ *enumerator*), 241
- esp\_gap\_search\_evt\_t::ESP\_GAP\_SEARCH\_INQ\_CMPL\_EVT (C++ *enumerator*), 242
- esp\_gap\_search\_evt\_t::ESP\_GAP\_SEARCH\_INQ\_DISCARD\_EVT (C++ *enumerator*), 242



- esp\_gatt\_rsp\_t (C++ union), 245  
 esp\_gatt\_rsp\_t::attr\_value (C++ member), 245  
 esp\_gatt\_rsp\_t::handle (C++ member), 245  
 esp\_gatt\_srvc\_id\_t (C++ struct), 245  
 esp\_gatt\_srvc\_id\_t::id (C++ member), 246  
 esp\_gatt\_srvc\_id\_t::is\_primary (C++ member), 246  
 esp\_gatt\_status\_t (C++ enum), 259  
 esp\_gatt\_status\_t::ESP\_GATT\_ALREADY\_OPEN (C++ enumerator), 261  
 esp\_gatt\_status\_t::ESP\_GATT\_APP\_RSP (C++ enumerator), 261  
 esp\_gatt\_status\_t::ESP\_GATT\_AUTH\_FAIL (C++ enumerator), 260  
 esp\_gatt\_status\_t::ESP\_GATT\_BUSY (C++ enumerator), 260  
 esp\_gatt\_status\_t::ESP\_GATT\_CANCEL (C++ enumerator), 261  
 esp\_gatt\_status\_t::ESP\_GATT\_CCC\_CFG\_ERROR (C++ enumerator), 261  
 esp\_gatt\_status\_t::ESP\_GATT\_CMD\_STARTED (C++ enumerator), 260  
 esp\_gatt\_status\_t::ESP\_GATT\_CONGESTED (C++ enumerator), 261  
 esp\_gatt\_status\_t::ESP\_GATT\_DB\_FULL (C++ enumerator), 260  
 esp\_gatt\_status\_t::ESP\_GATT\_DUP\_REG (C++ enumerator), 261  
 esp\_gatt\_status\_t::ESP\_GATT\_ENCRYPTED\_MSPM (C++ enumerator), 261  
 esp\_gatt\_status\_t::ESP\_GATT\_ENCRYPTED\_NSPM (C++ enumerator), 261  
 esp\_gatt\_status\_t::ESP\_GATT\_ERR\_UNLIKELY (C++ enumerator), 260  
 esp\_gatt\_status\_t::ESP\_GATT\_ERROR (C++ enumerator), 260  
 esp\_gatt\_status\_t::ESP\_GATT\_ILLEGAL\_PARAMETER (C++ enumerator), 260  
 esp\_gatt\_status\_t::ESP\_GATT\_INSUF\_AUTHENTICATION (C++ enumerator), 259  
 esp\_gatt\_status\_t::ESP\_GATT\_INSUF\_AUTHORIZATION (C++ enumerator), 259  
 esp\_gatt\_status\_t::ESP\_GATT\_INSUF\_ENCRYPTION (C++ enumerator), 260  
 esp\_gatt\_status\_t::ESP\_GATT\_INSUF\_KEY\_SIZE (C++ enumerator), 259  
 esp\_gatt\_status\_t::ESP\_GATT\_INSUF\_RESOURCE (C++ enumerator), 260  
 esp\_gatt\_status\_t::ESP\_GATT\_INTERNAL\_ERROR (C++ enumerator), 260  
 esp\_gatt\_status\_t::ESP\_GATT\_INVALID\_ATTRIBUTE (C++ enumerator), 260  
 esp\_gatt\_status\_t::ESP\_GATT\_INVALID\_CFG (C++ enumerator), 261  
 esp\_gatt\_status\_t::ESP\_GATT\_INVALID\_HANDLE (C++ enumerator), 259  
 esp\_gatt\_status\_t::ESP\_GATT\_INVALID\_OFFSET (C++ enumerator), 259  
 esp\_gatt\_status\_t::ESP\_GATT\_INVALID\_PDU (C++ enumerator), 259  
 esp\_gatt\_status\_t::ESP\_GATT\_MORE (C++ enumerator), 260  
 esp\_gatt\_status\_t::ESP\_GATT\_NO\_RESOURCES (C++ enumerator), 260  
 esp\_gatt\_status\_t::ESP\_GATT\_NOT\_ENCRYPTED (C++ enumerator), 261  
 esp\_gatt\_status\_t::ESP\_GATT\_NOT\_FOUND (C++ enumerator), 259  
 esp\_gatt\_status\_t::ESP\_GATT\_NOT\_LONG (C++ enumerator), 259  
 esp\_gatt\_status\_t::ESP\_GATT\_OK (C++ enumerator), 259  
 esp\_gatt\_status\_t::ESP\_GATT\_OUT\_OF\_RANGE (C++ enumerator), 261  
 esp\_gatt\_status\_t::ESP\_GATT\_PENDING (C++ enumerator), 260  
 esp\_gatt\_status\_t::ESP\_GATT\_PRC\_IN\_PROGRESS (C++ enumerator), 261  
 esp\_gatt\_status\_t::ESP\_GATT\_PREPARE\_Q\_FULL (C++ enumerator), 259  
 esp\_gatt\_status\_t::ESP\_GATT\_READ\_NOT\_PERMIT (C++ enumerator), 259  
 esp\_gatt\_status\_t::ESP\_GATT\_REQ\_NOT\_SUPPORTED (C++ enumerator), 259  
 esp\_gatt\_status\_t::ESP\_GATT\_SERVICE\_STARTED (C++ enumerator), 261  
 esp\_gatt\_status\_t::ESP\_GATT\_STACK\_RSP (C++ enumerator), 261  
 esp\_gatt\_status\_t::ESP\_GATT\_UNKNOWN\_ERROR (C++ enumerator), 261  
 esp\_gatt\_status\_t::ESP\_GATT\_UNSUPPORTED\_GRP\_TYPE (C++ enumerator), 260  
 esp\_gatt\_status\_t::ESP\_GATT\_WRITE\_NOT\_PERMIT (C++ enumerator), 259  
 esp\_gatt\_status\_t::ESP\_GATT\_WRONG\_STATE (C++ enumerator), 260  
 ESP\_GATT\_NOTIFICATION\_UID\_ALERT\_LEVEL (C macro), 254  
 ESP\_GATT\_NOTIFICATION\_UID\_ALERT\_NTF\_SVC (C macro), 251  
 ESP\_GATT\_NOTIFICATION\_UID\_ALERT\_STATUS (C macro), 254  
 ESP\_GATT\_NOTIFICATION\_UID\_Automation\_IO\_SVC (C macro), 252  
 ESP\_GATT\_NOTIFICATION\_UID\_BATTERY\_LEVEL (C macro), 256  
 ESP\_GATT\_NOTIFICATION\_UID\_BATTERY\_SERVICE\_SVC (C macro), 251  
 ESP\_GATT\_NOTIFICATION\_UID\_BLOOD\_PRESSURE\_SVC (C macro), 251  
 ESP\_GATT\_NOTIFICATION\_UID\_BODY\_COMPOSITION (C macro), 252  
 ESP\_GATT\_NOTIFICATION\_UID\_BOND\_MANAGEMENT\_SVC (C macro), 252  
 ESP\_GATT\_NOTIFICATION\_UID\_CHAR\_AGG\_FORMAT (C macro), 253  
 ESP\_GATT\_NOTIFICATION\_UID\_CHAR\_CLIENT\_CONFIG (C

- macro), 253
- ESP\_GATT\_UUID\_CHAR\_DECLARE (C macro), 252
- ESP\_GATT\_UUID\_CHAR\_DESCRIPTION (C macro), 253
- ESP\_GATT\_UUID\_CHAR\_EXT\_PROP (C macro), 253
- ESP\_GATT\_UUID\_CHAR\_PRESENT\_FORMAT (C macro), 253
- ESP\_GATT\_UUID\_CHAR\_SRV\_CONFIG (C macro), 253
- ESP\_GATT\_UUID\_CHAR\_VALID\_RANGE (C macro), 253
- ESP\_GATT\_UUID\_CONT\_GLUCOSE\_MONITOR\_SVC (C macro), 252
- ESP\_GATT\_UUID\_CSC\_FEATURE (C macro), 256
- ESP\_GATT\_UUID\_CSC\_MEASUREMENT (C macro), 256
- ESP\_GATT\_UUID\_CURRENT\_TIME (C macro), 254
- ESP\_GATT\_UUID\_CURRENT\_TIME\_SVC (C macro), 251
- ESP\_GATT\_UUID\_CYCLING\_POWER\_SVC (C macro), 252
- ESP\_GATT\_UUID\_CYCLING\_SPEED\_CADENCE\_SVC (C macro), 252
- ESP\_GATT\_UUID\_DEVICE\_INFO\_SVC (C macro), 251
- ESP\_GATT\_UUID\_ENV\_SENSING\_CONFIG\_DESCR (C macro), 253
- ESP\_GATT\_UUID\_ENV\_SENSING\_MEASUREMENT\_DESCR (C macro), 253
- ESP\_GATT\_UUID\_ENV\_SENSING\_TRIGGER\_DESCR (C macro), 253
- ESP\_GATT\_UUID\_ENVIRONMENTAL\_SENSING\_SVC (C macro), 252
- ESP\_GATT\_UUID\_EXT\_RPT\_REF\_DESCR (C macro), 253
- ESP\_GATT\_UUID\_FW\_VERSION\_STR (C macro), 255
- ESP\_GATT\_UUID\_GAP\_CENTRAL\_ADDR\_RESOL (C macro), 254
- ESP\_GATT\_UUID\_GAP\_DEVICE\_NAME (C macro), 253
- ESP\_GATT\_UUID\_GAP\_ICON (C macro), 254
- ESP\_GATT\_UUID\_GAP\_PREF\_CONN\_PARAM (C macro), 254
- ESP\_GATT\_UUID\_GATT\_SRV\_CHGD (C macro), 254
- ESP\_GATT\_UUID\_GLUCOSE\_SVC (C macro), 251
- ESP\_GATT\_UUID\_GM\_CONTEXT (C macro), 254
- ESP\_GATT\_UUID\_GM\_CONTROL\_POINT (C macro), 255
- ESP\_GATT\_UUID\_GM\_FEATURE (C macro), 255
- ESP\_GATT\_UUID\_GM\_MEASUREMENT (C macro), 254
- ESP\_GATT\_UUID\_HEALTH\_THERMOM\_SVC (C macro), 251
- ESP\_GATT\_UUID\_HEART\_RATE\_SVC (C macro), 251
- ESP\_GATT\_UUID\_HID\_BT\_KB\_INPUT (C macro), 256
- ESP\_GATT\_UUID\_HID\_BT\_KB\_OUTPUT (C macro), 256
- ESP\_GATT\_UUID\_HID\_BT\_MOUSE\_INPUT (C macro), 256
- ESP\_GATT\_UUID\_HID\_CONTROL\_POINT (C macro), 255
- ESP\_GATT\_UUID\_HID\_INFORMATION (C macro), 255
- ESP\_GATT\_UUID\_HID\_PROTO\_MODE (C macro), 255
- ESP\_GATT\_UUID\_HID\_REPORT (C macro), 255
- ESP\_GATT\_UUID\_HID\_REPORT\_MAP (C macro), 255
- ESP\_GATT\_UUID\_HID\_SVC (C macro), 251
- ESP\_GATT\_UUID\_HW\_VERSION\_STR (C macro), 255
- ESP\_GATT\_UUID\_IEEE\_DATA (C macro), 255
- ESP\_GATT\_UUID\_IMMEDIATE\_ALERT\_SVC (C macro), 251
- ESP\_GATT\_UUID\_INCLUDE\_SERVICE (C macro), 252
- ESP\_GATT\_UUID\_LINK\_LOSS\_SVC (C macro), 251
- ESP\_GATT\_UUID\_LOCAL\_TIME\_INFO (C macro), 254
- ESP\_GATT\_UUID\_LOCATION\_AND\_NAVIGATION\_SVC (C macro), 252
- ESP\_GATT\_UUID\_MANU\_NAME (C macro), 255
- ESP\_GATT\_UUID\_MODEL\_NUMBER\_STR (C macro), 255
- ESP\_GATT\_UUID\_NEXT\_DST\_CHANGE\_SVC (C macro), 251
- ESP\_GATT\_UUID\_NUM\_DIGITALS\_DESCR (C macro), 253
- ESP\_GATT\_UUID\_NW\_STATUS (C macro), 254
- ESP\_GATT\_UUID\_NW\_TRIGGER (C macro), 254
- ESP\_GATT\_UUID\_PHONE\_ALERT\_STATUS\_SVC (C macro), 251
- ESP\_GATT\_UUID\_PNP\_ID (C macro), 255
- ESP\_GATT\_UUID\_PRI\_SERVICE (C macro), 252
- ESP\_GATT\_UUID\_REF\_TIME\_INFO (C macro), 254
- ESP\_GATT\_UUID\_REF\_TIME\_UPDATE\_SVC (C macro), 251
- ESP\_GATT\_UUID\_RINGER\_CP (C macro), 254
- ESP\_GATT\_UUID\_RINGER\_SETTING (C macro), 254
- ESP\_GATT\_UUID\_RPT\_REF\_DESCR (C macro), 253
- ESP\_GATT\_UUID\_RSC\_FEATURE (C macro), 256
- ESP\_GATT\_UUID\_RSC\_MEASUREMENT (C macro), 256
- ESP\_GATT\_UUID\_RUNNING\_SPEED\_CADENCE\_SVC (C macro), 252
- ESP\_GATT\_UUID\_SC\_CONTROL\_POINT (C macro), 256



- ESP\_GATT\_UUID\_SCAN\_INT\_WINDOW (*C macro*), 256
- ESP\_GATT\_UUID\_SCAN\_PARAMETERS\_SVC (*C macro*), 252
- ESP\_GATT\_UUID\_SCAN\_REFRESH (*C macro*), 256
- ESP\_GATT\_UUID\_SEC\_SERVICE (*C macro*), 252
- ESP\_GATT\_UUID\_SENSOR\_LOCATION (*C macro*), 256
- ESP\_GATT\_UUID\_SERIAL\_NUMBER\_STR (*C macro*), 255
- ESP\_GATT\_UUID\_SW\_VERSION\_STR (*C macro*), 255
- ESP\_GATT\_UUID\_SYSTEM\_ID (*C macro*), 255
- ESP\_GATT\_UUID\_TIME\_TRIGGER\_DESCR (*C macro*), 253
- ESP\_GATT\_UUID\_TX\_POWER\_LEVEL (*C macro*), 254
- ESP\_GATT\_UUID\_TX\_POWER\_SVC (*C macro*), 251
- ESP\_GATT\_UUID\_USER\_DATA\_SVC (*C macro*), 252
- ESP\_GATT\_UUID\_VALUE\_TRIGGER\_DESCR (*C macro*), 253
- ESP\_GATT\_UUID\_WEIGHT\_SCALE\_SVC (*C macro*), 252
- esp\_gatt\_value\_t (*C++ struct*), 248
- esp\_gatt\_value\_t::auth\_req (*C++ member*), 248
- esp\_gatt\_value\_t::handle (*C++ member*), 248
- esp\_gatt\_value\_t::len (*C++ member*), 248
- esp\_gatt\_value\_t::offset (*C++ member*), 248
- esp\_gatt\_value\_t::value (*C++ member*), 248
- esp\_gatt\_write\_type\_t (*C++ enum*), 263
- esp\_gatt\_write\_type\_t::ESP\_GATT\_WRITE\_TYPE\_NO (*C++ enumerator*), 263
- esp\_gatt\_write\_type\_t::ESP\_GATT\_WRITE\_TYPE\_RSP (*C++ enumerator*), 263
- esp\_gattc\_cb\_event\_t (*C++ enum*), 295
- esp\_gattc\_cb\_event\_t::ESP\_GATTC\_ACL\_EVT (*C++ enumerator*), 296
- esp\_gattc\_cb\_event\_t::ESP\_GATTC\_ADV\_DATA\_EVT (*C++ enumerator*), 297
- esp\_gattc\_cb\_event\_t::ESP\_GATTC\_ADV\_VSC\_EVT (*C++ enumerator*), 297
- esp\_gattc\_cb\_event\_t::ESP\_GATTC\_BTH\_SCAN\_CFG\_EVT (*C++ enumerator*), 297
- esp\_gattc\_cb\_event\_t::ESP\_GATTC\_BTH\_SCAN\_DIS\_EVT (*C++ enumerator*), 297
- esp\_gattc\_cb\_event\_t::ESP\_GATTC\_BTH\_SCAN\_ENB\_EVT (*C++ enumerator*), 297
- esp\_gattc\_cb\_event\_t::ESP\_GATTC\_BTH\_SCAN\_PARAM\_EVT (*C++ enumerator*), 297
- esp\_gattc\_cb\_event\_t::ESP\_GATTC\_BTH\_SCAN\_RD\_EVT (*C++ enumerator*), 297
- esp\_gattc\_cb\_event\_t::ESP\_GATTC\_BTH\_SCAN\_THR\_EVT (*C++ enumerator*), 297
- esp\_gattc\_cb\_event\_t::ESP\_GATTC\_CANCEL\_OPEN\_EVT (*C++ enumerator*), 296
- esp\_gattc\_cb\_event\_t::ESP\_GATTC\_CFG\_MTU\_EVT (*C++ enumerator*), 296
- esp\_gattc\_cb\_event\_t::ESP\_GATTC\_CLOSE\_EVT (*C++ enumerator*), 296
- esp\_gattc\_cb\_event\_t::ESP\_GATTC\_CONGEST\_EVT (*C++ enumerator*), 297
- esp\_gattc\_cb\_event\_t::ESP\_GATTC\_CONNECT\_EVT (*C++ enumerator*), 298
- esp\_gattc\_cb\_event\_t::ESP\_GATTC\_DIS\_SRVC\_CMPL\_EVT (*C++ enumerator*), 298
- esp\_gattc\_cb\_event\_t::ESP\_GATTC\_DISCONNECT\_EVT (*C++ enumerator*), 298
- esp\_gattc\_cb\_event\_t::ESP\_GATTC\_ENC\_CMPL\_CB\_EVT (*C++ enumerator*), 296
- esp\_gattc\_cb\_event\_t::ESP\_GATTC\_EXEC\_EVT (*C++ enumerator*), 296
- esp\_gattc\_cb\_event\_t::ESP\_GATTC\_GET\_ADDR\_LIST\_EVT (*C++ enumerator*), 298
- esp\_gattc\_cb\_event\_t::ESP\_GATTC\_MULT\_ADV\_DATA\_EVT (*C++ enumerator*), 297
- esp\_gattc\_cb\_event\_t::ESP\_GATTC\_MULT\_ADV\_DIS\_EVT (*C++ enumerator*), 297
- esp\_gattc\_cb\_event\_t::ESP\_GATTC\_MULT\_ADV\_ENB\_EVT (*C++ enumerator*), 297
- esp\_gattc\_cb\_event\_t::ESP\_GATTC\_MULT\_ADV\_UPD\_EVT (*C++ enumerator*), 297
- esp\_gattc\_cb\_event\_t::ESP\_GATTC\_NOTIFY\_EVT (*C++ enumerator*), 296
- esp\_gattc\_cb\_event\_t::ESP\_GATTC\_OPEN\_EVT (*C++ enumerator*), 296
- esp\_gattc\_cb\_event\_t::ESP\_GATTC\_PREP\_WRITE\_EVT (*C++ enumerator*), 296
- esp\_gattc\_cb\_event\_t::ESP\_GATTC\_QUEUE\_FULL\_EVT (*C++ enumerator*), 298
- esp\_gattc\_cb\_event\_t::ESP\_GATTC\_READ\_CHAR\_EVT (*C++ enumerator*), 296
- esp\_gattc\_cb\_event\_t::ESP\_GATTC\_READ\_DESCR\_EVT (*C++ enumerator*), 296
- esp\_gattc\_cb\_event\_t::ESP\_GATTC\_READ\_MULTI\_VAR\_EVT (*C++ enumerator*), 298
- esp\_gattc\_cb\_event\_t::ESP\_GATTC\_READ\_MULTIPLE\_EVT (*C++ enumerator*), 298
- esp\_gattc\_cb\_event\_t::ESP\_GATTC\_REG\_EVT (*C++ enumerator*), 295
- esp\_gattc\_cb\_event\_t::ESP\_GATTC\_REG\_FOR\_NOTIFY\_EVT (*C++ enumerator*), 298
- esp\_gattc\_cb\_event\_t::ESP\_GATTC\_SCAN\_FLT\_CFG\_EVT (*C++ enumerator*), 297
- esp\_gattc\_cb\_event\_t::ESP\_GATTC\_SCAN\_FLT\_PARAM\_EVT (*C++ enumerator*), 297
- esp\_gattc\_cb\_event\_t::ESP\_GATTC\_SCAN\_FLT\_STATUS\_EVT (*C++ enumerator*), 297
- esp\_gattc\_cb\_event\_t::ESP\_GATTC\_SEARCH\_CMPL\_EVT (*C++ enumerator*), 296
- esp\_gattc\_cb\_event\_t::ESP\_GATTC\_SEARCH\_RES\_EVT (*C++ enumerator*), 296
- esp\_gattc\_cb\_event\_t::ESP\_GATTC\_SET\_ASSOC\_EVT (*C++ enumerator*), 296

- (C++ *enumerator*), 298
- esp\_gattc\_cb\_event\_t::ESP\_GATTC\_SRVC\_CHG\_EVT (*member*), 249  
(C++ *enumerator*), 296
- esp\_gattc\_cb\_event\_t::ESP\_GATTC\_UNREG\_EVT (*member*), 295  
(C++ *enumerator*), 295
- esp\_gattc\_cb\_event\_t::ESP\_GATTC\_UNREG\_EVT\_NOTIFY\_EVT (*member*), 247  
(C++ *member*), 247
- esp\_gattc\_cb\_event\_t::ESP\_GATTC\_WRITE\_CHAR\_EVT (*enum*), 277  
(C++ *enumerator*), 296
- esp\_gattc\_cb\_event\_t::ESP\_GATTC\_WRITE\_DESCR\_EVT (*enum*), 278  
(C++ *enumerator*), 296
- esp\_gattc\_cb\_t (C++ *type*), 295
- esp\_gattc\_char\_elem\_t (C++ *struct*), 249
- esp\_gattc\_char\_elem\_t::char\_handle (C++ *member*), 250
- esp\_gattc\_char\_elem\_t::properties (C++ *member*), 250
- esp\_gattc\_char\_elem\_t::uuid (C++ *member*), 250
- esp\_gattc\_db\_elem\_t (C++ *struct*), 249
- esp\_gattc\_db\_elem\_t::attribute\_handle (C++ *member*), 249
- esp\_gattc\_db\_elem\_t::end\_handle (C++ *member*), 249
- esp\_gattc\_db\_elem\_t::properties (C++ *member*), 249
- esp\_gattc\_db\_elem\_t::start\_handle (C++ *member*), 249
- esp\_gattc\_db\_elem\_t::type (C++ *member*), 249
- esp\_gattc\_db\_elem\_t::uuid (C++ *member*), 249
- esp\_gattc\_descr\_elem\_t (C++ *struct*), 250
- esp\_gattc\_descr\_elem\_t::handle (C++ *member*), 250
- esp\_gattc\_descr\_elem\_t::uuid (C++ *member*), 250
- esp\_gattc\_incl\_svc\_elem\_t (C++ *struct*), 250
- esp\_gattc\_incl\_svc\_elem\_t::handle (C++ *member*), 250
- esp\_gattc\_incl\_svc\_elem\_t::incl\_srvc\_elem\_handle (C++ *member*), 250
- esp\_gattc\_incl\_svc\_elem\_t::incl\_srvc\_elem\_handle (C++ *member*), 250
- esp\_gattc\_incl\_svc\_elem\_t::uuid (C++ *member*), 250
- esp\_gattc\_multi\_t (C++ *struct*), 248
- esp\_gattc\_multi\_t::handles (C++ *member*), 248
- esp\_gattc\_multi\_t::num\_attr (C++ *member*), 248
- esp\_gattc\_service\_elem\_t (C++ *struct*), 249
- esp\_gattc\_service\_elem\_t::end\_handle (C++ *member*), 249
- esp\_gattc\_service\_elem\_t::is\_primary (C++ *member*), 249
- esp\_gattc\_service\_elem\_t::start\_handle (C++ *member*), 249
- esp\_gatts\_attr\_db\_t (C++ *struct*), 246
- esp\_gatts\_attr\_db\_t::att\_desc (C++ *member*), 247
- esp\_gatts\_attr\_db\_t::attr\_control (C++ *member*), 247
- esp\_gatts\_cb\_event\_t (C++ *enum*), 277
- esp\_gatts\_cb\_event\_t::ESP\_GATTS\_ADD\_CHAR\_DESCR\_EVT (C++ *enumerator*), 278
- esp\_gatts\_cb\_event\_t::ESP\_GATTS\_ADD\_CHAR\_EVT (C++ *enumerator*), 278
- esp\_gatts\_cb\_event\_t::ESP\_GATTS\_ADD\_INCL\_SRVC\_EVT (C++ *enumerator*), 278
- esp\_gatts\_cb\_event\_t::ESP\_GATTS\_CANCEL\_OPEN\_EVT (C++ *enumerator*), 278
- esp\_gatts\_cb\_event\_t::ESP\_GATTS\_CLOSE\_EVT (C++ *enumerator*), 278
- esp\_gatts\_cb\_event\_t::ESP\_GATTS\_CONF\_EVT (C++ *enumerator*), 278
- esp\_gatts\_cb\_event\_t::ESP\_GATTS\_CONGEST\_EVT (C++ *enumerator*), 279
- esp\_gatts\_cb\_event\_t::ESP\_GATTS\_CONNECT\_EVT (C++ *enumerator*), 278
- esp\_gatts\_cb\_event\_t::ESP\_GATTS\_CREAT\_ATTR\_TAB\_EVT (C++ *enumerator*), 279
- esp\_gatts\_cb\_event\_t::ESP\_GATTS\_CREATE\_EVT (C++ *enumerator*), 278
- esp\_gatts\_cb\_event\_t::ESP\_GATTS\_DELETE\_EVT (C++ *enumerator*), 278
- esp\_gatts\_cb\_event\_t::ESP\_GATTS\_DISCONNECT\_EVT (C++ *enumerator*), 278
- esp\_gatts\_cb\_event\_t::ESP\_GATTS\_EXEC\_WRITE\_EVT (C++ *enumerator*), 277
- esp\_gatts\_cb\_event\_t::ESP\_GATTS\_LISTEN\_EVT (C++ *enumerator*), 278
- esp\_gatts\_cb\_event\_t::ESP\_GATTS\_MTU\_EVT (C++ *enumerator*), 278
- esp\_gatts\_cb\_event\_t::ESP\_GATTS\_OPEN\_EVT (C++ *enumerator*), 278
- esp\_gatts\_cb\_event\_t::ESP\_GATTS\_READ\_EVT (C++ *enumerator*), 277
- esp\_gatts\_cb\_event\_t::ESP\_GATTS\_REG\_EVT (C++ *enumerator*), 277
- esp\_gatts\_cb\_event\_t::ESP\_GATTS\_RESPONSE\_EVT (C++ *enumerator*), 279
- esp\_gatts\_cb\_event\_t::ESP\_GATTS\_SEND\_SERVICE\_CHANNEL\_EVT (C++ *enumerator*), 279
- esp\_gatts\_cb\_event\_t::ESP\_GATTS\_SET\_ATTR\_VAL\_EVT (C++ *enumerator*), 279
- esp\_gatts\_cb\_event\_t::ESP\_GATTS\_START\_EVT (C++ *enumerator*), 278
- esp\_gatts\_cb\_event\_t::ESP\_GATTS\_STOP\_EVT (C++ *enumerator*), 278
- esp\_gatts\_cb\_event\_t::ESP\_GATTS\_UNREG\_EVT (C++ *enumerator*), 278
- esp\_gatts\_cb\_event\_t::ESP\_GATTS\_WRITE\_EVT (C++ *enumerator*), 277

- esp\_gatts\_cb\_t (C++ type), 277  
 esp\_gatts\_incl128\_svc\_desc\_t (C++ struct), 247  
 esp\_gatts\_incl128\_svc\_desc\_t::end\_hdl (C++ member), 247  
 esp\_gatts\_incl128\_svc\_desc\_t::start\_hdl (C++ member), 247  
 esp\_gatts\_incl\_svc\_desc\_t (C++ struct), 247  
 esp\_gatts\_incl\_svc\_desc\_t::end\_hdl (C++ member), 247  
 esp\_gatts\_incl\_svc\_desc\_t::start\_hdl (C++ member), 247  
 esp\_gatts\_incl\_svc\_desc\_t::uuid (C++ member), 247  
 esp\_gcov\_dump (C++ function), 1710  
 esp\_get\_deep\_sleep\_wake\_stub (C++ function), 2034  
 esp\_get\_flash\_encryption\_mode (C++ function), 1146  
 esp\_get\_free\_heap\_size (C++ function), 1983  
 esp\_get\_free\_internal\_heap\_size (C++ function), 1983  
 esp\_get\_idf\_version (C++ function), 1985  
 esp\_get\_minimum\_free\_heap\_size (C++ function), 1983  
 ESP\_GOTO\_ON\_ERROR (C macro), 1759  
 ESP\_GOTO\_ON\_ERROR\_ISR (C macro), 1759  
 ESP\_GOTO\_ON\_FALSE (C macro), 1759  
 ESP\_GOTO\_ON\_FALSE\_ISR (C macro), 1759  
 esp\_hmac\_calculate (C++ function), 881  
 esp\_hmac\_jtag\_disable (C++ function), 881  
 esp\_hmac\_jtag\_enable (C++ function), 881  
 esp\_http\_client\_add\_auth (C++ function), 81  
 esp\_http\_client\_auth\_type\_t (C++ enum), 89  
 esp\_http\_client\_auth\_type\_t::HTTP\_AUTH\_TYPE\_BASIC (C++ enumerator), 89  
 esp\_http\_client\_auth\_type\_t::HTTP\_AUTH\_TYPE\_DIGEST (C++ enumerator), 89  
 esp\_http\_client\_auth\_type\_t::HTTP\_AUTH\_TYPE\_NONE (C++ enumerator), 89  
 esp\_http\_client\_cancel\_request (C++ function), 76  
 esp\_http\_client\_cleanup (C++ function), 80  
 esp\_http\_client\_close (C++ function), 80  
 esp\_http\_client\_config\_t (C++ struct), 83  
 esp\_http\_client\_config\_t::auth\_type (C++ member), 83  
 esp\_http\_client\_config\_t::buffer\_size (C++ member), 84  
 esp\_http\_client\_config\_t::buffer\_size\_timeout (C++ member), 85  
 esp\_http\_client\_config\_t::cert\_len (C++ member), 83  
 esp\_http\_client\_config\_t::cert\_pem (C++ member), 83  
 esp\_http\_client\_config\_t::client\_cert\_len (C++ member), 84  
 esp\_http\_client\_config\_t::client\_cert\_pem (C++ member), 84  
 esp\_http\_client\_config\_t::client\_key\_len (C++ member), 84  
 esp\_http\_client\_config\_t::client\_key\_password (C++ member), 84  
 esp\_http\_client\_config\_t::client\_key\_password\_len (C++ member), 84  
 esp\_http\_client\_config\_t::client\_key\_pem (C++ member), 84  
 esp\_http\_client\_config\_t::common\_name (C++ member), 85  
 esp\_http\_client\_config\_t::crt\_bundle\_attach (C++ member), 85  
 esp\_http\_client\_config\_t::disable\_auto\_redirect (C++ member), 84  
 esp\_http\_client\_config\_t::ds\_data (C++ member), 85  
 esp\_http\_client\_config\_t::event\_handler (C++ member), 84  
 esp\_http\_client\_config\_t::host (C++ member), 83  
 esp\_http\_client\_config\_t::if\_name (C++ member), 85  
 esp\_http\_client\_config\_t::is\_async (C++ member), 85  
 esp\_http\_client\_config\_t::keep\_alive\_count (C++ member), 85  
 esp\_http\_client\_config\_t::keep\_alive\_enable (C++ member), 85  
 esp\_http\_client\_config\_t::keep\_alive\_idle (C++ member), 85  
 esp\_http\_client\_config\_t::keep\_alive\_interval (C++ member), 85  
 esp\_http\_client\_config\_t::max\_authorization\_retries (C++ member), 84  
 esp\_http\_client\_config\_t::max\_redirection\_count (C++ member), 84  
 esp\_http\_client\_config\_t::method (C++ member), 84  
 esp\_http\_client\_config\_t::password (C++ member), 83  
 esp\_http\_client\_config\_t::path (C++ member), 83  
 esp\_http\_client\_config\_t::port (C++ member), 83  
 esp\_http\_client\_config\_t::query (C++ member), 83  
 esp\_http\_client\_config\_t::skip\_cert\_common\_name\_check (C++ member), 85  
 esp\_http\_client\_config\_t::timeout\_ms (C++ member), 84  
 esp\_http\_client\_config\_t::tls\_version (C++ member), 84  
 esp\_http\_client\_config\_t::transport\_type (C++ member), 84  
 esp\_http\_client\_config\_t::url (C++ member), 83



- esp\_http\_client\_config\_t::use\_global\_ca\_store [77](#)  
 (C++ member), [85](#)
- esp\_http\_client\_config\_t::user\_agent  
 (C++ member), [84](#)
- esp\_http\_client\_config\_t::user\_data  
 (C++ member), [85](#)
- esp\_http\_client\_config\_t::username  
 (C++ member), [83](#)
- esp\_http\_client\_delete\_header (C++ func-  
 tion), [78](#)
- esp\_http\_client\_event (C++ struct), [82](#)
- esp\_http\_client\_event::client (C++  
 member), [82](#)
- esp\_http\_client\_event::data (C++ mem-  
 ber), [82](#)
- esp\_http\_client\_event::data\_len (C++  
 member), [82](#)
- esp\_http\_client\_event::event\_id (C++  
 member), [82](#)
- esp\_http\_client\_event::header\_key  
 (C++ member), [82](#)
- esp\_http\_client\_event::header\_value  
 (C++ member), [82](#)
- esp\_http\_client\_event::user\_data (C++  
 member), [82](#)
- esp\_http\_client\_event\_handle\_t (C++  
 type), [86](#)
- esp\_http\_client\_event\_id\_t (C++ enum), [86](#)
- esp\_http\_client\_event\_id\_t::HTTP\_EVENT\_DISCONNECTED  
 (C++ enumerator), [87](#)
- esp\_http\_client\_event\_id\_t::HTTP\_EVENT\_ERROR  
 (C++ enumerator), [86](#)
- esp\_http\_client\_event\_id\_t::HTTP\_EVENT\_HEADER\_SENT  
 (C++ enumerator), [87](#)
- esp\_http\_client\_event\_id\_t::HTTP\_EVENT\_HEADERS\_SENT  
 (C++ enumerator), [87](#)
- esp\_http\_client\_event\_id\_t::HTTP\_EVENT\_ON\_CONNECTED  
 (C++ enumerator), [86](#)
- esp\_http\_client\_event\_id\_t::HTTP\_EVENT\_ON\_DATA  
 (C++ enumerator), [87](#)
- esp\_http\_client\_event\_id\_t::HTTP\_EVENT\_ON\_FINISH  
 (C++ enumerator), [87](#)
- esp\_http\_client\_event\_id\_t::HTTP\_EVENT\_ON\_HEADERS\_SENT  
 (C++ enumerator), [87](#)
- esp\_http\_client\_event\_id\_t::HTTP\_EVENT\_REDIRECTED  
 (C++ enumerator), [87](#)
- esp\_http\_client\_event\_t (C++ type), [86](#)
- esp\_http\_client\_fetch\_headers (C++ func-  
 tion), [79](#)
- esp\_http\_client\_flush\_response (C++  
 function), [81](#)
- esp\_http\_client\_get\_chunk\_length (C++  
 function), [82](#)
- esp\_http\_client\_get\_content\_length  
 (C++ function), [80](#)
- esp\_http\_client\_get\_errno (C++ function),  
[78](#)
- esp\_http\_client\_get\_header (C++ function),  
[77](#)
- esp\_http\_client\_get\_password (C++ func-  
 tion), [77](#)
- esp\_http\_client\_get\_post\_field (C++  
 function), [76](#)
- esp\_http\_client\_get\_status\_code (C++  
 function), [79](#)
- esp\_http\_client\_get\_transport\_type  
 (C++ function), [80](#)
- esp\_http\_client\_get\_url (C++ function), [81](#)
- esp\_http\_client\_get\_user\_data (C++ func-  
 tion), [78](#)
- esp\_http\_client\_get\_username (C++ func-  
 tion), [77](#)
- esp\_http\_client\_handle\_t (C++ type), [86](#)
- esp\_http\_client\_init (C++ function), [75](#)
- esp\_http\_client\_is\_chunked\_response  
 (C++ function), [79](#)
- esp\_http\_client\_is\_complete\_data\_received  
 (C++ function), [81](#)
- esp\_http\_client\_method\_t (C++ enum), [87](#)
- esp\_http\_client\_method\_t::HTTP\_METHOD\_COPY  
 (C++ enumerator), [88](#)
- esp\_http\_client\_method\_t::HTTP\_METHOD\_DELETE  
 (C++ enumerator), [88](#)
- esp\_http\_client\_method\_t::HTTP\_METHOD\_GET  
 (C++ enumerator), [88](#)
- esp\_http\_client\_method\_t::HTTP\_METHOD\_HEAD  
 (C++ enumerator), [88](#)
- esp\_http\_client\_method\_t::HTTP\_METHOD\_LOCK  
 (C++ enumerator), [88](#)
- esp\_http\_client\_method\_t::HTTP\_METHOD\_MAX  
 (C++ enumerator), [89](#)
- esp\_http\_client\_method\_t::HTTP\_METHOD\_MKCOL  
 (C++ enumerator), [89](#)
- esp\_http\_client\_method\_t::HTTP\_METHOD\_MOVE  
 (C++ enumerator), [88](#)
- esp\_http\_client\_method\_t::HTTP\_METHOD\_NOTIFY  
 (C++ enumerator), [88](#)
- esp\_http\_client\_method\_t::HTTP\_METHOD\_OPTIONS  
 (C++ enumerator), [88](#)
- esp\_http\_client\_method\_t::HTTP\_METHOD\_PATCH  
 (C++ enumerator), [88](#)
- esp\_http\_client\_method\_t::HTTP\_METHOD\_POST  
 (C++ enumerator), [88](#)
- esp\_http\_client\_method\_t::HTTP\_METHOD\_PROPFIND  
 (C++ enumerator), [88](#)
- esp\_http\_client\_method\_t::HTTP\_METHOD\_PROPPATCH  
 (C++ enumerator), [88](#)
- esp\_http\_client\_method\_t::HTTP\_METHOD\_PUT  
 (C++ enumerator), [88](#)
- esp\_http\_client\_method\_t::HTTP\_METHOD\_SUBSCRIBE  
 (C++ enumerator), [88](#)
- esp\_http\_client\_method\_t::HTTP\_METHOD\_UNLOCK  
 (C++ enumerator), [88](#)
- esp\_http\_client\_method\_t::HTTP\_METHOD\_UNSUBSCRIBE  
 (C++ enumerator), [88](#)
- esp\_http\_client\_on\_data (C++ struct), [82](#)



- esp\_https\_ota\_event\_t::ESP\_HTTPS\_OTA\_UPDATE\_BLOCK\_PARAMETER (C++ enumerator), 1704
- esp\_https\_ota\_event\_t::ESP\_HTTPS\_OTA\_VERIFY\_CHECK (C++ enumerator), 1704
- esp\_https\_ota\_event\_t::ESP\_HTTPS\_OTA\_WRITE\_FLASH (C++ enumerator), 1704
- esp\_https\_ota\_finish (C++ function), 1766
- esp\_https\_ota\_get\_image\_len\_read (C++ function), 1767
- esp\_https\_ota\_get\_image\_size (C++ function), 1767
- esp\_https\_ota\_get\_img\_desc (C++ function), 1766
- esp\_https\_ota\_handle\_t (C++ type), 1768
- esp\_https\_ota\_is\_complete\_data\_received (C++ function), 1765
- esp\_https\_ota\_perform (C++ function), 1765
- esp\_https\_server\_event\_id\_t (C++ enum), 148
- esp\_https\_server\_event\_id\_t::HTTPS\_SERVER\_EVENT\_DISCONNECTED (C++ enumerator), 148
- esp\_https\_server\_event\_id\_t::HTTPS\_SERVER\_EVENT\_ERROR (C++ enumerator), 148
- esp\_https\_server\_event\_id\_t::HTTPS\_SERVER\_EVENT\_CONNECTED (C++ enumerator), 148
- esp\_https\_server\_event\_id\_t::HTTPS\_SERVER\_EVENT\_DATA (C++ enumerator), 148
- esp\_https\_server\_event\_id\_t::HTTPS\_SERVER\_EVENT\_START (C++ enumerator), 148
- esp\_https\_server\_event\_id\_t::HTTPS\_SERVER\_EVENT\_STOP (C++ enumerator), 148
- esp\_https\_server\_last\_error\_t (C++ type), 148
- esp\_https\_server\_user\_cb (C++ type), 148
- esp\_https\_server\_user\_cb\_arg (C++ struct), 146
- esp\_https\_server\_user\_cb\_arg::tls (C++ member), 146
- esp\_https\_server\_user\_cb\_arg::user\_cb\_state (C++ member), 146
- esp\_https\_server\_user\_cb\_arg\_t (C++ type), 148
- ESP\_IDF\_VERSION (C macro), 1985
- ESP\_IDF\_VERSION\_MAJOR (C macro), 1985
- ESP\_IDF\_VERSION\_MINOR (C macro), 1985
- ESP\_IDF\_VERSION\_PATCH (C macro), 1985
- ESP\_IDF\_VERSION\_VAL (C macro), 1985
- esp\_iface\_mac\_addr\_set (C++ function), 1987
- esp\_image\_flash\_size\_t (C++ enum), 1703
- esp\_image\_flash\_size\_t::ESP\_IMAGE\_FLASH\_SIZE\_32MB (C++ enumerator), 1704
- esp\_image\_flash\_size\_t::ESP\_IMAGE\_FLASH\_SIZE\_4MB (C++ enumerator), 1704
- esp\_image\_flash\_size\_t::ESP\_IMAGE\_FLASH\_SIZE\_64MB (C++ enumerator), 1704
- esp\_image\_flash\_size\_t::ESP\_IMAGE\_FLASH\_SIZE\_8MB (C++ enumerator), 1704
- esp\_image\_flash\_size\_t::ESP\_IMAGE\_FLASH\_SIZE\_MAX (C++ enumerator), 1704
- ESP\_IMAGE\_HEADER\_MAGIC (C macro), 1702
- esp\_image\_header\_t (C++ struct), 1701
- esp\_image\_header\_t::chip\_id (C++ member), 1701
- esp\_image\_header\_t::entry\_addr (C++ member), 1701
- esp\_image\_header\_t::hash\_appended (C++ member), 1702
- ESP\_IMAGE\_MAGIC (C macro), 1701
- esp\_image\_header\_t::max\_chip\_rev\_full (C++ member), 1701
- esp\_image\_header\_t::min\_chip\_rev (C++ member), 1701
- ESP\_IMAGE\_ONE\_DATA (C macro), 1701
- esp\_image\_header\_t::min\_chip\_rev\_full (C++ member), 1701
- ESP\_IMAGE\_START\_DATA (C macro), 1701
- esp\_image\_header\_t::reserved (C++ member), 1701
- ESP\_IMAGE\_STOP (C macro), 1701
- esp\_image\_header\_t::segment\_count (C++ member), 1701
- esp\_image\_header\_t::spi\_mode (C++ member), 1701
- esp\_image\_header\_t::spi\_pin\_drv (C++ member), 1701
- esp\_image\_header\_t::spi\_size (C++ member), 1701
- esp\_image\_header\_t::spi\_speed (C++ member), 1701
- esp\_image\_header\_t::wp\_pin (C++ member), 1701
- ESP\_IMAGE\_MAX\_SEGMENTS (C macro), 1702
- esp\_image\_segment\_header\_t (C++ struct), 1702
- esp\_image\_segment\_header\_t::data\_len (C++ member), 1702
- esp\_image\_segment\_header\_t::load\_addr (C++ member), 1702
- esp\_image\_spi\_freq\_t (C++ enum), 1703
- esp\_image\_spi\_freq\_t::ESP\_IMAGE\_SPI\_SPEED\_DIV\_1 (C++ enumerator), 1703
- esp\_image\_spi\_freq\_t::ESP\_IMAGE\_SPI\_SPEED\_DIV\_2 (C++ enumerator), 1703
- esp\_image\_spi\_freq\_t::ESP\_IMAGE\_SPI\_SPEED\_DIV\_3 (C++ enumerator), 1703
- esp\_image\_spi\_freq\_t::ESP\_IMAGE\_SPI\_SPEED\_DIV\_4 (C++ enumerator), 1703
- esp\_image\_spi\_freq\_t::ESP\_IMAGE\_SPI\_SPEED\_DIV\_8 (C++ enumerator), 1703
- esp\_image\_spi\_mode\_t (C++ enum), 1703

- esp\_image\_spi\_mode\_t::ESP\_IMAGE\_SPI\_MODE\_DISABLE (C++ enumerator), 1703  
 esp\_image\_spi\_mode\_t::ESP\_IMAGE\_SPI\_MODE\_FAST\_READ (C++ enumerator), 1703  
 esp\_image\_spi\_mode\_t::ESP\_IMAGE\_SPI\_MODE\_SLOW\_READ (C++ enumerator), 1703  
 esp\_image\_spi\_mode\_t::ESP\_IMAGE\_SPI\_MODE\_WRITE (C++ enumerator), 1703  
 esp\_image\_spi\_mode\_t::ESP\_IMAGE\_SPI\_MODE\_READ (C++ enumerator), 1703  
 esp\_intr\_alloc (C++ function), 1968  
 esp\_intr\_alloc\_intrstatus (C++ function), 1968  
 esp\_intr\_cpu\_affinity\_t (C++ enum), 1967  
 esp\_intr\_cpu\_affinity\_t::ESP\_INTR\_CPU\_AFFINITY\_0 (C++ enumerator), 1967  
 esp\_intr\_cpu\_affinity\_t::ESP\_INTR\_CPU\_AFFINITY\_1 (C++ enumerator), 1967  
 esp\_intr\_cpu\_affinity\_t::ESP\_INTR\_CPU\_AFFINITY\_2 (C++ enumerator), 1967  
 ESP\_INTR\_CPU\_AFFINITY\_TO\_CORE\_ID (C macro), 1967  
 ESP\_INTR\_DISABLE (C macro), 1972  
 esp\_intr\_disable (C++ function), 1969  
 esp\_intr\_disable\_source (C++ function), 1970  
 esp\_intr\_dump (C++ function), 1970  
 ESP\_INTR\_ENABLE (C macro), 1972  
 esp\_intr\_enable (C++ function), 1969  
 esp\_intr\_enable\_source (C++ function), 1970  
 ESP\_INTR\_FLAG\_EDGE (C macro), 1971  
 ESP\_INTR\_FLAG\_HIGH (C macro), 1971  
 ESP\_INTR\_FLAG\_INTRDISABLED (C macro), 1971  
 ESP\_INTR\_FLAG\_IRAM (C macro), 1971  
 ESP\_INTR\_FLAG\_LEVEL1 (C macro), 1970  
 ESP\_INTR\_FLAG\_LEVEL2 (C macro), 1970  
 ESP\_INTR\_FLAG\_LEVEL3 (C macro), 1970  
 ESP\_INTR\_FLAG\_LEVEL4 (C macro), 1970  
 ESP\_INTR\_FLAG\_LEVEL5 (C macro), 1970  
 ESP\_INTR\_FLAG\_LEVEL6 (C macro), 1971  
 ESP\_INTR\_FLAG\_LEVELMASK (C macro), 1971  
 ESP\_INTR\_FLAG\_LOWMED (C macro), 1971  
 ESP\_INTR\_FLAG\_NMI (C macro), 1971  
 ESP\_INTR\_FLAG\_SHARED (C macro), 1971  
 esp\_intr\_flags\_to\_level (C++ function), 1970  
 esp\_intr\_free (C++ function), 1969  
 esp\_intr\_get\_cpu (C++ function), 1969  
 esp\_intr\_get\_intno (C++ function), 1969  
 esp\_intr\_level\_to\_flags (C++ function), 1970  
 esp\_intr\_mark\_shared (C++ function), 1967  
 esp\_intr\_noniram\_disable (C++ function), 1970  
 esp\_intr\_noniram\_enable (C++ function), 1970  
 esp\_intr\_reserve (C++ function), 1967  
 esp\_intr\_set\_in\_iram (C++ function), 1969  
 ESP\_OUT\_CAP\_IN (C macro), 221  
 ESP\_IO\_CAP\_IO (C macro), 221  
 ESP\_FAST\_CAP\_KBDISP (C macro), 221  
 ESP\_IO\_CAP\_NONE (C macro), 221  
 ESP\_IO\_CAP\_OUT (C macro), 221  
 esp\_ip4\_addr (C++ struct), 775  
 ESP\_IP4\_ADDR1 (C macro), 776  
 esp\_ip4\_addr1\_16 (C macro), 776  
 ESP\_IP4\_ADDR2 (C macro), 776  
 esp\_ip4\_addr2\_16 (C macro), 776  
 esp\_ip4\_addr3 (C macro), 776  
 esp\_ip4\_addr3\_16 (C macro), 776  
 esp\_ip4\_addr4 (C macro), 776  
 esp\_ip4\_addr4\_16 (C macro), 776  
 esp\_ip4\_addr::addr (C++ member), 775  
 esp\_ip4\_addr\_get\_byte (C macro), 776  
 esp\_ip4\_addr\_t (C++ type), 777  
 esp\_ip4addr\_aton (C++ function), 762  
 ESP\_IP4ADDR\_INIT (C macro), 777  
 esp\_ip4addr\_ntoa (C++ function), 762  
 ESP\_IP4TOADDR (C macro), 777  
 ESP\_IP4TOUINT32 (C macro), 777  
 esp\_ip6\_addr (C++ struct), 775  
 esp\_ip6\_addr::addr (C++ member), 775  
 esp\_ip6\_addr::zone (C++ member), 775  
 ESP\_IP6\_ADDR\_BLOCK1 (C macro), 776  
 ESP\_IP6\_ADDR\_BLOCK2 (C macro), 776  
 ESP\_IP6\_ADDR\_BLOCK3 (C macro), 776  
 ESP\_IP6\_ADDR\_BLOCK4 (C macro), 776  
 ESP\_IP6\_ADDR\_BLOCK5 (C macro), 776  
 ESP\_IP6\_ADDR\_BLOCK6 (C macro), 776  
 ESP\_IP6\_ADDR\_BLOCK7 (C macro), 776  
 ESP\_IP6\_ADDR\_BLOCK8 (C macro), 776  
 esp\_ip6\_addr\_t (C++ type), 777  
 esp\_ip6\_addr\_type\_t (C++ enum), 777  
 esp\_ip6\_addr\_type\_t::ESP\_IP6\_ADDR\_IS\_GLOBAL (C++ enumerator), 777  
 esp\_ip6\_addr\_type\_t::ESP\_IP6\_ADDR\_IS\_IPV4\_MAPPED (C++ enumerator), 777  
 esp\_ip6\_addr\_type\_t::ESP\_IP6\_ADDR\_IS\_LINK\_LOCAL (C++ enumerator), 777  
 esp\_ip6\_addr\_type\_t::ESP\_IP6\_ADDR\_IS\_SITE\_LOCAL (C++ enumerator), 777  
 esp\_ip6\_addr\_type\_t::ESP\_IP6\_ADDR\_IS\_UNIQUE\_LOCAL (C++ enumerator), 777  
 esp\_ip6\_addr\_type\_t::ESP\_IP6\_ADDR\_IS\_UNKNOWN (C++ enumerator), 777  
 ESP\_IP6ADDR\_INIT (C macro), 777  
 esp\_ip\_addr\_t (C++ type), 777  
 ESP\_IP\_IS\_ANY (C macro), 777  
 ESP\_IPADDR\_TYPE\_ANY (C macro), 777  
 ESP\_IPADDR\_TYPE\_V4 (C macro), 777  
 ESP\_IPADDR\_TYPE\_V6 (C macro), 777  
 esp\_lcd\_i2c\_bus\_handle\_t (C++ type), 961  
 esp\_lcd\_new\_panel\_io\_i2c (C macro), 961

- esp\_lcd\_new\_panel\_io\_i2c\_v1 (C++ function), 959  
 esp\_lcd\_new\_panel\_io\_i2c\_v2 (C++ function), 960  
 esp\_lcd\_new\_panel\_io\_spi (C++ function), 956  
 esp\_lcd\_panel\_del (C++ function), 968  
 esp\_lcd\_panel\_disp\_off (C++ function), 969  
 esp\_lcd\_panel\_disp\_on\_off (C++ function), 969  
 esp\_lcd\_panel\_disp\_sleep (C++ function), 969  
 esp\_lcd\_panel\_draw\_bitmap (C++ function), 968  
 esp\_lcd\_panel\_handle\_t (C++ type), 965  
 esp\_lcd\_panel\_init (C++ function), 967  
 esp\_lcd\_panel\_invert\_color (C++ function), 969  
 esp\_lcd\_panel\_io\_callbacks\_t (C++ struct), 964  
 esp\_lcd\_panel\_io\_callbacks\_t::on\_color\_trans\_done (C++ member), 965  
 esp\_lcd\_panel\_io\_color\_trans\_done\_cb\_t (C++ type), 965  
 esp\_lcd\_panel\_io\_del (C++ function), 967  
 esp\_lcd\_panel\_io\_event\_data\_t (C++ struct), 964  
 esp\_lcd\_panel\_io\_handle\_t (C++ type), 965  
 esp\_lcd\_panel\_io\_i2c\_config\_t (C++ struct), 960  
 esp\_lcd\_panel\_io\_i2c\_config\_t::control\_byte (C++ member), 960  
 esp\_lcd\_panel\_io\_i2c\_config\_t::dc\_bit\_offset (C++ member), 960  
 esp\_lcd\_panel\_io\_i2c\_config\_t::dc\_low\_on\_data (C++ member), 960  
 esp\_lcd\_panel\_io\_i2c\_config\_t::dev\_address (C++ member), 960  
 esp\_lcd\_panel\_io\_i2c\_config\_t::disable\_control\_phase (C++ member), 960  
 esp\_lcd\_panel\_io\_i2c\_config\_t::flags (C++ member), 961  
 esp\_lcd\_panel\_io\_i2c\_config\_t::lcd\_cmd\_bits (C++ member), 960  
 esp\_lcd\_panel\_io\_i2c\_config\_t::lcd\_param\_bits (C++ member), 960  
 esp\_lcd\_panel\_io\_i2c\_config\_t::on\_color\_trans\_done (C++ member), 960  
 esp\_lcd\_panel\_io\_i2c\_config\_t::scl\_speed\_hz (C++ member), 961  
 esp\_lcd\_panel\_io\_i2c\_config\_t::user\_ctx (C++ member), 960  
 esp\_lcd\_panel\_io\_register\_event\_callbacks (C++ function), 967  
 esp\_lcd\_panel\_io\_rx\_param (C++ function), 966  
 esp\_lcd\_panel\_io\_spi\_config\_t (C++ struct), 957  
 esp\_lcd\_panel\_io\_spi\_config\_t::cs\_gpio\_num (C++ member), 957  
 esp\_lcd\_panel\_io\_spi\_config\_t::cs\_high\_active (C++ member), 958  
 esp\_lcd\_panel\_io\_spi\_config\_t::dc\_gpio\_num (C++ member), 957  
 esp\_lcd\_panel\_io\_spi\_config\_t::dc\_high\_on\_cmd (C++ member), 957  
 esp\_lcd\_panel\_io\_spi\_config\_t::dc\_low\_on\_data (C++ member), 957  
 esp\_lcd\_panel\_io\_spi\_config\_t::dc\_low\_on\_param (C++ member), 957  
 esp\_lcd\_panel\_io\_spi\_config\_t::flags (C++ member), 958  
 esp\_lcd\_panel\_io\_spi\_config\_t::lcd\_cmd\_bits (C++ member), 957  
 esp\_lcd\_panel\_io\_spi\_config\_t::lcd\_param\_bits (C++ member), 957  
 esp\_lcd\_panel\_io\_spi\_config\_t::lsb\_first (C++ member), 958  
 esp\_lcd\_panel\_io\_spi\_config\_t::octal\_mode (C++ member), 957  
 esp\_lcd\_panel\_io\_spi\_config\_t::on\_color\_trans\_done (C++ member), 957  
 esp\_lcd\_panel\_io\_spi\_config\_t::pclk\_hz (C++ member), 957  
 esp\_lcd\_panel\_io\_spi\_config\_t::quad\_mode (C++ member), 958  
 esp\_lcd\_panel\_io\_spi\_config\_t::sio\_mode (C++ member), 958  
 esp\_lcd\_panel\_io\_spi\_config\_t::spi\_mode (C++ member), 957  
 esp\_lcd\_panel\_io\_spi\_config\_t::trans\_queue\_depth (C++ member), 957  
 esp\_lcd\_panel\_io\_spi\_config\_t::user\_ctx (C++ member), 957  
 esp\_lcd\_panel\_io\_tx\_color (C++ function), 966  
 esp\_lcd\_panel\_io\_tx\_param (C++ function), 966  
 esp\_lcd\_panel\_mirror (C++ function), 968  
 esp\_lcd\_panel\_reset (C++ function), 967  
 esp\_lcd\_panel\_set\_gap (C++ function), 969  
 esp\_lcd\_panel\_swap\_xy (C++ function), 968  
 esp\_lcd\_spi\_bus\_handle\_t (C++ type), 958  
 esp\_lcd\_video\_timing\_t (C++ struct), 964  
 esp\_lcd\_video\_timing\_t::h\_size (C++ member), 964  
 esp\_lcd\_video\_timing\_t::hsync\_back\_porch (C++ member), 964  
 esp\_lcd\_video\_timing\_t::hsync\_front\_porch (C++ member), 964  
 esp\_lcd\_video\_timing\_t::hsync\_pulse\_width (C++ member), 964  
 esp\_lcd\_video\_timing\_t::v\_size (C++ member), 964  
 esp\_lcd\_video\_timing\_t::vsync\_back\_porch (C++ member), 964



- esp\_lcd\_video\_timing\_t::vsync\_front\_polarity (C++ member), 964  
 esp\_lcd\_video\_timing\_t::vsync\_pulse\_width (C++ member), 964  
 ESP\_LE\_AUTH\_BOND (C macro), 220  
 ESP\_LE\_AUTH\_NO\_BOND (C macro), 220  
 ESP\_LE\_AUTH\_REQ\_BOND\_MITM (C macro), 220  
 ESP\_LE\_AUTH\_REQ\_MITM (C macro), 220  
 ESP\_LE\_AUTH\_REQ\_SC\_BOND (C macro), 221  
 ESP\_LE\_AUTH\_REQ\_SC\_MITM (C macro), 221  
 ESP\_LE\_AUTH\_REQ\_SC\_MITM\_BOND (C macro), 221  
 ESP\_LE\_AUTH\_REQ\_SC\_ONLY (C macro), 220  
 ESP\_LE\_KEY\_LCSRK (C macro), 220  
 ESP\_LE\_KEY\_LENC (C macro), 220  
 ESP\_LE\_KEY\_LID (C macro), 220  
 ESP\_LE\_KEY\_LLK (C macro), 220  
 ESP\_LE\_KEY\_NONE (C macro), 220  
 ESP\_LE\_KEY\_PCSRK (C macro), 220  
 ESP\_LE\_KEY\_PENC (C macro), 220  
 ESP\_LE\_KEY\_PID (C macro), 220  
 ESP\_LE\_KEY\_PLK (C macro), 220  
 esp\_light\_sleep\_start (C++ function), 2033  
 esp\_link\_key (C++ type), 159  
 esp\_local\_ctrl\_add\_property (C++ function), 94  
 esp\_local\_ctrl\_config (C++ struct), 97  
 esp\_local\_ctrl\_config::handlers (C++ member), 98  
 esp\_local\_ctrl\_config::max\_properties (C++ member), 98  
 esp\_local\_ctrl\_config::proto\_sec (C++ member), 98  
 esp\_local\_ctrl\_config::transport (C++ member), 98  
 esp\_local\_ctrl\_config::transport\_config (C++ member), 98  
 esp\_local\_ctrl\_config\_t (C++ type), 99  
 esp\_local\_ctrl\_get\_property (C++ function), 94  
 esp\_local\_ctrl\_get\_transport\_ble (C++ function), 93  
 esp\_local\_ctrl\_get\_transport\_httpd (C++ function), 93  
 esp\_local\_ctrl\_handlers (C++ struct), 96  
 esp\_local\_ctrl\_handlers::get\_prop\_value (C++ member), 96  
 esp\_local\_ctrl\_handlers::set\_prop\_value (C++ member), 96  
 esp\_local\_ctrl\_handlers::usr\_ctx (C++ member), 97  
 esp\_local\_ctrl\_handlers::usr\_ctx\_free\_fn (C++ member), 97  
 esp\_local\_ctrl\_handlers\_t (C++ type), 98  
 esp\_local\_ctrl\_prop (C++ struct), 95  
 esp\_local\_ctrl\_prop::ctx (C++ member), 95  
 esp\_local\_ctrl\_prop::ctx\_free\_fn (C++ member), 95  
 esp\_local\_ctrl\_prop::flags (C++ member), 95  
 esp\_local\_ctrl\_prop::name (C++ member), 95  
 esp\_local\_ctrl\_prop::size (C++ member), 95  
 esp\_local\_ctrl\_prop::type (C++ member), 95  
 esp\_local\_ctrl\_prop\_t (C++ type), 98  
 esp\_local\_ctrl\_prop\_val (C++ struct), 96  
 esp\_local\_ctrl\_prop\_val::data (C++ member), 96  
 esp\_local\_ctrl\_prop\_val::free\_fn (C++ member), 96  
 esp\_local\_ctrl\_prop\_val::size (C++ member), 96  
 esp\_local\_ctrl\_prop\_val\_t (C++ type), 98  
 esp\_local\_ctrl\_proto\_sec (C++ enum), 99  
 esp\_local\_ctrl\_proto\_sec::PROTOCOLCOM\_SEC0 (C++ enumerator), 99  
 esp\_local\_ctrl\_proto\_sec::PROTOCOLCOM\_SEC1 (C++ enumerator), 99  
 esp\_local\_ctrl\_proto\_sec::PROTOCOLCOM\_SEC2 (C++ enumerator), 99  
 esp\_local\_ctrl\_proto\_sec::PROTOCOLCOM\_SEC\_CUSTOM (C++ enumerator), 99  
 esp\_local\_ctrl\_proto\_sec\_cfg (C++ struct), 97  
 esp\_local\_ctrl\_proto\_sec\_cfg::custom\_handle (C++ member), 97  
 esp\_local\_ctrl\_proto\_sec\_cfg::pop (C++ member), 97  
 esp\_local\_ctrl\_proto\_sec\_cfg::sec\_params (C++ member), 97  
 esp\_local\_ctrl\_proto\_sec\_cfg::version (C++ member), 97  
 esp\_local\_ctrl\_proto\_sec\_cfg\_t (C++ type), 99  
 esp\_local\_ctrl\_proto\_sec\_t (C++ type), 99  
 esp\_local\_ctrl\_remove\_property (C++ function), 94  
 esp\_local\_ctrl\_security1\_params\_t (C++ type), 99  
 esp\_local\_ctrl\_security2\_params\_t (C++ type), 99  
 esp\_local\_ctrl\_set\_handler (C++ function), 94  
 esp\_local\_ctrl\_start (C++ function), 94  
 esp\_local\_ctrl\_stop (C++ function), 94  
 ESP\_LOCAL\_CTRL\_TRANSPORT\_BLE (C macro), 98  
 esp\_local\_ctrl\_transport\_config\_ble\_t (C++ type), 98  
 esp\_local\_ctrl\_transport\_config\_httpd\_t (C++ type), 98  
 esp\_local\_ctrl\_transport\_config\_t (C++ union), 95  
 esp\_local\_ctrl\_transport\_config\_t::ble



esp\_mqtt\_client\_config\_t::broker\_t::verify\_credentials (C++ member), 44  
 esp\_mqtt\_client\_config\_t::buffer (C++ member), 43  
 esp\_mqtt\_client\_config\_t::buffer\_t (C++ struct), 45  
 esp\_mqtt\_client\_config\_t::buffer\_t::out\_size (C++ member), 43  
 esp\_mqtt\_client\_config\_t::buffer\_t::size (C++ member), 43  
 esp\_mqtt\_client\_config\_t::credentials (C++ member), 43  
 esp\_mqtt\_client\_config\_t::credentials\_t (C++ struct), 45  
 esp\_mqtt\_client\_config\_t::credentials\_t::auth\_token (C++ member), 46  
 esp\_mqtt\_client\_config\_t::credentials\_t::auth\_token\_config\_t::session\_t::last\_will (C++ member), 47  
 esp\_mqtt\_client\_config\_t::credentials\_t::auth\_token\_config\_t::session\_t::last\_will\_t (C++ struct), 48  
 esp\_mqtt\_client\_config\_t::credentials\_t::auth\_token\_config\_t::session\_t::last\_will\_t::last\_will\_t (C++ member), 48  
 esp\_mqtt\_client\_config\_t::credentials\_t::auth\_token\_config\_t::data (C++ member), 48  
 esp\_mqtt\_client\_config\_t::credentials\_t::auth\_token\_config\_t::key::session\_t::last\_will\_t (C++ member), 48  
 esp\_mqtt\_client\_config\_t::credentials\_t::auth\_token\_config\_t::key::len (C++ member), 48  
 esp\_mqtt\_client\_config\_t::credentials\_t::auth\_token\_config\_t::key::password (C++ member), 48  
 esp\_mqtt\_client\_config\_t::credentials\_t::auth\_token\_config\_t::key::password\_len (C++ member), 48  
 esp\_mqtt\_client\_config\_t::credentials\_t::auth\_token\_config\_t::password (C++ member), 48  
 esp\_mqtt\_client\_config\_t::credentials\_t::auth\_token\_config\_t::password\_len (C++ member), 48  
 esp\_mqtt\_client\_config\_t::credentials\_t::auth\_token\_config\_t::protocol\_version (C++ member), 48  
 esp\_mqtt\_client\_config\_t::credentials\_t::auth\_token\_config\_t::state\_element (C++ member), 43  
 esp\_mqtt\_client\_config\_t::credentials\_t::task\_t (C++ struct), 48  
 esp\_mqtt\_client\_config\_t::credentials\_t::task\_t::priority (C++ member), 48  
 esp\_mqtt\_client\_config\_t::credentials\_t::task\_t::stack\_size (C++ member), 48  
 esp\_mqtt\_client\_config\_t::network (C++ member), 43  
 esp\_mqtt\_client\_config\_t::network\_t (C++ struct), 47  
 esp\_mqtt\_client\_config\_t::network\_t::display\_name (C++ member), 47  
 esp\_mqtt\_client\_config\_t::network\_t::ip\_addr (C++ member), 47  
 esp\_mqtt\_client\_config\_t::network\_t::reconnect\_timeout\_ms (C++ member), 47  
 esp\_mqtt\_client\_config\_t::network\_t::refresh\_connection\_after\_ms (C++ member), 47  
 esp\_mqtt\_client\_config\_t::network\_t::timeout (C++ member), 47  
 esp\_mqtt\_client\_config\_t::network\_t::transport (C++ member), 47  
 esp\_mqtt\_client\_destroy (C++ function), 40  
 esp\_mqtt\_client\_disconnect (C++ function), 38  
 esp\_mqtt\_client\_enqueue (C++ function), 40  
 esp\_mqtt\_client\_get\_outbox\_size (C++ function), 41  
 esp\_mqtt\_client\_handle\_t (C++ type), 49  
 esp\_mqtt\_client\_init (C++ function), 38  
 esp\_mqtt\_client\_publish (C++ function), 39  
 esp\_mqtt\_client\_reconnect (C++ function), 38  
 esp\_mqtt\_client\_register\_event (C++ function), 40  
 esp\_mqtt\_client\_set\_uri (C++ function), 38  
 esp\_mqtt\_client\_start (C++ function), 38  
 esp\_mqtt\_client\_stop (C++ function), 38





- (C++ enumerator), 52
- esp\_mqtt\_transport\_t::MQTT\_TRANSPORT\_OVER\_TCP (C++ enumerator), 52
- esp\_mqtt\_transport\_t::MQTT\_TRANSPORT\_OVER\_WIFI (C++ enumerator), 52
- esp\_mqtt\_transport\_t::MQTT\_TRANSPORT\_OVER\_WS (C++ enumerator), 52
- esp\_mqtt\_transport\_t::MQTT\_TRANSPORT\_UNKNOWN (C++ enumerator), 52
- esp\_netif\_action\_add\_ip6\_address (C++ function), 754
- esp\_netif\_action\_connected (C++ function), 753
- esp\_netif\_action\_disconnected (C++ function), 753
- esp\_netif\_action\_got\_ip (C++ function), 753
- esp\_netif\_action\_join\_ip6\_multicast\_group (C++ function), 753
- esp\_netif\_action\_leave\_ip6\_multicast\_group (C++ function), 754
- esp\_netif\_action\_remove\_ip6\_address (C++ function), 754
- esp\_netif\_action\_start (C++ function), 752
- esp\_netif\_action\_stop (C++ function), 752
- esp\_netif\_add\_ip6\_address (C++ function), 761
- esp\_netif\_attach (C++ function), 752
- ESP\_NETIF\_BR\_DROP (C macro), 771
- ESP\_NETIF\_BR\_FDW\_CPU (C macro), 771
- ESP\_NETIF\_BR\_FLOOD (C macro), 771
- esp\_netif\_callback\_fn (C++ type), 764
- esp\_netif\_config (C++ struct), 770
- esp\_netif\_config::base (C++ member), 770
- esp\_netif\_config::driver (C++ member), 770
- esp\_netif\_config::stack (C++ member), 770
- esp\_netif\_config\_t (C++ type), 771
- esp\_netif\_create\_ip6\_linklocal (C++ function), 761
- ESP\_NETIF\_DEFAULT\_OPENTHREAD (C macro), 743
- esp\_netif\_deinit (C++ function), 751
- esp\_netif\_destroy (C++ function), 752
- esp\_netif\_dhcp\_option\_id\_t (C++ enum), 773
- esp\_netif\_dhcp\_option\_id\_t::ESP\_NETIF\_DHCP\_OPTION\_ID\_UNKNOWN (C++ enumerator), 773
- esp\_netif\_dhcp\_option\_id\_t::ESP\_NETIF\_DHCP\_OPTION\_ID\_VENDOR\_SPECIFIC (C++ enumerator), 773
- esp\_netif\_dhcp\_option\_id\_t::ESP\_NETIF\_DHCP\_OPTION\_ID\_IP\_ADDRESS\_LEASE\_TIME (C++ enumerator), 773
- esp\_netif\_dhcp\_option\_id\_t::ESP\_NETIF\_DHCP\_OPTION\_ID\_IP\_REQUEST\_RETRY\_TIME (C++ enumerator), 773
- esp\_netif\_dhcp\_option\_id\_t::ESP\_NETIF\_DHCP\_OPTION\_ID\_IP\_REQUESTED\_IP\_ADDRESS (C++ enumerator), 773
- esp\_netif\_dhcp\_option\_id\_t::ESP\_NETIF\_DHCP\_OPTION\_ID\_IP\_REQUESTED\_IP\_ADDRESS\_RANGE (C++ enumerator), 773
- esp\_netif\_dhcp\_option\_id\_t::ESP\_NETIF\_DHCP\_OPTION\_ID\_IP\_REQUESTED\_IP\_ADDRESS\_SUBNET\_MASK (C++ enumerator), 773
- esp\_netif\_dhcp\_option\_id\_t::ESP\_NETIF\_DHCP\_OPTION\_ID\_VENDOR\_CLASS\_IDENTIFIER (C++ enumerator), 773
- esp\_netif\_dhcp\_option\_id\_t::ESP\_NETIF\_DHCP\_OPTION\_ID\_VENDOR\_CLASS\_IP\_IDENTIFIER (C++ enumerator), 773
- esp\_netif\_dhcp\_option\_id\_t::ESP\_NETIF\_DHCP\_OPTION\_ID\_VENDOR\_SPECIFIC (C++ enumerator), 773
- esp\_netif\_dhcp\_option\_mode\_t (C++ enum), 772
- esp\_netif\_dhcp\_option\_mode\_t::ESP\_NETIF\_OP\_GET (C++ enumerator), 773
- esp\_netif\_dhcp\_option\_mode\_t::ESP\_NETIF\_OP\_MAX (C++ enumerator), 773
- esp\_netif\_dhcp\_option\_mode\_t::ESP\_NETIF\_OP\_SET (C++ enumerator), 773
- esp\_netif\_dhcp\_option\_mode\_t::ESP\_NETIF\_OP\_START (C++ enumerator), 773
- esp\_netif\_dhcp\_status\_t (C++ enum), 772
- esp\_netif\_dhcp\_status\_t::ESP\_NETIF\_DHCP\_INIT (C++ enumerator), 772
- esp\_netif\_dhcp\_status\_t::ESP\_NETIF\_DHCP\_STARTED (C++ enumerator), 772
- esp\_netif\_dhcp\_status\_t::ESP\_NETIF\_DHCP\_STATUS\_MAX (C++ enumerator), 772
- esp\_netif\_dhcp\_status\_t::ESP\_NETIF\_DHCP\_STOPPED (C++ enumerator), 772
- esp\_netif\_dhcpc\_get\_status (C++ function), 759
- esp\_netif\_dhcpc\_option (C++ function), 758
- esp\_netif\_dhcpc\_start (C++ function), 759
- esp\_netif\_dhcpc\_stop (C++ function), 759
- esp\_netif\_dhcps\_get\_clients\_by\_mac (C++ function), 760
- esp\_netif\_dhcps\_get\_status (C++ function), 759
- esp\_netif\_dhcps\_option (C++ function), 758
- esp\_netif\_dhcps\_start (C++ function), 759
- esp\_netif\_dhcps\_stop (C++ function), 759
- esp\_netif\_dns\_info\_t (C++ struct), 767
- esp\_netif\_dns\_info\_t::ip (C++ member), 767
- esp\_netif\_dns\_type\_t (C++ enum), 772
- esp\_netif\_dns\_type\_t::ESP\_NETIF\_DNS\_BACKUP (C++ enumerator), 772
- esp\_netif\_dns\_type\_t::ESP\_NETIF\_DNS\_FALLBACK (C++ enumerator), 772
- esp\_netif\_dns\_type\_t::ESP\_NETIF\_DNS\_MAIN (C++ enumerator), 772
- esp\_netif\_dns\_type\_t::ESP\_NETIF\_DNS\_MAX (C++ enumerator), 772
- esp\_netif\_driver\_base\_s (C++ struct), 769
- esp\_netif\_driver\_base\_s::netif (C++ member), 769
- esp\_netif\_driver\_base\_s::post\_attach (C++ member), 769
- esp\_netif\_driver\_ifconfig (C++ struct), 769
- esp\_netif\_driver\_ifconfig::driver\_free\_rx\_buffer (C++ member), 770
- esp\_netif\_driver\_ifconfig::handle (C++ member), 770
- esp\_netif\_driver\_ifconfig::transmit (C++ member), 770

- (C++ member), 770
- `esp_netif_driver_ifconfig::transmit_wrap` (C++ member), 770
- `esp_netif_driver_ifconfig_t` (C++ type), 772
- `esp_netif_find_if` (C++ function), 764
- `esp_netif_find_predicate_t` (C++ type), 764
- `esp_netif_flags` (C++ enum), 774
- `esp_netif_flags::ESP_NETIF_DHCP_CLIENT` (C++ enumerator), 774
- `esp_netif_flags::ESP_NETIF_DHCP_SERVER` (C++ enumerator), 774
- `esp_netif_flags::ESP_NETIF_FLAG_AUTOUP` (C++ enumerator), 774
- `esp_netif_flags::ESP_NETIF_FLAG_EVENT_ESP_MODIFIED` (C++ enumerator), 774
- `esp_netif_flags::ESP_NETIF_FLAG_GARP` (C++ enumerator), 774
- `esp_netif_flags::ESP_NETIF_FLAG_IS_BRIDGE` (C++ enumerator), 774
- `esp_netif_flags::ESP_NETIF_FLAG_IS_PPP` (C++ enumerator), 774
- `esp_netif_flags::ESP_NETIF_FLAG_MLDV6_RESPONSE` (C++ enumerator), 774
- `esp_netif_flags_t` (C++ type), 771
- `esp_netif_free_rx_buffer` (C++ function), 781
- `esp_netif_get_all_ip6` (C++ function), 761
- `esp_netif_get_default_netif` (C++ function), 755
- `esp_netif_get_desc` (C++ function), 763
- `esp_netif_get_dns_info` (C++ function), 760
- `esp_netif_get_event_id` (C++ function), 763
- `esp_netif_get_flags` (C++ function), 763
- `esp_netif_get_handle_from_ifkey` (C++ function), 763
- `esp_netif_get_handle_from_netif_impl` (C++ function), 781
- `esp_netif_get_hostname` (C++ function), 756
- `esp_netif_get_ifkey` (C++ function), 763
- `esp_netif_get_io_driver` (C++ function), 763
- `esp_netif_get_ip6_global` (C++ function), 761
- `esp_netif_get_ip6_linklocal` (C++ function), 761
- `esp_netif_get_ip_info` (C++ function), 756
- `esp_netif_get_mac` (C++ function), 755
- `esp_netif_get_netif_impl` (C++ function), 781
- `esp_netif_get_netif_impl_index` (C++ function), 757
- `esp_netif_get_netif_impl_name` (C++ function), 757
- `esp_netif_get_nr_of_ifs` (C++ function), 764
- `esp_netif_get_old_ip_info` (C++ function), 756
- `esp_netif_get_route_prio` (C++ function), 763
- `esp_netif_htonl` (C macro), 776
- `esp_netif_inherent_config` (C++ struct), 769
- `esp_netif_inherent_config::bridge_info` (C++ member), 769
- `esp_netif_inherent_config::flags` (C++ member), 769
- `esp_netif_inherent_config::get_ip_event` (C++ member), 769
- `esp_netif_inherent_config::if_desc` (C++ member), 769
- `esp_netif_inherent_config::if_key` (C++ member), 769
- `esp_netif_inherent_config::ip_info` (C++ member), 769
- `esp_netif_inherent_config::lost_ip_event` (C++ member), 769
- `esp_netif_inherent_config::mac` (C++ member), 769
- `esp_netif_inherent_config::route_prio` (C++ member), 769
- `esp_netif_inherent_config_t` (C++ type), 771
- `ESP_NETIF_INHERENT_DEFAULT_OPENTHREAD` (C macro), 743
- `esp_netif_init` (C++ function), 751
- `esp_netif_iodriver_handle` (C++ type), 772
- `esp_netif_ip4_makeu32` (C macro), 776
- `esp_netif_ip6_get_addr_type` (C++ function), 775
- `esp_netif_ip6_info_t` (C++ struct), 767
- `esp_netif_ip6_info_t::ip` (C++ member), 767
- `esp_netif_ip_addr_copy` (C++ function), 775
- `esp_netif_ip_event_type` (C++ enum), 774
- `esp_netif_ip_event_type::ESP_NETIF_IP_EVENT_GOT_IP` (C++ enumerator), 774
- `esp_netif_ip_event_type::ESP_NETIF_IP_EVENT_LOST_IP` (C++ enumerator), 774
- `esp_netif_ip_event_type_t` (C++ type), 771
- `esp_netif_ip_info_t` (C++ struct), 767
- `esp_netif_ip_info_t::gw` (C++ member), 767
- `esp_netif_ip_info_t::ip` (C++ member), 767
- `esp_netif_ip_info_t::netmask` (C++ member), 767
- `esp_netif_is_netif_up` (C++ function), 756
- `esp_netif_join_ip6_multicast_group` (C++ function), 755
- `esp_netif_leave_ip6_multicast_group` (C++ function), 755
- `esp_netif_napt_disable` (C++ function), 758
- `esp_netif_napt_enable` (C++ function), 758
- `esp_netif_netstack_buf_free` (C++ function), 764
- `esp_netif_netstack_buf_ref` (C++ function), 764
- `esp_netif_netstack_config_t` (C++ type), 772
- `esp_netif_new` (C++ function), 751

- esp\_netif\_next (C++ function), 763  
 esp\_netif\_next\_unsafe (C++ function), 764  
 esp\_netif\_pair\_mac\_ip\_t (C++ struct), 770  
 esp\_netif\_pair\_mac\_ip\_t::ip (C++ member), 770  
 esp\_netif\_pair\_mac\_ip\_t::mac (C++ member), 770  
 esp\_netif\_receive (C++ function), 752  
 esp\_netif\_receive\_t (C++ type), 772  
 esp\_netif\_remove\_ip6\_address (C++ function), 762  
 esp\_netif\_set\_default\_netif (C++ function), 754  
 esp\_netif\_set\_dns\_info (C++ function), 760  
 esp\_netif\_set\_driver\_config (C++ function), 752  
 esp\_netif\_set\_hostname (C++ function), 755  
 esp\_netif\_set\_ip4\_addr (C++ function), 762  
 esp\_netif\_set\_ip\_info (C++ function), 756  
 esp\_netif\_set\_link\_speed (C++ function), 781  
 esp\_netif\_set\_mac (C++ function), 755  
 esp\_netif\_set\_old\_ip\_info (C++ function), 757  
 ESP\_NETIF\_SNTP\_DEFAULT\_CONFIG (C macro), 766  
 ESP\_NETIF\_SNTP\_DEFAULT\_CONFIG\_MULTIPLE (C macro), 766  
 esp\_netif\_sntp\_deinit (C++ function), 765  
 esp\_netif\_sntp\_init (C++ function), 765  
 esp\_netif\_sntp\_reachability (C++ function), 765  
 esp\_netif\_sntp\_start (C++ function), 765  
 esp\_netif\_sntp\_sync\_wait (C++ function), 765  
 esp\_netif\_str\_to\_ip4 (C++ function), 762  
 esp\_netif\_str\_to\_ip6 (C++ function), 762  
 esp\_netif\_t (C++ type), 771  
 esp\_netif\_tcpip\_exec (C++ function), 764  
 esp\_netif\_transmit (C++ function), 781  
 esp\_netif\_transmit\_wrap (C++ function), 781  
 esp\_ng\_type\_t (C++ enum), 1603  
 esp\_ng\_type\_t::ESP\_NG\_3072 (C++ enumerator), 1603  
 esp\_nimble\_hci\_deinit (C++ function), 691  
 esp\_nimble\_hci\_init (C++ function), 690  
 ESP\_OK (C macro), 1760  
 ESP\_OK\_EFUSE\_CNT (C macro), 1758  
 esp\_openthread\_auto\_start (C++ function), 735  
 esp\_openthread\_border\_router\_deinit (C++ function), 744  
 esp\_openthread\_border\_router\_init (C++ function), 744  
 esp\_openthread\_deinit (C++ function), 736  
 esp\_openthread\_event\_t (C++ enum), 740  
 esp\_openthread\_event\_t::OPENTHREAD\_EVENT\_ATTACHED (C++ enumerator), 740  
 esp\_openthread\_event\_t::OPENTHREAD\_EVENT\_DETACHED (C++ enumerator), 740  
 esp\_openthread\_event\_t::OPENTHREAD\_EVENT\_GOT\_IP6 (C++ enumerator), 740  
 esp\_openthread\_event\_t::OPENTHREAD\_EVENT\_IF\_DOWN (C++ enumerator), 740  
 esp\_openthread\_event\_t::OPENTHREAD\_EVENT\_IF\_UP (C++ enumerator), 740  
 esp\_openthread\_event\_t::OPENTHREAD\_EVENT\_LOST\_IP6 (C++ enumerator), 740  
 esp\_openthread\_event\_t::OPENTHREAD\_EVENT\_MULTICAST (C++ enumerator), 740  
 esp\_openthread\_event\_t::OPENTHREAD\_EVENT\_MULTICAST (C++ enumerator), 740  
 esp\_openthread\_event\_t::OPENTHREAD\_EVENT\_PUBLISH (C++ enumerator), 740  
 esp\_openthread\_event\_t::OPENTHREAD\_EVENT\_REMOVE\_M (C++ enumerator), 741  
 esp\_openthread\_event\_t::OPENTHREAD\_EVENT\_ROLE\_CHANGE (C++ enumerator), 740  
 esp\_openthread\_event\_t::OPENTHREAD\_EVENT\_SET\_DNS (C++ enumerator), 740  
 esp\_openthread\_event\_t::OPENTHREAD\_EVENT\_START (C++ enumerator), 740  
 esp\_openthread\_event\_t::OPENTHREAD\_EVENT\_STOP (C++ enumerator), 740  
 esp\_openthread\_event\_t::OPENTHREAD\_EVENT\_TREL\_ADD (C++ enumerator), 740  
 esp\_openthread\_event\_t::OPENTHREAD\_EVENT\_TREL\_MULTICAST (C++ enumerator), 740  
 esp\_openthread\_event\_t::OPENTHREAD\_EVENT\_TREL\_REMOVE (C++ enumerator), 740  
 esp\_openthread\_get\_backbone\_netif (C++ function), 744  
 esp\_openthread\_get\_instance (C++ function), 736  
 esp\_openthread\_get\_netif (C++ function), 743  
 esp\_openthread\_host\_connection\_config\_t (C++ struct), 738  
 esp\_openthread\_host\_connection\_config\_t::host\_connection (C++ member), 739  
 esp\_openthread\_host\_connection\_config\_t::host\_uar (C++ member), 739  
 esp\_openthread\_host\_connection\_config\_t::host\_usb (C++ member), 739  
 esp\_openthread\_host\_connection\_config\_t::spi\_slave (C++ member), 739  
 esp\_openthread\_host\_connection\_mode\_t (C++ enum), 741  
 esp\_openthread\_host\_connection\_mode\_t::HOST\_CONNECTION\_MODE\_HOST (C++ enumerator), 741  
 esp\_openthread\_host\_connection\_mode\_t::HOST\_CONNECTION\_MODE\_SLAVE (C++ enumerator), 741  
 esp\_openthread\_host\_connection\_mode\_t::HOST\_CONNECTION\_MODE\_SLAVE (C++ enumerator), 741  
 esp\_openthread\_host\_connection\_mode\_t::HOST\_CONNECTION\_MODE\_SLAVE (C++ enumerator), 741

esp\_openthread\_host\_connection\_mode\_t::HOST\_CONNECTION\_MODE\_NATIVE (C++ enumerator), 741  
 esp\_openthread\_host\_connection\_mode\_t::HOST\_CONNECTION\_MODE\_RCP\_SPI (C++ enumerator), 741  
 esp\_openthread\_host\_connection\_mode\_t::HOST\_CONNECTION\_MODE\_RCP\_UART (C++ enumerator), 741  
 esp\_openthread\_init (C++ function), 735  
 esp\_openthread\_launch\_mainloop (C++ function), 735  
 esp\_openthread\_lock\_acquire (C++ function), 742  
 esp\_openthread\_lock\_deinit (C++ function), 742  
 esp\_openthread\_lock\_init (C++ function), 742  
 esp\_openthread\_lock\_release (C++ function), 742  
 esp\_openthread\_mainloop\_context\_t (C++ struct), 736  
 esp\_openthread\_mainloop\_context\_t::error\_fds (C++ member), 737  
 esp\_openthread\_mainloop\_context\_t::max\_fd (C++ member), 737  
 esp\_openthread\_mainloop\_context\_t::read\_fds (C++ member), 737  
 esp\_openthread\_mainloop\_context\_t::timeout (C++ member), 737  
 esp\_openthread\_mainloop\_context\_t::write\_fds (C++ member), 737  
 esp\_openthread\_netif\_glue\_deinit (C++ function), 743  
 esp\_openthread\_netif\_glue\_init (C++ function), 743  
 esp\_openthread\_platform\_config\_t (C++ struct), 739  
 esp\_openthread\_platform\_config\_t::host\_config (C++ member), 738  
 esp\_openthread\_platform\_config\_t::port\_config (C++ member), 738  
 esp\_openthread\_platform\_config\_t::radio\_config (C++ member), 738  
 esp\_openthread\_port\_config\_t (C++ struct), 739  
 esp\_openthread\_port\_config\_t::netif\_queue\_size (C++ member), 739  
 esp\_openthread\_port\_config\_t::storage\_partition (C++ member), 739  
 esp\_openthread\_port\_config\_t::task\_queue\_size (C++ member), 739  
 esp\_openthread\_radio\_config\_t (C++ struct), 738  
 esp\_openthread\_radio\_config\_t::radio\_mode (C++ member), 738  
 esp\_openthread\_radio\_config\_t::radio\_spi\_config (C++ member), 738  
 esp\_openthread\_radio\_config\_t::radio\_uart\_config (C++ member), 738  
 esp\_openthread\_radio\_mode\_t (C++ enum), 741  
 esp\_openthread\_radio\_mode\_t::RADIO\_MODE\_MAX (C++ member), 737  
 esp\_openthread\_radio\_mode\_t::RADIO\_MODE\_NATIVE (C++ member), 741  
 esp\_openthread\_radio\_mode\_t::RADIO\_MODE\_SPI\_RCP (C++ member), 741  
 esp\_openthread\_radio\_mode\_t::RADIO\_MODE\_UART\_RCP (C++ member), 741  
 esp\_openthread\_rcp\_deinit (C++ function), 744  
 esp\_openthread\_rcp\_failure\_handler (C++ type), 739  
 esp\_openthread\_rcp\_init (C++ function), 744  
 esp\_openthread\_register\_meshcop\_e\_handler (C++ function), 743  
 esp\_openthread\_register\_rcp\_failure\_handler (C++ function), 744  
 esp\_openthread\_role\_changed\_event\_t (C++ struct), 736  
 esp\_openthread\_role\_changed\_event\_t::current\_role (C++ member), 736  
 esp\_openthread\_role\_changed\_event\_t::previous\_role (C++ member), 736  
 esp\_openthread\_set\_backbone\_netif (C++ function), 744  
 esp\_openthread\_set\_meshcop\_instance\_name (C++ function), 745  
 esp\_openthread\_spi\_host\_config\_t (C++ struct), 737  
 esp\_openthread\_spi\_host\_config\_t::dma\_channel (C++ member), 737  
 esp\_openthread\_spi\_host\_config\_t::host\_device (C++ member), 737  
 esp\_openthread\_spi\_host\_config\_t::intr\_pin (C++ member), 738  
 esp\_openthread\_spi\_host\_config\_t::spi\_device (C++ member), 738  
 esp\_openthread\_spi\_host\_config\_t::spi\_interface (C++ member), 738  
 esp\_openthread\_spi\_slave\_config\_t (C++ struct), 738  
 esp\_openthread\_spi\_slave\_config\_t::bus\_config (C++ member), 738  
 esp\_openthread\_spi\_slave\_config\_t::host\_device (C++ member), 738  
 esp\_openthread\_spi\_slave\_config\_t::intr\_pin (C++ member), 738  
 esp\_openthread\_spi\_slave\_config\_t::slave\_config (C++ member), 738  
 esp\_openthread\_task\_switching\_lock\_acquire (C++ function), 742  
 esp\_openthread\_task\_switching\_lock\_release (C++ function), 742  
 esp\_openthread\_uart\_config\_t (C++ struct), 737  
 esp\_openthread\_uart\_config\_t::port (C++ member), 737  
 esp\_openthread\_uart\_config\_t::rx\_pin (C++ member), 737







- esp\_phy\_init\_data\_t::params (C++ member), 2277
- esp\_phy\_load\_cal\_and\_init (C++ function), 2277
- esp\_phy\_load\_cal\_data\_from\_nvs (C++ function), 2276
- esp\_phy\_modem\_deinit (C++ function), 2277
- esp\_phy\_modem\_init (C++ function), 2277
- esp\_phy\_modem\_t (C++ enum), 2278
- esp\_phy\_modem\_t::PHY\_MODEM\_BT (C++ enumerator), 2278
- esp\_phy\_modem\_t::PHY\_MODEM\_IEEE802154 (C++ enumerator), 2278
- esp\_phy\_modem\_t::PHY\_MODEM\_WIFI (C++ enumerator), 2278
- esp\_phy\_release\_init\_data (C++ function), 2276
- esp\_phy\_rf\_get\_on\_ts (C++ function), 2277
- esp\_phy\_rftest\_config (C++ function), 2279
- esp\_phy\_rftest\_init (C++ function), 2279
- esp\_phy\_rx\_result\_t (C++ struct), 2280
- esp\_phy\_rx\_result\_t::phy\_rx\_correct\_count (C++ member), 2281
- esp\_phy\_rx\_result\_t::phy\_rx\_result\_flags (C++ member), 2281
- esp\_phy\_rx\_result\_t::phy\_rx\_rssi (C++ member), 2281
- esp\_phy\_rx\_result\_t::phy\_rx\_total\_count (C++ member), 2281
- esp\_phy\_store\_cal\_data\_to\_nvs (C++ function), 2276
- esp\_phy\_test\_start\_stop (C++ function), 2279
- esp\_phy\_tx\_contin\_en (C++ function), 2279
- esp\_phy\_update\_country\_info (C++ function), 2277
- esp\_phy\_wifi\_rate\_t (C++ enum), 2281
- esp\_phy\_wifi\_rate\_t::PHY\_RATE\_11M (C++ enumerator), 2281
- esp\_phy\_wifi\_rate\_t::PHY\_RATE\_12M (C++ enumerator), 2281
- esp\_phy\_wifi\_rate\_t::PHY\_RATE\_18M (C++ enumerator), 2281
- esp\_phy\_wifi\_rate\_t::PHY\_RATE\_1M (C++ enumerator), 2281
- esp\_phy\_wifi\_rate\_t::PHY\_RATE\_24M (C++ enumerator), 2281
- esp\_phy\_wifi\_rate\_t::PHY\_RATE\_2M (C++ enumerator), 2281
- esp\_phy\_wifi\_rate\_t::PHY\_RATE\_36M (C++ enumerator), 2281
- esp\_phy\_wifi\_rate\_t::PHY\_RATE\_48M (C++ enumerator), 2281
- esp\_phy\_wifi\_rate\_t::PHY\_RATE\_54M (C++ enumerator), 2281
- esp\_phy\_wifi\_rate\_t::PHY\_RATE\_5M5 (C++ enumerator), 2281
- esp\_phy\_wifi\_rate\_t::PHY\_RATE\_6M (C++ enumerator), 2281
- esp\_phy\_wifi\_rate\_t::PHY\_RATE\_9M (C++ enumerator), 2281
- esp\_phy\_wifi\_rate\_t::PHY\_RATE\_MCS0 (C++ enumerator), 2281
- esp\_phy\_wifi\_rate\_t::PHY\_RATE\_MCS1 (C++ enumerator), 2281
- esp\_phy\_wifi\_rate\_t::PHY\_RATE\_MCS2 (C++ enumerator), 2281
- esp\_phy\_wifi\_rate\_t::PHY\_RATE\_MCS3 (C++ enumerator), 2282
- esp\_phy\_wifi\_rate\_t::PHY\_RATE\_MCS4 (C++ enumerator), 2282
- esp\_phy\_wifi\_rate\_t::PHY\_RATE\_MCS5 (C++ enumerator), 2282
- esp\_phy\_wifi\_rate\_t::PHY\_RATE\_MCS6 (C++ enumerator), 2282
- esp\_phy\_wifi\_rate\_t::PHY\_RATE\_MCS7 (C++ enumerator), 2282
- esp\_phy\_wifi\_rate\_t::PHY\_WIFI\_RATE\_MAX (C++ enumerator), 2282
- esp\_phy\_wifi\_rx (C++ function), 2279
- esp\_phy\_wifi\_tx (C++ function), 2279
- esp\_phy\_wifi\_tx\_tone (C++ function), 2280
- esp\_ping\_callbacks\_t (C++ struct), 152
- esp\_ping\_callbacks\_t::cb\_args (C++ member), 152
- esp\_ping\_callbacks\_t::on\_ping\_end (C++ member), 152
- esp\_ping\_callbacks\_t::on\_ping\_success (C++ member), 152
- esp\_ping\_callbacks\_t::on\_ping\_timeout (C++ member), 152
- esp\_ping\_config\_t (C++ struct), 152
- esp\_ping\_config\_t::count (C++ member), 152
- esp\_ping\_config\_t::data\_size (C++ member), 153
- esp\_ping\_config\_t::interface (C++ member), 153
- esp\_ping\_config\_t::interval\_ms (C++ member), 152
- esp\_ping\_config\_t::target\_addr (C++ member), 153
- esp\_ping\_config\_t::task\_prio (C++ member), 153
- esp\_ping\_config\_t::task\_stack\_size (C++ member), 153
- esp\_ping\_config\_t::timeout\_ms (C++ member), 152
- esp\_ping\_config\_t::tos (C++ member), 153
- esp\_ping\_config\_t::ttl (C++ member), 153
- ESP\_PING\_COUNT\_INFINITE (C macro), 153
- ESP\_PING\_DEFAULT\_CONFIG (C macro), 153
- esp\_ping\_delete\_session (C++ function), 151
- esp\_ping\_get\_profile (C++ function), 152
- esp\_ping\_handle\_t (C++ type), 153
- esp\_ping\_new\_session (C++ function), 151



- esp\_ping\_profile\_t (C++ *enum*), 153  
 esp\_ping\_profile\_t::ESP\_PING\_PROF\_DURATION esp\_power\_level\_t::ESP\_PWR\_LVL\_N15  
 (C++ *enumerator*), 154 (C++ *enumerator*), 307  
 esp\_ping\_profile\_t::ESP\_PING\_PROF\_IPADDR esp\_power\_level\_t::ESP\_PWR\_LVL\_N18  
 (C++ *enumerator*), 154 (C++ *enumerator*), 307  
 esp\_ping\_profile\_t::ESP\_PING\_PROF\_REPLY esp\_power\_level\_t::ESP\_PWR\_LVL\_N21  
 (C++ *enumerator*), 154 (C++ *enumerator*), 307  
 esp\_ping\_profile\_t::ESP\_PING\_PROF\_REQUEST esp\_power\_level\_t::ESP\_PWR\_LVL\_N24  
 (C++ *enumerator*), 154 (C++ *enumerator*), 307  
 esp\_ping\_profile\_t::ESP\_PING\_PROF\_SEQUENCE esp\_power\_level\_t::ESP\_PWR\_LVL\_N3  
 (C++ *enumerator*), 153 (C++ *enumerator*), 307  
 esp\_ping\_profile\_t::ESP\_PING\_PROF\_SIZE esp\_power\_level\_t::ESP\_PWR\_LVL\_N6  
 (C++ *enumerator*), 154 (C++ *enumerator*), 307  
 esp\_ping\_profile\_t::ESP\_PING\_PROF\_TIMEOUT esp\_power\_level\_t::ESP\_PWR\_LVL\_N9  
 (C++ *enumerator*), 154 (C++ *enumerator*), 307  
 esp\_ping\_profile\_t::ESP\_PING\_PROF\_TOS esp\_power\_level\_t::ESP\_PWR\_LVL\_P12  
 (C++ *enumerator*), 153 (C++ *enumerator*), 307  
 esp\_ping\_profile\_t::ESP\_PING\_PROF\_TTL esp\_power\_level\_t::ESP\_PWR\_LVL\_P15  
 (C++ *enumerator*), 153 (C++ *enumerator*), 307  
 esp\_ping\_start (C++ *function*), 151  
 esp\_ping\_stop (C++ *function*), 151  
 esp\_pm\_config\_esp32\_t (C++ *type*), 2015  
 esp\_pm\_config\_esp32c2\_t (C++ *type*), 2015  
 esp\_pm\_config\_esp32c3\_t (C++ *type*), 2015  
 esp\_pm\_config\_esp32c6\_t (C++ *type*), 2015  
 esp\_pm\_config\_esp32s2\_t (C++ *type*), 2015  
 esp\_pm\_config\_esp32s3\_t (C++ *type*), 2015  
 esp\_pm\_config\_t (C++ *struct*), 2015  
 esp\_pm\_config\_t::light\_sleep\_enable  
 (C++ *member*), 2015  
 esp\_pm\_config\_t::max\_freq\_mhz (C++  
*member*), 2015  
 esp\_pm\_config\_t::min\_freq\_mhz (C++  
*member*), 2015  
 esp\_pm\_configure (C++ *function*), 2013  
 esp\_pm\_dump\_locks (C++ *function*), 2014  
 esp\_pm\_get\_configuration (C++ *function*),  
 2013  
 esp\_pm\_lock\_acquire (C++ *function*), 2014  
 esp\_pm\_lock\_create (C++ *function*), 2013  
 esp\_pm\_lock\_delete (C++ *function*), 2014  
 esp\_pm\_lock\_handle\_t (C++ *type*), 2015  
 esp\_pm\_lock\_release (C++ *function*), 2014  
 esp\_pm\_lock\_type\_t (C++ *enum*), 2015  
 esp\_pm\_lock\_type\_t::ESP\_PM\_APB\_FREQ\_MAX  
 (C++ *enumerator*), 2016  
 esp\_pm\_lock\_type\_t::ESP\_PM\_CPU\_FREQ\_MAX  
 (C++ *enumerator*), 2015  
 esp\_pm\_lock\_type\_t::ESP\_PM\_LOCK\_MAX  
 (C++ *enumerator*), 2016  
 esp\_pm\_lock\_type\_t::ESP\_PM\_NO\_LIGHT\_SLEEP  
 (C++ *enumerator*), 2016  
 esp\_power\_level\_t (C++ *enum*), 307  
 esp\_power\_level\_t::ESP\_PWR\_LVL\_INVALID  
 (C++ *enumerator*), 308  
 esp\_power\_level\_t::ESP\_PWR\_LVL\_N0  
 (C++ *enumerator*), 307  
 esp\_power\_level\_t::ESP\_PWR\_LVL\_N12  
 (C++ *enumerator*), 307  
 esp\_power\_level\_t::ESP\_PWR\_LVL\_N15  
 (C++ *enumerator*), 307  
 esp\_power\_level\_t::ESP\_PWR\_LVL\_N18  
 (C++ *enumerator*), 307  
 esp\_power\_level\_t::ESP\_PWR\_LVL\_N21  
 (C++ *enumerator*), 307  
 esp\_power\_level\_t::ESP\_PWR\_LVL\_N24  
 (C++ *enumerator*), 307  
 esp\_power\_level\_t::ESP\_PWR\_LVL\_N3  
 (C++ *enumerator*), 307  
 esp\_power\_level\_t::ESP\_PWR\_LVL\_N6  
 (C++ *enumerator*), 307  
 esp\_power\_level\_t::ESP\_PWR\_LVL\_N9  
 (C++ *enumerator*), 307  
 esp\_power\_level\_t::ESP\_PWR\_LVL\_P12  
 (C++ *enumerator*), 307  
 esp\_power\_level\_t::ESP\_PWR\_LVL\_P15  
 (C++ *enumerator*), 307  
 esp\_power\_level\_t::ESP\_PWR\_LVL\_P16  
 (C++ *enumerator*), 307  
 esp\_power\_level\_t::ESP\_PWR\_LVL\_P17  
 (C++ *enumerator*), 308  
 esp\_power\_level\_t::ESP\_PWR\_LVL\_P18  
 (C++ *enumerator*), 308  
 esp\_power\_level\_t::ESP\_PWR\_LVL\_P19  
 (C++ *enumerator*), 308  
 esp\_power\_level\_t::ESP\_PWR\_LVL\_P20  
 (C++ *enumerator*), 308  
 esp\_power\_level\_t::ESP\_PWR\_LVL\_P3  
 (C++ *enumerator*), 307  
 esp\_power\_level\_t::ESP\_PWR\_LVL\_P6  
 (C++ *enumerator*), 307  
 esp\_power\_level\_t::ESP\_PWR\_LVL\_P9  
 (C++ *enumerator*), 307  
 esp\_pthread\_cfg\_t (C++ *struct*), 2020  
 esp\_pthread\_cfg\_t::inherit\_cfg (C++  
*member*), 2020  
 esp\_pthread\_cfg\_t::pin\_to\_core (C++  
*member*), 2021  
 esp\_pthread\_cfg\_t::prio (C++ *member*),  
 2020  
 esp\_pthread\_cfg\_t::stack\_alloc\_caps  
 (C++ *member*), 2021  
 esp\_pthread\_cfg\_t::stack\_size (C++  
*member*), 2020  
 esp\_pthread\_cfg\_t::thread\_name (C++  
*member*), 2021  
 esp\_pthread\_get\_cfg (C++ *function*), 2020  
 esp\_pthread\_get\_default\_config (C++  
*function*), 2020  
 esp\_pthread\_init (C++ *function*), 2020  
 esp\_pthread\_set\_cfg (C++ *function*), 2020  
 esp\_random (C++ *function*), 2022  
 esp\_read\_mac (C++ *function*), 1987  
 esp\_register\_freertos\_idle\_hook (C++  
*function*), 1918  
 esp\_register\_freertos\_idle\_hook\_for\_cpu

- (C++ function), 1917
- esp\_register\_freertos\_tick\_hook (C++ function), 1918
- esp\_register\_freertos\_tick\_hook\_for\_cpu (C++ function), 1918
- esp\_register\_shutdown\_handler (C++ function), 1983
- esp\_reset\_reason (C++ function), 1983
- esp\_reset\_reason\_t (C++ enum), 1984
- esp\_reset\_reason\_t::ESP\_RST\_BROWNOUT (C++ enumerator), 1984
- esp\_reset\_reason\_t::ESP\_RST\_CPU\_LOCKUP (C++ enumerator), 1985
- esp\_reset\_reason\_t::ESP\_RST\_DEEPSLEEP (C++ enumerator), 1984
- esp\_reset\_reason\_t::ESP\_RST\_EFUSE (C++ enumerator), 1984
- esp\_reset\_reason\_t::ESP\_RST\_EXT (C++ enumerator), 1984
- esp\_reset\_reason\_t::ESP\_RST\_INT\_WDT (C++ enumerator), 1984
- esp\_reset\_reason\_t::ESP\_RST\_JTAG (C++ enumerator), 1984
- esp\_reset\_reason\_t::ESP\_RST\_PANIC (C++ enumerator), 1984
- esp\_reset\_reason\_t::ESP\_RST\_POWERON (C++ enumerator), 1984
- esp\_reset\_reason\_t::ESP\_RST\_PWR\_GLITCH (C++ enumerator), 1985
- esp\_reset\_reason\_t::ESP\_RST\_SDIO (C++ enumerator), 1984
- esp\_reset\_reason\_t::ESP\_RST\_SW (C++ enumerator), 1984
- esp\_reset\_reason\_t::ESP\_RST\_TASK\_WDT (C++ enumerator), 1984
- esp\_reset\_reason\_t::ESP\_RST\_UNKNOWN (C++ enumerator), 1984
- esp\_reset\_reason\_t::ESP\_RST\_USB (C++ enumerator), 1984
- esp\_reset\_reason\_t::ESP\_RST\_WDT (C++ enumerator), 1984
- esp\_restart (C++ function), 1983
- ESP\_RETURN\_ON\_ERROR (C macro), 1759
- ESP\_RETURN\_ON\_ERROR\_ISR (C macro), 1759
- ESP\_RETURN\_ON\_FALSE (C macro), 1759
- ESP\_RETURN\_ON\_FALSE\_ISR (C macro), 1759
- ESP\_RETURN\_VOID\_ON\_ERROR (C macro), 1759
- ESP\_RETURN\_VOID\_ON\_ERROR\_ISR (C macro), 1759
- ESP\_RETURN\_VOID\_ON\_FALSE (C macro), 1759
- ESP\_RETURN\_VOID\_ON\_FALSE\_ISR (C macro), 1759
- esp\_rom\_delay\_us (C++ function), 1964
- esp\_rom\_get\_cpu\_ticks\_per\_us (C++ function), 1964
- esp\_rom\_get\_reset\_reason (C++ function), 1964
- esp\_rom\_install\_channel\_putc (C++ function), 1964
- esp\_rom\_install\_uart\_printf (C++ function), 1964
- esp\_rom\_printf (C++ function), 1964
- esp\_rom\_route\_intr\_matrix (C++ function), 1964
- esp\_rom\_set\_cpu\_ticks\_per\_us (C++ function), 1964
- esp\_rom\_software\_reset\_cpu (C++ function), 1963
- esp\_rom\_software\_reset\_system (C++ function), 1963
- esp\_secure\_boot\_key\_digests\_t (C++ struct), 1757
- esp\_secure\_boot\_key\_digests\_t::key\_digests (C++ member), 1757
- esp\_secure\_boot\_read\_key\_digests (C++ function), 1756
- esp\_service\_source\_t (C++ enum), 263
- esp\_service\_source\_t::ESP\_GATT\_SERVICE\_FROM\_NVS (C++ enumerator), 263
- esp\_service\_source\_t::ESP\_GATT\_SERVICE\_FROM\_REMOTE (C++ enumerator), 263
- esp\_service\_source\_t::ESP\_GATT\_SERVICE\_FROM\_UNKNOWN (C++ enumerator), 263
- esp\_set\_deep\_sleep\_wake\_stub (C++ function), 2034
- esp\_set\_deep\_sleep\_wake\_stub\_default\_entry (C++ function), 2034
- esp\_sleep\_config\_gpio\_isolate (C++ function), 2035
- esp\_sleep\_cpu\_retention\_deinit (C++ function), 2035
- esp\_sleep\_cpu\_retention\_init (C++ function), 2035
- esp\_sleep\_disable\_bt\_wakeup (C++ function), 2032
- esp\_sleep\_disable\_ext1\_wakeup\_io (C++ function), 2030
- esp\_sleep\_disable\_wakeup\_source (C++ function), 2028
- esp\_sleep\_disable\_wifi\_beacon\_wakeup (C++ function), 2032
- esp\_sleep\_disable\_wifi\_wakeup (C++ function), 2032
- esp\_sleep\_enable\_bt\_wakeup (C++ function), 2032
- esp\_sleep\_enable\_ext1\_wakeup (C++ function), 2028
- esp\_sleep\_enable\_ext1\_wakeup\_io (C++ function), 2029
- esp\_sleep\_enable\_ext1\_wakeup\_with\_level\_mask (C++ function), 2030
- esp\_sleep\_enable\_gpio\_switch (C++ function), 2035
- esp\_sleep\_enable\_gpio\_wakeup (C++ function), 2031
- esp\_sleep\_enable\_timer\_wakeup (C++ function), 2031

- tion), 2028
- esp\_sleep\_enable\_uart\_wakeup (C++ function), 2031
- esp\_sleep\_enable\_wifi\_beacon\_wakeup (C++ function), 2032
- esp\_sleep\_enable\_wifi\_wakeup (C++ function), 2032
- esp\_sleep\_ext1\_wakeup\_mode\_t (C++ enum), 2035
- esp\_sleep\_ext1\_wakeup\_mode\_t::ESP\_EXT1\_WAKEUP\_MODE\_INTERRUPT (C++ enumerator), 2035
- esp\_sleep\_ext1\_wakeup\_mode\_t::ESP\_EXT1\_WAKEUP\_MODE\_GPIO (C++ enumerator), 2035
- esp\_sleep\_ext1\_wakeup\_mode\_t::ESP\_EXT1\_WAKEUP\_MODE\_TIMER (C++ enumerator), 2035
- esp\_sleep\_ext1\_wakeup\_mode\_t::ESP\_EXT1\_WAKEUP\_MODE\_TOUCHPAD (C++ enumerator), 2035
- esp\_sleep\_get\_ext1\_wakeup\_status (C++ function), 2032
- esp\_sleep\_get\_wakeup\_cause (C++ function), 2034
- esp\_sleep\_is\_valid\_wakeup\_gpio (C++ function), 2028
- esp\_sleep\_mode\_t (C++ enum), 2037
- esp\_sleep\_mode\_t::ESP\_SLEEP\_MODE\_DEEP\_SLEEP (C++ enumerator), 2038
- esp\_sleep\_mode\_t::ESP\_SLEEP\_MODE\_LIGHT\_SLEEP (C++ enumerator), 2037
- esp\_sleep\_pd\_config (C++ function), 2032
- esp\_sleep\_pd\_domain\_t (C++ enum), 2036
- esp\_sleep\_pd\_domain\_t::ESP\_PD\_DOMAIN\_CPU (C++ enumerator), 2036
- esp\_sleep\_pd\_domain\_t::ESP\_PD\_DOMAIN\_MAX (C++ enumerator), 2036
- esp\_sleep\_pd\_domain\_t::ESP\_PD\_DOMAIN\_MODEM (C++ enumerator), 2036
- esp\_sleep\_pd\_domain\_t::ESP\_PD\_DOMAIN\_RC32K (C++ enumerator), 2036
- esp\_sleep\_pd\_domain\_t::ESP\_PD\_DOMAIN\_RC\_FAST (C++ enumerator), 2036
- esp\_sleep\_pd\_domain\_t::ESP\_PD\_DOMAIN\_TOP (C++ enumerator), 2036
- esp\_sleep\_pd\_domain\_t::ESP\_PD\_DOMAIN\_VDD\_IO (C++ enumerator), 2036
- esp\_sleep\_pd\_domain\_t::ESP\_PD\_DOMAIN\_XTAL (C++ enumerator), 2036
- esp\_sleep\_pd\_domain\_t::ESP\_PD\_DOMAIN\_XTAL32K (C++ enumerator), 2036
- esp\_sleep\_pd\_option\_t (C++ enum), 2036
- esp\_sleep\_pd\_option\_t::ESP\_PD\_OPTION\_AUTO (C++ enumerator), 2036
- esp\_sleep\_pd\_option\_t::ESP\_PD\_OPTION\_OFF (C++ enumerator), 2036
- esp\_sleep\_pd\_option\_t::ESP\_PD\_OPTION\_ON (C++ enumerator), 2036
- ESP\_SLEEP\_POWER\_DOWN\_CPU (C macro), 2035
- esp\_sleep\_source\_t (C++ enum), 2036
- esp\_sleep\_source\_t::ESP\_SLEEP\_WAKEUP\_ALARM (C++ enumerator), 2037
- esp\_sleep\_source\_t::ESP\_SLEEP\_WAKEUP\_BUTTON (C++ enumerator), 2037
- esp\_sleep\_source\_t::ESP\_SLEEP\_WAKEUP\_COCPU (C++ enumerator), 2037
- esp\_sleep\_source\_t::ESP\_SLEEP\_WAKEUP\_COCPU\_TRAP\_T (C++ enumerator), 2037
- esp\_sleep\_source\_t::ESP\_SLEEP\_WAKEUP\_EXT0 (C++ enumerator), 2037
- esp\_sleep\_source\_t::ESP\_SLEEP\_WAKEUP\_EXT1 (C++ enumerator), 2037
- esp\_sleep\_source\_t::ESP\_SLEEP\_WAKEUP\_GPIO (C++ enumerator), 2037
- esp\_sleep\_source\_t::ESP\_SLEEP\_WAKEUP\_TIMER (C++ enumerator), 2037
- esp\_sleep\_source\_t::ESP\_SLEEP\_WAKEUP\_TOUCHPAD (C++ enumerator), 2037
- esp\_sleep\_source\_t::ESP\_SLEEP\_WAKEUP\_UART (C++ enumerator), 2037
- esp\_sleep\_source\_t::ESP\_SLEEP\_WAKEUP\_ULP (C++ enumerator), 2037
- esp\_sleep\_source\_t::ESP\_SLEEP\_WAKEUP\_UNDEFINED (C++ enumerator), 2037
- esp\_sleep\_source\_t::ESP\_SLEEP\_WAKEUP\_WIFI (C++ enumerator), 2037
- esp\_sleep\_wakeup\_cause\_t (C++ type), 2035
- esp\_sntp\_config (C++ struct), 765
- esp\_sntp\_config::index\_of\_first\_server (C++ member), 766
- esp\_sntp\_config::ip\_event\_to\_renew (C++ member), 766
- esp\_sntp\_config::num\_of\_servers (C++ member), 766
- esp\_sntp\_config::renew\_servers\_after\_new\_IP (C++ member), 765
- esp\_sntp\_config::server\_from\_dhcp (C++ member), 765
- esp\_sntp\_config::servers (C++ member), 766
- esp\_sntp\_config::smooth\_sync (C++ member), 765
- esp\_sntp\_config::start (C++ member), 765
- esp\_sntp\_config::sync\_cb (C++ member), 765
- esp\_sntp\_config::wait\_for\_sync (C++ member), 765
- esp\_sntp\_config\_t (C++ type), 766
- esp\_sntp\_enabled (C++ function), 2060
- esp\_sntp\_get\_sync\_interval (C macro), 2061
- esp\_sntp\_get\_sync\_mode (C macro), 2061
- esp\_sntp\_get\_sync\_status (C macro), 2061
- esp\_sntp\_getoperatingmode (C++ function), 2060
- esp\_sntp\_getreachability (C++ function), 2060
- esp\_sntp\_getserver (C++ function), 2060
- esp\_sntp\_getservername (C++ function), 2060
- esp\_sntp\_init (C++ function), 2060
- esp\_sntp\_operatingmode\_t (C++ enum), 2062
- esp\_sntp\_operatingmode\_t::ESP\_SNTP\_OPMODE\_LISTEN

- (C++ *enumerator*), 2062
- esp\_sntp\_operatingmode\_t::ESP\_SNTP\_OPMODE\_FORCE (C++ *enumerator*), 2062
- esp\_sntp\_restart (C *macro*), 2061
- ESP\_SNTP\_SERVER\_LIST (C *macro*), 766
- esp\_sntp\_set\_sync\_interval (C *macro*), 2061
- esp\_sntp\_set\_sync\_mode (C *macro*), 2061
- esp\_sntp\_set\_sync\_status (C *macro*), 2061
- esp\_sntp\_set\_time\_sync\_notification\_cb (C *macro*), 2061
- esp\_sntp\_setoperatingmode (C++ *function*), 2059
- esp\_sntp\_setserver (C++ *function*), 2060
- esp\_sntp\_setservername (C++ *function*), 2060
- esp\_sntp\_stop (C++ *function*), 2060
- esp\_sntp\_sync\_time (C *macro*), 2061
- esp\_sntp\_time\_cb\_t (C++ *type*), 766
- esp\_spiffs\_check (C++ *function*), 1677
- esp\_spiffs\_format (C++ *function*), 1677
- esp\_spiffs\_gc (C++ *function*), 1677
- esp\_spiffs\_info (C++ *function*), 1677
- esp\_spiffs\_mounted (C++ *function*), 1677
- esp\_srp\_exchange\_proofs (C++ *function*), 1602
- esp\_srp\_free (C++ *function*), 1600
- esp\_srp\_gen\_salt\_verifier (C++ *function*), 1601
- esp\_srp\_get\_session\_key (C++ *function*), 1602
- esp\_srp\_handle\_t (C++ *type*), 1602
- esp\_srp\_init (C++ *function*), 1600
- esp\_srp\_set\_salt\_verifier (C++ *function*), 1601
- esp\_srp\_srv\_pubkey (C++ *function*), 1600
- esp\_srp\_srv\_pubkey\_from\_salt\_verifier (C++ *function*), 1602
- esp\_system\_abort (C++ *function*), 1983
- esp\_systick\_new\_etm\_alarm\_event (C++ *function*), 840
- esp\_sysview\_flush (C++ *function*), 1711
- esp\_sysview\_heap\_trace\_alloc (C++ *function*), 1712
- esp\_sysview\_heap\_trace\_free (C++ *function*), 1712
- esp\_sysview\_heap\_trace\_start (C++ *function*), 1711
- esp\_sysview\_heap\_trace\_stop (C++ *function*), 1711
- esp\_sysview\_vprintf (C++ *function*), 1711
- esp\_task\_wdt\_add (C++ *function*), 2069
- esp\_task\_wdt\_add\_user (C++ *function*), 2070
- esp\_task\_wdt\_config\_t (C++ *struct*), 2072
- esp\_task\_wdt\_config\_t::idle\_core\_mask (C++ *member*), 2072
- esp\_task\_wdt\_config\_t::timeout\_ms (C++ *member*), 2072
- esp\_task\_wdt\_config\_t::trigger\_panic (C++ *member*), 2072
- esp\_task\_wdt\_deinit (C++ *function*), 2069
- esp\_task\_wdt\_delete (C++ *function*), 2070
- esp\_task\_wdt\_delete\_user (C++ *function*), 2070
- esp\_task\_wdt\_init (C++ *function*), 2069
- esp\_task\_wdt\_isr\_user\_handler (C++ *function*), 2071
- esp\_task\_wdt\_print\_triggered\_tasks (C++ *function*), 2071
- esp\_task\_wdt\_reconfigure (C++ *function*), 2069
- esp\_task\_wdt\_reset (C++ *function*), 2070
- esp\_task\_wdt\_reset\_user (C++ *function*), 2070
- esp\_task\_wdt\_status (C++ *function*), 2071
- esp\_task\_wdt\_user\_handle\_t (C++ *type*), 2072
- esp\_timer\_cb\_t (C++ *type*), 1963
- esp\_timer\_create (C++ *function*), 1959
- esp\_timer\_create\_args\_t (C++ *struct*), 1962
- esp\_timer\_create\_args\_t::arg (C++ *member*), 1962
- esp\_timer\_create\_args\_t::callback (C++ *member*), 1962
- esp\_timer\_create\_args\_t::dispatch\_method (C++ *member*), 1962
- esp\_timer\_create\_args\_t::name (C++ *member*), 1962
- esp\_timer\_create\_args\_t::skip\_unhandled\_events (C++ *member*), 1962
- esp\_timer\_deinit (C++ *function*), 1959
- esp\_timer\_delete (C++ *function*), 1960
- esp\_timer\_dispatch\_t (C++ *enum*), 1963
- esp\_timer\_dispatch\_t::ESP\_TIMER\_ISR (C++ *enumerator*), 1963
- esp\_timer\_dispatch\_t::ESP\_TIMER\_MAX (C++ *enumerator*), 1963
- esp\_timer\_dispatch\_t::ESP\_TIMER\_TASK (C++ *enumerator*), 1963
- esp\_timer\_dump (C++ *function*), 1961
- esp\_timer\_early\_init (C++ *function*), 1958
- esp\_timer\_get\_expiry\_time (C++ *function*), 1961
- esp\_timer\_get\_next\_alarm (C++ *function*), 1960
- esp\_timer\_get\_next\_alarm\_for\_wake\_up (C++ *function*), 1960
- esp\_timer\_get\_period (C++ *function*), 1961
- esp\_timer\_get\_time (C++ *function*), 1960
- esp\_timer\_handle\_t (C++ *type*), 1963
- esp\_timer\_init (C++ *function*), 1958
- esp\_timer\_is\_active (C++ *function*), 1962
- esp\_timer\_isr\_dispatch\_need\_yield (C++ *function*), 1962
- esp\_timer\_new\_etm\_alarm\_event (C++ *function*), 1962
- esp\_timer\_restart (C++ *function*), 1960
- esp\_timer\_start\_once (C++ *function*), 1959

- esp\_timer\_start\_periodic (C++ function), 1960  
 esp\_timer\_stop (C++ function), 1960  
 esp\_tls\_addr\_family (C++ enum), 68  
 esp\_tls\_addr\_family::ESP\_TLS\_AF\_INET (C++ enumerator), 68  
 esp\_tls\_addr\_family::ESP\_TLS\_AF\_INET6 (C++ enumerator), 68  
 esp\_tls\_addr\_family::ESP\_TLS\_AF\_UNSPEC (C++ enumerator), 68  
 esp\_tls\_addr\_family\_t (C++ type), 67  
 esp\_tls\_cfg (C++ struct), 63  
 esp\_tls\_cfg::addr\_family (C++ member), 65  
 esp\_tls\_cfg::alpn\_protos (C++ member), 63  
 esp\_tls\_cfg::cacert\_buf (C++ member), 64  
 esp\_tls\_cfg::cacert\_bytes (C++ member), 64  
 esp\_tls\_cfg::cacert\_pem\_buf (C++ member), 64  
 esp\_tls\_cfg::cacert\_pem\_bytes (C++ member), 64  
 esp\_tls\_cfg::ciphersuites\_list (C++ member), 66  
 esp\_tls\_cfg::clientcert\_buf (C++ member), 64  
 esp\_tls\_cfg::clientcert\_bytes (C++ member), 64  
 esp\_tls\_cfg::clientcert\_pem\_buf (C++ member), 64  
 esp\_tls\_cfg::clientcert\_pem\_bytes (C++ member), 64  
 esp\_tls\_cfg::clientkey\_buf (C++ member), 64  
 esp\_tls\_cfg::clientkey\_bytes (C++ member), 64  
 esp\_tls\_cfg::clientkey\_password (C++ member), 64  
 esp\_tls\_cfg::clientkey\_password\_len (C++ member), 64  
 esp\_tls\_cfg::clientkey\_pem\_buf (C++ member), 64  
 esp\_tls\_cfg::clientkey\_pem\_bytes (C++ member), 64  
 esp\_tls\_cfg::common\_name (C++ member), 65  
 esp\_tls\_cfg::crt\_bundle\_attach (C++ member), 65  
 esp\_tls\_cfg::ds\_data (C++ member), 65  
 esp\_tls\_cfg::ecdsa\_key\_efuse\_blk (C++ member), 65  
 esp\_tls\_cfg::if\_name (C++ member), 65  
 esp\_tls\_cfg::is\_plain\_tcp (C++ member), 65  
 esp\_tls\_cfg::keep\_alive\_cfg (C++ member), 65  
 esp\_tls\_cfg::non\_block (C++ member), 65  
 esp\_tls\_cfg::psk\_hint\_key (C++ member), 65  
 esp\_tls\_cfg::skip\_common\_name (C++ member), 65  
 esp\_tls\_cfg::timeout\_ms (C++ member), 65  
 esp\_tls\_cfg::tls\_version (C++ member), 66  
 esp\_tls\_cfg::use\_ecdsa\_peripheral (C++ member), 64  
 esp\_tls\_cfg::use\_global\_ca\_store (C++ member), 65  
 esp\_tls\_cfg::use\_secure\_element (C++ member), 65  
 esp\_tls\_cfg\_server (C++ struct), 66  
 esp\_tls\_cfg\_server::alpn\_protos (C++ member), 66  
 esp\_tls\_cfg\_server::cacert\_buf (C++ member), 66  
 esp\_tls\_cfg\_server::cacert\_bytes (C++ member), 66  
 esp\_tls\_cfg\_server::cacert\_pem\_buf (C++ member), 66  
 esp\_tls\_cfg\_server::cacert\_pem\_bytes (C++ member), 66  
 esp\_tls\_cfg\_server::ecdsa\_key\_efuse\_blk (C++ member), 67  
 esp\_tls\_cfg\_server::servercert\_buf (C++ member), 66  
 esp\_tls\_cfg\_server::servercert\_bytes (C++ member), 66  
 esp\_tls\_cfg\_server::servercert\_pem\_buf (C++ member), 66  
 esp\_tls\_cfg\_server::servercert\_pem\_bytes (C++ member), 66  
 esp\_tls\_cfg\_server::serverkey\_buf (C++ member), 66  
 esp\_tls\_cfg\_server::serverkey\_bytes (C++ member), 67  
 esp\_tls\_cfg\_server::serverkey\_password (C++ member), 67  
 esp\_tls\_cfg\_server::serverkey\_password\_len (C++ member), 67  
 esp\_tls\_cfg\_server::serverkey\_pem\_buf (C++ member), 66  
 esp\_tls\_cfg\_server::serverkey\_pem\_bytes (C++ member), 67  
 esp\_tls\_cfg\_server::use\_ecdsa\_peripheral (C++ member), 67  
 esp\_tls\_cfg\_server::use\_secure\_element (C++ member), 67  
 esp\_tls\_cfg\_server::userdata (C++ member), 67  
 esp\_tls\_cfg\_server\_session\_tickets\_free (C++ function), 57  
 esp\_tls\_cfg\_server\_session\_tickets\_init (C++ function), 57  
 esp\_tls\_cfg\_server\_t (C++ type), 68  
 esp\_tls\_cfg\_t (C++ type), 67  
 esp\_tls\_conn\_destroy (C++ function), 59  
 esp\_tls\_conn\_http\_new (C++ function), 57  
 esp\_tls\_conn\_http\_new\_async (C++ function), 59





- esp\_vfs\_eventfd\_config\_t::max\_fds (C++ member), 1695  
 esp\_vfs\_eventfd\_register (C++ function), 1694  
 esp\_vfs\_eventfd\_unregister (C++ function), 1694  
 esp\_vfs\_fat\_conf\_t (C++ struct), 1617  
 esp\_vfs\_fat\_conf\_t::base\_path (C++ member), 1618  
 esp\_vfs\_fat\_conf\_t::fat\_drive (C++ member), 1618  
 esp\_vfs\_fat\_conf\_t::max\_files (C++ member), 1618  
 esp\_vfs\_fat\_create\_contiguous\_file (C++ function), 1617  
 esp\_vfs\_fat\_info (C++ function), 1617  
 esp\_vfs\_fat\_mount\_config\_t (C++ struct), 1618  
 esp\_vfs\_fat\_mount\_config\_t::allocation\_size (C++ member), 1618  
 esp\_vfs\_fat\_mount\_config\_t::disk\_status\_checks\_enabled (C++ member), 1618  
 esp\_vfs\_fat\_mount\_config\_t::format\_if\_mount\_failed (C++ member), 1618  
 esp\_vfs\_fat\_mount\_config\_t::max\_files (C++ member), 1618  
 esp\_vfs\_fat\_mount\_config\_t::use\_one\_fat (C++ member), 1618  
 esp\_vfs\_fat\_register\_cfg (C++ function), 1612  
 esp\_vfs\_fat\_sdcard\_format (C++ function), 1614  
 esp\_vfs\_fat\_sdcard\_format\_cfg (C++ function), 1614  
 esp\_vfs\_fat\_sdcard\_unmount (C++ function), 1614  
 esp\_vfs\_fat\_sdmmc\_mount (C++ function), 1612  
 esp\_vfs\_fat\_sdmmc\_mount\_config\_t (C++ type), 1618  
 esp\_vfs\_fat\_sdmmc\_unmount (C++ function), 1614  
 esp\_vfs\_fat\_sdspi\_mount (C++ function), 1613  
 esp\_vfs\_fat\_spiflash\_format\_cfg\_rw\_wl (C++ function), 1615  
 esp\_vfs\_fat\_spiflash\_format\_rw\_wl (C++ function), 1616  
 esp\_vfs\_fat\_spiflash\_mount\_ro (C++ function), 1616  
 esp\_vfs\_fat\_spiflash\_mount\_rw\_wl (C++ function), 1615  
 esp\_vfs\_fat\_spiflash\_unmount\_ro (C++ function), 1616  
 esp\_vfs\_fat\_spiflash\_unmount\_rw\_wl (C++ function), 1615  
 esp\_vfs\_fat\_test\_contiguous\_file (C++ function), 1617  
 esp\_vfs\_fat\_unregister\_path (C++ function), 1612  
 ESP\_VFS\_FLAG\_CONTEXT\_PTR (C macro), 1691  
 ESP\_VFS\_FLAG\_DEFAULT (C macro), 1691  
 ESP\_VFS\_FLAG\_READONLY\_FS (C macro), 1691  
 esp\_vfs\_fstat (C++ function), 1683  
 esp\_vfs\_id\_t (C++ type), 1691  
 esp\_vfs\_l2tap\_eth\_filter (C++ function), 778  
 esp\_vfs\_l2tap\_intf\_register (C++ function), 778  
 esp\_vfs\_l2tap\_intf\_unregister (C++ function), 778  
 esp\_vfs\_link (C++ function), 1683  
 esp\_vfs\_lseek (C++ function), 1683  
 esp\_vfs\_open (C++ function), 1683  
 ESP\_VFS\_PATH\_MAX (C macro), 1691  
 esp\_vfs\_pread (C++ function), 1685  
 esp\_vfs\_pwrite (C++ function), 1685  
 esp\_vfs\_read (C++ function), 1683  
 esp\_vfs\_register (C++ function), 1683  
 esp\_vfs\_register\_fd (C++ function), 1684  
 esp\_vfs\_register\_fd\_range (C++ function), 1683  
 esp\_vfs\_register\_fd\_with\_local\_fd (C++ function), 1684  
 esp\_vfs\_register\_with\_id (C++ function), 1683  
 esp\_vfs\_rename (C++ function), 1683  
 esp\_vfs\_select (C++ function), 1684  
 esp\_vfs\_select\_sem\_t (C++ struct), 1686  
 esp\_vfs\_select\_sem\_t::is\_sem\_local (C++ member), 1686  
 esp\_vfs\_select\_sem\_t::sem (C++ member), 1686  
 esp\_vfs\_select\_triggered (C++ function), 1685  
 esp\_vfs\_select\_triggered\_isr (C++ function), 1685  
 esp\_vfs\_spiffs\_conf\_t (C++ struct), 1678  
 esp\_vfs\_spiffs\_conf\_t::base\_path (C++ member), 1678  
 esp\_vfs\_spiffs\_conf\_t::format\_if\_mount\_failed (C++ member), 1678  
 esp\_vfs\_spiffs\_conf\_t::max\_files (C++ member), 1678  
 esp\_vfs\_spiffs\_conf\_t::partition\_label (C++ member), 1678  
 esp\_vfs\_spiffs\_register (C++ function), 1677  
 esp\_vfs\_spiffs\_unregister (C++ function), 1677  
 esp\_vfs\_stat (C++ function), 1683  
 esp\_vfs\_t (C++ struct), 1686  
 esp\_vfs\_t::access (C++ member), 1689  
 esp\_vfs\_t::access\_p (C++ member), 1689  
 esp\_vfs\_t::close (C++ member), 1687  
 esp\_vfs\_t::close\_p (C++ member), 1687

- esp\_vfs\_t::closedir (C++ member), 1688  
 esp\_vfs\_t::closedir\_p (C++ member), 1688  
 esp\_vfs\_t::end\_select (C++ member), 1691  
 esp\_vfs\_t::fcntl (C++ member), 1689  
 esp\_vfs\_t::fcntl\_p (C++ member), 1689  
 esp\_vfs\_t::flags (C++ member), 1686  
 esp\_vfs\_t::fstat (C++ member), 1687  
 esp\_vfs\_t::fstat\_p (C++ member), 1687  
 esp\_vfs\_t::fsync (C++ member), 1689  
 esp\_vfs\_t::fsync\_p (C++ member), 1689  
 esp\_vfs\_t::ftruncate (C++ member), 1689  
 esp\_vfs\_t::ftruncate\_p (C++ member), 1689  
 esp\_vfs\_t::get\_socket\_select\_semaphore (C++ member), 1691  
 esp\_vfs\_t::ioctl (C++ member), 1689  
 esp\_vfs\_t::ioctl\_p (C++ member), 1689  
 esp\_vfs\_t::link (C++ member), 1687  
 esp\_vfs\_t::link\_p (C++ member), 1687  
 esp\_vfs\_t::lseek (C++ member), 1686  
 esp\_vfs\_t::lseek\_p (C++ member), 1686  
 esp\_vfs\_t::mkdir (C++ member), 1689  
 esp\_vfs\_t::mkdir\_p (C++ member), 1689  
 esp\_vfs\_t::open (C++ member), 1687  
 esp\_vfs\_t::open\_p (C++ member), 1687  
 esp\_vfs\_t::opendir (C++ member), 1688  
 esp\_vfs\_t::opendir\_p (C++ member), 1688  
 esp\_vfs\_t::pread (C++ member), 1687  
 esp\_vfs\_t::pread\_p (C++ member), 1687  
 esp\_vfs\_t::pwrite (C++ member), 1687  
 esp\_vfs\_t::pwrite\_p (C++ member), 1687  
 esp\_vfs\_t::read (C++ member), 1687  
 esp\_vfs\_t::read\_p (C++ member), 1687  
 esp\_vfs\_t::readdir (C++ member), 1688  
 esp\_vfs\_t::readdir\_p (C++ member), 1688  
 esp\_vfs\_t::readdir\_r (C++ member), 1688  
 esp\_vfs\_t::readdir\_r\_p (C++ member), 1688  
 esp\_vfs\_t::rename (C++ member), 1688  
 esp\_vfs\_t::rename\_p (C++ member), 1688  
 esp\_vfs\_t::rmdir (C++ member), 1689  
 esp\_vfs\_t::rmdir\_p (C++ member), 1689  
 esp\_vfs\_t::seekdir (C++ member), 1688  
 esp\_vfs\_t::seekdir\_p (C++ member), 1688  
 esp\_vfs\_t::socket\_select (C++ member), 1691  
 esp\_vfs\_t::start\_select (C++ member), 1691  
 esp\_vfs\_t::stat (C++ member), 1687  
 esp\_vfs\_t::stat\_p (C++ member), 1687  
 esp\_vfs\_t::stop\_socket\_select (C++ member), 1691  
 esp\_vfs\_t::stop\_socket\_select\_isr (C++ member), 1691  
 esp\_vfs\_t::tcdrain (C++ member), 1690  
 esp\_vfs\_t::tcdrain\_p (C++ member), 1690  
 esp\_vfs\_t::tcflow (C++ member), 1690  
 esp\_vfs\_t::tcflow\_p (C++ member), 1690  
 esp\_vfs\_t::tcflush (C++ member), 1690  
 esp\_vfs\_t::tcflush\_p (C++ member), 1690  
 esp\_vfs\_t::tcgetattr (C++ member), 1690  
 esp\_vfs\_t::tcgetattr\_p (C++ member), 1690  
 esp\_vfs\_t::tcgetsid (C++ member), 1690  
 esp\_vfs\_t::tcgetsid\_p (C++ member), 1690  
 esp\_vfs\_t::tcsendbreak (C++ member), 1690  
 esp\_vfs\_t::tcsendbreak\_p (C++ member), 1690  
 esp\_vfs\_t::tcsetattr (C++ member), 1690  
 esp\_vfs\_t::tcsetattr\_p (C++ member), 1690  
 esp\_vfs\_t::telldir (C++ member), 1688  
 esp\_vfs\_t::telldir\_p (C++ member), 1688  
 esp\_vfs\_t::truncate (C++ member), 1689  
 esp\_vfs\_t::truncate\_p (C++ member), 1689  
 esp\_vfs\_t::unlink (C++ member), 1688  
 esp\_vfs\_t::unlink\_p (C++ member), 1688  
 esp\_vfs\_t::utime (C++ member), 1690  
 esp\_vfs\_t::utime\_p (C++ member), 1690  
 esp\_vfs\_t::write (C++ member), 1686  
 esp\_vfs\_t::write\_p (C++ member), 1686  
 esp\_vfs\_unlink (C++ function), 1683  
 esp\_vfs\_unregister (C++ function), 1684  
 esp\_vfs\_unregister\_fd (C++ function), 1684  
 esp\_vfs\_unregister\_with\_id (C++ function), 1684  
 esp\_vfs\_usb\_serial\_jtag\_use\_driver (C++ function), 1693  
 esp\_vfs\_usb\_serial\_jtag\_use\_nonblocking (C++ function), 1693  
 esp\_vfs\_utime (C++ function), 1683  
 esp\_vfs\_write (C++ function), 1682  
 esp\_vhci\_host\_callback (C++ struct), 304  
 esp\_vhci\_host\_callback::notify\_host\_recv (C++ member), 305  
 esp\_vhci\_host\_callback::notify\_host\_send\_available (C++ member), 304  
 esp\_vhci\_host\_callback\_t (C++ type), 305  
 esp\_vhci\_host\_check\_send\_available (C++ function), 300  
 esp\_vhci\_host\_register\_callback (C++ function), 300  
 esp\_vhci\_host\_send\_packet (C++ function), 300  
 esp\_wake\_deep\_sleep (C++ function), 2034  
 esp\_wifi\_power\_domain\_off (C++ function), 2279  
 esp\_wifi\_power\_domain\_on (C++ function), 2279  
 essl\_clear\_intr (C++ function), 106  
 essl\_get\_intr (C++ function), 106  
 essl\_get\_intr\_ena (C++ function), 106  
 essl\_get\_packet (C++ function), 105  
 essl\_get\_rx\_data\_size (C++ function), 104  
 essl\_get\_tx\_buffer\_num (C++ function), 104  
 essl\_handle\_t (C++ type), 107  
 essl\_init (C++ function), 103  
 essl\_read\_reg (C++ function), 105  
 essl\_reset\_cnt (C++ function), 104  
 essl\_sdio\_config\_t (C++ struct), 107



- essl\_sdio\_config\_t::card (C++ member), 107  
 essl\_sdio\_config\_t::recv\_buffer\_size (C++ member), 107  
 essl\_sdio\_deinit\_dev (C++ function), 107  
 essl\_sdio\_init\_dev (C++ function), 107  
 essl\_send\_packet (C++ function), 104  
 essl\_send\_slave\_intr (C++ function), 106  
 essl\_set\_intr\_ena (C++ function), 106  
 essl\_spi\_config\_t (C++ struct), 113  
 essl\_spi\_config\_t::rx\_sync\_reg (C++ member), 113  
 essl\_spi\_config\_t::spi (C++ member), 113  
 essl\_spi\_config\_t::tx\_buf\_size (C++ member), 113  
 essl\_spi\_config\_t::tx\_sync\_reg (C++ member), 113  
 essl\_spi\_deinit\_dev (C++ function), 108  
 essl\_spi\_get\_packet (C++ function), 108  
 essl\_spi\_init\_dev (C++ function), 108  
 essl\_spi\_rdbuf (C++ function), 109  
 essl\_spi\_rdbuf\_polling (C++ function), 110  
 essl\_spi\_rddma (C++ function), 111  
 essl\_spi\_rddma\_done (C++ function), 111  
 essl\_spi\_rddma\_seg (C++ function), 111  
 essl\_spi\_read\_reg (C++ function), 108  
 essl\_spi\_reset\_cnt (C++ function), 109  
 essl\_spi\_send\_packet (C++ function), 109  
 essl\_spi\_wrbuf (C++ function), 110  
 essl\_spi\_wrbuf\_polling (C++ function), 111  
 essl\_spi\_wrdma (C++ function), 112  
 essl\_spi\_wrdma\_done (C++ function), 112  
 essl\_spi\_wrdma\_seg (C++ function), 112  
 essl\_spi\_write\_reg (C++ function), 108  
 essl\_wait\_for\_ready (C++ function), 104  
 essl\_wait\_int (C++ function), 105  
 essl\_write\_reg (C++ function), 105  
 eTaskGetState (C++ function), 1797  
 eTaskState (C++ enum), 1819  
 eTaskState::eBlocked (C++ enumerator), 1819  
 eTaskState::eDeleted (C++ enumerator), 1819  
 eTaskState::eInvalid (C++ enumerator), 1819  
 eTaskState::eReady (C++ enumerator), 1819  
 eTaskState::eRunning (C++ enumerator), 1819  
 eTaskState::eSuspended (C++ enumerator), 1819  
 eth\_checksum\_t (C++ enum), 705  
 eth\_checksum\_t::ETH\_CHECKSUM\_HW (C++ enumerator), 706  
 eth\_checksum\_t::ETH\_CHECKSUM\_SW (C++ enumerator), 705  
 ETH\_CMD\_CUSTOM\_MAC\_CMDS\_OFFSET (C macro), 714  
 ETH\_CMD\_CUSTOM\_PHY\_CMDS\_OFFSET (C macro), 714  
 eth\_data\_interface\_t (C++ enum), 705  
 eth\_data\_interface\_t::EMAC\_DATA\_INTERFACE\_MII (C++ enumerator), 727  
 eth\_data\_interface\_t::EMAC\_DATA\_INTERFACE\_RMII (C++ enumerator), 705  
 ETH\_DEFAULT\_CONFIG (C macro), 712  
 ETH\_DEFAULT\_SPI (C macro), 722  
 eth\_duplex\_t (C++ enum), 705  
 eth\_duplex\_t::ETH\_DUPLEX\_FULL (C++ enumerator), 705  
 eth\_duplex\_t::ETH\_DUPLEX\_HALF (C++ enumerator), 705  
 eth\_event\_t (C++ enum), 715  
 eth\_event\_t::ETHERNET\_EVENT\_CONNECTED (C++ enumerator), 715  
 eth\_event\_t::ETHERNET\_EVENT\_DISCONNECTED (C++ enumerator), 715  
 eth\_event\_t::ETHERNET\_EVENT\_START (C++ enumerator), 715  
 eth\_event\_t::ETHERNET\_EVENT\_STOP (C++ enumerator), 715  
 eth\_link\_t (C++ enum), 705  
 eth\_link\_t::ETH\_LINK\_DOWN (C++ enumerator), 705  
 eth\_link\_t::ETH\_LINK\_UP (C++ enumerator), 705  
 eth\_mac\_config\_t (C++ struct), 720  
 eth\_mac\_config\_t::flags (C++ member), 720  
 eth\_mac\_config\_t::rx\_task\_prio (C++ member), 720  
 eth\_mac\_config\_t::rx\_task\_stack\_size (C++ member), 720  
 eth\_mac\_config\_t::sw\_reset\_timeout\_ms (C++ member), 720  
 ETH\_MAC\_DEFAULT\_CONFIG (C macro), 720  
 eth\_mac\_dma\_burst\_len\_t (C++ enum), 706  
 eth\_mac\_dma\_burst\_len\_t::ETH\_DMA\_BURST\_LEN\_1 (C++ enumerator), 706  
 eth\_mac\_dma\_burst\_len\_t::ETH\_DMA\_BURST\_LEN\_16 (C++ enumerator), 706  
 eth\_mac\_dma\_burst\_len\_t::ETH\_DMA\_BURST\_LEN\_2 (C++ enumerator), 706  
 eth\_mac\_dma\_burst\_len\_t::ETH\_DMA\_BURST\_LEN\_2 (C++ enumerator), 706  
 eth\_mac\_dma\_burst\_len\_t::ETH\_DMA\_BURST\_LEN\_32 (C++ enumerator), 706  
 eth\_mac\_dma\_burst\_len\_t::ETH\_DMA\_BURST\_LEN\_4 (C++ enumerator), 706  
 eth\_mac\_dma\_burst\_len\_t::ETH\_DMA\_BURST\_LEN\_8 (C++ enumerator), 706  
 ETH\_MAC\_FLAG\_PIN\_TO\_CORE (C macro), 720  
 ETH\_MAC\_FLAG\_WORK\_WITH\_CACHE\_DISABLE (C macro), 720  
 eth\_phy\_autoneg\_cmd\_t (C++ enum), 727  
 eth\_phy\_autoneg\_cmd\_t::ESP\_ETH\_PHY\_AUTONEGO\_DIS (C++ enumerator), 727  
 eth\_phy\_autoneg\_cmd\_t::ESP\_ETH\_PHY\_AUTONEGO\_EN (C++ enumerator), 727  
 eth\_phy\_autoneg\_cmd\_t::ESP\_ETH\_PHY\_AUTONEGO\_G\_STA (C++ enumerator), 727  
 eth\_phy\_autoneg\_cmd\_t::ESP\_ETH\_PHY\_AUTONEGO\_RESTA (C++ enumerator), 727  
 eth\_phy\_config\_t (C++ struct), 727

- eth\_phy\_config\_t::autonego\_timeout\_ms (C++ member), 727
- eth\_phy\_config\_t::phy\_addr (C++ member), 727
- eth\_phy\_config\_t::reset\_gpio\_num (C++ member), 727
- eth\_phy\_config\_t::reset\_timeout\_ms (C++ member), 727
- ETH\_PHY\_DEFAULT\_CONFIG (C macro), 727
- eth\_speed\_t (C++ enum), 705
- eth\_speed\_t::ETH\_SPEED\_100M (C++ enumerator), 705
- eth\_speed\_t::ETH\_SPEED\_10M (C++ enumerator), 705
- eth\_speed\_t::ETH\_SPEED\_MAX (C++ enumerator), 705
- eth\_spi\_custom\_driver\_config\_t (C++ struct), 721
- eth\_spi\_custom\_driver\_config\_t::config (C++ member), 721
- eth\_spi\_custom\_driver\_config\_t::deinit (C++ member), 721
- eth\_spi\_custom\_driver\_config\_t::init (C++ member), 721
- eth\_spi\_custom\_driver\_config\_t::read (C++ member), 722
- eth\_spi\_custom\_driver\_config\_t::write (C++ member), 722
- ETS\_INTERNAL\_INTR\_SOURCE\_OFF (C macro), 1972
- ETS\_INTERNAL\_PROFILING\_INTR\_SOURCE (C macro), 1971
- ETS\_INTERNAL\_SW0\_INTR\_SOURCE (C macro), 1971
- ETS\_INTERNAL\_SW1\_INTR\_SOURCE (C macro), 1971
- ETS\_INTERNAL\_TIMER0\_INTR\_SOURCE (C macro), 1971
- ETS\_INTERNAL\_TIMER1\_INTR\_SOURCE (C macro), 1971
- ETS\_INTERNAL\_TIMER2\_INTR\_SOURCE (C macro), 1971
- ETS\_INTERNAL\_UNUSED\_INTR\_SOURCE (C macro), 1972
- EventBits\_t (C++ type), 1880
- eventfd (C++ function), 1695
- EventGroupHandle\_t (C++ type), 1880
- EXT\_ADV\_NUM\_SETS\_MAX (C macro), 229
- EXT\_ADV\_TX\_PWR\_NO\_PREFERENCE (C macro), 229
- F**
- ff\_diskio\_impl\_t (C++ struct), 1609
- ff\_diskio\_impl\_t::init (C++ member), 1610
- ff\_diskio\_impl\_t::ioctl (C++ member), 1610
- ff\_diskio\_impl\_t::read (C++ member), 1610
- ff\_diskio\_impl\_t::status (C++ member), 1610
- ff\_diskio\_impl\_t::write (C++ member), 1610
- ff\_diskio\_register (C++ function), 1609
- ff\_diskio\_register\_raw\_partition (C++ function), 1610
- ff\_diskio\_register\_sdmmc (C++ function), 1610
- ff\_diskio\_register\_wl\_partition (C++ function), 1610
- G**
- get\_phy\_version\_str (C++ function), 2277
- gpio\_config (C++ function), 843
- gpio\_config\_t (C++ struct), 850
- gpio\_config\_t::hys\_ctrl\_mode (C++ member), 850
- gpio\_config\_t::intr\_type (C++ member), 850
- gpio\_config\_t::mode (C++ member), 850
- gpio\_config\_t::pin\_bit\_mask (C++ member), 850
- gpio\_config\_t::pull\_down\_en (C++ member), 850
- gpio\_config\_t::pull\_up\_en (C++ member), 850
- gpio\_del\_glitch\_filter (C++ function), 857
- gpio\_drive\_cap\_t (C++ enum), 855
- gpio\_drive\_cap\_t::GPIO\_DRIVE\_CAP\_0 (C++ enumerator), 855
- gpio\_drive\_cap\_t::GPIO\_DRIVE\_CAP\_1 (C++ enumerator), 855
- gpio\_drive\_cap\_t::GPIO\_DRIVE\_CAP\_2 (C++ enumerator), 855
- gpio\_drive\_cap\_t::GPIO\_DRIVE\_CAP\_3 (C++ enumerator), 856
- gpio\_drive\_cap\_t::GPIO\_DRIVE\_CAP\_DEFAULT (C++ enumerator), 855
- gpio\_drive\_cap\_t::GPIO\_DRIVE\_CAP\_MAX (C++ enumerator), 856
- gpio\_dump\_io\_configuration (C++ function), 850
- gpio\_etm\_event\_bind\_gpio (C++ function), 837
- gpio\_etm\_event\_config\_t (C++ struct), 838
- gpio\_etm\_event\_config\_t::edge (C++ member), 838
- gpio\_etm\_event\_config\_t::edges (C++ member), 838
- gpio\_etm\_event\_edge\_t (C++ enum), 839
- gpio\_etm\_event\_edge\_t::GPIO\_ETM\_EVENT\_EDGE\_ANY (C++ enumerator), 839
- gpio\_etm\_event\_edge\_t::GPIO\_ETM\_EVENT\_EDGE\_NEG (C++ enumerator), 839
- gpio\_etm\_event\_edge\_t::GPIO\_ETM\_EVENT\_EDGE\_POS (C++ enumerator), 839
- GPIO\_ETM\_EVENT\_EDGE\_TYPES (C macro), 839

- gpio\_etm\_task\_action\_t (C++ enum), 839  
 gpio\_etm\_task\_action\_t::GPIO\_ETM\_TASK\_ACTION\_ (C++ enumerator), 854  
   (C++ enumerator), 839  
 gpio\_etm\_task\_action\_t::GPIO\_ETM\_TASK\_ACTION\_ (C++ enumerator), 854  
   (C++ enumerator), 839  
 gpio\_etm\_task\_action\_t::GPIO\_ETM\_TASK\_ACTION\_ (C++ enumerator), 854  
   (C++ enumerator), 839  
 GPIO\_ETM\_TASK\_ACTION\_TYPES (C macro), 839  
 gpio\_etm\_task\_add\_gpio (C++ function), 837  
 gpio\_etm\_task\_config\_t (C++ struct), 838  
 gpio\_etm\_task\_config\_t::action (C++ member), 839  
 gpio\_etm\_task\_config\_t::actions (C++ member), 839  
 gpio\_etm\_task\_rm\_gpio (C++ function), 838  
 gpio\_flex\_glitch\_filter\_config\_t (C++ struct), 858  
 gpio\_flex\_glitch\_filter\_config\_t::clk\_src (C++ member), 858  
 gpio\_flex\_glitch\_filter\_config\_t::gpio\_num (C++ member), 858  
 gpio\_flex\_glitch\_filter\_config\_t::window\_threshold (C++ member), 858  
 gpio\_flex\_glitch\_filter\_config\_t::window\_width (C++ member), 858  
 gpio\_force\_hold\_all (C++ function), 849  
 gpio\_force\_unhold\_all (C++ function), 849  
 gpio\_get\_drive\_capability (C++ function), 848  
 gpio\_get\_level (C++ function), 845  
 gpio\_glitch\_filter\_disable (C++ function), 857  
 gpio\_glitch\_filter\_enable (C++ function), 857  
 gpio\_glitch\_filter\_handle\_t (C++ type), 858  
 gpio\_hold\_dis (C++ function), 848  
 gpio\_hold\_en (C++ function), 848  
 gpio\_hys\_ctrl\_mode\_t (C++ enum), 856  
 gpio\_hys\_ctrl\_mode\_t::GPIO\_HYS\_CTRL\_EFUSE (C++ enumerator), 856  
 gpio\_hys\_ctrl\_mode\_t::GPIO\_HYS\_SOFT\_DISABLE (C++ enumerator), 856  
 gpio\_hys\_ctrl\_mode\_t::GPIO\_HYS\_SOFT\_ENABLE (C++ enumerator), 856  
 gpio\_install\_isr\_service (C++ function), 847  
 gpio\_int\_type\_t (C++ enum), 854  
 gpio\_int\_type\_t::GPIO\_INTR\_ANYEDGE (C++ enumerator), 854  
 gpio\_int\_type\_t::GPIO\_INTR\_DISABLE (C++ enumerator), 854  
 gpio\_int\_type\_t::GPIO\_INTR\_HIGH\_LEVEL (C++ enumerator), 854  
 gpio\_int\_type\_t::GPIO\_INTR\_LOW\_LEVEL (C++ enumerator), 854  
 gpio\_int\_type\_t::GPIO\_INTR\_MAX (C++ enumerator), 854  
 gpio\_int\_type\_t::GPIO\_INTR\_NEGEDGE (C++ enumerator), 854  
 gpio\_int\_type\_t::GPIO\_INTR\_POSEDGE (C++ enumerator), 854  
 gpio\_intr\_disable (C++ function), 844  
 gpio\_intr\_enable (C++ function), 844  
 gpio\_iomux\_in (C++ function), 848  
 gpio\_iomux\_out (C++ function), 848  
 GPIO\_IS\_VALID\_DIGITAL\_IO\_PAD (C macro), 851  
 GPIO\_IS\_VALID\_GPIO (C macro), 851  
 GPIO\_IS\_VALID\_OUTPUT\_GPIO (C macro), 851  
 gpio\_isr\_handle\_t (C++ type), 851  
 gpio\_isr\_handler\_add (C++ function), 847  
 gpio\_isr\_handler\_remove (C++ function), 847  
 gpio\_isr\_register (C++ function), 846  
 gpio\_isr\_t (C++ type), 851  
 gpio\_mode\_t (C++ enum), 854  
 gpio\_mode\_t::GPIO\_MODE\_DISABLE (C++ enumerator), 854  
 gpio\_mode\_t::GPIO\_MODE\_INPUT (C++ enumerator), 854  
 gpio\_mode\_t::GPIO\_MODE\_INPUT\_OUTPUT (C++ enumerator), 854  
 gpio\_mode\_t::GPIO\_MODE\_INPUT\_OUTPUT\_OD (C++ enumerator), 854  
 gpio\_mode\_t::GPIO\_MODE\_OUTPUT (C++ enumerator), 854  
 gpio\_mode\_t::GPIO\_MODE\_OUTPUT\_OD (C++ enumerator), 854  
 gpio\_new\_etm\_event (C++ function), 836  
 gpio\_new\_etm\_task (C++ function), 837  
 gpio\_new\_flex\_glitch\_filter (C++ function), 857  
 gpio\_new\_pin\_glitch\_filter (C++ function), 856  
 GPIO\_PIN\_COUNT (C macro), 851  
 gpio\_pin\_glitch\_filter\_config\_t (C++ struct), 858  
 gpio\_pin\_glitch\_filter\_config\_t::clk\_src (C++ member), 858  
 gpio\_pin\_glitch\_filter\_config\_t::gpio\_num (C++ member), 858  
 GPIO\_PIN\_REG\_0 (C macro), 851  
 GPIO\_PIN\_REG\_1 (C macro), 851  
 GPIO\_PIN\_REG\_10 (C macro), 851  
 GPIO\_PIN\_REG\_11 (C macro), 851  
 GPIO\_PIN\_REG\_12 (C macro), 852  
 GPIO\_PIN\_REG\_13 (C macro), 852  
 GPIO\_PIN\_REG\_14 (C macro), 852  
 GPIO\_PIN\_REG\_15 (C macro), 852  
 GPIO\_PIN\_REG\_16 (C macro), 852  
 GPIO\_PIN\_REG\_17 (C macro), 852  
 GPIO\_PIN\_REG\_18 (C macro), 852  
 GPIO\_PIN\_REG\_19 (C macro), 852  
 GPIO\_PIN\_REG\_2 (C macro), 851  
 GPIO\_PIN\_REG\_20 (C macro), 852  
 GPIO\_PIN\_REG\_21 (C macro), 852

- GPIO\_PIN\_REG\_22 (*C macro*), 852
- GPIO\_PIN\_REG\_23 (*C macro*), 852
- GPIO\_PIN\_REG\_24 (*C macro*), 852
- GPIO\_PIN\_REG\_25 (*C macro*), 852
- GPIO\_PIN\_REG\_26 (*C macro*), 852
- GPIO\_PIN\_REG\_27 (*C macro*), 852
- GPIO\_PIN\_REG\_28 (*C macro*), 852
- GPIO\_PIN\_REG\_29 (*C macro*), 852
- GPIO\_PIN\_REG\_3 (*C macro*), 851
- GPIO\_PIN\_REG\_30 (*C macro*), 852
- GPIO\_PIN\_REG\_31 (*C macro*), 852
- GPIO\_PIN\_REG\_32 (*C macro*), 852
- GPIO\_PIN\_REG\_33 (*C macro*), 852
- GPIO\_PIN\_REG\_34 (*C macro*), 852
- GPIO\_PIN\_REG\_35 (*C macro*), 853
- GPIO\_PIN\_REG\_36 (*C macro*), 853
- GPIO\_PIN\_REG\_37 (*C macro*), 853
- GPIO\_PIN\_REG\_38 (*C macro*), 853
- GPIO\_PIN\_REG\_39 (*C macro*), 853
- GPIO\_PIN\_REG\_4 (*C macro*), 851
- GPIO\_PIN\_REG\_40 (*C macro*), 853
- GPIO\_PIN\_REG\_41 (*C macro*), 853
- GPIO\_PIN\_REG\_42 (*C macro*), 853
- GPIO\_PIN\_REG\_43 (*C macro*), 853
- GPIO\_PIN\_REG\_44 (*C macro*), 853
- GPIO\_PIN\_REG\_45 (*C macro*), 853
- GPIO\_PIN\_REG\_46 (*C macro*), 853
- GPIO\_PIN\_REG\_47 (*C macro*), 853
- GPIO\_PIN\_REG\_48 (*C macro*), 853
- GPIO\_PIN\_REG\_49 (*C macro*), 853
- GPIO\_PIN\_REG\_5 (*C macro*), 851
- GPIO\_PIN\_REG\_50 (*C macro*), 853
- GPIO\_PIN\_REG\_51 (*C macro*), 853
- GPIO\_PIN\_REG\_52 (*C macro*), 853
- GPIO\_PIN\_REG\_53 (*C macro*), 853
- GPIO\_PIN\_REG\_54 (*C macro*), 853
- GPIO\_PIN\_REG\_6 (*C macro*), 851
- GPIO\_PIN\_REG\_7 (*C macro*), 851
- GPIO\_PIN\_REG\_8 (*C macro*), 851
- GPIO\_PIN\_REG\_9 (*C macro*), 851
- gpio\_port\_t (*C++ enum*), 854
- gpio\_port\_t::GPIO\_PORT\_0 (*C++ enumerator*), 854
- gpio\_port\_t::GPIO\_PORT\_MAX (*C++ enumerator*), 854
- gpio\_pull\_mode\_t (*C++ enum*), 855
- gpio\_pull\_mode\_t::GPIO\_FLOATING (*C++ enumerator*), 855
- gpio\_pull\_mode\_t::GPIO\_PULLDOWN\_ONLY (*C++ enumerator*), 855
- gpio\_pull\_mode\_t::GPIO\_PULLUP\_ONLY (*C++ enumerator*), 855
- gpio\_pull\_mode\_t::GPIO\_PULLUP\_PULLDOWN (*C++ enumerator*), 855
- gpio pulldown\_dis (*C++ function*), 846
- gpio pulldown\_en (*C++ function*), 846
- gpio pulldown\_t (*C++ enum*), 855
- gpio pulldown\_t::GPIO\_PULLDOWN\_DISABLE (*C++ enumerator*), 855
- gpio pulldown\_t::GPIO\_PULLDOWN\_ENABLE (*C++ enumerator*), 855
- gpio pullup\_dis (*C++ function*), 846
- gpio pullup\_en (*C++ function*), 846
- gpio pullup\_t (*C++ enum*), 855
- gpio pullup\_t::GPIO\_PULLUP\_DISABLE (*C++ enumerator*), 855
- gpio pullup\_t::GPIO\_PULLUP\_ENABLE (*C++ enumerator*), 855
- gpio\_reset\_pin (*C++ function*), 844
- gpio\_set\_direction (*C++ function*), 845
- gpio\_set\_drive\_capability (*C++ function*), 847
- gpio\_set\_intr\_type (*C++ function*), 844
- gpio\_set\_level (*C++ function*), 844
- gpio\_set\_pull\_mode (*C++ function*), 845
- gpio\_sleep\_sel\_dis (*C++ function*), 849
- gpio\_sleep\_sel\_en (*C++ function*), 849
- gpio\_sleep\_set\_direction (*C++ function*), 849
- gpio\_sleep\_set\_pull\_mode (*C++ function*), 849
- gpio\_uninstall\_isr\_service (*C++ function*), 847
- gpio\_wakeup\_disable (*C++ function*), 846
- gpio\_wakeup\_enable (*C++ function*), 845
- gptimer\_alarm\_cb\_t (*C++ type*), 872
- gptimer\_alarm\_config\_t (*C++ struct*), 870
- gptimer\_alarm\_config\_t::alarm\_count (*C++ member*), 870
- gptimer\_alarm\_config\_t::auto\_reload\_on\_alarm (*C++ member*), 870
- gptimer\_alarm\_config\_t::flags (*C++ member*), 870
- gptimer\_alarm\_config\_t::reload\_count (*C++ member*), 870
- gptimer\_alarm\_event\_data\_t (*C++ struct*), 872
- gptimer\_alarm\_event\_data\_t::alarm\_value (*C++ member*), 872
- gptimer\_alarm\_event\_data\_t::count\_value (*C++ member*), 872
- gptimer\_clock\_source\_t (*C++ type*), 872
- gptimer\_config\_t (*C++ struct*), 869
- gptimer\_config\_t::backup\_before\_sleep (*C++ member*), 869
- gptimer\_config\_t::clk\_src (*C++ member*), 869
- gptimer\_config\_t::direction (*C++ member*), 869
- gptimer\_config\_t::flags (*C++ member*), 870
- gptimer\_config\_t::intr\_priority (*C++ member*), 869
- gptimer\_config\_t::intr\_shared (*C++ member*), 869
- gptimer\_config\_t::resolution\_hz (*C++*

- member), 869  
 gptimer\_count\_direction\_t (C++ enum), 873  
 gptimer\_count\_direction\_t::GPTIMER\_COUNT\_DIRECTION\_DOWN (C++ enumerator), 873  
 gptimer\_count\_direction\_t::GPTIMER\_COUNT\_DIRECTION\_UP (C++ enumerator), 873  
 gptimer\_del\_timer (C++ function), 864  
 gptimer\_disable (C++ function), 868  
 gptimer\_enable (C++ function), 867  
 gptimer\_etm\_event\_config\_t (C++ struct), 871  
 gptimer\_etm\_event\_config\_t::event\_type (C++ member), 871  
 gptimer\_etm\_event\_type\_t (C++ enum), 873  
 gptimer\_etm\_event\_type\_t::GPTIMER\_ETM\_EVENT\_ALARM (C++ enumerator), 873  
 gptimer\_etm\_event\_type\_t::GPTIMER\_ETM\_EVENT\_MAX (C++ enumerator), 873  
 gptimer\_etm\_task\_config\_t (C++ struct), 871  
 gptimer\_etm\_task\_config\_t::task\_type (C++ member), 871  
 gptimer\_etm\_task\_type\_t (C++ enum), 873  
 gptimer\_etm\_task\_type\_t::GPTIMER\_ETM\_TASK\_CAPTURE (C++ enumerator), 873  
 gptimer\_etm\_task\_type\_t::GPTIMER\_ETM\_TASK\_ENABLE (C++ enumerator), 873  
 gptimer\_etm\_task\_type\_t::GPTIMER\_ETM\_TASK\_MAX (C++ enumerator), 873  
 gptimer\_etm\_task\_type\_t::GPTIMER\_ETM\_TASK\_REPEAT (C++ enumerator), 873  
 gptimer\_etm\_task\_type\_t::GPTIMER\_ETM\_TASK\_STARTS\_COUNT (C++ enumerator), 873  
 gptimer\_etm\_task\_type\_t::GPTIMER\_ETM\_TASK\_STOPS\_COUNT (C++ enumerator), 873  
 gptimer\_event\_callbacks\_t (C++ struct), 870  
 gptimer\_event\_callbacks\_t::on\_alarm (C++ member), 870  
 gptimer\_get\_captured\_count (C++ function), 866  
 gptimer\_get\_raw\_count (C++ function), 865  
 gptimer\_get\_resolution (C++ function), 866  
 gptimer\_handle\_t (C++ type), 872  
 gptimer\_new\_etm\_event (C++ function), 871  
 gptimer\_new\_etm\_task (C++ function), 871  
 gptimer\_new\_timer (C++ function), 864  
 gptimer\_register\_event\_callbacks (C++ function), 866  
 gptimer\_set\_alarm\_action (C++ function), 867  
 gptimer\_set\_raw\_count (C++ function), 865  
 gptimer\_start (C++ function), 868  
 gptimer\_stop (C++ function), 869
- H**
- heap\_caps\_add\_region (C++ function), 1935  
 heap\_caps\_add\_region\_with\_caps (C++ function), 1936  
 heap\_caps\_aligned\_alloc (C++ function), 1928  
 heap\_caps\_aligned\_calloc (C++ function), 1928  
 heap\_caps\_aligned\_free (C++ function), 1928  
 heap\_caps\_calloc (C++ function), 1929  
 heap\_caps\_calloc\_prefer (C++ function), 1932  
 heap\_caps\_check\_integrity (C++ function), 1930  
 heap\_caps\_check\_integrity\_addr (C++ function), 1931  
 heap\_caps\_check\_integrity\_all (C++ function), 1930  
 heap\_caps\_dump\_all (C++ function), 1932  
 heap\_caps\_enable\_nonos\_stack\_heaps (C++ function), 1935  
 heap\_caps\_free (C++ function), 1928  
 heap\_caps\_get\_allocated\_size (C++ function), 1932  
 heap\_caps\_get\_free\_size (C++ function), 1929  
 heap\_caps\_get\_info (C++ function), 1930  
 heap\_caps\_get\_largest\_free\_block (C++ function), 1929  
 heap\_caps\_get\_minimum\_free\_size (C++ function), 1929  
 heap\_caps\_get\_total\_size (C++ function), 1929  
 heap\_caps\_malloc (C++ function), 1928  
 heap\_caps\_malloc\_extmem\_enable (C++ function), 1931  
 heap\_caps\_malloc\_prefer (C++ function), 1931  
 heap\_caps\_monitor\_local\_minimum\_free\_size\_start (C++ function), 1930  
 heap\_caps\_monitor\_local\_minimum\_free\_size\_stop (C++ function), 1930  
 heap\_caps\_print\_heap\_info (C++ function), 1930  
 heap\_caps\_realloc (C++ function), 1928  
 heap\_caps\_realloc\_prefer (C++ function), 1931  
 heap\_caps\_register\_failed\_alloc\_callback (C++ function), 1927  
 heap\_caps\_walk (C++ function), 1932  
 heap\_caps\_walk\_all (C++ function), 1932  
 heap\_caps\_walker\_cb\_t (C++ type), 1935  
 HEAP\_IRAM\_ATTR (C macro), 1933  
 heap\_trace\_dump (C++ function), 1956  
 heap\_trace\_dump\_caps (C++ function), 1956  
 heap\_trace\_get (C++ function), 1956  
 heap\_trace\_get\_count (C++ function), 1956  
 heap\_trace\_init\_standalone (C++ function), 1955  
 heap\_trace\_init\_tohost (C++ function), 1955



- heap\_trace\_mode\_t (C++ enum), 1958  
 heap\_trace\_mode\_t::HEAP\_TRACE\_ALL (C++ enumerator), 1958  
 heap\_trace\_mode\_t::HEAP\_TRACE\_LEAKS (C++ enumerator), 1958  
 heap\_trace\_record\_t (C++ struct), 1956  
 heap\_trace\_record\_t (C++ type), 1958  
 heap\_trace\_record\_t::address (C++ member), 1957  
 heap\_trace\_record\_t::allocated\_by (C++ member), 1957  
 heap\_trace\_record\_t::ccount (C++ member), 1957  
 heap\_trace\_record\_t::freed\_by (C++ member), 1957  
 heap\_trace\_record\_t::size (C++ member), 1957  
 heap\_trace\_resume (C++ function), 1955  
 heap\_trace\_start (C++ function), 1955  
 heap\_trace\_stop (C++ function), 1955  
 heap\_trace\_summary (C++ function), 1956  
 heap\_trace\_summary\_t (C++ struct), 1957  
 heap\_trace\_summary\_t::capacity (C++ member), 1957  
 heap\_trace\_summary\_t::count (C++ member), 1957  
 heap\_trace\_summary\_t::has\_overflowed (C++ member), 1957  
 heap\_trace\_summary\_t::high\_water\_mark (C++ member), 1957  
 heap\_trace\_summary\_t::mode (C++ member), 1957  
 heap\_trace\_summary\_t::total\_allocations (C++ member), 1957  
 heap\_trace\_summary\_t::total\_frees (C++ member), 1957  
 hmac\_key\_id\_t (C++ enum), 882  
 hmac\_key\_id\_t::HMAC\_KEY0 (C++ enumerator), 882  
 hmac\_key\_id\_t::HMAC\_KEY1 (C++ enumerator), 882  
 hmac\_key\_id\_t::HMAC\_KEY2 (C++ enumerator), 882  
 hmac\_key\_id\_t::HMAC\_KEY3 (C++ enumerator), 882  
 hmac\_key\_id\_t::HMAC\_KEY4 (C++ enumerator), 882  
 hmac\_key\_id\_t::HMAC\_KEY5 (C++ enumerator), 882  
 hmac\_key\_id\_t::HMAC\_KEY\_MAX (C++ enumerator), 882  
 HTTP\_ANY (C macro), 139  
 http\_client\_init\_cb\_t (C++ type), 1768  
 http\_event\_handle\_cb (C++ type), 86  
 HTTPD\_200 (C macro), 139  
 HTTPD\_204 (C macro), 139  
 HTTPD\_207 (C macro), 139  
 HTTPD\_400 (C macro), 139  
 HTTPD\_404 (C macro), 139  
 HTTPD\_408 (C macro), 139  
 HTTPD\_500 (C macro), 139  
 httpd\_close\_func\_t (C++ type), 141  
 httpd\_config (C++ struct), 135  
 httpd\_config::backlog\_conn (C++ member), 136  
 httpd\_config::close\_fn (C++ member), 137  
 httpd\_config::core\_id (C++ member), 135  
 httpd\_config::ctrl\_port (C++ member), 135  
 httpd\_config::enable\_so\_linger (C++ member), 136  
 httpd\_config::global\_transport\_ctx (C++ member), 136  
 httpd\_config::global\_transport\_ctx\_free\_fn (C++ member), 136  
 httpd\_config::global\_user\_ctx (C++ member), 136  
 httpd\_config::global\_user\_ctx\_free\_fn (C++ member), 136  
 httpd\_config::keep\_alive\_count (C++ member), 136  
 httpd\_config::keep\_alive\_enable (C++ member), 136  
 httpd\_config::keep\_alive\_idle (C++ member), 136  
 httpd\_config::keep\_alive\_interval (C++ member), 136  
 httpd\_config::linger\_timeout (C++ member), 136  
 httpd\_config::lru\_purge\_enable (C++ member), 136  
 httpd\_config::max\_open\_sockets (C++ member), 135  
 httpd\_config::max\_resp\_headers (C++ member), 135  
 httpd\_config::max\_uri\_handlers (C++ member), 135  
 httpd\_config::open\_fn (C++ member), 137  
 httpd\_config::recv\_wait\_timeout (C++ member), 136  
 httpd\_config::send\_wait\_timeout (C++ member), 136  
 httpd\_config::server\_port (C++ member), 135  
 httpd\_config::stack\_size (C++ member), 135  
 httpd\_config::task\_caps (C++ member), 135  
 httpd\_config::task\_priority (C++ member), 135  
 httpd\_config::uri\_match\_fn (C++ member), 137  
 httpd\_config\_t (C++ type), 141  
 HTTPD\_DEFAULT\_CONFIG (C macro), 140  
 httpd\_err\_code\_t (C++ enum), 143  
 httpd\_err\_code\_t::HTTPD\_400\_BAD\_REQUEST (C++ enumerator), 143  
 httpd\_err\_code\_t::HTTPD\_401\_UNAUTHORIZED

- (C++ enumerator), 143
- httpd\_err\_code\_t::HTTPD\_403\_FORBIDDEN (C++ enumerator), 143
- httpd\_err\_code\_t::HTTPD\_404\_NOT\_FOUND (C++ enumerator), 143
- httpd\_err\_code\_t::HTTPD\_405\_METHOD\_NOT\_ALLOWED (C++ enumerator), 143
- httpd\_err\_code\_t::HTTPD\_408\_REQ\_TIMEOUT (C++ enumerator), 143
- httpd\_err\_code\_t::HTTPD\_411\_LENGTH\_REQUIRED (C++ enumerator), 143
- httpd\_err\_code\_t::HTTPD\_414\_URI\_TOO\_LONG (C++ enumerator), 143
- httpd\_err\_code\_t::HTTPD\_431\_REQ\_HDR\_FIELDS\_TOO\_LARGE (C++ enumerator), 143
- httpd\_err\_code\_t::HTTPD\_500\_INTERNAL\_SERVER\_ERROR (C++ enumerator), 143
- httpd\_err\_code\_t::HTTPD\_501\_METHOD\_NOT\_IMPLEMENTED (C++ enumerator), 143
- httpd\_err\_code\_t::HTTPD\_505\_VERSION\_NOT\_SUPPORTED (C++ enumerator), 143
- httpd\_err\_code\_t::HTTPD\_ERR\_CODE\_MAX (C++ enumerator), 143
- httpd\_err\_handler\_func\_t (C++ type), 142
- httpd\_free\_ctx\_fn\_t (C++ type), 140
- httpd\_get\_client\_list (C++ function), 134
- httpd\_get\_global\_transport\_ctx (C++ function), 133
- httpd\_get\_global\_user\_ctx (C++ function), 133
- httpd\_handle\_t (C++ type), 140
- HTTPD\_MAX\_REQ\_HDR\_LEN (C macro), 139
- HTTPD\_MAX\_URI\_LEN (C macro), 139
- httpd\_method\_t (C++ type), 140
- httpd\_open\_func\_t (C++ type), 140
- httpd\_pending\_func\_t (C++ type), 142
- httpd\_query\_key\_value (C++ function), 125
- httpd\_queue\_work (C++ function), 132
- httpd\_rcv\_func\_t (C++ type), 142
- httpd\_register\_err\_handler (C++ function), 132
- httpd\_register\_uri\_handler (C++ function), 120
- httpd\_req (C++ struct), 137
- httpd\_req::aux (C++ member), 138
- httpd\_req::content\_len (C++ member), 137
- httpd\_req::free\_ctx (C++ member), 138
- httpd\_req::handle (C++ member), 137
- httpd\_req::ignore\_sess\_ctx\_changes (C++ member), 138
- httpd\_req::method (C++ member), 137
- httpd\_req::sess\_ctx (C++ member), 138
- httpd\_req::uri (C++ member), 137
- httpd\_req::user\_ctx (C++ member), 138
- httpd\_req\_async\_handler\_begin (C++ function), 122
- httpd\_req\_async\_handler\_complete (C++ function), 122
- httpd\_req\_get\_cookie\_val (C++ function), 125
- httpd\_req\_get\_hdr\_value\_len (C++ function), 123
- httpd\_req\_get\_hdr\_value\_str (C++ function), 124
- httpd\_req\_get\_url\_query\_len (C++ function), 124
- httpd\_req\_get\_url\_query\_str (C++ function), 124
- httpd\_req\_rcv (C++ function), 123
- httpd\_req\_t (C++ type), 141
- httpd\_req\_to\_sockfd (C++ function), 122
- httpd\_req\_to\_sockfd\_err (C++ function), 126
- httpd\_resp\_send\_404 (C++ function), 129
- httpd\_resp\_send\_408 (C++ function), 130
- httpd\_resp\_send\_500 (C++ function), 130
- httpd\_resp\_send\_chunk (C++ function), 126
- httpd\_resp\_send\_custom\_err (C++ function), 129
- httpd\_resp\_send\_err (C++ function), 129
- httpd\_resp\_sendstr (C++ function), 127
- httpd\_resp\_sendstr\_chunk (C++ function), 127
- httpd\_resp\_set\_hdr (C++ function), 128
- httpd\_resp\_set\_status (C++ function), 127
- httpd\_resp\_set\_type (C++ function), 128
- HTTPD\_RESP\_USE\_STRLEN (C macro), 140
- httpd\_send (C++ function), 130
- httpd\_send\_func\_t (C++ type), 141
- httpd\_sess\_get\_ctx (C++ function), 132
- httpd\_sess\_get\_transport\_ctx (C++ function), 133
- httpd\_sess\_set\_ctx (C++ function), 133
- httpd\_sess\_set\_pending\_override (C++ function), 122
- httpd\_sess\_set\_rcv\_override (C++ function), 121
- httpd\_sess\_set\_send\_override (C++ function), 121
- httpd\_sess\_set\_transport\_ctx (C++ function), 133
- httpd\_sess\_trigger\_close (C++ function), 133
- httpd\_sess\_update\_lru\_counter (C++ function), 134
- HTTPD\_SOCK\_ERR\_FAIL (C macro), 139
- HTTPD\_SOCK\_ERR\_INVALID (C macro), 139
- HTTPD\_SOCK\_ERR\_TIMEOUT (C macro), 139
- httpd\_socket\_rcv (C++ function), 131
- httpd\_socket\_send (C++ function), 131
- httpd\_ssl\_config (C++ struct), 146
- httpd\_ssl\_config::alpn\_protos (C++ member), 147
- httpd\_ssl\_config::cacert\_len (C++ member), 147
- httpd\_ssl\_config::cacert\_pem (C++ member), 146

- [httpd\\_ssl\\_config::cert\\_select\\_cb \(C++ member\), 147](#)  
[httpd\\_ssl\\_config::ecdsa\\_key\\_efuse\\_blk \(C++ member\), 147](#)  
[httpd\\_ssl\\_config::httpd \(C++ member\), 146](#)  
[httpd\\_ssl\\_config::port\\_insecure \(C++ member\), 147](#)  
[httpd\\_ssl\\_config::port\\_secure \(C++ member\), 147](#)  
[httpd\\_ssl\\_config::prvtkey\\_len \(C++ member\), 147](#)  
[httpd\\_ssl\\_config::prvtkey\\_pem \(C++ member\), 147](#)  
[httpd\\_ssl\\_config::servercert \(C++ member\), 146](#)  
[httpd\\_ssl\\_config::servercert\\_len \(C++ member\), 146](#)  
[httpd\\_ssl\\_config::session\\_tickets \(C++ member\), 147](#)  
[httpd\\_ssl\\_config::ssl\\_userdata \(C++ member\), 147](#)  
[httpd\\_ssl\\_config::transport\\_mode \(C++ member\), 147](#)  
[httpd\\_ssl\\_config::use\\_ecdsa\\_peripheral \(C++ member\), 147](#)  
[httpd\\_ssl\\_config::use\\_secure\\_element \(C++ member\), 147](#)  
[httpd\\_ssl\\_config::user\\_cb \(C++ member\), 147](#)  
[HTTPD\\_SSL\\_CONFIG\\_DEFAULT \(C macro\), 148](#)  
[httpd\\_ssl\\_config\\_t \(C++ type\), 148](#)  
[httpd\\_ssl\\_start \(C++ function\), 146](#)  
[httpd\\_ssl\\_stop \(C++ function\), 146](#)  
[httpd\\_ssl\\_transport\\_mode\\_t \(C++ enum\), 148](#)  
[httpd\\_ssl\\_transport\\_mode\\_t::HTTPD\\_SSL\\_TRANSPORT\\_MODE\\_INSECURE \(C++ enumerator\), 149](#)  
[httpd\\_ssl\\_transport\\_mode\\_t::HTTPD\\_SSL\\_TRANSPORT\\_MODE\\_SECURE \(C++ enumerator\), 148](#)  
[httpd\\_ssl\\_user\\_cb\\_state\\_t \(C++ enum\), 149](#)  
[httpd\\_ssl\\_user\\_cb\\_state\\_t::HTTPD\\_SSL\\_USER\\_CB\\_STATE\\_CLOSE \(C++ enumerator\), 149](#)  
[httpd\\_ssl\\_user\\_cb\\_state\\_t::HTTPD\\_SSL\\_USER\\_CB\\_STATE\\_CREATE \(C++ enumerator\), 149](#)  
[httpd\\_start \(C++ function\), 119](#)  
[httpd\\_stop \(C++ function\), 119](#)  
[HTTPD\\_TYPE\\_JSON \(C macro\), 139](#)  
[HTTPD\\_TYPE\\_OCTET \(C macro\), 139](#)  
[HTTPD\\_TYPE\\_TEXT \(C macro\), 139](#)  
[httpd\\_unregister\\_uri \(C++ function\), 121](#)  
[httpd\\_unregister\\_uri\\_handler \(C++ function\), 120](#)  
[httpd\\_uri \(C++ struct\), 138](#)  
[httpd\\_uri::handler \(C++ member\), 138](#)  
[httpd\\_uri::method \(C++ member\), 138](#)  
[httpd\\_uri::uri \(C++ member\), 138](#)  
[httpd\\_uri::user\\_ctx \(C++ member\), 138](#)  
[httpd\\_uri\\_match\\_func\\_t \(C++ type\), 141](#)  
[httpd\\_uri\\_match\\_wildcard \(C++ function\), 125](#)  
[httpd\\_uri\\_t \(C++ type\), 141](#)  
[httpd\\_work\\_fn\\_t \(C++ type\), 143](#)  
[HttpStatus\\_Code \(C++ enum\), 89](#)  
[HttpStatus\\_Code::HttpStatus\\_BadRequest \(C++ enumerator\), 89](#)  
[HttpStatus\\_Code::HttpStatus\\_Forbidden \(C++ enumerator\), 89](#)  
[HttpStatus\\_Code::HttpStatus\\_Found \(C++ enumerator\), 89](#)  
[HttpStatus\\_Code::HttpStatus\\_InternalError \(C++ enumerator\), 89](#)  
[HttpStatus\\_Code::HttpStatus\\_MovedPermanently \(C++ enumerator\), 89](#)  
[HttpStatus\\_Code::HttpStatus\\_MultipleChoices \(C++ enumerator\), 89](#)  
[HttpStatus\\_Code::HttpStatus\\_NotFound \(C++ enumerator\), 89](#)  
[HttpStatus\\_Code::HttpStatus\\_Ok \(C++ enumerator\), 89](#)  
[HttpStatus\\_Code::HttpStatus\\_PermanentRedirect \(C++ enumerator\), 89](#)  
[HttpStatus\\_Code::HttpStatus\\_SeeOther \(C++ enumerator\), 89](#)  
[HttpStatus\\_Code::HttpStatus\\_TemporaryRedirect \(C++ enumerator\), 89](#)  
[HttpStatus\\_Code::HttpStatus\\_Unauthorized \(C++ enumerator\), 89](#)
- I**
- [i2c\\_ack\\_type\\_t \(C++ enum\), 912](#)  
[i2c\\_ack\\_type\\_t::I2C\\_MASTER\\_ACK \(C++ enumerator\), 912](#)  
[i2c\\_ack\\_type\\_t::I2C\\_MASTER\\_ACK\\_MAX \(C++ enumerator\), 912](#)  
[i2c\\_ack\\_type\\_t::I2C\\_MASTER\\_LAST\\_NACK \(C++ enumerator\), 912](#)  
[i2c\\_ack\\_type\\_t::I2C\\_MASTER\\_NACK \(C++ enumerator\), 912](#)  
[i2c\\_addr\\_bit\\_len\\_t \(C++ enum\), 910](#)  
[i2c\\_addr\\_bit\\_len\\_t::I2C\\_ADDR\\_BIT\\_LEN\\_10 \(C++ enumerator\), 911](#)  
[i2c\\_addr\\_bit\\_len\\_t::I2C\\_ADDR\\_BIT\\_LEN\\_7 \(C++ enumerator\), 911](#)  
[i2c\\_addr\\_mode\\_t \(C++ enum\), 911](#)  
[i2c\\_addr\\_mode\\_t::I2C\\_ADDR\\_BIT\\_10 \(C++ enumerator\), 911](#)  
[i2c\\_addr\\_mode\\_t::I2C\\_ADDR\\_BIT\\_7 \(C++ enumerator\), 911](#)  
[i2c\\_addr\\_mode\\_t::I2C\\_ADDR\\_BIT\\_MAX \(C++ enumerator\), 912](#)  
[i2c\\_clock\\_source\\_t \(C++ type\), 910](#)  
[i2c\\_del\\_master\\_bus \(C++ function\), 898](#)  
[i2c\\_del\\_slave\\_device \(C++ function\), 904](#)  
[i2c\\_device\\_config\\_t \(C++ struct\), 902](#)  
[i2c\\_device\\_config\\_t::dev\\_addr\\_length \(C++ member\), 902](#)



- i2c\_device\_config\_t::device\_address* (C++ member), 902  
*i2c\_device\_config\_t::disable\_ack\_check* (C++ member), 903  
*i2c\_device\_config\_t::flags* (C++ member), 903  
*i2c\_device\_config\_t::scl\_speed\_hz* (C++ member), 902  
*i2c\_device\_config\_t::scl\_wait\_us* (C++ member), 903  
*i2c\_hal\_clk\_config\_t* (C++ struct), 909  
*i2c\_hal\_clk\_config\_t::clkm\_div* (C++ member), 910  
*i2c\_hal\_clk\_config\_t::hold* (C++ member), 910  
*i2c\_hal\_clk\_config\_t::scl\_high* (C++ member), 910  
*i2c\_hal\_clk\_config\_t::scl\_low* (C++ member), 910  
*i2c\_hal\_clk\_config\_t::scl\_wait\_high* (C++ member), 910  
*i2c\_hal\_clk\_config\_t::sda\_hold* (C++ member), 910  
*i2c\_hal\_clk\_config\_t::sda\_sample* (C++ member), 910  
*i2c\_hal\_clk\_config\_t::setup* (C++ member), 910  
*i2c\_hal\_clk\_config\_t::tout* (C++ member), 910  
*i2c\_master\_bus\_add\_device* (C++ function), 898  
*i2c\_master\_bus\_config\_t* (C++ struct), 902  
*i2c\_master\_bus\_config\_t::clk\_source* (C++ member), 902  
*i2c\_master\_bus\_config\_t::enable\_internal\_pullup* (C++ member), 902  
*i2c\_master\_bus\_config\_t::flags* (C++ member), 902  
*i2c\_master\_bus\_config\_t::glitch\_ignore* (C++ member), 902  
*i2c\_master\_bus\_config\_t::i2c\_port* (C++ member), 902  
*i2c\_master\_bus\_config\_t::intr\_priority* (C++ member), 902  
*i2c\_master\_bus\_config\_t::scl\_io\_num* (C++ member), 902  
*i2c\_master\_bus\_config\_t::sda\_io\_num* (C++ member), 902  
*i2c\_master\_bus\_config\_t::trans\_queue\_depth* (C++ member), 902  
*i2c\_master\_bus\_handle\_t* (C++ type), 908  
*i2c\_master\_bus\_reset* (C++ function), 901  
*i2c\_master\_bus\_rm\_device* (C++ function), 899  
*i2c\_master\_bus\_wait\_all\_done* (C++ function), 901  
*i2c\_master\_callback\_t* (C++ type), 908  
*i2c\_master\_dev\_handle\_t* (C++ type), 908  
*i2c\_master\_event\_callbacks\_t* (C++ struct), 903  
*i2c\_master\_event\_callbacks\_t::on\_trans\_done* (C++ member), 903  
*i2c\_master\_event\_data\_t* (C++ struct), 907  
*i2c\_master\_event\_data\_t::event* (C++ member), 907  
*i2c\_master\_event\_t* (C++ enum), 909  
*i2c\_master\_event\_t::I2C\_EVENT\_ALIVE* (C++ enumerator), 909  
*i2c\_master\_event\_t::I2C\_EVENT\_DONE* (C++ enumerator), 909  
*i2c\_master\_event\_t::I2C\_EVENT\_NACK* (C++ enumerator), 909  
*i2c\_master\_event\_t::I2C\_EVENT\_TIMEOUT* (C++ enumerator), 909  
*i2c\_master\_probe* (C++ function), 900  
*i2c\_master\_receive* (C++ function), 900  
*i2c\_master\_register\_event\_callbacks* (C++ function), 901  
*i2c\_master\_status\_t* (C++ enum), 908  
*i2c\_master\_status\_t::I2C\_STATUS\_ACK\_ERROR* (C++ enumerator), 909  
*i2c\_master\_status\_t::I2C\_STATUS\_DONE* (C++ enumerator), 909  
*i2c\_master\_status\_t::I2C\_STATUS\_IDLE* (C++ enumerator), 909  
*i2c\_master\_status\_t::I2C\_STATUS\_READ* (C++ enumerator), 908  
*i2c\_master\_status\_t::I2C\_STATUS\_START* (C++ enumerator), 909  
*i2c\_master\_status\_t::I2C\_STATUS\_STOP* (C++ enumerator), 909  
*i2c\_master\_status\_t::I2C\_STATUS\_TIMEOUT* (C++ enumerator), 909  
*i2c\_master\_status\_t::I2C\_STATUS\_WRITE* (C++ enumerator), 908  
*i2c\_master\_transmit* (C++ function), 899  
*i2c\_master\_transmit\_receive* (C++ function), 899  
*i2c\_mode\_t* (C++ enum), 911  
*i2c\_mode\_t::I2C\_MODE\_MASTER* (C++ enumerator), 911  
*i2c\_mode\_t::I2C\_MODE\_MAX* (C++ enumerator), 911  
*i2c\_mode\_t::I2C\_MODE\_SLAVE* (C++ enumerator), 911  
*i2c\_new\_master\_bus* (C++ function), 898  
*i2c\_new\_slave\_device* (C++ function), 903  
*i2c\_port\_num\_t* (C++ type), 908  
*i2c\_port\_t* (C++ enum), 910  
*i2c\_port\_t::I2C\_NUM\_0* (C++ enumerator), 910  
*i2c\_port\_t::I2C\_NUM\_1* (C++ enumerator), 910  
*i2c\_port\_t::I2C\_NUM\_MAX* (C++ enumerator), 910  
*i2c\_rw\_t* (C++ enum), 911  
*i2c\_rw\_t::I2C\_MASTER\_READ* (C++ enumerator), 911

- i2c\_rw\_t::I2C\_MASTER\_WRITE* (C++ *enumerator*), 911  
*i2c\_slave\_config\_t* (C++ *struct*), 906  
*i2c\_slave\_config\_t::access\_ram\_en* (C++ *member*), 906  
*i2c\_slave\_config\_t::addr\_bit\_len* (C++ *member*), 906  
*i2c\_slave\_config\_t::broadcast\_en* (C++ *member*), 906  
*i2c\_slave\_config\_t::clk\_source* (C++ *member*), 906  
*i2c\_slave\_config\_t::flags* (C++ *member*), 906  
*i2c\_slave\_config\_t::i2c\_port* (C++ *member*), 906  
*i2c\_slave\_config\_t::intr\_priority* (C++ *member*), 906  
*i2c\_slave\_config\_t::scl\_io\_num* (C++ *member*), 906  
*i2c\_slave\_config\_t::sda\_io\_num* (C++ *member*), 906  
*i2c\_slave\_config\_t::send\_buf\_depth* (C++ *member*), 906  
*i2c\_slave\_config\_t::slave\_addr* (C++ *member*), 906  
*i2c\_slave\_config\_t::slave\_unmatch\_en* (C++ *member*), 906  
*i2c\_slave\_config\_t::stretch\_en* (C++ *member*), 906  
*i2c\_slave\_dev\_handle\_t* (C++ *type*), 908  
*i2c\_slave\_event\_callbacks\_t* (C++ *struct*), 906  
*i2c\_slave\_event\_callbacks\_t::on\_recv\_done* (C++ *member*), 907  
*i2c\_slave\_event\_callbacks\_t::on\_stretch\_end* (C++ *member*), 907  
*i2c\_slave\_read\_ram* (C++ *function*), 905  
*i2c\_slave\_receive* (C++ *function*), 904  
*i2c\_slave\_received\_callback\_t* (C++ *type*), 908  
*i2c\_slave\_register\_event\_callbacks* (C++ *function*), 904  
*i2c\_slave\_rx\_done\_event\_data\_t* (C++ *struct*), 907  
*i2c\_slave\_rx\_done\_event\_data\_t::buffer* (C++ *member*), 907  
*i2c\_slave\_stretch\_callback\_t* (C++ *type*), 908  
*i2c\_slave\_stretch\_cause\_t* (C++ *enum*), 912  
*i2c\_slave\_stretch\_cause\_t::I2C\_SLAVE\_STRETCH\_CAUSE\_ADDR\_CS\_FUNCTION* (C++ *enumerator*), 912  
*i2c\_slave\_stretch\_cause\_t::I2C\_SLAVE\_STRETCH\_CAUSE\_ADDR\_CS\_FUNCTION* (C++ *enumerator*), 912  
*i2c\_slave\_stretch\_cause\_t::I2C\_SLAVE\_STRETCH\_CAUSE\_ADDR\_CS\_FUNCTION* (C++ *enumerator*), 912  
*i2c\_slave\_stretch\_cause\_t::I2C\_SLAVE\_STRETCH\_CAUSE\_ADDR\_CS\_FUNCTION* (C++ *enumerator*), 912  
*i2c\_slave\_stretch\_cause\_t::I2C\_SLAVE\_STRETCH\_CAUSE\_ADDR\_CS\_FUNCTION* (C++ *enumerator*), 912  
*i2c\_slave\_stretch\_event\_data\_t* (C++ *struct*), 907  
*i2c\_slave\_stretch\_event\_data\_t::stretch\_cause* (C++ *member*), 908  
*i2c\_slave\_transmit* (C++ *function*), 904  
*i2c\_slave\_write\_ram* (C++ *function*), 905  
*i2c\_trans\_mode\_t* (C++ *enum*), 911  
*i2c\_trans\_mode\_t::I2C\_DATA\_MODE\_LSB\_FIRST* (C++ *enumerator*), 911  
*i2c\_trans\_mode\_t::I2C\_DATA\_MODE\_MAX* (C++ *enumerator*), 911  
*i2c\_trans\_mode\_t::I2C\_DATA\_MODE\_MSB\_FIRST* (C++ *enumerator*), 911  
*i2s\_chan\_config\_t* (C++ *struct*), 946  
*i2s\_chan\_config\_t::auto\_clear* (C++ *member*), 946  
*i2s\_chan\_config\_t::auto\_clear\_after\_cb* (C++ *member*), 946  
*i2s\_chan\_config\_t::auto\_clear\_before\_cb* (C++ *member*), 947  
*i2s\_chan\_config\_t::dma\_desc\_num* (C++ *member*), 946  
*i2s\_chan\_config\_t::dma\_frame\_num* (C++ *member*), 946  
*i2s\_chan\_config\_t::id* (C++ *member*), 946  
*i2s\_chan\_config\_t::intr\_priority* (C++ *member*), 947  
*i2s\_chan\_config\_t::role* (C++ *member*), 946  
*i2s\_chan\_handle\_t* (C++ *type*), 948  
*i2s\_chan\_info\_t* (C++ *struct*), 947  
*i2s\_chan\_info\_t::dir* (C++ *member*), 947  
*i2s\_chan\_info\_t::id* (C++ *member*), 947  
*i2s\_chan\_info\_t::mode* (C++ *member*), 947  
*i2s\_chan\_info\_t::pair\_chan* (C++ *member*), 947  
*i2s\_chan\_info\_t::role* (C++ *member*), 947  
*i2s\_chan\_info\_t::total\_dma\_buf\_size* (C++ *member*), 947  
I2S\_CHANNEL\_DEFAULT\_CONFIG (C *macro*), 947  
*i2s\_channel\_disable* (C++ *function*), 943  
*i2s\_channel\_enable* (C++ *function*), 943  
*i2s\_channel\_get\_info* (C++ *function*), 943  
*i2s\_channel\_init\_pdm\_tx\_mode* (C++ *function*), 931  
*i2s\_channel\_init\_std\_mode* (C++ *function*), 927  
*i2s\_channel\_init\_tdm\_mode* (C++ *function*), 937  
*i2s\_channel\_preload\_data* (C++ *function*), 944  
*i2s\_channel\_reconfig\_addr\_cs\_function* (C++ *function*), 945  
*i2s\_channel\_reconfig\_pdm\_tx\_clock* (C++ *function*), 932  
*i2s\_channel\_reconfig\_pdm\_tx\_gpio* (C++ *function*), 936  
*i2s\_channel\_reconfig\_pdm\_tx\_ing\_ack* (C++ *function*), 932  
*i2s\_channel\_reconfig\_pdm\_tx\_slot* (C++ *function*), 932  
*i2s\_channel\_reconfig\_std\_clock* (C++ *function*), 927

- i2s\_channel\_reconfig\_std\_gpio* (C++ function), 928  
*i2s\_channel\_reconfig\_std\_slot* (C++ function), 927  
*i2s\_channel\_reconfig\_tdm\_clock* (C++ function), 937  
*i2s\_channel\_reconfig\_tdm\_gpio* (C++ function), 938  
*i2s\_channel\_reconfig\_tdm\_slot* (C++ function), 937  
*i2s\_channel\_register\_event\_callback* (C++ function), 945  
*i2s\_channel\_write* (C++ function), 944  
*i2s\_clock\_src\_t* (C++ type), 950  
*i2s\_comm\_mode\_t* (C++ enum), 949  
*i2s\_comm\_mode\_t::I2S\_COMM\_MODE\_NONE* (C++ enumerator), 949  
*i2s\_comm\_mode\_t::I2S\_COMM\_MODE\_PDM* (C++ enumerator), 949  
*i2s\_comm\_mode\_t::I2S\_COMM\_MODE\_STD* (C++ enumerator), 949  
*i2s\_comm\_mode\_t::I2S\_COMM\_MODE\_TDM* (C++ enumerator), 949  
*i2s\_data\_bit\_width\_t* (C++ enum), 951  
*i2s\_data\_bit\_width\_t::I2S\_DATA\_BIT\_WIDTH\_16BIT* (C++ enumerator), 951  
*i2s\_data\_bit\_width\_t::I2S\_DATA\_BIT\_WIDTH\_24BIT* (C++ enumerator), 951  
*i2s\_data\_bit\_width\_t::I2S\_DATA\_BIT\_WIDTH\_32BIT* (C++ enumerator), 951  
*i2s\_data\_bit\_width\_t::I2S\_DATA\_BIT\_WIDTH\_8BIT* (C++ enumerator), 951  
*i2s\_del\_channel* (C++ function), 943  
*i2s\_dir\_t* (C++ enum), 950  
*i2s\_dir\_t::I2S\_DIR\_RX* (C++ enumerator), 950  
*i2s\_dir\_t::I2S\_DIR\_TX* (C++ enumerator), 950  
*i2s\_event\_callbacks\_t* (C++ struct), 945  
*i2s\_event\_callbacks\_t::on\_rcv* (C++ member), 946  
*i2s\_event\_callbacks\_t::on\_rcv\_q\_ovf* (C++ member), 946  
*i2s\_event\_callbacks\_t::on\_send\_q\_ovf* (C++ member), 946  
*i2s\_event\_callbacks\_t::on\_sent* (C++ member), 946  
*i2s\_event\_data\_t* (C++ struct), 948  
*i2s\_event\_data\_t::data* (C++ member), 948  
*i2s\_event\_data\_t::dma\_buf* (C++ member), 948  
*i2s\_event\_data\_t::size* (C++ member), 948  
*I2S\_GPIO\_UNUSED* (C macro), 947  
*i2s\_isr\_callback\_t* (C++ type), 948  
*i2s\_mclk\_multiple\_t* (C++ enum), 949  
*i2s\_mclk\_multiple\_t::I2S\_MCLK\_MULTIPLE\_1024* (C++ enumerator), 950  
*i2s\_mclk\_multiple\_t::I2S\_MCLK\_MULTIPLE\_1152* (C++ enumerator), 950  
*i2s\_mclk\_multiple\_t::I2S\_MCLK\_MULTIPLE\_128* (C++ enumerator), 949  
*i2s\_mclk\_multiple\_t::I2S\_MCLK\_MULTIPLE\_192* (C++ enumerator), 949  
*i2s\_mclk\_multiple\_t::I2S\_MCLK\_MULTIPLE\_256* (C++ enumerator), 949  
*i2s\_mclk\_multiple\_t::I2S\_MCLK\_MULTIPLE\_384* (C++ enumerator), 949  
*i2s\_mclk\_multiple\_t::I2S\_MCLK\_MULTIPLE\_512* (C++ enumerator), 949  
*i2s\_mclk\_multiple\_t::I2S\_MCLK\_MULTIPLE\_576* (C++ enumerator), 949  
*i2s\_mclk\_multiple\_t::I2S\_MCLK\_MULTIPLE\_768* (C++ enumerator), 949  
*i2s\_new\_channel* (C++ function), 942  
*i2s\_pcm\_compress\_t* (C++ enum), 951  
*i2s\_pcm\_compress\_t::I2S\_PCM\_A\_COMPRESS* (C++ enumerator), 952  
*i2s\_pcm\_compress\_t::I2S\_PCM\_A\_DECOMPRESS* (C++ enumerator), 951  
*i2s\_pcm\_compress\_t::I2S\_PCM\_DISABLE* (C++ enumerator), 951  
*i2s\_pcm\_compress\_t::I2S\_PCM\_U\_COMPRESS* (C++ enumerator), 952  
*i2s\_pcm\_compress\_t::I2S\_PCM\_U\_DECOMPRESS* (C++ enumerator), 952  
*i2s\_pdm\_sig\_scale\_t* (C++ enum), 952  
*i2s\_pdm\_sig\_scale\_t::I2S\_PDM\_SIG\_SCALING\_DIV\_2* (C++ enumerator), 952  
*i2s\_pdm\_sig\_scale\_t::I2S\_PDM\_SIG\_SCALING\_MUL\_1* (C++ enumerator), 952  
*i2s\_pdm\_sig\_scale\_t::I2S\_PDM\_SIG\_SCALING\_MUL\_2* (C++ enumerator), 952  
*i2s\_pdm\_sig\_scale\_t::I2S\_PDM\_SIG\_SCALING\_MUL\_4* (C++ enumerator), 952  
*i2s\_pdm\_slot\_mask\_t* (C++ enum), 953  
*i2s\_pdm\_slot\_mask\_t::I2S\_PDM\_SLOT\_BOTH* (C++ enumerator), 953  
*i2s\_pdm\_slot\_mask\_t::I2S\_PDM\_SLOT\_LEFT* (C++ enumerator), 953  
*i2s\_pdm\_slot\_mask\_t::I2S\_PDM\_SLOT\_RIGHT* (C++ enumerator), 953  
*i2s\_pdm\_tx\_clk\_config\_t* (C++ struct), 934  
*i2s\_pdm\_tx\_clk\_config\_t::bclk\_div* (C++ member), 934  
*i2s\_pdm\_tx\_clk\_config\_t::clk\_src* (C++ member), 934  
*i2s\_pdm\_tx\_clk\_config\_t::mclk\_multiple* (C++ member), 934  
*i2s\_pdm\_tx\_clk\_config\_t::sample\_rate\_hz* (C++ member), 934  
*i2s\_pdm\_tx\_clk\_config\_t::up\_sample\_fp* (C++ member), 934  
*i2s\_pdm\_tx\_clk\_config\_t::up\_sample\_fs* (C++ member), 934  
*I2S\_PDM\_TX\_CLK\_DAC\_DEFAULT\_CONFIG* (C macro), 936  
*I2S\_PDM\_TX\_CLK\_DEFAULT\_CONFIG* (C macro), 936

- i2s\_pdm\_tx\_config\_t* (C++ struct), 935  
*i2s\_pdm\_tx\_config\_t::clk\_cfg* (C++ member), 935  
*i2s\_pdm\_tx\_config\_t::gpio\_cfg* (C++ member), 935  
*i2s\_pdm\_tx\_config\_t::slot\_cfg* (C++ member), 935  
*i2s\_pdm\_tx\_gpio\_config\_t* (C++ struct), 934  
*i2s\_pdm\_tx\_gpio\_config\_t::clk* (C++ member), 935  
*i2s\_pdm\_tx\_gpio\_config\_t::clk\_inv* (C++ member), 935  
*i2s\_pdm\_tx\_gpio\_config\_t::dout* (C++ member), 935  
*i2s\_pdm\_tx\_gpio\_config\_t::dout2* (C++ member), 935  
*i2s\_pdm\_tx\_gpio\_config\_t::invert\_flags* (C++ member), 935  
*i2s\_pdm\_tx\_line\_mode\_t* (C++ enum), 952  
*i2s\_pdm\_tx\_line\_mode\_t::I2S\_PDM\_TX\_ONE\_LINE\_CODE* (C++ enumerator), 952  
*i2s\_pdm\_tx\_line\_mode\_t::I2S\_PDM\_TX\_ONE\_LINE\_DAC* (C++ enumerator), 952  
*i2s\_pdm\_tx\_line\_mode\_t::I2S\_PDM\_TX\_TWO\_LINES\_DAC* (C++ enumerator), 952  
*i2s\_pdm\_tx\_slot\_config\_t* (C++ struct), 933  
*i2s\_pdm\_tx\_slot\_config\_t::data\_bit\_width* (C++ member), 933  
*i2s\_pdm\_tx\_slot\_config\_t::hp\_cut\_off\_freq\_hz* (C++ member), 934  
*i2s\_pdm\_tx\_slot\_config\_t::hp\_en* (C++ member), 934  
*i2s\_pdm\_tx\_slot\_config\_t::hp\_scale* (C++ member), 933  
*i2s\_pdm\_tx\_slot\_config\_t::line\_mode* (C++ member), 934  
*i2s\_pdm\_tx\_slot\_config\_t::lp\_scale* (C++ member), 934  
*i2s\_pdm\_tx\_slot\_config\_t::sd\_dither* (C++ member), 934  
*i2s\_pdm\_tx\_slot\_config\_t::sd\_dither2* (C++ member), 934  
*i2s\_pdm\_tx\_slot\_config\_t::sd\_prescale* (C++ member), 933  
*i2s\_pdm\_tx\_slot\_config\_t::sd\_scale* (C++ member), 933  
*i2s\_pdm\_tx\_slot\_config\_t::sinc\_scale* (C++ member), 934  
*i2s\_pdm\_tx\_slot\_config\_t::slot\_bit\_width* (C++ member), 933  
*i2s\_pdm\_tx\_slot\_config\_t::slot\_mode* (C++ member), 933  
I2S\_PDM\_TX\_SLOT\_DAC\_DEFAULT\_CONFIG (C macro), 935  
I2S\_PDM\_TX\_SLOT\_DEFAULT\_CONFIG (C macro), 935  
*i2s\_port\_t* (C++ enum), 948  
*i2s\_port\_t::I2S\_NUM\_0* (C++ enumerator), 948  
*i2s\_port\_t::I2S\_NUM\_AUTO* (C++ enumerator), 949  
*i2s\_role\_t* (C++ enum), 950  
*i2s\_role\_t::I2S\_ROLE\_MASTER* (C++ enumerator), 950  
*i2s\_role\_t::I2S\_ROLE\_SLAVE* (C++ enumerator), 951  
*i2s\_slot\_bit\_width\_t* (C++ enum), 951  
*i2s\_slot\_bit\_width\_t::I2S\_SLOT\_BIT\_WIDTH\_16BIT* (C++ enumerator), 951  
*i2s\_slot\_bit\_width\_t::I2S\_SLOT\_BIT\_WIDTH\_24BIT* (C++ enumerator), 951  
*i2s\_slot\_bit\_width\_t::I2S\_SLOT\_BIT\_WIDTH\_32BIT* (C++ enumerator), 951  
*i2s\_slot\_bit\_width\_t::I2S\_SLOT\_BIT\_WIDTH\_8BIT* (C++ enumerator), 951  
*i2s\_slot\_bit\_width\_t::I2S\_SLOT\_BIT\_WIDTH\_AUTO* (C++ enumerator), 951  
*i2s\_slot\_mode\_t* (C++ enum), 950  
*i2s\_slot\_mode\_t::I2S\_SLOT\_MODE\_MONO* (C++ enumerator), 950  
*i2s\_slot\_mode\_t::I2S\_SLOT\_MODE\_STEREO* (C++ enumerator), 950  
*i2s\_std\_clk\_config\_t* (C++ struct), 929  
*i2s\_std\_clk\_config\_t::clk\_src* (C++ member), 929  
*i2s\_std\_clk\_config\_t::ext\_clk\_freq\_hz* (C++ member), 929  
*i2s\_std\_clk\_config\_t::mclk\_multiple* (C++ member), 929  
*i2s\_std\_clk\_config\_t::sample\_rate\_hz* (C++ member), 929  
I2S\_STD\_CLK\_DEFAULT\_CONFIG (C macro), 931  
*i2s\_std\_config\_t* (C++ struct), 930  
*i2s\_std\_config\_t::clk\_cfg* (C++ member), 930  
*i2s\_std\_config\_t::gpio\_cfg* (C++ member), 930  
*i2s\_std\_config\_t::slot\_cfg* (C++ member), 930  
*i2s\_std\_gpio\_config\_t* (C++ struct), 929  
*i2s\_std\_gpio\_config\_t::bclk* (C++ member), 930  
*i2s\_std\_gpio\_config\_t::bclk\_inv* (C++ member), 930  
*i2s\_std\_gpio\_config\_t::din* (C++ member), 930  
*i2s\_std\_gpio\_config\_t::dout* (C++ member), 930  
*i2s\_std\_gpio\_config\_t::invert\_flags* (C++ member), 930  
*i2s\_std\_gpio\_config\_t::mclk* (C++ member), 929  
*i2s\_std\_gpio\_config\_t::mclk\_inv* (C++ member), 930  
*i2s\_std\_gpio\_config\_t::ws* (C++ member), 930  
*i2s\_std\_gpio\_config\_t::ws\_inv* (C++

- member), 930
- I2S\_STD\_MSB\_SLOT\_DEFAULT\_CONFIG (C macro), 931
- I2S\_STD\_PCM\_SLOT\_DEFAULT\_CONFIG (C macro), 931
- I2S\_STD\_PHILIPS\_SLOT\_DEFAULT\_CONFIG (C macro), 930
- i2s\_std\_slot\_config\_t (C++ struct), 928
- i2s\_std\_slot\_config\_t::big\_endian (C++ member), 929
- i2s\_std\_slot\_config\_t::bit\_order\_lsb (C++ member), 929
- i2s\_std\_slot\_config\_t::bit\_shift (C++ member), 929
- i2s\_std\_slot\_config\_t::data\_bit\_width (C++ member), 928
- i2s\_std\_slot\_config\_t::left\_align (C++ member), 929
- i2s\_std\_slot\_config\_t::slot\_bit\_width (C++ member), 928
- i2s\_std\_slot\_config\_t::slot\_mask (C++ member), 929
- i2s\_std\_slot\_config\_t::slot\_mode (C++ member), 928
- i2s\_std\_slot\_config\_t::ws\_pol (C++ member), 929
- i2s\_std\_slot\_config\_t::ws\_width (C++ member), 929
- i2s\_std\_slot\_mask\_t (C++ enum), 952
- i2s\_std\_slot\_mask\_t::I2S\_STD\_SLOT\_BOTH (C++ enumerator), 953
- i2s\_std\_slot\_mask\_t::I2S\_STD\_SLOT\_LEFT (C++ enumerator), 953
- i2s\_std\_slot\_mask\_t::I2S\_STD\_SLOT\_RIGHT (C++ enumerator), 953
- I2S\_TDM\_AUTO\_SLOT\_NUM (C macro), 941
- I2S\_TDM\_AUTO\_WS\_WIDTH (C macro), 941
- i2s\_tdm\_clk\_config\_t (C++ struct), 939
- i2s\_tdm\_clk\_config\_t::bclk\_div (C++ member), 940
- i2s\_tdm\_clk\_config\_t::clk\_src (C++ member), 939
- i2s\_tdm\_clk\_config\_t::ext\_clk\_freq\_hz (C++ member), 939
- i2s\_tdm\_clk\_config\_t::mclk\_multiple (C++ member), 940
- i2s\_tdm\_clk\_config\_t::sample\_rate\_hz (C++ member), 939
- I2S\_TDM\_CLK\_DEFAULT\_CONFIG (C macro), 941
- i2s\_tdm\_config\_t (C++ struct), 940
- i2s\_tdm\_config\_t::clk\_cfg (C++ member), 941
- i2s\_tdm\_config\_t::gpio\_cfg (C++ member), 941
- i2s\_tdm\_config\_t::slot\_cfg (C++ member), 941
- i2s\_tdm\_gpio\_config\_t (C++ struct), 940
- i2s\_tdm\_gpio\_config\_t::bclk (C++ member), 940
- i2s\_tdm\_gpio\_config\_t::bclk\_inv (C++ member), 940
- i2s\_tdm\_gpio\_config\_t::din (C++ member), 940
- i2s\_tdm\_gpio\_config\_t::dout (C++ member), 940
- i2s\_tdm\_gpio\_config\_t::invert\_flags (C++ member), 940
- i2s\_tdm\_gpio\_config\_t::mclk (C++ member), 940
- i2s\_tdm\_gpio\_config\_t::mclk\_inv (C++ member), 940
- i2s\_tdm\_gpio\_config\_t::ws (C++ member), 940
- i2s\_tdm\_gpio\_config\_t::ws\_inv (C++ member), 940
- I2S\_TDM\_MSB\_SLOT\_DEFAULT\_CONFIG (C macro), 941
- I2S\_TDM\_PCM\_LONG\_SLOT\_DEFAULT\_CONFIG (C macro), 941
- I2S\_TDM\_PCM\_SHORT\_SLOT\_DEFAULT\_CONFIG (C macro), 941
- I2S\_TDM\_PHILIPS\_SLOT\_DEFAULT\_CONFIG (C macro), 941
- i2s\_tdm\_slot\_config\_t (C++ struct), 938
- i2s\_tdm\_slot\_config\_t::big\_endian (C++ member), 939
- i2s\_tdm\_slot\_config\_t::bit\_order\_lsb (C++ member), 939
- i2s\_tdm\_slot\_config\_t::bit\_shift (C++ member), 939
- i2s\_tdm\_slot\_config\_t::data\_bit\_width (C++ member), 938
- i2s\_tdm\_slot\_config\_t::left\_align (C++ member), 939
- i2s\_tdm\_slot\_config\_t::skip\_mask (C++ member), 939
- i2s\_tdm\_slot\_config\_t::slot\_bit\_width (C++ member), 938
- i2s\_tdm\_slot\_config\_t::slot\_mask (C++ member), 939
- i2s\_tdm\_slot\_config\_t::slot\_mode (C++ member), 938
- i2s\_tdm\_slot\_config\_t::total\_slot (C++ member), 939
- i2s\_tdm\_slot\_config\_t::ws\_pol (C++ member), 939
- i2s\_tdm\_slot\_config\_t::ws\_width (C++ member), 939
- i2s\_tdm\_slot\_mask\_t (C++ enum), 953
- i2s\_tdm\_slot\_mask\_t::I2S\_TDM\_SLOT0 (C++ enumerator), 953
- i2s\_tdm\_slot\_mask\_t::I2S\_TDM\_SLOT1 (C++ enumerator), 953
- i2s\_tdm\_slot\_mask\_t::I2S\_TDM\_SLOT10 (C++ enumerator), 954
- i2s\_tdm\_slot\_mask\_t::I2S\_TDM\_SLOT11



- (C++ *enumerator*), 954
- i2s\_tdm\_slot\_mask\_t::I2S\_TDM\_SLOT12 (C++ *enumerator*), 954
- i2s\_tdm\_slot\_mask\_t::I2S\_TDM\_SLOT13 (C++ *enumerator*), 954
- i2s\_tdm\_slot\_mask\_t::I2S\_TDM\_SLOT14 (C++ *enumerator*), 954
- i2s\_tdm\_slot\_mask\_t::I2S\_TDM\_SLOT15 (C++ *enumerator*), 954
- i2s\_tdm\_slot\_mask\_t::I2S\_TDM\_SLOT2 (C++ *enumerator*), 953
- i2s\_tdm\_slot\_mask\_t::I2S\_TDM\_SLOT3 (C++ *enumerator*), 953
- i2s\_tdm\_slot\_mask\_t::I2S\_TDM\_SLOT4 (C++ *enumerator*), 953
- i2s\_tdm\_slot\_mask\_t::I2S\_TDM\_SLOT5 (C++ *enumerator*), 954
- i2s\_tdm\_slot\_mask\_t::I2S\_TDM\_SLOT6 (C++ *enumerator*), 954
- i2s\_tdm\_slot\_mask\_t::I2S\_TDM\_SLOT7 (C++ *enumerator*), 954
- i2s\_tdm\_slot\_mask\_t::I2S\_TDM\_SLOT8 (C++ *enumerator*), 954
- i2s\_tdm\_slot\_mask\_t::I2S\_TDM\_SLOT9 (C++ *enumerator*), 954
- intr\_handle\_t (C++ *type*), 1967
- intr\_handler\_t (C++ *type*), 1967
- IP2STR (C *macro*), 776
- IP4ADDR\_STRLLEN\_MAX (C *macro*), 777
- ip\_event\_add\_ip6\_t (C++ *struct*), 768
- ip\_event\_add\_ip6\_t::addr (C++ *member*), 768
- ip\_event\_add\_ip6\_t::preferred (C++ *member*), 768
- ip\_event\_ap\_staipassigned\_t (C++ *struct*), 768
- ip\_event\_ap\_staipassigned\_t::esp\_netif (C++ *member*), 768
- ip\_event\_ap\_staipassigned\_t::ip (C++ *member*), 768
- ip\_event\_ap\_staipassigned\_t::mac (C++ *member*), 768
- ip\_event\_got\_ip6\_t (C++ *struct*), 767
- ip\_event\_got\_ip6\_t::esp\_netif (C++ *member*), 768
- ip\_event\_got\_ip6\_t::ip6\_info (C++ *member*), 768
- ip\_event\_got\_ip6\_t::ip\_index (C++ *member*), 768
- ip\_event\_got\_ip\_t (C++ *struct*), 767
- ip\_event\_got\_ip\_t::esp\_netif (C++ *member*), 767
- ip\_event\_got\_ip\_t::ip\_changed (C++ *member*), 767
- ip\_event\_got\_ip\_t::ip\_info (C++ *member*), 767
- ip\_event\_t (C++ *enum*), 773
- ip\_event\_t::IP\_EVENT\_AP\_STAIPASSIGNED (C++ *enumerator*), 774
- ip\_event\_t::IP\_EVENT\_ETH\_GOT\_IP (C++ *enumerator*), 774
- ip\_event\_t::IP\_EVENT\_ETH\_LOST\_IP (C++ *enumerator*), 774
- ip\_event\_t::IP\_EVENT\_GOT\_IP6 (C++ *enumerator*), 774
- ip\_event\_t::IP\_EVENT\_PPP\_GOT\_IP (C++ *enumerator*), 774
- ip\_event\_t::IP\_EVENT\_PPP\_LOST\_IP (C++ *enumerator*), 774
- ip\_event\_t::IP\_EVENT\_STA\_GOT\_IP (C++ *enumerator*), 773
- ip\_event\_t::IP\_EVENT\_STA\_LOST\_IP (C++ *enumerator*), 773
- IPSTR (C *macro*), 776
- IPV62STR (C *macro*), 776
- IPV6STR (C *macro*), 776
- ## L
- l2tap\_ioctl\_opt\_t (C++ *enum*), 779
- l2tap\_ioctl\_opt\_t::L2TAP\_G\_DEVICE\_DRV\_HNDL (C++ *enumerator*), 779
- l2tap\_ioctl\_opt\_t::L2TAP\_G\_INTF\_DEVICE (C++ *enumerator*), 779
- l2tap\_ioctl\_opt\_t::L2TAP\_G\_RCV\_FILTER (C++ *enumerator*), 779
- l2tap\_ioctl\_opt\_t::L2TAP\_S\_DEVICE\_DRV\_HNDL (C++ *enumerator*), 779
- l2tap\_ioctl\_opt\_t::L2TAP\_S\_INTF\_DEVICE (C++ *enumerator*), 779
- l2tap\_ioctl\_opt\_t::L2TAP\_S\_RCV\_FILTER (C++ *enumerator*), 779
- l2tap\_iedriver\_handle (C++ *type*), 779
- L2TAP\_VFS\_CONFIG\_DEFAULT (C *macro*), 778
- l2tap\_vfs\_config\_t (C++ *struct*), 778
- l2tap\_vfs\_config\_t::base\_path (C++ *member*), 778
- L2TAP\_VFS\_DEFAULT\_PATH (C *macro*), 778
- lcd\_clock\_source\_t (C++ *type*), 962
- lcd\_color\_range\_t (C++ *enum*), 963
- lcd\_color\_range\_t::LCD\_COLOR\_RANGE\_FULL (C++ *enumerator*), 963
- lcd\_color\_range\_t::LCD\_COLOR\_RANGE\_LIMIT (C++ *enumerator*), 963
- lcd\_color\_rgb\_pixel\_format\_t (C++ *enum*), 963
- lcd\_color\_rgb\_pixel\_format\_t::LCD\_COLOR\_PIXEL\_FORMAT\_1 (C++ *enumerator*), 963
- lcd\_color\_rgb\_pixel\_format\_t::LCD\_COLOR\_PIXEL\_FORMAT\_2 (C++ *enumerator*), 963
- lcd\_color\_rgb\_pixel\_format\_t::LCD\_COLOR\_PIXEL\_FORMAT\_3 (C++ *enumerator*), 963
- lcd\_color\_space\_t (C++ *enum*), 962
- lcd\_color\_space\_t::LCD\_COLOR\_SPACE\_RGB (C++ *enumerator*), 962
- lcd\_color\_space\_t::LCD\_COLOR\_SPACE\_YUV (C++ *enumerator*), 963

- lcd\_rgb\_data\_endian\_t (C++ enum), 962  
 lcd\_rgb\_data\_endian\_t::LCD\_RGB\_DATA\_ENDIAN\_BIG (C++ enumerator), 991  
 lcd\_rgb\_data\_endian\_t::LCD\_RGB\_DATA\_ENDIAN\_LITTLE (C++ enumerator), 991  
 lcd\_rgb\_element\_order\_t (C++ enum), 965  
 lcd\_rgb\_element\_order\_t::LCD\_RGB\_ELEMENT\_ORDER\_BGR (C++ enumerator), 991  
 lcd\_rgb\_element\_order\_t::LCD\_RGB\_ELEMENT\_ORDER\_RGB (C++ enumerator), 991  
 lcd\_yuv\_conv\_std\_t (C++ enum), 963  
 lcd\_yuv\_conv\_std\_t::LCD\_YUV\_CONV\_STD\_BT601 (C++ enumerator), 963  
 lcd\_yuv\_conv\_std\_t::LCD\_YUV\_CONV\_STD\_BT709 (C++ enumerator), 963  
 lcd\_yuv\_sample\_t (C++ enum), 963  
 lcd\_yuv\_sample\_t::LCD\_YUV\_SAMPLE\_411 (C++ enumerator), 963  
 lcd\_yuv\_sample\_t::LCD\_YUV\_SAMPLE\_420 (C++ enumerator), 963  
 lcd\_yuv\_sample\_t::LCD\_YUV\_SAMPLE\_422 (C++ enumerator), 963  
 ledc\_bind\_channel\_timer (C++ function), 979  
 ledc\_cb\_event\_t (C++ enum), 989  
 ledc\_cb\_event\_t::LEDC\_FADE\_END\_EVT (C++ enumerator), 989  
 ledc\_cb\_param\_t (C++ struct), 987  
 ledc\_cb\_param\_t::channel (C++ member), 987  
 ledc\_cb\_param\_t::duty (C++ member), 987  
 ledc\_cb\_param\_t::event (C++ member), 987  
 ledc\_cb\_param\_t::speed\_mode (C++ member), 987  
 ledc\_cb\_register (C++ function), 983  
 ledc\_cb\_t (C++ type), 989  
 ledc\_cbs\_t (C++ struct), 987  
 ledc\_cbs\_t::fade\_cb (C++ member), 987  
 ledc\_channel\_config (C++ function), 974  
 ledc\_channel\_config\_t (C++ struct), 985  
 ledc\_channel\_config\_t::channel (C++ member), 986  
 ledc\_channel\_config\_t::duty (C++ member), 986  
 ledc\_channel\_config\_t::flags (C++ member), 986  
 ledc\_channel\_config\_t::gpio\_num (C++ member), 986  
 ledc\_channel\_config\_t::hpoint (C++ member), 986  
 ledc\_channel\_config\_t::intr\_type (C++ member), 986  
 ledc\_channel\_config\_t::output\_invert (C++ member), 986  
 ledc\_channel\_config\_t::speed\_mode (C++ member), 986  
 ledc\_channel\_config\_t::timer\_sel (C++ member), 986  
 ledc\_channel\_t (C++ enum), 991  
 ledc\_channel\_t::LEDC\_CHANNEL\_0 (C++ enumerator), 991  
 ledc\_channel\_t::LEDC\_CHANNEL\_1 (C++ enumerator), 991  
 ledc\_channel\_t::LEDC\_CHANNEL\_2 (C++ enumerator), 991  
 ledc\_channel\_t::LEDC\_CHANNEL\_3 (C++ enumerator), 991  
 ledc\_channel\_t::LEDC\_CHANNEL\_4 (C++ enumerator), 991  
 ledc\_channel\_t::LEDC\_CHANNEL\_5 (C++ enumerator), 992  
 ledc\_channel\_t::LEDC\_CHANNEL\_MAX (C++ enumerator), 992  
 ledc\_clk\_cfg\_t (C++ type), 990  
 ledc\_clk\_src\_t (C++ enum), 991  
 ledc\_clk\_src\_t::LEDC\_SCLK (C++ enumerator), 991  
 ledc\_duty\_direction\_t (C++ enum), 990  
 ledc\_duty\_direction\_t::LEDC\_DUTY\_DIR\_DECREASE (C++ enumerator), 990  
 ledc\_duty\_direction\_t::LEDC\_DUTY\_DIR\_INCREASE (C++ enumerator), 990  
 ledc\_duty\_direction\_t::LEDC\_DUTY\_DIR\_MAX (C++ enumerator), 990  
 LEDC\_ERR\_DUTY (C macro), 989  
 LEDC\_ERR\_VAL (C macro), 989  
 ledc\_fade\_func\_install (C++ function), 980  
 ledc\_fade\_func\_uninstall (C++ function), 980  
 ledc\_fade\_mode\_t (C++ enum), 993  
 ledc\_fade\_mode\_t::LEDC\_FADE\_MAX (C++ enumerator), 993  
 ledc\_fade\_mode\_t::LEDC\_FADE\_NO\_WAIT (C++ enumerator), 993  
 ledc\_fade\_mode\_t::LEDC\_FADE\_WAIT\_DONE (C++ enumerator), 993  
 ledc\_fade\_param\_config\_t (C++ struct), 987  
 ledc\_fade\_param\_config\_t::cycle\_num (C++ member), 989  
 ledc\_fade\_param\_config\_t::dir (C++ member), 989  
 ledc\_fade\_param\_config\_t::scale (C++ member), 989  
 ledc\_fade\_param\_config\_t::step\_num (C++ member), 989  
 ledc\_fade\_start (C++ function), 980  
 ledc\_fade\_stop (C++ function), 981  
 ledc\_fill\_multi\_fade\_param\_list (C++ function), 984  
 ledc\_find\_suitable\_duty\_resolution (C++ function), 974  
 ledc\_get\_duty (C++ function), 977  
 ledc\_get\_freq (C++ function), 976  
 ledc\_get\_hpoint (C++ function), 976  
 ledc\_intr\_type\_t (C++ enum), 990  
 ledc\_intr\_type\_t::LEDC\_INTR\_DISABLE (C++ enumerator), 990

- [ledc\\_intr\\_type\\_t::LEDC\\_INTR\\_FADE\\_END \(C++ enumerator\), 990](#)  
[ledc\\_intr\\_type\\_t::LEDC\\_INTR\\_MAX \(C++ enumerator\), 990](#)  
[ledc\\_isr\\_handle\\_t \(C++ type\), 989](#)  
[ledc\\_isr\\_register \(C++ function\), 978](#)  
[ledc\\_mode\\_t \(C++ enum\), 990](#)  
[ledc\\_mode\\_t::LEDC\\_LOW\\_SPEED\\_MODE \(C++ enumerator\), 990](#)  
[ledc\\_mode\\_t::LEDC\\_SPEED\\_MODE\\_MAX \(C++ enumerator\), 990](#)  
[ledc\\_read\\_fade\\_param \(C++ function\), 985](#)  
[ledc\\_set\\_duty \(C++ function\), 977](#)  
[ledc\\_set\\_duty\\_and\\_update \(C++ function\), 981](#)  
[ledc\\_set\\_duty\\_with\\_hpoint \(C++ function\), 976](#)  
[ledc\\_set\\_fade \(C++ function\), 977](#)  
[ledc\\_set\\_fade\\_step\\_and\\_start \(C++ function\), 982](#)  
[ledc\\_set\\_fade\\_time\\_and\\_start \(C++ function\), 982](#)  
[ledc\\_set\\_fade\\_with\\_step \(C++ function\), 979](#)  
[ledc\\_set\\_fade\\_with\\_time \(C++ function\), 980](#)  
[ledc\\_set\\_freq \(C++ function\), 976](#)  
[ledc\\_set\\_multi\\_fade \(C++ function\), 983](#)  
[ledc\\_set\\_multi\\_fade\\_and\\_start \(C++ function\), 984](#)  
[ledc\\_set\\_pin \(C++ function\), 975](#)  
[ledc\\_slow\\_clk\\_sel\\_t \(C++ enum\), 990](#)  
[ledc\\_slow\\_clk\\_sel\\_t::LEDC\\_SLOW\\_CLK\\_PLL \(C++ enumerator\), 990](#)  
[ledc\\_slow\\_clk\\_sel\\_t::LEDC\\_SLOW\\_CLK\\_RC\\_FAST \(C++ enumerator\), 990](#)  
[ledc\\_slow\\_clk\\_sel\\_t::LEDC\\_SLOW\\_CLK\\_RTC \(C++ enumerator\), 991](#)  
[ledc\\_slow\\_clk\\_sel\\_t::LEDC\\_SLOW\\_CLK\\_XTAL \(C++ enumerator\), 990](#)  
[ledc\\_stop \(C++ function\), 975](#)  
[ledc\\_timer\\_bit\\_t \(C++ enum\), 992](#)  
[ledc\\_timer\\_bit\\_t::LEDC\\_TIMER\\_10\\_BIT \(C++ enumerator\), 992](#)  
[ledc\\_timer\\_bit\\_t::LEDC\\_TIMER\\_11\\_BIT \(C++ enumerator\), 992](#)  
[ledc\\_timer\\_bit\\_t::LEDC\\_TIMER\\_12\\_BIT \(C++ enumerator\), 992](#)  
[ledc\\_timer\\_bit\\_t::LEDC\\_TIMER\\_13\\_BIT \(C++ enumerator\), 992](#)  
[ledc\\_timer\\_bit\\_t::LEDC\\_TIMER\\_14\\_BIT \(C++ enumerator\), 992](#)  
[ledc\\_timer\\_bit\\_t::LEDC\\_TIMER\\_15\\_BIT \(C++ enumerator\), 993](#)  
[ledc\\_timer\\_bit\\_t::LEDC\\_TIMER\\_16\\_BIT \(C++ enumerator\), 993](#)  
[ledc\\_timer\\_bit\\_t::LEDC\\_TIMER\\_17\\_BIT \(C++ enumerator\), 993](#)  
[ledc\\_timer\\_bit\\_t::LEDC\\_TIMER\\_18\\_BIT \(C++ enumerator\), 993](#)  
[ledc\\_timer\\_bit\\_t::LEDC\\_TIMER\\_19\\_BIT \(C++ enumerator\), 993](#)  
[ledc\\_timer\\_bit\\_t::LEDC\\_TIMER\\_1\\_BIT \(C++ enumerator\), 992](#)  
[ledc\\_timer\\_bit\\_t::LEDC\\_TIMER\\_20\\_BIT \(C++ enumerator\), 993](#)  
[ledc\\_timer\\_bit\\_t::LEDC\\_TIMER\\_2\\_BIT \(C++ enumerator\), 992](#)  
[ledc\\_timer\\_bit\\_t::LEDC\\_TIMER\\_3\\_BIT \(C++ enumerator\), 992](#)  
[ledc\\_timer\\_bit\\_t::LEDC\\_TIMER\\_4\\_BIT \(C++ enumerator\), 992](#)  
[ledc\\_timer\\_bit\\_t::LEDC\\_TIMER\\_5\\_BIT \(C++ enumerator\), 992](#)  
[ledc\\_timer\\_bit\\_t::LEDC\\_TIMER\\_6\\_BIT \(C++ enumerator\), 992](#)  
[ledc\\_timer\\_bit\\_t::LEDC\\_TIMER\\_7\\_BIT \(C++ enumerator\), 992](#)  
[ledc\\_timer\\_bit\\_t::LEDC\\_TIMER\\_8\\_BIT \(C++ enumerator\), 992](#)  
[ledc\\_timer\\_bit\\_t::LEDC\\_TIMER\\_9\\_BIT \(C++ enumerator\), 992](#)  
[ledc\\_timer\\_bit\\_t::LEDC\\_TIMER\\_BIT\\_MAX \(C++ enumerator\), 993](#)  
[ledc\\_timer\\_config \(C++ function\), 974](#)  
[ledc\\_timer\\_config\\_t \(C++ struct\), 986](#)  
[ledc\\_timer\\_config\\_t::clk\\_cfg \(C++ member\), 986](#)  
[ledc\\_timer\\_config\\_t::deconfigure \(C++ member\), 987](#)  
[ledc\\_timer\\_config\\_t::duty\\_resolution \(C++ member\), 986](#)  
[ledc\\_timer\\_config\\_t::freq\\_hz \(C++ member\), 986](#)  
[ledc\\_timer\\_config\\_t::speed\\_mode \(C++ member\), 986](#)  
[ledc\\_timer\\_config\\_t::timer\\_num \(C++ member\), 986](#)  
[ledc\\_timer\\_pause \(C++ function\), 978](#)  
[ledc\\_timer\\_resume \(C++ function\), 979](#)  
[ledc\\_timer\\_rst \(C++ function\), 978](#)  
[ledc\\_timer\\_set \(C++ function\), 978](#)  
[ledc\\_timer\\_t \(C++ enum\), 991](#)  
[ledc\\_timer\\_t::LEDC\\_TIMER\\_0 \(C++ enumerator\), 991](#)  
[ledc\\_timer\\_t::LEDC\\_TIMER\\_1 \(C++ enumerator\), 991](#)  
[ledc\\_timer\\_t::LEDC\\_TIMER\\_2 \(C++ enumerator\), 991](#)  
[ledc\\_timer\\_t::LEDC\\_TIMER\\_3 \(C++ enumerator\), 991](#)  
[ledc\\_timer\\_t::LEDC\\_TIMER\\_MAX \(C++ enumerator\), 991](#)  
[ledc\\_update\\_duty \(C++ function\), 974](#)  
[linenoiseCompletions \(C++ type\), 1726](#)
- ## M
- [MAC2STR \(C macro\), 1987](#)



- MACSTR (*C macro*), 1987
- MALLOC\_CAP\_32BIT (*C macro*), 1933
- MALLOC\_CAP\_8BIT (*C macro*), 1933
- MALLOC\_CAP\_CACHE\_ALIGNED (*C macro*), 1934
- MALLOC\_CAP\_DEFAULT (*C macro*), 1934
- MALLOC\_CAP\_DMA (*C macro*), 1933
- MALLOC\_CAP\_DMA\_DESC\_AHB (*C macro*), 1934
- MALLOC\_CAP\_DMA\_DESC\_AXI (*C macro*), 1934
- MALLOC\_CAP\_EXEC (*C macro*), 1933
- MALLOC\_CAP\_INTERNAL (*C macro*), 1934
- MALLOC\_CAP\_INVALID (*C macro*), 1934
- MALLOC\_CAP\_IRAM\_8BIT (*C macro*), 1934
- MALLOC\_CAP\_PID2 (*C macro*), 1933
- MALLOC\_CAP\_PID3 (*C macro*), 1933
- MALLOC\_CAP\_PID4 (*C macro*), 1933
- MALLOC\_CAP\_PID5 (*C macro*), 1934
- MALLOC\_CAP\_PID6 (*C macro*), 1934
- MALLOC\_CAP\_PID7 (*C macro*), 1934
- MALLOC\_CAP\_RETENTION (*C macro*), 1934
- MALLOC\_CAP\_RTCRAM (*C macro*), 1934
- MALLOC\_CAP\_SPIRAM (*C macro*), 1934
- MALLOC\_CAP\_TCM (*C macro*), 1934
- MAX\_BLE\_DEVNAME\_LEN (*C macro*), 1607
- MAX\_BLE\_MANUFACTURER\_DATA\_LEN (*C macro*), 1607
- MAX\_FDS (*C macro*), 1691
- mcpwm\_brake\_config\_t (*C++ struct*), 1020
- mcpwm\_brake\_config\_t::brake\_mode (*C++ member*), 1020
- mcpwm\_brake\_config\_t::cbc\_recover\_on\_tep (*C++ member*), 1021
- mcpwm\_brake\_config\_t::cbc\_recover\_on\_tez (*C++ member*), 1021
- mcpwm\_brake\_config\_t::fault (*C++ member*), 1020
- mcpwm\_brake\_config\_t::flags (*C++ member*), 1021
- mcpwm\_brake\_event\_cb\_t (*C++ type*), 1044
- mcpwm\_brake\_event\_data\_t (*C++ struct*), 1042
- mcpwm\_cap\_channel\_handle\_t (*C++ type*), 1043
- mcpwm\_cap\_timer\_handle\_t (*C++ type*), 1043
- mcpwm\_capture\_channel\_config\_t (*C++ struct*), 1040
- mcpwm\_capture\_channel\_config\_t::extra\_flags (*C++ struct*), 1040
- mcpwm\_capture\_channel\_config\_t::extra\_flags::capture\_channel\_disable (*C++ member*), 1040
- mcpwm\_capture\_channel\_config\_t::extra\_flags::capture\_channel\_enable (*C++ member*), 1040
- mcpwm\_capture\_channel\_config\_t::extra\_flags::capture\_channel\_register\_event\_callbacks (*C++ member*), 1040
- mcpwm\_capture\_channel\_config\_t::extra\_flags::capture\_channel\_trigger\_soft\_catch (*C++ member*), 1040
- mcpwm\_capture\_channel\_config\_t::extra\_flags::pull (*C++ member*), 1040
- mcpwm\_capture\_channel\_config\_t::flags (*C++ member*), 1040
- mcpwm\_capture\_channel\_config\_t::gpio\_num (*C++ member*), 1040
- mcpwm\_capture\_channel\_config\_t::intr\_priority (*C++ member*), 1040
- mcpwm\_capture\_channel\_config\_t::prescale (*C++ member*), 1040
- mcpwm\_capture\_channel\_disable (*C++ function*), 1038
- mcpwm\_capture\_channel\_enable (*C++ function*), 1038
- mcpwm\_capture\_channel\_register\_event\_callbacks (*C++ function*), 1038
- mcpwm\_capture\_channel\_trigger\_soft\_catch (*C++ function*), 1039
- mcpwm\_capture\_clock\_source\_t (*C++ type*), 1044
- mcpwm\_capture\_edge\_t (*C++ enum*), 1046
- mcpwm\_capture\_edge\_t::MCPWM\_CAP\_EDGE\_NEG (*C++ enumerator*), 1046
- mcpwm\_capture\_edge\_t::MCPWM\_CAP\_EDGE\_POS (*C++ enumerator*), 1046
- mcpwm\_capture\_event\_callbacks\_t (*C++ struct*), 1041
- mcpwm\_capture\_event\_callbacks\_t::on\_cap (*C++ member*), 1041
- mcpwm\_capture\_event\_cb\_t (*C++ type*), 1044
- mcpwm\_capture\_event\_data\_t (*C++ struct*), 1043
- mcpwm\_capture\_event\_data\_t::cap\_edge (*C++ member*), 1043
- mcpwm\_capture\_event\_data\_t::cap\_value (*C++ member*), 1043
- mcpwm\_capture\_timer\_config\_t (*C++ struct*), 1039
- mcpwm\_capture\_timer\_config\_t::clk\_src (*C++ member*), 1039
- mcpwm\_capture\_timer\_config\_t::group\_id (*C++ member*), 1039
- mcpwm\_capture\_timer\_config\_t::resolution\_hz (*C++ member*), 1039
- mcpwm\_capture\_timer\_disable (*C++ function*), 1036
- mcpwm\_capture\_timer\_enable (*C++ function*), 1036
- mcpwm\_capture\_timer\_get\_resolution (*C++ function*), 1037
- mcpwm\_capture\_timer\_set\_explicit\_base\_on\_sync (*C++ function*), 1037
- mcpwm\_capture\_timer\_start (*C++ function*), 1036
- mcpwm\_capture\_timer\_stop (*C++ function*), 1037
- mcpwm\_capture\_timer\_sync\_phase\_config\_t (*C++ struct*), 1039

mcpwm\_capture\_timer\_sync\_phase\_config\_t::count\_value  
 (C++ member), 1040  
 mcpwm\_capture\_timer\_sync\_phase\_config\_t::direction  
 (C++ member), 1040  
 mcpwm\_capture\_timer\_sync\_phase\_config\_t::sync  
 (C++ member), 1043  
 mcpwm\_carrier\_clock\_source\_t (C++ type), 1044  
 mcpwm\_carrier\_config\_t (C++ struct), 1021  
 mcpwm\_carrier\_config\_t::clk\_src (C++ member), 1021  
 mcpwm\_carrier\_config\_t::duty\_cycle (C++ member), 1021  
 mcpwm\_carrier\_config\_t::first\_pulse\_duration (C++ member), 1021  
 mcpwm\_carrier\_config\_t::flags (C++ member), 1022  
 mcpwm\_carrier\_config\_t::frequency\_hz (C++ member), 1021  
 mcpwm\_carrier\_config\_t::invert\_after\_monitored  
 (C++ member), 1021  
 mcpwm\_carrier\_config\_t::invert\_before\_monitored  
 (C++ member), 1021  
 mcpwm\_cmpr\_etm\_event\_config\_t (C++ struct), 1042  
 mcpwm\_cmpr\_etm\_event\_config\_t::event\_type (C++ member), 1042  
 mcpwm\_cmpr\_handle\_t (C++ type), 1043  
 mcpwm\_comparator\_config\_t (C++ struct), 1023  
 mcpwm\_comparator\_config\_t::flags (C++ member), 1023  
 mcpwm\_comparator\_config\_t::intr\_priority (C++ member), 1023  
 mcpwm\_comparator\_config\_t::update\_cmp\_on\_sync (C++ member), 1023  
 mcpwm\_comparator\_config\_t::update\_cmp\_on\_tep (C++ member), 1023  
 mcpwm\_comparator\_config\_t::update\_cmp\_on\_tez (C++ member), 1023  
 mcpwm\_comparator\_etm\_event\_type\_t (C++ enum), 1047  
 mcpwm\_comparator\_etm\_event\_type\_t::MCPWM\_CMPR\_ETM\_EVENT\_TYPE\_NORMAL (C++ enumerator), 1047  
 mcpwm\_comparator\_etm\_event\_type\_t::MCPWM\_CMPR\_ETM\_EVENT\_TYPE\_FAULT (C++ enumerator), 1047  
 mcpwm\_comparator\_event\_callbacks\_t (C++ struct), 1023  
 mcpwm\_comparator\_event\_callbacks\_t::on\_reach (C++ member), 1024  
 mcpwm\_comparator\_new\_etm\_event (C++ function), 1041  
 mcpwm\_comparator\_register\_event\_callbacks (C++ function), 1022  
 mcpwm\_comparator\_set\_compare\_value (C++ function), 1023  
 mcpwm\_compare\_event\_cb\_t (C++ type), 1044  
 mcpwm\_compare\_event\_data\_t (C++ struct), 1042  
 mcpwm\_compare\_event\_data\_t::compare\_ticks (C++ member), 1042  
 mcpwm\_compare\_event\_data\_t::direction (C++ member), 1043  
 mcpwm\_dead\_time\_config\_t (C++ struct), 1030  
 mcpwm\_dead\_time\_config\_t::flags (C++ member), 1030  
 mcpwm\_dead\_time\_config\_t::invert\_output (C++ member), 1030  
 mcpwm\_dead\_time\_config\_t::negedge\_delay\_ticks (C++ member), 1030  
 mcpwm\_dead\_time\_config\_t::posedge\_delay\_ticks (C++ member), 1030  
 mcpwm\_del\_capture\_channel (C++ function), 1038  
 mcpwm\_del\_capture\_timer (C++ function), 1036  
 mcpwm\_del\_comparator (C++ function), 1022  
 mcpwm\_del\_fault (C++ function), 1031  
 mcpwm\_del\_generator (C++ function), 1024  
 mcpwm\_del\_operator (C++ function), 1018  
 mcpwm\_del\_sync\_src (C++ function), 1034  
 mcpwm\_del\_timer (C++ function), 1014  
 mcpwm\_fault\_event\_callbacks\_t (C++ struct), 1033  
 mcpwm\_fault\_event\_callbacks\_t::on\_fault\_enter (C++ member), 1033  
 mcpwm\_fault\_event\_callbacks\_t::on\_fault\_exit (C++ member), 1033  
 mcpwm\_fault\_event\_cb\_t (C++ type), 1044  
 mcpwm\_fault\_event\_data\_t (C++ struct), 1042  
 mcpwm\_fault\_handle\_t (C++ type), 1043  
 mcpwm\_fault\_register\_event\_callbacks (C++ function), 1029  
 MCPWM\_GEN\_BRAKE\_EVENT\_ACTION (C macro), 1030  
 MCPWM\_GEN\_BRAKE\_EVENT\_ACTION\_END (C macro), 1030  
 mcpwm\_gen\_brake\_event\_action\_t (C++ struct), 1029  
 mcpwm\_gen\_brake\_event\_action\_t::action (C++ member), 1029  
 mcpwm\_gen\_brake\_event\_action\_t::brake\_mode (C++ member), 1029  
 mcpwm\_gen\_brake\_event\_action\_t::direction (C++ member), 1029  
 MCPWM\_GEN\_COMPARE\_EVENT\_ACTION (C macro), 1030  
 MCPWM\_GEN\_COMPARE\_EVENT\_ACTION\_END (C macro), 1030  
 mcpwm\_gen\_compare\_event\_action\_t (C++ struct), 1028  
 mcpwm\_gen\_compare\_event\_action\_t::action (C++ member), 1029  
 mcpwm\_gen\_compare\_event\_action\_t::comparator (C++ member), 1029  
 mcpwm\_gen\_compare\_event\_action\_t::direction (C++ member), 1029

- (C++ member), 1029
- MCPWM\_GEN\_FAULT\_EVENT\_ACTION (C macro), 1030
- mcpwm\_gen\_fault\_event\_action\_t (C++ struct), 1029
- mcpwm\_gen\_fault\_event\_action\_t::action (C++ member), 1029
- mcpwm\_gen\_fault\_event\_action\_t::direction (C++ member), 1029
- mcpwm\_gen\_fault\_event\_action\_t::fault (C++ member), 1029
- mcpwm\_gen\_handle\_t (C++ type), 1043
- MCPWM\_GEN\_SYNC\_EVENT\_ACTION (C macro), 1030
- mcpwm\_gen\_sync\_event\_action\_t (C++ struct), 1029
- mcpwm\_gen\_sync\_event\_action\_t::action (C++ member), 1030
- mcpwm\_gen\_sync\_event\_action\_t::direction (C++ member), 1030
- mcpwm\_gen\_sync\_event\_action\_t::sync (C++ member), 1030
- MCPWM\_GEN\_TIMER\_EVENT\_ACTION (C macro), 1030
- MCPWM\_GEN\_TIMER\_EVENT\_ACTION\_END (C macro), 1030
- mcpwm\_gen\_timer\_event\_action\_t (C++ struct), 1028
- mcpwm\_gen\_timer\_event\_action\_t::action (C++ member), 1028
- mcpwm\_gen\_timer\_event\_action\_t::direction (C++ member), 1028
- mcpwm\_gen\_timer\_event\_action\_t::event (C++ member), 1028
- mcpwm\_generator\_action\_t (C++ enum), 1046
- mcpwm\_generator\_action\_t::MCPWM\_GEN\_ACTION\_HIGH (C++ enumerator), 1046
- mcpwm\_generator\_action\_t::MCPWM\_GEN\_ACTION\_KEEP (C++ enumerator), 1046
- mcpwm\_generator\_action\_t::MCPWM\_GEN\_ACTION\_LOW (C++ enumerator), 1046
- mcpwm\_generator\_action\_t::MCPWM\_GEN\_ACTION\_TOGGLE (C++ enumerator), 1046
- mcpwm\_generator\_config\_t (C++ struct), 1028
- mcpwm\_generator\_config\_t::flags (C++ member), 1028
- mcpwm\_generator\_config\_t::gen\_gpio\_num (C++ member), 1028
- mcpwm\_generator\_config\_t::invert\_pwm (C++ member), 1028
- mcpwm\_generator\_config\_t::io\_loop\_back (C++ member), 1028
- mcpwm\_generator\_config\_t::io\_od\_mode (C++ member), 1028
- mcpwm\_generator\_config\_t::pull\_down (C++ member), 1028
- mcpwm\_generator\_config\_t::pull\_up (C++ member), 1028
- mcpwm\_generator\_set\_action\_on\_brake\_event (C++ function), 1026
- mcpwm\_generator\_set\_action\_on\_compare\_event (C++ function), 1025
- mcpwm\_generator\_set\_action\_on\_fault\_event (C++ function), 1027
- mcpwm\_generator\_set\_action\_on\_sync\_event (C++ function), 1027
- mcpwm\_generator\_set\_action\_on\_timer\_event (C++ function), 1025
- mcpwm\_generator\_set\_actions\_on\_brake\_event (C++ function), 1026
- mcpwm\_generator\_set\_actions\_on\_compare\_event (C++ function), 1026
- mcpwm\_generator\_set\_actions\_on\_timer\_event (C++ function), 1025
- mcpwm\_generator\_set\_dead\_time (C++ function), 1027
- mcpwm\_generator\_set\_force\_level (C++ function), 1024
- mcpwm\_gpio\_fault\_config\_t (C++ struct), 1032
- mcpwm\_gpio\_fault\_config\_t::active\_level (C++ member), 1032
- mcpwm\_gpio\_fault\_config\_t::flags (C++ member), 1032
- mcpwm\_gpio\_fault\_config\_t::gpio\_num (C++ member), 1032
- mcpwm\_gpio\_fault\_config\_t::group\_id (C++ member), 1032
- mcpwm\_gpio\_fault\_config\_t::intr\_priority (C++ member), 1032
- mcpwm\_gpio\_fault\_config\_t::io\_loop\_back (C++ member), 1032
- mcpwm\_gpio\_fault\_config\_t::pull\_down (C++ member), 1032
- mcpwm\_gpio\_fault\_config\_t::pull\_up (C++ member), 1032
- mcpwm\_gpio\_sync\_src\_config\_t (C++ struct), 1035
- mcpwm\_gpio\_sync\_src\_config\_t::active\_neg (C++ member), 1035
- mcpwm\_gpio\_sync\_src\_config\_t::flags (C++ member), 1035
- mcpwm\_gpio\_sync\_src\_config\_t::gpio\_num (C++ member), 1035
- mcpwm\_gpio\_sync\_src\_config\_t::group\_id (C++ member), 1035
- mcpwm\_gpio\_sync\_src\_config\_t::io\_loop\_back (C++ member), 1035
- mcpwm\_gpio\_sync\_src\_config\_t::pull\_down (C++ member), 1035
- mcpwm\_gpio\_sync\_src\_config\_t::pull\_up (C++ member), 1035
- mcpwm\_new\_capture\_channel (C++ function), 1037
- mcpwm\_new\_capture\_timer (C++ function), 1036

- mcpwm\_new\_comparator (C++ function), 1022  
 mcpwm\_new\_generator (C++ function), 1024  
 mcpwm\_new\_gpio\_fault (C++ function), 1031  
 mcpwm\_new\_gpio\_sync\_src (C++ function), 1033  
 mcpwm\_new\_operator (C++ function), 1018  
 mcpwm\_new\_soft\_fault (C++ function), 1031  
 mcpwm\_new\_soft\_sync\_src (C++ function), 1034  
 mcpwm\_new\_timer (C++ function), 1014  
 mcpwm\_new\_timer\_sync\_src (C++ function), 1033  
 mcpwm\_oper\_handle\_t (C++ type), 1043  
 mcpwm\_operator\_apply\_carrier (C++ function), 1019  
 mcpwm\_operator\_brake\_mode\_t (C++ enum), 1046  
 mcpwm\_operator\_brake\_mode\_t::MCPWM\_OPERATOR\_BRAKE\_MODE\_CBC (C++ enumerator), 1046  
 mcpwm\_operator\_brake\_mode\_t::MCPWM\_OPERATOR\_BRAKE\_MODE\_DISABLED (C++ enumerator), 1046  
 mcpwm\_operator\_brake\_mode\_t::MCPWM\_OPERATOR\_BRAKE\_MODE\_ON (C++ enumerator), 1046  
 mcpwm\_operator\_config\_t (C++ struct), 1020  
 mcpwm\_operator\_config\_t::flags (C++ member), 1020  
 mcpwm\_operator\_config\_t::group\_id (C++ member), 1020  
 mcpwm\_operator\_config\_t::intr\_priority (C++ member), 1020  
 mcpwm\_operator\_config\_t::update\_dead\_time (C++ member), 1020  
 mcpwm\_operator\_config\_t::update\_dead\_time\_on\_timer (C++ member), 1020  
 mcpwm\_operator\_config\_t::update\_dead\_time\_on\_timer2 (C++ member), 1020  
 mcpwm\_operator\_config\_t::update\_dead\_time\_on\_timer3 (C++ member), 1020  
 mcpwm\_operator\_config\_t::update\_gen\_action (C++ member), 1020  
 mcpwm\_operator\_config\_t::update\_gen\_action\_on (C++ member), 1020  
 mcpwm\_operator\_config\_t::update\_gen\_action\_on2 (C++ member), 1020  
 mcpwm\_operator\_connect\_timer (C++ function), 1018  
 mcpwm\_operator\_event\_callbacks\_t (C++ struct), 1021  
 mcpwm\_operator\_event\_callbacks\_t::on\_brake\_cb (C++ member), 1021  
 mcpwm\_operator\_event\_callbacks\_t::on\_brake\_os (C++ member), 1021  
 mcpwm\_operator\_recover\_from\_fault (C++ function), 1019  
 mcpwm\_operator\_register\_event\_callbacks (C++ function), 1019  
 mcpwm\_operator\_set\_brake\_on\_fault (C++ function), 1019  
 mcpwm\_soft\_fault\_activate (C++ function), 1031  
 mcpwm\_soft\_fault\_config\_t (C++ struct), 1033  
 mcpwm\_soft\_sync\_activate (C++ function), 1034  
 mcpwm\_soft\_sync\_config\_t (C++ struct), 1035  
 mcpwm\_sync\_handle\_t (C++ type), 1043  
 mcpwm\_timer\_clock\_source\_t (C++ type), 1044  
 mcpwm\_timer\_config\_t (C++ struct), 1017  
 mcpwm\_timer\_config\_t::clk\_src (C++ member), 1017  
 mcpwm\_timer\_config\_t::count\_mode (C++ member), 1017  
 mcpwm\_timer\_config\_t::flags (C++ member), 1017  
 mcpwm\_timer\_config\_t::group\_id (C++ member), 1017  
 mcpwm\_timer\_config\_t::intr\_priority (C++ member), 1017  
 mcpwm\_timer\_config\_t::period\_ticks (C++ member), 1017  
 mcpwm\_timer\_config\_t::resolution\_hz (C++ member), 1017  
 mcpwm\_timer\_config\_t::update\_period\_on\_empty (C++ member), 1017  
 mcpwm\_timer\_config\_t::update\_period\_on\_sync (C++ member), 1017  
 mcpwm\_timer\_count\_mode\_t (C++ enum), 1045  
 mcpwm\_timer\_count\_mode\_t::MCPWM\_TIMER\_COUNT\_MODE\_DISABLED (C++ enumerator), 1045  
 mcpwm\_timer\_count\_mode\_t::MCPWM\_TIMER\_COUNT\_MODE\_ON (C++ enumerator), 1045  
 mcpwm\_timer\_count\_mode\_t::MCPWM\_TIMER\_COUNT\_MODE\_ON2 (C++ enumerator), 1045  
 mcpwm\_timer\_count\_mode\_t::MCPWM\_TIMER\_COUNT\_MODE\_ON3 (C++ enumerator), 1045  
 mcpwm\_timer\_direction\_t (C++ enum), 1045  
 mcpwm\_timer\_direction\_t::MCPWM\_TIMER\_DIRECTION\_DOWN (C++ enumerator), 1045  
 mcpwm\_timer\_direction\_t::MCPWM\_TIMER\_DIRECTION\_UP (C++ enumerator), 1045  
 mcpwm\_timer\_disable (C++ function), 1015  
 mcpwm\_timer\_enable (C++ function), 1015  
 mcpwm\_timer\_event\_callbacks\_t (C++ struct), 1016  
 mcpwm\_timer\_event\_callbacks\_t::on\_empty (C++ member), 1017  
 mcpwm\_timer\_event\_callbacks\_t::on\_full (C++ member), 1017  
 mcpwm\_timer\_event\_callbacks\_t::on\_stop (C++ member), 1017  
 mcpwm\_timer\_event\_cb\_t (C++ type), 1043  
 mcpwm\_timer\_event\_data\_t (C++ struct), 1042  
 mcpwm\_timer\_event\_data\_t::count\_value (C++ member), 1042  
 mcpwm\_timer\_event\_data\_t::direction (C++ member), 1042  
 mcpwm\_timer\_event\_t (C++ enum), 1045

- mcpwm\_timer\_event\_t::MCPWM\_TIMER\_EVENT\_EMPTY heap\_info\_t::allocated\_blocks  
 (C++ enumerator), 1045 (C++ member), 1940  
 mcpwm\_timer\_event\_t::MCPWM\_TIMER\_EVENT\_FULL heap\_info\_t::free\_blocks (C++  
 (C++ enumerator), 1045 member), 1940  
 mcpwm\_timer\_event\_t::MCPWM\_TIMER\_EVENT\_INVALID heap\_info\_t::largest\_free\_block  
 (C++ enumerator), 1045 (C++ member), 1940  
 mcpwm\_timer\_handle\_t (C++ type), 1043 multi\_heap\_info\_t::minimum\_free\_bytes  
 (C++ member), 1940  
 mcpwm\_timer\_register\_event\_callbacks (C++ function), 1016 multi\_heap\_info\_t::total\_allocated\_bytes  
 (C++ member), 1940  
 mcpwm\_timer\_set\_period (C++ function), 1015 multi\_heap\_info\_t::total\_blocks (C++  
 (C++ function), 1016 member), 1940  
 mcpwm\_timer\_set\_phase\_on\_sync (C++ function), 1015 multi\_heap\_info\_t::total\_free\_bytes  
 (C++ member), 1940  
 mcpwm\_timer\_start\_stop (C++ function), 1015 multi\_heap\_malloc (C++ function), 1937  
 mcpwm\_timer\_start\_stop\_cmd\_t (C++ enum), multi\_heap\_info\_t::total\_free\_size (C++ func-  
 1045 tion), 1939  
 mcpwm\_timer\_start\_stop\_cmd\_t::MCPWM\_TIMER\_START\_STOP\_CMD\_EMPTY (C++ function), 1937  
 (C++ enumerator), 1046 multi\_heap\_register (C++ function), 1938  
 mcpwm\_timer\_start\_stop\_cmd\_t::MCPWM\_TIMER\_START\_STOP\_CMD\_FULL minimum\_free\_bytes  
 (C++ enumerator), 1046 (C++ function), 1939  
 mcpwm\_timer\_start\_stop\_cmd\_t::MCPWM\_TIMER\_START\_STOP\_CMD\_INVALID store\_minimum\_free\_bytes  
 (C++ enumerator), 1045 (C++ function), 1939  
 mcpwm\_timer\_start\_stop\_cmd\_t::MCPWM\_TIMER\_START\_STOP\_CMD\_LOCK set\_lock (C++ function), 1938  
 (C++ enumerator), 1045 multi\_heap\_walk (C++ function), 1939  
 mcpwm\_timer\_sync\_phase\_config\_t (C++ multi\_heap\_walker\_cb\_t (C++ type), 1940  
 struct), 1017  
 mcpwm\_timer\_sync\_phase\_config\_t::count\_value  
 (C++ member), 1018  
 mcpwm\_timer\_sync\_phase\_config\_t::direction  
 (C++ member), 1018  
 mcpwm\_timer\_sync\_phase\_config\_t::sync\_src  
 (C++ member), 1017  
 mcpwm\_timer\_sync\_src\_config\_t (C++ NVS\_DEFAULT\_PART\_NAME (C macro), 1644  
 struct), 1034 nvs\_entry\_find (C++ function), 1640  
 mcpwm\_timer\_sync\_src\_config\_t::flags nvs\_entry\_find\_in\_handle (C++ function),  
 (C++ member), 1035 1641  
 mcpwm\_timer\_sync\_src\_config\_t::propagate\_input\_sync nvs\_entry\_info (C++ function), 1641  
 (C++ member), 1035 nvs\_entry\_info\_t (C++ struct), 1642  
 mcpwm\_timer\_sync\_src\_config\_t::timer\_event nvs\_entry\_info\_t::key (C++ member), 1642  
 (C++ member), 1034 nvs\_entry\_info\_t::namespace\_name (C++  
 member), 1642  
 MessageBufferHandle\_t (C++ type), 1898 nvs\_entry\_info\_t::type (C++ member), 1642  
 MQTT\_ERROR\_TYPE\_ESP\_TLS (C macro), 49 nvs\_entry\_next (C++ function), 1641  
 multi\_heap\_aligned\_alloc (C++ function), nvs\_erase\_all (C++ function), 1638  
 1937 nvs\_erase\_key (C++ function), 1638  
 multi\_heap\_aligned\_alloc\_offs (C++ func- nvs\_find\_key (C++ function), 1638  
 tion), 1939 nvs\_flash\_deinit (C++ function), 1629  
 multi\_heap\_aligned\_free (C++ function), nvs\_flash\_deinit\_partition (C++ function),  
 1937 1629  
 multi\_heap\_check (C++ function), 1938 nvs\_flash\_erase (C++ function), 1629  
 multi\_heap\_dump (C++ function), 1938 nvs\_flash\_erase\_partition (C++ function),  
 multi\_heap\_free (C++ function), 1937 1629  
 multi\_heap\_free\_size (C++ function), 1938 nvs\_flash\_erase\_partition\_ptr (C++ func-  
 multi\_heap\_get\_allocated\_size (C++ func- tion), 1629  
 tion), 1938 nvs\_flash\_generate\_keys (C++ function),  
 multi\_heap\_get\_info (C++ function), 1939 1630  
 multi\_heap\_handle\_t (C++ type), 1940 nvs\_flash\_generate\_keys\_t (C++ type), 1632  
 multi\_heap\_info\_t (C++ struct), 1940

## N



- nvs\_flash\_generate\_keys\_v2 (C++ function), 1631  
 nvs\_flash\_get\_default\_security\_scheme (C++ function), 1631  
 nvs\_flash\_init (C++ function), 1628  
 nvs\_flash\_init\_partition (C++ function), 1628  
 nvs\_flash\_init\_partition\_ptr (C++ function), 1628  
 nvs\_flash\_read\_cfg\_t (C++ type), 1632  
 nvs\_flash\_read\_security\_cfg (C++ function), 1631  
 nvs\_flash\_read\_security\_cfg\_v2 (C++ function), 1631  
 nvs\_flash\_register\_security\_scheme (C++ function), 1631  
 nvs\_flash\_secure\_init (C++ function), 1630  
 nvs\_flash\_secure\_init\_partition (C++ function), 1630  
 nvs\_get\_blob (C++ function), 1636  
 nvs\_get\_i16 (C++ function), 1635  
 nvs\_get\_i32 (C++ function), 1635  
 nvs\_get\_i64 (C++ function), 1635  
 nvs\_get\_i8 (C++ function), 1634  
 nvs\_get\_stats (C++ function), 1639  
 nvs\_get\_str (C++ function), 1635  
 nvs\_get\_u16 (C++ function), 1635  
 nvs\_get\_u32 (C++ function), 1635  
 nvs\_get\_u64 (C++ function), 1635  
 nvs\_get\_u8 (C++ function), 1635  
 nvs\_get\_used\_entry\_count (C++ function), 1639  
 NVS\_GUARD\_SYSVIEW\_MACRO\_EXPANSION\_POP (C macro), 1644  
 NVS\_GUARD\_SYSVIEW\_MACRO\_EXPANSION\_PUSH (C macro), 1644  
 nvs\_handle (C++ type), 1645  
 nvs\_handle\_t (C++ type), 1645  
 nvs\_iterator\_t (C++ type), 1645  
 NVS\_KEY\_NAME\_MAX\_SIZE (C macro), 1644  
 NVS\_KEY\_SIZE (C macro), 1632  
 NVS\_NS\_NAME\_MAX\_SIZE (C macro), 1644  
 nvs\_open (C++ function), 1636  
 nvs\_open\_from\_partition (C++ function), 1637  
 nvs\_open\_mode (C++ type), 1645  
 nvs\_open\_mode\_t (C++ enum), 1645  
 nvs\_open\_mode\_t::NVS\_READONLY (C++ enumerator), 1645  
 nvs\_open\_mode\_t::NVS\_READWRITE (C++ enumerator), 1645  
 NVS\_PART\_NAME\_MAX\_SIZE (C macro), 1644  
 nvs\_release\_iterator (C++ function), 1642  
 nvs\_sec\_cfg\_t (C++ struct), 1632  
 nvs\_sec\_cfg\_t::key (C++ member), 1632  
 nvs\_sec\_cfg\_t::tky (C++ member), 1632  
 nvs\_sec\_config\_flash\_enc\_t (C++ struct), 1650  
 nvs\_sec\_config\_flash\_enc\_t::nvs\_keys\_part (C++ member), 1651  
 nvs\_sec\_config\_hmac\_t (C++ struct), 1651  
 nvs\_sec\_config\_hmac\_t::hmac\_key\_id (C++ member), 1651  
 NVS\_SEC\_PROVIDER\_CFG\_FLASH\_ENC\_DEFAULT (C macro), 1651  
 NVS\_SEC\_PROVIDER\_CFG\_HMAC\_DEFAULT (C macro), 1651  
 nvs\_sec\_provider\_deregister (C++ function), 1650  
 nvs\_sec\_provider\_register\_flash\_enc (C++ function), 1650  
 nvs\_sec\_provider\_register\_hmac (C++ function), 1650  
 nvs\_sec\_scheme\_id\_t (C++ enum), 1651  
 nvs\_sec\_scheme\_id\_t::NVS\_SEC\_SCHEME\_FLASH\_ENC (C++ enumerator), 1651  
 nvs\_sec\_scheme\_id\_t::NVS\_SEC\_SCHEME\_HMAC (C++ enumerator), 1651  
 nvs\_sec\_scheme\_id\_t::NVS\_SEC\_SCHEME\_MAX (C++ enumerator), 1652  
 nvs\_sec\_scheme\_t (C++ struct), 1632  
 nvs\_sec\_scheme\_t::nvs\_flash\_key\_gen (C++ member), 1632  
 nvs\_sec\_scheme\_t::nvs\_flash\_read\_cfg (C++ member), 1632  
 nvs\_sec\_scheme\_t::scheme\_data (C++ member), 1632  
 nvs\_sec\_scheme\_t::scheme\_id (C++ member), 1632  
 nvs\_set\_blob (C++ function), 1637  
 nvs\_set\_i16 (C++ function), 1633  
 nvs\_set\_i32 (C++ function), 1633  
 nvs\_set\_i64 (C++ function), 1633  
 nvs\_set\_i8 (C++ function), 1633  
 nvs\_set\_str (C++ function), 1634  
 nvs\_set\_u16 (C++ function), 1633  
 nvs\_set\_u32 (C++ function), 1633  
 nvs\_set\_u64 (C++ function), 1633  
 nvs\_set\_u8 (C++ function), 1633  
 nvs\_stats\_t (C++ struct), 1642  
 nvs\_stats\_t::available\_entries (C++ member), 1642  
 nvs\_stats\_t::free\_entries (C++ member), 1642  
 nvs\_stats\_t::namespace\_count (C++ member), 1642  
 nvs\_stats\_t::total\_entries (C++ member), 1642  
 nvs\_stats\_t::used\_entries (C++ member), 1642  
 nvs\_type\_t (C++ enum), 1645  
 nvs\_type\_t::NVS\_TYPE\_ANY (C++ enumerator), 1646  
 nvs\_type\_t::NVS\_TYPE\_BLOB (C++ enumerator), 1646  
 nvs\_type\_t::NVS\_TYPE\_I16 (C++ enumerator),

- [1645](#)  
 nvs\_type\_t::NVS\_TYPE\_I32 (*C++ enumerator*), [1645](#)  
 nvs\_type\_t::NVS\_TYPE\_I64 (*C++ enumerator*), [1645](#)  
 nvs\_type\_t::NVS\_TYPE\_I8 (*C++ enumerator*), [1645](#)  
 nvs\_type\_t::NVS\_TYPE\_STR (*C++ enumerator*), [1646](#)  
 nvs\_type\_t::NVS\_TYPE\_U16 (*C++ enumerator*), [1645](#)  
 nvs\_type\_t::NVS\_TYPE\_U32 (*C++ enumerator*), [1645](#)  
 nvs\_type\_t::NVS\_TYPE\_U64 (*C++ enumerator*), [1645](#)  
 nvs\_type\_t::NVS\_TYPE\_U8 (*C++ enumerator*), [1645](#)
- ## O
- OTA\_SIZE\_UNKNOWN (*C macro*), [2008](#)  
 OTA\_WITH\_SEQUENTIAL\_WRITES (*C macro*), [2008](#)
- ## P
- parlio\_bit\_pack\_order\_t (*C++ enum*), [1061](#)  
 parlio\_bit\_pack\_order\_t::PARLIO\_BIT\_PACK\_ORDER\_LSB (*C++ enumerator*), [1061](#)  
 parlio\_bit\_pack\_order\_t::PARLIO\_BIT\_PACK\_ORDER\_MSB (*C++ enumerator*), [1061](#)  
 parlio\_clock\_source\_t (*C++ type*), [1061](#)  
 parlio\_del\_rx\_delimiter (*C++ function*), [1054](#)  
 parlio\_del\_rx\_unit (*C++ function*), [1052](#)  
 parlio\_del\_tx\_unit (*C++ function*), [1048](#)  
 parlio\_new\_rx\_level\_delimiter (*C++ function*), [1053](#)  
 parlio\_new\_rx\_pulse\_delimiter (*C++ function*), [1053](#)  
 parlio\_new\_rx\_soft\_delimiter (*C++ function*), [1053](#)  
 parlio\_new\_rx\_unit (*C++ function*), [1052](#)  
 parlio\_new\_tx\_unit (*C++ function*), [1048](#)  
 parlio\_receive\_config\_t (*C++ struct*), [1059](#)  
 parlio\_receive\_config\_t::delimiter (*C++ member*), [1059](#)  
 parlio\_receive\_config\_t::flags (*C++ member*), [1059](#)  
 parlio\_receive\_config\_t::indirect\_mount (*C++ member*), [1059](#)  
 parlio\_receive\_config\_t::partial\_rx\_en (*C++ member*), [1059](#)  
 parlio\_rx\_callback\_t (*C++ type*), [1060](#)  
 parlio\_rx\_delimiter\_handle\_t (*C++ type*), [1060](#)  
 parlio\_rx\_event\_callbacks\_t (*C++ struct*), [1060](#)  
 parlio\_rx\_event\_callbacks\_t::on\_partial\_receive (*C++ member*), [1060](#)  
 parlio\_rx\_event\_callbacks\_t::on\_receive\_done (*C++ member*), [1060](#)  
 parlio\_rx\_event\_callbacks\_t::on\_timeout (*C++ member*), [1060](#)  
 parlio\_rx\_event\_data\_t (*C++ struct*), [1059](#)  
 parlio\_rx\_event\_data\_t::data (*C++ member*), [1059](#)  
 parlio\_rx\_event\_data\_t::delimiter (*C++ member*), [1059](#)  
 parlio\_rx\_event\_data\_t::recv\_bytes (*C++ member*), [1059](#)  
 parlio\_rx\_level\_delimiter\_config\_t (*C++ struct*), [1057](#)  
 parlio\_rx\_level\_delimiter\_config\_t::active\_low\_en (*C++ member*), [1057](#)  
 parlio\_rx\_level\_delimiter\_config\_t::bit\_pack\_order (*C++ member*), [1057](#)  
 parlio\_rx\_level\_delimiter\_config\_t::eof\_data\_len (*C++ member*), [1057](#)  
 parlio\_rx\_level\_delimiter\_config\_t::flags (*C++ member*), [1057](#)  
 parlio\_rx\_level\_delimiter\_config\_t::sample\_edge (*C++ member*), [1057](#)  
 parlio\_rx\_level\_delimiter\_config\_t::timeout\_ticks (*C++ member*), [1057](#)  
 parlio\_rx\_level\_delimiter\_config\_t::valid\_sig\_line (*C++ member*), [1057](#)  
 parlio\_rx\_pulse\_delimiter\_config\_t (*C++ struct*), [1058](#)  
 parlio\_rx\_pulse\_delimiter\_config\_t::bit\_pack\_order (*C++ member*), [1058](#)  
 parlio\_rx\_pulse\_delimiter\_config\_t::end\_bit\_included (*C++ member*), [1058](#)  
 parlio\_rx\_pulse\_delimiter\_config\_t::eof\_data\_len (*C++ member*), [1058](#)  
 parlio\_rx\_pulse\_delimiter\_config\_t::flags (*C++ member*), [1058](#)  
 parlio\_rx\_pulse\_delimiter\_config\_t::has\_end\_pulse (*C++ member*), [1058](#)  
 parlio\_rx\_pulse\_delimiter\_config\_t::pulse\_invert (*C++ member*), [1058](#)  
 parlio\_rx\_pulse\_delimiter\_config\_t::sample\_edge (*C++ member*), [1058](#)  
 parlio\_rx\_pulse\_delimiter\_config\_t::start\_bit\_included (*C++ member*), [1058](#)  
 parlio\_rx\_pulse\_delimiter\_config\_t::timeout\_ticks (*C++ member*), [1058](#)  
 parlio\_rx\_pulse\_delimiter\_config\_t::valid\_sig\_line (*C++ member*), [1058](#)  
 parlio\_rx\_soft\_delimiter\_config\_t (*C++ struct*), [1058](#)  
 parlio\_rx\_soft\_delimiter\_config\_t::bit\_pack\_order (*C++ member*), [1059](#)  
 parlio\_rx\_soft\_delimiter\_config\_t::eof\_data\_len (*C++ member*), [1059](#)  
 parlio\_rx\_soft\_delimiter\_config\_t::sample\_edge (*C++ member*), [1059](#)  
 parlio\_rx\_soft\_delimiter\_config\_t::timeout\_ticks (*C++ member*), [1059](#)

- (C++ member), 1059
- parlio\_rx\_soft\_delimiter\_start\_stop (C++ function), 1054
- parlio\_rx\_unit\_config\_t (C++ struct), 1056
- parlio\_rx\_unit\_config\_t::clk\_gate\_en (C++ member), 1057
- parlio\_rx\_unit\_config\_t::clk\_in\_gpio\_num (C++ member), 1056
- parlio\_rx\_unit\_config\_t::clk\_out\_gpio\_num (C++ member), 1056
- parlio\_rx\_unit\_config\_t::clk\_src (C++ member), 1056
- parlio\_rx\_unit\_config\_t::data\_gpio\_nums (C++ member), 1056
- parlio\_rx\_unit\_config\_t::data\_width (C++ member), 1056
- parlio\_rx\_unit\_config\_t::exp\_clk\_freq\_hz (C++ member), 1056
- parlio\_rx\_unit\_config\_t::ext\_clk\_freq\_hz (C++ member), 1056
- parlio\_rx\_unit\_config\_t::flags (C++ member), 1057
- parlio\_rx\_unit\_config\_t::free\_clk (C++ member), 1056
- parlio\_rx\_unit\_config\_t::io\_loop\_back (C++ member), 1057
- parlio\_rx\_unit\_config\_t::io\_no\_init (C++ member), 1057
- parlio\_rx\_unit\_config\_t::max\_rcv\_size (C++ member), 1056
- parlio\_rx\_unit\_config\_t::trans\_queue\_depth (C++ member), 1056
- parlio\_rx\_unit\_config\_t::valid\_gpio\_num (C++ member), 1056
- parlio\_rx\_unit\_disable (C++ function), 1054
- parlio\_rx\_unit\_enable (C++ function), 1054
- parlio\_rx\_unit\_handle\_t (C++ type), 1060
- PARLIO\_RX\_UNIT\_MAX\_DATA\_WIDTH (C macro), 1061
- parlio\_rx\_unit\_receive (C++ function), 1055
- parlio\_rx\_unit\_register\_event\_callbacks (C++ function), 1055
- parlio\_rx\_unit\_wait\_all\_done (C++ function), 1055
- parlio\_sample\_edge\_t (C++ enum), 1061
- parlio\_sample\_edge\_t::PARLIO\_SAMPLE\_EDGE\_NEG (C++ enumerator), 1061
- parlio\_sample\_edge\_t::PARLIO\_SAMPLE\_EDGE\_POS (C++ enumerator), 1061
- parlio\_transmit\_config\_t (C++ struct), 1051
- parlio\_transmit\_config\_t::flags (C++ member), 1052
- parlio\_transmit\_config\_t::idle\_value (C++ member), 1051
- parlio\_transmit\_config\_t::queue\_nonblocking (C++ member), 1052
- parlio\_tx\_done\_callback\_t (C++ type), 1052
- parlio\_tx\_done\_event\_data\_t (C++ struct), 1051
- parlio\_tx\_event\_callbacks\_t (C++ struct), 1051
- parlio\_tx\_event\_callbacks\_t::on\_trans\_done (C++ member), 1051
- parlio\_tx\_unit\_config\_t (C++ struct), 1050
- parlio\_tx\_unit\_config\_t::bit\_pack\_order (C++ member), 1051
- parlio\_tx\_unit\_config\_t::clk\_gate\_en (C++ member), 1051
- parlio\_tx\_unit\_config\_t::clk\_in\_gpio\_num (C++ member), 1050
- parlio\_tx\_unit\_config\_t::clk\_out\_gpio\_num (C++ member), 1050
- parlio\_tx\_unit\_config\_t::clk\_src (C++ member), 1050
- parlio\_tx\_unit\_config\_t::data\_gpio\_nums (C++ member), 1050
- parlio\_tx\_unit\_config\_t::data\_width (C++ member), 1050
- parlio\_tx\_unit\_config\_t::flags (C++ member), 1051
- parlio\_tx\_unit\_config\_t::input\_clk\_src\_freq\_hz (C++ member), 1050
- parlio\_tx\_unit\_config\_t::io\_loop\_back (C++ member), 1051
- parlio\_tx\_unit\_config\_t::max\_transfer\_size (C++ member), 1051
- parlio\_tx\_unit\_config\_t::output\_clk\_freq\_hz (C++ member), 1050
- parlio\_tx\_unit\_config\_t::sample\_edge (C++ member), 1051
- parlio\_tx\_unit\_config\_t::trans\_queue\_depth (C++ member), 1050
- parlio\_tx\_unit\_config\_t::valid\_gpio\_num (C++ member), 1050
- parlio\_tx\_unit\_disable (C++ function), 1048
- parlio\_tx\_unit\_enable (C++ function), 1048
- parlio\_tx\_unit\_handle\_t (C++ type), 1060
- PARLIO\_TX\_UNIT\_MAX\_DATA\_WIDTH (C macro), 1061
- parlio\_tx\_unit\_register\_event\_callbacks (C++ function), 1049
- parlio\_tx\_unit\_transmit (C++ function), 1049
- parlio\_tx\_unit\_wait\_all\_done (C++ function), 1050
- pcnt\_chan\_config\_t (C++ struct), 1074
- pcnt\_chan\_config\_t::edge\_gpio\_num (C++ member), 1074
- pcnt\_chan\_config\_t::flags (C++ member), 1074
- pcnt\_chan\_config\_t::invert\_edge\_input (C++ member), 1074
- pcnt\_chan\_config\_t::invert\_level\_input (C++ member), 1074
- pcnt\_chan\_config\_t::io\_loop\_back (C++ member), 1074



- pcnt\_chan\_config\_t::level\_gpio\_num (C++ member), 1074  
 pcnt\_chan\_config\_t::virt\_edge\_io\_level (C++ member), 1074  
 pcnt\_chan\_config\_t::virt\_level\_io\_level (C++ member), 1074  
 pcnt\_channel\_edge\_action\_t (C++ enum), 1075  
 pcnt\_channel\_edge\_action\_t::PCNT\_CHANNEL\_EDGE\_ACTION\_DECREASE (C++ enumerator), 1075  
 pcnt\_channel\_edge\_action\_t::PCNT\_CHANNEL\_EDGE\_ACTION\_HOLD (C++ enumerator), 1075  
 pcnt\_channel\_edge\_action\_t::PCNT\_CHANNEL\_EDGE\_ACTION\_INCREASE (C++ enumerator), 1075  
 pcnt\_channel\_handle\_t (C++ type), 1075  
 pcnt\_channel\_level\_action\_t (C++ enum), 1075  
 pcnt\_channel\_level\_action\_t::PCNT\_CHANNEL\_LEVEL\_ACTION\_HOLD (C++ enumerator), 1075  
 pcnt\_channel\_level\_action\_t::PCNT\_CHANNEL\_LEVEL\_ACTION\_INCREASE (C++ enumerator), 1075  
 pcnt\_channel\_level\_action\_t::PCNT\_CHANNEL\_LEVEL\_ACTION\_RESET (C++ enumerator), 1075  
 pcnt\_channel\_set\_edge\_action (C++ function), 1072  
 pcnt\_channel\_set\_level\_action (C++ function), 1072  
 pcnt\_del\_channel (C++ function), 1072  
 pcnt\_del\_unit (C++ function), 1067  
 pcnt\_event\_callbacks\_t (C++ struct), 1073  
 pcnt\_event\_callbacks\_t::on\_reach (C++ member), 1073  
 pcnt\_glitch\_filter\_config\_t (C++ struct), 1074  
 pcnt\_glitch\_filter\_config\_t::max\_glitch\_time (C++ member), 1074  
 pcnt\_new\_channel (C++ function), 1072  
 pcnt\_new\_unit (C++ function), 1067  
 pcnt\_unit\_add\_watch\_point (C++ function), 1071  
 pcnt\_unit\_clear\_count (C++ function), 1070  
 pcnt\_unit\_config\_t (C++ struct), 1073  
 pcnt\_unit\_config\_t::accum\_count (C++ member), 1074  
 pcnt\_unit\_config\_t::flags (C++ member), 1074  
 pcnt\_unit\_config\_t::high\_limit (C++ member), 1073  
 pcnt\_unit\_config\_t::intr\_priority (C++ member), 1073  
 pcnt\_unit\_config\_t::low\_limit (C++ member), 1073  
 pcnt\_unit\_disable (C++ function), 1069  
 pcnt\_unit\_enable (C++ function), 1068  
 pcnt\_unit\_get\_count (C++ function), 1070  
 pcnt\_unit\_handle\_t (C++ type), 1075  
 pcnt\_unit\_register\_event\_callbacks (C++ function), 1071  
 pcnt\_unit\_remove\_watch\_point (C++ function), 1071  
 pcnt\_unit\_set\_glitch\_filter (C++ function), 1068  
 pcnt\_unit\_start (C++ function), 1069  
 pcnt\_unit\_stop (C++ function), 1069  
 pcnt\_unit\_zero\_cross\_mode\_t (C++ enum), 1076  
 pcnt\_unit\_zero\_cross\_mode\_t::PCNT\_UNIT\_ZERO\_CROSS\_MODE\_HOLD (C++ enumerator), 1076  
 pcnt\_unit\_zero\_cross\_mode\_t::PCNT\_UNIT\_ZERO\_CROSS\_MODE\_INCREASE (C++ enumerator), 1076  
 pcnt\_unit\_zero\_cross\_mode\_t::PCNT\_UNIT\_ZERO\_CROSS\_MODE\_RESET (C++ enumerator), 1076  
 pcnt\_watch\_cb\_t (C++ type), 1075  
 pcnt\_watch\_event\_data\_t (C++ struct), 1073  
 pcnt\_watch\_event\_data\_t::watch\_point\_value (C++ member), 1073  
 pcnt\_watch\_event\_data\_t::zero\_cross\_mode (C++ member), 1073  
 pcQueueGetName (C++ function), 1827  
 pcTaskGetName (C++ function), 1802  
 pcTimerGetName (C++ function), 1861  
 PendedFunction\_t (C++ type), 1871  
 phy\_802\_3\_t (C++ struct), 733  
 phy\_802\_3\_t::addr (C++ member), 733  
 phy\_802\_3\_t::autonego\_timeout\_ms (C++ member), 733  
 phy\_802\_3\_t::eth (C++ member), 733  
 phy\_802\_3\_t::link\_status (C++ member), 733  
 phy\_802\_3\_t::parent (C++ member), 733  
 phy\_802\_3\_t::reset\_gpio\_num (C++ member), 733  
 phy\_802\_3\_t::reset\_timeout\_ms (C++ member), 733  
 phy\_init\_param\_set (C++ function), 2277  
 phy\_wifi\_enable\_set (C++ function), 2277  
 protocomm\_add\_endpoint (C++ function), 1594  
 protocomm\_ble\_config (C++ struct), 1606  
 protocomm\_ble\_config::ble\_addr (C++ member), 1607  
 protocomm\_ble\_config::ble\_bonding (C++ member), 1606  
 protocomm\_ble\_config::ble\_link\_encryption (C++ member), 1607  
 protocomm\_ble\_config::ble\_sm\_sc (C++ member), 1606  
 protocomm\_ble\_config::device\_name (C++ member), 1606  
 protocomm\_ble\_config::manufacturer\_data (C++ member), 1606  
 protocomm\_ble\_config::manufacturer\_data\_len (C++ member), 1606  
 protocomm\_ble\_config::nu\_lookup (C++ member), 1606

- protocomm\_ble\_config::nu\_lookup\_count (C++ member), 1606  
 protocomm\_ble\_config::service\_uuid (C++ member), 1606  
 protocomm\_ble\_config\_t (C++ type), 1607  
 protocomm\_ble\_event\_t (C++ struct), 1606  
 protocomm\_ble\_event\_t::conn\_handle (C++ member), 1606  
 protocomm\_ble\_event\_t::conn\_status (C++ member), 1606  
 protocomm\_ble\_event\_t::disconnect\_reason (C++ member), 1606  
 protocomm\_ble\_event\_t::evt\_type (C++ member), 1606  
 protocomm\_ble\_name\_uuid\_t (C++ type), 1607  
 protocomm\_ble\_start (C++ function), 1605  
 protocomm\_ble\_stop (C++ function), 1605  
 protocomm\_close\_session (C++ function), 1595  
 protocomm\_delete (C++ function), 1593  
 protocomm\_http\_server\_config\_t (C++ struct), 1604  
 protocomm\_http\_server\_config\_t::port (C++ member), 1604  
 protocomm\_http\_server\_config\_t::stack\_size (C++ member), 1604  
 protocomm\_http\_server\_config\_t::task\_priority (C++ member), 1604  
 protocomm\_httpd\_config\_data\_t (C++ union), 1604  
 protocomm\_httpd\_config\_data\_t::config (C++ member), 1604  
 protocomm\_httpd\_config\_data\_t::handle (C++ member), 1604  
 protocomm\_httpd\_config\_t (C++ struct), 1604  
 protocomm\_httpd\_config\_t::data (C++ member), 1604  
 protocomm\_httpd\_config\_t::ext\_handle\_provider (C++ member), 1604  
 PROTOCOLM\_HTTPD\_DEFAULT\_CONFIG (C macro), 1604  
 protocomm\_httpd\_start (C++ function), 1603  
 protocomm\_httpd\_stop (C++ function), 1603  
 protocomm\_new (C++ function), 1593  
 protocomm\_open\_session (C++ function), 1594  
 protocomm\_remove\_endpoint (C++ function), 1594  
 protocomm\_req\_handle (C++ function), 1595  
 protocomm\_req\_handler\_t (C++ type), 1597  
 protocomm\_security (C++ struct), 1598  
 protocomm\_security1\_params (C++ struct), 1597  
 protocomm\_security1\_params::data (C++ member), 1597  
 protocomm\_security1\_params::len (C++ member), 1597  
 protocomm\_security1\_params\_t (C++ type), 1599  
 protocomm\_security2\_params (C++ struct), 1597  
 protocomm\_security2\_params::salt (C++ member), 1598  
 protocomm\_security2\_params::salt\_len (C++ member), 1598  
 protocomm\_security2\_params::verifier (C++ member), 1598  
 protocomm\_security2\_params::verifier\_len (C++ member), 1598  
 protocomm\_security2\_params\_t (C++ type), 1599  
 protocomm\_security::cleanup (C++ member), 1598  
 protocomm\_security::close\_transport\_session (C++ member), 1598  
 protocomm\_security::decrypt (C++ member), 1598  
 protocomm\_security::encrypt (C++ member), 1598  
 protocomm\_security::init (C++ member), 1598  
 protocomm\_security::new\_transport\_session (C++ member), 1598  
 protocomm\_security::security\_req\_handler (C++ member), 1598  
 protocomm\_security::ver (C++ member), 1598  
 protocomm\_security\_handle\_t (C++ type), 1599  
 protocomm\_security\_pop\_t (C++ type), 1599  
 protocomm\_security\_session\_event\_t (C++ enum), 1599  
 protocomm\_security\_session\_event\_t::PROTOCOLM\_SECURITY\_SESSION\_EVENT\_ENUM (C++ enumerator), 1599  
 protocomm\_security\_session\_event\_t::PROTOCOLM\_SECURITY\_SESSION\_EVENT\_ENUM\_1 (C++ enumerator), 1599  
 protocomm\_security\_session\_event\_t::PROTOCOLM\_SECURITY\_SESSION\_EVENT\_ENUM\_2 (C++ enumerator), 1599  
 protocomm\_security\_t (C++ type), 1599  
 protocomm\_set\_security (C++ function), 1595  
 protocomm\_set\_version (C++ function), 1596  
 protocomm\_t (C++ type), 1597  
 protocomm\_transport\_ble\_event\_t (C++ enum), 1607  
 protocomm\_transport\_ble\_event\_t::PROTOCOLM\_TRANSPORT\_BLE\_EVENT\_ENUM (C++ enumerator), 1607  
 protocomm\_transport\_ble\_event\_t::PROTOCOLM\_TRANSPORT\_BLE\_EVENT\_ENUM\_1 (C++ enumerator), 1607  
 protocomm\_unset\_security (C++ function), 1596  
 protocomm\_unset\_version (C++ function), 1596  
 PROV\_DATA\_FLAGS\_FLAG (C macro), 362  
 PROV\_DATA\_IV\_INDEX\_FLAG (C macro), 362  
 PROV\_DATA\_NET\_IDX\_FLAG (C macro), 362  
 psk\_hint\_key\_t (C++ type), 67  
 psk\_key\_hint (C++ struct), 62

- psk\_key\_hint::hint (C++ member), 63  
 psk\_key\_hint::key (C++ member), 63  
 psk\_key\_hint::key\_size (C++ member), 63  
 PTHREAD\_STACK\_MIN (C macro), 2021  
 pvTaskGetThreadLocalStoragePointer (C++ function), 1803  
 pvTimerGetTimerID (C++ function), 1858  
 pxTaskGetStackStart (C++ function), 1920
- ## Q
- QueueHandle\_t (C++ type), 1839  
 QueueSetHandle\_t (C++ type), 1839  
 QueueSetMemberHandle\_t (C++ type), 1839
- ## R
- RingbufferType\_t (C++ enum), 1917  
 RingbufferType\_t::RINGBUF\_TYPE\_ALLOWSPILL (C++ enumerator), 1917  
 RingbufferType\_t::RINGBUF\_TYPE\_BYTEBUF (C++ enumerator), 1917  
 RingbufferType\_t::RINGBUF\_TYPE\_MAX (C++ enumerator), 1917  
 RingbufferType\_t::RINGBUF\_TYPE\_NOSPLIT (C++ enumerator), 1917  
 RingbufHandle\_t (C++ type), 1916  
 rmt\_alloc\_encoder\_mem (C++ function), 1099  
 rmt\_apply\_carrier (C++ function), 1096  
 rmt\_bytes\_encoder\_config\_t (C++ struct), 1100  
 rmt\_bytes\_encoder\_config\_t::bit0 (C++ member), 1100  
 rmt\_bytes\_encoder\_config\_t::bit1 (C++ member), 1100  
 rmt\_bytes\_encoder\_config\_t::flags (C++ member), 1100  
 rmt\_bytes\_encoder\_config\_t::msb\_first (C++ member), 1100  
 rmt\_bytes\_encoder\_update\_config (C++ function), 1098  
 rmt\_carrier\_config\_t (C++ struct), 1097  
 rmt\_carrier\_config\_t::always\_on (C++ member), 1097  
 rmt\_carrier\_config\_t::duty\_cycle (C++ member), 1097  
 rmt\_carrier\_config\_t::flags (C++ member), 1097  
 rmt\_carrier\_config\_t::frequency\_hz (C++ member), 1097  
 rmt\_carrier\_config\_t::polarity\_active\_low (C++ member), 1097  
 rmt\_channel\_handle\_t (C++ type), 1103  
 rmt\_clock\_source\_t (C++ type), 1104  
 rmt\_copy\_encoder\_config\_t (C++ struct), 1100  
 rmt\_del\_channel (C++ function), 1096  
 rmt\_del\_encoder (C++ function), 1099  
 rmt\_del\_sync\_manager (C++ function), 1091  
 rmt\_disable (C++ function), 1097  
 rmt\_enable (C++ function), 1097  
 rmt\_encode\_simple\_cb\_t (C++ type), 1101  
 rmt\_encode\_state\_t (C++ enum), 1101  
 rmt\_encode\_state\_t::RMT\_ENCODING\_COMPLETE (C++ enumerator), 1102  
 rmt\_encode\_state\_t::RMT\_ENCODING\_MEM\_FULL (C++ enumerator), 1102  
 rmt\_encode\_state\_t::RMT\_ENCODING\_RESET (C++ enumerator), 1101  
 rmt\_encoder\_handle\_t (C++ type), 1103  
 rmt\_encoder\_reset (C++ function), 1099  
 rmt\_encoder\_t (C++ struct), 1099  
 rmt\_encoder\_t::del (C++ member), 1100  
 rmt\_encoder\_t::encode (C++ member), 1099  
 rmt\_encoder\_t::reset (C++ member), 1100  
 rmt\_new\_bytes\_encoder (C++ function), 1098  
 rmt\_new\_copy\_encoder (C++ function), 1098  
 rmt\_new\_rx\_channel (C++ function), 1093  
 rmt\_new\_simple\_encoder (C++ function), 1099  
 rmt\_new\_sync\_manager (C++ function), 1090  
 rmt\_new\_tx\_channel (C++ function), 1089  
 rmt\_receive (C++ function), 1093  
 rmt\_receive\_config\_t (C++ struct), 1095  
 rmt\_receive\_config\_t::extra\_flags (C++ struct), 1096  
 rmt\_receive\_config\_t::extra\_flags::en\_partial\_rx (C++ member), 1096  
 rmt\_receive\_config\_t::flags (C++ member), 1096  
 rmt\_receive\_config\_t::signal\_range\_max\_ns (C++ member), 1096  
 rmt\_receive\_config\_t::signal\_range\_min\_ns (C++ member), 1096  
 rmt\_rx\_channel\_config\_t (C++ struct), 1095  
 rmt\_rx\_channel\_config\_t::clk\_src (C++ member), 1095  
 rmt\_rx\_channel\_config\_t::flags (C++ member), 1095  
 rmt\_rx\_channel\_config\_t::gpio\_num (C++ member), 1095  
 rmt\_rx\_channel\_config\_t::intr\_priority (C++ member), 1095  
 rmt\_rx\_channel\_config\_t::invert\_in (C++ member), 1095  
 rmt\_rx\_channel\_config\_t::io\_loop\_back (C++ member), 1095  
 rmt\_rx\_channel\_config\_t::mem\_block\_symbols (C++ member), 1095  
 rmt\_rx\_channel\_config\_t::resolution\_hz (C++ member), 1095  
 rmt\_rx\_channel\_config\_t::with\_dma (C++ member), 1095  
 rmt\_rx\_done\_callback\_t (C++ type), 1103  
 rmt\_rx\_done\_event\_data\_t (C++ struct), 1102  
 rmt\_rx\_done\_event\_data\_t::flags (C++ member), 1102  
 rmt\_rx\_done\_event\_data\_t::is\_last (C++ member), 1102

- rmt\_rx\_done\_event\_data\_t::num\_symbols (C++ member), 1102  
 rmt\_rx\_done\_event\_data\_t::received\_symbols (C++ member), 1102  
 rmt\_rx\_event\_callbacks\_t (C++ struct), 1094  
 rmt\_rx\_event\_callbacks\_t::on\_recv\_done (C++ member), 1095  
 rmt\_rx\_register\_event\_callbacks (C++ function), 1094  
 rmt\_simple\_encoder\_config\_t (C++ struct), 1100  
 rmt\_simple\_encoder\_config\_t::arg (C++ member), 1101  
 rmt\_simple\_encoder\_config\_t::callback (C++ member), 1101  
 rmt\_simple\_encoder\_config\_t::min\_chunk\_size (C++ member), 1101  
 rmt\_symbol\_word\_t (C++ union), 1103  
 rmt\_symbol\_word\_t::duration0 (C++ member), 1103  
 rmt\_symbol\_word\_t::duration1 (C++ member), 1103  
 rmt\_symbol\_word\_t::level0 (C++ member), 1103  
 rmt\_symbol\_word\_t::level1 (C++ member), 1104  
 rmt\_symbol\_word\_t::val (C++ member), 1104  
 rmt\_symbol\_word\_t::[anonymous] (C++ member), 1104  
 rmt\_sync\_manager\_config\_t (C++ struct), 1093  
 rmt\_sync\_manager\_config\_t::array\_size (C++ member), 1093  
 rmt\_sync\_manager\_config\_t::tx\_channel\_array (C++ member), 1093  
 rmt\_sync\_manager\_handle\_t (C++ type), 1103  
 rmt\_sync\_reset (C++ function), 1091  
 rmt\_transmit (C++ function), 1089  
 rmt\_transmit\_config\_t (C++ struct), 1092  
 rmt\_transmit\_config\_t::eot\_level (C++ member), 1092  
 rmt\_transmit\_config\_t::flags (C++ member), 1093  
 rmt\_transmit\_config\_t::loop\_count (C++ member), 1092  
 rmt\_transmit\_config\_t::queue\_nonblocking (C++ member), 1092  
 rmt\_tx\_channel\_config\_t (C++ struct), 1091  
 rmt\_tx\_channel\_config\_t::clk\_src (C++ member), 1092  
 rmt\_tx\_channel\_config\_t::flags (C++ member), 1092  
 rmt\_tx\_channel\_config\_t::gpio\_num (C++ member), 1092  
 rmt\_tx\_channel\_config\_t::intr\_priority (C++ member), 1092  
 rmt\_tx\_channel\_config\_t::invert\_out (C++ member), 1092  
 rmt\_tx\_channel\_config\_t::io\_loop\_back (C++ member), 1092  
 rmt\_tx\_channel\_config\_t::io\_od\_mode (C++ member), 1092  
 rmt\_tx\_channel\_config\_t::mem\_block\_symbols (C++ member), 1092  
 rmt\_tx\_channel\_config\_t::resolution\_hz (C++ member), 1092  
 rmt\_tx\_channel\_config\_t::trans\_queue\_depth (C++ member), 1092  
 rmt\_tx\_channel\_config\_t::with\_dma (C++ member), 1092  
 rmt\_tx\_done\_callback\_t (C++ type), 1103  
 rmt\_tx\_done\_event\_data\_t (C++ struct), 1102  
 rmt\_tx\_done\_event\_data\_t::num\_symbols (C++ member), 1102  
 rmt\_tx\_event\_callbacks\_t (C++ struct), 1091  
 rmt\_tx\_event\_callbacks\_t::on\_trans\_done (C++ member), 1091  
 rmt\_tx\_register\_event\_callbacks (C++ function), 1090  
 rmt\_tx\_wait\_all\_done (C++ function), 1090
- ## S
- sdm\_channel\_disable (C++ function), 1113  
 sdm\_channel\_enable (C++ function), 1113  
 sdm\_channel\_handle\_t (C++ type), 1115  
 sdm\_channel\_set\_duty (C++ function), 1114  
 sdm\_channel\_set\_pulse\_density (C++ function), 1114  
 sdm\_clock\_source\_t (C++ type), 1115  
 sdm\_config\_t (C++ struct), 1114  
 sdm\_config\_t::clk\_src (C++ member), 1115  
 sdm\_config\_t::flags (C++ member), 1115  
 sdm\_config\_t::gpio\_num (C++ member), 1114  
 sdm\_config\_t::invert\_out (C++ member), 1115  
 sdm\_config\_t::io\_loop\_back (C++ member), 1115  
 sdm\_config\_t::sample\_rate\_hz (C++ member), 1115  
 sdm\_del\_channel (C++ function), 1113  
 sdm\_new\_channel (C++ function), 1113  
 sdmmc\_can\_discard (C++ function), 1660  
 sdmmc\_can\_trim (C++ function), 1661  
 sdmmc\_card\_init (C++ function), 1659  
 sdmmc\_card\_print\_info (C++ function), 1659  
 sdmmc\_erase\_sectors (C++ function), 1660  
 sdmmc\_full\_erase (C++ function), 1661  
 sdmmc\_get\_status (C++ function), 1659  
 sdmmc\_io\_enable\_int (C++ function), 1663  
 SDMMC\_IO\_FIXED\_ADDR (C macro), 1664  
 sdmmc\_io\_get\_cis\_data (C++ function), 1663  
 sdmmc\_io\_print\_cis\_info (C++ function), 1664  
 sdmmc\_io\_read\_blocks (C++ function), 1662  
 sdmmc\_io\_read\_byte (C++ function), 1661  
 sdmmc\_io\_read\_bytes (C++ function), 1662

- sdmmc\_io\_wait\_int (C++ function), 1663
- sdmmc\_io\_write\_blocks (C++ function), 1663
- sdmmc\_io\_write\_byte (C++ function), 1661
- sdmmc\_io\_write\_bytes (C++ function), 1662
- sdmmc\_mmc\_can\_sanitiz (C++ function), 1661
- sdmmc\_mmc\_sanitiz (C++ function), 1661
- sdmmc\_read\_sectors (C++ function), 1660
- sdmmc\_write\_sectors (C++ function), 1660
- SDSPI\_DEFAULT\_DMA (C macro), 1109
- SDSPI\_DEFAULT\_HOST (C macro), 1109
- sdspi\_dev\_handle\_t (C++ type), 1110
- SDSPI\_DEVICE\_CONFIG\_DEFAULT (C macro), 1109
- sdspi\_device\_config\_t (C++ struct), 1108
- sdspi\_device\_config\_t::gpio\_cd (C++ member), 1109
- sdspi\_device\_config\_t::gpio\_cs (C++ member), 1109
- sdspi\_device\_config\_t::gpio\_int (C++ member), 1109
- sdspi\_device\_config\_t::gpio\_wp (C++ member), 1109
- sdspi\_device\_config\_t::gpio\_wp\_polarity (C++ member), 1109
- sdspi\_device\_config\_t::host\_id (C++ member), 1109
- SDSPI\_HOST\_DEFAULT (C macro), 1109
- sdspi\_host\_deinit (C++ function), 1108
- sdspi\_host\_do\_transaction (C++ function), 1107
- sdspi\_host\_get\_dma\_info (C++ function), 1108
- sdspi\_host\_get\_real\_freq (C++ function), 1108
- sdspi\_host\_init (C++ function), 1106
- sdspi\_host\_init\_device (C++ function), 1106
- sdspi\_host\_io\_int\_enable (C++ function), 1108
- sdspi\_host\_io\_int\_wait (C++ function), 1108
- sdspi\_host\_remove\_device (C++ function), 1107
- sdspi\_host\_set\_card\_clk (C++ function), 1107
- SDSPI\_IO\_ACTIVE\_LOW (C macro), 1109
- SDSPI\_SLOT\_NO\_CD (C macro), 1109
- SDSPI\_SLOT\_NO\_CS (C macro), 1109
- SDSPI\_SLOT\_NO\_INT (C macro), 1109
- SDSPI\_SLOT\_NO\_WP (C macro), 1109
- SemaphoreHandle\_t (C++ type), 1854
- semBINARY\_SEMAPHORE\_QUEUE\_LENGTH (C macro), 1840
- semGIVE\_BLOCK\_TIME (C macro), 1840
- semSEMAPHORE\_QUEUE\_ITEM\_LENGTH (C macro), 1840
- shared\_stack\_function (C++ type), 1714
- shutdown\_handler\_t (C++ type), 1984
- slave\_cb\_t (C++ type), 1183
- slave\_transaction\_cb\_t (C++ type), 1176
- sntp\_get\_sync\_interval (C++ function), 2059
- sntp\_get\_sync\_mode (C++ function), 2059
- sntp\_get\_sync\_status (C++ function), 2059
- sntp\_getoperatingmode (C++ function), 2061
- sntp\_getreachability (C++ function), 2060
- sntp\_getserver (C++ function), 2060
- sntp\_getservername (C++ function), 2060
- sntp\_init (C++ function), 2060
- SNTP\_OPMODE\_POLL (C macro), 2061
- sntp\_restart (C++ function), 2059
- sntp\_servermode\_dhcp (C++ function), 2060
- sntp\_set\_sync\_interval (C++ function), 2059
- sntp\_set\_sync\_mode (C++ function), 2059
- sntp\_set\_sync\_status (C++ function), 2059
- sntp\_set\_time\_sync\_notification\_cb (C++ function), 2059
- sntp\_setoperatingmode (C++ function), 2060
- sntp\_setservername (C++ function), 2060
- sntp\_sync\_mode\_t (C++ enum), 2061
- sntp\_sync\_mode\_t::SNTP\_SYNC\_MODE\_IMMED (C++ enumerator), 2061
- sntp\_sync\_mode\_t::SNTP\_SYNC\_MODE\_SMOOTH (C++ enumerator), 2061
- sntp\_sync\_status\_t (C++ enum), 2061
- sntp\_sync\_status\_t::SNTP\_SYNC\_STATUS\_COMPLETED (C++ enumerator), 2062
- sntp\_sync\_status\_t::SNTP\_SYNC\_STATUS\_IN\_PROGRESS (C++ enumerator), 2062
- sntp\_sync\_status\_t::SNTP\_SYNC\_STATUS\_RESET (C++ enumerator), 2061
- sntp\_sync\_time (C++ function), 2058
- sntp\_sync\_time\_cb\_t (C++ type), 2061
- SOC\_ADC\_ATTEN\_NUM (C macro), 2041
- SOC\_ADC\_CALIB\_CHAN\_COMPENS\_SUPPORTED (C macro), 2042
- SOC\_ADC\_CALIBRATION\_V1\_SUPPORTED (C macro), 2042
- SOC\_ADC\_CHANNEL\_NUM (C macro), 2041
- SOC\_ADC\_DIG\_CTRL\_SUPPORTED (C macro), 2041
- SOC\_ADC\_DIG\_IIR\_FILTER\_SUPPORTED (C macro), 2041
- SOC\_ADC\_DIG\_SUPPORTED\_UNIT (C macro), 2041
- SOC\_ADC\_DIGI\_CLKS (C macro), 816
- SOC\_ADC\_DIGI\_CONTROLLER\_NUM (C macro), 2041
- SOC\_ADC\_DIGI\_DATA\_BYTES\_PER\_CONV (C macro), 2042
- SOC\_ADC\_DIGI\_IIR\_FILTER\_NUM (C macro), 2042
- SOC\_ADC\_DIGI\_MAX\_BITWIDTH (C macro), 2041
- SOC\_ADC\_DIGI\_MIN\_BITWIDTH (C macro), 2041
- SOC\_ADC\_DIGI\_MONITOR\_NUM (C macro), 2042
- SOC\_ADC\_DIGI\_RESULT\_BYTES (C macro), 2042
- SOC\_ADC\_DMA\_SUPPORTED (C macro), 2041
- SOC\_ADC\_MAX\_CHANNEL\_NUM (C macro), 2041
- SOC\_ADC\_MONITOR\_SUPPORTED (C macro), 2041
- SOC\_ADC\_PATT\_LEN\_MAX (C macro), 2041
- SOC\_ADC\_PERIPH\_NUM (C macro), 2041



- SOC\_ADC\_RTC\_MAX\_BITWIDTH (*C macro*), 2042
- SOC\_ADC\_RTC\_MIN\_BITWIDTH (*C macro*), 2042
- SOC\_ADC\_SAMPLE\_FREQ\_THRES\_HIGH (*C macro*), 2042
- SOC\_ADC\_SAMPLE\_FREQ\_THRES\_LOW (*C macro*), 2042
- SOC\_ADC\_SELF\_HW\_CALI\_SUPPORTED (*C macro*), 2042
- SOC\_ADC\_SHARED\_POWER (*C macro*), 2042
- SOC\_ADC\_SUPPORTED (*C macro*), 2038
- SOC\_ADC\_TEMPERATURE\_SHARE\_INTR (*C macro*), 2042
- SOC\_AES\_GDMA (*C macro*), 2041
- SOC\_AES\_SUPPORT\_AES\_128 (*C macro*), 2041
- SOC\_AES\_SUPPORT\_AES\_256 (*C macro*), 2041
- SOC\_AES\_SUPPORT\_DMA (*C macro*), 2041
- SOC\_AES\_SUPPORTED (*C macro*), 2040
- SOC\_AHB\_GDMA\_SUPPORTED (*C macro*), 2038
- SOC\_AHB\_GDMA\_VERSION (*C macro*), 2043
- SOC\_ANA\_CMPR\_CLKS (*C macro*), 816
- SOC\_ANA\_CMPR\_INTR\_SHARE\_WITH\_GPIO (*C macro*), 2045
- SOC\_ANA\_CMPR\_NUM (*C macro*), 2045
- SOC\_ANA\_CMPR\_SUPPORTED (*C macro*), 2038
- SOC\_APB\_BACKUP\_DMA (*C macro*), 2042
- SOC\_APM\_CTRL\_FILTER\_SUPPORTED (*C macro*), 2040
- SOC\_APM\_SUPPORTED (*C macro*), 2040
- SOC\_ASSIST\_DEBUG\_SUPPORTED (*C macro*), 2040
- SOC\_ASYNC\_MEMCPY\_SUPPORTED (*C macro*), 2038
- SOC\_BLE\_50\_SUPPORTED (*C macro*), 2055
- SOC\_BLE\_DEVICE\_PRIVACY\_SUPPORTED (*C macro*), 2055
- SOC\_BLE\_MESH\_SUPPORTED (*C macro*), 2055
- SOC\_BLE\_MULTI\_CONN\_OPTIMIZATION (*C macro*), 2055
- SOC\_BLE\_PERIODIC\_ADV\_ENH\_SUPPORTED (*C macro*), 2055
- SOC\_BLE\_POWER\_CONTROL\_SUPPORTED (*C macro*), 2055
- SOC\_BLE\_SUPPORTED (*C macro*), 2055
- SOC\_BOD\_SUPPORTED (*C macro*), 2040
- SOC\_BROWNOUT\_RESET\_SUPPORTED (*C macro*), 2042
- SOC\_BT\_SUPPORTED (*C macro*), 2039
- SOC\_CACHE\_FREEZE\_SUPPORTED (*C macro*), 2042
- SOC\_CLK\_LP\_FAST\_SUPPORT\_LP\_PLL (*C macro*), 2054
- SOC\_CLK\_OSC\_SLOW\_FREQ\_APPROX (*C macro*), 815
- SOC\_CLK\_OSC\_SLOW\_SUPPORTED (*C macro*), 2054
- SOC\_CLK\_RC32K\_FREQ\_APPROX (*C macro*), 815
- SOC\_CLK\_RC32K\_SUPPORTED (*C macro*), 2054
- SOC\_CLK\_RC\_FAST\_FREQ\_APPROX (*C macro*), 815
- SOC\_CLK\_RC\_FAST\_SUPPORT\_CALIBRATION (*C macro*), 2054
- SOC\_CLK\_RC\_SLOW\_FREQ\_APPROX (*C macro*), 815
- SOC\_CLK\_TREE\_SUPPORTED (*C macro*), 2040
- SOC\_CLK\_XTAL32K\_FREQ\_APPROX (*C macro*), 815
- SOC\_CLK\_XTAL32K\_SUPPORTED (*C macro*), 2054
- soc\_clkout\_sig\_id\_t (*C++ enum*), 826
- soc\_clkout\_sig\_id\_t::CLKOUT\_SIG\_AHB (*C++ enumerator*), 827
- soc\_clkout\_sig\_id\_t::CLKOUT\_SIG\_APB (*C++ enumerator*), 827
- soc\_clkout\_sig\_id\_t::CLKOUT\_SIG\_CPU (*C++ enumerator*), 826
- soc\_clkout\_sig\_id\_t::CLKOUT\_SIG\_EXT32K (*C++ enumerator*), 827
- soc\_clkout\_sig\_id\_t::CLKOUT\_SIG\_INVALID (*C++ enumerator*), 827
- soc\_clkout\_sig\_id\_t::CLKOUT\_SIG\_RC\_32K (*C++ enumerator*), 827
- soc\_clkout\_sig\_id\_t::CLKOUT\_SIG\_RC\_FAST (*C++ enumerator*), 827
- soc\_clkout\_sig\_id\_t::CLKOUT\_SIG\_RC\_SLOW (*C++ enumerator*), 827
- soc\_clkout\_sig\_id\_t::CLKOUT\_SIG\_XTAL (*C++ enumerator*), 826
- soc\_clkout\_sig\_id\_t::CLKOUT\_SIG\_XTAL32K (*C++ enumerator*), 827
- SOC\_CLOCKOUT\_HAS\_SOURCE\_GATE (*C macro*), 2044
- SOC\_COEX\_HW\_PTI (*C macro*), 2053
- SOC\_CPU\_BREAKPOINTS\_NUM (*C macro*), 2043
- soc\_cpu\_clk\_src\_t (*C++ enum*), 817
- soc\_cpu\_clk\_src\_t::SOC\_CPU\_CLK\_SRC\_FLASH\_PLL (*C++ enumerator*), 817
- soc\_cpu\_clk\_src\_t::SOC\_CPU\_CLK\_SRC\_INVALID (*C++ enumerator*), 817
- soc\_cpu\_clk\_src\_t::SOC\_CPU\_CLK\_SRC\_PLL (*C++ enumerator*), 817
- soc\_cpu\_clk\_src\_t::SOC\_CPU\_CLK\_SRC\_RC\_FAST (*C++ enumerator*), 817
- soc\_cpu\_clk\_src\_t::SOC\_CPU\_CLK\_SRC\_XTAL (*C++ enumerator*), 817
- SOC\_CPU\_CORES\_NUM (*C macro*), 2042
- SOC\_CPU\_HAS\_CSR\_PC (*C macro*), 2043
- SOC\_CPU\_HAS\_FLEXIBLE\_INTC (*C macro*), 2042
- SOC\_CPU\_HAS\_PMA (*C macro*), 2043
- SOC\_CPU\_IDRAM\_SPLIT\_USING\_PMP (*C macro*), 2043
- SOC\_CPU\_INTR\_NUM (*C macro*), 2042
- SOC\_CPU\_WATCHPOINT\_MAX\_REGION\_SIZE (*C macro*), 2043
- SOC\_CPU\_WATCHPOINTS\_NUM (*C macro*), 2043
- SOC\_CRYPTDPA\_PROTECTION\_SUPPORTED (*C macro*), 2053
- SOC\_DEDIC\_GPIO\_IN\_CHANNELS\_NUM (*C macro*), 2045
- SOC\_DEDIC\_GPIO\_OUT\_CHANNELS\_NUM (*C macro*), 2044
- SOC\_DEDIC\_PERIPH\_ALWAYS\_ENABLE (*C macro*), 2044

- macro*), 2045
- SOC\_DEDICATED\_GPIO\_SUPPORTED (*C macro*), 2038
- SOC\_DEEP\_SLEEP\_SUPPORTED (*C macro*), 2041
- SOC\_DIG\_SIGN\_SUPPORTED (*C macro*), 2040
- SOC\_DS\_KEY\_CHECK\_MAX\_WAIT\_US (*C macro*), 2043
- SOC\_DS\_KEY\_PARAM\_MD\_IV\_LENGTH (*C macro*), 2043
- SOC\_DS\_SIGNATURE\_MAX\_BIT\_LEN (*C macro*), 2043
- SOC\_ECC\_EXTENDED\_MODES\_SUPPORTED (*C macro*), 2040
- SOC\_ECC\_SUPPORTED (*C macro*), 2040
- SOC\_ECDSA\_SUPPORTED (*C macro*), 2040
- SOC\_ECDSA\_USES\_MPI (*C macro*), 2053
- SOC\_EFUSE\_BLOCK9\_KEY\_PURPOSE\_QUIRK (*C macro*), 2052
- SOC\_EFUSE\_DIS\_DIRECT\_BOOT (*C macro*), 2052
- SOC\_EFUSE\_DIS\_ICACHE (*C macro*), 2052
- SOC\_EFUSE\_DIS\_PAD\_JTAG (*C macro*), 2052
- SOC\_EFUSE\_DIS\_USB\_JTAG (*C macro*), 2052
- SOC\_EFUSE\_ECDSA\_KEY (*C macro*), 2052
- SOC\_EFUSE\_ECDSA\_USE\_HARDWARE\_K (*C macro*), 2052
- SOC\_EFUSE\_KEY\_PURPOSE\_FIELD (*C macro*), 2039
- SOC\_EFUSE\_REVOKE\_BOOT\_KEY\_DIGESTS (*C macro*), 2053
- SOC\_EFUSE\_SECURE\_BOOT\_KEY\_DIGESTS (*C macro*), 2052
- SOC\_EFUSE\_SOFT\_DIS\_JTAG (*C macro*), 2052
- SOC\_EFUSE\_SUPPORTED (*C macro*), 2039
- SOC\_ESP\_NIMBLE\_CONTROLLER (*C macro*), 2055
- SOC\_ETM\_CHANNELS\_PER\_GROUP (*C macro*), 2043
- SOC\_ETM\_GROUPS (*C macro*), 2043
- SOC\_ETM\_SUPPORTED (*C macro*), 2039
- SOC\_EXTERNAL\_COEX\_ADVANCE (*C macro*), 2053
- SOC\_EXTERNAL\_COEX\_LEADER\_TX\_LINE (*C macro*), 2053
- SOC\_FLASH\_ENC\_SUPPORTED (*C macro*), 2040
- SOC\_FLASH\_ENCRYPTED\_XTS\_AES\_BLOCK\_MAX (*C macro*), 2053
- SOC\_FLASH\_ENCRYPTION\_XTS\_AES (*C macro*), 2053
- SOC\_FLASH\_ENCRYPTION\_XTS\_AES\_128 (*C macro*), 2053
- SOC\_GDMA\_NUM\_GROUPS\_MAX (*C macro*), 2043
- SOC\_GDMA\_PAIRS\_PER\_GROUP\_MAX (*C macro*), 2043
- SOC\_GDMA\_SUPPORT\_ETM (*C macro*), 2043
- SOC\_GDMA\_SUPPORT\_SLEEP\_RETENTION (*C macro*), 2043
- SOC\_GDMA\_SUPPORTED (*C macro*), 2038
- SOC\_GLITCH\_FILTER\_CLKS (*C macro*), 816
- SOC\_GPIO\_CLOCKOUT\_BY\_GPIO\_MATRIX (*C macro*), 2044
- SOC\_GPIO\_CLOCKOUT\_CHANNEL\_NUM (*C macro*), 2044
- SOC\_GPIO\_FLEX\_GLITCH\_FILTER\_NUM (*C macro*), 2044
- SOC\_GPIO\_IN\_RANGE\_MAX (*C macro*), 2044
- SOC\_GPIO\_OUT\_RANGE\_MAX (*C macro*), 2044
- SOC\_GPIO\_PIN\_COUNT (*C macro*), 2044
- SOC\_GPIO\_PORT (*C macro*), 2044
- SOC\_GPIO\_SUPPORT\_ETM (*C macro*), 2044
- SOC\_GPIO\_SUPPORT\_FORCE\_HOLD (*C macro*), 2044
- SOC\_GPIO\_SUPPORT\_HOLD\_SINGLE\_IO\_IN\_DSLP (*C macro*), 2044
- SOC\_GPIO\_SUPPORT\_PIN\_GLITCH\_FILTER (*C macro*), 2044
- SOC\_GPIO\_SUPPORT\_PIN\_HYS\_CTRL\_BY\_EFUSE (*C macro*), 2044
- SOC\_GPIO\_SUPPORT\_PIN\_HYS\_FILTER (*C macro*), 2044
- SOC\_GPIO\_SUPPORT\_RTC\_INDEPENDENT (*C macro*), 2044
- SOC\_GPIO\_VALID\_DIGITAL\_IO\_PAD\_MASK (*C macro*), 2044
- SOC\_GPIO\_VALID\_GPIO\_MASK (*C macro*), 2044
- SOC\_GPIO\_VALID\_OUTPUT\_GPIO\_MASK (*C macro*), 2044
- SOC\_GPSPi\_SUPPORTED (*C macro*), 2039
- SOC\_GPTIMER\_CLKS (*C macro*), 815
- SOC\_GPTIMER\_SUPPORTED (*C macro*), 2039
- SOC\_HMAC\_SUPPORTED (*C macro*), 2040
- SOC\_HP\_I2C\_NUM (*C macro*), 2045
- SOC\_I2C\_CLKS (*C macro*), 816
- SOC\_I2C\_CMD\_REG\_NUM (*C macro*), 2045
- SOC\_I2C\_FIFO\_LEN (*C macro*), 2045
- SOC\_I2C\_NUM (*C macro*), 2045
- SOC\_I2C\_SLAVE\_CAN\_GET\_STRETCH\_CAUSE (*C macro*), 2045
- SOC\_I2C\_SLAVE\_SUPPORT\_BROADCAST (*C macro*), 2045
- SOC\_I2C\_SLAVE\_SUPPORT\_I2CRAM\_ACCESS (*C macro*), 2045
- SOC\_I2C\_SLAVE\_SUPPORT\_SLAVE\_UNMATCH (*C macro*), 2045
- SOC\_I2C\_SUPPORT\_10BIT\_ADDR (*C macro*), 2045
- SOC\_I2C\_SUPPORT\_HW\_CLR\_BUS (*C macro*), 2045
- SOC\_I2C\_SUPPORT\_HW\_FSM\_RST (*C macro*), 2045
- SOC\_I2C\_SUPPORT\_RTC (*C macro*), 2045
- SOC\_I2C\_SUPPORT\_SLAVE (*C macro*), 2045
- SOC\_I2C\_SUPPORT\_SLEEP\_RETENTION (*C macro*), 2045
- SOC\_I2C\_SUPPORT\_XTAL (*C macro*), 2045
- SOC\_I2C\_SUPPORTED (*C macro*), 2039
- SOC\_I2S\_CLKS (*C macro*), 816
- SOC\_I2S\_HW\_VERSION\_2 (*C macro*), 2046
- SOC\_I2S\_NUM (*C macro*), 2045
- SOC\_I2S\_PDM\_MAX\_TX\_LINES (*C macro*), 2046
- SOC\_I2S\_SUPPORTED (*C macro*), 2039
- SOC\_I2S\_SUPPORTS\_PCM (*C macro*), 2046
- SOC\_I2S\_SUPPORTS\_PDM (*C macro*), 2046

- SOC\_I2S\_SUPPORTS\_PDM\_TX (*C macro*), 2046
- SOC\_I2S\_SUPPORTS\_PLL\_F64M (*C macro*), 2046
- SOC\_I2S\_SUPPORTS\_PLL\_F96M (*C macro*), 2046
- SOC\_I2S\_SUPPORTS\_TDM (*C macro*), 2046
- SOC\_I2S\_SUPPORTS\_XTAL (*C macro*), 2046
- SOC\_I2S\_TDM\_FULL\_DATA\_WIDTH (*C macro*), 2046
- SOC\_IEEE802154\_BLE\_ONLY (*C macro*), 2039
- SOC\_IEEE802154\_SUPPORTED (*C macro*), 2039
- SOC\_INT\_PLIC\_SUPPORTED (*C macro*), 2043
- SOC\_LEDC\_CHANNEL\_NUM (*C macro*), 2046
- SOC\_LEDC\_CLKS (*C macro*), 816
- SOC\_LEDC\_FADE\_PARAMS\_BIT\_WIDTH (*C macro*), 2046
- SOC\_LEDC\_GAMMA\_CURVE\_FADE\_RANGE\_MAX (*C macro*), 2046
- SOC\_LEDC\_GAMMA\_CURVE\_FADE\_SUPPORTED (*C macro*), 2046
- SOC\_LEDC\_SUPPORT\_FADE\_STOP (*C macro*), 2046
- SOC\_LEDC\_SUPPORT\_PLL\_DIV\_CLOCK (*C macro*), 2046
- SOC\_LEDC\_SUPPORT\_XTAL\_CLOCK (*C macro*), 2046
- SOC\_LEDC\_SUPPORTED (*C macro*), 2039
- SOC\_LEDC\_TIMER\_BIT\_WIDTH (*C macro*), 2046
- SOC\_LIGHT\_SLEEP\_SUPPORTED (*C macro*), 2041
- SOC\_LP\_AON\_SUPPORTED (*C macro*), 2040
- SOC\_LP\_IO\_CLOCK\_IS\_INDEPENDENT (*C macro*), 2044
- soc\_lp\_pll\_clk\_src\_t (*C++ enum*), 818
- soc\_lp\_pll\_clk\_src\_t::SOC\_LP\_PLL\_CLK\_SRC\_INVALID (*C++ enumerator*), 818
- soc\_lp\_pll\_clk\_src\_t::SOC\_LP\_PLL\_CLK\_SRC\_RC32K (*C++ enumerator*), 818
- soc\_lp\_pll\_clk\_src\_t::SOC\_LP\_PLL\_CLK\_SRC\_XTAL32K (*C++ enumerator*), 818
- SOC\_LP\_TIMER\_BIT\_WIDTH\_HI (*C macro*), 2051
- SOC\_LP\_TIMER\_BIT\_WIDTH\_LO (*C macro*), 2051
- SOC\_LP\_TIMER\_SUPPORTED (*C macro*), 2040
- SOC\_MCPWM\_CAPTURE\_CHANNELS\_PER\_TIMER (*C macro*), 2048
- SOC\_MCPWM\_CAPTURE\_CLK\_FROM\_GROUP (*C macro*), 2048
- SOC\_MCPWM\_CAPTURE\_CLKS (*C macro*), 815
- SOC\_MCPWM\_CAPTURE\_TIMERS\_PER\_GROUP (*C macro*), 2048
- SOC\_MCPWM\_CARRIER\_CLKS (*C macro*), 815
- SOC\_MCPWM\_COMPARATORS\_PER\_OPERATOR (*C macro*), 2048
- SOC\_MCPWM\_GENERATORS\_PER\_OPERATOR (*C macro*), 2048
- SOC\_MCPWM\_GPIO\_FAULTS\_PER\_GROUP (*C macro*), 2048
- SOC\_MCPWM\_GPIO\_SYNCHROS\_PER\_GROUP (*C macro*), 2048
- SOC\_MCPWM\_GROUPS (*C macro*), 2048
- SOC\_MCPWM\_OPERATORS\_PER\_GROUP (*C macro*), 2048
- SOC\_MCPWM\_SUPPORT\_ETM (*C macro*), 2048
- SOC\_MCPWM\_SUPPORTED (*C macro*), 2039
- SOC\_MCPWM\_SWSYNC\_CAN\_PROPAGATE (*C macro*), 2048
- SOC\_MCPWM\_TIMER\_CLKS (*C macro*), 815
- SOC\_MCPWM\_TIMERS\_PER\_GROUP (*C macro*), 2048
- SOC\_MCPWM\_TRIGGERS\_PER\_OPERATOR (*C macro*), 2048
- SOC\_MEMSPI\_FLASH\_CLK\_SRC\_IS\_INDEPENDENT (*C macro*), 2051
- SOC\_MEMSPI\_IS\_INDEPENDENT (*C macro*), 2050
- SOC\_MEMSPI\_SRC\_FREQ\_16M\_SUPPORTED (*C macro*), 2051
- SOC\_MEMSPI\_SRC\_FREQ\_32M\_SUPPORTED (*C macro*), 2051
- SOC\_MEMSPI\_SRC\_FREQ\_64M\_SUPPORTED (*C macro*), 2051
- SOC\_MMU\_DI\_VADDR\_SHARED (*C macro*), 2043
- SOC\_MMU\_LINEAR\_ADDRESS\_REGION\_NUM (*C macro*), 2043
- SOC\_MMU\_PAGE\_SIZE\_CONFIGURABLE (*C macro*), 2043
- SOC\_MMU\_PERIPH\_NUM (*C macro*), 2043
- SOC\_MODEM\_CLOCK\_IS\_INDEPENDENT (*C macro*), 2055
- SOC\_MODEM\_CLOCK\_SUPPORTED (*C macro*), 2041
- soc\_module\_clk\_t (*C++ enum*), 819
- soc\_module\_clk\_t::SOC\_MOD\_CLK\_CPU (*C++ enumerator*), 819
- soc\_module\_clk\_t::SOC\_MOD\_CLK\_INVALID (*C++ enumerator*), 820
- soc\_module\_clk\_t::SOC\_MOD\_CLK\_PLL\_F48M (*C++ enumerator*), 819
- soc\_module\_clk\_t::SOC\_MOD\_CLK\_PLL\_F64M (*C++ enumerator*), 819
- soc\_module\_clk\_t::SOC\_MOD\_CLK\_PLL\_F96M (*C++ enumerator*), 819
- soc\_module\_clk\_t::SOC\_MOD\_CLK\_RC\_FAST (*C++ enumerator*), 819
- soc\_module\_clk\_t::SOC\_MOD\_CLK\_RTC\_FAST (*C++ enumerator*), 819
- soc\_module\_clk\_t::SOC\_MOD\_CLK\_RTC\_SLOW (*C++ enumerator*), 819
- soc\_module\_clk\_t::SOC\_MOD\_CLK\_XTAL (*C++ enumerator*), 820
- soc\_module\_clk\_t::SOC\_MOD\_CLK\_XTAL32K (*C++ enumerator*), 819
- SOC\_MPI\_MEM\_BLOCKS\_NUM (*C macro*), 2049
- SOC\_MPI\_OPERATIONS\_NUM (*C macro*), 2049
- SOC\_MPI\_SUPPORTED (*C macro*), 2040
- SOC\_MPU\_CONFIGURABLE\_REGIONS\_SUPPORTED (*C macro*), 2046
- SOC\_MPU\_MIN\_REGION\_SIZE (*C macro*), 2046
- SOC\_MPU\_REGION\_RO\_SUPPORTED (*C macro*), 2046
- SOC\_MPU\_REGION\_WO\_SUPPORTED (*C macro*), 2047
- SOC\_MPU\_REGIONS\_MAX\_NUM (*C macro*), 2046



- SOC\_MSPI\_CLKS (*C macro*), 816
- SOC\_MWDT\_CLKS (*C macro*), 816
- SOC\_MWDT\_SUPPORT\_XTAL (*C macro*), 2052
- SOC\_PARLIO\_CLKS (*C macro*), 816
- SOC\_PARLIO\_GROUPS (*C macro*), 2048
- SOC\_PARLIO\_RX\_CLK\_SUPPORT\_GATING (*C macro*), 2049
- SOC\_PARLIO\_RX\_CLK\_SUPPORT\_OUTPUT (*C macro*), 2049
- SOC\_PARLIO\_RX\_UNIT\_MAX\_DATA\_WIDTH (*C macro*), 2049
- SOC\_PARLIO\_RX\_UNITS\_PER\_GROUP (*C macro*), 2049
- SOC\_PARLIO\_SUPPORTED (*C macro*), 2039
- SOC\_PARLIO\_TRANS\_BIT\_ALIGN (*C macro*), 2049
- SOC\_PARLIO\_TX\_CLK\_SUPPORT\_GATING (*C macro*), 2049
- SOC\_PARLIO\_TX\_UNIT\_MAX\_DATA\_WIDTH (*C macro*), 2049
- SOC\_PARLIO\_TX\_UNITS\_PER\_GROUP (*C macro*), 2049
- SOC\_PAU\_SUPPORTED (*C macro*), 2040
- SOC\_PCNT\_CHANNELS\_PER\_UNIT (*C macro*), 2047
- SOC\_PCNT\_GROUPS (*C macro*), 2047
- SOC\_PCNT\_SUPPORT\_RUNTIME\_THRES\_UPDATE (*C macro*), 2047
- SOC\_PCNT\_SUPPORTED (*C macro*), 2038
- SOC\_PCNT\_THRES\_POINT\_PER\_UNIT (*C macro*), 2047
- SOC\_PCNT\_UNITS\_PER\_GROUP (*C macro*), 2047
- soc\_periph\_adc\_digi\_clk\_src\_t (*C++ enum*), 824
- soc\_periph\_adc\_digi\_clk\_src\_t::ADC\_DIGI\_CLK\_SRC\_DEFAULT (*C++ enumerator*), 825
- soc\_periph\_adc\_digi\_clk\_src\_t::ADC\_DIGI\_CLK\_SRC\_PLL\_196M (*C++ enumerator*), 825
- soc\_periph\_adc\_digi\_clk\_src\_t::ADC\_DIGI\_CLK\_SRC\_PLL\_FAST (*C++ enumerator*), 825
- soc\_periph\_adc\_digi\_clk\_src\_t::ADC\_DIGI\_CLK\_SRC\_XTAL (*C++ enumerator*), 824
- soc\_periph\_ana\_cmpr\_clk\_src\_t (*C++ enum*), 824
- soc\_periph\_ana\_cmpr\_clk\_src\_t::ANA\_CMPRS\_CLK\_SRC\_DEFAULT (*C++ enumerator*), 824
- soc\_periph\_ana\_cmpr\_clk\_src\_t::ANA\_CMPRS\_CLK\_SRC\_PLL\_196M (*C++ enumerator*), 824
- soc\_periph\_ana\_cmpr\_clk\_src\_t::ANA\_CMPRS\_CLK\_SRC\_XTAL (*C++ enumerator*), 824
- soc\_periph\_glitch\_filter\_clk\_src\_t (*C++ enum*), 824
- soc\_periph\_glitch\_filter\_clk\_src\_t::GLITCH\_FILTER\_CLK\_SRC\_DEFAULT (*C++ enumerator*), 824
- soc\_periph\_glitch\_filter\_clk\_src\_t::GLITCH\_FILTER\_CLK\_SRC\_PLL\_196M (*C++ enumerator*), 824
- soc\_periph\_glitch\_filter\_clk\_src\_t::GLITCH\_FILTER\_CLK\_SRC\_XTAL (*C++ enumerator*), 824
- soc\_periph\_gptimer\_clk\_src\_t (*C++ enum*), 820
- soc\_periph\_gptimer\_clk\_src\_t::GPTIMER\_CLK\_SRC\_DEFAULT (*C++ enumerator*), 820
- soc\_periph\_gptimer\_clk\_src\_t::GPTIMER\_CLK\_SRC\_PLL (*C++ enumerator*), 820
- soc\_periph\_gptimer\_clk\_src\_t::GPTIMER\_CLK\_SRC\_RC (*C++ enumerator*), 820
- soc\_periph\_gptimer\_clk\_src\_t::GPTIMER\_CLK\_SRC\_XTAL (*C++ enumerator*), 820
- soc\_periph\_i2c\_clk\_src\_t (*C++ enum*), 823
- soc\_periph\_i2c\_clk\_src\_t::I2C\_CLK\_SRC\_DEFAULT (*C++ enumerator*), 823
- soc\_periph\_i2c\_clk\_src\_t::I2C\_CLK\_SRC\_RC\_FAST (*C++ enumerator*), 823
- soc\_periph\_i2c\_clk\_src\_t::I2C\_CLK\_SRC\_XTAL (*C++ enumerator*), 823
- soc\_periph\_i2s\_clk\_src\_t (*C++ enum*), 822
- soc\_periph\_i2s\_clk\_src\_t::I2S\_CLK\_SRC\_DEFAULT (*C++ enumerator*), 822
- soc\_periph\_i2s\_clk\_src\_t::I2S\_CLK\_SRC\_EXTERNAL (*C++ enumerator*), 823
- soc\_periph\_i2s\_clk\_src\_t::I2S\_CLK\_SRC\_PLL\_64M (*C++ enumerator*), 823
- soc\_periph\_i2s\_clk\_src\_t::I2S\_CLK\_SRC\_PLL\_96M (*C++ enumerator*), 823
- soc\_periph\_i2s\_clk\_src\_t::I2S\_CLK\_SRC\_XTAL (*C++ enumerator*), 823
- soc\_periph\_ledc\_clk\_src\_legacy\_t (*C++ enum*), 825
- soc\_periph\_ledc\_clk\_src\_legacy\_t::LEDC\_AUTO\_CLK (*C++ enumerator*), 825
- soc\_periph\_ledc\_clk\_src\_legacy\_t::LEDC\_USE\_PLL\_DI (*C++ enumerator*), 825
- soc\_periph\_ledc\_clk\_src\_legacy\_t::LEDC\_USE\_RC\_FAST (*C++ enumerator*), 825
- soc\_periph\_ledc\_clk\_src\_legacy\_t::LEDC\_USE\_RTC8M (*C++ enumerator*), 825
- soc\_periph\_ledc\_clk\_src\_legacy\_t::LEDC\_USE\_XTAL\_C (*C++ enumerator*), 825
- soc\_periph\_mcpwm\_capture\_clk\_src\_t (*C++ enum*), 822
- soc\_periph\_mcpwm\_capture\_clk\_src\_t::MCPWM\_CAPTURE (*C++ enumerator*), 822
- soc\_periph\_mcpwm\_capture\_clk\_src\_t::MCPWM\_CAPTURE\_DEFAULT (*C++ enumerator*), 822
- soc\_periph\_mcpwm\_capture\_clk\_src\_t::MCPWM\_CAPTURE\_PLL\_196M (*C++ enumerator*), 822
- soc\_periph\_mcpwm\_capture\_clk\_src\_t::MCPWM\_CAPTURE\_XTAL (*C++ enum*), 822
- soc\_periph\_mcpwm\_carrier\_clk\_src\_t (*C++ enum*), 822
- soc\_periph\_mcpwm\_carrier\_clk\_src\_t::MCPWM\_CARRIER (*C++ enumerator*), 822
- soc\_periph\_mcpwm\_carrier\_clk\_src\_t::MCPWM\_CARRIER\_DEFAULT (*C++ enumerator*), 822
- soc\_periph\_mcpwm\_carrier\_clk\_src\_t::MCPWM\_CARRIER\_PLL\_196M (*C++ enumerator*), 822
- soc\_periph\_mcpwm\_carrier\_clk\_src\_t::MCPWM\_CARRIER\_XTAL (*C++ enum*), 822
- soc\_periph\_mcpwm\_timer\_clk\_src\_t (*C++ enum*), 822

soc\_periph\_mcpwm\_timer\_clk\_src\_t::MCPWM\_TIMER\_CLK\_SRC\_PLL\_96M (C++ enum), 823  
 (C++ enumerator), 822 soc\_periph\_spi\_clk\_src\_t::SPI\_CLK\_SRC\_DEFAULT  
 soc\_periph\_mcpwm\_timer\_clk\_src\_t::MCPWM\_TIMER\_CLK\_SRC\_DEFAULT (C++ enumerator), 823  
 (C++ enumerator), 822 soc\_periph\_spi\_clk\_src\_t::SPI\_CLK\_SRC\_PLL\_F48M  
 soc\_periph\_mspi\_clk\_src\_t (C++ enum), 826 (C++ enumerator), 823  
 soc\_periph\_mspi\_clk\_src\_t::MSPI\_CLK\_SRC\_DEFAULT soc\_periph\_spi\_clk\_src\_t::SPI\_CLK\_SRC\_RC\_FAST  
 (C++ enumerator), 826 (C++ enumerator), 823  
 soc\_periph\_mspi\_clk\_src\_t::MSPI\_CLK\_SRC\_PLL\_F48M soc\_periph\_spi\_clk\_src\_t::SPI\_CLK\_SRC\_XTAL  
 (C++ enumerator), 826 (C++ enumerator), 823  
 soc\_periph\_mspi\_clk\_src\_t::MSPI\_CLK\_SRC\_PLL\_F64M soc\_periph\_systimer\_clk\_src\_t (C++  
 (C++ enumerator), 826 enum), 820  
 soc\_periph\_mspi\_clk\_src\_t::MSPI\_CLK\_SRC\_RC\_FAST soc\_periph\_systimer\_clk\_src\_t::SYSTIMER\_CLK\_SRC\_D  
 (C++ enumerator), 826 (C++ enumerator), 820  
 soc\_periph\_mspi\_clk\_src\_t::MSPI\_CLK\_SRC\_RC\_DEFAULT soc\_periph\_systimer\_clk\_src\_t::SYSTIMER\_CLK\_SRC\_R  
 (C++ enumerator), 826 (C++ enumerator), 820  
 soc\_periph\_mspi\_clk\_src\_t::MSPI\_CLK\_SRC\_XTAL soc\_periph\_systimer\_clk\_src\_t::SYSTIMER\_CLK\_SRC\_X  
 (C++ enumerator), 826 (C++ enumerator), 820  
 soc\_periph\_mwdt\_clk\_src\_t (C++ enum), 825 soc\_periph\_temperature\_sensor\_clk\_src\_t  
 soc\_periph\_mwdt\_clk\_src\_t::MWDT\_CLK\_SRC\_DEFAULT (C++ enum), 821  
 (C++ enumerator), 825 soc\_periph\_temperature\_sensor\_clk\_src\_t::TEMPERAT  
 soc\_periph\_mwdt\_clk\_src\_t::MWDT\_CLK\_SRC\_PLL\_F48M (C++ enumerator), 821  
 (C++ enumerator), 825 soc\_periph\_temperature\_sensor\_clk\_src\_t::TEMPERAT  
 soc\_periph\_mwdt\_clk\_src\_t::MWDT\_CLK\_SRC\_RC\_FAST (C++ enumerator), 821  
 (C++ enumerator), 825 soc\_periph\_temperature\_sensor\_clk\_src\_t::TEMPERAT  
 soc\_periph\_mwdt\_clk\_src\_t::MWDT\_CLK\_SRC\_XTAL (C++ enumerator), 821  
 (C++ enumerator), 825 soc\_periph\_tg\_clk\_src\_legacy\_t (C++  
 soc\_periph\_parlio\_clk\_src\_t (C++ enum), 825 enum), 820  
 soc\_periph\_parlio\_clk\_src\_t::PARLIO\_CLK\_SRC\_DEFAULT soc\_periph\_tg\_clk\_src\_legacy\_t::TIMER\_SRC\_CLK\_DEF  
 (C++ enumerator), 826 (C++ enumerator), 820  
 soc\_periph\_parlio\_clk\_src\_t::PARLIO\_CLK\_SRC\_EXCEPT soc\_periph\_tg\_clk\_src\_legacy\_t::TIMER\_SRC\_CLK\_PLL  
 (C++ enumerator), 826 (C++ enumerator), 820  
 soc\_periph\_parlio\_clk\_src\_t::PARLIO\_CLK\_SRC\_PICOP soc\_periph\_tg\_clk\_src\_legacy\_t::TIMER\_SRC\_CLK\_XTA  
 (C++ enumerator), 826 (C++ enumerator), 820  
 soc\_periph\_parlio\_clk\_src\_t::PARLIO\_CLK\_SRC\_PICOP\_FAST soc\_periph\_twai\_clk\_src\_t (C++ enum), 824  
 soc\_periph\_parlio\_clk\_src\_t::PARLIO\_CLK\_SRC\_PICOP\_FAST twai\_clk\_src\_t::TWAI\_CLK\_SRC\_DEFAULT  
 (C++ enumerator), 826 (C++ enumerator), 824  
 soc\_periph\_parlio\_clk\_src\_t::PARLIO\_CLK\_SRC\_XTAL twai\_clk\_src\_t::TWAI\_CLK\_SRC\_XTAL  
 (C++ enumerator), 826 (C++ enumerator), 824  
 soc\_periph\_rmt\_clk\_src\_legacy\_t (C++ soc\_periph\_uart\_clk\_src\_legacy\_t (C++  
 enum), 821 enum), 821  
 soc\_periph\_rmt\_clk\_src\_legacy\_t::RMT\_CLK\_SRC\_DEFAULT soc\_periph\_uart\_clk\_src\_legacy\_t::UART\_SCLK\_DEFAULT  
 (C++ enumerator), 821 (C++ enumerator), 822  
 soc\_periph\_rmt\_clk\_src\_legacy\_t::RMT\_CLK\_SRC\_XTAL soc\_periph\_uart\_clk\_src\_legacy\_t::UART\_SCLK\_PLL\_F  
 (C++ enumerator), 821 (C++ enumerator), 821  
 soc\_periph\_rmt\_clk\_src\_t (C++ enum), 821 soc\_periph\_uart\_clk\_src\_legacy\_t::UART\_SCLK\_RTC  
 soc\_periph\_rmt\_clk\_src\_t::RMT\_CLK\_SRC\_DEFAULT (C++ enumerator), 821  
 (C++ enumerator), 821 soc\_periph\_uart\_clk\_src\_legacy\_t::UART\_SCLK\_XTAL  
 soc\_periph\_rmt\_clk\_src\_t::RMT\_CLK\_SRC\_RC\_FAST (C++ enumerator), 821  
 (C++ enumerator), 821 SOC\_PHY\_DIG\_REGS\_MEM\_SIZE (C macro), 2053  
 soc\_periph\_rmt\_clk\_src\_t::RMT\_CLK\_SRC\_XTAL SOC\_PHY\_SUPPORTED (C macro), 2039  
 (C++ enumerator), 821 SOC\_PM\_CPU\_RETENTION\_BY\_SW (C macro), 2054  
 soc\_periph\_sdm\_clk\_src\_t (C++ enum), 823 SOC\_PM\_MODEM\_RETENTION\_BY\_REGDMA (C  
 soc\_periph\_sdm\_clk\_src\_t::SDM\_CLK\_SRC\_DEFAULT macro), 2054  
 (C++ enumerator), 824 SOC\_PM\_PAU\_LINK\_NUM (C macro), 2054  
 soc\_periph\_sdm\_clk\_src\_t::SDM\_CLK\_SRC\_PICOP SOC\_PM\_RETENTION\_SW\_TRIGGER\_REGDMA (C  
 (C++ enumerator), 824 macro), 2054  
 soc\_periph\_sdm\_clk\_src\_t::SDM\_CLK\_SRC\_XTAL SOC\_PM\_SUPPORT\_BT\_WAKEUP (C macro), 2054  
 (C++ enumerator), 823 SOC\_PM\_SUPPORT\_CPU\_PD (C macro), 2054

- SOC\_PM\_SUPPORT\_DEEPSLEEP\_CHECK\_STUB\_ONLY (C++ enumerator), 818  
(C macro), 2054
- SOC\_PM\_SUPPORT\_EXT1\_WAKEUP (C macro), 2054
- SOC\_PM\_SUPPORT\_EXT1\_WAKEUP\_MODE\_PER\_PINS (C macro), 2054
- SOC\_PM\_SUPPORT\_MODEM\_PD (C macro), 2054
- SOC\_PM\_SUPPORT\_RC32K\_PD (C macro), 2054
- SOC\_PM\_SUPPORT\_RC\_FAST\_PD (C macro), 2054
- SOC\_PM\_SUPPORT\_TOP\_PD (C macro), 2054
- SOC\_PM\_SUPPORT\_VDDSDIO\_PD (C macro), 2054
- SOC\_PM\_SUPPORT\_XTAL32K\_PD (C macro), 2054
- SOC\_PM\_SUPPORTED (C macro), 2041
- SOC\_PMU\_SUPPORTED (C macro), 2040
- SOC\_RCC\_IS\_INDEPENDENT (C macro), 2055
- SOC\_RMT\_CHANNELS\_PER\_GROUP (C macro), 2047
- SOC\_RMT\_CLKS (C macro), 815
- SOC\_RMT\_GROUPS (C macro), 2047
- SOC\_RMT\_MEM\_WORDS\_PER\_CHANNEL (C macro), 2047
- SOC\_RMT\_RX\_CANDIDATES\_PER\_GROUP (C macro), 2047
- SOC\_RMT\_SUPPORT\_RC\_FAST (C macro), 2048
- SOC\_RMT\_SUPPORT\_RX\_DEMODULATION (C macro), 2047
- SOC\_RMT\_SUPPORT\_RX\_PINGPONG (C macro), 2047
- SOC\_RMT\_SUPPORT\_TX\_ASYNC\_STOP (C macro), 2047
- SOC\_RMT\_SUPPORT\_TX\_CARRIER\_DATA\_ONLY (C macro), 2047
- SOC\_RMT\_SUPPORT\_TX\_LOOP\_AUTO\_STOP (C macro), 2047
- SOC\_RMT\_SUPPORT\_TX\_LOOP\_COUNT (C macro), 2047
- SOC\_RMT\_SUPPORT\_TX\_SYNCHRO (C macro), 2047
- SOC\_RMT\_SUPPORT\_XTAL (C macro), 2048
- SOC\_RMT\_SUPPORTED (C macro), 2039
- SOC\_RMT\_TX\_CANDIDATES\_PER\_GROUP (C macro), 2047
- SOC\_RNG\_CLOCK\_IS\_INDEPENDENT (C macro), 2055
- SOC\_RNG\_SUPPORTED (C macro), 2040
- soc\_root\_clk\_t (C++ enum), 816
- soc\_root\_clk\_t::SOC\_ROOT\_CLK\_EXT\_OSC\_STOP (C++ enumerator), 817
- soc\_root\_clk\_t::SOC\_ROOT\_CLK\_EXT\_XTAL (C++ enumerator), 817
- soc\_root\_clk\_t::SOC\_ROOT\_CLK\_EXT\_XTAL32K (C++ enumerator), 817
- soc\_root\_clk\_t::SOC\_ROOT\_CLK\_INT\_RC32K (C++ enumerator), 817
- soc\_root\_clk\_t::SOC\_ROOT\_CLK\_INT\_RC\_FAST (C++ enumerator), 816
- soc\_root\_clk\_t::SOC\_ROOT\_CLK\_INT\_RC\_SLOW (C++ enumerator), 816
- SOC\_RSA\_MAX\_BIT\_LEN (C macro), 2049
- soc\_rtc\_fast\_clk\_src\_t (C++ enum), 818
- soc\_rtc\_fast\_clk\_src\_t::SOC\_RTC\_FAST\_CLK\_SRC\_LP\_PD (C++ enumerator), 818
- soc\_rtc\_fast\_clk\_src\_t::SOC\_RTC\_FAST\_CLK\_SRC\_RC\_FAST (C++ enumerator), 818
- soc\_rtc\_fast\_clk\_src\_t::SOC\_RTC\_FAST\_CLK\_SRC\_XTAL (C++ enumerator), 818
- soc\_rtc\_fast\_clk\_src\_t::SOC\_RTC\_FAST\_CLK\_SRC\_XTAL32K (C++ enumerator), 818
- SOC\_RTC\_FAST\_MEM\_SUPPORTED (C macro), 2039
- SOC\_RTC\_MEM\_SUPPORTED (C macro), 2039
- soc\_rtc\_slow\_clk\_src\_t (C++ enum), 817
- soc\_rtc\_slow\_clk\_src\_t::SOC\_RTC\_SLOW\_CLK\_SRC\_INVA (C++ enumerator), 818
- soc\_rtc\_slow\_clk\_src\_t::SOC\_RTC\_SLOW\_CLK\_SRC\_OSC\_STOP (C++ enumerator), 818
- soc\_rtc\_slow\_clk\_src\_t::SOC\_RTC\_SLOW\_CLK\_SRC\_RC32K (C++ enumerator), 818
- soc\_rtc\_slow\_clk\_src\_t::SOC\_RTC\_SLOW\_CLK\_SRC\_RC\_FAST (C++ enumerator), 817
- soc\_rtc\_slow\_clk\_src\_t::SOC\_RTC\_SLOW\_CLK\_SRC\_XTAL (C++ enumerator), 817
- SOC\_RTCIO\_HOLD\_SUPPORTED (C macro), 2044
- SOC\_RTCIO\_PIN\_COUNT (C macro), 2044
- SOC\_RTCIO\_VALID\_RTCIO\_MASK (C macro), 2044
- SOC\_SDM\_CHANNELS\_PER\_GROUP (C macro), 2050
- SOC\_SDM\_CLK\_SUPPORT\_PLL\_F48M (C macro), 2050
- SOC\_SDM\_CLK\_SUPPORT\_XTAL (C macro), 2050
- SOC\_SDM\_CLKS (C macro), 816
- SOC\_SDM\_GROUPS (C macro), 2049
- SOC\_SDM\_SUPPORTED (C macro), 2039
- SOC\_SECURE\_BOOT\_SUPPORTED (C macro), 2040
- SOC\_SECURE\_BOOT\_V2\_ECC (C macro), 2052
- SOC\_SECURE\_BOOT\_V2\_RSA (C macro), 2052
- SOC\_SHA\_DMA\_MAX\_BUFFER\_SIZE (C macro), 2049
- SOC\_SHA\_GDMA (C macro), 2049
- SOC\_SHA\_SUPPORT\_DMA (C macro), 2049
- SOC\_SHA\_SUPPORT\_RESUME (C macro), 2049
- SOC\_SHA\_SUPPORT\_SHA1 (C macro), 2049
- SOC\_SHA\_SUPPORT\_SHA224 (C macro), 2049
- SOC\_SHA\_SUPPORT\_SHA256 (C macro), 2049
- SOC\_SHA\_SUPPORTED (C macro), 2040
- SOC\_SHARED\_IDCACHE\_SUPPORTED (C macro), 2042
- SOC\_SPI\_CLKS (C macro), 816
- SOC\_SPI\_FLASH\_SUPPORTED (C macro), 2040
- SOC\_SPI\_MAX\_CS\_NUM (C macro), 2050
- SOC\_SPI\_MAX\_PRE\_DIVIDER (C macro), 2050
- SOC\_SPI\_MAXIMUM\_BUFFER\_SIZE (C macro), 2050
- SOC\_SPI\_MEM\_SUPPORT\_AUTO\_RESUME (C macro), 2051
- SOC\_SPI\_MEM\_SUPPORT\_AUTO\_SUSPEND (C macro), 2051
- SOC\_SPI\_MEM\_SUPPORT\_AUTO\_WAIT\_IDLE (C macro), 2050

- SOC\_SPI\_MEM\_SUPPORT\_CHECK\_SUS (*C macro*), 2051
- SOC\_SPI\_MEM\_SUPPORT\_IDLE\_INTR (*C macro*), 2051
- SOC\_SPI\_MEM\_SUPPORT\_SW\_SUSPEND (*C macro*), 2051
- SOC\_SPI\_MEM\_SUPPORT\_WRAP (*C macro*), 2051
- SOC\_SPI\_PERIPH\_CS\_NUM (*C macro*), 2050
- SOC\_SPI\_PERIPH\_NUM (*C macro*), 2050
- SOC\_SPI\_PERIPH\_SUPPORT\_MULTILINE\_MODE (*C macro*), 2050
- SOC\_SPI\_SCT\_BUFFER\_NUM\_MAX (*C macro*), 2050
- SOC\_SPI\_SCT\_CONF\_BITLEN\_MAX (*C macro*), 2050
- SOC\_SPI\_SCT\_REG\_NUM (*C macro*), 2050
- SOC\_SPI\_SCT\_SUPPORTED (*C macro*), 2050
- SOC\_SPI\_SCT\_SUPPORTED\_PERIPH (*C macro*), 2050
- SOC\_SPI\_SLAVE\_SUPPORT\_SEG\_TRANS (*C macro*), 2050
- SOC\_SPI\_SUPPORT\_CD\_SIG (*C macro*), 2050
- SOC\_SPI\_SUPPORT\_CLK\_PLL\_F48M (*C macro*), 2050
- SOC\_SPI\_SUPPORT\_CLK\_RC\_FAST (*C macro*), 2050
- SOC\_SPI\_SUPPORT\_CLK\_XTAL (*C macro*), 2050
- SOC\_SPI\_SUPPORT\_CONTINUOUS\_TRANS (*C macro*), 2050
- SOC\_SPI\_SUPPORT\_DDRCLK (*C macro*), 2050
- SOC\_SPI\_SUPPORT\_SLAVE\_HD\_VER2 (*C macro*), 2050
- SOC\_SUPPORT\_COEXISTENCE (*C macro*), 2040
- SOC\_SUPPORT\_SECURE\_BOOT\_REVOKE\_KEY (*C macro*), 2053
- SOC\_SUPPORTS\_SECURE\_DL\_MODE (*C macro*), 2039
- SOC\_SYSTIMER\_ALARM\_MISS\_COMPENSATE (*C macro*), 2051
- SOC\_SYSTIMER\_ALARM\_NUM (*C macro*), 2051
- SOC\_SYSTIMER\_BIT\_WIDTH\_HI (*C macro*), 2051
- SOC\_SYSTIMER\_BIT\_WIDTH\_LO (*C macro*), 2051
- SOC\_SYSTIMER\_COUNTER\_NUM (*C macro*), 2051
- SOC\_SYSTIMER\_FIXED\_DIVIDER (*C macro*), 2051
- SOC\_SYSTIMER\_INT\_LEVEL (*C macro*), 2051
- SOC\_SYSTIMER\_SUPPORT\_ETM (*C macro*), 2051
- SOC\_SYSTIMER\_SUPPORT\_RC\_FAST (*C macro*), 2051
- SOC\_SYSTIMER\_SUPPORTED (*C macro*), 2039
- SOC\_TEMP\_SENSOR\_CLKS (*C macro*), 815
- SOC\_TEMP\_SENSOR\_SUPPORTED (*C macro*), 2039
- SOC\_TEMPERATURE\_SENSOR\_INTR\_SUPPORT (*C macro*), 2055
- SOC\_TEMPERATURE\_SENSOR\_SUPPORT\_ETM (*C macro*), 2055
- SOC\_TEMPERATURE\_SENSOR\_SUPPORT\_FAST\_RC (*C macro*), 2055
- SOC\_TEMPERATURE\_SENSOR\_SUPPORT\_XTAL (*C macro*), 2055
- SOC\_TIMER\_GROUP\_COUNTER\_BIT\_WIDTH (*C macro*), 2052
- SOC\_TIMER\_GROUP\_SUPPORT\_RC\_FAST (*C macro*), 2052
- SOC\_TIMER\_GROUP\_SUPPORT\_XTAL (*C macro*), 2052
- SOC\_TIMER\_GROUP\_TIMERS\_PER\_GROUP (*C macro*), 2051
- SOC\_TIMER\_GROUP\_TOTAL\_TIMERS (*C macro*), 2052
- SOC\_TIMER\_GROUPS (*C macro*), 2051
- SOC\_TIMER\_SUPPORT\_ETM (*C macro*), 2052
- SOC\_TIMER\_SUPPORT\_SLEEP\_RETENTION (*C macro*), 2052
- SOC\_TWAI\_BRP\_MAX (*C macro*), 2052
- SOC\_TWAI\_BRP\_MIN (*C macro*), 2052
- SOC\_TWAI\_CLK\_SUPPORT\_XTAL (*C macro*), 2052
- SOC\_TWAI\_CLKS (*C macro*), 816
- SOC\_TWAI\_CONTROLLER\_NUM (*C macro*), 2052
- SOC\_TWAI\_SUPPORTED (*C macro*), 2039
- SOC\_TWAI\_SUPPORTS\_RX\_STATUS (*C macro*), 2052
- SOC\_UART\_BITRATE\_MAX (*C macro*), 2053
- SOC\_UART\_CLKS (*C macro*), 815
- SOC\_UART\_FIFO\_LEN (*C macro*), 2053
- SOC\_UART\_HP\_NUM (*C macro*), 2053
- SOC\_UART\_NUM (*C macro*), 2053
- SOC\_UART\_SUPPORT\_FSM\_TX\_WAIT\_SEND (*C macro*), 2053
- SOC\_UART\_SUPPORT\_RTC\_CLK (*C macro*), 2053
- SOC\_UART\_SUPPORT\_SLEEP\_RETENTION (*C macro*), 2053
- SOC\_UART\_SUPPORT\_WAKEUP\_INT (*C macro*), 2053
- SOC\_UART\_SUPPORT\_XTAL\_CLK (*C macro*), 2053
- SOC\_UART\_SUPPORTED (*C macro*), 2038
- SOC\_USB\_SERIAL\_JTAG\_SUPPORTED (*C macro*), 2039
- SOC\_WDT\_SUPPORTED (*C macro*), 2040
- soc\_xtal\_freq\_t (*C++ enum*), 819
- soc\_xtal\_freq\_t::SOC\_XTAL\_FREQ\_32M (*C++ enumerator*), 819
- SOC\_XTAL\_SUPPORT\_32M (*C macro*), 2041
- spi\_bus\_add\_device (*C++ function*), 1160
- spi\_bus\_add\_flash\_device (*C++ function*), 1126
- spi\_bus\_config\_t (*C++ struct*), 1157
- spi\_bus\_config\_t::data0\_io\_num (*C++ member*), 1157
- spi\_bus\_config\_t::data1\_io\_num (*C++ member*), 1157
- spi\_bus\_config\_t::data2\_io\_num (*C++ member*), 1157
- spi\_bus\_config\_t::data3\_io\_num (*C++ member*), 1157
- spi\_bus\_config\_t::data4\_io\_num (*C++ member*), 1157
- spi\_bus\_config\_t::data5\_io\_num (*C++ member*), 1157

- member*), 1157
- `spi_bus_config_t::data6_io_num` (C++ *member*), 1157
- `spi_bus_config_t::data7_io_num` (C++ *member*), 1158
- `spi_bus_config_t::flags` (C++ *member*), 1158
- `spi_bus_config_t::intr_flags` (C++ *member*), 1158
- `spi_bus_config_t::isr_cpu_id` (C++ *member*), 1158
- `spi_bus_config_t::max_transfer_sz` (C++ *member*), 1158
- `spi_bus_config_t::miso_io_num` (C++ *member*), 1157
- `spi_bus_config_t::mosi_io_num` (C++ *member*), 1157
- `spi_bus_config_t::quadhd_io_num` (C++ *member*), 1157
- `spi_bus_config_t::quadwp_io_num` (C++ *member*), 1157
- `spi_bus_config_t::sclk_io_num` (C++ *member*), 1157
- `spi_bus_free` (C++ *function*), 1156
- `spi_bus_get_max_transaction_len` (C++ *function*), 1164
- `spi_bus_initialize` (C++ *function*), 1156
- `spi_bus_remove_device` (C++ *function*), 1160
- `spi_bus_remove_flash_device` (C++ *function*), 1126
- `spi_clock_source_t` (C++ *type*), 1154
- `spi_command_t` (C++ *enum*), 1155
- `spi_command_t::SPI_CMD_HD_EN_QPI` (C++ *enumerator*), 1155
- `spi_command_t::SPI_CMD_HD_INT0` (C++ *enumerator*), 1155
- `spi_command_t::SPI_CMD_HD_INT1` (C++ *enumerator*), 1155
- `spi_command_t::SPI_CMD_HD_INT2` (C++ *enumerator*), 1155
- `spi_command_t::SPI_CMD_HD_RDBUF` (C++ *enumerator*), 1155
- `spi_command_t::SPI_CMD_HD_RDDMA` (C++ *enumerator*), 1155
- `spi_command_t::SPI_CMD_HD_SEG_END` (C++ *enumerator*), 1155
- `spi_command_t::SPI_CMD_HD_WR_END` (C++ *enumerator*), 1155
- `spi_command_t::SPI_CMD_HD_WRBUF` (C++ *enumerator*), 1155
- `spi_command_t::SPI_CMD_HD_WRDMA` (C++ *enumerator*), 1155
- `spi_common_dma_t` (C++ *enum*), 1159
- `spi_common_dma_t::SPI_DMA_CH_AUTO` (C++ *enumerator*), 1159
- `spi_common_dma_t::SPI_DMA_DISABLED` (C++ *enumerator*), 1159
- `SPI_DEVICE_3WIRE` (C *macro*), 1168
- `spi_device_acquire_bus` (C++ *function*), 1163
- `SPI_DEVICE_BIT_LSBFIRST` (C *macro*), 1168
- `SPI_DEVICE_CLK_AS_CS` (C *macro*), 1168
- `SPI_DEVICE_DDRCLK` (C *macro*), 1168
- `spi_device_get_actual_freq` (C++ *function*), 1163
- `spi_device_get_trans_result` (C++ *function*), 1161
- `SPI_DEVICE_HALFDUPLEX` (C *macro*), 1168
- `spi_device_handle_t` (C++ *type*), 1169
- `spi_device_interface_config_t` (C++ *struct*), 1164
- `spi_device_interface_config_t::address_bits` (C++ *member*), 1164
- `spi_device_interface_config_t::clock_source` (C++ *member*), 1164
- `spi_device_interface_config_t::clock_speed_hz` (C++ *member*), 1165
- `spi_device_interface_config_t::command_bits` (C++ *member*), 1164
- `spi_device_interface_config_t::cs_ena_posttrans` (C++ *member*), 1165
- `spi_device_interface_config_t::cs_ena_pretrans` (C++ *member*), 1165
- `spi_device_interface_config_t::dummy_bits` (C++ *member*), 1164
- `spi_device_interface_config_t::duty_cycle_pos` (C++ *member*), 1165
- `spi_device_interface_config_t::flags` (C++ *member*), 1165
- `spi_device_interface_config_t::input_delay_ns` (C++ *member*), 1165
- `spi_device_interface_config_t::mode` (C++ *member*), 1164
- `spi_device_interface_config_t::post_cb` (C++ *member*), 1165
- `spi_device_interface_config_t::pre_cb` (C++ *member*), 1165
- `spi_device_interface_config_t::queue_size` (C++ *member*), 1165
- `spi_device_interface_config_t::spics_io_num` (C++ *member*), 1165
- `SPI_DEVICE_NO_DUMMY` (C *macro*), 1168
- `SPI_DEVICE_NO_RETURN_RESULT` (C *macro*), 1168
- `spi_device_polling_end` (C++ *function*), 1162
- `spi_device_polling_start` (C++ *function*), 1162
- `spi_device_polling_transmit` (C++ *function*), 1162
- `SPI_DEVICE_POSITIVE_CS` (C *macro*), 1168
- `spi_device_queue_trans` (C++ *function*), 1161
- `spi_device_release_bus` (C++ *function*), 1163
- `SPI_DEVICE_RXBIT_LSBFIRST` (C *macro*), 1167
- `spi_device_transmit` (C++ *function*), 1161
- `SPI_DEVICE_TXBIT_LSBFIRST` (C *macro*), 1167
- `spi_dma_chan_t` (C++ *type*), 1159
- `spi_event_t` (C++ *enum*), 1154



- spi\_event\_t::SPI\_EV\_BUF\_RX (C++ *enumerator*), 1154  
 spi\_event\_t::SPI\_EV\_BUF\_TX (C++ *enumerator*), 1154  
 spi\_event\_t::SPI\_EV\_CMD9 (C++ *enumerator*), 1155  
 spi\_event\_t::SPI\_EV\_CMDA (C++ *enumerator*), 1155  
 spi\_event\_t::SPI\_EV\_RECV (C++ *enumerator*), 1155  
 spi\_event\_t::SPI\_EV\_RECV\_DMA\_READY (C++ *enumerator*), 1155  
 spi\_event\_t::SPI\_EV\_SEND (C++ *enumerator*), 1154  
 spi\_event\_t::SPI\_EV\_SEND\_DMA\_READY (C++ *enumerator*), 1154  
 spi\_event\_t::SPI\_EV\_TRANS (C++ *enumerator*), 1155  
 spi\_flash\_cache2phys (C++ *function*), 1136  
 SPI\_FLASH\_CACHE2PHYS\_FAIL (C *macro*), 1136  
 spi\_flash\_chip\_t (C++ *type*), 1134  
 SPI\_FLASH\_CONFIG\_CONF\_BITS (C *macro*), 1141  
 spi\_flash\_counter\_t (C++ *type*), 1145  
 spi\_flash\_counters\_t (C++ *type*), 1145  
 spi\_flash\_dump\_counters (C++ *function*), 1144  
 spi\_flash\_encryption\_t (C++ *struct*), 1138  
 spi\_flash\_encryption\_t::flash\_encryption\_check (C++ *member*), 1139  
 spi\_flash\_encryption\_t::flash\_encryption\_prepare (C++ *member*), 1138  
 spi\_flash\_encryption\_t::flash\_encryption\_prepare\_async (C++ *member*), 1139  
 spi\_flash\_encryption\_t::flash\_encryption\_prepare\_async\_disable (C++ *member*), 1138  
 spi\_flash\_encryption\_t::flash\_encryption\_prepare\_async\_enable (C++ *member*), 1139  
 spi\_flash\_encryption\_t::flash\_encryption\_prepare\_async\_status (C++ *member*), 1138  
 spi\_flash\_get\_counters (C++ *function*), 1144  
 spi\_flash\_host\_driver\_s (C++ *struct*), 1139  
 spi\_flash\_host\_driver\_s::check\_suspend (C++ *member*), 1141  
 spi\_flash\_host\_driver\_s::common\_command (C++ *member*), 1139  
 spi\_flash\_host\_driver\_s::configure\_host (C++ *member*), 1140  
 spi\_flash\_host\_driver\_s::dev\_config (C++ *member*), 1139  
 spi\_flash\_host\_driver\_s::erase\_block (C++ *member*), 1140  
 spi\_flash\_host\_driver\_s::erase\_chip (C++ *member*), 1139  
 spi\_flash\_host\_driver\_s::erase\_sector (C++ *member*), 1139  
 spi\_flash\_host\_driver\_s::flush\_cache (C++ *member*), 1141  
 spi\_flash\_host\_driver\_s::host\_status (C++ *member*), 1140  
 spi\_flash\_host\_driver\_s::poll\_cmd\_done (C++ *member*), 1141  
 spi\_flash\_host\_driver\_s::program\_page (C++ *member*), 1140  
 spi\_flash\_host\_driver\_s::read (C++ *member*), 1140  
 spi\_flash\_host\_driver\_s::read\_data\_slicer (C++ *member*), 1140  
 spi\_flash\_host\_driver\_s::read\_id (C++ *member*), 1139  
 spi\_flash\_host\_driver\_s::read\_status (C++ *member*), 1140  
 spi\_flash\_host\_driver\_s::resume (C++ *member*), 1141  
 spi\_flash\_host\_driver\_s::set\_write\_protect (C++ *member*), 1140  
 spi\_flash\_host\_driver\_s::supports\_direct\_read (C++ *member*), 1140  
 spi\_flash\_host\_driver\_s::supports\_direct\_write (C++ *member*), 1140  
 spi\_flash\_host\_driver\_s::sus\_setup (C++ *member*), 1141  
 spi\_flash\_host\_driver\_s::suspend (C++ *member*), 1141  
 spi\_flash\_host\_driver\_s::write\_data\_slicer (C++ *member*), 1140  
 spi\_flash\_host\_driver\_t (C++ *type*), 1142  
 spi\_flash\_inst\_t (C++ *struct*), 1139  
 spi\_flash\_inst\_t::driver (C++ *member*), 1139  
 spi\_flash\_mmap (C++ *function*), 1135  
 spi\_flash\_mmap\_dump (C++ *function*), 1135  
 spi\_flash\_mmap\_get\_free\_pages (C++ *function*), 1135  
 spi\_flash\_mmap\_handle\_t (C++ *type*), 1137  
 spi\_flash\_mmap\_memory\_t (C++ *enum*), 1137  
 spi\_flash\_mmap\_memory\_t::SPI\_FLASH\_MMMap\_DATA (C++ *enumerator*), 1137  
 spi\_flash\_mmap\_memory\_t::SPI\_FLASH\_MMMap\_INST (C++ *enumerator*), 1137  
 spi\_flash\_mmap\_pages (C++ *function*), 1135  
 SPI\_FLASH\_MMU\_PAGE\_SIZE (C *macro*), 1136  
 spi\_flash\_munmap (C++ *function*), 1135  
 SPI\_FLASH\_OPI\_FLAG (C *macro*), 1141  
 SPI\_FLASH\_OS\_IS\_ERASING\_STATUS\_FLAG (C *macro*), 1134  
 spi\_flash\_phys2cache (C++ *function*), 1136  
 SPI\_FLASH\_READ\_MODE\_MIN (C *macro*), 1141  
 spi\_flash\_reset\_counters (C++ *function*), 1144  
 SPI\_FLASH\_SEC\_SIZE (C *macro*), 1136  
 spi\_flash\_sus\_cmd\_conf (C++ *struct*), 1138  
 spi\_flash\_sus\_cmd\_conf::cmd\_rdsr (C++ *member*), 1138  
 spi\_flash\_sus\_cmd\_conf::res\_cmd (C++ *member*), 1138  
 spi\_flash\_sus\_cmd\_conf::reserved (C++

- member*), 1138
- `spi_flash_sus_cmd_conf::sus_cmd` (C++ *member*), 1138
- `spi_flash_sus_cmd_conf::sus_mask` (C++ *member*), 1138
- `SPI_FLASH_TRANS_FLAG_BYTE_SWAP` (C *macro*), 1141
- `SPI_FLASH_TRANS_FLAG_CMD16` (C *macro*), 1141
- `SPI_FLASH_TRANS_FLAG_IGNORE_BASEIO` (C *macro*), 1141
- `SPI_FLASH_TRANS_FLAG_PE_CMD` (C *macro*), 1141
- `spi_flash_trans_t` (C++ *struct*), 1137
- `spi_flash_trans_t::address` (C++ *member*), 1137
- `spi_flash_trans_t::address_bitlen` (C++ *member*), 1137
- `spi_flash_trans_t::command` (C++ *member*), 1138
- `spi_flash_trans_t::dummy_bitlen` (C++ *member*), 1138
- `spi_flash_trans_t::flags` (C++ *member*), 1138
- `spi_flash_trans_t::io_mode` (C++ *member*), 1138
- `spi_flash_trans_t::miso_data` (C++ *member*), 1138
- `spi_flash_trans_t::miso_len` (C++ *member*), 1137
- `spi_flash_trans_t::mosi_data` (C++ *member*), 1137
- `spi_flash_trans_t::mosi_len` (C++ *member*), 1137
- `spi_flash_trans_t::reserved` (C++ *member*), 1137
- `SPI_FLASH_YIELD_REQ_SUSPEND` (C *macro*), 1134
- `SPI_FLASH_YIELD_REQ_YIELD` (C *macro*), 1134
- `SPI_FLASH_YIELD_STA_RESUME` (C *macro*), 1134
- `spi_get_actual_clock` (C++ *function*), 1163
- `spi_get_freq_limit` (C++ *function*), 1164
- `spi_get_timing` (C++ *function*), 1163
- `spi_host_device_t` (C++ *enum*), 1154
- `spi_host_device_t::SPI1_HOST` (C++ *enumerator*), 1154
- `spi_host_device_t::SPI2_HOST` (C++ *enumerator*), 1154
- `spi_host_device_t::SPI_HOST_MAX` (C++ *enumerator*), 1154
- `spi_line_mode_t` (C++ *struct*), 1154
- `spi_line_mode_t::addr_lines` (C++ *member*), 1154
- `spi_line_mode_t::cmd_lines` (C++ *member*), 1154
- `spi_line_mode_t::data_lines` (C++ *member*), 1154
- `SPI_MASTER_FREQ_10M` (C *macro*), 1167
- `SPI_MASTER_FREQ_11M` (C *macro*), 1167
- `SPI_MASTER_FREQ_13M` (C *macro*), 1167
- `SPI_MASTER_FREQ_16M` (C *macro*), 1167
- `SPI_MASTER_FREQ_20M` (C *macro*), 1167
- `SPI_MASTER_FREQ_26M` (C *macro*), 1167
- `SPI_MASTER_FREQ_40M` (C *macro*), 1167
- `SPI_MASTER_FREQ_80M` (C *macro*), 1167
- `SPI_MASTER_FREQ_8M` (C *macro*), 1167
- `SPI_MASTER_FREQ_9M` (C *macro*), 1167
- `SPI_MAX_DMA_LEN` (C *macro*), 1158
- `SPI_SLAVE_BIT_LSBFIRST` (C *macro*), 1175
- `spi_slave_chan_t` (C++ *enum*), 1183
- `spi_slave_chan_t::SPI_SLAVE_CHAN_RX` (C++ *enumerator*), 1184
- `spi_slave_chan_t::SPI_SLAVE_CHAN_TX` (C++ *enumerator*), 1183
- `spi_slave_free` (C++ *function*), 1173
- `spi_slave_get_trans_result` (C++ *function*), 1173
- `SPI_SLAVE_HD_APPEND_MODE` (C *macro*), 1183
- `spi_slave_hd_append_trans` (C++ *function*), 1180
- `SPI_SLAVE_HD_BIT_LSBFIRST` (C *macro*), 1183
- `spi_slave_hd_callback_config_t` (C++ *struct*), 1181
- `spi_slave_hd_callback_config_t::arg` (C++ *member*), 1182
- `spi_slave_hd_callback_config_t::cb_buffer_rx` (C++ *member*), 1182
- `spi_slave_hd_callback_config_t::cb_buffer_tx` (C++ *member*), 1182
- `spi_slave_hd_callback_config_t::cb_cmd9` (C++ *member*), 1182
- `spi_slave_hd_callback_config_t::cb_cmdA` (C++ *member*), 1182
- `spi_slave_hd_callback_config_t::cb_recv` (C++ *member*), 1182
- `spi_slave_hd_callback_config_t::cb_recv_dma_ready` (C++ *member*), 1182
- `spi_slave_hd_callback_config_t::cb_send_dma_ready` (C++ *member*), 1182
- `spi_slave_hd_callback_config_t::cb_sent` (C++ *member*), 1182
- `spi_slave_hd_data_t` (C++ *struct*), 1181
- `spi_slave_hd_data_t::arg` (C++ *member*), 1181
- `spi_slave_hd_data_t::data` (C++ *member*), 1181
- `spi_slave_hd_data_t::flags` (C++ *member*), 1181
- `spi_slave_hd_data_t::len` (C++ *member*), 1181
- `spi_slave_hd_data_t::trans_len` (C++ *member*), 1181
- `spi_slave_hd_deinit` (C++ *function*), 1179
- `spi_slave_hd_event_t` (C++ *struct*), 1181
- `spi_slave_hd_event_t::event` (C++ *member*), 1181
- `spi_slave_hd_event_t::trans` (C++ *member*), 1181

- ber*), 1181
- `spi_slave_hd_get_append_trans_res` (C++ function), 1180
- `spi_slave_hd_get_trans_res` (C++ function), 1179
- `spi_slave_hd_init` (C++ function), 1179
- `spi_slave_hd_queue_trans` (C++ function), 1179
- `spi_slave_hd_read_buffer` (C++ function), 1180
- `SPI_SLAVE_HD_RXBIT_LSBFIRST` (C macro), 1183
- `spi_slave_hd_slot_config_t` (C++ struct), 1182
- `spi_slave_hd_slot_config_t::address_bits` (C++ member), 1183
- `spi_slave_hd_slot_config_t::cb_config` (C++ member), 1183
- `spi_slave_hd_slot_config_t::command_bits` (C++ member), 1182
- `spi_slave_hd_slot_config_t::dma_chan` (C++ member), 1183
- `spi_slave_hd_slot_config_t::dummy_bits` (C++ member), 1183
- `spi_slave_hd_slot_config_t::flags` (C++ member), 1182
- `spi_slave_hd_slot_config_t::mode` (C++ member), 1182
- `spi_slave_hd_slot_config_t::queue_size` (C++ member), 1183
- `spi_slave_hd_slot_config_t::spics_io_num` (C++ member), 1182
- `SPI_SLAVE_HD_TRANS_DMA_BUFFER_ALIGN_AUTO` (C macro), 1183
- `SPI_SLAVE_HD_TXBIT_LSBFIRST` (C macro), 1183
- `spi_slave_hd_write_buffer` (C++ function), 1180
- `spi_slave_initialize` (C++ function), 1172
- `spi_slave_interface_config_t` (C++ struct), 1174
- `spi_slave_interface_config_t::flags` (C++ member), 1174
- `spi_slave_interface_config_t::mode` (C++ member), 1174
- `spi_slave_interface_config_t::post_setup_cb` (C++ member), 1175
- `spi_slave_interface_config_t::post_trans_cb` (C++ member), 1175
- `spi_slave_interface_config_t::queue_size` (C++ member), 1174
- `spi_slave_interface_config_t::spics_io_num` (C++ member), 1174
- `SPI_SLAVE_NO_RETURN_RESULT` (C macro), 1175
- `spi_slave_queue_trans` (C++ function), 1173
- `SPI_SLAVE_RXBIT_LSBFIRST` (C macro), 1175
- `SPI_SLAVE_TRANS_DMA_BUFFER_ALIGN_AUTO` (C macro), 1176
- `spi_slave_transaction_t` (C++ struct), 1175
- `spi_slave_transaction_t::flags` (C++ member), 1175
- `spi_slave_transaction_t::length` (C++ member), 1175
- `spi_slave_transaction_t::rx_buffer` (C++ member), 1175
- `spi_slave_transaction_t::trans_len` (C++ member), 1175
- `spi_slave_transaction_t::tx_buffer` (C++ member), 1175
- `spi_slave_transaction_t::user` (C++ member), 1175
- `spi_slave_transmit` (C++ function), 1174
- `SPI_SLAVE_TXBIT_LSBFIRST` (C macro), 1175
- `SPI_SWAP_DATA_RX` (C macro), 1158
- `SPI_SWAP_DATA_TX` (C macro), 1158
- `SPI_TRANS_CS_KEEP_ACTIVE` (C macro), 1169
- `SPI_TRANS_DMA_BUFFER_ALIGN_MANUAL` (C macro), 1169
- `SPI_TRANS_MODE_DIO` (C macro), 1168
- `SPI_TRANS_MODE_DIOQIO_ADDR` (C macro), 1168
- `SPI_TRANS_MODE_OCT` (C macro), 1169
- `SPI_TRANS_MODE_QIO` (C macro), 1168
- `SPI_TRANS_MULTILINE_ADDR` (C macro), 1169
- `SPI_TRANS_MULTILINE_CMD` (C macro), 1169
- `SPI_TRANS_USE_RXDATA` (C macro), 1168
- `SPI_TRANS_USE_TXDATA` (C macro), 1168
- `SPI_TRANS_VARIABLE_ADDR` (C macro), 1169
- `SPI_TRANS_VARIABLE_CMD` (C macro), 1168
- `SPI_TRANS_VARIABLE_DUMMY` (C macro), 1169
- `spi_transaction_ext_t` (C++ struct), 1166
- `spi_transaction_ext_t::address_bits` (C++ member), 1167
- `spi_transaction_ext_t::base` (C++ member), 1166
- `spi_transaction_ext_t::command_bits` (C++ member), 1167
- `spi_transaction_ext_t::dummy_bits` (C++ member), 1167
- `spi_transaction_t` (C++ struct), 1165
- `spi_transaction_t::addr` (C++ member), 1166
- `spi_transaction_t::cmd` (C++ member), 1166
- `spi_transaction_t::flags` (C++ member), 1166
- `spi_transaction_t::length` (C++ member), 1166
- `spi_transaction_t::rx_buffer` (C++ member), 1166
- `spi_transaction_t::rx_data` (C++ member), 1166
- `spi_transaction_t::rxlength` (C++ member), 1166
- `spi_transaction_t::tx_buffer` (C++ member), 1166
- `spi_transaction_t::tx_data` (C++ member), 1166



- spi\_transaction\_t::user (C++ member), 1166
- SPICOMMON\_BUSFLAG\_DUAL (C macro), 1159
- SPICOMMON\_BUSFLAG\_GPIO\_PINS (C macro), 1159
- SPICOMMON\_BUSFLAG\_IO4\_IO7 (C macro), 1159
- SPICOMMON\_BUSFLAG\_IOMUX\_PINS (C macro), 1159
- SPICOMMON\_BUSFLAG\_MASTER (C macro), 1158
- SPICOMMON\_BUSFLAG\_MISO (C macro), 1159
- SPICOMMON\_BUSFLAG\_MOSI (C macro), 1159
- SPICOMMON\_BUSFLAG\_NATIVE\_PINS (C macro), 1159
- SPICOMMON\_BUSFLAG\_OCTAL (C macro), 1159
- SPICOMMON\_BUSFLAG\_QUAD (C macro), 1159
- SPICOMMON\_BUSFLAG\_SCLK (C macro), 1159
- SPICOMMON\_BUSFLAG\_SLAVE (C macro), 1158
- SPICOMMON\_BUSFLAG\_WPHD (C macro), 1159
- StaticRingbuffer\_t (C++ type), 1916
- StreamBufferCallbackFunction\_t (C++ type), 1889
- StreamBufferHandle\_t (C++ type), 1889
- ## T
- task\_wdt\_msg\_handler (C++ type), 2072
- taskDISABLE\_INTERRUPTS (C macro), 1813
- taskENABLE\_INTERRUPTS (C macro), 1813
- taskENTER\_CRITICAL (C macro), 1813
- taskENTER\_CRITICAL\_FROM\_ISR (C macro), 1813
- taskENTER\_CRITICAL\_ISR (C macro), 1813
- taskEXIT\_CRITICAL (C macro), 1813
- taskEXIT\_CRITICAL\_FROM\_ISR (C macro), 1813
- taskEXIT\_CRITICAL\_ISR (C macro), 1813
- TaskHandle\_t (C++ type), 1818
- TaskHookFunction\_t (C++ type), 1819
- taskSCHEDULER\_NOT\_STARTED (C macro), 1813
- taskSCHEDULER\_RUNNING (C macro), 1813
- taskSCHEDULER\_SUSPENDED (C macro), 1813
- TaskStatus\_t (C++ type), 1819
- taskVALID\_CORE\_ID (C macro), 1813
- taskYIELD (C macro), 1813
- temperature\_sensor\_abs\_threshold\_config\_t (C++ struct), 1189
- temperature\_sensor\_abs\_threshold\_config\_t::high\_threshold (C++ member), 1190
- temperature\_sensor\_abs\_threshold\_config\_t::low\_threshold (C++ member), 1190
- temperature\_sensor\_clk\_src\_t (C++ type), 1191
- TEMPERATURE\_SENSOR\_CONFIG\_DEFAULT (C macro), 1190
- temperature\_sensor\_config\_t (C++ struct), 1189
- temperature\_sensor\_config\_t::clk\_src (C++ member), 1189
- temperature\_sensor\_config\_t::range\_max (C++ member), 1189
- temperature\_sensor\_config\_t::range\_min (C++ member), 1189
- temperature\_sensor\_delta\_threshold\_config\_t (C++ struct), 1190
- temperature\_sensor\_delta\_threshold\_config\_t::decr (C++ member), 1190
- temperature\_sensor\_delta\_threshold\_config\_t::incr (C++ member), 1190
- temperature\_sensor\_disable (C++ function), 1187
- temperature\_sensor\_enable (C++ function), 1187
- temperature\_sensor\_etm\_event\_config\_t (C++ struct), 1192
- temperature\_sensor\_etm\_event\_config\_t::event\_type (C++ member), 1192
- temperature\_sensor\_etm\_event\_type\_t (C++ enum), 1191
- temperature\_sensor\_etm\_event\_type\_t::TEMPERATURE\_ (C++ enumerator), 1191
- temperature\_sensor\_etm\_event\_type\_t::TEMPERATURE\_ (C++ enumerator), 1191
- temperature\_sensor\_etm\_task\_config\_t (C++ struct), 1192
- temperature\_sensor\_etm\_task\_config\_t::task\_type (C++ member), 1193
- temperature\_sensor\_etm\_task\_type\_t (C++ enum), 1191
- temperature\_sensor\_etm\_task\_type\_t::TEMPERATURE\_ (C++ enumerator), 1191
- temperature\_sensor\_etm\_task\_type\_t::TEMPERATURE\_ (C++ enumerator), 1191
- temperature\_sensor\_etm\_task\_type\_t::TEMPERATURE\_ (C++ enumerator), 1191
- temperature\_sensor\_event\_callbacks\_t (C++ struct), 1189
- temperature\_sensor\_event\_callbacks\_t::on\_threshold (C++ member), 1189
- temperature\_sensor\_get\_celsius (C++ function), 1187
- temperature\_sensor\_handle\_t (C++ type), 1190
- temperature\_sensor\_install (C++ function), 1187
- temperature\_sensor\_new\_etm\_event (C++ function), 1192
- temperature\_sensor\_new\_etm\_task (C++ function), 1192
- temperature\_sensor\_register\_callbacks (C++ function), 1188
- temperature\_sensor\_set\_absolute\_threshold (C++ function), 1188
- temperature\_sensor\_set\_delta\_threshold (C++ function), 1188
- temperature\_sensor\_threshold\_event\_data\_t (C++ struct), 1189
- temperature\_sensor\_threshold\_event\_data\_t::celsius (C++ member), 1189

- temperature\_sensor\_threshold\_event\_data\_t::int1205 condition  
(C++ member), 1189
- temperature\_sensor\_uninstall (C++ function), 1187
- temperature\_thres\_cb\_t (C++ type), 1190
- temperature\_val\_intr\_condition\_t (C++ enum), 1190
- temperature\_val\_intr\_condition\_t::TEMPERATURE\_EQUAL\_OR\_HIGHER\_THAN\_HIGH\_THRESHOLD (C++ enumerator), 1191
- temperature\_val\_intr\_condition\_t::TEMPERATURE\_EQUAL\_OR\_HIGHER\_THAN\_LOW\_THRESHOLD (C++ enumerator), 1191
- TimerCallbackFunction\_t (C++ type), 1871
- TimerHandle\_t (C++ type), 1871
- tls\_keep\_alive\_cfg (C++ struct), 63
- tls\_keep\_alive\_cfg::keep\_alive\_count (C++ member), 63
- tls\_keep\_alive\_cfg::keep\_alive\_enable (C++ member), 63
- tls\_keep\_alive\_cfg::keep\_alive\_idle (C++ member), 63
- tls\_keep\_alive\_cfg::keep\_alive\_interval (C++ member), 63
- tls\_keep\_alive\_cfg\_t (C++ type), 67
- TlsDeleteCallbackFunction\_t (C++ type), 1925
- topic\_t (C++ struct), 49
- topic\_t::filter (C++ member), 49
- topic\_t::qos (C++ member), 49
- transaction\_cb\_t (C++ type), 1169
- tskIDLE\_PRIORITY (C macro), 1813
- tskNO\_AFFINITY (C macro), 1813
- twai\_clear\_receive\_queue (C++ function), 1213
- twai\_clear\_receive\_queue\_v2 (C++ function), 1213
- twai\_clear\_transmit\_queue (C++ function), 1212
- twai\_clear\_transmit\_queue\_v2 (C++ function), 1212
- twai\_clock\_source\_t (C++ type), 1206
- twai\_driver\_install (C++ function), 1206
- twai\_driver\_install\_v2 (C++ function), 1207
- twai\_driver\_uninstall (C++ function), 1207
- twai\_driver\_uninstall\_v2 (C++ function), 1207
- TWAI\_ERR\_PASS\_THRESH (C macro), 1206
- TWAI\_EXTD\_ID\_MASK (C macro), 1205
- twai\_filter\_config\_t (C++ struct), 1205
- twai\_filter\_config\_t::acceptance\_code (C++ member), 1205
- twai\_filter\_config\_t::acceptance\_mask (C++ member), 1205
- twai\_filter\_config\_t::single\_filter (C++ member), 1205
- TWAI\_FRAME\_EXTD\_ID\_LEN\_BYTES (C macro), 1205
- TWAI\_FRAME\_MAX\_DLC (C macro), 1205
- TWAI\_FRAME\_STD\_ID\_LEN\_BYTES (C macro), 1205
- twai\_general\_config\_t (C++ struct), 1213
- twai\_general\_config\_t::alerts\_enabled (C++ member), 1214
- twai\_general\_config\_t::bus\_off\_io (C++ member), 1214
- twai\_general\_config\_t::clkout\_divider (C++ member), 1214
- twai\_general\_config\_t::clkout\_io (C++ member), 1214
- twai\_general\_config\_t::controller\_id (C++ member), 1213
- twai\_general\_config\_t::intr\_flags (C++ member), 1214
- twai\_general\_config\_t::mode (C++ member), 1213
- twai\_general\_config\_t::rx\_io (C++ member), 1214
- twai\_general\_config\_t::rx\_queue\_len (C++ member), 1214
- twai\_general\_config\_t::tx\_io (C++ member), 1213
- twai\_general\_config\_t::tx\_queue\_len (C++ member), 1214
- twai\_get\_status\_info (C++ function), 1212
- twai\_get\_status\_info\_v2 (C++ function), 1212
- twai\_handle\_t (C++ type), 1215
- twai\_initiate\_recovery (C++ function), 1211
- twai\_initiate\_recovery\_v2 (C++ function), 1212
- TWAI\_IO\_UNUSED (C macro), 1215
- twai\_message\_t (C++ struct), 1203
- twai\_message\_t::data (C++ member), 1204
- twai\_message\_t::data\_length\_code (C++ member), 1204
- twai\_message\_t::dlc\_non\_comp (C++ member), 1204
- twai\_message\_t::extd (C++ member), 1204
- twai\_message\_t::flags (C++ member), 1204
- twai\_message\_t::identifier (C++ member), 1204
- twai\_message\_t::reserved (C++ member), 1204
- twai\_message\_t::rtr (C++ member), 1204
- twai\_message\_t::self (C++ member), 1204
- twai\_message\_t::ss (C++ member), 1204
- twai\_mode\_t (C++ enum), 1206
- twai\_mode\_t::TWAI\_MODE\_LISTEN\_ONLY (C++ enumerator), 1206
- twai\_mode\_t::TWAI\_MODE\_NO\_ACK (C++ enumerator), 1206
- twai\_mode\_t::TWAI\_MODE\_NORMAL (C++ enumerator), 1206
- twai\_read\_alerts (C++ function), 1210
- twai\_read\_alerts\_v2 (C++ function), 1210
- twai\_receive (C++ function), 1210
- twai\_receive\_v2 (C++ function), 1210

- twai\_reconfigure\_alerts (C++ *function*), 1211
- twai\_reconfigure\_alerts\_v2 (C++ *function*), 1211
- twai\_start (C++ *function*), 1208
- twai\_start\_v2 (C++ *function*), 1208
- twai\_state\_t (C++ *enum*), 1215
- twai\_state\_t::TWAI\_STATE\_BUS\_OFF (C++ *enumerator*), 1215
- twai\_state\_t::TWAI\_STATE\_RECOVERING (C++ *enumerator*), 1215
- twai\_state\_t::TWAI\_STATE\_RUNNING (C++ *enumerator*), 1215
- twai\_state\_t::TWAI\_STATE\_STOPPED (C++ *enumerator*), 1215
- twai\_status\_info\_t (C++ *struct*), 1214
- twai\_status\_info\_t::arb\_lost\_count (C++ *member*), 1215
- twai\_status\_info\_t::bus\_error\_count (C++ *member*), 1215
- twai\_status\_info\_t::msgs\_to\_rx (C++ *member*), 1214
- twai\_status\_info\_t::msgs\_to\_tx (C++ *member*), 1214
- twai\_status\_info\_t::rx\_error\_counter (C++ *member*), 1214
- twai\_status\_info\_t::rx\_missed\_count (C++ *member*), 1215
- twai\_status\_info\_t::rx\_overrun\_count (C++ *member*), 1215
- twai\_status\_info\_t::state (C++ *member*), 1214
- twai\_status\_info\_t::tx\_error\_counter (C++ *member*), 1214
- twai\_status\_info\_t::tx\_failed\_count (C++ *member*), 1214
- TWAI\_STD\_ID\_MASK (C *macro*), 1205
- twai\_stop (C++ *function*), 1208
- twai\_stop\_v2 (C++ *function*), 1208
- twai\_timing\_config\_t (C++ *struct*), 1204
- twai\_timing\_config\_t::brp (C++ *member*), 1204
- twai\_timing\_config\_t::clk\_src (C++ *member*), 1204
- twai\_timing\_config\_t::quanta\_resolution\_hz (C++ *member*), 1204
- twai\_timing\_config\_t::sjw (C++ *member*), 1205
- twai\_timing\_config\_t::triple\_sampling (C++ *member*), 1205
- twai\_timing\_config\_t::tseg\_1 (C++ *member*), 1205
- twai\_timing\_config\_t::tseg\_2 (C++ *member*), 1205
- twai\_transmit (C++ *function*), 1209
- twai\_transmit\_v2 (C++ *function*), 1209
- ## U
- uart\_at\_cmd\_t (C++ *struct*), 1235
- uart\_at\_cmd\_t::char\_num (C++ *member*), 1236
- uart\_at\_cmd\_t::cmd\_char (C++ *member*), 1236
- uart\_at\_cmd\_t::gap\_tout (C++ *member*), 1236
- uart\_at\_cmd\_t::post\_idle (C++ *member*), 1236
- uart\_at\_cmd\_t::pre\_idle (C++ *member*), 1236
- UART\_BITRATE\_MAX (C *macro*), 1234
- uart\_clear\_intr\_status (C++ *function*), 1225
- uart\_config\_t (C++ *struct*), 1233
- uart\_config\_t::backup\_before\_sleep (C++ *member*), 1233
- uart\_config\_t::baud\_rate (C++ *member*), 1233
- uart\_config\_t::data\_bits (C++ *member*), 1233
- uart\_config\_t::flags (C++ *member*), 1233
- uart\_config\_t::flow\_ctrl (C++ *member*), 1233
- uart\_config\_t::parity (C++ *member*), 1233
- uart\_config\_t::rx\_flow\_ctrl\_thresh (C++ *member*), 1233
- uart\_config\_t::source\_clk (C++ *member*), 1233
- uart\_config\_t::stop\_bits (C++ *member*), 1233
- uart\_disable\_intr\_mask (C++ *function*), 1225
- uart\_disable\_pattern\_det\_intr (C++ *function*), 1229
- uart\_disable\_rx\_intr (C++ *function*), 1225
- uart\_disable\_tx\_intr (C++ *function*), 1225
- uart\_driver\_delete (C++ *function*), 1222
- uart\_driver\_install (C++ *function*), 1222
- uart\_enable\_intr\_mask (C++ *function*), 1225
- uart\_enable\_pattern\_det\_baud\_intr (C++ *function*), 1229
- uart\_enable\_rx\_intr (C++ *function*), 1225
- uart\_enable\_tx\_intr (C++ *function*), 1225
- uart\_event\_t (C++ *struct*), 1234
- uart\_event\_t::size (C++ *member*), 1234
- uart\_event\_t::timeout\_flag (C++ *member*), 1234
- uart\_event\_t::type (C++ *member*), 1234
- uart\_event\_type\_t (C++ *enum*), 1235
- uart\_event\_type\_t::UART\_BREAK (C++ *enumerator*), 1235
- uart\_event\_type\_t::UART\_BUFFER\_FULL (C++ *enumerator*), 1235
- uart\_event\_type\_t::UART\_DATA (C++ *enumerator*), 1235
- uart\_event\_type\_t::UART\_DATA\_BREAK (C++ *enumerator*), 1235

- uart\_event\_type\_t::UART\_EVENT\_MAX  
 (C++ enumerator), 1235
- uart\_event\_type\_t::UART\_FIFO\_OVF (C++  
 enumerator), 1235
- uart\_event\_type\_t::UART\_FRAME\_ERR  
 (C++ enumerator), 1235
- uart\_event\_type\_t::UART\_PARITY\_ERR  
 (C++ enumerator), 1235
- uart\_event\_type\_t::UART\_PATTERN\_DET  
 (C++ enumerator), 1235
- uart\_event\_type\_t::UART\_WAKEUP (C++  
 enumerator), 1235
- UART\_FIFO\_LEN (C macro), 1234
- uart\_flush (C++ function), 1228
- uart\_flush\_input (C++ function), 1228
- uart\_get\_baudrate (C++ function), 1224
- uart\_get\_buffered\_data\_len (C++ function),  
 1229
- uart\_get\_collision\_flag (C++ function),  
 1231
- uart\_get\_hw\_flow\_ctrl (C++ function), 1224
- uart\_get\_parity (C++ function), 1223
- uart\_get\_sclk\_freq (C++ function), 1223
- uart\_get\_stop\_bits (C++ function), 1223
- uart\_get\_tx\_buffer\_free\_size (C++ func-  
 tion), 1229
- uart\_get\_wakeup\_threshold (C++ function),  
 1232
- uart\_get\_word\_length (C++ function), 1222
- UART\_GPIO23\_DIRECT\_CHANNEL (C macro), 1240
- UART\_GPIO24\_DIRECT\_CHANNEL (C macro), 1239
- UART\_HW\_FIFO\_LEN (C macro), 1234
- uart\_hw\_flowcontrol\_t (C++ enum), 1238
- uart\_hw\_flowcontrol\_t::UART\_HW\_FLOWCTRL\_CTS  
 (C++ enumerator), 1238
- uart\_hw\_flowcontrol\_t::UART\_HW\_FLOWCTRL\_CTS\_RTS  
 (C++ enumerator), 1238
- uart\_hw\_flowcontrol\_t::UART\_HW\_FLOWCTRL\_DISABLE  
 (C++ enumerator), 1238
- uart\_hw\_flowcontrol\_t::UART\_HW\_FLOWCTRL\_MAX  
 (C++ enumerator), 1238
- uart\_hw\_flowcontrol\_t::UART\_HW\_FLOWCTRL\_RTS  
 (C++ enumerator), 1238
- uart\_intr\_config (C++ function), 1227
- uart\_intr\_config\_t (C++ struct), 1234
- uart\_intr\_config\_t::intr\_enable\_mask  
 (C++ member), 1234
- uart\_intr\_config\_t::rx\_timeout\_thresh  
 (C++ member), 1234
- uart\_intr\_config\_t::rxfifo\_full\_thresh  
 (C++ member), 1234
- uart\_intr\_config\_t::txfifo\_empty\_intr\_thresh  
 (C++ member), 1234
- uart\_is\_driver\_installed (C++ function),  
 1222
- uart\_isr\_handle\_t (C++ type), 1235
- uart\_mode\_t (C++ enum), 1237
- uart\_mode\_t::UART\_MODE\_IRDA (C++ enumer-  
 ator), 1237
- uart\_mode\_t::UART\_MODE\_RS485\_APP\_CTRL  
 (C++ enumerator), 1237
- uart\_mode\_t::UART\_MODE\_RS485\_COLLISION\_DETECT  
 (C++ enumerator), 1237
- uart\_mode\_t::UART\_MODE\_RS485\_HALF\_DUPLEX  
 (C++ enumerator), 1237
- uart\_mode\_t::UART\_MODE\_UART (C++ enumer-  
 ator), 1237
- UART\_NUM\_0\_RXD\_DIRECT\_GPIO\_NUM (C  
 macro), 1240
- UART\_NUM\_0\_TXD\_DIRECT\_GPIO\_NUM (C  
 macro), 1239
- uart\_param\_config (C++ function), 1227
- uart\_parity\_t (C++ enum), 1238
- uart\_parity\_t::UART\_PARITY\_DISABLE  
 (C++ enumerator), 1238
- uart\_parity\_t::UART\_PARITY\_EVEN (C++  
 enumerator), 1238
- uart\_parity\_t::UART\_PARITY\_ODD (C++  
 enumerator), 1238
- uart\_pattern\_get\_pos (C++ function), 1230
- uart\_pattern\_pop\_pos (C++ function), 1229
- uart\_pattern\_queue\_reset (C++ function),  
 1230
- UART\_PIN\_NO\_CHANGE (C macro), 1234
- uart\_port\_t (C++ enum), 1236
- uart\_port\_t::UART\_NUM\_0 (C++ enumerator),  
 1236
- uart\_port\_t::UART\_NUM\_1 (C++ enumerator),  
 1236
- uart\_port\_t::UART\_NUM\_MAX (C++ enumer-  
 ator), 1237
- uart\_read\_bytes (C++ function), 1228
- UART\_RXD\_GPIO23\_DIRECT\_CHANNEL (C  
 macro), 1240
- uart\_sclk\_t (C++ type), 1236
- uart\_set\_always\_rx\_timeout (C++ function),  
 1233
- uart\_set\_baudrate (C++ function), 1223
- uart\_set\_dtr (C++ function), 1226
- uart\_set\_hw\_flow\_ctrl (C++ function), 1224
- uart\_set\_line\_inverse (C++ function), 1224
- uart\_set\_loop\_back (C++ function), 1232
- uart\_set\_mode (C++ function), 1230
- uart\_set\_parity (C++ function), 1223
- uart\_set\_pin (C++ function), 1226
- uart\_set\_rts (C++ function), 1226
- uart\_set\_rx\_full\_threshold (C++ function),  
 1231
- uart\_set\_rx\_timeout (C++ function), 1231
- uart\_set\_stop\_bits (C++ function), 1223
- uart\_set\_sw\_flow\_ctrl (C++ function), 1224
- uart\_set\_tx\_empty\_threshold (C++ func-  
 tion), 1231
- uart\_set\_tx\_idle\_num (C++ function), 1226
- uart\_set\_wakeup\_threshold (C++ function),  
 1231

- uart\_set\_word\_length (C++ function), 1222  
 uart\_signal\_inv\_t (C++ enum), 1238  
 uart\_signal\_inv\_t::UART\_SIGNAL\_CTS\_INV (C++ enumerator), 1239  
 uart\_signal\_inv\_t::UART\_SIGNAL\_DSR\_INV (C++ enumerator), 1239  
 uart\_signal\_inv\_t::UART\_SIGNAL\_DTR\_INV (C++ enumerator), 1239  
 uart\_signal\_inv\_t::UART\_SIGNAL\_INV\_DISABLE (C++ enumerator), 1238  
 uart\_signal\_inv\_t::UART\_SIGNAL\_IRDA\_RX (C++ enumerator), 1239  
 uart\_signal\_inv\_t::UART\_SIGNAL\_IRDA\_TX (C++ enumerator), 1238  
 uart\_signal\_inv\_t::UART\_SIGNAL\_RTS\_INV (C++ enumerator), 1239  
 uart\_signal\_inv\_t::UART\_SIGNAL\_RXD\_INV (C++ enumerator), 1239  
 uart\_signal\_inv\_t::UART\_SIGNAL\_TXD\_INV (C++ enumerator), 1239  
 uart\_stop\_bits\_t (C++ enum), 1237  
 uart\_stop\_bits\_t::UART\_STOP\_BITS\_1 (C++ enumerator), 1237  
 uart\_stop\_bits\_t::UART\_STOP\_BITS\_1\_5 (C++ enumerator), 1238  
 uart\_stop\_bits\_t::UART\_STOP\_BITS\_2 (C++ enumerator), 1238  
 uart\_stop\_bits\_t::UART\_STOP\_BITS\_MAX (C++ enumerator), 1238  
 uart\_sw\_flowctrl\_t (C++ struct), 1236  
 uart\_sw\_flowctrl\_t::xoff\_char (C++ member), 1236  
 uart\_sw\_flowctrl\_t::xoff\_thrd (C++ member), 1236  
 uart\_sw\_flowctrl\_t::xon\_char (C++ member), 1236  
 uart\_sw\_flowctrl\_t::xon\_thrd (C++ member), 1236  
 uart\_tx\_chars (C++ function), 1227  
 UART\_TXD\_GPIO24\_DIRECT\_CHANNEL (C macro), 1240  
 uart\_vfs\_dev\_port\_set\_rx\_line\_endings (C++ function), 1693  
 uart\_vfs\_dev\_port\_set\_tx\_line\_endings (C++ function), 1693  
 uart\_vfs\_dev\_register (C++ function), 1693  
 uart\_vfs\_dev\_use\_driver (C++ function), 1694  
 uart\_vfs\_dev\_use\_nonblocking (C++ function), 1694  
 uart\_wait\_tx\_done (C++ function), 1227  
 uart\_wait\_tx\_idle\_polling (C++ function), 1232  
 uart\_word\_length\_t (C++ enum), 1237  
 uart\_word\_length\_t::UART\_DATA\_5\_BITS (C++ enumerator), 1237  
 uart\_word\_length\_t::UART\_DATA\_6\_BITS (C++ enumerator), 1237  
 uart\_word\_length\_t::UART\_DATA\_7\_BITS (C++ enumerator), 1237  
 uart\_word\_length\_t::UART\_DATA\_8\_BITS (C++ enumerator), 1237  
 uart\_word\_length\_t::UART\_DATA\_BITS\_MAX (C++ enumerator), 1237  
 uart\_write\_bytes (C++ function), 1227  
 uart\_write\_bytes\_with\_break (C++ function), 1228  
 UINT16 (C++ type), 381  
 UINT32 (C++ type), 381  
 UINT64 (C++ type), 381  
 UINVT8 (C++ type), 381  
 ulTaskGenericNotifyValueClear (C++ function), 1810  
 ulTaskGetIdleRunTimeCounter (C++ function), 1807  
 ulTaskGetIdleRunTimePercent (C++ function), 1807  
 ulTaskNotifyTakeIndexed (C macro), 1817  
 ulTaskNotifyValueClear (C macro), 1818  
 ulTaskNotifyValueClearIndexed (C macro), 1818  
 USE\_ECDSA\_KEY\_FROM\_KEY\_MANAGER (C macro), 831  
 uxQueueMessagesWaiting (C++ function), 1824  
 uxQueueMessagesWaitingFromISR (C++ function), 1826  
 uxQueueSpacesAvailable (C++ function), 1824  
 uxSemaphoreGetCount (C macro), 1853  
 uxSemaphoreGetCountFromISR (C macro), 1853  
 uxTaskGetNumberOfTasks (C++ function), 1802  
 uxTaskGetStackHighWaterMark (C++ function), 1803  
 uxTaskGetStackHighWaterMark2 (C++ function), 1803  
 uxTaskGetSystemState (C++ function), 1804  
 uxTaskPriorityGet (C++ function), 1797  
 uxTaskPriorityGetFromISR (C++ function), 1797  
 uxTimerGetReloadMode (C++ function), 1861
- ## V
- vApplicationGetIdleTaskMemory (C++ function), 1803  
 vApplicationGetTimerTaskMemory (C++ function), 1862  
 VENDOR\_HCI\_CMD\_MASK (C macro), 226  
 vEventGroupDelete (C++ function), 1878  
 vEventGroupDeleteWithCaps (C++ function), 1925  
 VFS\_FAT\_MOUNT\_DEFAULT\_CONFIG (C macro), 1618  
 vMessageBufferDelete (C macro), 1896  
 vMessageBufferDeleteWithCaps (C++ function), 1924  
 vprintf\_like\_t (C++ type), 1979  
 vQueueAddToRegistry (C++ function), 1827



- [vQueueDelete \(C++ function\), 1824](#)  
[vQueueDeleteWithCaps \(C++ function\), 1922](#)  
[vQueueUnregisterQueue \(C++ function\), 1827](#)  
[vRingbufferDelete \(C++ function\), 1914](#)  
[vRingbufferDeleteWithCaps \(C++ function\), 1916](#)  
[vRingbufferGetInfo \(C++ function\), 1915](#)  
[vRingbufferReturnItem \(C++ function\), 1913](#)  
[vRingbufferReturnItemFromISR \(C++ function\), 1914](#)  
[vSemaphoreCreateBinary \(C macro\), 1840](#)  
[vSemaphoreDelete \(C macro\), 1853](#)  
[vSemaphoreDeleteWithCaps \(C++ function\), 1923](#)  
[vStreamBufferDelete \(C++ function\), 1885](#)  
[vStreamBufferDeleteWithCaps \(C++ function\), 1924](#)  
[vTaskAllocateMPURegions \(C++ function\), 1794](#)  
[vTaskDelay \(C++ function\), 1795](#)  
[vTaskDelete \(C++ function\), 1794](#)  
[vTaskDeleteWithCaps \(C++ function\), 1922](#)  
[vTaskGenericNotifyGiveFromISR \(C++ function\), 1808](#)  
[vTaskGetInfo \(C++ function\), 1798](#)  
[vTaskGetRunTimeStats \(C++ function\), 1806](#)  
[vTaskList \(C++ function\), 1806](#)  
[vTaskNotifyGiveFromISR \(C macro\), 1817](#)  
[vTaskNotifyGiveIndexedFromISR \(C macro\), 1817](#)  
[vTaskPrioritySet \(C++ function\), 1798](#)  
[vTaskResume \(C++ function\), 1800](#)  
[vTaskSetApplicationTaskTag \(C++ function\), 1803](#)  
[vTaskSetThreadLocalStoragePointer \(C++ function\), 1803](#)  
[vTaskSetThreadLocalStoragePointerAndDeleteCallback \(C++ function\), 1921](#)  
[vTaskSetTimeOutState \(C++ function\), 1810](#)  
[vTaskSuspend \(C++ function\), 1799](#)  
[vTaskSuspendAll \(C++ function\), 1801](#)  
[vTimerSetReloadMode \(C++ function\), 1861](#)  
[vTimerSetTimerID \(C++ function\), 1858](#)
- W**
- [walker\\_block\\_info \(C++ struct\), 1933](#)  
[walker\\_block\\_info::ptr \(C++ member\), 1933](#)  
[walker\\_block\\_info::size \(C++ member\), 1933](#)  
[walker\\_block\\_info::used \(C++ member\), 1933](#)  
[walker\\_block\\_info\\_t \(C++ type\), 1935](#)  
[walker\\_heap\\_info \(C++ struct\), 1933](#)  
[walker\\_heap\\_info::end \(C++ member\), 1933](#)  
[walker\\_heap\\_info::start \(C++ member\), 1933](#)  
[walker\\_heap\\_info\\_t \(C++ type\), 1935](#)  
[wl\\_erase\\_range \(C++ function\), 1697](#)  
[wl\\_handle\\_t \(C++ type\), 1698](#)  
[WL\\_INVALID\\_HANDLE \(C macro\), 1698](#)  
[wl\\_mount \(C++ function\), 1697](#)  
[wl\\_read \(C++ function\), 1697](#)  
[wl\\_sector\\_size \(C++ function\), 1698](#)  
[wl\\_size \(C++ function\), 1698](#)  
[wl\\_unmount \(C++ function\), 1697](#)  
[wl\\_write \(C++ function\), 1697](#)
- X**
- [xEventGroupClearBits \(C++ function\), 1874](#)  
[xEventGroupClearBitsFromISR \(C macro\), 1878](#)  
[xEventGroupCreate \(C++ function\), 1872](#)  
[xEventGroupCreateStatic \(C++ function\), 1872](#)  
[xEventGroupCreateWithCaps \(C++ function\), 1924](#)  
[xEventGroupGetBits \(C macro\), 1880](#)  
[xEventGroupGetBitsFromISR \(C++ function\), 1878](#)  
[xEventGroupGetStaticBuffer \(C++ function\), 1878](#)  
[xEventGroupSetBits \(C++ function\), 1875](#)  
[xEventGroupSetBitsFromISR \(C macro\), 1879](#)  
[xEventGroupSync \(C++ function\), 1876](#)  
[xEventGroupWaitBits \(C++ function\), 1873](#)  
[xMessageBufferCreateStaticWithCallback \(C macro\), 1890](#)  
[xMessageBufferCreateWithCallback \(C macro\), 1890](#)  
[xMessageBufferCreateWithCaps \(C++ function\), 1924](#)  
[xMessageBufferGetStaticBuffers \(C macro\), 1891](#)  
[xMessageBufferIsEmpty \(C macro\), 1897](#)  
[xMessageBufferIsFull \(C macro\), 1897](#)  
[xMessageBufferNextLengthBytes \(C macro\), 1897](#)  
[xMessageBufferReceive \(C macro\), 1894](#)  
[xMessageBufferReceiveCompletedFromISR \(C macro\), 1898](#)  
[xMessageBufferReceiveFromISR \(C macro\), 1895](#)  
[xMessageBufferReset \(C macro\), 1897](#)  
[xMessageBufferSend \(C macro\), 1892](#)  
[xMessageBufferSendCompletedFromISR \(C macro\), 1897](#)  
[xMessageBufferSendFromISR \(C macro\), 1893](#)  
[xMessageBufferSpaceAvailable \(C macro\), 1897](#)  
[xMessageBufferSpacesAvailable \(C macro\), 1897](#)  
[xQueueAddToSet \(C++ function\), 1828](#)  
[xQueueCreate \(C macro\), 1829](#)  
[xQueueCreateSet \(C++ function\), 1827](#)  
[xQueueCreateStatic \(C macro\), 1830](#)  
[xQueueCreateWithCaps \(C++ function\), 1922](#)

- [xQueueGenericSend \(C++ function\), 1820](#)  
[xQueueGenericSendFromISR \(C++ function\), 1824](#)  
[xQueueGetStaticBuffers \(C macro\), 1831](#)  
[xQueueGiveFromISR \(C++ function\), 1825](#)  
[xQueueIsQueueEmptyFromISR \(C++ function\), 1826](#)  
[xQueueIsQueueFullFromISR \(C++ function\), 1826](#)  
[xQueueOverwrite \(C macro\), 1834](#)  
[xQueueOverwriteFromISR \(C macro\), 1837](#)  
[xQueuePeek \(C++ function\), 1821](#)  
[xQueuePeekFromISR \(C++ function\), 1822](#)  
[xQueueReceive \(C++ function\), 1823](#)  
[xQueueReceiveFromISR \(C++ function\), 1825](#)  
[xQueueRemoveFromSet \(C++ function\), 1828](#)  
[xQueueReset \(C macro\), 1839](#)  
[xQueueSelectFromSet \(C++ function\), 1828](#)  
[xQueueSelectFromSetFromISR \(C++ function\), 1829](#)  
[xQueueSend \(C macro\), 1833](#)  
[xQueueSendFromISR \(C macro\), 1838](#)  
[xQueueSendToBack \(C macro\), 1832](#)  
[xQueueSendToBackFromISR \(C macro\), 1836](#)  
[xQueueSendToFront \(C macro\), 1831](#)  
[xQueueSendToFrontFromISR \(C macro\), 1835](#)  
[xRingbufferAddToQueueSetRead \(C++ function\), 1915](#)  
[xRingbufferCanRead \(C++ function\), 1915](#)  
[xRingbufferCreate \(C++ function\), 1908](#)  
[xRingbufferCreateNoSplit \(C++ function\), 1908](#)  
[xRingbufferCreateStatic \(C++ function\), 1908](#)  
[xRingbufferCreateWithCaps \(C++ function\), 1916](#)  
[xRingbufferGetCurFreeSize \(C++ function\), 1914](#)  
[xRingbufferGetMaxItemSize \(C++ function\), 1914](#)  
[xRingbufferGetStaticBuffer \(C++ function\), 1916](#)  
[xRingbufferPrintInfo \(C++ function\), 1916](#)  
[xRingbufferReceive \(C++ function\), 1910](#)  
[xRingbufferReceiveFromISR \(C++ function\), 1911](#)  
[xRingbufferReceiveSplit \(C++ function\), 1911](#)  
[xRingbufferReceiveSplitFromISR \(C++ function\), 1912](#)  
[xRingbufferReceiveUpTo \(C++ function\), 1912](#)  
[xRingbufferReceiveUpToFromISR \(C++ function\), 1913](#)  
[xRingbufferRemoveFromQueueSetRead \(C++ function\), 1915](#)  
[xRingbufferSend \(C++ function\), 1909](#)  
[xRingbufferSendAcquire \(C++ function\), 1910](#)  
[xRingbufferSendComplete \(C++ function\), 1910](#)  
[xRingbufferSendFromISR \(C++ function\), 1909](#)  
[xSemaphoreCreateBinary \(C macro\), 1840](#)  
[xSemaphoreCreateBinaryStatic \(C macro\), 1841](#)  
[xSemaphoreCreateBinaryWithCaps \(C++ function\), 1922](#)  
[xSemaphoreCreateCounting \(C macro\), 1851](#)  
[xSemaphoreCreateCountingStatic \(C macro\), 1852](#)  
[xSemaphoreCreateCountingWithCaps \(C++ function\), 1923](#)  
[xSemaphoreCreateMutex \(C macro\), 1848](#)  
[xSemaphoreCreateMutexStatic \(C macro\), 1849](#)  
[xSemaphoreCreateMutexWithCaps \(C++ function\), 1923](#)  
[xSemaphoreCreateRecursiveMutex \(C macro\), 1849](#)  
[xSemaphoreCreateRecursiveMutexStatic \(C macro\), 1850](#)  
[xSemaphoreCreateRecursiveMutexWithCaps \(C++ function\), 1923](#)  
[xSemaphoreGetMutexHolder \(C macro\), 1853](#)  
[xSemaphoreGetMutexHolderFromISR \(C macro\), 1853](#)  
[xSemaphoreGetStaticBuffer \(C macro\), 1854](#)  
[xSemaphoreGive \(C macro\), 1844](#)  
[xSemaphoreGiveFromISR \(C macro\), 1846](#)  
[xSemaphoreGiveRecursive \(C macro\), 1845](#)  
[xSemaphoreTake \(C macro\), 1842](#)  
[xSemaphoreTakeFromISR \(C macro\), 1847](#)  
[xSemaphoreTakeRecursive \(C macro\), 1843](#)  
[xSTATIC\\_RINGBUFFER \(C++ struct\), 1916](#)  
[xStreamBufferBytesAvailable \(C++ function\), 1886](#)  
[xStreamBufferCreateStaticWithCallback \(C macro\), 1888](#)  
[xStreamBufferCreateWithCallback \(C macro\), 1887](#)  
[xStreamBufferCreateWithCaps \(C++ function\), 1924](#)  
[xStreamBufferGetStaticBuffers \(C++ function\), 1880](#)  
[xStreamBufferIsEmpty \(C++ function\), 1885](#)  
[xStreamBufferIsFull \(C++ function\), 1885](#)  
[xStreamBufferReceive \(C++ function\), 1883](#)  
[xStreamBufferReceiveCompletedFromISR \(C++ function\), 1887](#)  
[xStreamBufferReceiveFromISR \(C++ function\), 1884](#)  
[xStreamBufferReset \(C++ function\), 1885](#)  
[xStreamBufferSend \(C++ function\), 1881](#)  
[xStreamBufferSendCompletedFromISR \(C++ function\), 1886](#)  
[xStreamBufferSendFromISR \(C++ function\), 1882](#)  
[xStreamBufferSetTriggerLevel \(C++ function\), 1910](#)

- [tion](#), 1886
- [xStreamBufferSpacesAvailable \(C++ function\)](#), 1886
- [xTASK\\_STATUS \(C++ struct\)](#), 1812
- [xTASK\\_STATUS::eCurrentState \(C++ member\)](#), 1812
- [xTASK\\_STATUS::pcTaskName \(C++ member\)](#), 1812
- [xTASK\\_STATUS::pxStackBase \(C++ member\)](#), 1812
- [xTASK\\_STATUS::ulRunTimeCounter \(C++ member\)](#), 1812
- [xTASK\\_STATUS::usStackHighWaterMark \(C++ member\)](#), 1813
- [xTASK\\_STATUS::uxBasePriority \(C++ member\)](#), 1812
- [xTASK\\_STATUS::uxCurrentPriority \(C++ member\)](#), 1812
- [xTASK\\_STATUS::xCoreID \(C++ member\)](#), 1813
- [xTASK\\_STATUS::xHandle \(C++ member\)](#), 1812
- [xTASK\\_STATUS::xTaskNumber \(C++ member\)](#), 1812
- [xTaskAbortDelay \(C++ function\)](#), 1796
- [xTaskCallApplicationTaskHook \(C++ function\)](#), 1804
- [xTaskCatchUpTicks \(C++ function\)](#), 1812
- [xTaskCheckForTimeOut \(C++ function\)](#), 1810
- [xTaskCreate \(C++ function\)](#), 1791
- [xTaskCreatePinnedToCore \(C++ function\)](#), 1919
- [xTaskCreatePinnedToCoreWithCaps \(C++ function\)](#), 1921
- [xTaskCreateStatic \(C++ function\)](#), 1792
- [xTaskCreateStaticPinnedToCore \(C++ function\)](#), 1919
- [xTaskCreateWithCaps \(C++ function\)](#), 1921
- [xTaskDelayUntil \(C++ function\)](#), 1796
- [xTaskGenericNotifyStateClear \(C++ function\)](#), 1809
- [xTaskGenericNotifyWait \(C++ function\)](#), 1807
- [xTaskGetApplicationTaskTag \(C++ function\)](#), 1803
- [xTaskGetApplicationTaskTagFromISR \(C++ function\)](#), 1803
- [xTaskGetCoreID \(C++ function\)](#), 1920
- [xTaskGetCurrentTaskHandleForCore \(C++ function\)](#), 1920
- [xTaskGetHandle \(C++ function\)](#), 1802
- [xTaskGetIdleTaskHandle \(C++ function\)](#), 1804
- [xTaskGetStaticBuffers \(C++ function\)](#), 1802
- [xTaskGetTickCount \(C++ function\)](#), 1802
- [xTaskGetTickCountFromISR \(C++ function\)](#), 1802
- [xTaskNotifyAndQueryIndexed \(C macro\)](#), 1815
- [xTaskNotifyAndQueryIndexedFromISR \(C macro\)](#), 1816
- [xTaskNotifyGiveIndexed \(C macro\)](#), 1816
- [xTaskNotifyIndexed \(C macro\)](#), 1814
- [xTaskNotifyIndexedFromISR \(C macro\)](#), 1815
- [xTaskNotifyStateClear \(C macro\)](#), 1818
- [xTaskNotifyStateClearIndexed \(C macro\)](#), 1818
- [xTaskNotifyWait \(C macro\)](#), 1816
- [xTaskNotifyWaitIndexed \(C macro\)](#), 1816
- [xTaskResumeAll \(C++ function\)](#), 1801
- [xTaskResumeFromISR \(C++ function\)](#), 1800
- [xTimerChangePeriod \(C macro\)](#), 1863
- [xTimerChangePeriodFromISR \(C macro\)](#), 1869
- [xTimerCreate \(C++ function\)](#), 1854
- [xTimerCreateStatic \(C++ function\)](#), 1856
- [xTimerDelete \(C macro\)](#), 1864
- [xTimerGetExpiryTime \(C++ function\)](#), 1861
- [xTimerGetPeriod \(C++ function\)](#), 1861
- [xTimerGetReloadMode \(C++ function\)](#), 1861
- [xTimerGetStaticBuffer \(C++ function\)](#), 1862
- [xTimerGetTimerDaemonTaskHandle \(C++ function\)](#), 1859
- [xTimerIsTimerActive \(C++ function\)](#), 1859
- [xTimerPendFunctionCall \(C++ function\)](#), 1860
- [xTimerPendFunctionCallFromISR \(C++ function\)](#), 1859
- [xTimerReset \(C macro\)](#), 1865
- [xTimerResetFromISR \(C macro\)](#), 1870
- [xTimerStart \(C macro\)](#), 1862
- [xTimerStartFromISR \(C macro\)](#), 1867
- [xTimerStop \(C macro\)](#), 1863
- [xTimerStopFromISR \(C macro\)](#), 1868